

A Framework for Output-Feedback Symbolic Control

Mahmoud Khaled, Kuize Zhang, and Majid Zamani

Abstract

Symbolic control is an abstraction-based controller synthesis approach that provides, algorithmically, certifiable-by-construction controllers for cyber-physical systems. Symbolic control approaches usually assume that full-state information is available which is not suitable for many real-world applications with partially-observable states or output information. This article introduces a framework for output-feedback symbolic control. We propose relations between original systems and their symbolic models based on outputs. They enable designing symbolic controllers and refining them to enforce complex requirements on original systems. We provide example methodologies to synthesize and refine output-feedback symbolic controllers.

I. INTRODUCTION

In the past decades, the world has witnessed many emerging applications formed by the tight interaction of physical systems, computation platforms, communication networks, and software. This is clearly the case in avionics, automotive systems, smart power grids, and infrastructure management systems, which are all examples of so-called cyber-physical systems (CPS). In CPS, (embedded) control software orchestrates the interaction between different physical and computational parts to achieve some given desired requirements. Today's CPS often require certifiable control software, faster requirements-to-prototype development cycles and the handling of more sophisticated specifications. Many CPS are also safety-critical in which the correctness of control software is crucial. Consequently, modern CPS require approaches for automated synthesis of provably-correct control software.

M. Khaled is with the Department of Computer and Systems Engineering, Faculty of Engineering, Minia University, Egypt. K. Zhang is with the Department of Computer Science, University of Surrey, UK. M. Zamani is with the Department of Computer Science, University of Colorado Boulder, USA, and the Department of Computer Science at LMU, Munich, Germany. Emails: mkhaled@mu.edu.eg, kuize.zhang@surrey.ac.uk, majid.zamani@colorado.edu. This work was supported in part by the H2020 ERC Starting Grant AutoCPS (Grant Agreement No. 804639) and the NSF under Grant CNS-2145184.

Symbolic control [1]–[4] is an approach to automatically synthesize certifiable controllers that handle complex requirements including objectives and constraints given by formulae in linear temporal logic (LTL) or automata on infinite strings [1, 5]. In symbolic control, a dynamical system (e.g., a physical process described by a set of differential equations) is related to a *symbolic model* (i.e., a system with finite state and input sets) via a formal relation. The relation ensures that the symbolic model captures some required features from the original system. Since symbolic models are finite, reactive synthesis techniques [6]–[8] can be applied to algorithmically synthesize controllers enforcing the given specifications. The designed controllers are usually referred to as *symbolic controllers*.

Symbolic models can be used to abstract several classes of control systems [1, 3, 4, 9, 10]. They have been recently investigated for general nonlinear systems [2, 11], time-delay control systems [12], switched control systems [13, 14], stochastic control systems [15, 16], and networked control systems []. Unfortunately, the majority of current techniques assume control systems with full-state or quantized-state information and, hence, they are not applicable to control systems with outputs or partially-observable states. Moreover, none of state-of-the-art tools of symbolic controller synthesis [17]–[19] support output-feedback systems since the required theories for them are not yet fully established.

In this article, we consider control systems with partial-state or output information. We refer to these particular types of systems as *output-based control systems*. We introduce a framework for symbolic control that can handle this class of systems. We refer to the introduced framework as *output-feedback symbolic control*. We first extend the work in [4] to provide mathematical tools for constructing symbolic models of output-based systems. More precisely, output-feedback refinement relations (OFRRs) are introduced as means of relating output-based systems and their symbolic models. They are extensions of feedback refinement relations (FRRs) in [4]. OFRRs allow abstractions to be constructed by quantizing the state and output sets of concrete systems, such that the output quantization respects the state quantization. We prove that OFRRs ensure external (i.e., output-based) behavioral inclusion from original systems to symbolic models. Symbolic controllers synthesized based on the outputs of symbolic models can be refined via simple and practically implementable interfaces.

In Sections VI, VII and VIII, we present example methodologies that realize the introduced framework. The first methodology is based on games of imperfect information. The second one proposes designing observers for output-based systems. The third one proposes detectors

designed for symbolic models. Three case studies are presented in Section IX to demonstrate the effectiveness of proposed methodologies.

II. NOTATION

The identity map on a set X is denoted by id_X . Symbols $\mathbb{N}, \mathbb{Z}, \mathbb{R}, \mathbb{R}^+$, and \mathbb{R}_0^+ denote, respectively, the sets of natural, integer, real, positive real, and nonnegative real numbers.

The relative complement of a set A in a set B is denoted by $B \setminus A$. For a set A , we denote by $|A|$ the cardinality of the set, and by 2^A the set of all subsets of A including the empty set \emptyset . A *cover* of a set A is a set of subsets of A whose union equals A . A *partition* of a set A is a set of pairwise disjoint nonempty subsets of A whose union equals A . We denote by A^* the set of all finite strings (a.k.a. sequences) obtained by concatenating elements in A , by A^ω the set of all infinite strings obtained by concatenating elements in A , and by A^∞ the set of all finite and infinite strings obtained by concatenating elements in A . For any finite string s , $|s|$ denotes the length of the string, s_i , $i \in \{0, 1, \dots, |s| - 1\}$, denotes the i -th element of s , and $s[i, j]$, $j \geq i$, denotes the substring $s_i s_{i+1} \dots s_j$. Symbol ϵ denotes the empty string and $|\epsilon| = 0$. We use the dot symbol \cdot to concatenate two strings.

Consider a relation $\mathcal{R} \subseteq A \times B$. \mathcal{R} is strict when $\mathcal{R}(a) \neq \emptyset$ for every $a \in A$. \mathcal{R} naturally introduces a map $\mathcal{R} : A \rightarrow 2^B$ such that $\mathcal{R}(a) = \{b \in B \mid (a, b) \in \mathcal{R}\}$. \mathcal{R} also admits an inverse relation $\mathcal{R}^{-1} := \{(b, a) \in B \times A \mid (a, b) \in \mathcal{R}\}$. Given an element $r = (a, b) \in \mathcal{R}$, $\pi_A(r)$ denotes the natural projection of r on the set A , i.e., $\pi_A(r) = a$. We sometimes abuse the notation and apply the projection map π_A to a string (resp., a set of strings) of elements of \mathcal{R} , which means applying it iteratively to all elements in the string (resp., all strings in the set). When \mathcal{R} is an equivalence relation on a set X , we denote by $[x]$ the equivalence class of $x \in X$ and by X/\mathcal{R} the set of all equivalence classes (a.k.a. quotient set). We also denote by $\pi_{\mathcal{R}} : X \rightarrow X/\mathcal{R}$ the natural projection map taking a point $x \in X$ to its equivalence class, i.e., $\pi_{\mathcal{R}}(x) = [x] \in X/\mathcal{R}$. We say that an equivalence relation is finite when it has finitely many equivalence classes.

Given a vector $v \in \mathbb{R}^n$, we denote by v_i , $i \in \{0, 1, \dots, n - 1\}$, the i -th element of v and by $\|v\|$ its infinity norm.

III. PRELIMINARIES

First, we present the notion of *systems* as a general mathematical framework to describe control systems, symbolic models, observers, controllers, and their interconnections.

A. Systems

We use a similar definition for systems as in [1].

Definition III.1 (System). *A system is a tuple*

$$S := (X, X_0, U, \longrightarrow, Y, H),$$

where X is the set of states, $X_0 \subseteq X$ is a set of initial states, U is the set of inputs, $\longrightarrow \subseteq X \times U \times X$ is the transition relation, Y is the set of outputs, and $H : X \rightarrow Y$ is the output map.

All sets in tuple S are assumed to be non-empty. For any $x \in X$ and $u \in U$, we denote by $\text{Post}_u^S(x) := \{x' \in X \mid (x, u, x') \in \longrightarrow\}$ the set of u -successors of x in S . When S is known from the context, the set of u -successors of x is simply denoted by $\text{Post}_u(x)$. The inputs admissible to a state x of system S is denoted by $U_S(x) := \{u \in U \mid \text{Post}_u(x) \neq \emptyset\}$.

For any output element $y \in Y$, the map $H^{-1} : Y \rightarrow 2^X$ recovers the underlying set of states $X_y \subseteq X$ generating y , and it is defined as follows: $H^{-1}(y) := \{x \in X \mid H(x) = y\}$.

We sometimes abuse the notation and apply maps H and H^{-1} to subsets of X and Y , respectively, which refers to applying them element-wise and then taking the union. Specifically, we have that

$$\text{for } \bar{x} \subseteq X, H(\bar{x}) := \bigcup_{x \in \bar{x}} \{H(x)\}, \text{ and}$$

$$\text{for } \bar{y} \subseteq Y, H^{-1}(\bar{y}) := \bigcup_{y \in \bar{y}} H^{-1}(y).$$

System S is said to be static if X is singleton; autonomous if U is singleton; state-based (a.k.a. simple system [4]) when $X = Y$, $H = id_X$, and all states are admissible as initial ones, i.e., $X = X_0$; output-based when $X \neq Y$; total when for any $x \in X$ and any $u \in U$ there exists at least one $x' \in X$ such that $x' \in \text{Post}_u(x)$; deterministic when for any $x \in X$ and any $u \in U$ we have $|\text{Post}_u(x)| \leq 1$; and symbolic when X and U are both finite sets.

For any $\bar{x} \subseteq X_0$, we denote by $S^{(\bar{x})}$ the restricted version of S with $X_0 = \bar{x}$. For any output-based system S , one can always construct its state-based version by assuming the availability of state information, i.e., $Y = X$, $X_0 = X$ and $H = id_X$, and we denote it by S_X .

Let S be an output-based system. Map $\bar{U}_S : Y \rightarrow 2^U$ provides all inputs admissible to outputs of S . It is defined as follows for any $y \in Y$:

$$\bar{U}_S(y) := \bigcap_{x \in H^{-1}(y)} U_S(x).$$

Additionally, for any $y \in Y$ and $u \in \bar{U}_S(y)$, $\overline{\text{Post}}_u^S(y)$ denotes all u -successor observations of y and we define it as follows:

$$\overline{\text{Post}}_u^S(y) := H\left(\bigcup_{x \in H^{-1}(y)} \text{Post}_u^S(x)\right).$$

Given a system S , for all $x \in X$ and $\alpha \in U^*$ such that $|\alpha| \geq 1$, $x' \in X$ is called an α -successor of x , if there exist states $x_0, \dots, x_{|\alpha|} \in X$ such that $x_0 = x$, $x_{|\alpha|} = x'$, and $(x_i, \alpha_i, x_{i+1}) \in \longrightarrow$ for all integers $0 \leq i \leq |\alpha| - 1$. The set of α -successors of a state $x \in X$ (resp., a subset $X' \subset X$) is denoted by $\text{Post}_\alpha(x)$ (resp., $\text{Post}_\alpha(X') := \bigcup_{x \in X'} \text{Post}_\alpha(x)$). For all $x \in X$, $\alpha \in U^*$ and $\beta \in Y^*$ such that $|\alpha| + 1 = |\beta|$, $x' \in X$ is called an (α, β) -successor of x , if there exist states $x_0, \dots, x_{|\alpha|} \in X$ such that $x_0 = x$, $x_{|\alpha|} = x'$, $H(x_{|\alpha|}) = \beta_{|\alpha|}$, and $H(x_i) = \beta_i$ and $(x_i, \alpha_i, x_{i+1}) \in \longrightarrow$ for all integers $0 \leq i \leq |\alpha| - 1$. The set of (α, β) -successors of a state $x \in X$ (resp., a subset $X' \subset X$) is denoted by $\text{Post}_{\alpha\beta}^S(x)$ (resp., $\text{Post}_{\alpha\beta}^S(X') := \bigcup_{x \in X'} \text{Post}_{\alpha\beta}^S(x)$).

An *internal run* of system S is an infinite sequence $r_{int} := x_0 u_0 x_1 u_1 \cdots x_{n-1} u_{n-1} x_n \cdots$ such that $x_0 \in X_0$, and for any $i \geq 0$ we have $(x_i, u_i, x_{i+1}) \in \longrightarrow$. An *external run* is an infinite sequence $r_{ext} := y_0 u_0 y_1 \cdots y_{n-1} u_{n-1} y_n \cdots$ such that $y_0 = H(x_0)$ for some $x_0 \in X_0$, and for any $i \geq 0$ there exist $x_i \in X$ and $x_{i+1} \in X$ such that $y_i = H(x_i)$, $y_{i+1} = H(x_{i+1})$, and $(x_i, u_i, x_{i+1}) \in \longrightarrow$. The internal (resp., external) *prefix* up to x_n (resp., y_n) of r_{int} (resp., r_{ext}) is denoted by $r_{int}(n)$ (resp., $r_{ext}(n)$) and its last element is $\text{Last}(r_{int}(n)) := x_n$ (resp., $\text{Last}(r_{ext}(n)) := y_n$). The set of all internal (resp., external) runs and the set of all internal (resp., external) n -length prefixes are denoted by $\text{RUNS}_{int}(S)$ (resp., $\text{RUNS}_{ext}(S)$) and $\text{PREFS}_{int}^n(S)$ (resp., $\text{PREFS}_{ext}^n(S)$), respectively. A state x is said to be *reachable* iff there exists at least one internal *prefix* $r_{int}(n) \in \text{PREFS}_{int}^n(S)$ such that $\text{Last}(r_{int}(n)) = x$ for some $n \in \mathbb{N}$.

B. Composition of systems

Systems are composed together to construct new systems. Here, we define formally different types of compositions.

Definition III.2 (Serial Composition). *Consider two systems $S_i := (X_i, X_{i,0}, U_i, \xrightarrow{i}, Y_i, H_i)$, $i \in \{1, 2\}$, such that $Y_1 \subseteq U_2$. The serial (a.k.a. cascade) composition of S_1 and S_2 , denoted by $S_2 \circ S_1$, is a new system $S_{12} := (X_1 \times X_2, X_{1,0} \times X_{2,0}, U_1, \xrightarrow{12}, Y_2, H_{12})$, where $((x_1, x_2), u_1, (x'_1, x'_2)) \in \xrightarrow{12}$ iff there exist two transitions $(x_1, u_1, x'_1) \in \xrightarrow{1}$ and $(x_2, H_1(x_1), x'_2) \in \xrightarrow{2}$, and map H_{12} is defined as follows for any $(x_1, x_2) \in X_1 \times X_2$: $H_{12}((x_1, x_2)) := H_2(x_2)$.*

Definition III.3 (Feedback Composition). *Consider two systems $S_i := (X_i, X_{i,0}, U_i, \xrightarrow{i}, Y_i, H_i)$, $i \in \{1, 2\}$, such that $Y_1 \subseteq U_2$, $Y_2 \subseteq U_1$, and the following holds:*

$$\begin{aligned} y_2 = H_2(x_2) \wedge y_1 = H_1(x_1) \wedge \text{Post}_{y_2}^{S_1}(x_1) = \emptyset \\ \implies \text{Post}_{y_1}^{S_2}(x_2) = \emptyset. \end{aligned}$$

Then, S_1 is said to be feedback-composable with S_2 (denoted by $S_1 \times S_2$) and the new composed system is $S_{12} := (X_1 \times X_2, X_{1,0} \times X_{2,0}, \{0\}, \xrightarrow{12}, Y_1 \times Y_2, H_{12})$, where $((x_1, x_2), 0, (x'_1, x'_2)) \in \xrightarrow{12}$ iff there exist two transitions $(x_1, H_2(x_2), x'_1) \in \xrightarrow{1}$ and $(x_2, H_1(x_1), x'_2) \in \xrightarrow{2}$, and the map H_{12} is defined as follows for any $(x_1, x_2) \in X_1 \times X_2$:

$$H_{12}((x_1, x_2)) := (H_1(x_1), H_2(x_2)).$$

The feedback composition in [4] requires that one of the systems is Moore (i.e., the output does not depend on the input). Such assumption is already fulfilled here since all systems are Moore by Definition III.1. The following proposition shows that external runs of feedback-composed systems are tightly connected to external runs of their subsystems. It is used later in Subsection V-D to prove the output-based behavioral inclusion from original systems to symbolic models.

Proposition III.4. *Consider two systems $S_i := (X_i, X_{i,0}, U_i, \xrightarrow{i}, Y_i, H_i)$, $i \in \{1, 2\}$, such that S_1 is feedback-composable with system S_2 . Then, for a feedback-composed system $S_1 \times S_2$, an external run $r_{S_1 \times S_2, ext} := (y_{1,0}, y_{2,0})0(y_{1,1}, y_{2,1})0 \cdots$ exists iff there exist two external runs $r_{S_1, ext} := y_{1,0}y_{2,0}y_{1,1}y_{2,1} \cdots$ and $r_{S_2, ext} := y_{2,0}y_{1,0}y_{2,1}y_{1,1} \cdots$.*

Proof. The proof is straightforward based on Definitions III.1 and III.3. \square

Definition III.5 (Observation Composition). *Consider two systems $S_i := (X_i, X_{i,0}, U_i, \xrightarrow{i}, Y_i, H_i)$, $i \in \{1, 2\}$, such that $U_1 \times Y_1 \subseteq U_2$. The observation composition of S_1 and S_2 , denoted by $S_2 \triangleleft S_1$, is a new system $S_{12} := (X_1 \times X_2, X_{1,0} \times X_{2,0}, U_1, \xrightarrow{12}, X_2, H_{12})$, where $((x_1, x_2), u_1, (x'_1, x'_2)) \in \xrightarrow{12}$ iff there exist two transitions: $(x_1, u_1, x'_1) \in \xrightarrow{1}$ and $(x_2, (u_1, H_1(x_1)), x'_2) \in \xrightarrow{2}$, and $H_{12} := \pi_{X_2}$.*

The observation composition is used when system S_2 is an observer that infers the states of S_1 by monitoring its inputs and outputs.

C. Specifications and Control Problems

Now, we discuss the behaviors of systems and their specifications. Let S be a system as defined in Definition III.1. The internal and external behaviors of S are subsets of the set of all (possibly infinite) internal and external prefixes of S , i.e., $B_{int}(S) \subseteq \bigcup_{n \in \mathbb{N} \cup \{\infty\}} \text{PREFS}_{int}^n(S)$ and $B_{ext}(S) \subseteq \bigcup_{n \in \mathbb{N} \cup \{\infty\}} \text{PREFS}_{ext}^n(S)$. Specifications are defined next.

Definition III.6 (Specification). *Let S be a system as defined in Definition III.1. Let $\Gamma_S := \pi_Y(B_{ext}(S))$ be the set of all output sequences of S . A specification $\psi \subseteq \Gamma_S$ is a set of output*

sequences that must be enforced on S . System S satisfies ψ (denoted by $S \models \psi$) iff $\pi_Y(B_{ext}(S)) \subseteq \psi$.

Specifications can adopt formal requirements encoded as linear temporal logic (LTL) [20] formulae or automata on finite strings. Classical requirements like *invariance* (often referred to as *safety*) and *reachability* can be readily included. Given a safe set of observations $F \subseteq Y$, we denote by $\text{Safe}(F)$ the *safety specification* and we define it as follows:

$$\text{Safe}(F) := \{y_0y_1y_2 \cdots \in \Gamma_S \mid \forall k \geq 0 (y_k \in F)\}.$$

The safety objective requires that the output of S always remains within subset F . Using LTL, such a safety specification is encoded as the formula $\Box F$. Similarly, for a target set of observations $T \subseteq Y$, we denote by $\text{Reach}(T)$ the *reachability specification* and we define it as follows:

$$\text{Reach}(T) := \{y_0y_1y_2 \cdots \in \Gamma_S \mid \exists k \geq 0 (y_k \in T)\}.$$

The reachability objective requires that the output of S visits, at least once, some elements in T . Such a reachability specification is encoded as the LTL formula $\Diamond T$.

Specifications like *infinitely often* ($\Box \Diamond G$) and *eventually forever* (a.k.a. *persistence*) ($\Diamond \Box G$), for a set of observations $G \subseteq Y$, can be defined in a similar way. It is also possible to extend the specifications to include timing constrains. For example, $\text{Safe}_{[a,b]}(F)$ and $\text{Reach}_{[a,b]}(T)$ require that the output follows the specifications during the time steps $k \in \{a, a+1, \dots, b\}$. Such time-constrained specifications can be encoded in the form of metric temporal logic (MTL) formulae [21].

Remark III.7. For state-based systems, specifications are reduced automatically to sequences of states, since external and internal behaviors of systems coincide. In such a case, the satisfaction condition in Definition III.6 should be checked against internal behaviors.

Now, we introduce the control problem considered in this article. We then introduce controllers and their domains.

Problem III.8 (Control Problem). Consider a system S as defined in Definition III.1. Let ψ be a given specification on S following Definition III.6. We denote by the tuple (S, ψ) the control problem of finding a system C such that $C \times S \models \psi$.

Definition III.9 (Controller). Given a control problem (S, ψ) as defined in Problem III.8, a controller solving the control problem is a feedback-composable system

$$C := (X_C, X_{C,0}, U_C, \xrightarrow{C}, Y_C, H_C),$$

where $U_C := Y$ and $Y_C := U$. All of X_C , $X_{C,0}$, \xrightarrow{C} , and H_C are constructed such that

$$C \times S \models \psi.$$

The domain of controller C is the set of initial states of the controlled systems that can be controlled to solve the main control problem. We define it formally next.

Definition III.10 (Domain of Controller). *Consider a controller C solving (S, ψ) , as defined in Definition III.9. The domain of C is denoted by $\mathcal{D}(C) \subseteq X_0$ and defined as follows:*

$$\mathcal{D}(C) := \{x \in X_0 \mid C \times S^{\{\{x\}\}} \models \psi\}.$$

IV. OUTPUT-FEEDBACK REFINEMENT RELATIONS

We first revise FRRs [4] and then introduce OFRRs.

Definition IV.1 (FRR). *Consider two state-based systems $S_i := (X_i, X_{i,0}, U_i, \xrightarrow{i}, X_i, id_{X_i})$, $i \in \{1, 2\}$, and assume that $U_2 \subseteq U_1$. A strict relation $Q \subseteq X_1 \times X_2$ is an FRR from S_1 to S_2 if all of the followings hold for all $(x_1, x_2) \in Q$:*

- (i) $U_{S_2}(x_2) \subseteq U_{S_1}(x_1)$,
- (ii) $u \in U_{S_2}(x_2) \implies Q(\text{Post}_u^{S_1}(x_1)) \subseteq \text{Post}_u^{S_2}(x_2)$, and
- (iii) $x_1 \in X_{1,0} \implies x_2 \in X_{2,0}$.

When Q is an FRR from S_1 to S_2 , this is denoted by $S_1 \preceq_Q S_2$.

FRRs are introduced to resolve common shortcomings in alternating (bi-)simulation relations (ASR) and their approximate versions. As discussed in [4], using ASR results in controllers that require exact state information of concrete systems while only quantized state information is usually available. Additionally, the refined controllers contain symbolic models of original systems as building blocks inside them, which makes the implementation much more complex. On the other hand, controllers designed for systems related via FRRs require only quantized-state information. They can be feedback-composed with original systems through static quantizers and they do not require the symbolic models as building blocks inside them. Such features simplify refining and implementing the synthesized symbolic controllers.

Unfortunately, FRRs are only applicable to state-based systems. Basically, a controller synthesized for the outputs of a symbolic model can not be refined to work with its original system. This is because there is no mapping from the outputs of the original system to the outputs of its symbolic model. Consequently, outputs of original systems received by the refined controllers cannot be matched to outputs of symbolic models used previously to synthesize the symbolic controllers. We introduce OFRRs as extensions of FRRs so that one can construct symbolic models, synthesize symbolic controllers and refine them for output-based systems.

If S_1 and S_2 are *output-based* systems, we use $S_1 \preceq_Q S_2$ to denote that $Q \subseteq X_1 \times X_2$ is an FRR from S_{1, X_1} to S_{2, X_2} .

Definition IV.2 (OFRR). Consider two output-based systems $S_i := (X_i, X_{i,0}, U_i, \xrightarrow{i}, Y_i, H_i)$, $i \in \{1, 2\}$, such that $U_2 \subseteq U_1$. Let $Q \subseteq X_1 \times X_2$ be an FRR such that $S_1 \preceq_Q S_2$. A relation $Z \subseteq Y_1 \times Y_2$ is an OFRR if all of the followings hold:

- (i) For any $(y_1, y_2) \in Z$, $\bar{U}_{S_2}(y_2) \subseteq \bar{U}_{S_1}(y_1)$,
- (ii) For any $(x_1, x_2) \in Q$, $\exists (y_1, y_2) \in Z$ s.t. $y_1 = H_1(x_1) \wedge y_2 = H_2(x_2)$, and
- (iii) For any $(y_1, y_2) \in Z$, $\exists (x_1, x_2) \in Q$ s.t. $x_1 \in H_1^{-1}(y_1) \wedge x_2 \in H_2^{-1}(y_2)$.

Condition (i) ensures the admissibility of inputs of S_2 for S_1 . This is not restrictive for output-based systems representing control systems as we show later in Remark V.2. Conditions (ii) and (iii) ensure that observed outputs correspond to evolving states that obey a valid FRR between the two systems. For the sake of a simpler presentation, we slightly abuse the notation hereinafter and use $S_1 \preceq_Z S_2$ to indicate the existence of OFRR Z from S_1 to S_2 .

We provide a simple example to illustrate the importance of conditions (ii) and (iii).

Example IV.3. Consider system $S := (X, X, U, \longrightarrow, Y, H)$, where $X := \{x_1, x_2, x_3, x_4\}$, U and \longrightarrow are some sets, $Y := \{y_1, y_2, y_3, y_4\}$, and $H(x_i) := y_i$, for all $i \in \{1, 2, 3, 4\}$. Also consider system $S_q := (X_q, X_q, U_q, \xrightarrow{q}, Y_q, H_q)$, where $X_q := \{x_{q1}, x_{q2}, x_{q3}\}$, \xrightarrow{q} and $U_q \subseteq U$ are some sets, $Y_q := \{y_{q1}, y_{q2}, y_{q3}\}$, and $H_q(x_{qi}) := y_{qi}$, for all $i \in \{1, 2, 3\}$. Consider a relation $Q := \{(x_1, x_{q1}), (x_2, x_{q1}), (x_3, x_{q2}), (x_4, x_{q2})\}$ and assume that the settings of U , \longrightarrow , U_q , and \xrightarrow{q} ensure that $S \preceq_Q S_q$. We inspect two relations $Z_1 \subseteq Y \times Y_q$ and $Z_2 \subseteq Y \times Y_q$ lacking, respectively, conditions (ii) and (iii) in Definition IV.2:

- 1) A relation $Z_1 := \{(y_1, y_{q1}), (y_3, y_{q2}), (y_4, y_{q2})\}$ violates condition (ii). Note that $(x_2, x_{q1}) \in Q$ has no corresponding element in Z_1 that satisfies the condition. Consequently, if S is at state x_2 , its output $y_2 = H(x_2)$ can not be mapped to one of the outputs of S_q . Condition (ii) ensures that, as system S evolves, there always exist related observations in set Y_q .
- 2) A relation $Z_2 := \{(y_1, y_{q1}), (y_2, y_{q1}), (y_3, y_{q2}), (y_4, y_{q2}), (y_3, y_{q3})\}$ violates condition (iii). More precisely, $(y_3, y_{q3}) \in Z$ has no corresponding element in Q that satisfies condition (iii). Now, $\{y_{q2}, y_{q3}\} = Z(y_3)$ makes it ambiguous to map the the output y_3 from S to S_q . Condition (iii) makes sure that outputs can be mapped unambiguously from S to S_q .

The following proposition provides sufficient conditions for the existence of OFRR.

Proposition IV.4. Consider two systems $S_i := (X_i, X_{i,0}, U_i, \xrightarrow{i}, Y_i, H_i)$, $i \in \{1, 2\}$ having $U_2 \subseteq U_1$. Let $Q \subseteq X_1 \times X_2$ be an FRR such that $S_1 \preceq_Q S_2$, Y_2 partitions Y_1 , and

$$y \in Y_2 \implies H_1(Q^{-1}(H_2^{-1}(y))) \equiv y. \quad (1)$$

Then, there exists a unique OFRR $Z \subseteq Y_1 \times Y_2$ corresponding to FRR Q such that $S_1 \preceq_Z S_2$.

Proof. Let $Q \subseteq X_1 \times X_2$ be an FRR. We first prove by construction that Z exists. Let Z be as follows:

$$Z := \{(y_1, y_2) \mid y_1 = H_1(x_1) \wedge y_2 = H_2(x_2) \text{ for some } (x_1, x_2) \in Q\},$$

which satisfies conditions (i)-(iii) in Definition IV.2.

Now, we prove that Z is unique. Consider two OFRRs Z_1 and Z_2 having the same underlying FRR Q . We show that they are equal. Consider any $(y_{1,1}, y_{1,2}) \in Z_1$. We know from condition (iii) in the definition of OFRR Z_1 that there exists $(x_1, x_2) \in Q$ such that $x_1 \in H_1^{-1}(y_{1,1})$ and

$x_2 \in H_2^{-1}(y_{1,2})$. We also know from condition (ii) in the definition of OFRR Z_2 that there exists $(y_1, y_2) \in Z_2$ such that $y_1 = H_1(x_1)$ and $y_2 = H_2(x_2)$. Clearly, $y_1 = y_{1,1}$ and $y_2 = y_{1,2}$ since the output maps are single-valued. This implies that $(y_{1,1}, y_{1,2}) \in Z_2$ and, hence, $Z_1 \subseteq Z_2$. One can, similarly, show that $Z_2 \subseteq Z_1$ which proves that $Z_1 = Z_2$. \square

The following corollary shows that OFRR and FRR coincide if the related systems are state-based.

Corollary IV.5. *Consider two systems $S_i := (X_i, X_{i,0}, U_i, \xrightarrow{i}, X_i, id_{X_i})$, $i \in \{1, 2\}$, such that $U_2 \subseteq U_1$. Let $Q \subseteq X_1 \times X_2$ be an FRR such that $S_1 \preceq_Q S_2$. Then, Z and Q coincide (i.e., $Q = Z$).*

Proof. The proof is straightforward since we have $Q \subseteq Z$ and $Z \subseteq Q$ as a result of making $H_i = id_{X_i}$, $i \in \{1, 2\}$ and using Definition IV.2. \square

The following proposition shows that, when two systems are related via an OFRR Z and as we observe one of the systems, we can always find corresponding outputs of the other system such that the successor outputs of both systems are in Z . Such a feature is used to prove the output-based behavioral inclusion from original systems to symbolic ones in Subsection V-D.

Proposition IV.6. *Consider two systems $S_i := (X_i, X_{i,0}, U_i, \xrightarrow{i}, Y_i, H_i)$, $i \in \{1, 2\}$ having $U_2 \subseteq U_1$. Let $Z \subseteq Y_1 \times Y_2$ be an OFRR s.t. $S_1 \preceq_Z S_2$. Then, for any $(y_1, y_2) \in Z$ we have:*

$$\forall u \in \bar{U}_{S_2}(y_2) \forall y'_1 \in \overline{\text{Post}}_u^{S_1}(y_1) \exists y'_2 \in \overline{\text{Post}}_u^{S_2}(y_2) \text{ s.t.} \\ ((y'_1, y'_2) \in Z).$$

Proof. Consider any $(y_1, y_2) \in Z$ and any $u \in \bar{U}_{S_2}(y_2)$. We know by condition (i) in Definition IV.2 that $u \in \bar{U}_{S_1}(y_1)$. We also know from condition (iii) in Definition IV.2 that there exists $(x_1, x_2) \in Q$ such that $y_1 = H_1(x_1)$ and $y_2 = H_2(x_2)$. Now, consider any $x'_1 \in \text{Post}_u^{S_1}(x_1)$. Also, consider the output of x'_1 which is $y'_1 = H_1(x'_1) \in H(\text{Post}_u^{S_1}(x_1)) \subseteq \overline{\text{Post}}_u^{S_1}(y_1)$.

We know from Definition IV.1 for Q that $Q(x'_1) \subseteq \text{Post}_u^{S_2}(x_2)$ which implies that there exists $x'_2 \in X_2$ such that $(x'_1, x'_2) \in Q$. From Definition IV.2 for Z , there exists $(y'_1, y^*) \in Z$ with $y^* = H_2(x'_2)$. What remains is to show that $y^* \in \overline{\text{Post}}_u^{S_2}(y_2)$. By definition, we have $\overline{\text{Post}}_u^{S_2}(y_2) = H_2(\text{Post}_u^{S_2}(H_2^{-1}(y_2)))$. We also know from Definition IV.2 that $x_2 \in H_2^{-1}(y_2)$ which implies that $x'_2 \in \text{Post}_u^{S_2}(H_2^{-1}(y_2))$. Note that $y^* = H_2(x'_2)$ implies that $y^* \in H_2(\text{Post}_u^{S_2}(H_2^{-1}(y_2))) = \overline{\text{Post}}_u^{S_2}(y_2)$. \square

V. OUTPUT-FEEDBACK SYMBOLIC CONTROL

We first introduce control systems. Then, we construct symbolic models of them and synthesize their symbolic controllers using OFRRs.

A. Control systems

Definition V.1 (Control System). *A control system is a tuple $\Sigma := (\mathcal{X}, \mathcal{U}, f, \mathcal{Y}, h)$, where $\mathcal{X} \subseteq \mathbb{R}^n$ is the state set; $\mathcal{U} \subseteq \mathbb{R}^m$ is an input set; $f : \mathcal{X} \times \mathcal{U} \rightarrow \mathcal{X}$ is a continuous map satisfying the*

following Lipschitz assumption: for each compact set $X \subseteq \mathcal{X}$, there exists a constant $L \in \mathbb{R}^+$ such that

$$\|f(x_1, u) - f(x_2, u)\| \leq L\|x_1 - x_2\|,$$

for all $x_1, x_2 \in X$ and all $u \in \mathcal{U}$; $\mathcal{Y} = \mathbb{R}^q$ is the output set; and $h : \mathcal{X} \rightarrow \mathcal{Y}$ is an output (a.k.a. observation) map.

Let \mathcal{U} be the set of all functions of time from $]a, b[\subseteq \mathbb{R}$ to \mathcal{U} with $a < 0$ and $b > 0$. We define a trajectory of Σ by a locally absolutely continuous curve $\xi :]a, b[\rightarrow \mathcal{X}$ if there exists a $v \in \mathcal{U}$ that satisfies $\dot{\xi}(t) = f(\xi(t), v(t))$ at any $t \in]a, b[$. We redefine $\xi : [0, t] \rightarrow \mathcal{X}$ for trajectories over closed intervals with the understanding that there exists a trajectory $\xi' :]a, b[\rightarrow \mathcal{X}$ for which $\xi = \xi'|_{[0, t]}$ with $a < 0$ and $b > t$. $\xi_{xv}(t)$ denotes the state reached at time t under input v and with the initial condition $\xi_{xv}(0) = x$. Such a state is uniquely determined since the assumptions on f ensure the existence and uniqueness of its trajectories [22]. System Σ is said to be *forward complete* if every trajectory is defined on an interval of the form $]a, \infty[$. Here, we consider forward complete control systems. We also define $\zeta : [0, t] \rightarrow \mathcal{Y}$ as an output trajectory of Σ if there exists a trajectory ξ_{xv} over $[0, t]$ such that at any time $\tilde{t} \in [0, t]$ we have that $\zeta(\tilde{t}) = h(\xi_{xv}(\tilde{t}))$.

B. Control Systems as Systems

Let Σ be a control system as defined in Definition V.1. The sampled version of Σ (a.k.a. concrete system) is a system

$$S_\tau(\Sigma) := (X_\tau, X_\tau, U_\tau, \xrightarrow{\tau}, Y_\tau, H_\tau), \quad (2)$$

that encapsulates the information contained in Σ at sampling times $k\tau$, for all $k \in \mathbb{N}$, where $X_\tau \subseteq \mathcal{X}$, U_τ is the set of piece-wise constant curves of length τ defined as follows:

$$U_\tau := \{v_\tau : [0, \tau[\rightarrow \mathcal{U} \mid \forall t \in [0, \tau[(v_\tau(t) = v_\tau(0))\},$$

$Y_\tau := \{y_\tau \in \mathcal{Y} \mid \exists x_\tau \in X_\tau (y_\tau = h(x_\tau))\}$, $H_\tau := h$, and a transition $(x_\tau, v_\tau, x'_\tau) \in \xrightarrow{\tau}$ iff there exists a trajectory $\xi : [0, \tau] \rightarrow \mathcal{X}$ in Σ such that $\xi_{x_\tau v_\tau}(\tau) = x'_\tau$. We sometimes use S_τ to refer to the sampled-data system $S_\tau(\Sigma)$.

Remark V.2. System S_τ is deterministic since any trajectory of Σ is uniquely determined. Sets X_τ and U_τ are uncountable, and hence, S_τ is not symbolic. Since all trajectories of Σ are defined for all inputs and all states, we have $U_{S_\tau}(x_\tau) = U_\tau$, for all $x_\tau \in X_\tau$, and $\bar{U}_{S_\tau}(y) = U_\tau$, for all $y \in Y_\tau$.

System S_τ is an output-based system. Any system feedback-composed with (or, serially

composed after) S_τ has no access to its states, but rather to its outputs. Throughout this article, we also consider a state-based version of S_τ (denoted by $S_{\tau,X}(\Sigma)$) and defined as follows:

$$S_{\tau,X}(\Sigma) := (X_\tau, X_\tau, U_\tau, \xrightarrow{\tau}, X_\tau, id_{X_\tau}). \quad (3)$$

C. Symbolic Models of Control Systems

We utilize OFRRs (and their underlying FRRs) to construct symbolic models that approximate S_τ . Given a control system Σ , let S_τ be its sampled-data representation, as defined in (2). A symbolic model of S_τ is a system:

$$S_q := (X_q, X_q, U_q, \xrightarrow{q}, Y_q, H_q), \quad (4)$$

where $X_q := X_\tau/\bar{Q}$, \bar{Q} is a finite equivalence relation on X_τ , U_q is a finite subset of U_τ , $(x_q, u_q, x'_q) \in \xrightarrow{q}$ if there exist $x \in x_q$ and $x' \in x'_q$ such that $(x, u_q, x') \in \xrightarrow{\tau}$, $Y_q := H_\tau(X_\tau)/\bar{Z}$, where \bar{Z} is a finite equivalence relation on Y_τ , $H_q(x_q) := \{y_q \in Y_q \mid y_q \cap H_\tau(x_q) \neq \emptyset\}$, and condition (1) holds for $S_1 := S_\tau$ and $S_2 := S_q$.

Starting with a given equivalence relation \bar{Z} on Y_τ , one can construct the underlying equivalence relation \bar{Q} on X_τ using the following relation condition for any $(x_a, x_b) \in \bar{Q}$:

$$x_a \sim x_b \iff (H_\tau(x_a), H_\tau(x_b)) \in \bar{Z}, \quad (5)$$

which ensures that condition (1) is satisfied. The following theorem shows that the above introduced construction of S_q implies the existence of some OFRR Z such that $S_\tau \preceq_Z S_q$.

Theorem V.3. *Let S_τ be defined as in (2). Also, let S_q be defined as in (4) for some equivalence relations \bar{Q} on X_τ and \bar{Z} on $H_\tau(X_\tau)$. Then,*

$$Z := \{(y, [y]) \in Y_\tau \times Y_q \mid y \in H_\tau(X_\tau)\},$$

is an OFRR such that $S_\tau \preceq_Z S_q$ and

$$Q := \{(x, [x]) \in X_\tau \times X_q \mid x \in X_\tau\},$$

is its underlying FRR.

Proof. First, we show that Q is an FRR. Clearly, conditions (i) and (iii) in Definition IV.1 hold since S_τ represents a control system. See Remark V.2 for more details. We show that condition (ii) holds. Consider any $(x, [x]) \in Q$ and any input $u_q \in U_q([x])$. Also consider any successor state $x' \in \text{Post}_{u_q}^{S_\tau}(x)$. Remark that $x \in [x]$ and $x' \in [x']$ since Q is an equivalence relation. Now, from the definition of S_q in (4), we know that there exists a corresponding transition $([x], u_q, [x'])$ in \xrightarrow{q} . Since, $[x'] \in Q(x)$, by the definition of Q , we have that $[x'] \in \text{Post}_{u_q}^{S_q}([x])$. Consequently, Q is an FRR from S_{τ,X_τ} to S_{q,X_q} .

Now, we show that Z is an OFRR. Again, condition (i) in Definition IV.2 holds since S_τ represents a control system.

We show that condition (ii) in Definition IV.2 holds. Consider any $(x, [x]) \in Q$. Since $x \in X_\tau$, there exists one observation $y := H_\tau(x)$. Note that $[x] \in X_q$. Now, by the definition of Y_q in (4), we know there exists $[y] \in Y_q$ such that $[y] = H_q([x])$. Finally, by the definition of Z , which is based on the equivalence relation \bar{Z} , we have that $(y, [y]) \in Z$, and this, consequently, satisfies condition (ii) in Definition IV.2.

We show that condition (iii) in Definition IV.2 holds. Consider any $(y, [y]) \in Z$. Note that $y \in H_\tau(X_\tau)$ (i.e., inside the the image of X_τ using H_τ). From the definition of system S_τ in (2), we know that there exists $x \in X_\tau$ such that $x = H_\tau^{-1}(y)$. Also, we know from condition (1) and the definition of X_q that there exists $[x] \in X_q$ such that $[x] = H_\tau^{-1}([y])$. Finally, by the definition of Q , which is based on the equivalence relation \bar{Q} , we conclude that $(x, [x]) \in Q$, and this, consequently, satisfies condition (iii) in Definition IV.2.

Now, recall Proposition IV.4, and set $S_1 := S_\tau$ and $S_2 := S_q$. Hence, we have that $S_\tau \preceq_Z S_q$. \square

D. Synthesis and Refinement of Symbolic Controllers

Let ψ_q be a given output-based specification on S_q as introduced in (4). ψ_τ is the corresponding concrete specification that should be enforced on S_τ and it is interpreted as follows:

$$\psi_\tau := \{\bar{s} \in \Gamma_{S_\tau} \mid \exists s \in \psi_q \forall i \in \{0, 1, \dots, |s| - 1\} \\ (s_i = Z(\bar{s}_i))\}. \quad (6)$$

Here, S_τ and ψ_τ represent together a *concrete control problem* (S_τ, ψ_τ) , whereas (S_q, ψ_q) represents an *abstract control problem*. To algorithmically design controllers solving (S_τ, ψ_τ) , we utilize (S_q, ψ_q) to automatically synthesize a *symbolic controller* C_q that can be refined to solve (S_τ, ψ_τ) . Later in Section VIII, we propose a methodology for synthesizing C_q , which is then refined with a suitable interface to a controller C_τ that solves the concrete control problem (S_τ, ψ_τ) .

Now, we show that OFRRs preserve the behavioral inclusion from concrete systems to symbolic models.

Theorem V.4. *Consider systems S_τ and S_q as introduced in (2) and (4), respectively, where Z is an OFRR and $S_\tau \preceq_Z S_q$. Let C_q be a controller that solves (S_q, ψ_q) . Then,*

- (i) $(C_q \circ Z)$ is feedback-composable with S_τ ;
- (ii) $Z(B_{int}((C_q \circ Z) \times S_\tau)) \subseteq B_{int}(C_q \times S_q)$; and
- (iii) $Z(B_{ext}((C_q \circ Z) \times S_\tau)) \subseteq B_{ext}(C_q \times S_q)$;

Proof. Proof of (i): Let system C_τ be of the form

$$C_\tau := C_q \circ Z := (X_C, X_{C,0}, U_C, \xrightarrow{C}, Y_C, H_C),$$

for some sets $X_C, X_{C,0}, U_C, \xrightarrow{C}$, and Y_C , and a map H_C . Now, based on the given assumptions and [4, Definition III.2], we have that $Y_C \subseteq U_q$ and $Y_\tau \subseteq U_C$. Since $U_q \subseteq U_\tau$, we know that

$Y_C \subseteq U_\tau$. From Definition IV.1 and since C_q is feedback-composable with S_q , we get

$$\begin{aligned} y_q &= H_q(x_q) \wedge u_q = H_{C_q}(x_{C_q}) \wedge \text{Post}_{y_q}^{C_q}(x_{C_q}) = \emptyset \\ &\implies \text{Post}_{u_q}^{S_q}(x_q) = \emptyset. \end{aligned}$$

From condition (i) in Definition IV.2 and considering Z as a serially composed static map with C_q , we get

$$\begin{aligned} y_\tau &= H_\tau(x_\tau) \wedge u_q = H_C(x_C) \wedge \text{Post}_{y_\tau}^{C_\tau}(x_C) = \emptyset \\ &\implies \text{Post}_{u_q}^{S_\tau}(x_\tau) = \emptyset, \end{aligned}$$

which completes the proof of (i).

Proof of (ii): The results in [4, Theorem V.4] are directly applicable here since S_{τ, X_τ} and S_{q, X_q} are state-based systems that are related via an FRR. This completes the proof of (ii).

To proof (iii), consider any external run $r_{C_\tau \times S_\tau, ext} \in B_{ext}(C_\tau \times S_\tau)$ defined as:

$$r_{C_\tau \times S_\tau, ext} := (u_q^0, y_\tau^0)0(u_q^1, y_\tau^1)0 \cdots (u_q^i, y_\tau^i)0 \cdots,$$

where $i \in \mathbb{N}$. According to Proposition III.4, there exist two external runs:

$$\begin{aligned} r_{C_\tau, ext} &:= u_q^0 y_\tau^0 u_q^1 y_\tau^1 \cdots u_q^i y_\tau^i \cdots, \text{ and} \\ r_{S_\tau, ext} &:= y_\tau^0 u_q^0 y_\tau^1 u_q^1 \cdots y_\tau^i u_q^i \cdots, \end{aligned} \tag{7}$$

where $i \in \mathbb{N}$.

Notice how the output sets Y_τ and Y_q are constructed in (2) and (4), respectively. Both of them use map H_τ to project the state set X_τ . Then, one can easily show that Z is a strict relation. Now, using the given relation Z and for any y_τ^i , $i \in \mathbb{N}$, we know that there exists a corresponding $y_q^i \in Y_q$ such that $(y_\tau^i, y_q^i) \in Z$. This allows us to apply Z on the concrete output elements of each of the runs in 7.

Now, by applying Proposition IV.6 inductively to (7) starting with $(y_\tau^0, y_q^0) \in Z$, we conclude that the following external run $r_{S_q, ext} \in B_{ext}(S_q)$ exists:

$$r_{S_q, ext} := y_q^0 u_q^0 y_q^1 u_q^1 \cdots y_q^i u_q^i \cdots.$$

Also, since map Z is strict, and it interfaces the input to C_q , one can assume that run $r_{C_\tau, ext} \in B_{ext}(C_\tau)$ is synchronized with an run $r_{C_q, ext} \in B_{ext}(C_q)$ given by:

$$r_{C_q, ext} := u_q^0 y_q^0 u_q^1 y_q^1 \cdots u_q^i y_q^i \cdots.$$

Again, according to Proposition III.4, the two runs $r_{C_q, ext}$ and $r_{S_q, ext}$ imply the existence of the external run of the feedback-composed system $C_q \times S_q$:

$$r_{C_q \times S_q, ext} := (u_q^0, y_q^0)0(u_q^1, y_q^1)0 \cdots (u_q^i, y_q^i)0 \cdots,$$

where $i \in \mathbb{N}$, which proves that $r_{(C_q \circ Z) \times S_\tau, ext} \in B_{ext}(C_q \times S_q)$, and completes the proof of (iii). \square

The following corollary shows that internal behavioral inclusion from a concrete closed-loop to a symbolic closed-loop implies an external behavioral inclusion.

Corollary V.5. *Let S_τ and S_q be as introduced in (2) and (4), respectively, where Z is an OFRR*

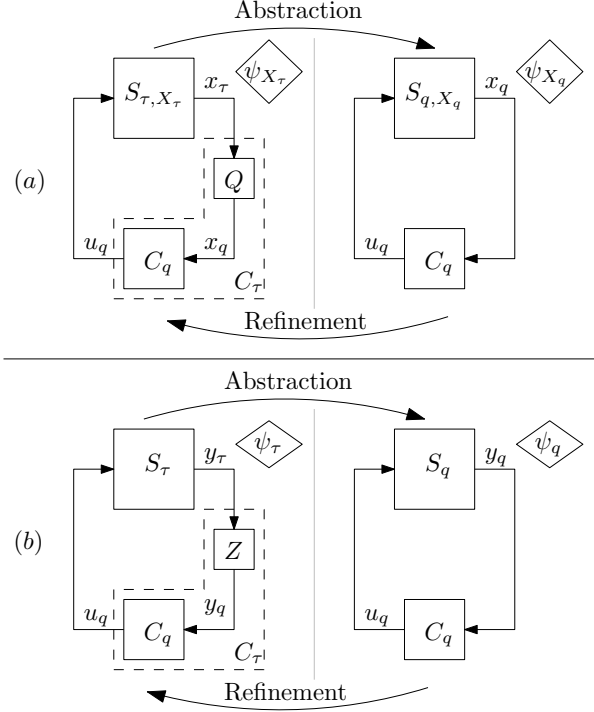

Fig. 1: Synthesis and refinement of (a) state-based and (b) output-based systems. Systems are represented by rectangles, specifications by diamonds and interconnections by arrows.

and $S_{\tau} \preceq_Z S_q$. Then,

$$B_{int}((C_q \circ Z) \times S_{\tau}) \subseteq B_{int}(C_q \times S_q) \implies \\ B_{ext}((C_q \circ Z) \times S_{\tau}) \subseteq B_{ext}(C_q \times S_q).$$

Proof. The proof is similar to that of part (iii) in Theorem V.4 by mapping the internal sequences to external sequences. \square

Remark V.6. Given two systems S_{τ} and S_q such that $S_{\tau} \preceq_Z S_q$, for some OFRR Z , a controller C_q that solves the abstract control problem (S_q, ψ_q) can be refined to solve the concrete control problem (S_{τ}, ψ_{τ}) using Z as a static map.

Remark V.7. Theorem V.4 and Corollary V.5 provide general results for output-feedback symbolic control. They can be applied to any methodology that can synthesize controllers (cf. Definition III.9) for the outputs of symbolic models (cf. the definition in (4)) to enforce output-based specifications (cf. Definition III.6).

The next three sections provide example methodologies that realize the introduced framework.

Figure 1 provides an illustration for the synthesis and refinement of symbolic controllers for state-based and output-based systems. For state-based systems, the refined controller is the symbolic controller serially composed after the map Q , i.e. $C_{\tau} = Q \circ C_q$ [4]. For output-based systems, the refined controller is the symbolic controller serially composed after the map Z , i.e.

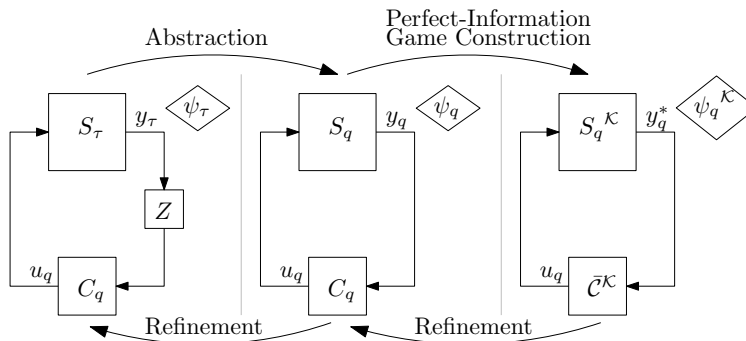

Fig. 2: Output-based symbolic control using two-player games with imperfect information.

$$C_\tau = Z \circ C_q.$$

The presented results serve as a generalized framework that formulates the synthesis and refinement of symbolic controllers for output-based systems. What remains is to provide specific implementations that show how symbolic controllers are synthesized and refined. In the following sections, we present three different methodologies to serve this purpose.

VI. METHODOLOGY 1: GAMES OF IMPERFECT INFORMATION

Two-player games on graphs arise in many computer science problems [23]. We utilize the results in [24]–[26] and construct perfect-information (a.k.a. knowledge-based) games from output-based symbolic models. Then, we solve the abstract control problem (or *the game*) as presented in [26]. We then refine the synthesized controller in two steps: 1) the symbolic controller synthesized for the game structure is refined to work with the symbolic model, and 2) Theorem V.4 is used to refine the controller once again for the concrete system. Figure 2 provides a high-level overview of this methodology.

A. Output-based Symbolic Control using Two-player Games

We assume having a symbolic model S_q , as defined in (4), related via an OFRR Z to a sampled output-based system S_τ , as defined in (2). The following assumptions are required [25]:

- 1) the abstract system S_q is total; and
- 2) the set $\{H_q^{-1}(y_q) | y_q \in Y_q\}$ partitions X_q .

The first assumption is not restrictive since all inputs are admissible to all states in control systems (see Remark V.2). The second assumption is already satisfied as we consider quotient systems, based on the definition of the symbolic model in (4) and the result from Theorem V.3.

The symbolic model S_q is seen as a *game structure* of two players played in rounds. The symbolic controller C_q is named `Player1` and, at each game round, it selects an input $u_q \in U_q$

for the game structure S_q . A hypothetical player `Player2`, or simply the symbolic model itself, responds by resolving the nondeterminism and selects a successor x'_q for the state x_q using the supplied input u_q such that $(x_q, u_q, x'_q) \in \xrightarrow{u_q}$.

S_q is considered as a game structure of imperfect information since `Player1` has no access to the states of the game. During the game play, only observations of the game structure are available to `Player1`. Given an internal run (a.k.a. a *play*) $r_{S_q,int}$, we construct a corresponding external run obs_q as the unique sequence of observations:

$$\begin{aligned} obs_q &:= r_{S_q,ext} \\ &= H_q(\pi_{X_q}(r_{S_q,int})) = y_{q,0}y_{q,1} \cdots y_{q,n-1}y_{q,n} \cdots \end{aligned}$$

The *knowledge* associated with the prefix $obs_q(n) := y_{q,0}y_{q,1} \cdots y_{q,n-1}y_{q,n}$ is given by the set:

$$\begin{aligned} \mathcal{K}(obs_q(n)) &:= \{\text{Last}(r_{S_q,int}(n)) \mid \\ &r_{S_q,int}(n) \in \text{PREFS}_{int}(S_q) \wedge H(r_{S_q,int}(n)) = obs_q(n)\}, \end{aligned}$$

which represents the set of possible underlying states expected at the end of the monitored observation sequence. Having an initial knowledge $s_0 := X_{q,0} \subseteq X_q$, the knowledge $s_i := \mathcal{K}(obs_q(i))$, at any step $i \in \mathbb{N}$, $i \geq 1$, can be constructed iteratively [25, Lemma 2.1] using the received observation and the input [26]:

$$s_i := \text{Post}_{u_{q,i}}^{S_q}(s_{i-1}) \cap H_q^{-1}(\text{Last}(obs_q(i))),$$

where $u_{q,i}$ is the input at time step i .

Remark VI.1. *Since `Player1` generates the inputs, it can construct the knowledge at every step by having s_0 and monitoring the observations of the game structure.*

B. Controller Synthesis and Refinement

Consider a concrete game (S_τ, ψ_τ) and its corresponding abstract game (S_q, ψ_q) , where $S_\tau \preceq_Z S_q$ and the specification ψ_q is constructed from ψ_τ using Z as a static map as introduced in (6). The first goal is to synthesize a controller C_q that solves $(C_q \times S_q)$.

A *strategy* for `Player1` is a map $\mathcal{C} : Y_q^* \rightarrow U_q$ that accepts a sequence of observations and produces a control input. \mathcal{C} is said to be memoryless strategy (a.k.a. a static controller) if $\mathcal{C}(r \cdot y_q) = \mathcal{C}(r' \cdot y_q)$ for all $r, r' \in Y_q^*$. A memoryless strategy \mathcal{C} induces another strategy $\bar{\mathcal{C}} : Y_q \rightarrow U_q$ that works with the last element of the observation for which $\mathcal{C}(r) = \bar{\mathcal{C}}(\text{Last}(r))$ for all $r \in Y_q^*$.

Having a strategy \mathcal{C} , we denote by $\text{Outcome}_{S_q}(\mathcal{C})$ the set of all possible state sequences resulting from closing the loop between S_q and \mathcal{C} , and we define it as follows:

$$\begin{aligned} \text{Outcome}_{S_q}(\mathcal{C}) := & \{x_{q,0}x_{q,1}\cdots \mid x_{q,0} \in X_{q,0} \wedge \\ & (\forall i \geq 0, (x_{q,i}, u_{q,i}, x_{q,i+1}) \in \xrightarrow[q]{\quad} \wedge u_{q,i} = \mathcal{C}(\text{obs}_q(i)))\}. \end{aligned}$$

We say that game (S_q, ψ_q) is solvable when there exists a strategy \mathcal{C} such that for all $r \in \text{Outcome}_{S_q}(\mathcal{C})$, we have $H_q(r) \in \psi_q$. The strategy is then called a winning strategy.

To check the existence of a winning strategy, we construct another game of perfect information [24, 26]. The knowledge-based perfect-information game structure is a system:

$$S_q^{\mathcal{K}} := (X_{\mathcal{K}}, s_0, U_q, \xrightarrow[\mathcal{K}]{\quad}, X_{\mathcal{K}}, \text{id}_{X_{\mathcal{K}}}),$$

where $X_{\mathcal{K}} := 2^{X_q} \setminus \{\emptyset\}$, and $(s_1, u_q, s_2) \in \xrightarrow[\mathcal{K}]{\quad}$ iff there exists an observation $y_q \in Y_q$ such that:

$$s_2 := \text{Post}_{u_q}^{S_q^{\mathcal{K}}}(s_1) \cap H_q^{-1}(y_q). \quad (8)$$

Proposition VI.2. *Player1 has a winning strategy in the game S_q starting at the initial set $X_{q,0}$ iff Player1 has a winning strategy in $S_q^{\mathcal{K}}$ starting at $X_{q,0}$.*

Proof. The proof is similar to that in [24, Proposition 2.1] and [25, Proposition 2.4]. \square

In [26, Algorithm 1], the game of imperfect information is solved using an antichain-based technique. The technique is implemented in a tool named ALPAGA [27]. Using the tool, one can possibly synthesize a winning memoryless strategy $\bar{\mathcal{C}}^{\mathcal{K}}$ for the game $(S_q^{\mathcal{K}}, \psi_q^{\mathcal{K}})$, where $\psi_q^{\mathcal{K}}$ is an extended version of ψ_q constructed by the same tool. The memoryless strategy is refined to work with S_q by embedding it inside the symbolic controller C_q :

$$C_q := (X_{C_q}, X_{C_q,0}, U_{C_q}, \xrightarrow[C_q]{\quad}, Y_{C_q}, H_{C_q}), \quad (9)$$

where

- $X_{C_q} := U_q \times 2^{X_q}$;
- $X_{C_q,0} := \{u_{q,0}\} \times X_q$, where $u_{q,0} \in U_q$;
- $U_{C_q} := Y_q$;
- $\xrightarrow[C_q]{\quad} := \{((u_q, x_{C_q}), y_q, (u'_q, x'_{C_q})) \mid x'_{C_q} = \text{Post}_{u_q}^{S_q}(x_{C_q}) \cap H_q^{-1}(y_q) \wedge u'_q = \bar{\mathcal{C}}^{\mathcal{K}}(x'_{C_q})\}$;
- $Y_{C_q} := U_q$; and
- $H_{C_q} := \pi_{U_q}$.

Remark VI.3. *The strategy $\bar{\mathcal{C}}^{\mathcal{K}}$ synthesized via the knowledge-based game is static. The refined game controller C_q contains the symbolic model S_q as a building block inside it, in order to*

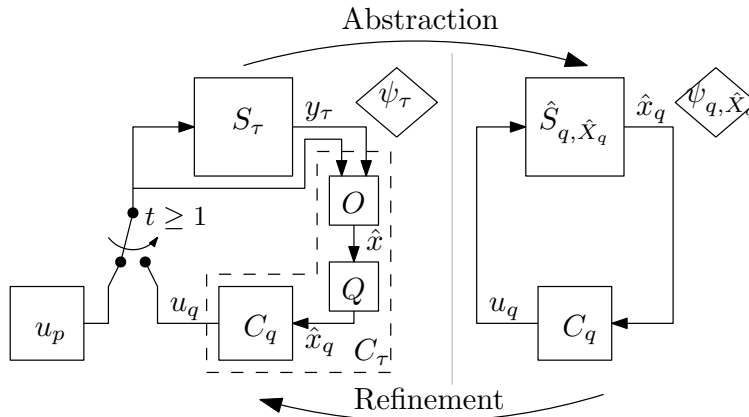

Fig. 3: Symbolic control of output-based systems using an observer for the concrete system.

compute the knowledge and, hence, it is not static anymore.

The following theorem shows how the controller is refined and concludes this section.

Theorem VI.4. *Let (S_τ, ψ_τ) be a concrete game and (S_q, ψ_q) be an abstract game, where $S_\tau \preceq_Z S_q$ and ψ_q is a specification constructed from ψ_τ using Z as a static map. If a controller C_q , as defined in (9), solves the game (S_q, ψ_q) then $(C_q \circ Z)$ solves the game (S_τ, ψ_τ) .*

Proof. The proof follows directly from Proposition VI.2 and Theorem V.4. \square

VII. METHODOLOGY 2: OBSERVERS FOR CONCRETE SYSTEMS

Observers estimate state values of control systems by observing their input and output sequences. We consider observers of concrete systems for output-based symbolic control. We give an informal overview of the methodology and then present it, in details, in the following subsections. Figure 3 depicts the abstraction and refinement phases of the proposed methodology. Consider the concrete system S_τ , as introduced in (2), and its symbolic model S_q , as introduced in (4). We first design an observer \mathcal{O} that estimates the states of S_τ, X_τ with some upper bound $\epsilon \in \mathbb{R}^+$ for the error between actual states and observed ones. A state-based symbolic model \hat{S}_{q, \hat{X}_q} is then related to the observed system and used for symbolic controller synthesis. We show that \hat{S}_{q, \hat{X}_q} can be directly constructed from S_q by inflating each of its states (a state of S_q is a set in X_τ) by ϵ . The synthesized symbolic controller C_q is finally refined with an interface that uses the observer.

A. Observer Design

Let S_τ be an output-based system and S_q be its symbolic model, as introduced in (2) and (4), respectively, such that $S_\tau \preceq_Z S_q$, where Z is an OFRR. Let Q be the underlying FRR of Z .

Given a specification ψ_τ , let (S_τ, ψ_τ) be a concrete control problem. We first introduce observers and show how they are composed with S_τ .

Definition VII.1 (Observers). *Given a precision $\epsilon > 0$, an observer for concrete system S_τ is a system:*

$$\mathcal{O} := (\hat{X}, \hat{X}, \hat{U}, \xrightarrow{\mathcal{O}}, \hat{X}, id_{\hat{X}}),$$

where $\hat{X} := X_\tau$, $\hat{U} := U_\tau \times Y_\tau$, and $\xrightarrow{\mathcal{O}}$ is defined such that the following holds for all $x_0 \in X_\tau$ and all $\hat{x}_0 \in \hat{X}$:

$$\begin{aligned} \forall r_{int} \in \text{RUNS}_{int}(S_\tau^{\{\{x_0\}\}}) \quad \forall \hat{r}_{int} \in \text{RUNS}_{int}(\mathcal{O}^{\{\{\hat{x}_0\}\}}) \quad (10) \\ (\pi_{U_\tau}(r_{int}) = \pi_{U_\tau}(\hat{r}_{int}) \implies \\ \forall n \geq 1 (\|\text{Last}(\hat{r}_{int}(n)) - \text{Last}(r_{int}(n))\| \leq \epsilon)). \end{aligned}$$

Note that, for any linear time-invariant control systems, it is always possible to construct \mathcal{O} by embedding a Luenberger observer with a suitable gain inside it [28]. Additionally, for some classes of nonlinear systems, one can utilize high-gain observers [29]. We define the *observed system* \hat{S}_τ as the system resulting from composing the observer \mathcal{O} to the sampled-data system S_τ as follows:

$$\hat{S}_\tau := \mathcal{O} \triangleleft S_\tau,$$

where \triangleleft denotes the observation composition introduced in Definition III.5 and the output set of \hat{S}_τ is consequently equals to $\hat{X} = X_\tau$. Here, \hat{S}_τ coincides with its state-based system \hat{S}_{τ, X_τ} version and we use them interchangeably.

In Definition VII.1, the distance between the runs of S_τ and those of \hat{S}_τ is always upper bounded by ϵ after the first sampling period. We synthesize symbolic controllers to solve (S_τ, ψ_τ) only after the first sampling period. In Subsection VII-D, we show how to handle the first sampling period.

B. A symbolic model for \hat{S}_τ

We approximate \mathcal{O} with a static perturbation map, denoted by $\tilde{\mathcal{O}} : X_\tau \rightrightarrows X_\tau$ (\rightrightarrows denotes set-valued mapping), such that its perturbation is upper bounded by ϵ . Formally, we define map $\tilde{\mathcal{O}}$ as follows for any $x \in X_\tau$:

$$\tilde{\mathcal{O}}(x) := \{\tilde{x} \in X_\tau \mid \|x - \tilde{x}\| \leq \epsilon\}.$$

One can simply show that $B(\mathcal{O} \triangleleft S_\tau) \subseteq B(\tilde{\mathcal{O}} \circ S_{\tau, X_\tau})$. Now let us recall the symbolic model S_q of S_τ . Note that the elements of X_q are disjoint subsets of X_τ . A symbolic model for \hat{S}_τ is

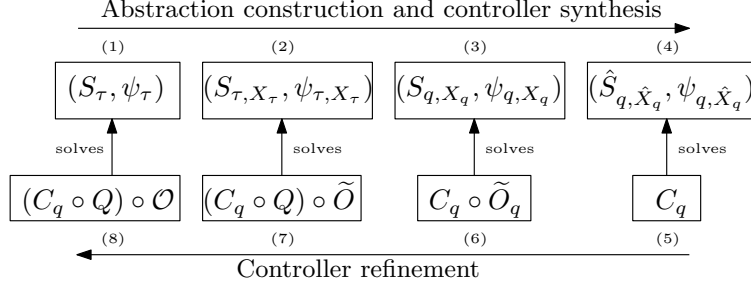

Fig. 4: Construction of different control problems and their controllers for the observer-based methodology.

constructed by inflating each state $x_q \in \hat{X}_q$ of S_q by ϵ . Formally, we denote by \hat{S}_q the symbolic model of the observed system \hat{S}_τ and we define it as follows:

$$\hat{S}_q := (\hat{X}_q, \hat{X}_q, U_q, \xrightarrow{\hat{q}}, \hat{X}_q, id_{\hat{X}_q}), \quad (11)$$

where $\hat{X}_q := \{ \bigcup_{x_\tau \in X_q} \tilde{O}(x_\tau) \mid x_q \in X_q \}$, and $(\hat{x}_q, u_q, \hat{x}'_q) \in \xrightarrow{\hat{q}}$ if there exist $x \in \hat{x}_q$ and $x' \in \hat{x}'_q$ such that $((x, \hat{x}), u_q, (x', \hat{x}')) \in \xrightarrow{\hat{\tau}}$ for some $\hat{x}, \hat{x}' \in \hat{X}$, and $\xrightarrow{\hat{\tau}}$ is the transition relation of \hat{S}_τ . Notice that \hat{S}_q also coincides with its state-based version \hat{S}_{q, \hat{X}_q} and we use them interchangeably.

Remark VII.2. For any $\epsilon > 0$, the elements of \hat{X}_q form a cover of X_τ and its elements have one-to-one correspondence with the partition elements of X_q .

Now we derive a version of the given specification ψ_τ to be used later for controller synthesis. First, a state-based abstract specification ψ_{q, X_q} is derived using maps Z and H_q as follows: $\psi_{q, X_q} := H_q^{-1}(Z(\psi_\tau))$. Here, we abuse the notation and apply Z and H_q^{-1} to elements of state sequences in ψ_τ . Then, we define a map $\tilde{O}_q : X_q \rightarrow \hat{X}_q$ that accepts a partition element $x_q \in X_q$ and translates it to its corresponding cover element $\hat{x}_q \in \hat{X}_q$. Using \tilde{O}_q , any state-based abstract specification ψ_{q, X_q} can be translated to an abstract specification ψ_{q, \hat{X}_q} as follows: $\psi_{q, \hat{X}_q} := \tilde{O}_q(\psi_{q, X_q})$. Finally, we have $(\hat{S}_{q, \hat{X}_q}, \psi_{q, \hat{X}_q})$ as an observed-based abstract control problem and its construction is depicted with steps (1) to (4) in Fig. 4.

Remark VII.3. Although observer \mathcal{O} is designed for S_τ , the choice of ϵ should be based on states set X_q in S_q . Selecting a larger value of ϵ increases the nondeterminism of transitions of \hat{S}_{q, \hat{X}_q} making control problem $(\hat{S}_{q, \hat{X}_q}, \psi_{q, \hat{X}_q})$ unsolvable.

C. Controller Synthesis and Refinement

In the previous subsection, we demonstrated how (S_τ, ψ_τ) is translated to $(\hat{S}_{q, \hat{X}_q}, \psi_{q, \hat{X}_q})$, as depicted in Fig. 4. We know from Corollary V.5 that a controller designed for control problem

in step (2) can be refined to solve control problem in step (1). Here, we rely on two facts: the behavior of S_{τ, X_τ} is the internal behavior of S_τ , and $B(\mathcal{O} \triangleleft S_\tau) \subseteq B(\tilde{\mathcal{O}} \circ S_{\tau, X_\tau})$. The control problem in step (3) is a symbolic representation of the control problem in step (2) using the FRR Q . The results from [4] apply directly and any controller designed to solve the control problem in step (3) can be refined to solve the control problem in step (2) using Q as a static quantization map. The only missing link is how a controller designed to solve the control problem in step (4) is refined to solve the control problem in step (3). Note that in (11), we designed \hat{S}_{q, \hat{X}_q} by inflating the states of S_{q, X_q} using the perturbation map $\tilde{\mathcal{O}}$. Hence, we can use the results in [4, Theorem VI.4] to ensure the behavioral inclusion when refining the controller designed for the control problem in step (4). We introduce a version of [4, Theorem VI.4] adapted to our notation.

Theorem VII.4. *Let $(S_{q, X_q}, \psi_{q, X_q})$ be an abstract control problem. Consider an abstract observer-based control problem $(\hat{S}_{q, \hat{X}_q}, \psi_{q, \hat{X}_q})$ constructed using the map $\tilde{\mathcal{O}}_q$. If a controller C_q solves $(\hat{S}_{q, \hat{X}_q}, \psi_{q, \hat{X}_q})$, then the controller $C_q \circ \tilde{\mathcal{O}}_q$ solves $(S_{q, X_q}, \psi_{q, X_q})$.*

Proof. The proof is very similar to that of [4, Theorem VI.4] and is omitted here due to lack of space. \square

D. The First Sampling Period

The symbolic controller C_q is only valid after the first sampling period. One solution to ensure that the system is ready for C_q for times $t \geq \tau$, is to choose an input $u_p \in U_\tau$ and an initial state set $X_p \in X_\tau$ satisfying

$$\begin{aligned} \forall x_0 \in X_p \quad \forall x_\tau \in \text{Post}_{u_p}^{S_\tau}(x_0) \quad \exists x_q \in \mathcal{D}(C_q) \text{ s.t.} \\ x_\tau \in x_q, \end{aligned} \quad (12)$$

where \mathcal{D} extracts the controller's domain as introduced in Definition III.10. Condition (12) ensures that states at times $t \geq \tau$ remains in $\mathcal{D}(C_q)$. We then need to solve a special control problem $(S_\tau^{(X_p)}, \psi_p)$, where ψ_p is defined as follows:

$$\psi_p := \begin{cases} \text{Safe}_{[0,1]}(H_\tau(X_D)), & \text{if } X_p \subseteq \mathcal{D}(C_q) \\ \text{Reach}_{[0,1]}(H_\tau(X_D)), & \text{if } \mathcal{D}(C_q) \subset X_p \end{cases},$$

and $X_D := \bigcup_{x_q \in \mathcal{D}(C_q)} x_q$. The selection of X_p is critical and depends on the dynamics of Σ . A good strategy is to start with $X_p = X_D$ and expand (or shrink) it until condition (12) is met for some input u_p . We discuss this again with an example in Section IX.

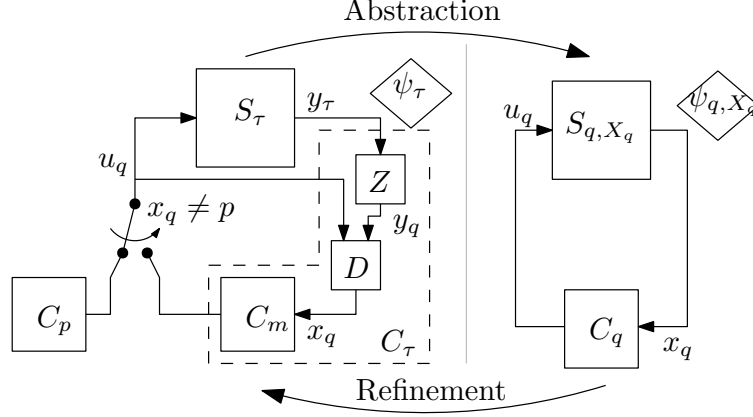

Fig. 5: Output-feedback symbolic control using detectors.

VIII. METHODOLOGY 3: CONSTRUCTING DETECTORS FOR SYMBOLIC MODELS

We revise the notion of detectability of non-deterministic finite transition systems (NFTS) [30], and use it to design detectors for S_q . First, we introduce non-deterministic finite automata (NFA). Here, a system is intuitively called detectable if one can use sufficiently long input sequences and their corresponding output sequences to determine the current and all subsequent states of the system. We first show how to construct detectors to identify, in finite-time, the current and all subsequent states of detectable symbolic models. We then synthesize symbolic controllers and refine them to enforce the given specifications on original systems. The method is depicted schematically in Fig. 5 and we summarize it as follows: 1) construct an abstract control problem (S_q, ψ_q) from the concrete control problem (S_τ, ψ_τ) , where $S_q \preceq_Z S_\tau$; 2) verify the detectability of S_q ; 3) if S_q is detectable, then design a detector D to detect its state at the current time step; 4) use the state-based system S_{q, X_q} to synthesize a symbolic controller C_q that is wrapped with some routing signals in a symbolic controller C_m ; 5) refine symbolic controller C_m using Z and D as interfaces to controller C_τ ; and finally 6) since D requires a priori known finite time to start detecting the states of S_q , an open-loop controller C_p is designed to keep the system in the domain of C_q , and a signal p is required to switch between C_p and C_τ .

Definition VIII.1. An NFA \mathcal{A} is a tuple $\mathcal{A} := (\mathcal{Q}, \Delta, \delta, q_0, F)$, where \mathcal{Q} is a finite set of states, Δ is a finite set of labels (which is an alphabet), $\delta \subset \mathcal{Q} \times \Delta \times \mathcal{Q}$ is the transition relation, $q_0 \in \mathcal{Q}$ is the initial state, and $F \subset \mathcal{Q}$ is a set of final states.

The transition relation δ of NFA \mathcal{A} is extended to $\delta^* \subset \mathcal{Q} \times \Delta^* \times \mathcal{Q}$ in the usual way: for all $q, q' \in \mathcal{Q}$, $(q, e, q') \in \delta^*$ iff $q = q'$; and for all $q, q' \in \mathcal{Q}$ and $\sigma_0 \dots \sigma_{n-1} \in \Delta^* \setminus \{e\}$, $(q, \sigma_0 \dots \sigma_{n-1}, q') \in \delta^*$ iff there exists $q_1, \dots, q_{n-1} \in \mathcal{Q}$ such that $(q, \sigma_0, q_1), (q_1, \sigma_1, q_2), \dots,$

$(q_{n-1}, \sigma_{n-1}, q') \in \delta$. Hereinafter, we use δ to denote δ^* , as no confusion shall occur. A state $q \in \mathcal{Q}$ is said to be reachable from a state $q' \in \mathcal{Q}$, if there exists $\sigma \in \Delta^*$ such that $(q', \sigma, q) \in \delta$. A state $x \in \mathcal{Q}$ is called reachable from a subset \mathcal{Q}' of \mathcal{Q} , if x is reachable from some states of \mathcal{Q}' . A sequence $q_0, \dots, q_n \in \mathcal{Q}$ is called a path, if there exist $\sigma_0, \dots, \sigma_{n-1} \in \Delta$ such that $(q_0, \sigma_0, q_1), \dots, (q_{n-1}, \sigma_{n-1}, q_n) \in \delta$. A path $q_0, \dots, q_n \in \mathcal{Q}$ is called a cycle, if $q_0 = q_n$.

We borrow the concept of limit points from the theory of cellular automata [31] and use it for NFAs. Limit points are defined as the points that can be visited at each time step. If one regards an NFA \mathcal{A} as a system in which each state is initial, and regard each state of \mathcal{A} as a point, then limit points are exactly the states reachable from some cycles. The limit set of \mathcal{A} consists of limit points and we denote it by $LP(\mathcal{A})$.

A. Detectability of Symbolic Models

Consider a concrete control problem (S_τ, ψ_τ) and its abstract control problem (S_q, ψ_q) such that $S_q \preceq_Z S_\tau$, for some OFRR Z , and ψ_q is constructed as introduced in (6). We first introduce the concept of detectability for symbolic models.

Definition VIII.2 (Detectability of Symbolic Models). *A symbolic model S_q , as defined in (4), is said to be detectable if there exists $N \in \mathbb{R}^+$ such that for all input sequences $\alpha \in U^*$, $|\alpha| \geq N$, and all output sequences $\beta \in Y^*$, $|\beta| = |\alpha| + 1$, we have that $|\text{Post}_\alpha^\beta(X_q)| \leq 1$.*

Verifying the detectability of S_q is essential in the current methodology. We introduce Algorithm VIII.3 that takes S_q as input, and returns NFA \mathcal{A} which is used to check the detectability of S_q .

Algorithm VIII.3. *Receive a symbolic model $S_q := (X_q, X_q, U_q, \xrightarrow{q}, Y_q, H)$, and initiate an NFA $\mathcal{A} := (\mathcal{Q}, \Delta, \delta, q_0, F)$, where $\mathcal{Q} := \{\diamond\}$, \diamond is a dummy symbol, $\Delta := \delta := F := \emptyset$, and $q_0 := \diamond$. $\mathcal{Q}_1 := \emptyset$, $\mathcal{Q}_2 := \emptyset$. Let ϕ be a dummy symbol not in Y_q .*

- 1) For each $y \in Y_q$, denote $X_y := \{x \in X_q | H_q(x) = y\}$,
 - a) if $|X_y| = 1$, then $\mathcal{Q}_1 := \mathcal{Q}_1 \cup \{X_y\}$, $\Delta := \Delta \cup \{(\phi, y)\}$, $\delta := \delta \cup \{(\diamond, (\phi, y), X_y)\}$,
 - b) else if $|X_y| > 1$, then $\mathcal{Q}_1 := \mathcal{Q}_1 \cup \{Z \subset X_y | |Z| = 2\}$, $\Delta := \Delta \cup \{(\phi, y)\}$, for each $Z \subset X_y$ satisfying that $|Z| = 2$, $\delta := \delta \cup \{(\diamond, (\phi, y), Z)\}$. $\mathcal{Q} := \mathcal{Q} \cup \mathcal{Q}_1$, $\mathcal{Q}_2 := \mathcal{Q}_2 \cup \mathcal{Q}_1$, $\mathcal{Q}_1 := \emptyset$.
- 2) If $\mathcal{Q}_2 = \emptyset$, stop. Else, for each $q_2 \in \mathcal{Q}_2$, denote $y_0 := H_q(x)$, where $x \in q_2$, for each $u \in U_q$ and each $y \in Y_q$,
 - a) if $|\text{post}_u^{y_0 y}(q_2)| = 1$, then $\Delta := \Delta \cup \{(u, y)\}$, $\delta := \delta \cup \{(q_2, (u, y), \text{post}_u^{y_0 y}(q_2))\}$, if $\text{post}_u^{y_0 y}(q_2) \notin \mathcal{Q}$ then $\mathcal{Q}_1 := \mathcal{Q}_1 \cup \{\text{post}_u^{y_0 y}(q_2)\}$,
 - b) else if $|\text{post}_u^{y_0 y}(q_2)| > 1$, then $\Delta := \Delta \cup \{(u, y)\}$, for each $Z \subset \text{post}_u^{y_0 y}(q_2)$ satisfying $|Z| = 2$, $\delta := \delta \cup \{(q_2, (u, y), Z)\}$, if $Z \notin \mathcal{Q}$ then $\mathcal{Q}_1 := \mathcal{Q}_1 \cup \{Z\}$. $\mathcal{Q} := \mathcal{Q} \cup \mathcal{Q}_1$, $\mathcal{Q}_2 := \emptyset$, $\mathcal{Q}_2 := \mathcal{Q}_1$, $\mathcal{Q}_1 := \emptyset$.
- 3) Go to Step (2). (Since X_q, U_q , and Y_q are finite, the algorithm will terminate.)

Let \mathcal{A} be the NFA resulting from Algorithm VIII.3 after setting S_q as input. The smallest natural number T_t such that each pair of input sequence of length T_t and output sequence of length $T_t + 1$ changes the initial state of the \mathcal{A} to a state of its limit set is called the *transient period*. More precisely, we denote by T_t the transient period of S_q and define it as follows:

$$T_t := \min \{t \in \mathbb{N} \mid \forall u_1, \dots, u_t \in U_q \forall y_0, \dots, y_t \in Y_q \\ (\delta(\diamond, (\phi, y_0)(u_1, y_1) \dots (u_t, y_t)) \neq \emptyset \implies \\ \delta(\diamond, (\phi, y_0)(u_1, y_1) \dots (u_t, y_t)) \subseteq LP(\mathcal{A}))\}.$$

The next theorem provides a tool to check the detectability of S_q and provides a time index T_t after which one can identify the states of the system.

Theorem VIII.4. *Let S_q be a symbolic model as introduced in (4). Let \mathcal{A} be the NFA resulting from running Algorithm VIII.3 with S_q as input and T_t be its transient period. Then,*

- (i) S_q is detectable iff in \mathcal{A} , each state reachable from some cycle is a singleton, and
- (ii) if S_q is detectable, then for all input sequences $\alpha \in U_q^*$, $|\alpha| \geq T_t$, and all output sequences $\beta \in Y_q^*$, $|\beta| = |\alpha| + 1$, we have that $|\text{Post}_\alpha^\beta(X_q)| \leq 1$.

Proof. The proof of (i) is given in [30, Theorem 8.1].

The proof of (ii) is given in [30, Proposition 8.1]. □

B. Controller Synthesis and Refinement

Consider a detectable symbolic model S_q . We show how to design a detector for it. Let $\mathcal{A} := (\mathcal{Q}, \Delta, \delta, \{\diamond\}, F)$ be the NFA resulting from Algorithm VIII.3 with S_q as input. We introduce the detector system as follows:

$$D := (X_D, X_{D,0}, U_q \times Y_q, \xrightarrow{D}, Y_D, H_D), \quad (13)$$

where

- $X_D := X_q \times \mathcal{Q} \times \{0, 1\}$;
- $X_{D,0} := \{(x_q, \diamond, 0) \mid x_q \in X_q\}$;
- $\xrightarrow{D} := \{((x_q, q, 0), (u_q, y_q), (x'_q, q', 1)) \mid (x_q, u_q, x'_q) \in \xrightarrow{q} \wedge (q, (u_q, y_q), q') \in \delta \wedge |q'| \leq 1\} \cup \{((x_q, q, f), (u_q, y_q), (x'_q, q', f)) \mid (x_q, u_q, x'_q) \in \xrightarrow{q} \wedge (q, (u_q, y_q), q') \in \delta \wedge (|q'| > 1 \vee f = 1)\}$;
- $Y_D := X_q \cup \{p\}$, where p is a dummy symbol denoting incomplete detection of the state of S_q ; and

- H_D is defined as follows:

$$H_D((x_q, q, f)) := \begin{cases} x_q & f = 1 \\ p & f = 0 \end{cases}.$$

Remark VIII.5. After T_t sampling periods of providing inputs and observations of S_q to D , we have that:

- (1) $H_D(x_D) \neq p$, for any $x_D \in X_D$,
- (2) $H_D(x_D)$ provides the detected current state of S_q , and
- (3) $B_{ext}(D \triangleleft (Z \circ S_\tau)) = B_{int}(S_q)$.

A controller C_q , as defined in Definition III.9, can be synthesized to solve (S_q, ψ_q) , as discussed in V-D. Then, using Theorems V.4 and Remark VIII.5(3), C_q is refined using the detector system D and the static map Z as interface, as shown in Fig. 5. We only need to encapsulate C_q , in the following system C_m , to handle the detection signal p :

$$C_m := (X_{C_m}, X_{C_m,0}, U_{C_m}, \xrightarrow{C_m}, Y_{C_q} \cup \{\kappa\}, H_{C_m}), \quad (14)$$

where

- κ is a dummy symbol for unavailability of control inputs;
- $X_{C_m} := X_{C_q} \cup \{0, 1\}$;
- $X_{C_m,0} := \{(x_{C_q}, 0) \mid x_{C_q} \in X_{C_q,0}\}$;
- $U_{C_m} := U_{C_q} \cup \{p\}$, where p is the symbol from (13);
- $\xrightarrow{C_m} := \{((x_{C_q}, 0), u_{C_m}, ((x'_{C_q}, 1)) \mid (x'_{C_q}, u_{C_m}, x'_{C_q}) \in \xrightarrow{C_q} \wedge u_{C_m} \neq p\} \cup \{((x_{C_q}, 1), u_{C_m}, ((x'_{C_q}, 1)) \mid (x'_{C_q}, u_{C_m}, x'_{C_q}) \in \xrightarrow{C_q} \wedge u_{C_m} \neq p\} \cup \{((x_{C_q}, 0), u_{C_m}, ((x_{C_q}, 0)) \mid u_{C_m} = p\}$;

and

$$\bullet H_{C_m}((x_{C_q}, f)) := \begin{cases} H_{C_q}(x_{C_q}) & f = 1 \\ \kappa & f = 0 \end{cases}.$$

To handle the time period $[0, T_t]$, we need to find a static open-loop controller C_p that solves $(S_\tau^{(X_p)}, \psi_p)$, where

$$\psi_p := \begin{cases} \text{Safe}_{[0, T_t]}(H_\tau(X_D)), & \text{if } X_p \subseteq \mathcal{D}(C_q) \\ \text{Reach}_{[0, T_t]}(H_\tau(X_D)), & \text{if } \mathcal{D}(C_q) \subset X_p \end{cases},$$

and $X_D := \bigcup_{x_q \in \mathcal{D}(C_q)} x_q$. C_p encapsulates at least one control input sequence $\tilde{u}_p \in U_q^{T_t}$ that results in an output sequence $\tilde{y}_p \in Y_\tau^{T_t}$ such that $\tilde{y}_p \in \psi_p$. One direct approach to find \tilde{u}_p is via an exhaustive search in $U_q^{T_t}$.

IX. CASE STUDIES

We provide different examples to demonstrate the practicality and applicability of the presented methodologies. Implementations of all examples are done using available open-source toolboxes and some customized C++ programs developed for each methodology. All closed-loop simulations of refined controllers are done in MATLAB. We use a PC (Intel Xeon E5-1620 3.5 GHz and 32 GB RAM) for all the examples.

In all of the examples, given a concrete system S_τ , we construct a symbolic model S_q . We use tool SCOTS [17] to construct S_{q,X_q} . SCOTS can only construct S_{q,X_q} with an FRR Q in the form:

$$Q := \{(x_\tau, x_q) \mid x_\tau \in X_\tau \cap x_q \wedge x_q \in X_q\},$$

where X_q is a partition on X_τ constructed by a uniform quantization parameter $\eta \in \mathbb{R}^n$. Declaring η is sufficient to define X_q and Q . X_q is a set of polytopes of identical shapes forming a partition on X_τ . This is a limited structure in constructing S_q that we must comply with. Another restriction imposed by SCOTS is the need to use easily invertible output maps h such that $H_q^{-1}(y_q)$, $y_q \in Y_q$, complies with the hyper-rectangular structure of X_q needed by SCOTS.

A. Output-Feedback Symbolic Control using Games of Imperfect Information

We consider one example to illustrate the methodology presented in Section VI. In this example, after constructing S_q , tool ALPAGA [27] is used to construct the knowledge-based game S_q^K and synthesize a winning strategy \bar{C}^K . We refine the strategy as previously depicted in Fig. 2.

Consider the following dynamics of a DC motor:

$$\begin{bmatrix} \dot{x}_1 \\ \dot{x}_2 \\ \dot{x}_3 \end{bmatrix} = \begin{bmatrix} \frac{-R}{L} & 0 & \frac{-K}{L} \\ 0 & 0 & 1 \\ \frac{K}{J} & 0 & \frac{-b}{J} \end{bmatrix} \begin{bmatrix} x_1 \\ x_2 \\ x_3 \end{bmatrix} + \begin{bmatrix} \frac{1}{L} \\ 0 \\ 0 \end{bmatrix} v,$$

where x_1 is the armature current, x_2 is the rotation angle of the rotor, x_3 is the angular velocity of the rotor, v is the input voltage, $L := 5 \times 10^{-2}$ is the electric inductance of the motor coil, $R := 5$ is the resistance of the motor coil, $J := 5 \times 10^{-4}$ is the moment of inertia of the rotor, $b := 1 \times 10^{-2}$ is the viscous friction constant, and $K := 0.1$ is both the torque and the back EMF constants. We consider a state set $X_\tau := [-0.6, 0.6] \times [-0.3, 0.3] \times [-4.8, 4.8]$ and an input set

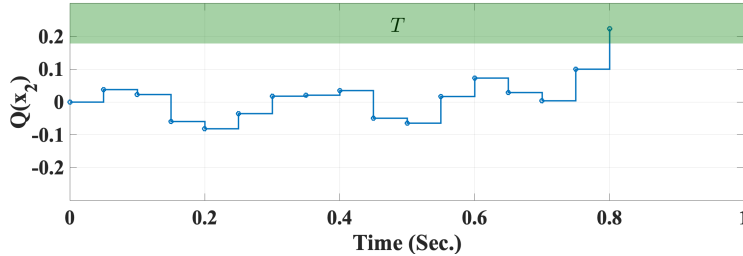

Fig. 6: The output of the DC motor example.

$U_\tau := [-4.25, 4.25]$. One sensor is attached to the motor's rotor and it can measure x_2 . Hence, the output is as follows:

$$y := \begin{bmatrix} 0 & 1 & 0 \end{bmatrix} \begin{bmatrix} x_1 \\ x_2 \\ x_3 \end{bmatrix},$$

and, consequently, $Y_\tau := [-0.3, 0.3]$. We consider a reachability specification with a target set $T := [0.18, 0.3]$.

To construct S_q , we consider an abstract output spaces $Y_q := \{y_0, y_2, y_3, \dots, y_{30}\}$ that forces a partition on Y_τ . Here, each $y_q \in Y_q$ represents one subset in Y_τ from 31 subsets by dividing Y_τ equally using a quantization parameter 0.02. More precisely, we use an OFRR:

$$Z := \{(y_\tau, y_q) \in Y_\tau \times Y_q \mid y_q = y_{\lfloor (y_\tau + 0.3) / 0.02 \rfloor}\}.$$

With such a Y_q , the abstract specification is to synthesize a controller to reach any of the symbolic outputs $y_{24}, y_{25}, \dots, y_{30}$. To construct S_{q, X_q} , we use the following parameters in SCOTS: a state quantization vector $(0.3, 0.02, 1.6)$, an input quantization parameter 0.75, and a sampling time $\tau := 0.05$ seconds. SCOTS constructs S_{q, X_q} in 2 seconds with X_q having 1085 elements (each representing a hyper-rectangle in X_τ) and S_{q, X_q} having 88501 transitions. We then define H_q as follows:

$$H_q((x_{q,1}, x_{q,2}, x_{q,3})) := y_{\lfloor (x_{q,2} + 0.3) / 0.02 \rfloor},$$

which satisfies condition (1). We pass S_q to ALPAGA which takes around 24 hours to construct $S_q^{\mathcal{K}}$ and synthesize $\bar{C}^{\mathcal{K}}$, which is then refined as discussed in Fig. 2.

The closed-loop behavior is simulated in MATLAB and the output is depicted in Fig. 6. The target region is highlighted with a green rectangle. The actual initial state of the system is set to $(0, 0, 0)$, which is of course unknown to the controller.

B. Output-Feedback Symbolic Control using Observers

As an example for the methodology presented in Section VII, consider the double-integrator model:

$$\begin{bmatrix} \dot{x}_1 \\ \dot{x}_2 \end{bmatrix} = \begin{bmatrix} 0 & 1 \\ 0 & 0 \end{bmatrix} \begin{bmatrix} x_1 \\ x_2 \end{bmatrix} + \begin{bmatrix} 0 \\ 1 \end{bmatrix} v, \quad (15)$$

where $(x_1, x_2) \in [-1, 1] \times [-5, 5]$, and $v \in [-10, 10]$. The output of the system is seen through a single sensor monitoring x_1 , i.e., $y = x_1$. We consider the following LTL specification:

$$\psi_\tau = \square\Diamond(\mathbf{Target1}) \wedge \square\Diamond(\mathbf{Target2}),$$

where $\Diamond(T)$ denotes the reachability requirement that the output of S_q visits, at least once, some elements in T , $\mathbf{Target1} := [0.65, 1.0]$ and $\mathbf{Target2} := [-1, -0.65]$ are two subsets of $Y_\tau := [-1, 1]$.

We first design an observer for the system. We choose a precision value of $\epsilon := 0.001$ and design a Luenberger observer using pole placement. It is then embedded in an observer system \mathcal{O} that fulfills condition (10). System \mathcal{O} is needed in order to refine the designed controller as depicted in Fig. 3.

To construct S_q , we set $Y_q := \{y_0, y_1, \dots, y_{50}\}$ forcing a partition on Y_τ such that each $y_q \in Y_q$ represents one subset of Y_τ from 51 subsets by dividing Y_τ equally using a quantization parameter 0.04. More precisely, use an OFRR:

$$Z := \{(y_\tau, y_q) \in Y_\tau \times Y_q \mid y_q = y_{\lfloor (y_\tau + 1)/0.04 \rfloor}\}.$$

Then, we use SCOTS to construct S_{q, X_q} with a sampling time $\tau := 0.05$ seconds, a state quantization vector $(0.04, 0.01)$, and an input quantization parameter 1.0. Error ϵ is used as a state error parameter in SCOTS to emulate the inflation discussed in Subsection VII-C. SCOTS constructs S_{q, X_q} in 39 seconds and it has 5.59325×10^7 transitions. We then have an output map defined as follows: $H_q((x_{q,1}, x_{q,2})) := y_{\lfloor (x_{q,1} + 1)/0.04 \rfloor}$, which satisfies condition (1). With the above setup, we can use the results of the observer-based methodology and refine any synthesized controller for S_{q, X_q} using \mathcal{O} and Q .

We continue with controller synthesis and refinement. Since SCOTS requires specifications over symbolic states, the corresponding symbolic target state sets are computed by $Q(H_\tau^{-1}(\mathbf{Target1}))$ and $Q(H_\tau^{-1}(\mathbf{Target2}))$, respectively. The controller is synthesized in 24 seconds. The set of possible control-actions for the first sampling period are identified as discussed in Subsection

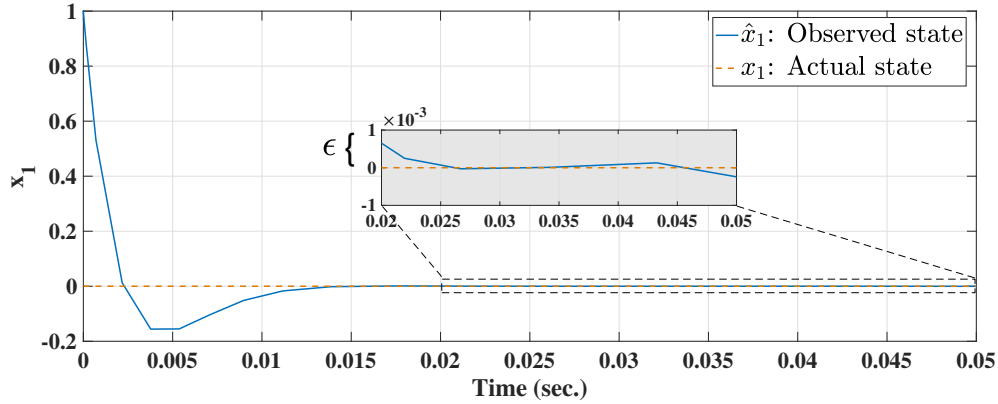

Fig. 7: State variable x_1 and its observed version \hat{x}_1 of the double-integrator example during the first sampling period.

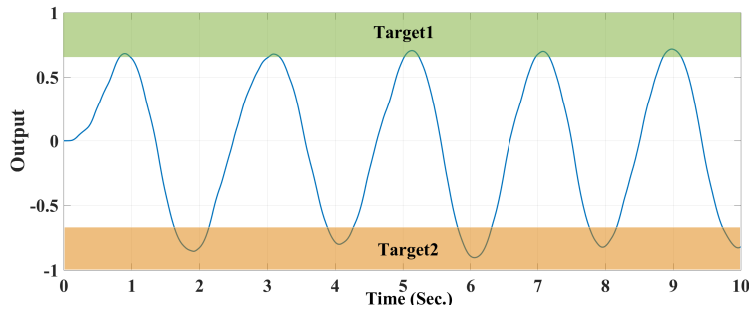

Fig. 8: Output of the double-integrator example.

VII-D. The input $v := 0$ is selected for the first sampling period.

We simulate the closed-loop in MATLAB with $(0, 0)$ and $(1, 1)$ as initial states of the system and observer, respectively. At the first sampling period, the controller applies input $v := 0$ to keep the system in the controller's domain. From the second sampling period, we switch to the symbolic controller. Figure 8 depicts the output y and Fig. 9 depicts the applied inputs.

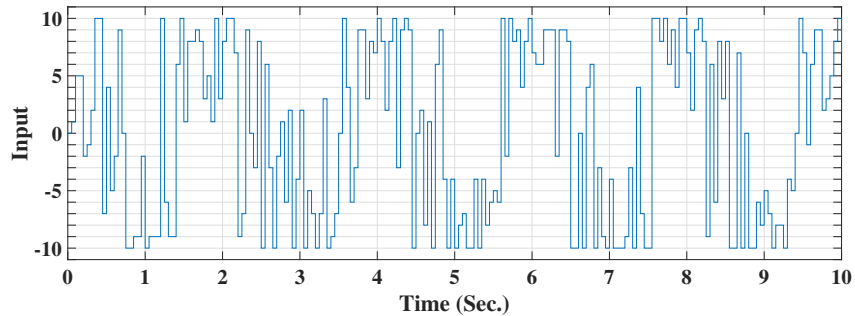

Fig. 9: Control inputs applied to the double-integrator system during the closed-loop simulation.

C. Output-Feedback Symbolic Control using Detectors

Now, we provide an example to illustrate the methodology presented in Section VIII. Consider a pendulum system [11]:

$$\begin{bmatrix} \dot{x}_1 \\ \dot{x}_2 \end{bmatrix} = \begin{bmatrix} 0 & x_2 \\ -\frac{g}{l} \sin(x_1) & -\frac{k}{m} x_2 \end{bmatrix} + \begin{bmatrix} 0 \\ 1 \end{bmatrix} u, \quad y = \begin{bmatrix} 1 & 0 \end{bmatrix} \begin{bmatrix} x_1 \\ x_2 \end{bmatrix},$$

where $x_1 \in [-1, 1]$ is the angular position, $x_2 \in [-1, 1]$ is the angular velocity, $u \in [-1.5, 1.5]$ is the input torque, $g := 9.8$ is the gravitational acceleration constant, $l := 5$ is the length of the pendulum's massless rod, $m := 0.5$ is a mass attached to the rod, $k := 3$ is the friction's coefficient, and $y \in [-1, 1]$ is the measured angular position. We consider designing a symbolic controller to enforce the angle of the rod to infinitely alternate between two regions $\theta_1 := [0.3, 0.4]$ and $\theta_2 := [-0.4, -0.3]$. When it reaches one region, the pendulum should hold for 10 consequent time steps.

To construct S_q , we set $Y_q := \{y_0, y_1, \dots, y_{50}\}$ forcing a partition on Y_τ such that each $y_q \in Y_q$ represents one subset in Y_τ from 51 subsets by dividing Y_τ equally using a quantization parameter 0.04. More precisely, we use an OFRR:

$$Z := \{(y_\tau, y_q) \in Y_\tau \times Y_q \mid y_q = y_{\lfloor (y_\tau + 1)/0.04 \rfloor}\}.$$

S_{q, X_q} is constructed using the following parameters: state quantization vector $(0.4, 0.4)$, input quantization parameter 0.15, and a sampling time 2 seconds. The resulting S_{q, X_q} has 25 states and 525 transitions. We then have an output map defined as follows: $H_q((x_{q,1}, x_{q,2})) := y_{\lfloor (x_{q,1} + 1)/0.04 \rfloor}$, which satisfies condition (1). We then use the results from Section VIII and refine any synthesized controller for S_q .

We implemented Algorithm VIII.3 in C++ and ran it with S_q as input. NFA \mathcal{A} has 60 states and 1485 transitions. System S_q is detectable with $T_t = 1$. A controller is synthesized using SCOTS and map H_τ^{-1} is used to construct a state-based specification. The controller is refined using Z and the detector. A closed-loop simulation is depicted in Fig. 10.

X. RELATED WORKS

The work in [32] provides a symbolic control approach based on outputs. It is limited to partially observable linear time-invariant systems, as long as the system is detectable and stabilizable. Some extensions are made in [33] for probabilistic safety specifications and in [34]

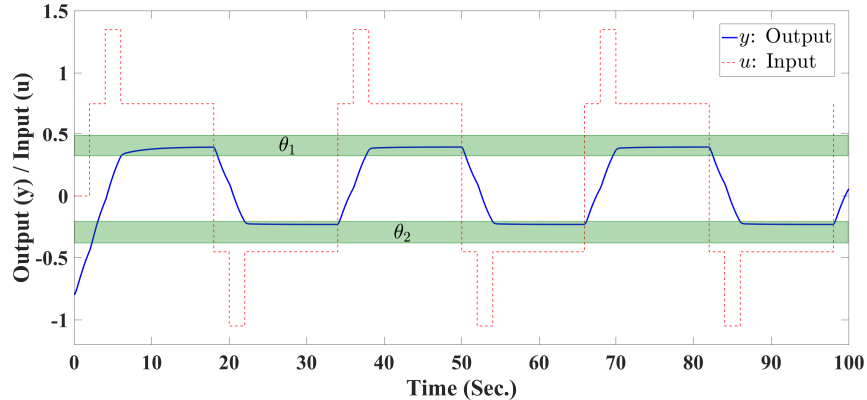

Fig. 10: Closed-loop simulation of Pendulum example.

for nonlinear systems. The latter is limited to a class of feedback-linearizable systems and the results are limited to safety.

The work in [35] proposes designing symbolic output-feedback controllers for control systems. It designs observers induced by abstract systems and obtain output-feedback controllers similar to the methodology we presented in Section VIII. The authors, unlike our approach, require the availability of a controller for the abstract system when the state of the control system is fully measured. Then, they reduce the controller to work with the original system with the designed observer.

In [36, 37], the authors use *state-based* strong alternating approximate simulation relations to relate concrete systems with their abstractions. They make sure that a partition constructed on the output space imposes a partition on the state space, which allows designing output-based controllers using *state-based* symbolic models. The work in [37] is different from ours in three main directions: (1) our work introduces OFRRs as general relations between the outputs of symbolic models and original systems, (2) we utilize FRRs which avoid the drawbacks of approximate alternating simulation relations (see [4, Section IV] for a comparison between both types of relations), and (3) we introduce multiple practical methodologies that realize the framework we introduced; in Sections VI, VII, and VIII. In [38], the authors design observers for original systems. Then, the observed *state-based* systems are related, via FRRs, to *state-based* symbolic models that are used for controller synthesis. Unlike our work, the behavioral inclusion from original closed-loop to abstract closed-loop is shown in state-based setting. Also, the specifications are given over the states set. In [39], the authors provide an extension to FRR to ensure that controllers designed for *state-based symbolic models* can be refined to work

TABLE I: Requirements of the presented methodologies.

Methodology	Assumptions	Refined controllers
2-player games	None.	Z + symbolic model
Observer based	S_τ is observable	Z + observer
Detector based	S_q is detectable	Z + detector

for output-based concrete systems. Abstractions are designed using a modified version of the knowledge-based algorithm (a.k.a. KAM). Unfortunately, the authors can not decide whether a correct abstraction is constructed or not unless a controller is synthesized which requires to iteratively run the algorithm. KAM needs to be stopped once an upper bound for the number of iterations is reached. Although Algorithm VIII.3 is more restrictive in the sense that KAM can produce an abstraction for a symbolic model that is not detectable, it is more predictable since it always terminates. Additionally, Algorithm VIII.3 runs in polynomial time, while the KAM algorithm runs in exponential time. Hence, although KAM algorithm can work for undetectable systems, Algorithm VIII.3 is significantly more efficient for detectable systems. Having both algorithms available to the designer of symbolic controllers offers a trade-off between decidability and applicability.

The main contributions of this work are:

1. OFRRs are introduced as extensions to FRRs allowing abstractions to be constructed by quantizing the state and output sets of concrete systems, such that the output quantization respects the state quantization in the sense that every quantized state belongs to one quantized output. Symbolic controllers of output-based symbolic models can be refined to work for output-based concrete systems.
2. OFRRs and the results following them in Section V serve as a general framework to host different methodologies of output-feedback symbolic control.
3. We introduced three example methodologies (Sections VI, VII, and VIII) to synthesize and refine output-based symbolic controllers for output-based systems.

XI. CONCLUSION

We have shown that symbolic control can be extended to work with output-based systems. OFRR are introduced as tools to relate systems based on their outputs. They allow symbolic models to be constructed by quantizing the state and output sets of concrete systems, such that the output quantization respects the state quantization. Consequently, this allows refining symbolic controllers designed based on the outputs of symbolic models to work with the outputs

of original systems. Three example methodologies for output-feedback symbolic control based on detectors for symbolic models were also introduced. Their assumptions and requirements are highlighted in Table I.

REFERENCES

- [1] P. Tabuada, *Verification and control of hybrid systems, A symbolic approach*. USA: Springer, 2009.
- [2] M. Zamani, G. Pola, M. Mazo Jr., and P. Tabuada, “Symbolic models for nonlinear control systems without stability assumptions,” *IEEE Transactions on Automatic Control*, vol. 57, no. 7, pp. 1804–1809, July 2012.
- [3] R. Majumdar and M. Zamani, “Approximately bisimilar symbolic models for digital control systems,” in *Computer Aided Verification*, P. Madhusudan and S. A. Seshia, Eds. Berlin, Heidelberg: Springer Berlin Heidelberg, 2012, pp. 362–377.
- [4] G. Reissig, A. Weber, and M. Rungger, “Feedback refinement relations for the synthesis of symbolic controllers,” *IEEE Transactions on Automatic Control*, vol. 62, no. 4, pp. 1781–1796, April 2017.
- [5] C. Baier and J. P. Katoen, *Principles of model checking*. The MIT Press, April 2008.
- [6] A. Pnueli and R. Rosner, “On the synthesis of an asynchronous reactive module,” in *Proceedings of the 16th International Colloquium on Automata, Languages and Programming*, ser. ICALP ’89. London, UK: Springer-Verlag, 1989, pp. 652–671.
- [7] M. Y. Vardi, *An automata-theoretic approach to fair realizability and synthesis*. Berlin, Heidelberg: Springer Berlin Heidelberg, 1995, pp. 267–278.
- [8] R. Bloem, B. Jobstmann, N. Piterman, A. Pnueli, and Y. Sa’ar, “Synthesis of reactive(1) designs,” *Journal of Computer and System Sciences*, vol. 78, no. 3, pp. 911 – 938, 2012, in Commemoration of Amir Pnueli.
- [9] M. Khaled, M. Rungger, and M. Zamani, “Symbolic models of networked control systems: A feedback refinement relation approach,” in *54th Annual Allerton Conference on Communication, Control, and Computing (Allerton)*, Sept 2016, pp. 187–193.
- [10] M. Zamani, M. M. Jr, M. Khaled, and A. Abate, “Symbolic abstractions of networked control systems,” *IEEE Transactions on Control of Network Systems*, accepted, to appear. [Online]. Available: <https://arxiv.org/abs/1401.6396>
- [11] G. Pola, A. Girard, and P. Tabuada, “Approximately bisimilar symbolic models for nonlinear control systems,” *Automatica*, vol. 44, no. 10, pp. 2508 – 2516, 2008.
- [12] G. Pola, P. Pepe, M. D. D. Benedetto], and P. Tabuada, “Symbolic models for nonlinear time-delay systems using approximate bisimulations,” *Systems & Control Letters*, vol. 59, no. 6, pp. 365 – 373, 2010.
- [13] M. Zamani, A. Abate, and A. Girard, “Symbolic models for stochastic switched systems: A discretization and a discretization-free approach,” *Automatica*, vol. 55, pp. 183 – 196, 2015.
- [14] A. Girard, G. Pola, and P. Tabuada, “Approximately bisimilar symbolic models for incrementally stable switched systems,” *IEEE Transactions on Automatic Control*, vol. 55, no. 1, pp. 116–126, 2010.
- [15] M. Zamani, P. Mohajerin Esfahani, R. Majumdar, A. Abate, and J. Lygeros, “Symbolic control of stochastic systems via approximately bisimilar finite abstractions,” *IEEE Transactions on Automatic Control*, vol. 59, no. 12, pp. 3135–3150, 2014.
- [16] M. Zamani, P. Mohajerin Esfahani, A. Abate, and J. Lygeros, “Symbolic models for stochastic control systems without stability assumptions,” in *2013 European Control Conference (ECC)*, 2013, pp. 4257–4262.
- [17] M. Rungger and M. Zamani, “Scots: A tool for the synthesis of symbolic controllers,” in *Proceedings of the 19th International Conference on Hybrid Systems: Computation and Control*, ser. HSCC ’16. New York, NY, USA: ACM, 2016, pp. 99–104.
- [18] S. Mouelhi, A. Girard, and G. Gössler, “Cosyma: A tool for controller synthesis using multi-scale abstractions,” in *Proceedings of 16th International Conference on Hybrid Systems: Computation and Control*, ser. HSCC ’13. New York, NY, USA: ACM, 2013, pp. 83–88.
- [19] M. Khaled and M. Zamani, “pFaces: An acceleration ecosystem for symbolic control,” in *Proceedings of the 22nd ACM International Conference on Hybrid Systems: Computation and Control*, ser. HSCC ’19. New York, NY, USA: ACM, 2019.
- [20] A. Pnueli, “The temporal logic of programs,” in *18th Annual Symposium on Foundations of Computer Science (sfcs 1977)*, 1977, pp. 46–57.
- [21] R. Koymans, “Specifying real-time properties with metric temporal logic,” *Real-Time Systems*, vol. 2, no. 4, pp. 255–299, 1990. [Online]. Available: <https://doi.org/10.1007/BF01995674>
- [22] E. D. Sontag, *Mathematical control theory: Deterministic finite dimensional systems*, 2nd ed., ser. Texts in Applied Mathematics. Springer-Verlag, New York, 1999, vol. 6.
- [23] A. E. Roth, “Two-person games on graphs,” *Journal of Combinatorial Theory, Series B*, vol. 24, no. 2, pp. 238 – 241, 1978.
- [24] J. H. Reif, “The complexity of two-player games of incomplete information,” *Journal of Computer and System Sciences*, vol. 29, no. 2, pp. 274 – 301, 1984.
- [25] J. Raskin, K. Chatterjee, L. Doyen, and T. Henzinger, *Algorithms for Omega-Regular Games with Imperfect Information*. Lars Birkedal, 2007, vol. 3:3, pp. 4 – 23.
- [26] D. Berwanger, K. Chatterjee, L. Doyen, T. A. Henzinger, S. Rajee, and M. Chechik, *Strategy Construction for Parity Games with Imperfect Information*. Springer Berlin Heidelberg, 2008, pp. 325–339.
- [27] D. Berwanger, K. Chatterjee, M. De Wulf, L. Doyen, and T. A. Henzinger, *Alpaga: A Tool for Solving Parity Games with Imperfect Information*. Berlin, Heidelberg: Springer Berlin Heidelberg, 2009, pp. 58–61.
- [28] G. F. Franklin, M. L. Workman, and D. Powell, *Digital Control of Dynamic Systems*, 3rd ed. Boston, MA, USA: Addison-Wesley Longman Publishing Co., Inc., 1997.

- [29] H. K. Khalil and L. Praly, "High-gain observers in nonlinear feedback control," *International Journal of Robust and Nonlinear Control*, vol. 24, no. 6, pp. 993–1015, 2014.
- [30] K. Zhang, L. Zhang, and L. Xie, *Detectability of Nondeterministic Finite-Transition Systems*. Cham: Springer International Publishing, 2020, pp. 165–175. [Online]. Available: https://doi.org/10.1007/978-3-030-25972-3_8
- [31] J. Kari, "Theory of cellular automata: A survey," *Theoretical Computer Science*, vol. 334, no. 1, pp. 3 – 33, 2005.
- [32] S. Haesaert, A. Abate, and P. M. J. V. den Hof, "Correct-by-design output feedback of lti systems," in *2015 54th IEEE Conference on Decision and Control (CDC)*, Dec 2015, pp. 6159–6164.
- [33] K. Lesser and A. Abate, "Controller synthesis for probabilistic safety specifications using observers," *IFAC-PapersOnLine*, vol. 48, no. 27, pp. 329 – 334, 2015, analysis and Design of Hybrid Systems ADHS.
- [34] K. Lesser and A. Abate, "Safety verification of output feedback controllers for nonlinear systems," in *2016 European Control Conference (ECC)*, 2016, pp. 413–418.
- [35] M. Mizoguchi and T. Ushio, "Deadlock-free output feedback controller design based on approximately abstracted observers," *Nonlinear Analysis: Hybrid Systems*, vol. 30, pp. 58 – 71, 2018.
- [36] G. Pola and M. D. D. Benedetto, "Approximate supervisory control of nonlinear systems with outputs," in *2017 IEEE 56th Annual Conference on Decision and Control (CDC)*, Dec 2017, pp. 2991–2996.
- [37] G. Pola, M. D. Di Benedetto, and A. Borri, "Symbolic control design of nonlinear systems with outputs," *Automatica*, vol. 109, p. 108511, 2019.
- [38] W. A. Apaza-Perez, A. Girard, C. Combastel, and A. Zolghadri, "Symbolic observer-based controller for uncertain nonlinear systems," *IEEE Control Systems Letters*, vol. 5, no. 4, pp. 1297–1302, 2021.
- [39] R. Majumdar, N. Ozay, and A.-K. Schmuck, "On abstraction-based controller design with output feedback," in *Proceedings of the 23rd International Conference on Hybrid Systems: Computation and Control*, ser. HSCC '20. New York, NY, USA: Association for Computing Machinery, 2020.