

# Variational certification of quantum devices

Akash Kundu<sup>1,2</sup> and Jarosław Adam Miszczak<sup>1</sup>

<sup>1</sup>*Institute of Theoretical and Applied Informatics,*

*Polish Academy of Sciences, Baltycka 5, 44-100 Gliwice, Poland*

<sup>2</sup>*Joint Doctoral School, Silesian University of Technology, Akademicka 2A, 44-100 Gliwice, Poland\**

One of the requirements imposed on the realistic quantum computers is to provide computation results which can be repeated and reproduced. In the situation when one needs to repeat the quantum computation procedure several times, it is crucial that the copies of the quantum devices are similar in the sense of the produced results. In this work, we describe a simple procedure based on variational quantum eigensolver which can be utilized to compare quantum devices. The procedure is developed by combining Choi-Jamiołkowski isomorphism with the variational hybrid quantum-classical procedure for matrix diagonalization. We compare the introduced procedure with the scheme based on the standard bounds for the similarity between quantum operations by analysing its action on random quantum channels. We also discuss the sensitivity of the described procedure to the noise, and we provide numerical results demonstrating its feasibility in realistic scenarios by running the procedure on IBM quantum computer.

**Keywords:** random quantum operations, quantum certification, variational quantum eigensolver, truncated fidelity bound.

## I. INTRODUCTION

Quantum information processing aims at utilizing the rules of quantum mechanics for the purpose of transmitting information [16] and processing data [7]. To this end one needs to construct quantum mechanical devices which implement the desired protocols or algorithms. Moreover, to make any such device suitable for deployment in real-world applications one needs to make sure that the fabricated system indeed executes the desired quantum operation and prepares the required quantum states.

At the moment, among the most promising approaches for providing useful quantum computers one can point the development of quantum procedures based on small and limited devices. Such devices are commonly referred to as NISQ (noisy intermediate scale quantum) computers because they should be available in the foreseeable future, will be rather small, limited by the number of qubits and the available set of gates, and their operational capabilities will be severely limited by errors [38].

Even for NISQ-era devices, working in the  $10^2$  qubits regime, to ensure that the quantum device provided by the merchant or the developer indeed executes the desired task, it must undergo the certification procedure. Even if the accurate control of quantum information systems foreshadows numerous applications in the area of data processing, the complexity of such devices renders the certification of their correct operating a significant challenge [9, 21].

Certification tasks are particularly demanding in quantum computing applications as the task of certifying the properties of a quantum system is equivalent to reproducing the result obtained by it in the classical simulation.

This, however, is computationally hard, which is exactly the point of the quantum supremacy [1, 3, 14].

The difficulty of the certification of the quantum devices stems mainly from the intrinsic computational advantages offered by quantum computers. Thus, it is natural to consider the possibility of utilizing quantum computers for providing the certification of quantum devices. In this work we investigate such a scenario by providing a certification scheme based on the structure of the space of quantum operations. The natural correspondence between states and operations in the quantum mechanics gives rise to new methods of information processing beyond the scope of classical mechanics.

The ideas presented in this work are organized according to the following plan. We start with the preliminaries concerning the problems related to the distinguishability of states and operations, and we recall standard mathematical apparatus utilized for investigating these matters. Next, in Section III, we consider a scenario in which quantum devices need to undergo a certification procedure and introduce two schemes. In Section IV, we compare the discussed certification procedures and investigate their behaviour for the random quantum operations. We also provide the analysis of the impact of noise models on the efficiency of the variational fidelity estimation for random quantum operations. We conclude the paper in Section V by discussing the features and limitations of the introduced schemes and their possible applications.

## II. PRELIMINARIES

One of the most prominent characteristics of quantum information is its susceptibility to errors. Even if theoretical considerations and schemes are based on the assumption that quantum states are represented by normalized

---

\* akundu@iitis.pl

vectors, in most cases this is not true when one needs to deal with the actual physical realization of the quantum computation processes. It is clear that the errors occurring during the process of preparation and processing of data encoded in a quantum system are unavoidable and have to be taken into account during the development of quantum procedures for realistic applications. From the mathematical point of view this means that the state of a quantum system during the process of quantum computation has to be described by a density matrix which is represented by the convex combinations of pure states [15, 20].

From the theoretical point of view, the problem of distinguishing between quantum devices is identical to the problem of defining the measure of similarity on the space of density matrices. The interest in the physical realizations of quantum information processing resulted in considerable effort in this area [8, 19, 37, 46], with the special focus on the feasibility of the proposed schemes [41]. What's more, the same mathematical apparatus developed for solving discrimination problems can be used to quantify the amount of errors in physical realizations of quantum processes [11]. This issue is crucial for describing the precision of the physical implementation of quantum information processing.

The most common measure of similarity between quantum states  $\rho$  and  $\sigma$  is given by fidelity [45],

$$F(\rho, \sigma) = \|\sqrt{\rho}\sqrt{\sigma}\|_1 = \text{tr}\sqrt{\sqrt{\rho}\sigma\sqrt{\rho}}, \quad (1)$$

where  $\|\cdot\|_1$  is the Schatten 1-norm. Fidelity provides a quantum counterpart of the Bhattacharyya coefficient measuring the similarity between two probability distributions and it reduces to the scalar product for rank-1 operators. The important characteristic of fidelity is that its calculation requires non-integer powers of  $\rho$  and  $\sigma$  and thus there is no exact quantum algorithm which could be used to calculate it using finite number of copies of the input states.

As it is believed that computing quantum fidelity will be important to verify and characterize the states prepared on a quantum computer, a significant research effort has been devoted to the problem of finding methods for calculating or approximating it [27]. Therefore, it is also reasonable to provide the bounds for the values of fidelity using the functionals which could be easily calculated. To address this, sub- and super-fidelity bounds (SSFB) for the fidelity between quantum states were introduced [32], defined respectively as

$$E(\rho, \sigma) = \text{tr}\rho\sigma + \sqrt{2[(\text{tr}\rho\sigma)^2 - \text{tr}(\rho\sigma)^2]} \quad (2)$$

and

$$G(\rho, \sigma) = \text{tr}\rho\sigma + \sqrt{(1 - \text{tr}\rho^2)(1 - \text{tr}\sigma^2)}, \quad (3)$$

and fulfilling the property

$$E(\rho, \sigma) \leq F(\rho, \sigma) \leq G(\rho, \sigma). \quad (4)$$

Both sub- and super-fidelity display many features desirable from the quantity used to approximate the fidelity. First of all, both are expressed in the form of functional of density matrices which have a direct representation in the form of quantum circuits [10]. In the case of two-qubit photonic states these quantities can be efficiently measured [2]. Moreover, super-fidelity can be used to provide the lower bound for the trace distance between two quantum states [39], that can be estimated using a simple measurement procedure.

More recently, an alternative approach for computing the bounds for fidelity, based on variational hybrid quantum-classical algorithm has been proposed [5]. This variational quantum fidelity estimation (VQFE) algorithm was designed as the extension of the variational diagonalization procedure introduced in [25]. The variational diagonalization procedure enables finding  $m$  eigenvalues of one of density matrices used to calculate fidelity in the eigenbasis of the second density matrix. Thus, the series of approximations – so-called *fidelity spectrum* – can be obtained and used to bound the value of fidelity. The bounds on the fidelity between states  $\rho$  and  $\sigma$  are expressed by

$$F(\rho_m, \sigma_m^\rho) \leq F(\rho, \sigma) \leq F_*(\rho_m^\rho, \sigma_m^\rho), \quad (5)$$

with

$$F_*(\rho_m, \sigma_m^\rho) \equiv \|\sqrt{\rho_m^\rho}\sqrt{\sigma_m^\rho}\|_1 + \sqrt{(1 - \text{tr}\rho_m^\rho)(1 - \text{tr}\sigma_m^\rho)}, \quad (6)$$

where  $\sigma_m^\rho = \Pi_m^\rho \sigma \Pi_m^\rho$  denotes the operator obtained as the projection of  $\sigma$  onto the subspace spanned by  $m$  eigenvectors of  $\rho$ , corresponding to the largest eigenvalues and  $\Pi_m^\rho$  is the projector onto this subspace. Quantity  $F(\rho_m, \sigma_m^\rho)$  is called *truncated fidelity*, and it has also been applied to the problem of computing quantum Fisher information [43].

The VQFE algorithm targets the situations when one of the input states is low-rank. However, even if the procedure was developed by assuming low-rank approximations of a density matrix, the bounds given by (5) can be arbitrarily refined by increasing  $m$ .

In what follows, we utilize the SSFB and VQFE procedures as building blocks for the quantum device certification. We achieve this by combining the procedures for the estimation of bounds on fidelity with the resulting density matrix obtained by using Choi-Jamiolkowski isomorphism [6, 17, 18]. We will use the standard representation of this isomorphism. Namely, for a quantum channel  $\Phi$ , being a completely-positive trace preserving operation on the space of density matrices  $\Omega(\mathbb{C}^n)$ , we define the Choi-Jamiolkowski image of  $\Phi$ ,  $\mathcal{J}(\Phi)$ , as

$$\mathcal{J}(\Phi) = (\mathbf{1} \otimes \Phi) \sum_{i=1}^n |i\rangle \otimes |i\rangle, \quad (7)$$

where  $\sum_{i=1}^n |i\rangle \otimes |i\rangle$  is the maximally entangled state on the space  $\mathbb{C}^n \otimes \mathbb{C}^n$ .

### III. ESTIMATION OF THE FIDELITY BETWEEN QUANTUM DEVICES

#### A. Problem statement

Let us assume that the quantum start-up company has developed a device solving an important optimization problem or producing valuable states utilized by some crucial quantum communication protocol. In this case, it is desirable to provide some testing procedure which would ensure the buyers that the offered device really provides the described functionality. To achieve this, one needs to ensure that the operation realized by the quantum device is indeed the one promised by the seller.

In the general case of channel distinguishability, it is customary to assume that we have for our disposal a set of  $N$  quantum devices, represented by quantum channels  $\Psi_1, \Psi_2, \dots, \Psi_N$ . Each of the devices is given as a black box, *ie.* the Kraus representation of the channels is unknown. In such a situation, one cannot judge if the input devices are perfectly distinguishable [8].

However, in our situation the task is simpler. All we need to do is to convince a customer that the device we would like to sell implements the operation of some standard or ideal device. From now on, we assume that the ideal (or standard) device  $D_{\Phi_0}$  is described by a quantum channel  $\Phi_0$ , which operates on the space of  $n$  qubits. We also deal with the second device,  $D_{\Psi}$ , which is claimed to be identical with  $D_{\Phi_0}$ .

What's more, as our start-up is a quantum company, its board decided that the certification procedures deployed by the company should also benefit from the quantum advantage. Such decision yields two benefits. Firstly, it supports the claims concerning the ubiquitous applications of quantum computing. Secondly, it provides an opportunity to develop a unique certification service which can be offered to other quantum start-ups [35].

#### B. SSFB certification procedure

The first approach one can propose is based on the SSFB bounds. Such approach was first proposed in [40], where new measures of distance between quantum operations have been introduced. These two quantities are  $C_G$  corresponding to root infidelity,

$$C_G(\Phi_0, \Psi) = \sqrt{1 - G(\mathcal{J}(\Phi_0), \mathcal{J}(\Psi))}, \quad (8)$$

and  $A_{G^2}$ , corresponding to Bures angle,

$$A_{G^2}(\Phi_0, \Psi) = \arccos C_G(\Phi_0, \Psi). \quad (9)$$

It can be demonstrated that both  $C_G$  and  $A_{G^2}$  have the properties required from the measures of difference between ideal and real quantum processes [11, 40]. What is more important, they both can be measured directly. This is due to the fact that super-fidelity, in the terms of

which both quantities are expressed, can be measured in the simple quantum procedure [32].

For the sake of completeness, in Fig. (1) we recall the construction of the quantum circuit for calculating the overlap between two quantum channels as introduced in [40].

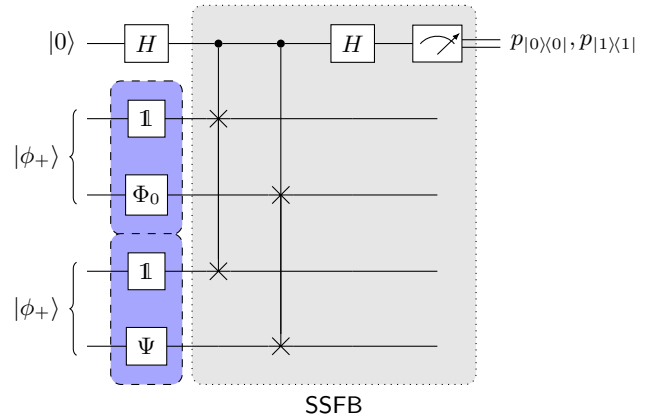

FIG. 1. Quantum procedure for calculating the overlap between quantum channels based on super-fidelity [32]. The procedure consists of the sub-procedure for creating Choi-Jamiołkowski image of the channel (blue dashed parts) applied twice and the sub-procedure for evaluating the overlap (green dotted part). The resulting probability  $p_{|0\rangle\langle 0|}$  of finding the top qubit in state  $|0\rangle$  corresponds to  $\text{tr} \mathcal{J}(\Phi) \mathcal{J}(\Psi) = 2p_{|0\rangle\langle 0|} - 1$  [10]. This leads to the direct estimation of the bound for the fidelity between channels describing devices  $\Phi_0$  and  $\Psi$ . See [32] for the construction of a quantum circuit for measuring sub-fidelity.

The circuit presented in Fig. (1) consists of two parts. The first part is used to construct the density matrix corresponding to the quantum channel as defined by the Choi-Jamiołkowski isomorphism. The circuit is based on the gate-teleportation approach. The second part of the circuit implements the calculation of the overlap between two density matrices [10]. In this case, as the density matrices fed into the second part of the procedure represent quantum channels, the final measurement results in the estimation of the overlap between the images of the Choi-Jamiołkowski isomorphism for the channels.

In order to utilize this circuit in the device certification scenario one has to process the obtained measurement results in order to calculate the appropriate bound on the similarity between quantum devices. The diagram representing this procedure is provided in Fig. (2). The procedure takes two device as an input – the standard device with the operational capacity already confirmed, and the device for which its conformation with the standard device is to be confirmed.

One should note that in this scheme the classical data processing is required only at the final step of the procedure. This step is required to compute the bounds for the fidelity based on the measurement results.

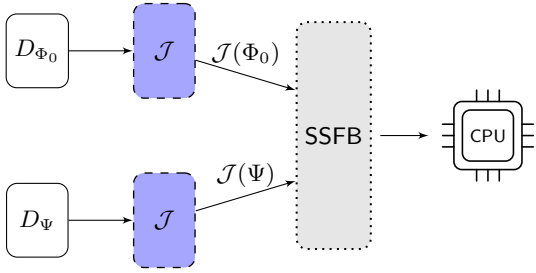

FIG. 2. SSFB quantum device certification scheme. In this scheme, the goal is to certify a quantum device  $\Psi$  against the ideal (or standard) device  $\Phi_0$  using the calculable bounds for the fidelity. The input of the procedure is given in the form of physical devices,  $D_{\Phi_0}$  and  $D_{\Psi}$ , implementing channels  $\Phi_0$  and  $\Psi$ , respectively. CPU part of the scheme is responsible for classical post-processing of the results obtained using the quantum procedure. Colours and line styles are identical to the ones used in Fig. (1).

### C. VQFE certification procedure

The alternative approach to the task of quantum certification can be obtained by utilizing the variational quantum fidelity estimation. The goal of this procedure is to find the truncated fidelity of  $\mathcal{J}(\Psi)$  for the  $m$  largest eigenvalues of  $\mathcal{J}(\Phi_0)$ .

In [25], the procedure for using variational hybrid classical-quantum algorithm was introduced. This procedure can be used to calculate lower and upper bounds for the fidelity based on the *truncated fidelities*, defined as overlaps between two density matrices in the eigenbasis of one of the matrices.

In the application to the problem of device certification, the quantum variational fidelity estimation consists of the following steps (see Fig. (3)).

- Prepare two copies of  $\mathcal{J}(\Phi_0)$  and one copy of  $\mathcal{J}(\Psi)$ .
- Utilize variational quantum state diagonalization (VQSD) for diagonalizing  $\mathcal{J}(\Phi_0)$ . This procedure outputs eigenvalues  $\{r_i\}$  of  $\mathcal{J}(\Phi_0)$ , which can be subsequently stored in a classical CPU, and the eigenvectors of  $\mathcal{J}(\Phi_0)$ , used in the next step.
- Utilize VQSD with input  $\mathcal{J}(\Psi)$  and the eigenvectors of  $\mathcal{J}(\Phi_0)$  obtained from the first VQSD sub-procedure to obtain matrix elements  $\sigma_{ij}$  of  $\mathcal{J}(\Psi)$  in the eigenbasis of  $\mathcal{J}(\Phi_0)$ .
- The resulting matrix elements of  $\mathcal{J}(\Psi)$  in the eigenbasis of  $\mathcal{J}(\Phi_0)$  and eigenvalues of  $\mathcal{J}(\Phi_0)$  are used to calculate truncated fidelity bounds according to Eq. (5).

In the remaining part of the paper, in order to simplify the notation, we have considered  $\rho = \mathcal{J}(\Phi_0)$  and  $\sigma = \mathcal{J}(\Psi)$ .

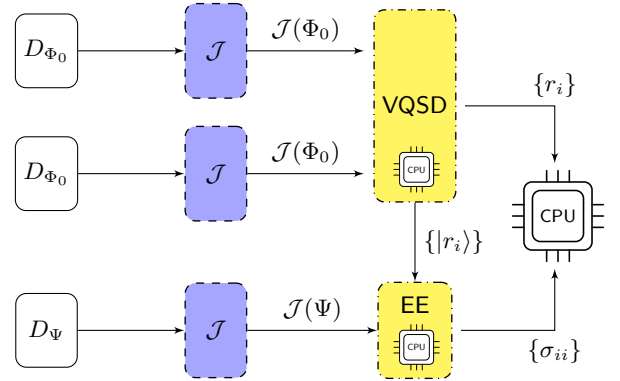

FIG. 3. VQFE quantum device certification scheme. In this scheme to certify a quantum device  $\Psi$  against the ideal (or standard) device  $\Phi_0$  the VQFE procedure is used. The input of the procedure is given in the form of physical devices,  $D_{\Phi_0}$  and  $D_{\Psi}$ , implementing channels  $\Phi_0$  and  $\Psi$ , respectively. The first step is to apply Choi-Jamiołkowski isomorphism to obtain dynamical matrices for the input devices. Next, two copies of  $\mathcal{J}(\Phi_0)$  are used as an input for the variational quantum state diagonalization procedure (VQSD). At the same time,  $\mathcal{J}(\Psi)$  is processed by a quantum-classical algorithm to obtain its matrix elements in the eigenbasis of  $\mathcal{J}(\Phi_0)$ . Finally, classical processing of the obtained eigenvalues is used to calculate the approximation of the fidelity between quantum operations. Note that in this procedure, CPU part is utilized at several steps – as a part of VQSD used for calculating eigenvalues  $r_i$  of  $\mathcal{J}(\Phi_0)$  and matrix elements  $\sigma_{ij}$  of  $\mathcal{J}(\Psi)$ . Yellow colour indicates hybrid quantum-classical subprocedures. Procedure denoted by EE (Eigenvalue Estimation) evaluates  $\sigma_{ij} = \langle r_i | \sigma | r_j \rangle$ .

## IV. COMPARISON OF THE PROCEDURES

The discussed procedures can be potentially used in the certification scenarios. Naturally, in such case one can take into account various requirements imposed on the quality or on the cost of the certification. If the figure of merit in the certification scenario is the precision of the results given by the procedure, the most important factor is the accuracy of the results given by the procedure. On the other hand, one might be interested in the fast and cost-effective certification of the quantum devices. In this case, the goal is to minimize the size of the systems used during the procedures and the depth of the auxiliary circuits. One should note that in both cases we assume that quantum resources – the complication of a quantum system, number of copies of quantum states, or the final accuracy – are more important than the classical resources (eg. time required for classical computation) required for the certification procedure.

### A. Memory requirements

Let us first focus on the requirements concerning the size of quantum systems needed in the case of both dis-

cussed procedures. We assume that our devices – both the standard one and the certified one – operate on  $n$  qubits. The Choi-Jamiołkowski isomorphism leads to the requirement of  $2n$  qubits for constructing corresponding dynamical matrices. In the case of SSFB certification, super-fidelity calculation utilizes  $4n + 1$  qubits as it requires only the values of expressions of the form  $\text{tr}(\mathcal{J}(\Psi_i)\mathcal{J}(\Phi_0))$ . On the other hand, the quantum circuit for sub-fidelity requires  $8n + 1$  qubits. Moreover, the sub-fidelity bound requires two copies of both devices to be delivered as an input to the certification procedure. This makes this procedure hard to implement in practice as even if the copies of the standard devices might be available, it is reasonable to assume that each new device undergoing the certification procedure is different.

In the case of VQFE scheme, also two copies of the device  $D_{\Phi_0}$  used as the certification model have to be used. This is due to the fact that two copies of  $\mathcal{J}(\Phi_0)$  have to be used by the first VQSD procedure. However, the VQFE certification procedure requires quantum register with  $4n + 1$  qubits only.

As one can see, the main obstacle for using both procedures is the requirement of using two copies of the dynamical matrix of the standard device. This further translates into the requirement that one has to possess two copies of this device. Moreover, both copies have to be certified to represent the same operation. This problem does not occur in the case of SSFB certification if one is only interested in the upper bound for the fidelity as in this case only one copy of the standard device is required.

It should be also noted that VQFE procedure requires two copies of the standard device to be used only once. If the first VQSD procedure is executed, corresponding eigenvalues and eigenvectors can be utilized to certify newly produced quantum devices. Together with the modest requirements concerning the size of quantum registers, this fact makes VQFE certification procedure more appropriate for practical applications offered to wider audiences.

## B. Accuracy of the procedures

The second aspect of both considered procedures is their accuracy.

First of all, VQFE was developed as a low-rank approximation of the fidelity. In a similar manner, SSFB provides tighter bounds if the input density matrices are low-rank. Thus both certification procedures are better suited for devices operating on low-rank matrices. This translates to the operations with smaller number of Kraus operators [30].

On the other hand, one should note that the bounds obtained by VQFE certification can be tightened monotonically with the rank of the approximation used. Thus, the accuracy of the certification can be refined to achieve the required threshold. SSFB certification does not pro-

vide such mechanisms.

To investigate the behaviour of the SSFB and VQFE certification procedures we provide the analysis of the bounds obtained by both methods for the case of random quantum operations [4, 23]. Sampling over the set of quantum operations has potential applications in quantum computing and quantum information theory, in particular for investigating the properties of quantum circuits [28, 42, 44], analysing data from randomized experiments [13], and process tomography [22].

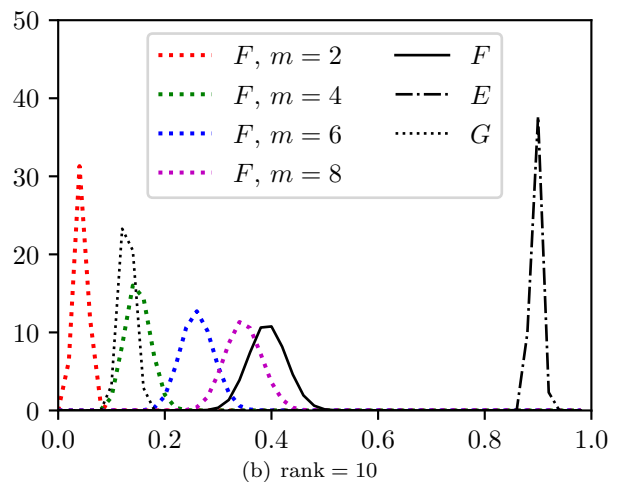
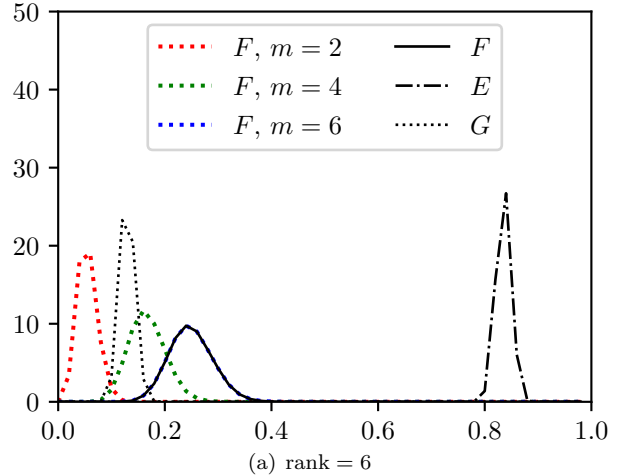
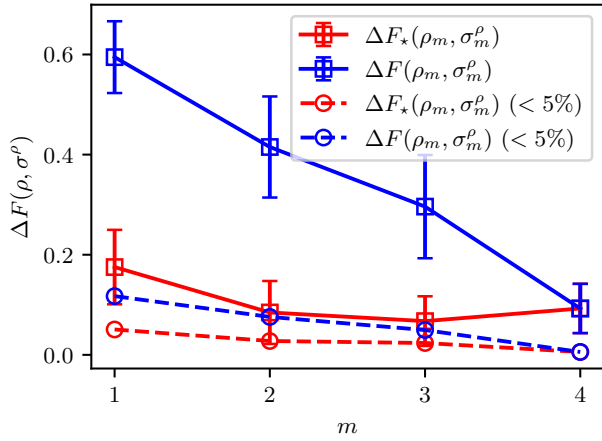
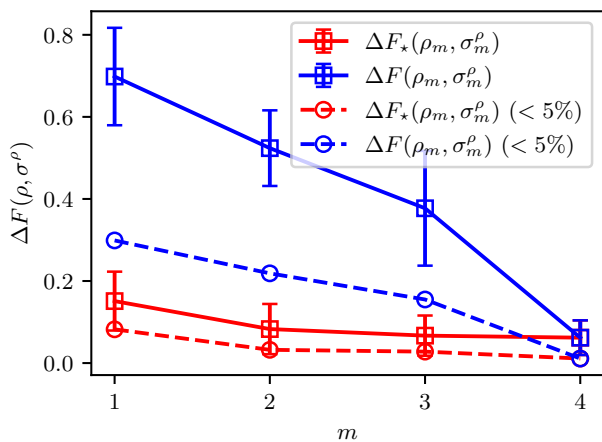

FIG. 4. Probability density of values of the bounds for random quantum operations obtained using SSFB and VQFE certification. In the above figure random quantum operators were sampled using the method described in [4] and implemented in [34]. A sample of  $10^5$  random operations acting on two qubits was used, with dynamical matrices of (a) rank 6 and (b) rank 10. In the case (a) truncated fidelity for  $m = 6$  corresponds to fidelity. Black dotted and black dashdotted lines indicate the values of sub-fidelity  $G$  and super-fidelity  $E$  obtained for this case. Solid black lines indicate the values of  $F$ .

For the purpose of the presented study we utilize the implementation of the random operations generation procedure provided in [31, 33, 34]. To sample the space of



(a) CZ as entangler.



(b) CX as entangler.

FIG. 5. Error in fidelity estimation with respect to  $m$ . The results were obtained by taking an average over 1000 random 1-qubit quantum channels ( $n = 1$ ) of rank 4, using IBM quantum computer simulator from `Qiskit Aer` package. Here  $\Delta F(\rho, \sigma^\rho) = F(\rho_m, \sigma_m^\rho) - F(\rho, \sigma)$ . The dashed lines depict the average over channels with less than 5% error in the estimation of fidelity. The source code for the implementation can be obtained from [24].

quantum operations we generate a square matrix  $X$  of  $N^2 \times M$  from the complex Ginibre ensemble [12] with elements being complex random Gaussian variables. By taking the partial trace of matrix  $GG^\dagger$  over the first subsystem and subsequently normalizing the results we obtain a random dynamical matrix,

$$\left( \mathbb{1}_N \otimes \frac{1}{\sqrt{\text{tr}_N GG^\dagger}} \right) GG^\dagger \left( \mathbb{1}_N \otimes \frac{1}{\sqrt{\text{tr}_N GG^\dagger}} \right) \quad (10)$$

where  $\text{tr}_N$  denotes the partial trace over the first  $N$ -dimensions.

The results obtained for the sample of random quantum operations are presented in Fig. (4). As one can

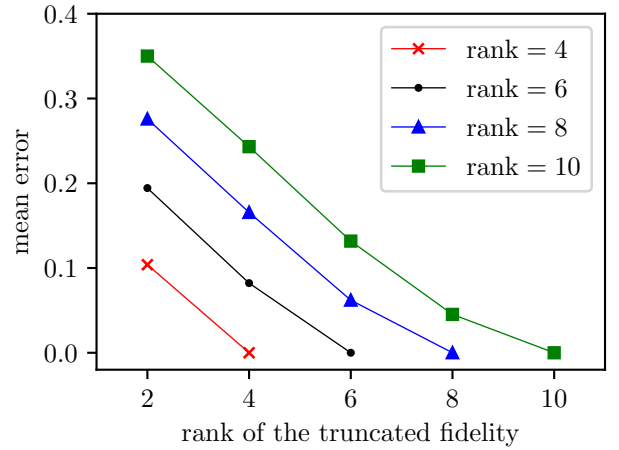

FIG. 6. Mean error for the approximation of fidelity by the truncated fidelities. Values are plotted for random quantum operations as a function of the rank of the truncated fidelity. Each combination of colour and shape corresponds to density matrices with a fixed rank. Each point was obtained by averaging the difference between the fidelity and the truncated fidelity on the sample of  $10^5$  pairs of random dynamical matrices.

see, to obtain a viable approximation of fidelity in terms of truncated fidelities, the VQFE certification procedure needs to be used to estimate almost all eigenvalues of the dynamical matrix. In this particular case, the lower bound obtained using SSFB provides an estimation similar to the VQFE certification with  $m = 4$  eigenvalues.

From the results for random quantum operations one can see that VQFE provides a very good tool for lower-rank operations. At the same time SSFB, certification can provide useful lower bound for fidelity between operations. However, the upper bound obtained in SSFB case is unsuitable for providing a viable approximation of fidelity.

It can be also noted that the approximation given by VQFE procedure can be significantly improved by increasing the number of eigenvalues estimated in the variational diagonalization procedure. This can be seen in Fig. (6), where the dependency of the mean approximation error of the truncated fidelity is plotted for dynamical matrices with different rank. As one can see, the bound obtained using truncated fidelities can be easily tightened. Moreover, the mean for the given rank of the truncated fidelity decreases with the increasing rank of random dynamical matrices.

Fidelity estimation with respect to the number of estimated eigenvalues can be observed in Fig. (5). As an ansatz we used three layers of the following structure

$$U(\vec{\theta}) = U_{\text{ent}} \times \prod_{i=0}^{N-1} \text{RY}(\theta_i)^{\otimes i} \text{RZ}(\theta_i)^{\otimes i}, \quad (11)$$

where  $n$  is the dimension of quantum channel. In subfigure (5a) we use  $U_{\text{ent}} = \text{CZ}$  and in subfigure (5b) setting  $U_{\text{ent}} = \text{CX}$  and  $N = 2n = 2$ . For simulation purposes we

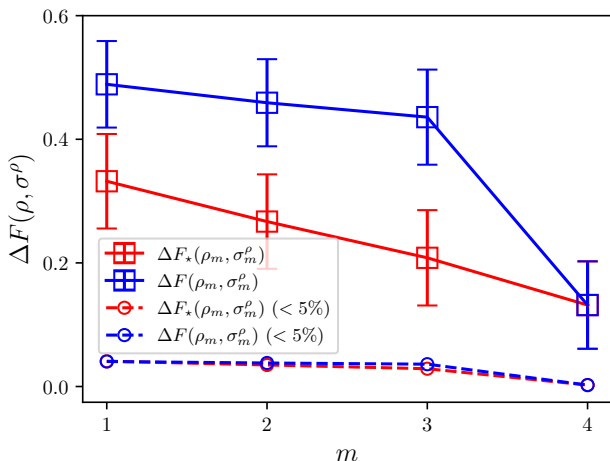

FIG. 7. The average error in fidelity estimation with respect to  $m$ , obtained by averaging over 1000 random 2-qubit quantum channels ( $n = 2$ ) of rank 4, using IBM quantum computer simulator from `Qiskit Aer` package.

utilize `Qiskit` package to implement the variational fidelity estimation for one-qubit quantum channels, which can be executed using a quantum computer. One can observe that the difference between the real and the approximated value decreases with the rank of the approximation.

In the Fig. (7) we illustrate the error in the fidelity estimation for two-qubit quantum channels of rank 4. It should be noted that although the average error over 1000 random one and two qubit channels is almost similar in both cases, the difference lies in the number of channels with less than 5% error. While for one qubit channels we get 480 channels with less than 5% error (dashed lines in Fig. (5)), for two qubit channels the number decreases almost 5 times i.e. we note 99 channels with less than 5% error (dashed lines in Fig. (7)). To obtain the results we utilize the similar structure of the ansatz as in Eq. (11) with  $N = 2n = 4$ . The entangler is of the following form

$$U_{\text{ent}} = \prod_{i=0}^{N-1} \text{CX}_{i,i+1(\text{mod}N)}. \quad (12)$$

Interestingly, during the simulation we found out that some of the channels are easier to certify than others, which is reflected by the statistics over the number of channels that are converging to the true fidelity for one and two qubit channels, as described above.

### C. Sensitivity to noise

The last aspect of importance is the sensitivity of the proposed procedure. In this section we study the convergence of truncated fidelity bounds under a class of noise models. Let us start by discussing briefly the nature of

the noise models under consideration. A  $p$ -dimensional depolarizing channel can be viewed as CPTP map, which maps a state  $\rho$  into linear combination of a maximally mixed state and the state itself

$$\Delta_\gamma = (1 - \gamma)\rho + \frac{\gamma}{p}\mathbb{1}. \quad (13)$$

On the other hand, amplitude-damping channel leads to a decay of energy from an excited state to the ground state depending on the probability  $\gamma$ . Hence, the channel's action on a state is given as

$$A_\gamma = \mathcal{K}_0\rho\mathcal{K}_0^\dagger + \mathcal{K}_1\rho\mathcal{K}_1^\dagger, \quad (14)$$

where

$$\mathcal{K}_0 = \begin{bmatrix} 1 & 0 \\ 0 & \sqrt{1-\gamma} \end{bmatrix}, \quad \mathcal{K}_1 = \begin{bmatrix} 0 & \sqrt{\gamma} \\ 0 & 0 \end{bmatrix}. \quad (15)$$

Meanwhile, random  $X$  quantum channel is defined as

$$R_\gamma = \gamma X + (1 - \gamma)\mathbb{1}, \quad (16)$$

where we apply  $X$ -gate with probability  $\gamma$ . In Fig. (8) we illustrate the effect of depolarizing, amplitude damping, and random  $X$  noise. It can be observed that the fidelity bound fails to converge to the true value as the noise amplitude increases by more than 10%. The depolarizing and random  $X$  noise increases the fidelity at full rank, while due to the effect of amplitude damping noise the estimated fidelity decreases. When the amplitude of noise increases by more than 10%, the deviation of fidelity estimation from its true value becomes more prominent.

To get some insight into the sensitivity of the described procedure in the realistic model, one can consider a noise model of the quantum hardware. To achieve this we run the procedure on IBM quantum computer with noisy and noise-free simulator for the sample of random quantum operations.

In Fig. (9), we depict the results for fidelity estimation after running the algorithm in `Qiskit Aer` with real device backends provided by IBM.

## V. FINAL REMARKS

As suggested in [5], variational quantum fidelity estimation can be naturally used to compute the distance between quantum operations and thus provide means for the certification of quantum devices. Following this direction, we have proposed a method for certifying quantum devices which is aimed to be used on near-term intermediate-scale quantum computers. The proposed scheme is particularly suitable for the cases when one needs to provide a convincing argument supporting their claim concerning some quantum mechanical device, and the certified quantum device operates on a relatively small number of qubits. This is exactly the case for the

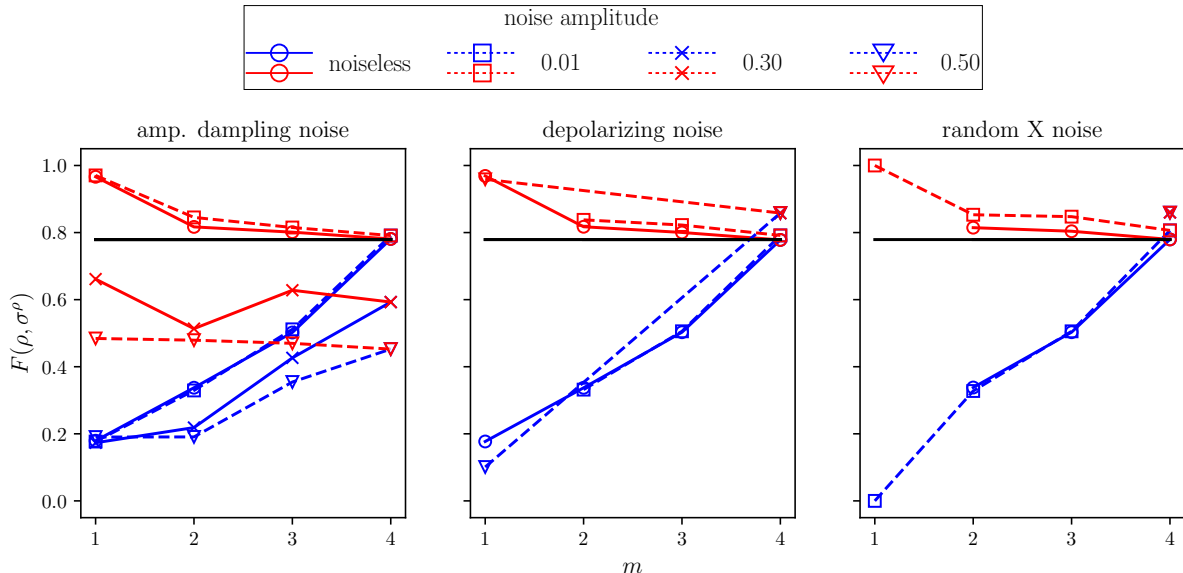

FIG. 8. Effect of noise in the estimation of truncated fidelity bound under amplitude damping, depolarizing, and random  $X$  channels. It can be seen that the effect of amplitude damping noise on fidelity estimation is more prominent when the noise ratio exceeds 30%. Additionally, for amplitude damping noise when the noise amplitude is within 10%, we do not observe any notable changes in the fidelity estimation.

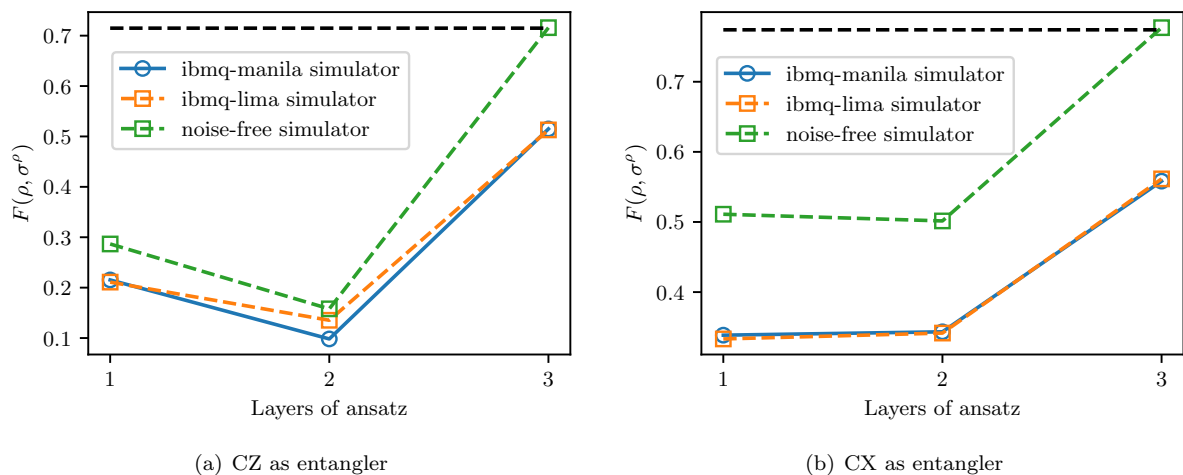

FIG. 9. An example of the convergence of the truncated fidelity for a single random one-qubit (rank 4) channel in IBM's noise-free simulator and `AerSimulator` from Qiskit package with real device backends. The black dashed line depicts the true value of fidelity. See [24] for the implementation details.

NISQ generation of quantum devices, which makes the presented approach especially appealing in this scenario.

The benefits and features of the VQFE certification procedure are related to the very principles of VQE computing paradigm [36]. In particular, VQE is one of the main candidates for exploiting the advantage offered by early quantum devices. At the same time, VQE is, by design, suitable for harnessing the strengths of a given architecture. For example, if some gates or quantum operations may be performed with higher fidelity then by utilizing proper ansatz, VQE can benefit from this fact.

At the same time, VQE is able to suppress some kinds of quantum errors [29], which makes it especially attractive for NISQ devices. Meanwhile, from the noisy simulation of the certification we can infer that the effect of amplitude damping noise is far more prominent than the depolarizing and random  $X$  noise when the noise amplitude is more than 0.1.

The main weakness of the approach presented in this work is that both procedures require the standard device to be available and it has to be confirmed as operating in accordance to the specification. Thus, one needs



some other form of the certification in order to construct the standard device. However, the proposed procedures enable the fast certification based on the quantum resources. Even if the certification of the device used as the standard one is expensive in terms of computational resources, the quantum mechanical approach to the certification makes the certification of next devices significantly cheaper.

This weakness is even more visible in the case of SSFB certification as two copies of the standard device are required. This translates to the requirement of preparing two images of Choi-Jamiołkowski isomorphism corresponding to the standard devices. Equivalently one has to possess two copies of such device and to certify that they represent the same operation. The variational state diagonalization routine used in VQFE as a subprocedure also requires two copies of the device. However, in this case one has to use hybrid quantum-classical procedure for variational diagonalization of the standard device only once. This fact and the quality of the obtained certification makes the VQFE certification an attractive approach to the problem of quantum device certification, especially when a significant number of new devices must undergo the certification procedure.

Eigen-decomposition of Choi-Jamiołkowski states is an indispensable recipe to obtain the Kraus operators of an unknown quantum operation [26]. The VQSD algorithm along with Choi-Jamiołkowski isomorphism pro-

vides complete eigen-information of an unknown quantum operation hence the diagonalizing subroutine of the certification process can be utilized in quantum process tomography. The introduced scheme is based on the well-known and studied building blocks used in the theory of quantum computing. We believe that this demonstrates the current trend in the area of quantum data processing when one aims at building practical applications of quantum computing by utilizing the concepts and methods which were quite recently of only theoretical interest. The presented work demonstrates that such approach can lead to interesting applications of quantum computers.

## ACKNOWLEDGMENTS

This work has been partially supported by the Polish National Science Center (NCN) under the grant agreement 2019/33/B/ST6/02011.

JM would like to express his gratitude to P. Gawron, Z. Puchała, and K. Życzkowski for discussions concerning the problems related to process discrimination and generation of random quantum operations. Authors would also like to acknowledge comments from M. Ostaszewski concerning the variational quantum computing and help from A. Glos with improving the implementation of the variational fidelity estimation.

- 
- [1] Frank Arute, Kunal Arya, Ryan Babbush, Dave Bacon, Joseph C. Bardin, Rami Barends, Rupak Biswas, Sergio Boixo, Fernando G.S.L. Brandao, David A. Buell, Brian Burkett, Yu Chen, Zijun Chen, Ben Chiaro, Roberto Collins, William Courtney, Andrew Dunsworth, Edward Farhi, Brooks Foxen, Austin Fowler, Craig Gidney, Marissa Giustina, Rob Graff, Keith Guerin, Steve Habegger, Matthew P. Harrigan, Michael J. Hartmann, Alan Ho, Markus Hoffmann, Trent Huang, Travis S. Humble, Sergei V. Isakov, Evan Jeffrey, Zhang Jiang, Dvir Kafri, Kostyantyn Kechedzhi, Julian Kelly, Paul V. Klimov, Sergey Knysh, Alexander Korotkov, Fedor Kostritsa, David Landhuis, Mike Lindmark, Erik Lucero, Dmitry Lyakh, Salvatore Mandrà, Jarrod R. McClean, Matthew McEwen, Anthony Megrant, Xiao Mi, Kristel Michielsen, Masoud Mohseni, Josh Mutus, Ofer Naaman, Matthew Neeley, Charles Neill, Murphy Yuezhen Niu, Eric Ostby, Andre Petukhov, John C. Platt, Chris Quintana, Eleanor G. Rieffel, Pedram Roushan, Nicholas C. Rubin, Daniel Sank, Kevin J. Satzinger, Vadim Smelyanskiy, Kevin J. Sung, Matthew D. Trevithick, Amit Vainsencher, Benjamin Villalonga, Theodore White, Z. Jamie Yao, Ping Yeh, Adam Zalcman, Hartmut Neven, and John M. Martinis. Quantum supremacy using a programmable superconducting processor. *Nature*, 74(7779): 505–510, oct 2019. doi:10.1038/s41586-019-1666-5.
- [2] Karol Bartkiewicz, Karel Lemr, and Adam Miranowicz. Direct method for measuring of purity, super-fidelity, and subfidelity of photonic two-qubit mixed states. *Phys. Rev. A*, 88:052104, 2013. doi: 10.1103/PhysRevA.88.052104.
- [3] Sergio Boixo, Sergei V. Isakov, Vadim N. Smelyanskiy, Ryan Babbush, Nan Ding, Zhang Jiang, Michael J. Bremner, John M. Martinis, and Hartmut Neven. Characterizing quantum supremacy in near-term devices. *Nat. Phys.*, 14(6):595–600, 2018. doi:10.1038/s41567-018-0124-x.
- [4] Wojciech Bruzda, Valerio Cappellini, Hans Jürgen Sommers, and Karol Życzkowski. Random quantum operations. *Phys. Lett. A*, 373(3):320–324, 2009. doi: 10.1016/j.physleta.2008.11.043.
- [5] Marco Cerezo, Alexander Poremba, Lukasz Cincio, and Patrick J. Coles. Variational quantum fidelity estimation. *Quantum*, 4:248, 2020. doi:10.22331/q-2020-03-26-248.
- [6] Man Duen Choi. Completely positive linear maps on complex matrices. *Linear Alg. Appl.*, 10(3):285–290, 1975. doi:10.1016/0024-3795(75)90075-0.
- [7] David Deutsch. Quantum theory, the Church–Turing principle and the universal quantum computer. *Proc. R. Soc. Lond. A*, 400(1818):97–117, 1985. doi: 10.1098/rspa.1985.0070.
- [8] Runyao Duan, Yuan Feng, and Mingsheng Ying. Perfect distinguishability of quantum operations. *Phys. Rev. Lett.*, 103(21):210501, 2009. doi: 10.1103/PhysRevLett.103.210501.
- [9] Jens Eisert, Dominik Hangleiter, Nathan Walk, Ingo Roth, Damian Markham, Rhea Parekh, Ulysse Chabaud, and Elham Kashefi. Quantum certification and bench-

- marking. *Nat. Rev. Phys.*, 2(7):382–390, 2019. doi:10.1038/s42254-020-0186-4.
- [10] Artur K. Ekert, Carolina Moura Alves, Daniel K. L. Oi, Michał Horodecki, Paweł Horodecki, and Leong Chuan Kwek. Direct estimations of linear and nonlinear functionals of a quantum state. *Phys. Rev. Lett.*, 88(21):217901, 2002. doi:10.1103/PhysRevLett.88.217901.
- [11] Alexei Gilchrist, Nathan K. Langford, and Michael A. Nielsen. Distance measures to compare real and ideal quantum processes. *Phys. Rev. A*, 71(6):062310, 2005. doi:10.1103/PhysRevA.71.062310.
- [12] Jean Ginibre. Statistical ensembles of complex, quaternion, and real matrices. *J. Math. Phys.*, 6(3):440–449, 1965. doi:10.1063/1.1704292.
- [13] Christopher Granade, Christopher Ferrie, Ian Hincks, Steven Casagrande, Thomas Alexander, Jonathan Gross, Michał Kononenko, and Yuval Sanders. QInfer: Statistical inference software for quantum applications. *Quantum*, 1:5, 2017. doi:10.22331/q-2017-04-25-5.
- [14] Aram W. Harrow and Ashley Montanaro. Quantum computational supremacy. *Nature*, 549(7671):203–209, 2017. doi:10.1038/nature23458.
- [15] Alexander S. Holevo. *Statistical Structure of Quantum Theory*, volume 67 of *Lecture Notes in Physics*. Springer-Verlag, 2001. doi:10.1007/3-540-44998-1.
- [16] Roman S. Ingarden. Quantum information theory. *Rep. Math. Phys.*, 10(1):43–72, 1976. doi:10.1016/0034-4877(76)90005-7.
- [17] Andrzej Jamiolkowski. Linear transformations which preserve trace and positive semidefiniteness of operators. *Rep. Math. Phys.*, 3(4):275–278, 1972. doi:10.1016/0034-4877(72)90011-0.
- [18] Andrzej Jamiolkowski. An effective method of investigation of positive maps on the set of positive definite operators. *Rep. Math. Phys.*, 5(3):415–424, 1974. doi:10.1016/0034-4877(74)90044-5.
- [19] Zhengfeng Ji, Yuan Feng, Runyao Duan, and Mingsheng Ying. Identification and distance measures of measurement apparatus. *Phys. Rev. Lett.*, 96(20):200401, 2006. doi:10.1103/PhysRevLett.96.200401.
- [20] Michael Keyl. Fundamentals of quantum information theory. *Phys. Rep.*, 5(369):431–548, 2002. doi:10.1016/S0370-1573(02)00266-1.
- [21] Martin Kliesch and Ingo Roth. Theory of quantum system certification. *PRX Quantum*, 2:010201, 2021. doi:10.1103/PRXQuantum.2.010201.
- [22] George C. Knee, Eliot Bolduc, Jonathan Leach, and Erik M. Gauger. Quantum process tomography via completely positive and trace-preserving projection. *Phys. Rev. A*, 98(6):062336, 2018. doi:10.1103/PhysRevA.98.062336.
- [23] Ryszard Kukulski, Ion Nechita, Łukasz Paweła, Zbigniew Puchała, and Karol Życzkowski. Generating random quantum channels. *J. Math. Phys.*, 62:062201, 2021. doi:10.1063/5.0038838.
- [24] Akash Kundu and Jarosław Adam Miszczak. Qiskit source code for variational fidelity estimation for quantum channels., 2021. doi:10.5281/zenodo.5804364.
- [25] Ryan LaRose, Arkin Tikku, Étude O’Neel-Judy, Łukasz Cincio, and Patrick J Coles. Variational quantum state diagonalization. *npj Quantum Inf.*, 5(1):1–10, 2019. doi:10.1038/s41534-019-0167-6.
- [26] Debbie W Leung. Choi’s proof as a recipe for quantum process tomography. *J. Math. Phys.*, 44(2):528–533, 2003. doi:10.1063/1.1518554.
- [27] Yeong Cherng Liang, Yu Hao Yeh, Paulo E.M.F. Mendonça, Run Yan Teh, Margaret D. Reid, and Peter D. Drummond. Quantum fidelity measures for mixed states. *Rep. Prog. Phys.*, 82(7):076001, 2019. doi:10.1088/1361-6633/ab1ca4.
- [28] Yiping Lu, Jun Yan Sim, Jun Suzuki, Berthold Georg Englert, and Hui Khoon Ng. Direct estimation of minimum gate fidelity. *Phys. Rev. A*, 102(2):022410, 2020. doi:10.1103/PhysRevA.102.022410.
- [29] Jarrod R. McClean, Jonathan Romero, Ryan Babbush, and Alán Aspuru-Guzik. The theory of variational hybrid quantum-classical algorithms. *New J. Phys.*, 18(2):23023, 2016. doi:10.1088/1367-2630/18/2/023023.
- [30] Jarosław A. Miszczak. Singular value decomposition and matrix reorderings in quantum information theory. *Int. J. Mod. Phys. C*, 22(9):897–918, 2011. doi:10.1142/S0129183111016683.
- [31] Jarosław A. Miszczak. Generating and using truly random quantum states in Mathematica. *Comput. Phys. Commun.*, 183(1):118–124, 2012. doi:10.1016/j.cpc.2011.08.002.
- [32] Jarosław A. Miszczak, Zbigniew Puchała, Paweł Horodecki, Armin Uhlmann, and Karol Życzkowski. Sub- and super-fidelity as bounds for quantum fidelity. *Quantum Inform. Comput.*, 9(1&2):0103–0130, 2009.
- [33] Jarosław Adam Miszczak. Employing online quantum random number generators for generating truly random quantum states in Mathematica. *Comput. Phys. Commun.*, 184:257–258, 2013. doi:10.1016/j.cpc.2012.08.012.
- [34] Jarosław A. Miszczak, Zbigniew Puchała, and Piotr Gawron. QI package for Mathematica, aug 2020. URL <https://zenodo.org/record/3988569>.
- [35] Masoud Mohseni, Peter Read, Hartmut Neven, Sergio Boixo, Vasil Denchev, Ryan Babbush, Austin Fowler, Vadim Smelyanskiy, and John Martinis. Commercialize quantum technologies in five years. *Nature*, 543(7644):171–174, 2017. doi:10.1038/543171a.
- [36] Nikolaj Moll, Panagiotis Barkoutsos, Lev S. Bishop, Jerry M. Chow, Andrew Cross, Daniel J. Egger, Stefan Filipp, Andreas Fuhrer, Jay M. Gambetta, Marc Ganzhorn, Abhinav Kandala, Antonio Mezzacapo, Peter Müller, Walter Riess, Gian Salis, John Smolin, Ivano Tavernelli, and Kristan Temme. Quantum optimization using variational algorithms on near-term quantum devices. *Quantum Sci. Technol.*, 3(3):030503, 2018. doi:10.1088/2058-9565/aab822.
- [37] Marco Piani and John Watrous. All entangled states are useful for channel discrimination. *Phys. Rev. Lett.*, 102(25):250501, 2009. doi:10.1103/PhysRevLett.102.250501.
- [38] John Preskill. Quantum computing in the NISQ era and beyond. *Quantum*, 2:79, 2018. doi:10.22331/q-2018-08-06-79.
- [39] Zbigniew Puchała and Jarosław A. Miszczak. Bound on trace distance based on super-fidelity. *Phys. Rev. A*, 79:024302, 2009. doi:10.1103/PhysRevA.79.024302.
- [40] Zbigniew Puchała, Jarosław A. Miszczak, Piotr Gawron, and Bartłomiej Gardas. Experimentally feasible measures of distance between quantum operations. *Quantum Inf. Process.*, 10(1), 2011. doi:10.1007/s11128-010-0166-1.
- [41] Michał Sedláč and Mario Ziman. Unambiguous compar-

- ison of unitary channels. *Phys. Rev. A*, 79(1):012303, 2009. doi:10.1103/PhysRevA.79.012303.
- [42] Jun Yan Sim, Jun Suzuki, Berthold Georg Englert, and Hui Khooon Ng. User-specified random sampling of quantum channels and its applications. *Phys. Rev. A*, 101(2):022307, 2020. doi:10.1103/PhysRevA.101.022307.
- [43] Akira Sone, Marco Cerezo, Jacob L Beckey, and Patrick J Coles. Generalized measure of quantum Fisher information. *Phys. Rev. A*, 104(6):062602, 2021. doi:10.1103/PhysRevA.104.062602.
- [44] Le Phuc Thinh, Philippe Faist, Jonas Helsen, David Elkouss, and Stephanie Wehner. Practical and reliable error bars for quantum process tomography. *Phys. Rev. A*, 99(5):052311, 2019. doi:10.1103/PhysRevA.99.052311.
- [45] Armin Uhlmann. The 'transition probability' in the state space of a  $*$ -algebra. *Rep. Math. Phys.*, 9(273), 1976. doi:10.1016/0034-4877(76)90060-4.
- [46] Guoming Wang and Mingsheng Ying. Unambiguous discrimination among quantum operations. *Phys. Rev. A*, 73(4):042301, 2006. doi:10.1103/PhysRevA.73.042301.