

Tensor Completion via Tensor Networks with a Tucker Wrapper

Yunfeng Cai, Ping Li

Cognitive Computing Lab
Baidu Research

No.10 Xibeiwang East Road, Beijing 100193, China
10900 NE 8th St. Bellevue, Washington 98004, USA
{caiyunfeng, liping11}@baidu.com

Abstract

In recent years, low-rank tensor completion (LRTC) has received considerable attention due to its applications in image/video inpainting, hyperspectral data recovery, etc. With different notions of tensor rank (e.g., CP, Tucker, tensor train/ring, etc.), various optimization based numerical methods are proposed to LRTC. However, tensor network based methods have not been proposed yet. In this paper, we propose to solve LRTC via tensor networks with a Tucker wrapper. Here by ‘‘Tucker wrapper’’ we mean that the outermost factor matrices of the tensor network are all orthonormal. We formulate LRTC as a problem of solving a system of nonlinear equations, rather than a constrained optimization problem. A two-level alternative least square method is then employed to update the unknown factors. The computation of the method is dominated by tensor matrix multiplications and can be efficiently performed. Also, under proper assumptions, it is shown that with high probability, the method converges to the exact solution at a linear rate. Numerical simulations show that the proposed algorithm is comparable with state-of-the-art methods.

1 Introduction

Tensors are multi-dimensional arrays, which are generalizations of vectors and matrices. Tensors are natural tools for the representation of high dimensional data. For example, EEG signal is a third tensor (time \times frequency \times electrodes); a color video is a fourth-order tensor (width \times height \times 3 \times time). Tensors and their decompositions nowadays become increasingly popular and become fundamental tools to deal with high dimensional data. We refer the readers to [2, 22, 9, 31, 32] for tensors, their decompositions and applications.

Due to the data acquisition process and/or outliers, values can be missing in data. People have great interests in inferring the missing values (e.g., recommender system). However, there are infinitely many ways to fill in the missing values without further assumptions. It is commonly assumed that the high dimensional data lie in a low dimensional manifold. (For example, in a recommendation system, it is commonly believed that users’ behaviors are dictated by a few common factors.) Upon such an assumption, people may learn the low dimensional manifold from the observed data, then infer the missing values. In current literature for tensor completion, the low dimensional manifold is represented by a ‘‘low rank’’ tensor decomposition. Tensor rank differs from matrix rank dramatically (e.g., a real-valued tensor may have different tensor ranks over \mathbb{R} and \mathbb{C} ; the best low rank approximation of a high order tensor may not exist), and it’s the cornerstone of all methods for LRTC (low-rank tensor completion).

Mathematically, the LRTC problem can be formulated as the following optimization problem:

$$\min_{\mathcal{X}} \text{rank}_*(\mathcal{X}), \quad \text{subject to} \quad \Pi_{\Omega}(\mathcal{X}) = \Pi_{\Omega}(\mathcal{T}), \quad (1)$$

where $\text{rank}_*(\cdot)$ denotes a specific type of tensor rank, Ω stores the indices of the observed entries, and Π_{Ω} picks the entries of a tensor with entries’ indices in Ω . With different notations of tensor rank, various methods are proposed to solve LRTC. First, tensor has a CP decomposition (CPD) [7, 13, 15], and the

tensor CP rank. However, the determination of the CP rank is NP-hard [14]. Thus in practice the CP rank is usually treated as a parameter that can be tuned. Several CP rank based methods are proposed in last two decades, e.g., INDAFAC [35], CP-WOPT [1], BPTF [42], STC [24]. Second, tensors has Tucker decomposition/high-order SVD (HOSVD) [38, 39] and the Tucker/multi-linear rank. Based on such a decomposition, many numerical methods are proposed. To name a few, pTucker [8], MRTF [19], geomCG [23], Tmac [43], FaLRTC/HaLRTC [27], Square Deal [28]. Tensors also have other decompositions and related rank definitions, e.g., tensor train (TT) [29] and TT rank [16], tensor ring (TR) and TR rank [49], t-SVD and tubal-rank [20], the related methods includes [4, 11, 12, 21, 44, 45, 48], etc. Among the various numerical methods for LRTC, some of them have theoretical guarantees for exact recovery under proper assumptions, e.g., Jain and Oh [18], Liu and Moitra [26], Yuan and Zhang [46], Mu *et al.* [28], Xia and Yuan [41], Zhang and Aeron [47]. We refer the readers to a recent survey [34] for a comprehensive overview of LRTC.

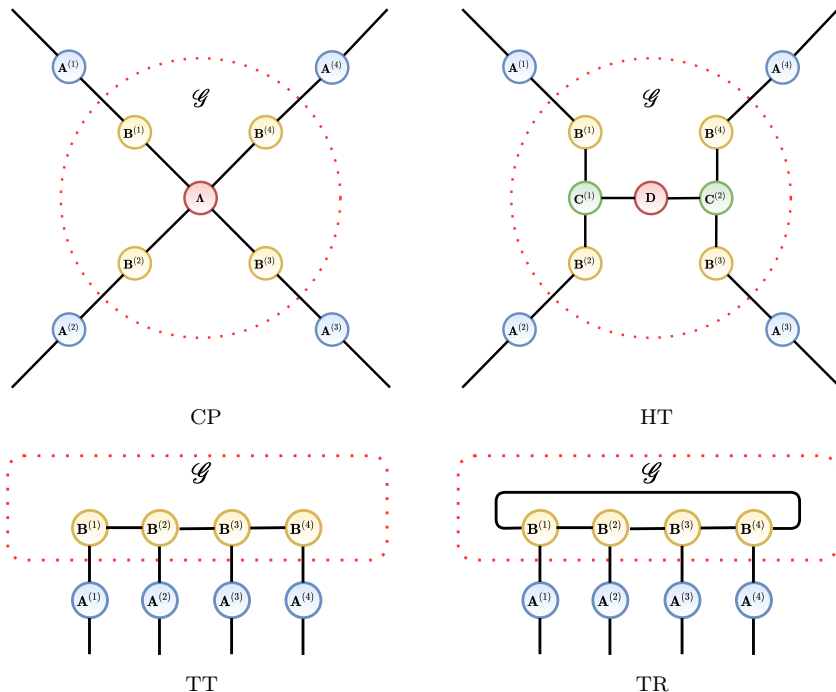

Figure 1: A fourth-order tensor network with a Tucker wrapper: canonical polyadic (CP), Hierarchical Tucker (HT), tensor train (TT) and tensor ring (TR), the weights of all edges are omitted for simplicity.

To the best of the authors’ knowledge, existing (popular) methods for LRTC are all optimization based. And perhaps, due to the difficulty for finding an appropriate $\text{rank}_*(\cdot)$ for tensor networks (TN), (which plays the role of the nuclear norm for matrix), optimization based methods have not been proposed for LRTC based on TN. In this paper, we adopt a TN model with a Tucker wrapper, or equivalently, a Tucker/HOSVD model with the core tensor having a TN structure, see Figure 1 for illustrations, where the tensor diagram notation [5] is adopted. Unfamiliar readers may refer to Figure 2 first. What’s more, we formulate the LRTC problem as a problem solving a system of nonlinear equations (SNLE), rather than a constrained optimization problem as in (1). Then we propose a two-level alternative least square method to solve the SNLE. Under a “low rank” assumption, that is, the outermost factor matrices are low rank and the core tensor can be represented by a TN with a small number of parameters, we show that with high probability, the method converges to the exact solution at a linear rate. Finally, numerical simulations show the merits of the method.

The rest of this paper is organized as follows. In Section 2, we present some preliminary results. In Section 3, we formulate the LRTC problem as a problem of solving a system of nonlinear equations and present an algorithm to solve it. The convergence analysis of the algorithm is then presented in Section 4. Numerical simulations are provided in Section 5. Concluding remarks are given in Section 6.

Notations In this paper, we use lowercase letters to denote scalars (e.g., a, b), boldface lowercase letters to denote column vectors (e.g., \mathbf{a}, \mathbf{b}), boldface uppercase letters to denote matrices (e.g., \mathbf{A}, \mathbf{B}), and boldface calligraphic letters to denote tensors (e.g., \mathcal{A}, \mathcal{B}). The symbol \otimes denotes the Kronecker product. The operation $\text{vec}(\mathbf{X})$ denotes the vectorization of the matrix \mathbf{X} formed by stacking the columns of \mathbf{X} into a single column vector. The identity matrix of order N is denoted by \mathbf{I}_N . For a (rectangular) matrix $\mathbf{A} \in \mathbb{R}^{m \times n}$, its singular values are denoted by $\sigma_1(\mathbf{A}) \geq \dots \geq \sigma_{\min\{m, n\}}(\mathbf{A}) \geq 0$, and $\sigma_{\min\{m, n\}}(\mathbf{A})$ is usually denoted by $\sigma_{\min}(\mathbf{A})$. The rank of \mathbf{A} is denoted by $\text{rank}(\mathbf{A})$. The 2-norm and Frobenius norm are denoted by $\|\cdot\|$ and $\|\cdot\|_F$, respectively. The range space of \mathbf{A} , which is the subspace spanned by the column vectors of \mathbf{A} , is denoted by $\mathcal{R}(\mathbf{A})$.

2 Preliminary

In this section, we present some notations and preliminary results for facilitating of our following discussions.

Canonical Angles Let \mathcal{X}, \mathcal{Y} be two k -dimensional subspaces of \mathbb{R}^n . Let $\mathbf{X}, \mathbf{Y} \in \mathbb{R}^{n \times k}$ be the orthonormal basis matrices of \mathcal{X} and \mathcal{Y} , respectively, i.e.,

$$\mathcal{R}(\mathbf{X}) = \mathcal{X}, \quad \mathbf{X}^T \mathbf{X} = \mathbf{I}_k, \quad \text{and} \quad \mathcal{R}(\mathbf{Y}) = \mathcal{Y}, \quad \mathbf{Y}^T \mathbf{Y} = \mathbf{I}_k.$$

Denote ω_j for $1 \leq j \leq k$ the singular values of $\mathbf{Y}^T \mathbf{X}$ in ascending order, i.e., $\omega_1 \leq \dots \leq \omega_k$. The k canonical angles $\theta_j(\mathcal{X}, \mathcal{Y})$ between \mathcal{X} and \mathcal{Y} are defined by

$$0 \leq \theta_j(\mathcal{X}, \mathcal{Y}) := \arccos \omega_j \leq \frac{\pi}{2}, \quad \text{for } 1 \leq j \leq k.$$

They are in descending order, i.e., $\theta_1(\mathcal{X}, \mathcal{Y}) \geq \dots \geq \theta_k(\mathcal{X}, \mathcal{Y})$. Set

$$\Theta(\mathcal{X}, \mathcal{Y}) = \text{diag}(\theta_1(\mathcal{X}, \mathcal{Y}), \dots, \theta_k(\mathcal{X}, \mathcal{Y})).$$

Notice that if $k = 1$, the canonical angle is nothing but the angle between two vectors. In what follows, we sometimes place a vector or matrix in one or both arguments of $\theta_j(\cdot, \cdot)$ and $\Theta(\cdot, \cdot)$ with the meaning that it is about the subspace spanned by the vector or the column vectors of the matrix argument.

Modal Unfolding Given a tensor $\mathcal{T} \in \mathbb{R}^{I_1 \times \dots \times I_N}$, its mode- n unfolding is an I_n -by- $\prod_{k \neq n} I_k$ matrix, its columns are the mode- n fibers of \mathcal{T} , denoted by $\mathcal{T}_{(n)}$.

Modal Product Given a tensor $\mathcal{T} \in \mathbb{R}^{I_1 \times \dots \times I_N}$ and a matrix $\mathbf{U} \in \mathbb{R}^{J \times I_n}$, the mode- n product of \mathcal{T} and \mathbf{U} is an I_1 -by- \dots -by- I_{n-1} -by- J -by- I_{n+1} -by- \dots -by- I_N tensor, denoted by $\mathcal{T} \times_n \mathbf{U}$. Let $\mathcal{S} = \mathcal{T} \times_n \mathbf{U}$. The mode- n product can be defined via modal unfolding as $\mathcal{S}_{(n)} = \mathbf{U} \mathcal{T}_{(n)}$.

The operation $\mathcal{S} = \mathcal{T} \times_1 \mathbf{A}_1 \cdots \times_N \mathbf{A}_N$ is usually denoted as $\llbracket \mathcal{T}; \mathbf{A}_1, \dots, \mathbf{A}_N \rrbracket$. Furthermore, in such case, it holds the following important equality:

$$\mathcal{S}_{(n)} = \mathbf{A}_n \mathcal{T}_{(n)} (\mathbf{A}_N \otimes \dots \otimes \mathbf{A}_{n+1} \otimes \mathbf{A}_n \otimes \dots \otimes \mathbf{A}_1)^T.$$

High Order SVD (HOSVD) Given an N th tensor $\mathcal{T} \in \mathbb{R}^{I_1 \times \dots \times I_N}$. Let $\mathcal{T}_n = \mathbf{U}_n \mathbf{\Sigma}_n \mathbf{V}_n^T$ for $n = 1, \dots, N$ be the SVDs of the modal unfoldings of \mathcal{T} . Then the HOSVD of \mathcal{T} can be given by

$$\mathcal{T} = \mathcal{S} \times_1 \mathbf{U}_1 \cdots \times_N \mathbf{U}_N = \llbracket \mathcal{S}; \mathbf{U}_1, \dots, \mathbf{U}_N \rrbracket,$$

where $\mathcal{S} = \llbracket \mathcal{S}; \mathbf{U}_1^T, \dots, \mathbf{U}_N^T \rrbracket$ is the core tensor. Furthermore, if the SVDs of $\mathcal{T}_{(n)}$'s are economic (zero singular values of $\mathbf{\Sigma}_n$ are removed, the corresponding left and right singular vectors are also removed from the column vectors of \mathbf{U}_n and \mathbf{V}_n , respectively), then \mathcal{S} will be r_1 -by- \dots -by- r_N , where $r_n = \text{rank}(\mathcal{T}_{(n)})$. In such case, the HOSVD will be referred to as an economic HOSVD. The vector (r_1, \dots, r_N) is the multi-linear rank of \mathcal{T} , denoted by $\text{rank}_n(\mathcal{T})$. In addition, if small singular values of $\mathbf{\Sigma}_n$ are also removed, then one would obtain the truncated HOSVD.

Tucker Decomposition Given an N th tensor $\mathcal{T} \in \mathbb{R}^{I_1 \times \dots \times I_N}$ and a vector $\mathbf{r} \leq \text{rank}_n(\mathcal{T})$ with inequality in at least one component. The Tucker decomposition tries to find a tensor \mathcal{X} such that

$$\min_{\mathcal{X}} \|\mathcal{T} - \mathcal{X}\|_F, \text{ s.t. } \text{rank}_n(\mathcal{X}) = \mathbf{r}. \quad (2)$$

The truncated HOSVD does not solve (2), but provides a good approximation.

Tensor Network and Graph A tensor network aims to represent a high order tensor into a set of lower order (usually 2 or 3) tensors, which are connected sparsely. In such a way, the curse of dimensionality can be greatly alleviated or even avoided. Tensor diagram notation is a simple yet effective way to represent tensor networks, in which a node represents a tensor, an edge between two nodes indicates a contraction between the two connected node tensors in the associated pair of modes, each outgoing edge represents a mode, and the weight above it indicates the size of the mode. For example, in Figure 2, the node with none/one/two/three weighted edges stands for a scalar/a length I vector/an I_1 -by- I_2 matrix/an I_1 -by- I_2 -by- I_3 tensor, two nodes connected by an edge with weight I stands for the inner product of two length I vectors, two nodes with one outgoing edge each and one common edge stand for the multiplication between an I_1 -by- I_2 matrix and an I_2 -by- I_3 matrix.

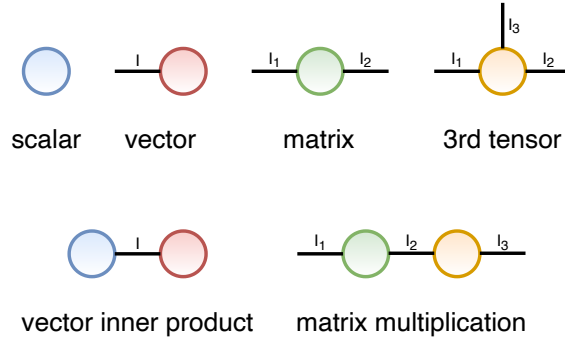

Figure 2: Basic symbols for tensor diagram notations

Simply speaking, a graph is a structure that consists of nodes that may or may not be connected with one another. A graph is undirected if the edge is undirected. A graph is weighted if each of its edges is assigned with a number (weight).

Now we may embed a tensor $\mathcal{T} \in \mathbb{R}^{I_1 \times \dots \times I_N}$ into a weighted and undirected graph \mathbf{G} as follows: for each mode, pick a node from \mathbf{G} and assign the node an outgoing edge with weight I_n . Denote the resultant graph-like structure as \mathbf{G}^+ . We can uniquely construct a TN for a tensor \mathcal{T} from \mathbf{G}^+ since \mathbf{G}^+ is essentially a tensor diagram. So, for any tensor with a TN decomposition, we can rewrite it as:

$$\mathcal{T} \triangleq \mathcal{T}(\mathbf{G}^+(\mathbf{w}, \mathbf{d}), \mathcal{B}) \quad (3)$$

where \mathbf{G}^+ is a tensor diagram constructed from a graph \mathbf{G} , \mathbf{w} is the weight vector for \mathbf{G} (the edges of \mathbf{G} need to be numbered), \mathbf{d} is the weight vector of all outgoing edges, i.e., the dimension of \mathcal{T} , \mathcal{B} is the collection of the node tensors in \mathbf{G} . For example, in Figure 3, \mathcal{T} is a tensor of dimension $10 \times 20 \times 30 \times 40$, $\mathbf{w} = (10, 8, 12, 18, 20, 15)$, $\mathbf{d} = (10, 20, 30, 40)$, \mathcal{B} consists of 5 matrices and 2 order-3 tensors. Note here that modes 3 and 4 are assigned to the same node.

3 Algorithm

In this section, we first motivate the method in Section 3.1, then summarize it in Section 3.2.

3.1 Solving a System of Nonlinear Equations

Let \mathcal{X} have the following TN decomposition with a Tucker wrapper:

$$\mathcal{X} = \llbracket \mathcal{G}(\mathbf{G}^+(\mathbf{w}, \mathbf{d}), \mathcal{B}); \mathbf{A}^{(1)}, \dots, \mathbf{A}^{(N)} \rrbracket, \quad (4)$$

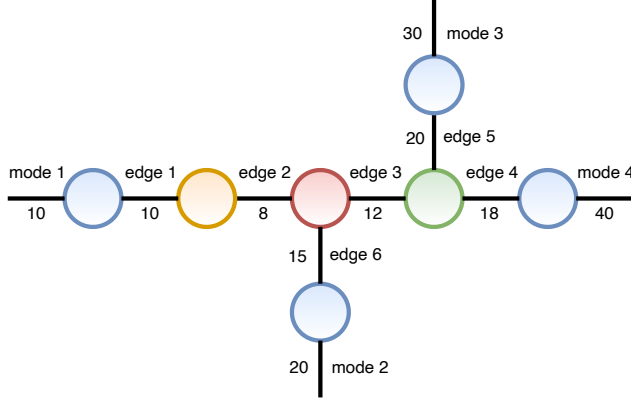

Figure 3: An example for $\mathbf{G}^+(\mathbf{w}, \mathbf{d})$

where $\mathcal{G} = \mathcal{G}(\mathbf{G}^+(\mathbf{w}, \mathbf{d}), \mathcal{B}) \in \mathbb{R}^{r_1 \times \dots \times r_N}$ is the core tensor with $\text{rank}_n(\mathcal{G}) = (r_1, \dots, r_N)$, $\mathbf{G}^+(\mathbf{w}, \mathbf{d})$ and \mathcal{B} are similarly defined as in (3), $\mathbf{A}^{(n)} \in \mathbb{R}^{I_n \times r_n}$ has orthonormal columns for all n . The reason why we add a Tucker wrapper is that the size of the core tensor \mathcal{G} is smaller (in practice much smaller) than that of \mathcal{T} , by instinct, the structure of TNs for \mathcal{G} should be simpler than that for \mathcal{T} , and the parameters of TNs for \mathcal{G} should be much less than that for \mathcal{T} .

Given $\mathbf{G}^+(\mathbf{w}, \mathbf{d})$ and assume \mathcal{X} has the decomposition (4), then

$$\Pi_\Omega(\mathcal{X}) = \Pi_\Omega(\mathcal{T}) \quad (5)$$

is a system of nonlinear equations (SNLE) in $\mathbf{A}^{(n)}$'s and the node tensors in \mathcal{B} . One may use the alternative least square (ALS) method to update $\mathbf{A}^{(n)}$'s and the node tensors in \mathcal{B} in some prescribed order. That is, fix all $\mathbf{A}^{(n)}$'s and all node tensors in \mathcal{B} except one, update the one via minimizing $\|\Pi_\Omega(\mathcal{X}) - \Pi_\Omega(\mathcal{T})\|_F$; update all $\mathbf{A}^{(n)}$'s and the node tensors in \mathcal{B} in some prescribed order until convergence.

In order to update the factor matrices $\mathbf{A}^{(n)}$'s and the node tensors in \mathcal{B} , we need to know $\mathbf{G}^+(\mathbf{w}, \mathbf{d})$, i.e., the tensor diagram (including the weights of all edges). Without knowing any information of $\mathbf{G}^+(\mathbf{w}, \mathbf{d})$, the problem NP-hard. To the best of the authors' knowledge, such a problem is only recently discussed for tensor network decomposition [25], where a genetic meta-algorithm was used, and only the simplest case was treated.

In this paper, to simplify the problem, we assume \mathbf{G}^+ and \mathbf{w} to be known, and we only have a good initial guess for \mathbf{d} . Furthermore, for the sake of a convergence guarantee, we propose to solve the SNLE via a two-level ALS method. Simply put, in the first level, we update $\mathbf{A}^{(n)}$ for $n = 1, 2, \dots, N$; in the second level, we update the node tensors in \mathcal{B} until the core tensor \mathcal{G} converges. Next, we show how to update $\mathbf{A}^{(n)}$'s, the node tensors in \mathcal{B} and the weight vector \mathbf{d} in detail.

Updating the factor matrices $\mathbf{A}^{(n)}$'s Let \mathcal{G}_{t-1} be the current estimation for the core tensor. Assume that we update $\mathbf{A}^{(n)}$ for $n = 1, \dots, N$ one by one, and we are updating $\mathbf{A}^{(n)}$ with $\mathbf{A}^{(1)}, \dots, \mathbf{A}^{(n-1)}$ updated, $\mathbf{A}^{(n+1)}, \dots, \mathbf{A}^{(N)}$ to be updated. Then we denote the current estimations for $\mathbf{A}^{(1)}, \dots, \mathbf{A}^{(n-1)}$ and $\mathbf{A}^{(n+1)}, \dots, \mathbf{A}^{(N)}$ by $\mathbf{A}_t^{(1)}, \dots, \mathbf{A}_t^{(n-1)}$ and $\mathbf{A}_{t-1}^{(n+1)}, \dots, \mathbf{A}_{t-1}^{(N)}$, respectively. In order to update $\mathbf{A}^{(n)}$, we need to solve the following optimization problem:

$$\|\Pi_\Omega([\mathcal{G}_{t-1}; \mathbf{A}_t^{(1)}, \dots, \mathbf{A}_t^{(n-1)}, \mathbf{X}, \mathbf{A}_{t-1}^{(n+1)}, \dots, \mathbf{A}_{t-1}^{(N)}]) - \Pi_\Omega(\mathcal{T})\|_F = \min. \quad (6)$$

Notice that (6) is nothing but a linear least square (LLS) problem, since theoretically it can be rewritten in the form $\|\mathbf{A}\mathbf{x} - \mathbf{b}\|$.

At first glance, the LLS problem has $|\Omega|$ equations and $I_n r_n$ unknowns. A closer examination indicates that the LLS problem can be decoupled into I_n independent smaller LLS problems, that is, to solve \mathbf{X} row-wise. The LLS problem with the i th row of \mathbf{X} as its unknowns, has $\omega_{i,n} \triangleq \{(i_1, \dots, i_N) \in \Omega \mid i_n = i\}$ equations. For simplicity, let us assume $I_1 = \dots = I_N = d$, $r_1 = \dots = r_N = r$, and each entry of \mathcal{T} is

observed independently with probability p . Then we have $\omega_{i,n} \approx pd^{N-1}$, and $\mathbf{X} \in \mathbb{R}^{d \times r}$. So, when solving the LLS problem with a standard direct solver (say the normal equation method), the computational cost for computing one row of \mathbf{X} is $O(pd^{N-1}r^2)$. And updating all $\mathbf{A}_t^{(n)}$ once requires $O(Npd^N r^2)$, which are very expensive when d and N are large. To reduce the computation cost, we may compute a sub-optimal solution instead. For example, we may randomly sample $O(r)$ rows from the coefficient matrix of the LLS problem, then a sub-optimal solution can be obtained from the sampled LLS problem. And the computational cost for updating all $\mathbf{A}^{(n)}$'s can be reduced from $O(Npd^N r^2)$ into $O(Ndr^3)$, which scales linearly with respect to both N and d , and hence, suitable for large scale problems.

In practice, we don't need to compute the exact solution to (6), an approximation is usually sufficient. And to get an approximate solution, one may use the iterative method LSQR [30] to solve \mathbf{X} all at once. In each iteration of LSQR, two matrix vector multiplications (MVPs) are needed, namely, $\mathbf{A}\mathbf{v}$ and $\mathbf{A}^T\mathbf{v}$. For the LLS problem (6), the operation $\mathbf{A}\mathbf{v}$ amounts to the tensor modal product: $\Pi_\Omega(\mathcal{S} \times_n \mathbf{V})$, where $\mathcal{S} = \llbracket \mathcal{G}_{t-1}; \mathbf{A}_t^{(1)}, \dots, \mathbf{A}_t^{(n-1)}, \mathbf{I}, \mathbf{A}_t^{(n+1)}, \dots, \mathbf{A}_t^{(N)} \rrbracket$; and the operation $\mathbf{A}^T\mathbf{v}$ amounts to the multiplication between a sparse matrix and a matrix: $[\Pi_\Omega(\mathcal{V})]_{(n)} \mathcal{S}_{(n)}$. As long as these two MVPs can be efficiently computed, LSQR is preferred, especially for large scale problems. Also, note that the sub-sample idea can also be applied to reduce the computational cost.

Updating the node tensors in \mathcal{B} To update the node tensors in \mathcal{B} , we need to know $\mathcal{G}^+(\mathbf{w}, \mathbf{d})$. For the ease of illustration, we assume that $\mathcal{G}(\mathcal{G}^+(\mathbf{w}, \mathbf{d}), \mathcal{B})$ is in the CPD form, i.e.,

$$\mathcal{G}(\mathcal{G}^+(\mathbf{w}, \mathbf{d}), \mathcal{B}) = \llbracket \mathbf{A}; \mathbf{B}^{(1)}, \dots, \mathbf{B}^{(N)} \rrbracket, \quad (7)$$

where $\mathcal{B} = \{\mathbf{A}, \mathbf{B}^{(1)}, \dots, \mathbf{B}^{(N)}\}$, \mathbf{A} is a diagonal tensor, $\mathbf{B}^{(n)} \in \mathbb{R}^{r_n \times r}$ for $n = 1, \dots, N$, $\mathbf{w} = (r, \dots, r)$, $\mathbf{d} = (r_1, \dots, r_N)$. See the upper left plot in Figure 1 for an illustration.

Let the current estimations for $\mathbf{A}^{(1)}, \dots, \mathbf{A}^{(N)}$ be $\mathbf{A}_t^{(1)}, \dots, \mathbf{A}_t^{(N)}$, respectively. We can update the node tensors in \mathcal{B} , that is, $\mathbf{A}, \mathbf{B}^{(1)}, \dots, \mathbf{B}^{(N)}$, by solving

$$\|\Pi_\Omega(\llbracket \mathcal{G}; \mathbf{A}_t^{(1)}, \dots, \mathbf{A}_t^{(N)} \rrbracket) - \Pi_\Omega(\mathcal{T})\|_F = \min, \quad (8)$$

where \mathcal{G} is given by (7). Again, the ALS method can be used. Similar to the ALS method for computing CPD, we may update $\mathbf{B}^{(n)}$'s as follows: fix all $\mathbf{B}^{(n)}$'s but one (say $\mathbf{B}^{(1)}$), then (8) becomes an LLS problem. Similar to the way we find an approximate solution for $\mathbf{A}^{(n)}$'s ($\mathbf{B}^{(n)}$'s can no longer be computed row by row), we can obtain a new estimation for $\mathbf{B}^{(1)}$, denoted by $\widehat{\mathbf{B}}^{(1)}$. Let the length of the i th column vector of $\widehat{\mathbf{B}}^{(1)}$ be γ_i , for $i = 1, \dots, r_1$. Then we set $\mathbf{B}^{(1)} = \widehat{\mathbf{B}}^{(1)}\mathbf{\Gamma}^{-1}$, $\mathbf{A} = \mathbf{A} \times_1 \mathbf{\Gamma}$, where $\mathbf{\Gamma} = \text{diag}(\gamma_1, \dots, \gamma_{r_1})$. Such a normalization step makes the all columns of $\mathbf{B}^{(n)}$'s be of unit length, which is commonly adopted in the ALS method for computing CPD. We will perform the ALS method for updating the node tensors in \mathcal{B} until the core tensor \mathcal{G} converges.¹

For general $\mathcal{G}(\mathcal{G}^+(\mathbf{w}, \mathbf{d}), \mathcal{B})$, the ALS method can also be used to update the node tensors in \mathcal{B} . And the iteration continues until \mathcal{G} converges.

Updating the weight vector \mathbf{d} Recall that \mathbf{d} is nothing but the multi-linear rank of \mathcal{T} . We recommend an over-estimated initial guess to begin with. In each iteration, after updating \mathcal{G} , we expect to observe rank deficiency in the modal unfolding matrices of \mathcal{G} . So, when small singular values occur in $\mathcal{G}_{(n)}$, we may remove them and update the multi-linear rank correspondingly. To be precise, let $\mathcal{G}_t \in \mathbb{R}^{r_t^{(1)} \times \dots \times r_t^{(N)}}$ be the current estimation for the core tensor, the economic SVD of $[\mathcal{G}_t]_{(n)}$ be $\mathcal{G}_{(n)} = \mathbf{U}^{(n)}\mathbf{\Sigma}^{(n)}\mathbf{V}^{(n)}$, for $n = 1, \dots, N$, where $\mathbf{U}^{(n)}$ is orthogonal, $\mathbf{V}^{(n)}$ is orthonormal, and $\mathbf{\Sigma}^{(n)} = \text{diag}(\sigma_1^{(n)}, \dots, \sigma_{r_t^{(n)}}^{(n)})$. Then for all n , we find the smallest $\sigma_{s_n}^{(n)}$ such that $\sigma_1^{(n)} \leq \kappa_n \sigma_{s_n}^{(n)}$, where $\kappa_n \geq 1$ is a prescribed number. Next, update $r_t^{(n)} = s_n$, $\mathbf{U}^{(n)} = \mathbf{U}_{(:,1:s_n)}^{(n)}$, $\mathbf{A}_t^{(n)} = \mathbf{A}_t^{(n)}\mathbf{U}^{(n)}$ for all n , and update $\mathcal{G}_t = \llbracket \mathcal{G}_t; (\mathbf{U}^{(1)})^T, \dots, (\mathbf{U}^{(N)})^T \rrbracket$. After that, the size of \mathcal{G}_t becomes smaller, the condition number of $[\mathcal{G}_t]_{(n)}$ is no more than κ_n , and $\mathbf{A}^{(n)}$'s have orthonormal columns (thus still consist of a Tucker wrapper).

¹Since the TN decomposition of tensors has some natural indeterminacies (scaling, permutation, etc.), we should not expect all node tensors converge individually.

Remark 1. In [6], the authors used a similar idea to transform the robust matrix completion problem into a problem of solving a system of nonlinear equations. Due to the differences between high order tensors and matrices, the approach here differs from the aforementioned one in some obvious aspects, e.g., the multilinear rank vs. the matrix rank, N orthonormal factor matrices vs. two, etc. Besides that, the major difference between the two approaches is that we impose a TN structure for the core tensor. As a result, a two-level ALS method is needed rather than a “one-level” ALS method for the matrix completion problem. The reason why we impose a TN structure is that: first, it is expensive to compute the core tensor as a whole since $\prod_n \text{rank}([\mathcal{G}]_n)$ can be large though $\text{rank}([\mathcal{G}]_n)$ is assumed to be small; second, a TN structure of the core tensor may improve the performance of the method in practical problems, see Example 2 in Section 5.

3.2 Algorithm Details

Before we present the detailed algorithm, we need to explain some notations. Recall \mathbf{G}^+ , for each mode, pick a node from \mathbf{G} and assign the node an outgoing edge with certain weight. To be specific, assume that all nodes of \mathbf{G} are numbered; For each mode- n , we assign it to node k_n ; and the k_n node tensor $\mathcal{B}^{(k_n)}$ is connected with the mode- n outgoing edge through its m_n -mode. The detailed algorithm is summarized in Algorithm 1. Some implementation details follow.

Algorithm 1 Two level ALS method (TLALS)

Input:

- 1: $\Pi_\Omega(\mathcal{T})$: the observed tensor;
- 2: \mathbf{G}^+ : a graph with N outgoing edges;
- 3: \mathbf{w} : the weight vector for all edges in \mathbf{G} ;
- 4: $\mathbf{d}_0 = (r_1^{(0)}, \dots, r_N^{(0)})$: the initial weight vector for all outgoing edges, and $\mathbf{d}_0 \geq \text{rank}_n(\mathcal{T})$ (entrywise);
- 5: $(\kappa_1, \dots, \kappa_N)$: the condition number upper bound vector;
- 6: **tol** : the tolerance.

Output:

- 7: $\mathbf{A}_t^{(n)} \in \mathbb{R}^{I_n \times r_t^{(n)}}$,s: the orthonormal factors;
 - 8: $\mathcal{G}_t = \mathcal{G}(\mathbf{G}^+(\mathbf{w}, \mathbf{d}_t), \mathcal{B}_t)$: the core tensor, where $\mathbf{d}_t = (r_t^{(1)}, \dots, r_t^{(N)})$, $\mathcal{B}_t = \{\mathcal{B}_t^{(k)}\}_{k=1}^K$. Here K is the number of nodes in \mathbf{G} , $\mathcal{B}_t^{(k)}$'s are the estimations for the node tensors in \mathbf{G} .
 - 9: $t \leftarrow 0$;
 - 10: Initialize $\mathbf{A}_t^{(n)} \in \mathbb{R}^{I_n \times r_t^{(n)}}$ and $\mathcal{B}_t = \{\mathcal{B}_t^{(k)}\}_{k=1}^K$;
 - 11: $\mathcal{G}_t \leftarrow \mathcal{G}(\mathbf{G}^+(\mathbf{w}, \mathbf{d}_t), \mathcal{B}_t)$;
 - 12: $\tau_t \leftarrow \|\Pi_\Omega([\mathcal{G}_t; \mathbf{A}_t^{(1)}, \dots, \mathbf{A}_t^{(N)}]) - \mathcal{T}\|_F$;
 - 13: **while** $\tau_t > \text{tol}$ **do**
 - 14: $t \leftarrow t + 1$;
 - 15: **for** $n = 1, \dots, N$ **do**
 - 16: Solve (6) for \mathbf{X} ;
 - 17: Compute $[\mathbf{Q}, \mathbf{R}] = \text{QR}(\mathbf{X})$;
 - 18: $\mathbf{A}_t^{(n)} \leftarrow \mathbf{Q}$, $\mathcal{B}_t^{(k_n)} \leftarrow \mathcal{B}_{t-1}^{(k_n)} \times_{m_n} \mathbf{R}$;
 - 19: **end for**
 - 20: Update $\mathcal{B}_t = \{\mathcal{B}_t^{(k)}\}_{k=1}^K$ via ALS method;
 - 21: $\mathcal{G}_t \leftarrow \mathcal{G}(\mathbf{G}^+(\mathbf{w}, \mathbf{d}_t), \mathcal{B}_t)$;
 - 22: **for** $n = 1, \dots, N$ **do**
 - 23: Compute $[\mathbf{U}^{(n)}, \Sigma^{(n)}, \sim] = \text{SVD}([\mathcal{G}_t]_{(n)})$, where $\Sigma^{(n)} = \text{diag}(\sigma_1^{(n)}, \dots, \sigma_{r_{t-1}^{(n)}}^{(n)})$;
 - 24: $r_t^{(n)} \leftarrow |\{j \mid \sigma_j^{(n)} \leq \kappa_n \sigma_j^{(n)}\}|$;
 - 25: $\mathbf{U}_t^{(n)} \leftarrow \mathbf{U}_{(:,1:r_t^{(n)})}^{(n)}$, $\mathbf{A}_t^{(n)} \leftarrow \mathbf{A}_t^{(n)} \mathbf{U}^{(n)}$, $\mathcal{B}_t^{(k_n)} \leftarrow \mathcal{B}_{t-1}^{(k_n)} \times_{m_n} (\mathbf{U}^{(n)})^T$;
 - 26: **end for**
 - 27: $\mathcal{G}_t \leftarrow \mathcal{G}(\mathbf{G}^+(\mathbf{w}, \mathbf{d}_t), \mathcal{B}_t)$;
 - 28: $\tau_t \leftarrow \|\Pi_\Omega([\mathcal{G}_t; \mathbf{A}_t^{(1)}, \dots, \mathbf{A}_t^{(N)}]) - \mathcal{T}\|_F$.
 - 29: **end while**
-

Line 10 Inspired by the initialization of the matrix completion problem, we initialize the factor matrices $\mathbf{A}_0^{(n)}$'s and the core tensor \mathcal{G}_0 via the best rank- (r_1, \dots, r_N) approximation of $\frac{\prod_n I_n}{|\Omega|} \Pi_\Omega(\mathcal{T})$, which can be computed by the ALS method [3]. Then the node tensors $\mathcal{B}_0^{(k)}$'s can be initialized via minimizing $\|\mathcal{G}(\mathbf{G}^+(\mathbf{w}, \mathbf{d}_t), \mathcal{B}_t) - \mathcal{G}_0\|_F$. A large tolerance, say 10^{-2} , is usually sufficient, for both $\mathbf{A}_0^{(n)}$'s and $\mathcal{B}_0^{(k)}$'s.

Line 17 Here we only need to compute an ‘‘economic’’ QR decomposition, in which \mathbf{Q} has orthonormal columns, \mathbf{R} is an upper triangular square matrix.

Line 20 For the sake of a guaranteed convergence, we need to update the node tensors until the core tensor converges. In practice, an approximation for the core tensor is sufficient.

Line 23 Here we only need to compute an ‘‘economic’’ SVD, in which only the singular values and the corresponding left singular vectors are required.

Line 24 The singular values are truncated such that the condition number of $[\mathcal{G}_t]_{(n)}$ is no more than κ_n .

Lines 11, 21 and 27 Assume that the contractions for the TN can be efficiently computed. Then it is possible to perform the algorithm without formulating the core tensor \mathcal{G}_t explicitly.

4 Convergence Analysis

In this section, we study the convergence of Algorithm 1. We will follow the notations in Algorithm 1 and we will also make the following assumptions.

A1 Each entry of \mathcal{T} is observed independently with probability p .

A2 The tensor \mathcal{T} can be factorized as in (4).

A3 The factor matrix $\mathbf{A}_t^{(n)}$ satisfies an incoherence condition with parameter μ_n : $\|\mathbf{A}_t^{(n)}\|_{2,\infty} \leq \sqrt{\frac{\mu_n r_n}{I_n}}$, for all n and t .

A4 There exist two positive constants γ, Γ such that

$$\gamma \leq \frac{\min_{\mathcal{X}} \|\Pi_\Omega(\llbracket \mathcal{X}; \mathbf{A}_t^{(1)}, \dots, \mathbf{A}_t^{(N)} \rrbracket) - \Pi_\Omega(\mathcal{T})\|_F}{\tau_t} \leq \Gamma,$$

where τ_t is the same as in Algorithm 1.

A5 $r_t^{(n)} \equiv r_n$, i.e., the multi-linear rank estimations are all correctly revealed.

Several remarks on the assumptions follow.

(a) **A1-A2** are standard for tensor completion [34].

(b) Recall that solving the SNLE (5) as described in Algorithm 1 is equivalent to the minimization of $\|\Pi_\Omega(\mathcal{X}) - \Pi_\Omega(\mathcal{T})\|_F^2$. If we add a regularizer $\lambda \sum_n \|\mathbf{A}^{(n)}\|_F^2$ and still apply Algorithm 1 (of course, with small modifications), the computed $\|\mathbf{A}_t^{(n)}\|_{2,\infty}$ becomes smaller. The larger λ is, the smaller $\|\mathbf{A}_t^{(n)}\|_{2,\infty}$ is. So, we may declare that assumption **A3** is only slightly stronger than the standard assumption that $\mathbf{A}^{(n)}$ satisfies an incoherence condition.

(c) Assumption **A4** essentially requires that \mathbf{G}^+ together with the weight vector \mathbf{w} have a good capacity for the representation for the minimizer of the numerator in **A4**. Such a requirement is quite natural. In fact, for sufficiently large \mathbf{w} , $\mathcal{G}(\mathbf{G}^+(\mathbf{w}, \mathbf{d}_t), \mathcal{B}_t)$ can represent any tensor of size $r_t^{(1)}$ -by- \dots -by- $r_t^{(N)}$. And in such case, $\gamma = \Gamma = 1$.

(d) From Algorithm 1, we know that for each n , $r_1^{(n)} \geq r_2^{(n)} \geq \dots \geq 1$. Thus, $r_t^{(n)}$ must converge. We assume **A5** for the ease of the convergence analysis.

To motivate the convergence analysis, in Section 4.1, we sketch a proof for the convergence when all entries of \mathcal{T} are observed. Then the convergence results for the partial observation case are given in Section 4.2.

4.1 Full Observation Case

The difference between the full and partial observation cases is the LLS problems in Algorithm 1. Note that for an LLS problem $\|\mathbf{A}\mathbf{x} - \mathbf{b}\|$, sampling the rows uniformly yields a smaller LLS problem $\|\mathbf{P}_\Omega \mathbf{A}\mathbf{x} - \mathbf{P}_\Omega \mathbf{b}\|$, where \mathbf{P}_Ω a 0-1 matrix which selects the indices in Ω . Its solution $\hat{\mathbf{x}}_* = (\mathbf{P}_\Omega \mathbf{A})^\dagger \mathbf{P}_\Omega \mathbf{b}$ is the solution to $\|\mathbf{A}\mathbf{x} - \mathbf{b} - (\mathbf{A}\hat{\mathbf{x}}_* - \mathbf{b})\|$, which is a perturbed LLS problem for $\|\mathbf{A}\mathbf{x} - \mathbf{b}\|$. So, to motivate the convergence analysis for the partial observation case, for the full observation case, instead of assuming **A2**, we assume $\mathcal{T} = \llbracket \mathcal{G}_*; \mathbf{A}_*^{(1)}, \dots, \mathbf{A}_*^{(N)} \rrbracket + \mathcal{E}$, where \mathcal{E} is a noise tensor.

First, note that under the assumption **A5**, lines 24 to 29 of Algorithm 1 can be skipped. Next, we consider Lines 18 and 22. Let

$$\begin{aligned} \mathbf{M}_{t,n} &= \mathbf{A}_{t-1}^{(N)} \otimes \dots \otimes \mathbf{A}_{t-1}^{(n+1)} \otimes \mathbf{A}_t^{(n-1)} \otimes \dots \otimes \mathbf{A}_t^{(1)}, \\ \mathbf{M}_{*,n} &= \mathbf{A}_*^{(N)} \otimes \dots \otimes \mathbf{A}_*^{(n+1)} \otimes \mathbf{A}_*^{(n-1)} \otimes \dots \otimes \mathbf{A}_*^{(1)}. \end{aligned} \quad (9)$$

Then (6) with all entries observed is equivalent to

$$\|\mathbf{X}[\mathcal{G}_{t-1}]_{(n)} \mathbf{M}_{t,n}^\top - \mathcal{T}_{(n)}\| = \min.$$

Therefore, **X** Algorithm 1 can be given by

$$\begin{aligned} \mathbf{X} &= \mathcal{T}_{(n)} \mathbf{M}_{t,n} [\mathcal{G}_{t-1}]_{(n)}^\dagger \\ &= (\mathbf{A}_*^{(n)} [\mathcal{G}_*]_{(n)} \mathbf{M}_{*,n}^\top + \mathcal{E}_{(n)}) \mathbf{M}_{t,n} [\mathcal{G}_{t-1}]_{(n)}^\dagger. \end{aligned} \quad (10)$$

When $\|\mathcal{E}\|_F$ is small, the right hand side of (10) almost lies in $\mathcal{R}(\mathbf{A}_*^{(n)})$, thus, we expect $\|\sin \Theta(\mathbf{X}, \mathbf{A}_*^{(n)})\|$ to be small. In particular, when $\mathcal{E} = 0$, it holds that $\|\sin \Theta(\mathbf{X}, \mathbf{A}_*^{(n)})\| = 0$, i.e., updating $\mathbf{A}_{t-1}^{(n)}$ once will find the the range space $\mathcal{R}(\mathbf{A}_*^{(n)})$. So, it is not surprising to conclude that $\mathcal{R}(\mathbf{A}_t^{(n)})$ is a better approximation of $\mathcal{R}(\mathbf{A}_*^{(n)})$ than $\mathcal{R}(\mathbf{A}_{t-1}^{(n)})$ when \mathcal{E} is sufficiently small.

Similarly, we may also show that when \mathcal{E} is sufficiently small, \mathcal{G}_t is a better approximation of \mathcal{G}_* than \mathcal{G}_{t-1} . In summary, one iteration of Algorithm 1 gives better approximations for $\mathbf{A}_*^{(n)}$'s and \mathcal{G}_* . In particular, when there is no noise, one iteration of algorithm 1 will return a solution of LRTC.

4.2 Partial Observation Case

In this section, we present the convergence of Algorithm 1 when the entries of \mathcal{T} are partially observed.

The next two lemmas establish the bridges between the partial and full observation cases.

Lemma 4.1. Denote $J_n = \prod_{k \neq n} I_k$, $J_{\min} = \min_k J_k$, $g_{\max} = \max_k \|\mathcal{T}_{(k)}\|$, $\sin \theta_t = \max_{1 \leq k \leq N} \|\sin \Theta(\mathbf{A}_t^{(k)}, \mathbf{A}_*^{(k)})\|$.

Let

$$\begin{aligned} \mathcal{L}(\mathbf{X}) &= \llbracket \mathcal{G}_{t-1}; \mathbf{A}_t^{(1)}, \dots, \mathbf{A}_t^{(n-1)}, \mathbf{X}, \mathbf{A}_{t-1}^{(n+1)}, \dots, \mathbf{A}_{t-1}^{(N)} \rrbracket, \\ \mathbf{X}_{\text{opt}} &= \operatorname{argmin} \|\mathcal{L}_t(\mathbf{X}) - \mathcal{T}\|_F, \\ \widetilde{\mathbf{X}}_{\text{opt}} &= \operatorname{argmin} \|\Pi_\Omega(\mathcal{L}_t(\mathbf{X})) - \Pi_\Omega(\mathcal{T})\|_F. \end{aligned}$$

Assume **A1-A3** and **A5**, $p \in [4p_*, 0.5]$ with $p_* = \frac{10}{3} (\log(2 \prod_{k=1}^N I_k) + 5) \max_n \prod_{k \neq n} \frac{\mu_k r_k}{I_k}$ and $\sigma_{\min}([\mathcal{G}_t]_{(n)}) \geq g_{\min}$ for all n and t . Also assume

$$\|\sin \Theta(\mathbf{M}_{t,n} [\mathcal{G}_{t-1}]_{(n)}^\top, \mathbf{M}_{*,n} [\mathcal{G}_*]_{(n)}^\top)\| \leq C \sin \theta_{t-1}, \quad (11)$$

where $\mathbf{M}_{t,n}, \mathbf{M}_{*,n}$ are defined in (9), $C > 0$ is a constant.² Then with probability (w.p.) $\geq 1 - 2/J_{\min}^{10+\log \alpha}$, it holds that

$$\|\widetilde{\mathbf{X}}_{\text{opt}} - \mathbf{X}_{\text{opt}}\| \leq \frac{6g_{\max}(C_1 + C_2)}{g_{\min}} \sqrt{\frac{\alpha}{p}} \sin \theta_{t-1},$$

where $C_1 = C \frac{g_{\max}}{g_{\min}} \max_n \left\{ \sqrt{\frac{7\mu_n r_n}{I_n}} \prod_{k \neq n} \sqrt{\mu_k r_k} \right\}$, and $C_2 = C \max_n \sqrt{\frac{\mu_n r_n J_n}{I_n}}$.

²To understand the constant C and why assumption (11) holds, please see Appendix.

Lemma 4.1 tells that the distance between the partial observation solution $\widetilde{\mathbf{X}}_{\text{opt}}$ and the full observation solution \mathbf{X}_{opt} is upper bounded: the larger p is, the smaller the distance is; the smaller θ_{t-1} is, the smaller the distance is.

Lemma 4.2. Let $\phi_t = \|\llbracket \mathbf{X}_{\text{opt}}; \mathbf{A}_t^{(1)}, \dots, \mathbf{A}_t^{(N)} \rrbracket - \mathcal{T}\|_F$, $\psi_t = \|\llbracket \widetilde{\mathbf{X}}_{\text{opt}}; \mathbf{A}_t^{(1)}, \dots, \mathbf{A}_t^{(N)} \rrbracket - \mathcal{T}\|_F$, where

$$\begin{aligned}\mathbf{X}_{\text{opt}} &= \operatorname{argmin} \|\llbracket \mathbf{X}; \mathbf{A}_t^{(1)}, \dots, \mathbf{A}_t^{(N)} \rrbracket - \mathcal{T}\|_F, \\ \widetilde{\mathbf{X}}_{\text{opt}} &= \operatorname{argmin} \|\Pi_{\Omega}(\llbracket \mathbf{X}; \mathbf{A}_t^{(1)}, \dots, \mathbf{A}_t^{(N)} \rrbracket) - \mathcal{T}\|_F.\end{aligned}$$

Assume **A1**, **A3**, $p \in [4p_*, 0.5]$ with p_* being the same as in Lemma 4.1. Then w.p. ≥ 0.99 , it holds that

$$\phi_t \leq \psi_t \leq 3/\sqrt{2} \phi_t.$$

Lemma 4.2 tells that the partial observation solution $\widetilde{\mathbf{X}}_{\text{opt}}$ is as good as the full observation solution \mathbf{X}_{opt} , in term of the residual. With the help of the above two lemmas, we are able to prove our main theorem.

Theorem 4.3. Follow the notations in Lemma 4.1. Assume **A1-A5**, $p \in [4p_*, 0.5]$, and

$$\mu = \frac{3}{\sqrt{2}} \frac{\|\mathcal{T}\|_F}{g_{\min}} \frac{[(1 + \sin \theta_0)^N - 1]}{\sin \theta_0} \times \frac{6g_{\max}(C_1 + C_2)\sqrt{\frac{\alpha}{p}}}{g_{\min} - \sqrt{2}\kappa\psi_0 - 6g_{\max}(C_1 + C_2)\sqrt{\frac{\alpha}{p}}\sin \theta_0} < \frac{\gamma}{7\Gamma}.$$

Then

$$\|\llbracket \mathbf{G}_t; \mathbf{A}_t^{(1)}, \dots, \mathbf{A}_t^{(N)} \rrbracket - \mathcal{T}\|_F \leq \frac{7\mu\Gamma}{\gamma} \|\llbracket \mathbf{G}_{t-1}; \mathbf{A}_{t-1}^{(1)}, \dots, \mathbf{A}_{t-1}^{(N)} \rrbracket - \mathcal{T}\|_F, \quad w.h.p.$$

In other words, Algorithm 1 converges to the exact solution at a linear rate, w.h.p.

Remark 2. Let \mathbf{G} be a single node. Then we are in fact solving LRTC problem with the multi-linear rank. Let $I_1 = \dots = I_N = d$, $\operatorname{rank}_n(\mathcal{T}) = (r, \dots, r)$. Then $p_*d^N = O(Nr^{N-1}d \log d)$, i.e., we need at least $O(Nr^{N-1}d \log d)$ observations. When $N = 2$, we need $O(rd \log d)$ observations, which is theoretical optimal. When $N = 3$, we need $O(r^2d \log d)$ observations. Compared with existing multi-linear rank based methods, Algorithm 1 needs less observations, see Table 1 below.

Table 1: Bound for $|\Omega|$ for exact recovery – the case for 3rd tensor of size $d \times d \times d$

Method	Bound for $ \Omega $
SNN [28, 36]	$O(rd^2)$
Square Deal [28]	$O(rd^2)$
GoG [41]	$O(r^{\frac{7}{2}}d^{\frac{3}{2}}\log^{\frac{7}{2}}d + r^7d\log^6d)$
TLALS (ours)	$O(r^2d \log d)$

5 Numerical Experiment

In this section, we present several numerical examples to illustrate the performance of our method.

Example 1. In this example, we let \mathbf{G} have a single node. We compare our algorithm with two multi-linear rank based tensor completion methods, namely, geomCG [23] and Tmac [43].³ The MATLAB codes for geomCG and Tmac are obtained from Github.⁴

We generate the tensor as $\mathcal{T} = \llbracket \mathbf{G}; \mathbf{A}^{(1)}, \dots, \mathbf{A}^{(N)} \rrbracket$, where $\mathbf{A}^{(n)} \in \mathbb{R}^{I \times r_n}$, $\mathbf{G} \in \mathbb{R}^{r_1 \times \dots \times r_N}$, and their entries are *i.i.d.* from the standard normal distribution. And each entry of \mathcal{T} is observed independently with probability p . We perform the tests under the following settings:

³According to [33], Tmac ranked No.1 among 10 tensor completion methods over SBI data.

⁴<https://github.com/andrewssobral/mctc4bmi>

1. $I = (50, 50, 50)$, $R = (10, 10, 10)$, $p = 0.1, 0.2, 0.3$;

1. $I = (50, 50, 50)$, $p = 0.2$, $R = (r, r, r)$ for $r = 5, 10, 20$;

2. $I = (50, 50, 50)$, $R = (r, r, r)$ for $r = 5, 10, \dots, 25$, $p = 0.05, 0.10, \dots, 0.4$.

We use the residual $\tau_t = \frac{\|\Pi_{\Omega}([\mathcal{G}_t; \mathbf{A}_t^{(1)}, \dots, \mathbf{A}_t^{(N)}]) - \mathcal{T}\|_F}{\|\Pi_{\Omega}(\mathcal{T})\|_F}$ to measure the quality of the computed solution.

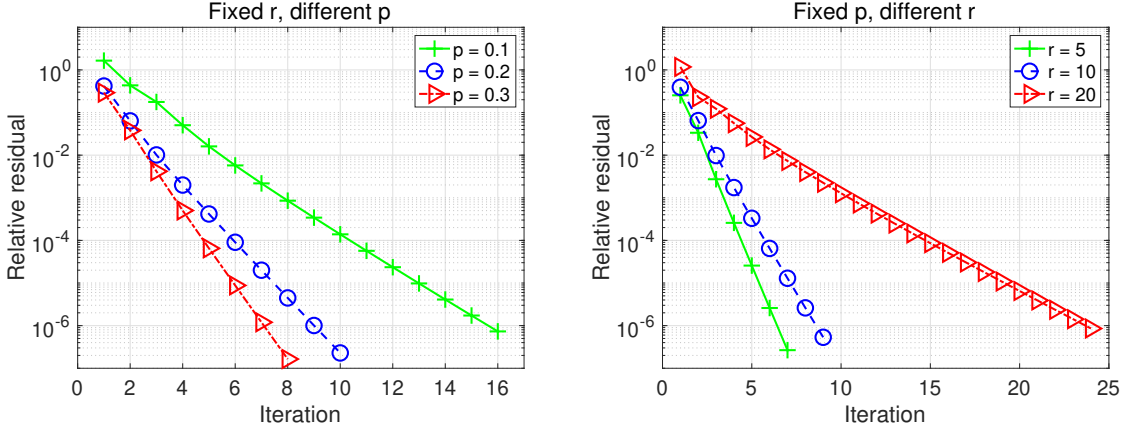

Figure 4: Relative residual vs. iteration number, left: setting 1, right: setting2

In Figure 4, we plot the results of our method under settings 1 and 2. From the left (setting 1) and right (setting 2) figures, we can see that in all cases, τ_t converges linearly; the larger p is, the larger the convergence rate is; the smaller r is, the larger the convergence rate is.

Under setting 3, we set the tolerance for all three methods to 10^{-4} . On the output of each method, if $\tau_t < 10^{-2}$, we take it as a success. For every pair of (r, p) , we perform all three methods 20 times. The phase transitions for three methods are reported in Figure 5. We can see that to ensure a successful recovery, our method permits a smaller p and a larger r , compared with geomCG and Tmac.

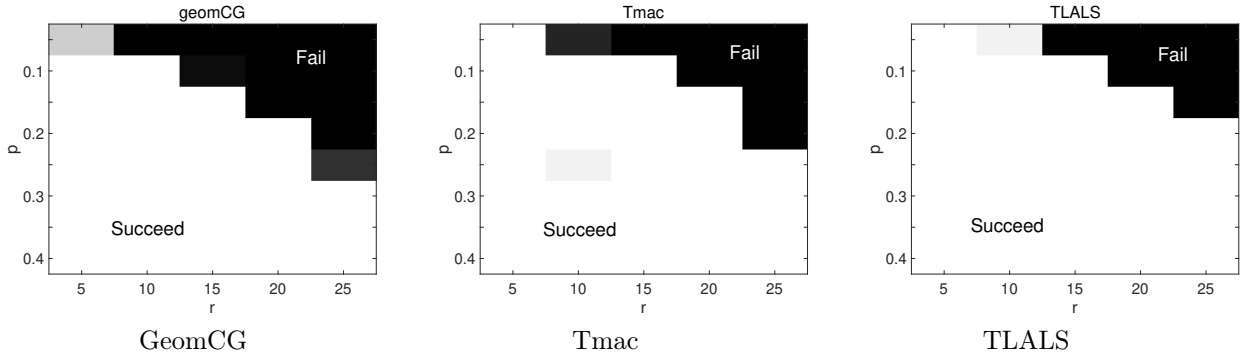

Figure 5: Phase transition of successful recovery for three methods

Example 2. In this example, we show the effectiveness of the TN with a Tucker wrapper. For the color image “onion.png” (available in MATLAB), which is a third-order tensor of dimension $135 \times 198 \times 3$, we reshape it into a fifth-order tensor of dimension $15 \times 9 \times 18 \times 11 \times 3$. Each entry of the tensor is observed with a probability of $p = 0.5$. The original and observed figures are shown in Figure 6. We perform our method with three different tensor diagrams, the recovered figures are shown in Figure 7. We can see that compared with simple Tucker, Tucker with TT and TR improves the quality of the recovered figures.

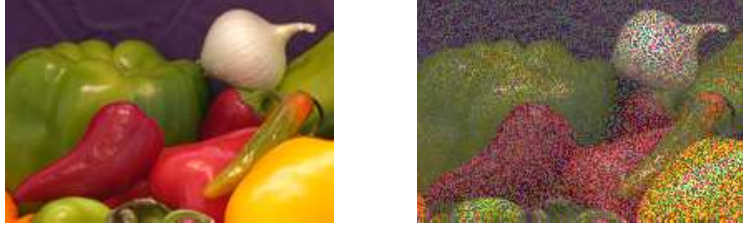

Figure 6: Original and observed figures, left: original, right:observed

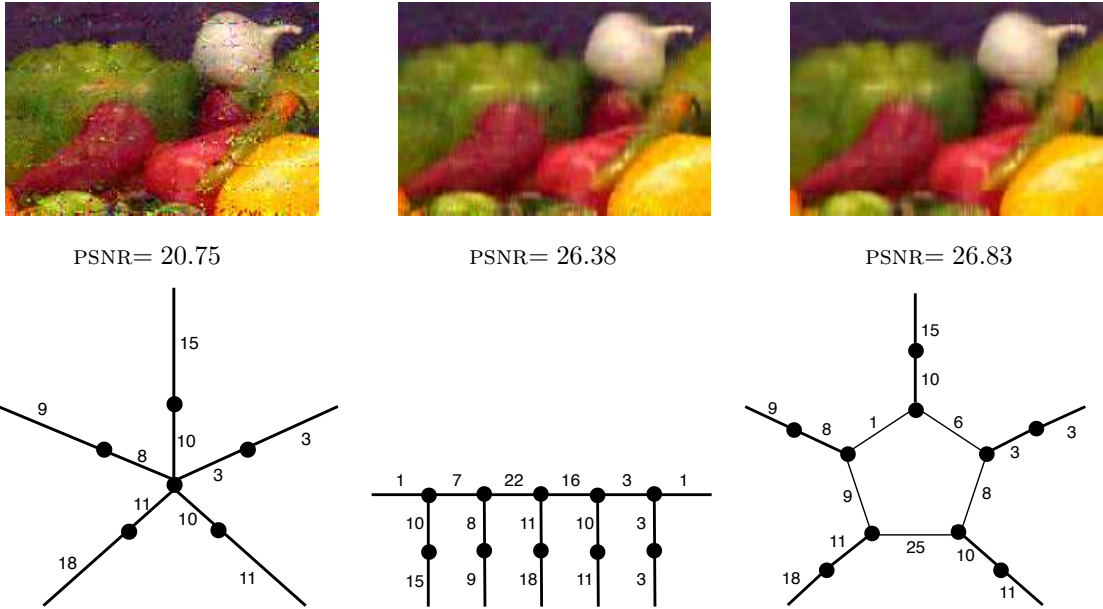

Figure 7: Recovered figure, PSNR and the corresponding tensor diagram, from left to right: Tucker, Tucker + tensor train, Tucker + tensor ring

6 Conclusion

This paper considers the LRTC problem via tensor networks with a Tucker wrapper. The problem is formulated as a system of nonlinear equations, and a two-level ALS method is proposed to solve it. Under proper assumptions, it is shown that our method converges to the exact solution at a linear rate, *w.h.p.* Also, to ensure convergence, our method requires less number of observations compared with existing multi-linear rank based tensor completion methods. Numerical simulations show that the method is comparable with state-of-the-art algorithms.

The topology structure search problem remains still open: how to find the tensor diagram to achieve the best performance for real-world data? More studies are needed to that end.

References

- [1] Evrim Acar, Daniel M Dunlavy, Tamara G Kolda, and Morten Mørup. Scalable tensor factorizations for incomplete data. *Chemometrics and Intelligent Laboratory Systems*, 106(1):41–56, 2011.
- [2] Evrim Acar and Bülent Yener. Unsupervised multiway data analysis: A literature survey. *IEEE Trans. Knowl. Data Eng.*, 21(1):6–20, 2009.
- [3] Brett W. Bader, Tamara G. Kolda, et al. Matlab tensor toolbox version 3.1. Available online, June 2019.
- [4] Johann A. Bengua, Ho N. Phien, Hoang Duong Tuan, and Minh N. Do. Efficient tensor completion for color image and video recovery: Low-rank tensor train. *IEEE Trans. Image Process.*, 26(5):2466–2479, 2017.
- [5] Jacob C Bridgeman and Christopher T Chubb. Hand-waving and interpretive dance: an introductory course on tensor networks. *Journal of Physics A: Mathematical and Theoretical*, 50(22):223001, 2017.
- [6] Yunfeng Cai and Ping Li. Solving the robust matrix completion problem via a system of nonlinear equations. In *Proceedings of the 23rd International Conference on Artificial Intelligence and Statistics (AISTATS)*, pages 4162–4172, Online [Palermo, Sicily, Italy], 2020.
- [7] J Douglas Carroll and Jih-Jie Chang. Analysis of individual differences in multidimensional scaling via an n-way generalization of “eckart-young” decomposition. *Psychometrika*, 35(3):283–319, 1970.
- [8] Wei Chu and Zoubin Ghahramani. Probabilistic models for incomplete multi-dimensional arrays. In *Proceedings of the Twelfth International Conference on Artificial Intelligence and Statistics (AISTATS)*, pages 89–96, Clearwater Beach, FL, 2009.
- [9] Andrzej Cichocki, Danilo P. Mandic, Lieven De Lathauwer, Guoxu Zhou, Qibin Zhao, Cesar F. Caiafa, and Anh Huy Phan. Tensor decompositions for signal processing applications: From two-way to multiway component analysis. *IEEE Signal Process. Mag.*, 32(2):145–163, 2015.
- [10] James W Demmel. *Applied Numerical Linear Algebra*. SIAM, Philadelphia, PA, 1997.
- [11] Meng Ding, Ting-Zhu Huang, Xi-Le Zhao, and Tian-Hui Ma. Tensor completion via nonconvex tensor ring rank minimization with guaranteed convergence. *arXiv:2005.09674*, 2020.
- [12] Lars Grasedyck, Melanie Kluge, and Sebastian Krämer. Variants of alternating least squares tensor completion in the tensor train format. *SIAM J. Sci. Comput.*, 37(5), 2015.
- [13] Richard A Harshman. Foundations of the parafac procedure: Models and conditions for an " explanatory" multimodal factor analysis. 1970.
- [14] Johan Håstad. Tensor rank is np-complete. *J. Algorithms*, 11(4):644–654, 1990.
- [15] Frank L Hitchcock. The expression of a tensor or a polyadic as a sum of products. *Journal of Mathematics and Physics*, 6(1-4):164–189, 1927.
- [16] Masaaki Imaizumi, Takanori Maehara, and Kohei Hayashi. On tensor train rank minimization : Statistical efficiency and scalable algorithm. In *Advances in Neural Information Processing Systems (NIPS)*, pages 3930–3939, Long Beach, CA, 2017.
- [17] Prateek Jain and Praneeth Netrapalli. Fast exact matrix completion with finite samples. In *Proceedings of The 28th Conference on Learning Theory (COLT)*, pages 1007–1034, Paris, France, 2015.
- [18] Prateek Jain and Sewoong Oh. Provable tensor factorization with missing data. In *Advances in Neural Information Processing Systems (NIPS)*, pages 1431–1439, Montreal, Canada, 2014.

- [19] Alexandros Karatzoglou, Xavier Amatriain, Linas Baltrunas, and Nuria Oliver. Multiverse recommendation: n-dimensional tensor factorization for context-aware collaborative filtering. In *Proceedings of the 2010 ACM Conference on Recommender Systems (RecSys)*, pages 79–86, Barcelona, Spain, 2010.
- [20] Misha E Kilmer and Carla D Martin. Factorization strategies for third-order tensors. *Linear Algebra Appl.*, 435(3):641–658, 2011.
- [21] Ching-Yun Ko, Kim Batselier, Luca Daniel, Wenjian Yu, and Ngai Wong. Fast and accurate tensor completion with total variation regularized tensor trains. *IEEE Trans. Image Process.*, 29:6918–6931, 2020.
- [22] Tamara G. Kolda and Brett W. Bader. Tensor decompositions and applications. *SIAM Rev.*, 51(3):455–500, 2009.
- [23] Daniel Kressner, Michael Steinlechner, and Bart Vandereycken. Low-rank tensor completion by riemannian optimization. *BIT Numerical Mathematics*, 54(2):447–468, 2014.
- [24] Akshay Krishnamurthy and Aarti Singh. Low-rank matrix and tensor completion via adaptive sampling. In *Advances in Neural Information Processing Systems (NIPS)*, pages 836–844, Lake Tahoe, NV, 2013.
- [25] Chao Li and Sun Sun. Evolutionary topology search for tensor network decomposition. In *Proceedings of the 37th International Conference on Machine Learning (ICML)*, 2020.
- [26] Allen Liu and Ankur Moitra. Tensor completion made practical. In *Advances in Neural Information Processing Systems (NeurIPS)*, 2020.
- [27] Ji Liu, Przemyslaw Musialski, Peter Wonka, and Jieping Ye. Tensor completion for estimating missing values in visual data. *IEEE Trans. Pattern Anal. Mach. Intell.*, 35(1):208–220, 2013.
- [28] Cun Mu, Bo Huang, John Wright, and Donald Goldfarb. Square deal: Lower bounds and improved relaxations for tensor recovery. In *Proceedings of the 31th International Conference on Machine Learning (ICML)*, pages 73–81, Beijing, China, 2014.
- [29] Ivan V. Oseledets. Tensor-train decomposition. *SIAM J. Sci. Comput.*, 33(5):2295–2317, 2011.
- [30] Christopher C. Paige and Michael A. Saunders. LSQR: an algorithm for sparse linear equations and sparse least squares. *ACM Trans. Math. Softw.*, 8(1):43–71, 1982.
- [31] Evangelos E. Papalexakis, Christos Faloutsos, and Nicholas D. Sidiropoulos. Tensors for data mining and data fusion: Models, applications, and scalable algorithms. *ACM Trans. Intell. Syst. Technol.*, 8(2):16:1–16:44, 2017.
- [32] Nicholas D. Sidiropoulos, Lieven De Lathauwer, Xiao Fu, Kejun Huang, Evangelos E. Papalexakis, and Christos Faloutsos. Tensor decomposition for signal processing and machine learning. *IEEE Trans. Signal Process.*, 65(13):3551–3582, 2017.
- [33] Andrews Sobral and El-hadi Zahzah. Matrix and tensor completion algorithms for background model initialization: A comparative evaluation. *Pattern Recognit. Lett.*, 96:22–33, 2017.
- [34] Qingquan Song, Hancheng Ge, James Caverlee, and Xia Hu. Tensor completion algorithms in big data analytics. *ACM Trans. Knowl. Discov. Data*, 13(1):6:1–6:48, 2019.
- [35] Giorgio Tomasi and Rasmus Bro. Parafac and missing values. *Chemometrics and Intelligent Laboratory Systems*, 75(2):163–180, 2005.
- [36] Ryota Tomioka, Taiji Suzuki, Kohei Hayashi, and Hisashi Kashima. Statistical performance of convex tensor decomposition. In *Advances in Neural Information Processing Systems (NIPS)*, pages 972–980, Granada, Spain, 2011.
- [37] Joel A. Tropp. An introduction to matrix concentration inequalities. *Found. Trends Mach. Learn.*, 8(1-2):1–230, 2015.

- [38] Ledyard R Tucker. Implications of factor analysis of three-way matrices for measurement of change. *Problems in measuring change*, 15:122–137, 1963.
- [39] Ledyard R Tucker. Some mathematical notes on three-mode factor analysis. *Psychometrika*, 31(3):279–311, 1966.
- [40] Per-Åke Wedin. Perturbation theory for pseudo-inverses. *BIT Numerical Mathematics*, 13(2):217–232, 1973.
- [41] Dong Xia and Ming Yuan. On polynomial time methods for exact low-rank tensor completion. *Found. Comput. Math.*, 19(6):1265–1313, 2019.
- [42] Liang Xiong, Xi Chen, Tzu-Kuo Huang, Jeff G. Schneider, and Jaime G. Carbonell. Temporal collaborative filtering with bayesian probabilistic tensor factorization. In *Proceedings of the SIAM International Conference on Data Mining (SDM)*, pages 211–222, Columbus, OH, 2010.
- [43] Yangyang Xu, Ruru Hao, Wotao Yin, and Zhixun Su. Parallel matrix factorization for low-rank tensor completion. *arXiv preprint arXiv:1312.1254*, 2013.
- [44] Longhao Yuan, Qibin Zhao, and Jianting Cao. Completion of high order tensor data with missing entries via tensor-train decomposition. In *Proceedings of the 24th International Conference on Neural Information Processing (ICONIP)*, pages 222–229, Guangzhou, China, 2017.
- [45] Longhao Yuan, Qibin Zhao, Lihua Gui, and Jianting Cao. High-order tensor completion via gradient-based optimization under tensor train format. *Signal Process. Image Commun.*, 73:53–61, 2019.
- [46] Ming Yuan and Cun-Hui Zhang. Incoherent tensor norms and their applications in higher order tensor completion. *IEEE Trans. Inf. Theory*, 63(10):6753–6766, 2017.
- [47] Zemin Zhang and Shuchin Aeron. Exact tensor completion using t-svd. *IEEE Trans. Signal Process.*, 65(6):1511–1526, 2017.
- [48] Zemin Zhang, Gregory Ely, Shuchin Aeron, Ning Hao, and Misha Elena Kilmer. Novel methods for multilinear data completion and de-noising based on tensor-svd. In *Proceedings of the 2014 IEEE Conference on Computer Vision and Pattern Recognition (CVPR)*, pages 3842–3849, Columbus, OH, 2014.
- [49] Qibin Zhao, Guoxu Zhou, Shengli Xie, Liqing Zhang, and Andrzej Cichocki. Tensor ring decomposition. *arXiv:1606.05535*, 2016.

Appendix

7 Preliminary Lemmas

In this section, we give preliminary lemmas that will be frequently used in subsequent proofs. Firstly, the following lemma is fundamental for canonical angle, and can be easily verified via definition.

Lemma 7.1. *Let $[\mathbf{U}, \mathbf{U}_c]$ and $[\mathbf{V}, \mathbf{V}_c]$ be two orthogonal matrices with $\mathbf{U}, \mathbf{V} \in \mathbb{R}^{n \times k}$. Then*

$$\|\sin \Theta(\mathbf{U}, \mathbf{V})\| = \|\mathbf{U}_c^T \mathbf{V}\| = \|\mathbf{U}^T \mathbf{V}_c\| = \|(I - \mathbf{U}\mathbf{U}^T)\mathbf{V}\| = \|(I - \mathbf{V}\mathbf{V}^T)\mathbf{U}\| = \|\mathbf{U}\mathbf{U}^T - \mathbf{V}\mathbf{V}^T\|.$$

The next lemma is the well-known Weyl theorem, which gives the perturbation bound for singular values.

Lemma 7.2. *[10, Corollary 5.1] For two matrices $\mathbf{A}, \tilde{\mathbf{A}} \in \mathbb{C}^{m \times n}$, it holds*

$$|\sigma_j(\tilde{\mathbf{A}}) - \sigma_j(\mathbf{A})| \leq \|\mathbf{A} - \tilde{\mathbf{A}}\|, \quad \forall j.$$

Lemma 7.3. *[17, Lemmas 8,10] Let $\mathbf{A} \in \mathbb{R}^{m \times n}$ with $m \geq n$. Suppose Ω is obtained by sampling each entry of \mathbf{A} with probability $p \in [\frac{1}{4m}, 0.5]$. Then w.p. $\geq 1 - 1/m^{10+\log \alpha}$, it holds*

$$\left\| \frac{1}{p} \Pi_{\Omega}(\mathbf{A}) - \mathbf{A} \right\| \leq \frac{6\sqrt{\alpha m}}{\sqrt{p}} \|\mathbf{A}\|_{\max}.$$

Lemma 7.4. *[37, Corollary 6.1.2] Let $\mathbf{S}_1, \dots, \mathbf{S}_n$ be independent random matrices with common dimension $d_1 \times d_2$, and assume that each matrix has uniformly bounded deviation from its mean:*

$$\|\mathbf{S}_k - \mathbb{E}(\mathbf{S}_k)\| \leq L, \quad \text{for each } k = 1, \dots, n.$$

Let $\mathbf{Z} = \sum_{k=1}^n \mathbf{S}_k$, $v(\mathbf{Z})$ denote the matrix variance statistic of the sum:

$$\begin{aligned} v(\mathbf{Z}) &= \max\{\|\mathbb{E}[(\mathbf{Z} - \mathbb{E}(\mathbf{Z}))(\mathbf{Z} - \mathbb{E}(\mathbf{Z}))^T]\|, \|\mathbb{E}[(\mathbf{Z} - \mathbb{E}(\mathbf{Z}))^T(\mathbf{Z} - \mathbb{E}(\mathbf{Z}))]\|\} \\ &= \max\{\|\mathbb{E}[\sum_{k=1}^n (\mathbf{S}_k - \mathbb{E}(\mathbf{S}_k))(\mathbf{S}_k - \mathbb{E}(\mathbf{S}_k))^T]\|, \|\mathbb{E}[\sum_{k=1}^n (\mathbf{S}_k - \mathbb{E}(\mathbf{S}_k))^T(\mathbf{S}_k - \mathbb{E}(\mathbf{S}_k))]\|\}. \end{aligned}$$

Then for all $t \geq 0$, it holds that

$$\mathbb{P}\{\|\mathbf{Z} - \mathbb{E}(\mathbf{Z})\| \geq t\} \leq (d_1 + d_2) \cdot \exp\left(\frac{-t^2/2}{v(\mathbf{Z}) + Lt/3}\right).$$

Lemma 7.5. *Let $\mathbf{A} \in \mathbb{R}^{n \times r}$ have orthonormal columns and $\|\mathbf{A}\|_{2,\infty} \leq \sqrt{\frac{\mu r}{n}}$. Assume $p \geq 4p'$ with $p' = \frac{10}{3}(\log 2n + 5)\frac{\mu r}{n}$. Then for any \mathcal{J} that is uniformly drawn from $\{1, \dots, n\}$ with probability p , it holds w.p. ≥ 0.99 that $\sigma_{\min}^2(\mathbf{A}_{(\mathcal{J},:)}) \geq p - \sqrt{pp'}$.*

Proof. Let $\{\delta_k\}_{1 \leq k \leq n}$ be an independent family of BERNOULLI(p) random variables, and $\mathbf{A}^T = [\mathbf{a}_1, \dots, \mathbf{a}_n]$. Denote $\mathbf{W}_k = \delta_k \mathbf{a}_k \mathbf{a}_k^T$, $\mathbf{W} = \sum_{k=1}^n \mathbf{W}_k$. Using $\mathbf{A}^T \mathbf{A} = \mathbf{I}_r$ and $\|\mathbf{L}\|_{2,\infty} \leq \sqrt{\frac{\mu r}{n}}$, by calculations, we have

$$\begin{aligned} \mathbb{E}(\mathbf{W}) &= \sum_k \mathbb{E}(\delta_k) \mathbf{a}_k \mathbf{a}_k^T = p \mathbf{A}^T \mathbf{A} = p \mathbf{I}_r, \\ \mathbb{E}(\mathbf{W}_k) &= \mathbb{E}(\delta_k) \mathbf{a}_k \mathbf{a}_k^T = p \mathbf{a}_k \mathbf{a}_k^T, & \|\mathbf{W}_k - \mathbb{E}(\mathbf{W}_k)\| &= |\delta_k - p| \|\mathbf{a}_k \mathbf{a}_k^T\| < \frac{\mu r}{n}, \\ \|\mathbb{E}[\sum_k (\mathbf{W}_k - \mathbb{E}(\mathbf{W}_k))^2]\| &= \|\sum_k \mathbb{E}[(\delta_k - p)^2] (\mathbf{a}_k \mathbf{a}_k^T)^2\| \leq \frac{p(1-p)\mu r}{n}. \end{aligned}$$

Then by Lemma 7.4, we have

$$\mathbb{P}\{\|\mathbf{W} - p\mathbf{I}_r\| > t\} \leq 2n \exp\left(\frac{-t^2/2}{p(1-p)\mu r/n + \mu r/n \times t/3}\right).$$

Let $t = \sqrt{pp'}$, then the right hand side of the above inequality satisfies

$$\text{RHS} \leq 2n \exp\left(-\frac{1/2pp'}{p\mu r/n + \mu r/n \times 2p/3}\right) = \exp(-5) < 0.01.$$

Therefore, w.p. ≥ 0.99 , it holds $\|\mathbf{W} - p\mathbf{I}_r\| \leq \sqrt{pp'}$. Using Lemma 7.2, we have

$$\sigma_r(\mathbf{W}) \geq p - \sqrt{pp'}, \quad \text{w.p.} \geq 0.99,$$

which completes the proof. \square

Lemma 7.6. Let $\mathbf{a} = [a_1, \dots, a_n]$, $\mathbf{b} = [\delta_1 a_1, \dots, \delta_n a_n]$ be two n -dimensional real vectors, where $\{\delta_k\}_{1 \leq k \leq n}$ is an independent family of BERNOLLI(p) random variables. Assume $p \geq \frac{256}{9} \frac{\|\mathbf{a}\|_{\max}^2}{\|\mathbf{a}\|^2}$. Then w.p. ≥ 0.996 , it holds that $\frac{\sqrt{p}}{2} \|\mathbf{a}\| \leq \|\mathbf{b}\| \leq \frac{\sqrt{7p}}{2} \|\mathbf{a}\|$.

Proof. Let $x_k = (\delta - p)a_k^2$ for $k = 1, \dots, n$, $z = \sum_{k=1}^n x_k$. Then

$$\mathbb{E}(x_k) = 0, \quad |x_k| \leq \|\mathbf{a}\|_{\max}^2, \quad \mathbb{E}(z^2) = \sum_k \mathbb{E}(\delta - p)^2 a_k^4 = p(1-p) \sum_k a_k^4 < p \|a\|_{\max}^2 \|\mathbf{a}\|^2.$$

By Lemma 7.4, we have

$$\mathbb{P}\{|z| > t\} \leq 2 \exp\left(\frac{-t^2/2}{p \|a\|_{\max}^2 \|\mathbf{a}\|^2 + \|\mathbf{a}\|_{\max}^2 \times t/3}\right).$$

Let $t = 4\|\mathbf{a}\|_{\max} \|\mathbf{a}\| \sqrt{p}$, then the right hand side of the above inequality satisfies

$$\text{RHS} \leq 2 \exp\left(-\frac{8p}{p + 4\|a\|_{\max}/\|\mathbf{a}\| \times \sqrt{p}/3}\right) \leq 2 \exp\left(-\frac{8}{1 + 1/4}\right) < 0.004.$$

Therefore, w.p. ≥ 0.996 , it holds $|z| \leq 4\|\mathbf{a}\|_{\max} \|\mathbf{a}\| \sqrt{p}$. Then it follows

$$\begin{aligned} \|\mathbf{b}\|^2 &\leq p\|\mathbf{a}\|^2 + 4\|\mathbf{a}\|_{\max} \|\mathbf{a}\| \sqrt{p} \leq p\|\mathbf{a}\|^2 + \frac{3}{4}p\|\mathbf{a}\|^2 = \frac{7}{4}p\|\mathbf{a}\|^2, \\ \|\mathbf{b}\|^2 &\geq p\|\mathbf{a}\|^2 - 4\|\mathbf{a}\|_{\max} \|\mathbf{a}\| \sqrt{p} \geq p\|\mathbf{a}\|^2 - \frac{3}{4}p\|\mathbf{a}\|^2 = \frac{1}{4}p\|\mathbf{a}\|^2, \end{aligned}$$

completing the proof. \square

8 Proofs of the Main results

Proof of Lemma 4.1

Lemma 4.1. Denote $J_n = \prod_{k \neq n} J_k$, $J_{\min} = \min_k J_k$, $g_{\max} = \max_k \|\mathcal{T}_{(k)}\|$, and $\sin \theta_t = \max_{1 \leq k \leq N} \|\sin \Theta(\mathbf{A}_t^{(k)}, \mathbf{A}_*^{(k)})\|$. Let

$$\begin{aligned} \mathcal{L}(\mathbf{X}) &= \llbracket \mathcal{G}_{t-1}; \mathbf{A}_t^{(1)}, \dots, \mathbf{A}_t^{(n-1)}, \mathbf{X}, \mathbf{A}_{t-1}^{(n+1)}, \dots, \mathbf{A}_{t-1}^{(N)} \rrbracket, \\ \mathbf{X}_{\text{opt}} &= \text{argmin} \|\mathcal{L}_t(\mathbf{X}) - \mathcal{T}\|_F, \\ \tilde{\mathbf{X}}_{\text{opt}} &= \text{argmin} \|\Pi_{\Omega}(\mathcal{L}_t(\mathbf{X})) - \Pi_{\Omega}(\mathcal{T})\|_F. \end{aligned}$$

Assume **A1-A3** and **A5**, $p \in [4p_*, 0.5]$ with $p_* = \frac{10}{3} (\log(2 \prod_{k=1}^N I_k) + 5) \max_n \prod_{k \neq n} \frac{\mu_k r_k}{I_k}$ and $\sigma_{\min}([\mathcal{G}_t]_{(n)}) \geq g_{\min}$ for all n and t . Also assume

$$\|\sin \Theta(\mathbf{M}_{t,n}[\mathcal{G}_{t-1}]_{(n)}^T, \mathbf{M}_{*,n}[\mathcal{G}_*]_{(n)}^T)\| \leq C \sin \theta_{t-1},$$

where $\mathbf{M}_{t,n}, \mathbf{M}_{*,n}$ are defined in (9), $C > 0$ is a constant. Then w.p. $\geq 1 - 2/J_{\min}^{10+\log \alpha}$, it holds that

$$\|\widetilde{\mathbf{X}}_{\text{opt}} - \mathbf{X}_{\text{opt}}\| \leq \frac{6g_{\max}(C_1 + C_2)}{g_{\min}} \sqrt{\frac{\alpha}{p}} \sin \theta_{t-1},$$

where $C_1 = C \frac{g_{\max}}{g_{\min}} \max_n \{\sqrt{\frac{7\mu_n r_n}{I_n}} \prod_{k \neq n} \sqrt{\mu_k r_k}\}$, and $C_2 = C \max_n \sqrt{\frac{\mu_n r_n J_n}{I_n}}$.

Proof. Recall (9). We have

$$\mathbf{X}_{\text{opt}} = \mathbf{A}_*^{(n)}[\mathcal{G}_*]_{(n)} \mathbf{M}_{*,n}^T \mathbf{M}_{t,n}[\mathcal{G}_{t-1}]_{(n)}^\dagger.$$

and $\widetilde{\mathbf{X}}_{\text{opt}}$ is the solution to

$$\|\mathbf{P}_\Omega(\mathbf{X}[\mathcal{G}_{t-1}]_{(n)} \mathbf{M}_{t,n}^T) - \mathbf{P}_\Omega(\mathbf{A}_*^{(n)}[\mathcal{G}_*]_{(n)} \mathbf{M}_{*,n}^T)\| = \min, \quad (12)$$

where \mathbf{P}_Ω picks the entries of the unfolding matrix corresponding to the observed entries in Ω . Set $\mathbf{X} = \mathbf{X}_{\text{opt}} + \mathbf{Y}$ in (12). Since the smallest singular value of the linear operator $\mathbf{P}_\Omega(\cdot [\mathcal{G}_{t-1}]_{(n)} \mathbf{M}_{t,n}^T)$ is positive (can be easily shown via Lemma 7.5) with high probability, we know that $\mathbf{Y} = \widetilde{\mathbf{X}}_{\text{opt}} - \mathbf{X}_{\text{opt}}$ is the solution to

$$\|\mathbf{P}_\Omega(\mathbf{Y}[\mathcal{G}_{t-1}]_{(n)} \mathbf{M}_{t,n}^T) - \mathbf{P}_\Omega(\mathbf{R})\| = \min, \quad (13)$$

where

$$\mathbf{R} = \mathbf{A}_*^{(n)}[\mathcal{G}_*]_{(n)} \mathbf{M}_{*,n}^T (\mathbf{I} - \mathbf{M}_{t,n}[\mathcal{G}_{t-1}]_{(n)}^\dagger [\mathcal{G}_{t-1}]_{(n)} \mathbf{M}_{t,n}^T).$$

On one hand, by calculations, we have

$$\|\mathbf{R}\|_{\max} \stackrel{(a)}{\leq} \sqrt{\frac{\mu_n r_n}{I_n}} g_{\max} \|\sin \Theta(\mathbf{M}_{t,n}[\mathcal{G}_{t-1}]_{(n)}^T, \mathbf{M}_{*,n}[\mathcal{G}_*]_{(n)}^T)\| \stackrel{(b)}{\leq} \sqrt{\frac{\mu_n r_n}{I_n}} g_{\max} C \sin \theta_{t-1}, \quad (14)$$

where (a) uses **A3** and Lemma 7.1, (b) uses (11).

On the other hand, rewrite (13) as I_n independent least square problems:

$$\|\mathbf{e}_i^T \mathbf{Y}[\mathcal{G}_{t-1}]_{(n)} \mathbf{M}_{t,n}^T \mathbf{P}_i^T - \mathbf{e}_i^T \mathbf{R} \mathbf{P}_i^T\| = \min, \quad \text{for } i = 1, \dots, I_n, \quad (15)$$

where \mathbf{P}_i^T picks the observed entries on the i th row of the unfolding matrix.

By calculations, we have w.p. ≥ 0.99 that

$$\begin{aligned} \|\mathbf{e}_i^T \mathbf{Y}\| &= \|\mathbf{e}_i^T \mathbf{R} \mathbf{P}_i^T ([\mathcal{G}_{t-1}]_{(n)} \mathbf{M}_{t,n}^T \mathbf{P}_i^T)^\dagger\| \leq \frac{1}{g_{\min}} \|\mathbf{e}_i^T \mathbf{R} \mathbf{P}_i^T ([\widehat{\mathcal{G}}_{t-1}]_{(n)} \mathbf{M}_{t,n}^T \mathbf{P}_i^T)^\dagger\| \\ &\leq \frac{1}{g_{\min}} \|\mathbf{e}_i^T \mathbf{R} \mathbf{P}_i^T\| \|([\widehat{\mathcal{G}}_{t-1}]_{(n)} \mathbf{M}_{t,n}^T \mathbf{P}_i^T)^\dagger\| \stackrel{(d)}{\leq} \frac{1}{g_{\min} \sqrt{p - \sqrt{pp'}}} \|\mathbf{e}_i^T \mathbf{R} \mathbf{P}_i^T\| \\ &\stackrel{(e)}{\leq} \frac{1}{g_{\min} \sqrt{p/2}} \frac{\sqrt{7p}}{2} \sqrt{\frac{\mu_n r_n}{I_n}} g_{\max} \|\sin \Theta(\mathbf{M}_{t,n}[\mathcal{G}_{t-1}]_{(n)}^T, \mathbf{M}_{*,n}[\mathcal{G}_*]_{(n)}^T)\| \\ &\stackrel{(f)}{\leq} \frac{g_{\max}}{g_{\min}} \sqrt{\frac{7\mu_n r_n}{I_n}} C \sin \theta_{t-1}. \end{aligned} \quad (16)$$

where the row vectors of $[\widehat{\mathcal{G}}_{t-1}]_{(n)}$ and $[\widehat{\mathcal{G}}_*]_{(n)}$ form orthonormal bases for the subspaces spanned by the row vectors of $[\mathcal{G}_{t-1}]_{(n)}$ and $[\mathcal{G}_*]_{(n)}$, respectively, (d) uses Lemma 7.5, $\|\mathbf{M}_{t,n}[\widehat{\mathcal{G}}_{t-1}]_{(n)}^T\|_{2,\infty} \leq \prod_{k \neq n} \sqrt{\frac{\mu_k r_k}{I_k}}$, $p' = \frac{10}{3} (\log 2J_n + 5) \prod_{k \neq n} \frac{\mu_k r_k}{I_k} < p_*$, (e) uses **A3**, Lemma 7.1, Lemma 7.6, (f) uses (11).

By Lemma 7.3, we have w.p. $\geq 1 - 1/J_n^{10+\log \alpha}$ that

$$\frac{1}{p} \mathbf{P}_\Omega(\mathbf{Y}[\mathcal{G}_{t-1}]_{(n)} \mathbf{M}_{t,n}^\top) = \mathbf{Y}[\mathcal{G}_{t-1}]_{(n)} \mathbf{M}_{t,n}^\top + \mathbf{E}, \quad \frac{1}{p} \mathbf{P}_\Omega(\mathbf{R}) = \mathbf{R} + \mathbf{F}, \quad (17)$$

where

$$\begin{aligned} \|\mathbf{E}\| &\leq \frac{6\sqrt{\alpha J_n}}{\sqrt{p}} \|\mathbf{Y}[\mathcal{G}_{t-1}]_{(n)} \mathbf{M}_{t,n}^\top\|_{\max} \leq \frac{6\sqrt{\alpha J_n}}{\sqrt{p}} g_{\max} \|\mathbf{M}_{t,n}\|_{2,\infty} \|\mathbf{Y}\|_{2,\infty} \\ &\stackrel{(g)}{\leq} \frac{6\sqrt{\alpha J_n}}{\sqrt{p}} g_{\max} \prod_{k \neq n} \sqrt{\frac{\mu_k r_k}{I_k}} \frac{g_{\max}}{g_{\min}} \sqrt{\frac{2\mu_n r_n}{I_n p}} C \sin \theta_{t-1} \leq 6g_{\max} C_1 \sqrt{\frac{\alpha}{p}} \sin \theta_{t-1}, \end{aligned} \quad (18)$$

$$\|\mathbf{F}\| \leq \frac{6\sqrt{\alpha J_n}}{\sqrt{p}} \|\mathbf{R}\|_{\max} \stackrel{(h)}{\leq} \frac{6\sqrt{\alpha J_n}}{\sqrt{p}} \sqrt{\frac{\mu_n r_n}{I_n}} g_{\max} C \sin \theta_{t-1} \leq 6g_{\max} C_2 \sqrt{\frac{\alpha}{p}} \sin \theta_{t-1}. \quad (19)$$

Here (g) uses (16) and **A3**, (h) uses (14).

Using (13) and (17), we get

$$\widetilde{\mathbf{X}}_{\text{opt}} - \mathbf{X}_{\text{opt}} = (\mathbf{R} + \mathbf{F} - \mathbf{E}) \mathbf{M}_{t,n} [\mathcal{G}_{t-1}]_{(n)}^\dagger = (\mathbf{F} - \mathbf{E}) \mathbf{M}_{t,n} [\mathcal{G}_{t-1}]_{(n)}^\dagger.$$

Combining it with (18) and (19), we get

$$\|\widetilde{\mathbf{X}}_{\text{opt}} - \mathbf{X}_{\text{opt}}\| \leq (\|\mathbf{F}\| + \|\mathbf{E}\|) \|\mathcal{G}_{t-1}\|_{(n)}^\dagger \leq \frac{6g_{\max}(C_1 + C_2)}{g_{\min}} \sqrt{\frac{\alpha}{p}} \sin \theta_{t-1}. \quad (20)$$

This completes the proof. \square

Proof of Lemma 4.2

Lemma 4.2. Let $\phi_t = \|\mathcal{X}_{\text{opt}}; \mathbf{A}_t^{(1)}, \dots, \mathbf{A}_t^{(N)}\| - \mathcal{T}\|_F$, $\psi_t = \|\widetilde{\mathcal{X}}_{\text{opt}}; \mathbf{A}_t^{(1)}, \dots, \mathbf{A}_t^{(N)}\| - \mathcal{T}\|_F$, where

$$\begin{aligned} \mathcal{X}_{\text{opt}} &= \operatorname{argmin} \|\mathcal{X}; \mathbf{A}_t^{(1)}, \dots, \mathbf{A}_t^{(N)}\| - \mathcal{T}\|_F, \\ \widetilde{\mathcal{X}}_{\text{opt}} &= \operatorname{argmin} \|\Pi_\Omega(\mathcal{X}; \mathbf{A}_t^{(1)}, \dots, \mathbf{A}_t^{(N)}) - \mathcal{T}\|_F. \end{aligned}$$

Assume **A1**, **A3**, $p \in [4p_*, 0.5]$ with p_* being the same as in Lemma 4.1. Then w.p. ≥ 0.99 , it holds

$$\phi_t \leq \psi_t \leq 3/\sqrt{2} \phi_t.$$

Proof. Let $\mathbf{L} = \mathbf{A}_t^{(N)} \otimes \dots \otimes \mathbf{A}_t^{(1)}$. Then \mathbf{L} has orthonormal columns since $\mathbf{A}_t^{(n)}$'s all have orthonormal columns. Using $\|\mathbf{A}_t^{(n)}\|_{2,\infty} \leq \sqrt{\frac{\mu_n r_n}{I_n}}$ (by **A3**), we have $\|\mathbf{L}\|_{2,\infty} \leq \prod_{k=1}^N \sqrt{\frac{\mu_k r_k}{I_k}}$.

Let

$$\begin{aligned} \mathcal{X}_{\text{opt}} &= \operatorname{argmin} \|\mathcal{X}; \mathbf{A}_t^{(1)}, \dots, \mathbf{A}_t^{(N)}\| - \mathcal{T}\|_F, \\ \widetilde{\mathcal{X}}_{\text{opt}} &= \operatorname{argmin} \|\Pi_\Omega(\mathcal{X}; \mathbf{A}_t^{(1)}, \dots, \mathbf{A}_t^{(N)}) - \mathcal{T}\|_F. \end{aligned}$$

Then \mathcal{X}_{opt} and $\widetilde{\mathcal{X}}_{\text{opt}}$ can also be given by

$$\operatorname{vec}(\mathcal{X}_{\text{opt}}) = \operatorname{argmin} \|\mathbf{L} \operatorname{vec}(\mathcal{X}) - \operatorname{vec}(\mathcal{T})\|, \quad \operatorname{vec}(\widetilde{\mathcal{X}}_{\text{opt}}) = \operatorname{argmin} \|\mathbf{P}_\Omega(\mathbf{L} \operatorname{vec}(\mathcal{X}) - \operatorname{vec}(\mathcal{T}))\|.$$

Then by Lemma 7.5, w.p. ≥ 0.99 , it holds that

$$\sigma_{\min}(\mathbf{P}_\Omega \mathbf{L}) \geq \sqrt{p - \sqrt{pp_*}} \geq \sqrt{\frac{p}{2}}. \quad (21)$$

Rewrite $\text{vec}(\mathcal{T}) = \text{vec}(\mathcal{T}_1) + \text{vec}(\mathcal{T}_2)$, where $\text{vec}(\mathcal{T}_1) \in \mathcal{R}(\mathbf{L})$ and $\text{vec}(\mathcal{T}_2) \in \mathcal{R}(\mathbf{L})^\perp$. Then it follows that

$$\begin{aligned}\text{vec}(\mathcal{X}_{\text{opt}}) &= \mathbf{L}^\dagger \text{vec}(\mathcal{T}_1), \\ \text{vec}(\tilde{\mathcal{X}}_{\text{opt}}) &= (\mathbf{P}_\Omega \mathbf{L})^\dagger \mathbf{P}_\Omega \text{vec}(\mathcal{T}_1) + (\mathbf{P}_\Omega \mathbf{L})^\dagger \mathbf{P}_\Omega \text{vec}(\mathcal{T}_2) \\ &\stackrel{(a)}{=} \text{vec}(\mathcal{X}_{\text{opt}}) + (\mathbf{P}_\Omega \mathbf{L})^\dagger \mathbf{P}_\Omega \text{vec}(\mathcal{T}_2),\end{aligned}\tag{22}$$

where (a) uses the fact that $\mathcal{R}(\mathbf{P}_\Omega \text{vec}(\mathcal{T}_1)) \subset \mathcal{R}(\mathbf{P}_\Omega \mathbf{L})$.

By calculations, we get

$$\begin{aligned}\psi_t &= \|\llbracket \tilde{\mathcal{X}}_{\text{opt}}; \mathbf{A}_t^{(1)}, \dots, \mathbf{A}_t^{(N)} \rrbracket - \mathcal{T}\|_F \\ &= \|\mathbf{L} \text{vec}(\tilde{\mathcal{X}}_{\text{opt}}) - \text{vec}(\mathcal{T})\| \\ &= \|\mathbf{L} \text{vec}(\mathcal{X}_{\text{opt}}) - \text{vec}(\mathcal{T}_1) + \mathbf{L}(\mathbf{P}_\Omega \mathbf{L})^\dagger \mathbf{P}_\Omega \text{vec}(\mathcal{T}_2) - \text{vec}(\mathcal{T}_2)\| \\ &= \|\mathbf{L}(\mathbf{P}_\Omega \mathbf{L})^\dagger \mathbf{P}_\Omega \text{vec}(\mathcal{T}_2) - \text{vec}(\mathcal{T}_2)\| \\ &\stackrel{(b)}{=} \sqrt{\|\mathbf{L}(\mathbf{P}_\Omega \mathbf{L})^\dagger \mathbf{P}_\Omega \text{vec}(\mathcal{T}_2)\|^2 + \|\text{vec}(\mathcal{T}_2)\|^2},\end{aligned}$$

where (b) uses $\mathbf{L}(\mathbf{P}_\Omega \mathbf{L})^\dagger \mathbf{P}_\Omega \text{vec}(\mathcal{T}_2) \in \mathcal{R}(\mathbf{L})$, and $\text{vec}(\mathcal{T}_2) \in \mathcal{R}(\mathbf{L})^\perp$. Then it follows that

$$\begin{aligned}\psi_t &\geq \|\text{vec}(\mathcal{T}_2)\| = \phi_t, \\ \psi_t &\stackrel{(c)}{\leq} \sqrt{\frac{7p/4}{\sigma_{\min}^2(\mathbf{P}_\Omega \mathbf{L})} + 1} \|\text{vec}(\mathcal{T}_2)\| \stackrel{(d)}{\leq} \frac{3}{\sqrt{2}} \phi_t,\end{aligned}$$

where (c) uses Lemma 7.6, (d) uses (21). This completes the proof. \square

Proof of Theorem 4.3.

To show Theorem 4.3, we also need the following two lemmas.

Lemma 8.1. *Follow the notations and assumptions in Lemmas 4.1 and 4.2, and denote $\kappa = \max_k \kappa([\mathcal{G}_*]_{(k)})$. If*

$$g_{\min} > \sqrt{2}\kappa\psi_{t-1} - 6g_{\max}(C_1 + C_2)\sqrt{\frac{\alpha}{p}}(\sin\theta_{t-1} + 1),$$

then w.p. $\geq 1 - 2/J_{\min}^{10+\log\alpha}$, it holds that

$$\sin\theta_t \leq \frac{6g_{\max}(C_1 + C_2)\sqrt{\frac{\alpha}{p}}\sin\theta_{t-1}}{g_{\min} - \sqrt{2}\kappa\psi_{t-1} - 6g_{\max}(C_1 + C_2)\sqrt{\frac{\alpha}{p}}\sin\theta_{t-1}} < \sin\theta_{t-1}.$$

Proof. Denote $\mathcal{S} = \llbracket \mathcal{G}_{t-1}; \mathbf{A}_t^{(1)}, \dots, \mathbf{A}_t^{(n-1)}, \mathbf{I}, \mathbf{A}_{t-1}^{(n+1)}, \dots, \mathbf{A}_{t-1}^{(N)} \rrbracket$, and recall (9). Then $\mathbf{X}_{\text{opt}} = \text{argmin} \|\mathbf{X}\mathcal{S}_{(n)} - \mathcal{T}_{(n)}\|_F = \mathcal{T}_{(n)}\mathcal{S}_{(n)}^\dagger$. By calculations, we have

$$\begin{aligned}\sigma_{\min}(\mathbf{X}_{\text{opt}}) &= \sigma_{\min}(\mathcal{T}_{(n)}\mathcal{S}_{(n)}^\dagger) = \sigma_{\min}(\mathbf{A}^{(n)}\mathcal{G}_{(n)}\mathbf{M}_n^\text{T}\mathbf{M}_{t,n}[\mathcal{G}_{t-1}]_{(n)}^\dagger(\mathbf{A}_{t-1}^{(n)})^\text{T}) \\ &\stackrel{(a)}{\geq} 1 - \|\mathbf{A}^{(n)}\mathcal{G}_{(n)}\mathbf{M}_n^\text{T}(\mathbf{M}_{t,n}[\mathcal{G}_{t-1}]_{(n)}^\dagger(\mathbf{A}_{t-1}^{(n)})^\text{T} - \mathbf{M}_n\mathcal{G}_{(n)}^\dagger(\mathbf{A}^{(n)})^\text{T})\| \\ &\stackrel{(b)}{\geq} 1 - \|\mathcal{G}_{(n)}\| \|\mathbf{M}_{t,n}[\mathcal{G}_{t-1}]_{(n)}^\dagger(\mathbf{A}_{t-1}^{(n)})^\text{T} - \mathbf{M}_n\mathcal{G}_{(n)}^\dagger(\mathbf{A}^{(n)})^\text{T}\| \\ &\stackrel{(c)}{\geq} 1 - \|\mathcal{G}_{(n)}\| \|\mathbf{M}_{t,n}[\mathcal{G}_{t-1}]_{(n)}^\dagger(\mathbf{A}_{t-1}^{(n)})^\text{T} - \mathbf{M}_n\mathcal{G}_{(n)}^\dagger(\mathbf{A}^{(n)})^\text{T}\| \\ &\stackrel{(d)}{\geq} 1 - \|\mathcal{G}_{(n)}\| \sqrt{2} \|\mathcal{G}_{t-1}\|_{(n)}^\dagger \|\mathcal{G}_{(n)}^\dagger\| \|\mathbf{A}_{t-1}^{(n)}[\mathcal{G}_{t-1}]_{(n)}\mathbf{M}_{t,n}^\text{T} - \mathbf{A}^{(n)}\mathcal{G}_{(n)}\mathbf{M}_n^\text{T}\| \\ &\stackrel{(e)}{\geq} 1 - \|\mathcal{G}_{(n)}\| \sqrt{2} \|\mathcal{G}_{t-1}\|_{(n)}^\dagger \|\mathcal{G}_{(n)}^\dagger\| \psi_{t-1} \\ &\stackrel{(f)}{\geq} 1 - \frac{\sqrt{2}\kappa_n}{g_{\min}} \psi_{t-1},\end{aligned}\tag{23}$$

where (a) uses $\|\mathbf{A}^{(n)}\mathcal{G}_{(n)}\mathbf{M}_n^T(\mathbf{M}_n\mathcal{G}_{(n)}^\dagger(\mathbf{A}^{(n)})^T)\| = 1$, (b) uses $\mathbf{A}^{(n)}$ has orthonormal columns, (c) uses $\mathbf{A}^{(n)}$, $\mathbf{A}_{t-1}^{(n)}$, \mathbf{M}_n and $\mathbf{M}_{t,n}$ all have orthonormal columns, (d) uses [40, Theorem 4.1], (e) uses $\mathbf{A}_{t-1}^{(n)}[\mathcal{G}_{t-1}]_{(n)}\mathbf{M}_{t,n}^T - \mathbf{A}^{(n)}\mathcal{G}_{(n)}\mathbf{M}_n^T = \llbracket[\mathcal{G}_{t-1}; \mathbf{A}_t^{(1)}, \dots, \mathbf{A}_{t-1}^{(N)}] - \mathcal{T}\rrbracket_{(n)}$ and the definition of ψ_t , (f) uses $\kappa(\mathcal{G}_{(n)}) \leq \kappa_n$.

Then it follows that

$$\begin{aligned} \sigma_{\min}(\widetilde{\mathbf{X}}_{\text{opt}}) &\stackrel{(g)}{\geq} \sigma_{\min}(\mathbf{X}_{\text{opt}}) - \|\widetilde{\mathbf{X}}_{\text{opt}} - \mathbf{X}_{\text{opt}}\| \\ &\stackrel{(h)}{\geq} 1 - \frac{\sqrt{2}\kappa_n\psi_{t-1}}{g_{\min}} - \frac{6g_{\max}(C_1 + C_2)}{g_{\min}}\sqrt{\frac{\alpha}{p}}\sin\theta_{t-1}, \quad \text{w.p.} \geq 1 - 2/J_{\min}^{10+\log\alpha}, \end{aligned} \quad (24)$$

where (g) uses Lemma 7.2, (h) uses (23) and Lemma 4.1.

Let $[\mathbf{A}_*^{(n)}, \mathbf{A}_c^{(n)}]$ be an orthogonal matrix, the QR decomposition of $\widetilde{\mathbf{X}}_{\text{opt}}$ be $\widetilde{\mathbf{X}}_{\text{opt}} = \mathbf{Q}\mathbf{R}$, where \mathbf{Q} has orthonormal columns, \mathbf{R} is nonsingular. Then we have

$$\begin{aligned} \|\sin\Theta(\mathbf{A}_t^{(n)}, \mathbf{A}^{(n)})\| &\stackrel{(i)}{=} \|(\mathbf{A}_c^{(n)})^T\widetilde{\mathbf{X}}_{\text{opt}}\mathbf{R}^{-1}\| \\ &\leq \|(\mathbf{A}_c^{(n)})^T(\widetilde{\mathbf{X}}_{\text{opt}} - \mathbf{X}_{\text{opt}})\mathbf{R}^{-1}\| + \|(\mathbf{A}_c^{(n)})^T\mathbf{X}_{\text{opt}}\mathbf{R}^{-1}\|_F \\ &\stackrel{(j)}{\leq} \|\widetilde{\mathbf{X}}_{\text{opt}} - \mathbf{X}_{\text{opt}}\|\|\mathbf{R}^{-1}\| \\ &\stackrel{(k)}{\leq} \frac{\frac{6g_{\max}(C_1+C_2)}{g_{\min}}\sqrt{\frac{\alpha}{p}}\sin\theta_{t-1}}{1 - \frac{\sqrt{2}\kappa_n\psi_{t-1}}{g_{\min}} - \frac{6g_{\max}(C_1+C_2)}{g_{\min}}\sqrt{\frac{\alpha}{p}}\sin\theta_{t-1}}, \end{aligned}$$

where (i) uses Lemma 7.1, (j) uses $(\mathbf{A}_c^{(n)})^T\mathbf{X}_{\text{opt}} = 0$ since $\mathbf{X}_{\text{opt}} = \mathbf{A}_*^{(n)}[\mathcal{G}_*]_{(n)}\mathbf{M}_{*,n}^T\mathcal{S}_{(n)}^\dagger$, (k) uses Lemma 4.1 and (24). The conclusion follows immediately. \square

Lemma 8.2. Denote $\sin\theta_t = \max_n \|\sin\Theta(\mathbf{A}_t^{(n)}, \mathbf{A}_*^{(n)})\|$, $g_{\min} = \min_n \sigma_{\min}(\mathcal{G}_{(n)})$, and let ϕ_t be the same as in Lemma 4.2. Assume **A2**. Then

$$g_{\min} \sin\theta_t \leq \phi_t \leq \|\mathcal{T}\|_F[(1 + \sin\theta_t)^N - 1].$$

Proof. Since **A2** and $\mathbf{A}_t^{(n)}$ has orthonormal columns for all n , we know that

$$\mathcal{X}_{\text{opt}} = \llbracket\mathcal{G}_*; (\mathbf{A}_t^{(1)})^T\mathbf{A}_*^{(1)}, \dots, (\mathbf{A}_t^{(N)})^T\mathbf{A}_*^{(N)}\rrbracket. \quad (25)$$

Let $\mathbf{P}_{*,n} = \mathbf{A}_*^{(n)}(\mathbf{A}_*^{(n)})^T$, $\mathbf{P}_{t,n} = \mathbf{A}_t^{(n)}(\mathbf{A}_t^{(n)})^T$ for all n . By Lemma 7.1, we have

$$\|\mathbf{P}_{t,n} - \mathbf{P}_{*,n}\| \leq \sin\theta_t. \quad (26)$$

For the upper bound of ϕ_t , by calculations, we have

$$\begin{aligned} \phi_t &\stackrel{(a)}{=} \|\llbracket\mathcal{G}_*; \mathbf{P}_{1,t}\mathbf{A}_*^{(1)}, \dots, \mathbf{P}_{N,t}\mathbf{A}_*^{(N)}\rrbracket - \llbracket\mathcal{G}_*; \mathbf{A}_*^{(1)}, \dots, \mathbf{A}_*^{(N)}\rrbracket\|_F \\ &= \|\llbracket\mathcal{T}; \mathbf{P}_{*,1} + (\mathbf{P}_{1,t} - \mathbf{P}_{*,1}), \dots, \mathbf{P}_{*,N} + (\mathbf{P}_{N,t} - \mathbf{P}_{*,N})\rrbracket - \mathcal{T}\rrbracket\|_F \\ &\stackrel{(b)}{\leq} \sum_{n=1}^N \binom{N}{n} \sin^n\theta_t \|\mathcal{T}\|_F = \|\mathcal{T}\|_F[(1 + \sin\theta_t)^N - 1] \end{aligned}$$

where (a) uses **A2** and (25), (b) uses (26) and **A2**.

For the lower bound of ϕ_t , let us first fix all $\mathbf{P}_{t,n}$ except one, say $\mathbf{P}_{t,1}$. Unfolding

$$\llbracket\mathcal{G}_*; \mathbf{P}_{t,1}\mathbf{A}_*^{(1)}, \dots, \mathbf{P}_{t,N}\mathbf{A}_*^{(N)}\rrbracket - \llbracket\mathcal{G}_*; \mathbf{A}_*^{(1)}, \dots, \mathbf{A}_*^{(N)}\rrbracket$$

along mode-1, we get

$$\mathbf{P}_{t,1}\mathbf{A}_*^{(1)}\mathcal{T}_{(n)}\mathbf{P}_{t,N}\mathbf{A}_*^{(N)} \otimes \dots \otimes \mathbf{P}_{t,2}\mathbf{A}_*^{(2)} - \mathbf{A}_*^{(1)}\mathcal{T}_{(n)}\mathbf{A}_*^{(N)} \otimes \dots \otimes \mathbf{A}_*^{(2)},$$

whose Frobenius norm is minimized at

$$\mathbf{P}_{t,1} = \mathbf{A}_*^{(1)} \mathcal{T}_{(n)} \mathbf{A}_*^{(N)} \otimes \cdots \otimes \mathbf{A}_*^{(2)} (\mathbf{A}_*^{(1)} \mathcal{T}_{(n)} \mathbf{P}_{t,N} \mathbf{A}_*^{(N)} \otimes \cdots \otimes \mathbf{P}_{t,2} \mathbf{A}_*^{(2)})^\dagger. \quad (27)$$

Using **A4** and the definition of $\mathbf{P}_{1,t}$, we have $\mathcal{R}(\mathbf{A}_t^{(1)}) = \mathcal{R}(\mathbf{A}_*^{(1)})$. Without loss of generality, let $\theta_{1,t} = \theta_t$. By calculations, we have

$$\begin{aligned} \phi_t &\geq \|[\mathcal{G}_*; \mathbf{P}_{1,t} \mathbf{A}_*^{(1)}, \mathbf{A}_*^{(2)}, \dots, \mathbf{A}_*^{(N)}] - [\mathcal{G}_*; \mathbf{A}_*^{(1)}, \dots, \mathbf{A}_*^{(N)}]\|_F \\ &= \|\mathcal{T} \times_1 (\mathbf{P}_{1,t} - \mathbf{P}_{*,1})\|_F = \|(\mathbf{P}_{1,t} - \mathbf{P}_{*,1}) \mathcal{T}_{(1)}\|_F \\ &= \|(\mathbf{P}_{1,t} - \mathbf{P}_{*,1}) \mathbf{A}_*^{(1)} [\mathcal{G}_*]_{(1)} (\mathbf{A}_*^{(N)} \otimes \cdots \otimes \mathbf{A}_*^{(2)})^\top\|_F \stackrel{(c)}{=} \|(\mathbf{P}_{1,t} - \mathbf{P}_{*,1}) \mathbf{A}^{(1)} [\mathcal{G}_*]_{(1)}\|_F \\ &\geq \|(\mathbf{I} - \mathbf{P}_{1,t}) \mathbf{A}_*^{(1)}\|_F \sigma_{\min}([\mathcal{G}_*]_{(1)}) \stackrel{(d)}{\geq} g_{\min} \sin \theta_t, \end{aligned}$$

where (c) uses $\mathbf{A}_*^{(N)} \otimes \cdots \otimes \mathbf{A}_*^{(2)}$ is orthonormal, (d) uses Lemma 7.1. This completes the proof. \square

Now we are ready to show the main theorem.

Theorem 4.3. Follow the notations in Lemma 4.1. Assume **A1-A5**, $p \in [4p_*, 0.5]$, and

$$\mu = \frac{3}{\sqrt{2}} \frac{\|\mathcal{T}\|_F [(1 + \sin \theta_0)^N - 1]}{g_{\min} \sin \theta_0} \times \frac{6g_{\max}(C_1 + C_2) \sqrt{\frac{\alpha}{p}}}{g_{\min} - \sqrt{2}\kappa\psi_0 - 6g_{\max}(C_1 + C_2) \sqrt{\frac{\alpha}{p}} \sin \theta_0} < \frac{\gamma}{7\Gamma}.$$

Then

$$\|[\mathcal{G}_t; \mathbf{A}_t^{(1)}, \dots, \mathbf{A}_t^{(N)}] - \mathcal{T}\|_F \leq \frac{7\mu\Gamma}{\gamma} \|[\mathcal{G}_{t-1}; \mathbf{A}_{t-1}^{(1)}, \dots, \mathbf{A}_{t-1}^{(N)}] - \mathcal{T}\|_F, \quad \text{w.h.p.}$$

In other words, Algorithm 1 converges to the exact solution at a linear rate, *w.h.p.*

Proof. First, we show $\psi_{t+1} \leq \mu\psi_t$ by mathematical induction.

Consider $t = 1$. By Lemma 8.1 and $\mu < 1$, we know that

$$\sin \theta_1 \leq \frac{6g_{\max}(C_1 + C_2) \sqrt{\frac{\alpha}{p}}}{g_{\min} - \sqrt{2}\kappa\psi_0 - 6g_{\max}(C_1 + C_2) \sqrt{\frac{\alpha}{p}} \sin \theta_0} \sin \theta_0 < \sin \theta_0. \quad (28)$$

Then

$$\psi_1 \stackrel{(a)}{\leq} \frac{3}{\sqrt{2}} \phi_1 \stackrel{(b)}{\leq} \frac{3}{\sqrt{2}} \|\mathcal{T}\|_F [(1 + \sin \theta_1)^N - 1] \stackrel{(c)}{\leq} \frac{3}{\sqrt{2}} \|\mathcal{T}\|_F \frac{[(1 + \sin \theta_0)^N - 1]}{\sin \theta_0} \sin \theta_1 \stackrel{(d)}{\leq} \mu g_{\min} \sin \theta_0 \stackrel{(e)}{\leq} \mu \psi_0 \stackrel{(f)}{<} \psi_0, \quad (29)$$

where (a) uses Lemma 4.2, (b) (e) uses Lemma 8.2, (c) uses $\sin \theta_1 < \sin \theta_0$ (by (28) and $\mu < 1$), (d) uses (28), (f) uses $\mu < 1$.

Now assume $\sin \theta_t < \sin \theta_{t-1}$, $\psi_t < \mu\psi_{t-1}$ for $t \leq T$. Then together with Lemma 8.1 and $\mu < 1$, we have

$$\begin{aligned} \sin \theta_{T+1} &\leq \frac{6g_{\max}(C_1 + C_2) \sqrt{\frac{\alpha}{p}}}{g_{\min} - \sqrt{2}\kappa\psi_T - 6g_{\max}(C_1 + C_2) \sqrt{\frac{\alpha}{p}} \sin \theta_T} \sin \theta_T \\ &\leq \frac{6g_{\max}(C_1 + C_2) \sqrt{\frac{\alpha}{p}}}{g_{\min} - \sqrt{2}\kappa\psi_0 - 6g_{\max}(C_1 + C_2) \sqrt{\frac{\alpha}{p}} \sin \theta_0} \sin \theta_T < \sin \theta_T. \end{aligned}$$

And similar to the proof of (29), we get $\psi_{T+1} \leq \mu\psi_T$.

Second, let $\tilde{\mathcal{X}}_{\text{opt}} = \operatorname{argmin} \|\Pi_{\Omega}(\llbracket \mathcal{X}; \mathbf{A}_t^{(1)}, \dots, \mathbf{A}_t^{(N)} \rrbracket) - \mathcal{T}\|_F$. Using Lemma 7.6 and A4, we have *w.h.p.* that

$$\begin{aligned} \|\llbracket \mathcal{G}_t; \mathbf{A}_t^{(1)}, \dots, \mathbf{A}_t^{(N)} \rrbracket - \mathcal{T}\|_F &\leq \frac{2}{\sqrt{p}} \tau_t \leq \frac{2}{\sqrt{p}} \frac{1}{\gamma} \|\Pi_{\Omega}(\llbracket \tilde{\mathcal{X}}_{\text{opt}}; \mathbf{A}_t^{(1)}, \dots, \mathbf{A}_t^{(N)} \rrbracket) - \Pi_{\Omega}(\mathcal{T})\|_F \\ &\leq \frac{2}{\sqrt{p}} \frac{1}{\gamma} \frac{\sqrt{7p}}{2} \|\llbracket \tilde{\mathcal{X}}_{\text{opt}}; \mathbf{A}_t^{(1)}, \dots, \mathbf{A}_t^{(N)} \rrbracket - \mathcal{T}\|_F = \frac{\sqrt{7}}{\gamma} \psi_t, \\ \|\llbracket \mathcal{G}_t; \mathbf{A}_t^{(1)}, \dots, \mathbf{A}_t^{(N)} \rrbracket - \mathcal{T}\|_F &\geq \frac{2}{\sqrt{7p}} \tau_t \geq \frac{2}{\sqrt{7p}} \frac{1}{\Gamma} \|\Pi_{\Omega}(\llbracket \tilde{\mathcal{X}}_{\text{opt}}; \mathbf{A}_t^{(1)}, \dots, \mathbf{A}_t^{(N)} \rrbracket) - \Pi_{\Omega}(\mathcal{T})\|_F \\ &\geq \frac{2}{\sqrt{7p}} \frac{1}{\Gamma} \frac{\sqrt{p}}{2} \|\llbracket \tilde{\mathcal{X}}_{\text{opt}}; \mathbf{A}_t^{(1)}, \dots, \mathbf{A}_t^{(N)} \rrbracket - \mathcal{T}\|_F = \frac{1}{\sqrt{7}\Gamma} \psi_t, \end{aligned}$$

Combining them with $\psi_{t+1} \leq \mu\psi_t$, we get

$$\|\llbracket \mathcal{G}_t; \mathbf{A}_t^{(1)}, \dots, \mathbf{A}_t^{(N)} \rrbracket - \mathcal{T}\|_F \leq \frac{\sqrt{7}}{\gamma} \psi_t \leq \frac{\sqrt{7}}{\gamma} \mu\psi_{t-1} \leq \frac{7\mu\Gamma}{\gamma} \|\llbracket \mathcal{G}_{t-1}; \mathbf{A}_t^{(1)}, \dots, \mathbf{A}_t^{(N)} \rrbracket - \mathcal{T}\|_F.$$

This completes the proof. \square

9 Assumption (11) in Lemma 4.1

In this section, we first give a lemma, then give Proposition 9.2, a proof for assumption (11) in Lemma 4.1.

Lemma 9.1. *Let $\mathbf{A}_k, \widehat{\mathbf{A}}_k \in \mathbb{R}^{I_n \times r_n}$ have orthonormal columns for $k = 1, \dots, N$, and denote*

$$\mathbf{M} = \mathbf{A}_1 \otimes \mathbf{A}_2 \otimes \dots \otimes \mathbf{A}_N, \quad \widehat{\mathbf{M}} = \widehat{\mathbf{A}}_1 \otimes \widehat{\mathbf{A}}_2 \otimes \dots \otimes \widehat{\mathbf{A}}_N.$$

Then

$$\|\sin \Theta(\mathbf{M}, \widehat{\mathbf{M}})\| \leq 2^{\frac{N-1}{2}} \max_k \{\|\sin \Theta(\mathbf{A}_k, \widehat{\mathbf{A}}_k)\|\}.$$

Proof. Consider $N = 2$. Without loss of generality, let $\|\sin \Theta(\mathbf{A}_1, \widehat{\mathbf{A}}_1)\| \geq \|\sin \Theta(\mathbf{A}_2, \widehat{\mathbf{A}}_2)\|$. Then by the definition of principal angle, it holds

$$\sigma_{\min}(\mathbf{A}_1^T \widehat{\mathbf{A}}_1) \geq \sigma_{\min}(\mathbf{A}_2^T \widehat{\mathbf{A}}_2). \quad (30)$$

Noticing that

$$\sigma_{\min}(\mathbf{M}^T \widehat{\mathbf{M}}) = \sigma_{\min}(\mathbf{A}_1^T \widehat{\mathbf{A}}_1 \otimes \mathbf{A}_2^T \widehat{\mathbf{A}}_2) = \sigma_{\min}(\mathbf{A}_1^T \widehat{\mathbf{A}}_1) \sigma_{\min}(\mathbf{A}_2^T \widehat{\mathbf{A}}_2), \quad (31)$$

by calculations, we have

$$\begin{aligned} \|\sin \Theta(\mathbf{M}, \widehat{\mathbf{M}})\| &\stackrel{(a)}{=} \sqrt{1 - \sigma_{\min}^2(\mathbf{M}^T \widehat{\mathbf{M}})} \stackrel{(b)}{=} \sqrt{1 - \sigma_{\min}^2(\mathbf{A}_1^T \widehat{\mathbf{A}}_1) \sigma_{\min}^2(\mathbf{A}_2^T \widehat{\mathbf{A}}_2)} \\ &\stackrel{(c)}{\leq} \sqrt{1 - \sigma_{\min}^4(\mathbf{A}_1^T \widehat{\mathbf{A}}_1)} \leq \sqrt{1 + \sigma_{\min}^2(\mathbf{A}_1^T \widehat{\mathbf{A}}_1)} \sqrt{1 - \sigma_{\min}^2(\mathbf{A}_1^T \widehat{\mathbf{A}}_1)} \\ &\leq \sqrt{2} \|\sin \Theta(\mathbf{A}_1, \widehat{\mathbf{A}}_1)\|. \end{aligned}$$

where (a) uses the definition of principal angle, (b) uses (31), (c) uses (30). The conclusion follows by recursively applying the above result for $N = 2$. \square

Proposition 9.2. *Follow the notations and assumptions in Lemma 4.2. Then*

$$\|\sin \Theta(\mathbf{M}_{t,t,n}[\tilde{\mathcal{X}}_{\text{opt}}]_{(n)}^T, \mathbf{M}_{*,n}[\mathcal{G}_*]_{(n)}^T)\| \leq C \sin \theta_t,$$

where

$$C = \frac{2^{\frac{N-2}{2}} g_{\max}}{g_{\min} - 2^{\frac{N-2}{2}} g_{\max} \sin \theta_t} + \frac{\frac{6\sqrt{\alpha} J_n}{\sqrt{p}} g_{\max} \left(\prod_{k \neq n} \sqrt{\frac{\mu_k r_k}{I_k}} + \sqrt{\frac{\mu_n r_n}{I_n}} 2^{\frac{N-2}{2}} \right)}{\left(1 - \frac{6\sqrt{\alpha} J_n}{\sqrt{p}} \sqrt{\frac{\mu_n r_n}{I_n}}\right) (g_{\min} - 2^{\frac{N-2}{2}} g_{\max} \sin \theta_t)}.$$

Proof. First, we show an upper bound for $\|\sin \Theta(\mathbf{M}_{t,t,n}[\mathcal{X}_{\text{opt}}]_{(n)}^{\text{T}}, \mathbf{M}_{*,n}[\mathcal{G}_*]_{(n)}^{\text{T}})\|$.

Recall the definition of \mathcal{X}_{opt} , we have

$$[\mathcal{X}_{\text{opt}}]_{(n)} = (\mathbf{A}_t^{(n)})^{\text{T}} \mathbf{A}_*^{(n)} [\mathcal{G}_*]_{(n)} \mathbf{M}_{*,n}^{\text{T}} \mathbf{M}_{t,t,n}. \quad (32)$$

By calculations, we get

$$\begin{aligned} & \|\mathbf{M}_{t,t,n}[\mathcal{X}_{\text{opt}}]_{(n)}^{\text{T}} - \mathbf{M}_{*,n}[\mathcal{G}_*]_{(n)}^{\text{T}} (\mathbf{A}_*^{(n)})^{\text{T}} \mathbf{A}_t^{(n)}\| \\ & \stackrel{(a)}{=} \|(\mathbf{I} - \mathbf{M}_{t,t,n} \mathbf{M}_{t,t,n}^{\text{T}}) \mathbf{M}_{*,n} [\mathcal{G}_*]_{(n)}^{\text{T}} (\mathbf{A}_*^{(n)})^{\text{T}} \mathbf{A}_t^{(n)}\| \\ & \stackrel{(b)}{\leq} \|\sin \Theta(\mathbf{M}_{t,t,n}, \mathbf{M}_{*,n})\| g_{\max} \cos \theta_t \stackrel{(c)}{\leq} 2^{\frac{N-2}{2}} g_{\max} \sin \theta_t \cos \theta_t, \end{aligned} \quad (33)$$

where (a) uses (32), (b) uses Lemma 7.1, (c) uses Lemma 9.1. It follows that

$$\begin{aligned} \sigma_{\min}(\mathbf{M}_{t,t,n}[\mathcal{X}_{\text{opt}}]_{(n)}^{\text{T}}) & \stackrel{(d)}{\geq} \sigma_{\min}(\mathbf{M}_{*,n}[\mathcal{G}_*]_{(n)}^{\text{T}} (\mathbf{A}_*^{(n)})^{\text{T}} \mathbf{A}_t^{(n)}) - 2^{\frac{N-2}{2}} g_{\max} \sin \theta_t \cos \theta_t \\ & = \sigma_{\min}([\mathcal{G}_*]_{(n)}^{\text{T}} (\mathbf{A}_*^{(n)})^{\text{T}} \mathbf{A}_t^{(n)}) - 2^{\frac{N-2}{2}} g_{\max} \sin \theta_t \cos \theta_t \\ & \geq g_{\min} \cos \theta_t - 2^{\frac{N-2}{2}} g_{\max} \sin \theta_t \cos \theta_t. \end{aligned} \quad (34)$$

where (d) (33). Then we get

$$\begin{aligned} & \|\sin \Theta(\mathbf{M}_{t,t,n}[\mathcal{X}_{\text{opt}}]_{(n)}^{\text{T}}, \mathbf{M}_{*,n}[\mathcal{G}_*]_{(n)}^{\text{T}})\| \\ & \stackrel{(e)}{\leq} \frac{\|(\mathbf{I} - \mathbf{M}_{*,n}[\mathcal{G}_*]_{(n)}^{\text{T}} (\mathbf{M}_{*,n}[\mathcal{G}_*]_{(n)}^{\text{T}})^{\dagger}) \mathbf{M}_{t,t,n}[\mathcal{X}_{\text{opt}}]_{(n)}^{\text{T}}\|}{\sigma_{\min}(\mathbf{M}_{t,t,n}[\mathcal{X}_{\text{opt}}]_{(n)}^{\text{T}})} \\ & \stackrel{(f)}{\leq} \frac{\|(\mathbf{I} - \mathbf{M}_{*,n}[\mathcal{G}_*]_{(n)}^{\text{T}} (\mathbf{M}_{*,n}[\mathcal{G}_*]_{(n)}^{\text{T}})^{\dagger}) (\mathbf{M}_{t,t,n}[\mathcal{X}_{\text{opt}}]_{(n)}^{\text{T}} - \mathbf{M}_{*,n}[\mathcal{G}_*]_{(n)}^{\text{T}} (\mathbf{A}_*^{(n)})^{\text{T}} \mathbf{A}_t^{(n)})\|}{g_{\min} \cos \theta_t - 2^{\frac{N-2}{2}} g_{\max} \sin \theta_t \cos \theta_t} \\ & \stackrel{(g)}{\leq} \frac{2^{\frac{N-2}{2}} g_{\max} \sin \theta_t}{g_{\min} - 2^{\frac{N-2}{2}} g_{\max} \sin \theta_t}, \end{aligned} \quad (35)$$

where (e) uses Lemma 7.1, (f) uses (34), and (g) uses (33).

Next, we show an upper bound for $\|\sin \Theta(\mathbf{M}_{t,t,n}[\tilde{\mathcal{X}}_{\text{opt}}]_{(n)}^{\text{T}}, \mathbf{M}_{t,t,n}[\mathcal{X}_{\text{opt}}]_{(n)}^{\text{T}})\|$.

Let $\mathcal{X} = \mathcal{X}_{\text{opt}} + \mathcal{Y}$. Since $\tilde{\mathcal{X}}_{\text{opt}} = \operatorname{argmin} \|\llbracket \tilde{\mathcal{X}}_{\text{opt}}; \mathbf{A}_t^{(1)}, \dots, \mathbf{A}_t^{(N)} \rrbracket - \mathcal{T}\|_F$, Let \mathcal{Y} be the least square solution to

$$\frac{1}{p} \Pi_{\Omega}(\mathbf{A}_t^{(n)} \mathcal{Y}_{(n)} \mathbf{M}_{t,t,n}^{\text{T}}) = \frac{1}{p} \Pi_{\Omega}(\mathbf{R}), \quad (36)$$

where $\mathbf{R} = \mathbf{A}_*^{(n)} [\mathcal{G}_*]_{(n)} \mathbf{M}_{*,n}^{\text{T}} - \mathbf{A}_t^{(n)} \mathcal{X}_{\text{opt}} \mathbf{M}_{t,t,n}^{\text{T}}$, then $\tilde{\mathcal{X}}_{\text{opt}} = \mathcal{X}_{\text{opt}} + \mathcal{Y}$.

By Lemma 7.3, *w.h.p.*, there exist \mathbf{E} and \mathbf{F} such that

$$\frac{1}{p} \Pi_{\Omega}(\mathbf{A}_t^{(n)} \mathcal{Y}_{(n)} \mathbf{M}_{t,t,n}^{\text{T}}) = \mathbf{A}_t^{(n)} \mathcal{Y}_{(n)} \mathbf{M}_{t,t,n}^{\text{T}} + \mathbf{E}, \quad \frac{1}{p} \Pi_{\Omega}(\mathbf{R}) = \mathbf{R} + \mathbf{F}, \quad (37)$$

where

$$\begin{aligned}
\|\mathbf{E}\| &\leq \frac{6\sqrt{\alpha J_n}}{\sqrt{p}} \|\mathbf{A}_t^{(n)} \mathcal{Y}_{(n)} \mathbf{M}_{t,t,n}^T\|_{\max} \stackrel{(h)}{\leq} \frac{6\sqrt{\alpha J_n}}{\sqrt{p}} \sqrt{\frac{\mu_n r_n}{I_n}} \|\mathcal{Y}_{(n)} \mathbf{M}_{t,t,n}^T\|, \\
\|\mathbf{F}\| &\leq \frac{6\sqrt{\alpha J_n}}{\sqrt{p}} \|\mathbf{R}\|_{\max} \\
&\leq \frac{6\sqrt{\alpha J_n}}{\sqrt{p}} (\|\mathbf{A}_*^{(n)} [\mathcal{G}_*]_{(n)} \mathbf{M}_{*,n}^T - \mathbf{A}_t^{(n)} (\mathbf{A}_t^{(n)})^T \mathbf{A}_*^{(n)} [\mathcal{G}_*]_{(n)} \mathbf{M}_{*,n}^T\|_{\max} + \\
&\quad \|\mathbf{A}_t^{(n)} (\mathbf{A}_t^{(n)})^T \mathbf{A}_*^{(n)} [\mathcal{G}_*]_{(n)} \mathbf{M}_{*,n}^T - \mathbf{A}_t^{(n)} (\mathbf{A}_t^{(n)})^T \mathbf{A}_*^{(n)} [\mathcal{G}_*]_{(n)} \mathbf{M}_{*,n}^T \mathbf{M}_{t,t,n} \mathbf{M}_{t,t,n}^T\|_{\max}) \\
&\stackrel{(i)}{\leq} \frac{6\sqrt{\alpha J_n}}{\sqrt{p}} g_{\max} \left(\prod_{k \neq n} \sqrt{\frac{\mu_k r_k}{I_k}} \sin \theta_t + \sqrt{\frac{\mu_n r_n}{I_n}} \|\sin \Theta(\mathbf{M}_{t,t,n}, \mathbf{M}_{*,n})\| \right) \\
&\stackrel{(j)}{\leq} \frac{6\sqrt{\alpha J_n}}{\sqrt{p}} g_{\max} \left(\prod_{k \neq n} \sqrt{\frac{\mu_k r_k}{I_k}} + \sqrt{\frac{\mu_n r_n}{I_n}} 2^{\frac{N-2}{2}} \right) \sin \theta_t,
\end{aligned} \tag{38}$$

where (h) uses **A3**, (i) uses **A3**, **A3**, Lemma 7.1, and (j) uses Lemma 9.1.

Then we can rewrite (36) as $\mathbf{A}_t^{(n)} \mathcal{Y}_{(n)} \mathbf{M}_{t,t,n}^T + \mathbf{E} = \mathbf{R} + \mathbf{F}$, from which we can obtain

$$\mathcal{Y}_{(n)} = (\mathbf{A}_t^{(n)})^T (\mathbf{R} + \mathbf{F} - \mathbf{E}) \mathbf{M}_{t,t,n} = (\mathbf{A}_t^{(n)})^T (\mathbf{F} - \mathbf{E}) \mathbf{M}_{t,t,n}. \tag{40}$$

It follows from (38), (39) and (40) that

$$\|\mathcal{Y}_{(n)} \mathbf{M}_{t,t,n}^T\| \leq \frac{1}{1 - \frac{6\sqrt{\alpha J_n}}{\sqrt{p}} \sqrt{\frac{\mu_n r_n}{I_n}}} \|\mathbf{F}\| \leq \frac{\frac{6\sqrt{\alpha J_n}}{\sqrt{p}} g_{\max} \left(\prod_{k \neq n} \sqrt{\frac{\mu_k r_k}{I_k}} + \sqrt{\frac{\mu_n r_n}{I_n}} 2^{\frac{N-2}{2}} \right)}{1 - \frac{6\sqrt{\alpha J_n}}{\sqrt{p}} \sqrt{\frac{\mu_n r_n}{I_n}}} \sin \theta_t. \tag{41}$$

Then we get

$$\begin{aligned}
&\|\sin \Theta(\mathbf{M}_{t,t,n}[\tilde{\mathcal{X}}_{\text{opt}}]_{(n)}^T, \mathbf{M}_{t,t,n}[\mathcal{X}_{\text{opt}}]_{(n)}^T)\| \\
&\stackrel{(k)}{\leq} \frac{\|(\mathbf{I} - \mathbf{M}_{t,t,n}[\tilde{\mathcal{X}}_{\text{opt}}]_{(n)}^T)(\mathbf{M}_{t,t,n}[\tilde{\mathcal{X}}_{\text{opt}}]_{(n)}^T)^\dagger \mathbf{M}_{t,t,n}[\mathcal{X}_{\text{opt}}]_{(n)}^T\|}{\sigma_{\min}(\mathbf{M}_{t,t,n}[\mathcal{X}_{\text{opt}}]_{(n)}^T)} \\
&\stackrel{(l)}{\leq} \frac{\|(\mathbf{I} - \mathbf{M}_{t,t,n}[\tilde{\mathcal{X}}_{\text{opt}}]_{(n)}^T)(\mathbf{M}_{t,t,n}[\tilde{\mathcal{X}}_{\text{opt}}]_{(n)}^T)^\dagger (\mathbf{M}_{t,t,n}[\mathcal{X}_{\text{opt}}]_{(n)}^T - \mathbf{M}_{t,t,n}[\tilde{\mathcal{X}}_{\text{opt}}]_{(n)}^T)\|}{g_{\min} \cos \theta_t - 2^{\frac{N-2}{2}} g_{\max} \sin \theta_t \cos \theta_t} \\
&\stackrel{(m)}{\leq} \frac{\frac{6\sqrt{\alpha J_n}}{\sqrt{p}} g_{\max} \left(\prod_{k \neq n} \sqrt{\frac{\mu_k r_k}{I_k}} + \sqrt{\frac{\mu_n r_n}{I_n}} 2^{\frac{N-2}{2}} \right) \sin \theta_t}{\left(1 - \frac{6\sqrt{\alpha J_n}}{\sqrt{p}} \sqrt{\frac{\mu_n r_n}{I_n}}\right) (g_{\min} - 2^{\frac{N-2}{2}} g_{\max} \sin \theta_t)},
\end{aligned} \tag{42}$$

where (k) uses Lemma 7.1, (l) uses 33, and (m) uses (41).

Finally, combining (35) and (42), we obtain

$$\begin{aligned}
&\|\sin \Theta(\mathbf{M}_{t,t,n}[\tilde{\mathcal{X}}_{\text{opt}}]_{(n)}^T, \mathbf{M}_{*,n}[\mathcal{G}_*]_{(n)}^T)\| \\
&\leq \|\sin \Theta(\mathbf{M}_{t,t,n}[\tilde{\mathcal{X}}_{\text{opt}}]_{(n)}^T, \mathbf{M}_{t,t,n}[\mathcal{X}_{\text{opt}}]_{(n)}^T)\| + \|\sin \Theta(\mathbf{M}_{t,t,n}[\mathcal{X}_{\text{opt}}]_{(n)}^T, \mathbf{M}_{*,n}[\mathcal{G}_*]_{(n)}^T)\| \\
&\leq \frac{2^{\frac{N-2}{2}} g_{\max} \sin \theta_t}{g_{\min} - 2^{\frac{N-2}{2}} g_{\max} \sin \theta_t} + \frac{\frac{6\sqrt{\alpha J_n}}{\sqrt{p}} g_{\max} \left(\prod_{k \neq n} \sqrt{\frac{\mu_k r_k}{I_k}} + \sqrt{\frac{\mu_n r_n}{I_n}} 2^{\frac{N-2}{2}} \right) \sin \theta_t}{\left(1 - \frac{6\sqrt{\alpha J_n}}{\sqrt{p}} \sqrt{\frac{\mu_n r_n}{I_n}}\right) (g_{\min} - 2^{\frac{N-2}{2}} g_{\max} \sin \theta_t)},
\end{aligned}$$

completing the proof. \square