

MULTIPLICITY-FREE SKEW SCHUR POLYNOMIALS

SHILIANG GAO, REUVEN HODGES, AND GIDON ORELOWITZ

ABSTRACT. We provide a non-recursive, combinatorial classification of multiplicity-free skew Schur polynomials. These polynomials are GL_n and SL_n characters of the skew Schur modules. Our result extends work of H. Thomas–A. Yong, and C. Gutschwager, in which they classify the multiplicity-free skew Schur functions.

1. INTRODUCTION

The *skew Schur polynomials* are a fundamental family of symmetric polynomials whose connection to representation theory was first studied by I. Schur. This family is indexed by *skew partitions* λ/μ , where $\lambda = (\lambda_1 \geq \lambda_2 \geq \dots \geq \lambda_n > 0)$ and $\mu = (\mu_1 \geq \mu_2 \geq \dots \geq \mu_m > 0)$ are *partitions* with $\mu \subseteq \lambda$ (that is, $m \leq n$ and $\mu_i \leq \lambda_i$ for $1 \leq i \leq m$). The skew Schur polynomial of *shape* λ/μ is the generating function

$$(1) \quad s_{\lambda/\mu}(x_1, \dots, x_n) = \sum_T x^{\eta(T)}, \quad x^{\eta(T)} := x_1^{\eta_1(T)} x_2^{\eta_2(T)} \dots x_n^{\eta_n(T)},$$

where the sum is over all semistandard tableaux T of shape λ/μ with entries in $[n]$, and $\eta_i(T)$ is the number of entries in T equal to i .

Though not immediately apparent from (1), $s_{\lambda/\mu}(x_1, \dots, x_n)$ is an element of Λ_n , the ring of symmetric polynomials in variables x_1, \dots, x_n . For $\lambda = (\lambda_1, \lambda_2, \dots, \lambda_n)$, the *length* of the partition is $\ell(\lambda) = n$. Defining $s_\lambda(x_1, \dots, x_n) := s_{\lambda/\emptyset}(x_1, \dots, x_n)$ we recover the *Schur polynomials*; the $s_\lambda(x_1, \dots, x_n)$ with $\ell(\lambda) \leq n$ are a \mathbb{Z} -linear basis of Λ_n . This implies

$$(2) \quad s_{\lambda/\mu}(x_1, \dots, x_n) = \sum_\nu c_{\mu,\nu}^\lambda s_\nu(x_1, \dots, x_n)$$

where the sum is over partitions ν with $\ell(\nu) \leq n$ and the coefficients $c_{\mu,\nu}^\lambda$ are the celebrated Littlewood-Richardson coefficients. The expansion (2) is *multiplicity-free* if $c_{\mu,\nu}^\lambda \in \{0, 1\}$ for all ν with $\ell(\nu) \leq n$. A natural question is then:

When is $s_{\lambda/\mu}(x_1, \dots, x_n)$ multiplicity-free?

Our Theorem 1.10 gives a complete, non-recursive answer to this question.

1.1. Multiplicity-free representation theory. Multiplicity questions, along the same line as the one posed above, have both representation theoretic and geometric import. The Schur polynomials are characters of the irreducible polynomial representations of GL_n (and of SL_n , but we focus here on GL_n). Expressing a GL_n representation character in the basis of Schur polynomials is equivalent to decomposing the representation into a sum of irreducible representations.

Date: October 29, 2020.

Knowing that a representation is multiplicity-free has a number of applications (see, e.g., the survey [H95]). Pivoting to a geometric perspective, a group action on a projective algebraic variety induces an action on its homogeneous coordinate ring. The representations that arise from this induced action can often illuminate the orbit structure of the group in the variety [P14, MWZ01, S03, AP14]. In [HL19], the second author and V. Lakshmibai classified *spherical Schubert varieties* by showing that certain infinite sets of skew Schur polynomials always contain elements that are not multiplicity-free.

Developing multiplicity-free criterion for important families of representations has seen considerable interest. In [S01], the prototypical example, J. Stembridge classified products of Schur functions that are multiplicity-free. In *ibid.*, he extended this to a classification of the multiplicity-free products of Schur polynomials (equivalently multiplicity-free tensor products of irreducible GL_n representations). The skew Schur functions whose coefficients are all equal to 1 over an entire dominance order interval, and equal to 0 otherwise, are characterized in [ACM19]. Other examples of multiplicity-free classifications include [TY10, G10, FMS19]. As the skew Schur polynomials are GL_n characters of the skew Schur modules [FH91], this paper represents our contribution to this body of work.

1.2. Main theorem. Altering definition (1) so that it becomes a sum over all semistandard tableaux of shape λ/μ yields the *skew Schur function* $s_{\lambda/\mu}$. In [TY10], H. Thomas and A. Yong classified multiplicity-free products of Schubert classes in the cohomology ring of the Grassmannian. As the authors note, this is equivalent to classifying multiplicity-free skew Schur functions (see also [G10]).

Implicitly, $s_{\lambda/\mu}(x_1, \dots, x_n)$ is a specialization of $s_{\lambda/\mu}$ that arises by setting $x_m = 0$ for $m > n$. In particular, if $s_{\lambda/\mu}$ is multiplicity-free, then so is $s_{\lambda/\mu}(x_1, \dots, x_n)$, but the converse does not hold. In this sense, our classification is a generalization of [TY10], and we follow much of their terminology and notation.

Our result relies on four reductions. The first is central to [TY10]. A partition λ is visualized by its *Young diagram*, also denoted λ ; it is a collection of left justified boxes, with λ_i boxes in row i . Analogously, given a skew partition λ/μ , the *skew (Young) diagram* λ/μ equals the Young diagram λ with the leftmost μ_i boxes deleted in each row i .

Example 1.1. Let $\lambda = (5, 4, 1, 1)$ and $\mu = (2, 1, 1)$. The Young diagrams λ , μ and the skew diagram λ/μ are listed below, left to right.

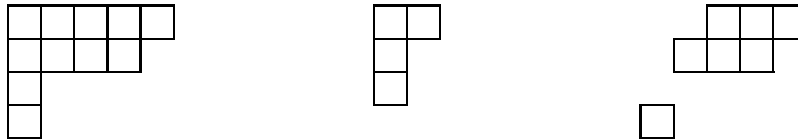

If there is a box B in row r and column c of the skew diagram λ/μ we will write $B = (r, c) \in \lambda/\mu$. Then $\text{col}(B) = c$ and $\text{row}(B) = r$. For any set $S \subset [\lambda_1]$, we refer to column k as an S -column if $k \in S$.

Definition 1.2. A skew partition is *basic* if its skew diagram does not contain any empty rows or columns. The skew partition that arises from the deletion of all empty rows and columns of λ/μ is called the *basic demolition* of the skew partition, and is denoted $(\lambda/\mu)^{\text{ba}}$.

Let $\text{CS}_k(\lambda/\mu) = |\{r : (r, k) \in \lambda/\mu\}|$. Define

$$(3) \quad \rho(\lambda/\mu) := \max\{\text{CS}_k(\lambda/\mu) : 1 \leq k \leq \lambda_1\}.$$

Definition 1.3. A skew partition is n -sharp if $\text{CS}_k(\lambda/\mu) < n$ for all k . The n -sharp demolition of a skew partition is equal to \emptyset/\emptyset if there exists a k such that $\text{CS}_k(\lambda/\mu) > n$. Otherwise it equals the skew partition that remains after deleting each column k such that $\text{CS}_k(\lambda/\mu) = n$. We denote the n -sharp demolition by $(\lambda/\mu)^{n\sharp}$.

When convenient, a partition will be presented as $(\lambda_1^{l_1}, \lambda_2^{l_2}, \dots, \lambda_p^{l_p})$, corresponding to the partition with the first l_1 entries equal to λ_1 , the next l_2 entries equal to λ_2 , and so on. The number of parts of λ is $\text{np}(\lambda) = p$. If $\text{np}(\lambda) = 1$, the partition is called a *rectangle*. A partition λ with $\text{np}(\lambda) = 2$ is called a *fat hook*.

For a skew partition λ/μ where $\lambda = (\lambda_1^{l_1}, \lambda_2^{l_2}, \dots, \lambda_p^{l_p})$ and $\mu = (\mu_1^{k_1}, \mu_2^{k_2}, \dots, \mu_q^{k_q})$, define $\tau(\lambda/\mu) = \sigma(\lambda/\mu) = 0$ if $\mu = \emptyset$ or λ is a rectangle. Otherwise, define

$$(4) \quad \tau(\lambda/\mu) = l_1 - \min(l_1, \ell(\mu)) \text{ and } \sigma(\lambda/\mu) = \lambda_p - \min(\mu_1, \lambda_p).$$

Definition 1.4. A basic skew partition λ/μ is *tight* if $\tau(\lambda/\mu) = \sigma(\lambda/\mu) = 0$. The *tight demolition* of λ/μ is

$$(\lambda/\mu)^{\text{ti}} = (((\lambda_1 - \sigma(\lambda/\mu))^{l_1 - \tau(\lambda/\mu)}, (\lambda_2 - \sigma(\lambda/\mu))^{l_2}, \dots, (\lambda_p - \sigma(\lambda/\mu))^{l_p})/\mu)^{\text{ba}}.$$

Note that if $\tau(\lambda/\mu) = \sigma(\lambda/\mu) = 0$, then $(\lambda/\mu)^{\text{ti}} = (\lambda/\mu)^{\text{ba}}$. Visually, if $\mu \neq \emptyset$ and λ is not a rectangle, then $(\lambda/\mu)^{\text{ti}}$ is the deletion of all rows with λ_1 boxes and all columns with $\ell(\lambda)$ boxes from λ/μ followed by the deletion of all empty rows and columns.

If $\lambda \subseteq (a^b)$, the (a^b) -complement of λ is

$$(5) \quad \lambda^{\vee(a^b)} = (a - \lambda_b, a - \lambda_{b-1}, \dots, a - \lambda_1),$$

where trailing zeros are removed, and for simplicity of notation, we set $\lambda_i = 0$ if $i > \ell(\lambda)$. Visually, $\lambda^{\vee(a^b)}$ is the complement of λ inside (a^b) , rotated by 180 degrees. There is a unique shortest lattice path, from the southwest corner to the northeast corner of (a^b) , separating λ and its complement. A *segment* of this lattice path is a maximal consecutive sequence of north, or east, steps. The (a^b) -shortness of a partition λ , denoted $\text{short}_{(a^b)}(\lambda)$, is the length of the shortest segment in the associated lattice path in (a^b) . Once a rectangle is fixed, we omit the respective (a^b) from the notation.

Example 1.5. Fix the rectangle (5^4) . If $\lambda = (5, 4, 1, 1) \subseteq (5^4)$, then $\lambda^\vee = (4, 4, 1)$. The shortness of λ equals 1 as seen by inspecting the lattice path below.

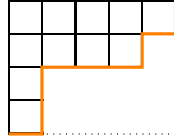

Definition 1.6. A basic skew partition λ/μ is *ordinary* if $\text{np}(\lambda) - 1 \leq \text{np}(\mu)$ or $\mu = \emptyset$. The *ordinary reduction* of a skew partition is equal to $\mu^{\vee(\lambda_1^{\ell(\lambda)})}/\lambda^{\vee(\lambda_1^{\ell(\lambda)})}$ if $\text{np}(\lambda) - 1 > \text{np}(\mu)$ and $\mu \neq \emptyset$, otherwise it equals λ/μ . We denote the ordinary reduction by $(\lambda/\mu)^{\text{or}}$.

Definition 1.7. A skew Schur polynomial $s_{\lambda/\mu}(x_1, \dots, x_n)$ is basic (resp. n -sharp, tight, ordinary) if λ/μ is basic (resp. n -sharp, tight, ordinary).

Theorem 1.8. Let $s_{((\lambda/\mu)^{n\sharp})^{\text{ba}})^{\text{or}}}(x_1, \dots, x_{n'})$ with $n' = n - \tau(((\lambda/\mu)^{n\sharp})^{\text{ba}})$ be the n -sharp, basic, tight, ordinary demolition of $s_{\lambda/\mu}(x_1, \dots, x_n)$. Then $s_{((\lambda/\mu)^{n\sharp})^{\text{ba}})^{\text{or}}}(x_1, \dots, x_{n'})$ is basic, n -sharp, tight, and ordinary. Further, $s_{\lambda/\mu}(x_1, \dots, x_n)$ is multiplicity-free if and only if $s_{((\lambda/\mu)^{n\sharp})^{\text{ba}})^{\text{or}}}(x_1, \dots, x_{n'})$ is multiplicity-free.

Definition 1.9. Let λ/μ be a basic, tight, ordinary skew partition, and say $\lambda = (\lambda_1^{l_1}, \lambda_2^{l_2}, \dots, \lambda_p^{l_p})$ and $\mu = (\mu_1^{k_1}, \mu_2^{k_2}, \dots, \mu_q^{k_q})$. Fix the rectangle $(\lambda_1^{\ell(\lambda)})$. Denote

$$(6) \quad r_1(\lambda/\mu) := \begin{cases} 0 & \text{np}(\lambda) > 2, \text{np}(\mu) > 1 \\ 1 & \text{np}(\lambda) = 2, \text{np}(\mu) > 2, \text{short}(\lambda) \geq 2 \\ 2 & \text{np}(\lambda) = 2, \text{np}(\mu) = 2, \text{short}(\lambda) \geq 3, \text{short}(\mu) \geq 2 \\ \infty & \text{Otherwise} \end{cases}$$

and

$$(7) \quad r_2(\lambda/\mu) := \begin{cases} 1 & \lambda_2 = \mu_q, l_2 \geq \ell(\mu) \\ 1 & \lambda_2 = \mu_1, k_1 \geq l_2 \\ 0 & \text{Otherwise} \end{cases} .$$

Now we may state our main result.

Theorem 1.10. Let $s_{\lambda/\mu}(x_1, \dots, x_n)$ be a basic, n -sharp, tight, ordinary skew Schur polynomial. Then $s_{\lambda/\mu}(x_1, \dots, x_n)$ is multiplicity-free if and only if

$$(8) \quad \rho(\lambda/\mu) < n < \rho(\lambda/\mu) + r_1(\lambda/\mu) + r_2(\lambda/\mu)$$

2. THE REDUCTIONS

2.1. The Littlewood-Richardson coefficients, rules and identities. There are myriad rules for computing the Littlewood-Richardson coefficients, one of them being the Littlewood-Richardson rule.

A *filling* of shape λ/μ is an assignment of values from $[n]$ to each box in the Young diagram λ/μ . A filling is called a *tableau* if the entries in each column strictly increase top to bottom. A tableau where the entries in each row weakly increase left to right is *semistandard tableau*. The *content* of a filling T is $\eta(T) = (\eta_1(T), \dots, \eta_n(T))$, where $\eta_i(T)$ is equal to the number of entries in T equal to i . For a filling T of λ/μ , and $(r, c) \in \lambda/\mu$, $T(r, c) = a$ indicates that the box in row r and column c of T contains a .

The *reverse reading word* of a filling is the sequence obtained by concatenating the entries of each row from right to left, top to bottom. A word $a_1 a_2 \dots a_t$ is *ballot* if in every initial factor $a_1 a_2 \dots a_s$ the number of i 's is greater than or equal to the number of $i + 1$'s, for all i . A *ballot tableau* is a semistandard tableau whose reverse reading word is ballot.

Theorem 2.1 (the Littlewood-Richardson rule [S99]). *The Littlewood-Richardson coefficient $c_{\mu, \nu}^\lambda$ is equal to the number of ballot tableaux of shape λ/μ and content ν .*

The column reading word of a filling is the sequence obtained by concatenating the entries of each column of the filling, top to bottom, right to left. The following lemma is a well known result whose proof we leave to the reader.

Lemma 2.2. *Let T be a semistandard tableau. The reverse reading word of T is ballot if and only if the column reading word of T is ballot.*

The Littlewood-Richardson coefficients satisfy the following two symmetries:

$$(9) \quad c_{\mu, \nu}^\lambda = c_{\nu, \mu}^\lambda ,$$

$$(10) \quad c_{\mu, \nu}^{\lambda} = c_{\mu, \nu^{\vee(a^b)}}^{\lambda^{\vee(a^b)}} ,$$

for $\lambda \subseteq (a^b)$. Applying the two above identities yields

$$(11) \quad c_{\mu, \nu}^{\lambda} = c_{\nu, \mu}^{\lambda} = c_{\nu, \lambda^{\vee(a^b)}}^{\mu^{\vee(a^b)}} = c_{\lambda^{\vee(a^b)}, \nu}^{\mu^{\vee(a^b)}} .$$

Given a sequence $\nu = (\nu_1, \dots, \nu_z) \in \mathbb{N}_{\geq 0}^z$, define $\text{sort}(\nu)$ to be the partition that arises from sorting the entries of ν so that they are weakly decreasing. If $\lambda = (\lambda_1, \dots, \lambda_a)$ and $\mu = (\mu_1, \dots, \mu_b)$ are two partitions, then $\lambda \cup \mu = \text{sort}(\lambda_1, \dots, \lambda_a, \mu_1, \dots, \mu_b)$. Set $\lambda + (c^d) = (\lambda_1 + c, \lambda_2 + c, \dots, \lambda_d + c, \lambda_{d+1}, \dots)$ where $\lambda_i = 0$ for $i > a$.

Theorem 2.3 ([G10, Theorem 3.1]). *Let λ, μ, ν be partitions with $a, b \in \mathbb{N}_{\geq 0}$ and $a \geq b$. Then*

$$(12) \quad c_{\mu, \nu}^{\lambda} \leq c_{\mu + (1^a), \nu + (1^{a-b})}^{\lambda + (1^a)} ,$$

$$(13) \quad c_{\mu, \nu}^{\lambda} \leq c_{\mu \cup (b), \nu \cup (a-b)}^{\lambda \cup (a)} .$$

Corollary 2.4. *Let λ/μ and λ^*/μ^* be skew partitions such that λ^*/μ^* is obtained from λ/μ by removing a subset of columns. If $\rho(\lambda/\mu) = \rho(\lambda^*/\mu^*)$ then for all $n \in \mathbb{Z}$, $s_{\lambda^*/\mu^*}(x_1, \dots, x_n)$ is not multiplicity-free implies $s_{\lambda/\mu}(x_1, \dots, x_n)$ is not multiplicity-free.*

Proof. There is a sequence of skew diagrams $\lambda^*/\mu^* = \lambda^1/\mu^1, \dots, \lambda^z/\mu^z = \lambda/\mu$ with $\lambda_i/\mu_i = \lambda_{i-1} + (1^{a_i})/\mu_{i-1} + (1^{b_i})$ and $b_i < a_i$, for $1 < i \leq z$. By construction

$$(14) \quad a_i - b_i \leq \rho(\lambda/\mu).$$

If $s_{\lambda^*/\mu^*}(x_1, \dots, x_n)$ is not multiplicity-free, then $n \geq \rho(\lambda/\mu)$ and there is a partition ν^* with $\ell(\nu^*) \leq n$ such that $c_{\mu^*, \nu^*}^{\lambda^*} > 1$. By (12), $c_{\mu^2, \nu^* + (1^{a_2 - b_2})}^{\lambda^2} \geq c_{\mu^*, \nu^*}^{\lambda^*} > 1$. Then (14) implies $\ell(\nu^* + (1^{a_i - b_i})) \leq n$. Thus $s_{\lambda^2/\mu^2}(x_1, \dots, x_n)$ is not multiplicity-free. Our desired result follows by inductively repeating this argument. \square

Corollary 2.5. *Let λ/μ and λ^*/μ^* be skew partitions such that λ^*/μ^* is obtained from λ/μ by removing a subset of columns. If $s_{\lambda^*/\mu^*}(x_1, \dots, x_{\rho(\lambda^*/\mu^*)+1})$ is not multiplicity-free, then $s_{\lambda/\mu}(x_1, \dots, x_{\rho(\lambda/\mu)+1})$ is not multiplicity-free.*

Proof. This follows by a nearly identical argument to the proof of Corollary 2.4, taking care at each step to show that the final content ν will have $\ell(\nu) \leq \rho(\lambda/\mu) + 1$. \square

Lemma 2.6. *Let λ/μ be a basic skew partition such that $\text{np}(\lambda), \text{np}(\mu) \geq 2$. Suppose that $\lambda_2 = \mu_q$ and $\ell(\mu) = l_1$. Set $\tilde{\lambda} = (\tilde{\lambda}_1^{l_1}, \dots, \tilde{\lambda}_{p+q-1}^{l_{p+q-1}})$ and $\tilde{\mu} = (\mu_q^{l_1})$ where*

$$\tilde{\lambda}_i = \begin{cases} (\lambda_1 + \mu_q - \mu_{q-i+1})^{k_{q-i+1}} & \text{if } i \in [q] \\ \lambda_{i-q+1}^{l_{i-q+1}} & \text{else} \end{cases} ,$$

then

$$c_{\mu, \nu}^{\lambda} = c_{\tilde{\mu}, \nu}^{\tilde{\lambda}} \text{ for all partition } \nu .$$

Example 2.7. Let $\lambda = (6^3, 2^2, 1)$ and $\mu = (5, 3, 2)$. By Lemma 2.6, we obtain $\tilde{\lambda} = (6, 5, 3, 2^2, 1)$, $\tilde{\mu} = (2^3)$ and $c_{\mu, \nu}^{\lambda} = c_{\tilde{\mu}, \nu}^{\tilde{\lambda}}$ for all partition ν . The skew diagram λ/μ (on the left) and $\tilde{\lambda}/\tilde{\mu}$ (on the right) are listed below.

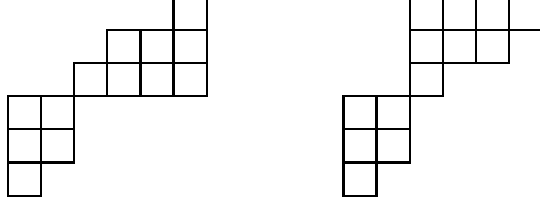

Visually, we obtain $\tilde{\lambda}/\tilde{\mu}$ from λ/μ by reversing the left to right order of column 3 through 6 while maintaining a valid skew partition.

Proof of Lemma 2.6: Since $\lambda_2 = \mu_q$ and $\ell(\mu) = l_1$, all ballot tableaux of shape λ/μ , of any content, are identical in columns $\mu_q + 1$ through λ_1 . Notice that $\tilde{\lambda}_{q+1} = \lambda_2$ and $\ell(\mu) = \sum_{i=1}^q k_i = \sum_{j=i}^q \tilde{l}_j$. Therefore all ballot tableaux of shape $\tilde{\lambda}/\tilde{\mu}$, of any content, are also identical in columns $\mu_q + 1$ through λ_1 . Let T be any ballot tableau of shape λ/μ and of any content, then column c of T is filled by 1 through $\text{CS}_c(\lambda/\mu)$ for $c \in [\mu_q + 1, \lambda_1]$. Similarly, let \tilde{T} be any ballot tableau of shape $\tilde{\lambda}/\tilde{\mu}$ and of any content, then column c of \tilde{T} is filled by 1 through $\text{CS}_c(\tilde{\lambda}/\tilde{\mu})$ for $c \in [\mu_q + 1, \lambda_1]$. Since $\text{CS}_c(\lambda/\mu) = \text{CS}_{\lambda_1 + \mu_q + 1 - c}(\tilde{\lambda}/\tilde{\mu})$ for all $c \in [\mu_q + 1, \lambda_1]$, the content of T and \tilde{T} are identical in columns $\mu_q + 1$ through λ_1 . Therefore we can find a content preserving involution from the set of ballot tableaux of shape λ/μ to the set of ballot tableaux of shape $\tilde{\lambda}/\tilde{\mu}$. As a result,

$$c_{\mu, \nu}^{\lambda} = c_{\tilde{\mu}, \nu}^{\tilde{\lambda}} \text{ for all partition } \nu.$$

□

2.2. A quartet of reductions.

Proposition 2.8 ([TY10, Lemma 2]). *If λ/μ is a skew partition, then*

$$s_{\lambda/\mu}(x_1, \dots, x_n) = s_{(\lambda/\mu)^{\text{ba}}}(x_1, \dots, x_n).$$

Proposition 2.9. *If λ/μ is a skew partition, then*

$$(15) \quad s_{\lambda/\mu}(x_1, \dots, x_n) = (x_1 \cdots x_n)^k s_{(\lambda/\mu)^{\text{n}\sharp}}(x_1, \dots, x_n),$$

where $k = \#\{d : \text{CS}_d(\lambda/\mu) = n\}$. In particular, $s_{\lambda/\mu}(x_1, \dots, x_n)$ is multiplicity-free if and only if $s_{(\lambda/\mu)^{\text{n}\sharp}}(x_1, \dots, x_n)$ is multiplicity-free.

Proof. If $\rho(\lambda/\mu) > n$, then $(\lambda/\mu)^{\text{n}\sharp} = \emptyset/\emptyset$ and $s_{(\lambda/\mu)^{\text{n}\sharp}}(x_1, \dots, x_n) = 0$. Let ν be a partition with $\ell(\nu) \leq n$. Since there is a column in λ/μ with more than n boxes, there are no tableau of shape λ/μ and content ν . Hence, Theorem 2.1 implies $c_{\mu, \nu}^{\lambda} = 0$. By (1), $s_{\lambda/\mu}(x_1, \dots, x_n) = 0$. Thus (15) holds when $\rho(\lambda/\mu) > n$.

If $\rho(\lambda/\mu) \leq n$, then $(\lambda/\mu)^{\text{n}\sharp}$ is the skew partition that arises from deleting all columns with exactly n boxes. If $k = 0$, then $(\lambda/\mu)^{\text{n}\sharp} = \lambda/\mu$ and (15) is trivial. Hence, we assume $k > 0$. Let $\lambda^{n\sharp}$ and $\mu^{n\sharp}$ be the partitions such that $(\lambda/\mu)^{\text{n}\sharp} = \lambda^{n\sharp}/\mu^{n\sharp}$. If ν is a partition such that $\ell(\nu) \leq n$, then we claim

$$(16) \quad c_{\mu^{n\sharp}, \nu}^{\lambda^{n\sharp}} = c_{\mu, \nu + (k^n)}^{\lambda}.$$

Denote by S_1 the set of ballot tableaux of shape λ/μ with content $\nu + (k^n)$, and let S_2 denote the set of ballot tableaux of shape $(\lambda/\mu)^{\text{n}\sharp}$ with content ν . Consider the map $f : S_1 \rightarrow S_2$ that sends a $T \in S_1$ to a $T^* \in S_2$ by removing all columns in T of length n . We show that f is a bijection.

f is well-defined: Since each column of T is strictly increasing downwards, a column with n boxes has to be filled with 1 through n . Removing the subword corresponding to the boxes in such a column will result in a column reading word that is ballot. Thus by Lemma 2.2 the reverse reading word is ballot. Each column remains strictly increasing and each row remains weakly increasing after removing columns of length n . Hence $f(T)$ is a ballot tableau of shape $(\lambda/\mu)^{\#}$ and content ν .

f is injective: Since all the columns of length n must be filled with 1 through n , all ballot tableaux in S_1 are identical in these columns. Therefore if $T_1, T_2 \in S_1$ with $T_1 \neq T_2$, then they must differ in a column of length less than n . As a result, their image, $f(T_1)$ and $f(T_2)$, differ in a column of length less than n .

f is surjective: Let $\{c_1^*, \dots, c_k^*\}$ be the columns in λ/μ of length less than n and let $\{c_1, \dots, c_l\}$ be the columns of length equal to n . For $T^* \in S_2$, consider a tableau T_0 of shape λ/μ where we fill column c_i^* with the same entries as the i^{th} column in T^* , for all $i \in \{1, \dots, k\}$. By construction the two columns have the same size. Fill in the remaining columns of T_0 with 1 through n in each column. It is clear that if $T_0 \in S_1$, then $f(T_0) = T^*$.

T_0 is semistandard: It is clear from the construction that each column of T_0 is strictly increasing. Since T^* is semistandard, it suffices to verify that the entries in each row are weakly increasing at the boxes in c_i for all $i \in \{1, \dots, l\}$. Since λ/μ is a skew-shape, the column directly to the left of c_i , denoted as c_i^- , ends in the same row or lower than c_i ends. Therefore if an entry in c_i^- is greater than its right neighbor in c_i , then every entries in c_i^- below it have to be greater than their right neighbors (if exist). As a result, the entry in c_i^- that has the bottom entry of c_i as its right neighbor has to be filled by at least $n + 1$ which is impossible by our construction. Similarly, the column directly to the right of c_i , denoted as c_i^+ starts in the same row or higher than c_i . Therefore if an entry in c_i^+ is smaller than its left neighbor in c_i , then every entry above it in c_i^+ is smaller than their left neighbors, if they exist. However, there will not be a valid entry to the right of the top entry in c_i . Therefore T_0 is semistandard.

T_0 is a ballot tableau: By adding columns $\{c_1, \dots, c_l\}$ filled by 1 through n , one insert l subwords into the column reading word of T^* where each subword is $1, 2, \dots, n$. Therefore the column reading word of T_0 is also ballot, and by Lemma 2.2 the reverse reading word is ballot.

Thus (16) holds. The final equality we need to complete the proof is

$$(17) \quad s_{\nu+(k^n)}(x_1, \dots, x_n) = (x_1 \cdots x_n)^k s_{\nu}(x_1, \dots, x_n),$$

which follows from (1). Thus

$$(18) \quad \begin{aligned} s_{\lambda/\mu}(x_1, \dots, x_n) &= \sum_{\alpha \text{ s.t. } \ell(\alpha) \leq n} c_{\mu, \alpha}^{\lambda} s_{\alpha}(x_1, \dots, x_n) & (1) \\ &= \sum_{\nu \text{ s.t. } \ell(\nu) \leq n} c_{\mu, \nu+(k^n)}^{\lambda} s_{\nu+(k^n)}(x_1, \dots, x_n) \\ &= \sum_{\nu \text{ s.t. } \ell(\nu) \leq n} c_{\mu^{\#}, \nu}^{\lambda^{\#}}(x_1, \dots, x_n)^k s_{\nu}(x_1, \dots, x_n) & (16), (17) \\ &= (x_1 \cdots x_n)^k s_{(\lambda/\mu)^{\#}}(x_1, \dots, x_n) & (1) \end{aligned}$$

The second equality in (18) follows from the fact that any nonzero $c_{\mu, \alpha}^{\lambda}$ must have $(k^n) \subseteq \alpha$. If $s_{\lambda/\mu}(x_1, \dots, x_n)$ is multiplicity-free then all the Littlewood-Richardson coefficients that

appear in (18) are equal to 0 or 1, and hence $s_{(\lambda/\mu)^{\#}}(x_1, \dots, x_n)$ is multiplicity-free. The converse holds by the same argument. \square

Lemma 2.10. *If λ/μ is a skew partition that contains a $b \times k$ rectangle and $c_{\mu, \nu}^{\lambda} \neq 0$, then $(k^b) \subseteq \nu$.*

Proof. If $c_{\mu, \nu}^{\lambda} \neq 0$, then there must exist a ballot tableau T of shape λ/μ and content ν . Let $(r, c) \in \lambda/\mu$ be the bottom, left corner of the $b \times k$ rectangle. Then $T(r, c) \geq b$ since T is a tableau, and $T(r, c + i) \geq b$ for $0 \leq i \leq k$ since T is a semistandard tableau. Thus the reverse reading word a_1, \dots, a_m of T contains a consecutive subsequence a_{z+1}, \dots, a_{z+k} with

$$(19) \quad a_{z+j} \geq b \text{ for } 1 \leq j \leq k,$$

$$(20) \quad a_{z+j} \geq a_{z+j+1} \text{ for } 1 \leq j < k.$$

Since a_1, \dots, a_m is a ballot sequence, we must have that there is a subsequence of a_1, \dots, a_z that equals $1, 2, \dots, a_{z+1} - 1$. By (20), $a_{z+1} \geq a_{z+2}$, so there must be a second subsequence of a_1, \dots, a_z that equals $1, 2, \dots, a_{z+2} - 1$, and it must be disjoint from the first sequence. Continuing inductively we arrive at the conclusion that there are k disjoint subsequences of a_1, \dots, a_{z+k} of the form $1, 2, \dots, a_{z+j}$ for $1 \leq j \leq k$. Each $a_{z+j} \geq b$ by (19), and thus we arrive at our desired result that $(k^b) \subseteq \nu$. \square

Proposition 2.11. *If λ/μ is a basic skew partition and $n' = n - \tau(\lambda/\mu)$, then $s_{\lambda/\mu}(x_1, \dots, x_n)$ is multiplicity-free if and only if $s_{(\lambda/\mu)^{\text{ti}}}(x_1, \dots, x_{n'})$ is multiplicity-free.*

Proof. Let $\tau = \tau(\lambda/\mu)$ and $\sigma = \sigma(\lambda/\mu)$. If $\tau = \sigma = 0$, the result is immediate, so we assume $\tau > 0$ or $\sigma > 0$. Let λ^{ti} and μ^{ti} be the partitions such that $(\lambda/\mu)^{\text{ti}} = \lambda^{\text{ti}}/\mu^{\text{ti}}$. By Definition 1.4,

$$(21) \quad \lambda = \lambda^{\text{ti}} \cup ((\lambda_1 - \sigma)^{\tau}) + (\sigma^{\ell(\lambda)}) \text{ and } \mu = \mu^{\text{ti}}.$$

Suppose that $c_{\mu, \nu}^{\lambda} \neq 0$ for some ν such that $\ell(\nu) \leq n$. Since λ/μ contains a $\tau \times \lambda_1$ rectangle and a $\ell(\lambda) \times \sigma$ rectangle, Lemma 2.10 implies $(\lambda_1^{\tau}) \subseteq \nu$ and $(\sigma^{\ell(\lambda)}) \subseteq \nu$. Therefore both λ and ν contains the fat hook $(\lambda_1^{\tau}, \sigma^{\ell(\lambda)-\tau})$. Further, $\nu \subseteq \lambda$, and so $\nu_i = \lambda_i$ for $i \in \{1, \dots, \tau\}$ and $\nu_{\ell(\lambda)} = \lambda_p$. This implies

$$(22) \quad \nu = \alpha \cup ((\lambda_1 - \sigma)^{\tau}) + (\sigma^{\ell(\lambda)}),$$

for some partition α with $\ell(\alpha) \leq n'$ and $\alpha_1 \leq \lambda_1$.

(23)

$$c_{\mu, \nu}^{\lambda} = c_{\mu^{\text{ti}}, \alpha \cup ((\lambda_1 - \sigma)^{\tau}) + (\sigma^{\ell(\lambda)})}^{\lambda^{\text{ti}} \cup ((\lambda_1 - \sigma)^{\tau}) + (\sigma^{\ell(\lambda)})} \quad (21), (22)$$

$$= c_{\alpha \cup ((\lambda_1 - \sigma)^{\tau}) + (\sigma^{\ell(\lambda)}), \mu^{\text{ti}}}^{\lambda^{\text{ti}} \cup ((\lambda_1 - \sigma)^{\tau}) + (\sigma^{\ell(\lambda)})} \quad (9)$$

$$= c_{\alpha, \mu^{\text{ti}}}^{\lambda^{\text{ti}}} \quad \text{Proposition 2.8, } \alpha_1 \leq \lambda_1 - \sigma \text{ and } \ell(\alpha) \leq \ell(\lambda) - \tau$$

$$= c_{\mu^{\text{ti}}, \alpha}^{\lambda^{\text{ti}}} \quad (9)$$

Notice that the above equality holds for all ν such that $\ell(\nu) \leq n$ and $c_{\mu, \nu}^{\lambda} \neq 0$, and all α such that $\ell(\alpha) \leq n'$ and $c_{\mu^{\text{ti}}, \alpha}^{\lambda^{\text{ti}}} \neq 0$. Therefore if $s_{(\lambda/\mu)^{\text{ti}}}(x_1, \dots, x_{n'})$ is not multiplicity-free, by (23), we can find ν such that $c_{\mu, \nu}^{\lambda} > 1$ as well. By (2) we are done. \square

Proposition 2.12. *If λ/μ is a skew partition, then*

$$s_{\lambda/\mu}(x_1, \dots, x_n) = s_{(\lambda/\mu)^{\sigma}}(x_1, \dots, x_n).$$

Proof. If λ/μ is ordinary, then $(\lambda/\mu)^{\text{or}} = \lambda/\mu$ and the proof is trivial. If λ/μ is not ordinary, then $(\lambda/\mu)^{\text{or}} = \mu^{\vee((\lambda_1)^{\ell(\lambda)})}/\lambda^{\vee((\lambda_1)^{\ell(\lambda)})}$. Our result now follows from (11). \square

Proof of Theorem 1.8: We first show that $\lambda^{\text{red}}/\mu^{\text{red}} := (((\lambda/\mu)^{n\sharp})^{\text{ba}})^{\text{ti}}$ is n -sharp, basic, tight, and ordinary. It follows from Definition 1.3 that $(\lambda/\mu)^{n\sharp}$ is n -sharp. The basic demolition of $(\lambda/\mu)^{n\sharp}$ does not increase the number of boxes in any column, and hence is n -sharp and, by construction, basic.

Let $\alpha/\beta = (\alpha_1^{c_1}, \dots, \alpha_r^{c_r})/(\beta_1^{d_1}, \dots, \beta_s^{d_s})$ be a n -sharp and basic skew partition. The tight demolition of α/β does not increase the number of boxes in any row or column, and hence is n -sharp. By definition the tight demolition of α/β deletes all empty rows and columns and hence is basic. It remains to show that the tight demolition of α/β is tight. Let us consider the following four cases:

Case 1 ($\tau(\alpha/\beta) = \sigma(\alpha/\beta) = 0$): By definition $(\alpha/\beta)^{\text{ti}} = (\alpha/\beta)^{\text{ba}} = \alpha/\beta$. Since α/β is tight, the tight demolition is tight.

Case 2 ($\tau(\alpha/\beta) \neq 0, \sigma(\lambda/\beta) = 0$): By definition, $(\alpha_1^{c_1 - \tau(\alpha/\beta)}, \dots, \alpha_r^{c_r})/(\beta_1^{d_1}, \dots, \beta_s^{d_s})$ is tight and $\ell(\beta) = c_1 - \tau(\alpha/\beta)$. Therefore $(\alpha_1^{c_1 - \tau(\alpha/\beta)}, \dots, \alpha_r^{c_r})/(\beta_1^{d_1}, \dots, \beta_s^{d_s})$ does not have empty rows. If there are also no empty columns, then $(\alpha/\beta)^{\text{ti}} = (\alpha_1^{c_1 - \tau(\alpha/\beta)}, \dots, \alpha_r^{c_r})/(\beta_1^{d_1}, \dots, \beta_s^{d_s})$ is tight. Suppose column z is empty, then we have $\beta_r \geq z$ and $\alpha_2 < z$. As a result, $(r, c) \in (\alpha_1^{c_1 - \tau(\alpha/\beta)}, \dots, \alpha_r^{c_r})/(\beta_1^{d_1}, \dots, \beta_s^{d_s})$ implies that $(r, c) \in [1, c_1 - \tau(\alpha/\beta)] \times [z + 1, \alpha_1] \cup [c_1 - \tau(\alpha/\beta) + 1, \ell(\alpha) - \tau(\alpha/\beta)] \times [1, z - 1]$. Since the row sets and column sets of the two rectangular boxes are disjoint, there are no rows with α_1 boxes or columns with $\ell(\alpha) - \tau(\alpha/\beta)$ boxes and thus $(\alpha/\beta)^{\text{ti}}$ is tight.

Case 3 ($\tau(\alpha/\beta) = 0, \sigma(\lambda/\beta) \neq 0$): Since $(\alpha/\beta)^T$ satisfies the condition in Case 2, we know $((\alpha/\beta)^T)^{\text{ti}}$ is tight. Since taking the transpose does not affect tightness, $(\alpha/\beta)^{\text{ti}} = (((\alpha/\beta)^T)^{\text{ti}})^T$ is also tight.

Case 4 ($\tau(\alpha/\beta) \neq 0, \sigma(\lambda/\beta) \neq 0$): Since $\beta \neq \emptyset$, we know $\alpha_r - \sigma(\alpha/\beta) > 0$ and $c_1 - \tau(\alpha/\beta) > 0$. Since α is not a rectangle, $\alpha_1 > \alpha_r$ and $c_2 > 0$. Combining $c_1 - \tau(\alpha/\beta) > 0$ and $\alpha_1 > \alpha_r$, we get $[1, c_1 - \tau(\alpha/\beta)] \times [\alpha_r + 1, \alpha_1] \subseteq ((\alpha_1 - \sigma(\alpha/\beta))^{c_1 - \tau(\alpha/\beta)}, \dots, (\alpha_r - \sigma(\alpha/\beta))^{c_r})/(\beta_1^{d_1}, \dots, \beta_s^{d_s})$. Combining $\alpha_r - \sigma(\alpha/\beta) > 0$ and $c_2 > 0$, we get $[c_1 - \tau(\alpha/\beta) + 1, \ell(\alpha) - \tau(\alpha/\beta)] \times [1, \alpha_r - \sigma(\alpha/\beta)] \subseteq ((\alpha_1 - \sigma(\alpha/\beta))^{c_1 - \tau(\alpha/\beta)}, \dots, (\alpha_r - \sigma(\alpha/\beta))^{c_r})/(\beta_1^{d_1}, \dots, \beta_s^{d_s})$. Notice that there are no empty column or row in $((\alpha_1 - \sigma(\alpha/\beta))^{c_1 - \tau(\alpha/\beta)}, \dots, (\alpha_r - \sigma(\alpha/\beta))^{c_r})/(\beta_1^{d_1}, \dots, \beta_s^{d_s})$. Therefore $(\alpha/\beta)^{\text{ti}}$ is tight by definition.

Since we have exhaust all possible cases of α/β , we conclude that the tight demolition of α/β is tight.

Let $\alpha/\beta = (\alpha_1^{c_1}, \dots, \alpha_r^{c_r})/(\beta_1^{d_1}, \dots, \beta_s^{d_s})$ be a n -sharp, basic, and tight skew partition that is not ordinary. Then $(\alpha/\beta)^{\text{or}}$ is the skew partition with the same number of rows and columns as α/β that results from rotating α/β by 180 degrees. Thus $(\alpha/\beta)^{\text{or}}$ is n -sharp and basic. Fixing the rectangle $((\alpha_1)^{\ell(\alpha)})$, we have $(\alpha/\beta)^{\text{or}} = \beta^{\vee}/\alpha^{\vee}$ with $\beta^{\vee} = ((\alpha_1)^{\ell(\alpha) - \ell(\beta)}, (\alpha_1 - \beta_s)^{d_s}, \dots, (\alpha_1 - \beta_1)^{d_1})$. Since α/β is basic, $\ell(\alpha) > \ell(\beta)$ and hence the first row of β^{\vee} has α_1 boxes. Suppose that $(\alpha/\beta)^{\text{or}}$ is not tight. This means $(\alpha/\beta)^{\text{or}}$ contains a row with α_1 boxes. Since $(\alpha/\beta)^{\text{or}}$ is the 180 degree rotation of α/β this implies that α/β contains a row with α_1 boxes. That is, α/β is not tight, a contradiction.

Since α/β is not ordinary, this implies

$$(24) \quad \text{np}(\alpha) - 1 > \text{np}(\beta).$$

If we fix the rectangle $((\alpha_1)^{\ell(\alpha)})$, then $(\alpha/\beta)^{\text{or}} = \beta^\vee/\alpha^\vee$. Then, since α/β is basic, $\text{np}(\beta^\vee) = \text{np}(\beta) + 1$ and $\text{np}(\alpha^\vee) = \text{np}(\alpha) - 1$. Hence, (24) implies

$$(25) \quad \text{np}(\beta^\vee) - 1 = \text{np}(\beta) < \text{np}(\alpha) - 1 = \text{np}(\alpha^\vee),$$

which means $(\alpha/\beta)^{\text{or}}$ is ordinary.

The multiplicity-freeness claim is a corollary of Propositions 2.8, 2.9, 2.11, and 2.12. \square

3. MULTIPLICITY-FREE UPPER BOUNDS

We reformulate Theorem 1.10 in the following equivalent way:

Theorem 3.1. *Let $s_{\lambda/\mu}(x_1, \dots, x_n)$ be a basic, n -sharp, tight, ordinary skew Schur polynomial where $\lambda = (\lambda_1^{l_1}, \lambda_2^{l_2}, \dots, \lambda_p^{l_p})$ and $\mu = (\mu_1^{k_1}, \mu_2^{k_2}, \dots, \mu_q^{k_q})$. Fix the rectangle $(\lambda_1^{\ell(\lambda)})$ and set $\rho = \rho(\lambda/\mu)$. Then $s_{\lambda/\mu}(x_1, \dots, x_n)$ is multiplicity-free if and only if λ, μ satisfy at least one of:*

- (I) λ^\vee is a rectangle of shortness 1 or an empty partition.
- (II) λ^\vee is a rectangle of shortness 2 and μ is a fat hook.
- (III) λ^\vee is a rectangle and μ is a fat hook of shortness 1.
- (IV) λ^\vee and μ are both rectangles.
- (V) λ^\vee is a rectangle of shortness at least 3, μ is a fat hook of shortness at least 2, $\lambda_2 = \mu_1$, $l_2 > k_1$ and $n = \rho + 1$.
- (VI) λ^\vee is a rectangle of shortness at least 3, μ is a fat hook of shortness at least 2, $\lambda_2 = \mu_1$, $l_2 \leq k_1$ and $n = \rho + 1$ or $\rho + 2$.
- (VII) λ^\vee is a rectangle of shortness at least 3, μ is a fat hook of shortness at least 2, $\mu_1 > \lambda_2 > \mu_2$, $k_1 \geq l_2$ and $n = \rho + 1$.
- (VIII) λ^\vee is a rectangle of shortness at least 3, μ is a fat hook of shortness at least 2, $l_2 \geq l_1$, $\mu_2 = \lambda_2$ and $n = \rho + 1$ or $\rho + 2$.
- (IX) λ^\vee is a rectangle of shortness at least 3, μ is a fat hook of shortness at least 2, $l_1 > l_2$, $\mu_2 = \lambda_2$ and $n = \rho + 1$.
- (X) λ^\vee is a rectangle of shortness at least 2, $\text{np}(\mu) > 2$, $\lambda_2 = \mu_q$, $l_2 \geq l_1$ and $n = \rho + 1$.
- (XI) λ^\vee is a rectangle of shortness at least 2, $\text{np}(\mu) > 2$, $\mu_1 = \lambda_2$, $k_1 \geq l_2$ and $n = \rho + 1$.

Note that we don't need to consider the case where $n \leq \rho$ since the skew Schur polynomial would not be n -sharp.

Theorem 3.2 ([G10], [TY10]). *Let λ/μ be a basic, ordinary skew partition and fix the rectangle $(\lambda_1^{\ell(\lambda)})$. The skew Schur function $s_{\lambda/\mu}$ is multiplicity-free if and only if one of the following holds:*

- (I) either λ^\vee is a rectangle of shortness 1 or an empty partition.
- (II) λ^\vee is a rectangle of shortness 2 and μ is a fat hook.
- (III) λ^\vee is a rectangle and μ is a fat hook of shortness 1.
- (IV) λ^\vee and μ are both rectangles.

In order to classify all multiplicity-free skew Schur polynomials, it is enough to find, for each basic, tight, ordinary skew partition λ/μ the minimal integer $m(\lambda/\mu)$ such that λ/μ is $m(\lambda/\mu)$ -sharp and $s_{\lambda/\mu}(x_1, \dots, x_{m(\lambda/\mu)})$ is not multiplicity-free. As a result of Theorem 3.2, we only need to consider the basic, tight, ordinary skew partitions λ/μ that satisfies any of the three following conditions:

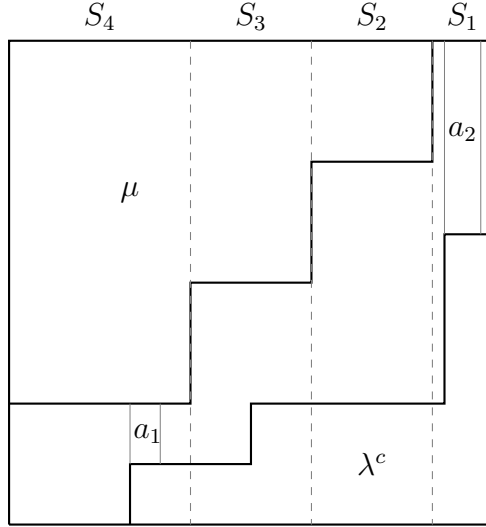

FIGURE 1

- (I) λ^\vee is a rectangle of shortness at least 3 and μ is a fat hook of shortness at least 2;
- (II) λ^\vee is a rectangle of shortness at least 2 and $\text{np}(\mu) \geq 3$;
- (III) $\text{np}(\lambda^\vee), \text{np}(\mu) \geq 2$.

In this section, we will find upper bounds on $m(\lambda/\mu)$ for λ/μ satisfying each of the three conditions. For the rest of this section, we fix $\lambda = (\lambda_1^{l_1}, \lambda_2^{l_2}, \dots, \lambda_p^{l_p})$ and $\mu = (\mu_1^{k_1}, \mu_2^{k_2}, \dots, \mu_q^{k_q})$ with $p = \text{np}(\lambda)$ and $q = \text{np}(\mu)$.

3.1. Both $\text{np}(\lambda^\vee)$ and $\text{np}(\mu)$ are at least 2.

Theorem 3.3. *Let $s_{\lambda/\mu}(x_1, \dots, x_n)$ be a basic, n -sharp, tight skew Schur polynomial such that neither λ^\vee nor μ is a rectangle, then $s_{\lambda/\mu}(x_1, \dots, x_n)$ is not multiplicity-free (or equivalently, $m(\lambda/\mu) = \rho + 1$).*

For $1 \leq c \leq \lambda_1$, let $U(c) := \min\{r : (r, c) \in \lambda/\mu\}$ and $L(c) := \max\{r : (r, c) \in \lambda/\mu\}$. For the rest of this section, we fix $\lambda = (\lambda_1^{l_1}, \dots, \lambda_p^{l_p})$ and $\mu = (\mu_1^{k_1}, \dots, \mu_q^{k_q})$ with $p = \text{np}(\lambda)$ and $q = \text{np}(\mu)$.

Lemma 3.4. *If neither λ^\vee nor μ is a rectangle, then at least one of the following is true:*

- (I) *There exist three columns indexed by c_1, c_2, c_3 in λ/μ such that $U(c_1), U(c_2), U(c_3)$ are all distinct, and $L(c_1), L(c_2), L(c_3)$ are all distinct.*
- (II) *There exist four columns indexed by c_1, c_2, c_3, c_4 in λ/μ such that $U(c_1) = U(c_2), L(c_3) = L(c_4), U(c_1), U(c_3), U(c_4)$ are all distinct, and $L(c_1), L(c_2), L(c_3)$ are all distinct.*

Proof. Since μ and λ^\vee are not rectangles, $p \geq 3$ and $q \geq 2$. For $1 \leq i \leq q + 1$, set $S_i = \{\mu_i + 1, \dots, \mu_{i-1}\}$, where $\mu_0 = \lambda_1$ and $\mu_{q+1} = 0$.

By construction,

$$(26) \quad U(c) = U(d) \text{ for } c, d \in S_i$$

and

$$(27) \quad U(c) < U(d) \text{ for } c \in S_i, d \in S_j \text{ with } i > j$$

Denote

$$(28) \quad a_1 = \min\{k : L(k) < \ell(\lambda)\} \text{ and } a_2 = \min\{k : L(k) = l_1\}.$$

Note that by construction $L(1) > L(a_1) > L(a_2) = L(\lambda_1)$, so in particular $1 < a_1 < a_2$. If $a_1 \notin S_1 \cup S_{q+1}$, then columns 1, a_1 and λ_1 satisfy Lemma 3.4 (I).

If $a_1 \in S_1$, then $a_1 < a_2$ implies $a_2 \in S_1$. Set $c_1 = a_1, c_2 = a_2$, and $c_3 = \max(S_2), c_4 = \max(S_3)$. Notice that $U(c_1) = U(c_2)$ by (26), with $U(c_1), U(c_3), U(c_4)$ all distinct by (27). Since c_1 is the minimum index such that $L(c_1) < \ell(\lambda)$ and $c_1 \in S_1$, we have $L(c_3) = L(c_4) = \ell(\lambda)$. Finally, $L(c_1) = \ell(\lambda) - l_p, L(c_2) = l_1, L(c_3) = \ell(\lambda)$ are all distinct. Thus these four columns satisfy Lemma 3.4 (II).

If $a_1 \in S_{q+1}$ and $a_2 \leq \min(S_q)$, then let $c_1 = 1, c_2 = a_1, c_3 = \min(S_q)$, and $c_4 = \lambda_1$. Then $U(c_1) = U(c_2)$ by (26), and $U(c_1), U(c_3), U(c_4)$ are all distinct by (27). Since $a_2 = \min\{k : L(k) = l_1\}$ and $a_2 \leq c_3$, then $L(c_3) = L(c_4) = l_1$. Furthermore, $L(c_1) = \lambda_1, L(c_2) = \ell(\lambda) - l_p$, and $L(c_3) = l_1$ are all distinct. Hence c_1, c_2, c_3 , and c_4 satisfy Lemma 3.4(II).

If $a_1 \in S_{q+1}$ and $a_2 > \min(S_q)$, then columns 1, $\min(S_q)$, and λ_1 satisfy Lemma 3.4(I). Since we have exhausted all possibilities for a_1 and a_2 , we conclude that either Lemma 3.4 (I) or (II) always hold. \square

Proposition 3.5. *If there exist columns c_1, c_2, c_3 in λ/μ such that $U(c_1), U(c_2), U(c_3)$ are all distinct and $L(c_1), L(c_2), L(c_3)$ are all distinct, then $s_{\lambda/\mu}(x_1, \dots, x_{\rho+1})$ is not multiplicity-free.*

Proof. First consider the case where λ/μ consists of only those three columns, and without loss of generality say that $c_1 = 3, c_2 = 2$, and $c_3 = 1$. Let $\rho_i := \text{CS}_{c_i}(\lambda/\mu)$ for $i \in \{1, 2, 3\}$.

Our goal is to construct two distinct ballot fillings of λ/μ with the same content. In both fillings, we fill column c_1 with the numbers from 1 to ρ_1 . The entries of column c_2 and column c_3 will depend on the relative sizes of ρ_1, ρ_2 , and ρ_3 :

Case 1 ($\rho_1 \leq \rho_2 < \rho_3$): For Filling 1, fill column c_2 with $[\rho_2]$ and column c_3 with $[\rho_3 + 1] \setminus \{\rho_1\}$. For Filling 2, fill column c_2 with $[\rho_2 + 1] \setminus \{\rho_1\}$ and column c_3 with $[\rho_3 + 1] \setminus \{\rho_2 + 1\}$.

Case 2 ($\rho_1 < \rho_3 \leq \rho_2$): For Filling 1, fill column c_2 with $[\rho_2]$ and column c_3 with $([\rho_3] \setminus \{\rho_1\}) \cup \{\rho_2 + 1\}$. For Filling 2, fill column c_2 with $[\rho_2 + 1] \setminus \{\rho_1\}$ and column c_3 with $[\rho_3]$.

Case 3 ($\rho_2 \leq \rho_1 < \rho_3$): For Filling 1, fill column c_2 with $[\rho_2]$ and column c_3 with $[\rho_3 + 1] \setminus \{\rho_2\}$. For Filling 2, fill column c_2 with $[\rho_2 - 1] \cup \{\rho_1 + 1\}$ and column c_3 with $[\rho_3 + 1] \setminus \{\rho_1 + 1\}$.

Case 4 ($\rho_2 < \rho_3 \leq \rho_1$): For Filling 1, fill column c_2 with $[\rho_2]$ and column c_3 with $([\rho_3] \setminus \{\rho_2\}) \cup \{\rho_1 + 1\}$. For Filling 2, fill column c_2 with $[\rho_2 - 1] \cup \{\rho_1 + 1\}$ and column c_3 with $[\rho_3]$.

Case 5 ($\rho_3 \leq \rho_1 \leq \rho_2$): For Filling 1, fill column c_2 with $[\rho_2]$ and column c_3 with $[\rho_3 - 1] \cup \{\rho_2 + 1\}$. For Filling 2, fill column c_2 with $[\rho_2 + 1] \setminus \{\rho_1\}$ and column c_3 with $[\rho_3 - 1] \cup \{\rho_1\}$.

Case 6 ($\rho_3 \leq \rho_2 \leq \rho_1$): For Filling 1, fill column c_2 with $[\rho_2]$ and column c_3 with $[\rho_3 - 1] \cup \{\rho_1 + 1\}$. For Filling 2, fill column c_2 with $[\rho_2 - 1] \cup \{\rho_1 + 1\}$ and column c_3 with $[\rho_3 - 1] \cup \{\rho_2\}$.

In all of the above cases, both fillings have the same content, and they are strictly increasing within columns. Similarly, in all cases the column reading word is ballot. It remains to show that the fillings are weakly increasing within rows.

Claim 3.6. *Let T be any one of the fillings defined in the six cases above.*

(I) *If $(r, c_2), (r, c_3) \in \lambda/\mu$, then $T(r, c_3) \leq T(r, c_2)$.*

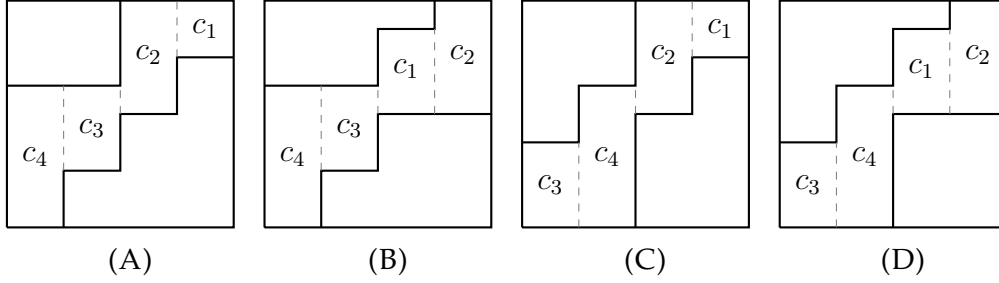

FIGURE 2

(II) If $(r, c_1), (r, c_2) \in \lambda/\mu$, then $T(r, c_2) \leq T(r, c_1)$.

Proof. We first prove (I). Since $U(c_3) > U(c_2)$, at most the top $\rho_2 - 1$ boxes of column c_3 are to the left of a box in column c_2 . In addition, there is at least one box in column c_2 in a higher row than the highest box in column c_3 . Similarly, because $L(c_3) > L(c_2)$, at most the top $\rho_3 - 1$ labels of c_3 are to the left of a label of column c_2 .

Combining these two facts, we know that at most the top $\min(\rho_2, \rho_3) - 1$ boxes in column c_3 have a box in column c_2 directly to the right. Notice that in all of the cases of the fillings above, for $1 \leq k \leq \min(\rho_2, \rho_3) - 1$, the k^{th} box from the top of column c_3 has a value of at most $k + 1$, and its right neighbor is at least the $(k + 1)^{\text{th}}$ box from the top of column c_2 . Thus even if column c_2 was minimally filled, its entries would still be larger than the corresponding entries in column c_3 , which proves the claim.

The proof of (II) follows by the same logic as the proof of (I). \square

This completes the proof in the case where λ/μ consists of exactly three columns. If λ/μ has more than three columns, then let λ^*/μ^* be the skew shape consisting of only the three columns indexed by c_1, c_2 , and c_3 in the statement of the theorem. By Corollary 2.5, $s_{\lambda^*/\mu^*}(x_1, \dots, x_{\rho(\lambda^*/\mu^*)+1})$ is not multiplicity-free implies $s_{\lambda/\mu}(x_1, \dots, x_{\rho(\lambda/\mu)+1})$ is not multiplicity-free. \square

Proposition 3.7. *Suppose there exist columns c_1, c_2, c_3, c_4 in λ/μ such that either $U(c_1) = U(c_2)$ or $L(c_1) = L(c_2)$ but not both, either $U(c_1) = U(c_2)$ or $L(c_1) = L(c_2)$ but not both, and $U(c_i) \neq U(c_j)$ and $L(c_i) \neq L(c_j)$ for all $i \in \{1, 2\}$ and $j \in \{3, 4\}$. If neither λ^\vee nor μ are rectangles of shortness 1, then $s_{\lambda/\mu}(x_1, \dots, x_{\rho+1})$ is not multiplicity-free.*

Proof. Consider the case where λ/μ consists of only those four columns c_1, c_2, c_3, c_4 . Without loss of generality say $\{c_1, c_2\} = \{3, 4\}$ and $\text{CS}_{c_1}(\lambda/\mu) < \text{CS}_{c_2}(\lambda/\mu)$, and $\{c_3, c_4\} = \{1, 2\}$ with $\text{CS}_{c_3}(\lambda/\mu) < \text{CS}_{c_4}(\lambda/\mu)$. There are four possible arrangements of c_1 through c_4 as shown in Figure 2. Let $\rho_i := \text{CS}_{c_i}(\lambda/\mu)$ for $i \in \{1, 2, 3, 4\}$.

We want to construct two distinct ballot fillings of λ/μ with the same content. In both fillings, we fill column c_1 and c_2 with $[\rho_1]$ and $[\rho_2]$ respectively. The entries of column c_3 and c_4 depend on the relative sizes of $\rho_1, \rho_2, \rho_3, \rho_4$ and the relative sizes of c_3 and c_4 .

Case 1 ($c_3 > c_4, \rho_2 \geq \rho_4, \rho_4 - 1 \geq \rho_1 + 1, \rho_3 \geq \rho_1$): For Filling 1, fill column c_3 with $[\rho_3 + 1] \setminus \{\rho_1\}$ and column c_4 with $([\rho_4] \setminus \{\rho_3 + 1\}) \cup \{\rho_2 + 1\}$. For Filling 2, fill column c_3 with $([\rho_3] \setminus \{\rho_1\}) \cup \{\rho_2 + 1\}$ and column c_4 with $[\rho_4]$.

Case 2 ($c_3 > c_4, \rho_2 \geq \rho_4, \rho_4 - 1 \geq \rho_1 + 1, \rho_3 < \rho_1$): For Filling 1, fill column c_3 with $[\rho_3 - 1] \cup \{\rho_1 + 1\}$ and column c_4 with $([\rho_4] \setminus \{\rho_1 + 1\}) \cup \{\rho_2 + 1\}$. For Filling 2, fill column c_3 with $[\rho_3 - 1] \cup \{\rho_2 + 1\}$ and column c_4 with $[\rho_4]$.

Case 3 ($c_3 > c_4, \rho_2 \geq \rho_4, \rho_4 - 1 < \rho_1 + 1$): For Filling 1, fill column c_3 with $[\rho_3 - 1] \cup \{\rho_1 + 1\}$ and column c_4 with $[\rho_4 - 1] \cup \{\rho_2 + 1\}$. For Filling 2, fill column c_3 with $[\rho_3 - 1] \cup \{\rho_2 + 1\}$ and column c_4 with $[\rho_4 - 1] \cup \{\rho_1 + 1\}$.

Case 4 ($c_3 > c_4, \rho_2 < \rho_4, \rho_3 \geq \rho_2$): For Filling 1, fill column c_3 with $[\rho_3 + 1] \setminus \{\rho_1\}$ and column c_4 with $[\rho_4 + 1] \setminus \{\rho_2\}$. For Filling 2, fill column c_3 with $[\rho_3 + 2] \setminus \{\rho_1, \rho_2\}$ and column c_4 with $[\rho_4 + 1] \setminus \{\rho_3 + 2\}$.

Case 5 ($c_3 > c_4, \rho_2 < \rho_4, \rho_3 < \rho_2, \rho_1 \geq \rho_3$): For Filling 1, fill column c_3 with $[\rho_3 - 1] \cup \{\rho_1 + 1\}$ and column c_4 with $[\rho_4 + 1] \setminus \{\rho_1 + 1\}$. For Filling 2, fill column c_3 with $[\rho_3 - 1] \cup \{\rho_2 + 1\}$ and column c_4 with $[\rho_4 + 1] \setminus \{\rho_2 + 1\}$.

Case 6 ($c_3 > c_4, \rho_2 < \rho_4, \rho_3 < \rho_2, \rho_1 < \rho_3$): For Filling 1, fill column c_3 with $[\rho_3 + 1] \setminus \{\rho_1\}$ and column c_4 with $[\rho_4 + 1] \setminus \{\rho_3 + 1\}$. For Filling 2, fill column c_3 with $([\rho_3] \setminus \{\rho_1\}) \cup \{\rho_2 + 1\}$ and column c_4 with $[\rho_4 + 1] \setminus \{\rho_2 + 1\}$.

Case 7 ($c_3 < c_4, \rho_2 \geq \rho_4, \rho_4 - 1 < \rho_1 + 1$): For Filling 1, fill column c_3 with $[\rho_3 - 1] \cup \{\rho_1 + 1\}$ and column c_4 with $[\rho_4 - 1] \cup \{\rho_2 + 1\}$. For Filling 2, fill column c_3 with c_3 with $[\rho_3 - 1] \cup \{\rho_4 - 1\}$ and column c_4 with $[\rho_4 - 2] \cup \{\rho_1 + 1, \rho_2 + 1\}$.

Case 8 ($c_3 < c_4, \rho_2 \geq \rho_4, \rho_4 - 1 \geq \rho_1 + 1, \rho_1 \geq \rho_3$): For Filling 1, fill column c_3 with $[\rho_3 - 1] \cup \{\rho_1\}$ and column c_4 with $([\rho_4] \setminus \{\rho_1\}) \cup \{\rho_2 + 1\}$. For Filling 2, fill column c_3 with $[\rho_3 - 1] \cup \{\rho_4\}$ and column c_4 with $[\rho_4 - 1] \cup \{\rho_2 + 1\}$.

Case 9 ($c_3 < c_4, \rho_2 \geq \rho_4, \rho_4 - 1 \geq \rho_1 + 1, \rho_1 < \rho_3$): For Filling 1, fill column c_3 with $([\rho_3] \setminus \{\rho_1\}) \cup \{\rho_4\}$ and column c_4 with $[\rho_4 - 1] \cup \{\rho_2 + 1\}$. For Filling 2, fill column c_3 with $[\rho_3]$ and column c_4 with $([\rho_4] \setminus \{\rho_1\}) \cup \{\rho_2 + 1\}$.

Case 10 ($c_3 < c_4, \rho_2 < \rho_4, \rho_2 \leq \rho_3$): For Filling 1, fill column c_3 with $[\rho_3 + 1] \setminus \{\rho_1\}$ and column c_4 with $[\rho_4 + 1] \setminus \{\rho_2\}$. For Filling 2, fill column c_3 with $[\rho_3 + 1] \setminus \{\rho_2\}$ and column c_4 with $[\rho_4 + 1] \setminus \{\rho_1\}$.

Case 11 ($c_3 < c_4, \rho_2 < \rho_4, \rho_2 > \rho_3, \rho_3 > \rho_1$): For Filling 1, fill column c_3 with $([\rho_3] \setminus \{\rho_1\}) \cup \{\rho_2\}$ and column c_4 with $[\rho_4 + 1] \setminus \{\rho_2\}$. For Filling 2, fill column c_3 with $[\rho_3]$ and column c_4 with $[\rho_4 + 1] \setminus \{\rho_1\}$.

Case 12 ($c_3 < c_4, \rho_2 < \rho_4, \rho_2 > \rho_3, \rho_3 \leq \rho_1$): For Filling 1, fill column c_3 with $[\rho_3 - 1] \cup \{\rho_1\}$ and column c_4 with $[\rho_4 + 1] \setminus \{\rho_2\}$. For Filling 2, fill column c_3 with $[\rho_3 - 1] \cup \{\rho_2\}$ and column c_4 with $[\rho_4 + 1] \setminus \{\rho_1\}$.

In all of the above cases, both fillings have the same content, and they are strictly increasing within columns. Similarly, in all cases the column reading word is ballot. It remains to show that the fillings are weakly increasing within rows.

For each pair of indices (c_1, c_2) or (c_3, c_4) , the fillings described above are weakly increasing within rows for those column pairs. Let $c'' = \max\{c_3, c_4\}$ and $c' = \min\{c_1, c_2\}$. It remains to show that the fillings described above are weakly increasing within rows for the column pair c' and c'' .

Claim 3.8. *Let T be any one of the fillings defined in the twelve cases above. If $(r, c''), (r, c') \in \lambda/\mu$, then $T(r, c'') \leq T(r, c')$.*

Proof. Let $\rho'' = \text{CS}_{c''}(\lambda/\mu)$. Because $U(c'') > U(c')$ and $\text{CS}_{c'}(\lambda/\mu) \leq \rho_2$, at most the top $\rho_2 - 1$ boxes of column c'' are to the left of a box in column c' . In addition, the boxes in column c' have at least one more box above them than the corresponding box in column c'' . Similarly, because $L(c'') > L(c')$, at most the top $\rho'' - 1$ boxes of column c'' are to the left of a box in column c' . Combining these two facts, we know that at most the top $\min(\rho_2, \rho'') - 1$ boxes in column c'' have a box in c' directly to the right of it.

Observe that in nearly all of the cases above, for $1 \leq k \leq \min(\rho_2, \rho'') - 1$, the k^{th} box from the top of column c'' has an entry of at most $k + 1$, and its right neighbor has at least k boxes above it. Even if column c' was minimally filled, its entries would still be at least the value of the corresponding entries in column c'' . This proves the claim in these cases.

There are only two exceptions to the above observation: Case 4 and Case 7.

In Case 4, the only box contradicting the observation is the box that is $\rho_2 - 1$ from the top of column $c'' = c_3$, which has value $\rho_2 + 1$. This would violate semistandardness if and only if

$$(29) \quad c' = c_2 \text{ and } U(c_2) = U(c_3) - 1.$$

In this case μ is a rectangle of shortness 1, and thus (29) can not be satisfied.

In Case 7, the only box contradicting the observation is the box that is $\rho_4 - 1$ from the top of column $c'' = c_4$, which has value $\rho_1 + 1$. This would violate semistandardness if and only if

$$(30) \quad c' = c_1 \text{ and } L(c_1) = L(c_4) - 1.$$

In this case λ^\vee is a rectangle of shortness 1, and thus (30) can not be satisfied.

As a result, in all cases, both fillings of λ/μ are semistandard. \square

This completes the proof in the case where λ/μ consists of exactly four columns. If λ/μ has more than four columns, then let λ^*/μ^* be the skew shape consisting of the four columns in the statement of the theorem. If neither $(\lambda^*)^\vee$ nor μ^* is a rectangle of shortness 1, then we have shown that $s_{\lambda^*/\mu^*}(x_1, \dots, x_{\rho(\lambda^*/\mu^*)+1})$ is not multiplicity-free. By Corollary 2.5, $s_{\lambda^*/\mu^*}(x_1, \dots, x_{\rho(\lambda^*/\mu^*)+1})$ is not multiplicity-free implies $s_{\lambda/\mu}(x_1, \dots, x_{\rho(\lambda/\mu)+1})$ is not multiplicity-free.

On the other hand, suppose either $(\lambda^*)^\vee$ or μ^* is a rectangle of shortness 1 as in Figure 2(A) or Figure 2(D). Since neither λ^\vee nor μ is a rectangle of shortness 1, there must exist some other column c such that $U(c), U(c_i), U(c_j)$ are all distinct, and $L(c), L(c_i), L(c_j)$ are all distinct for some $1 \leq i < j \leq 4$. By Proposition 3.5, $s_{\lambda/\mu}(x_1, \dots, x_{\rho(\lambda/\mu)+1})$ is not multiplicity-free. \square

Proof of Theorem 3.3: The four columns defined in Lemma 3.4(II) satisfy the hypotheses in Proposition 3.7. Combining Lemma 3.4, Proposition 3.5 and Proposition 3.7, we conclude that $s_{\lambda/\mu}(x_1, \dots, x_{\rho+1})$ is not multiplicity-free. Thus all basic, n -sharp, tight skew Schur polynomials are not multiplicity-free if neither λ^\vee nor μ is not a rectangle.

3.2. λ^\vee is a rectangle of shortness at least 2 and $\text{np}(\mu) \geq 3$.

Theorem 3.9. *Let $s_{\lambda/\mu}(x_1, \dots, x_n)$ be a basic, n -sharp, tight skew Schur polynomial such that λ^\vee is a rectangle of shortness at least 2 and $\text{np}(\mu) > 2$, then $s_{\lambda/\mu}(x_1, \dots, x_n)$ is not multiplicity-free if one of the following conditions hold:*

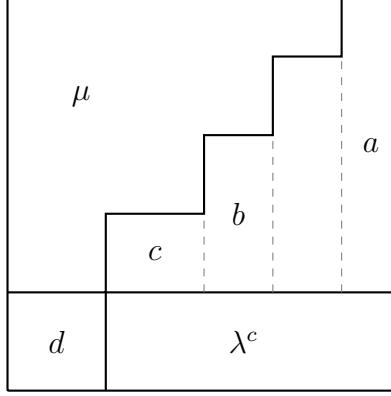

FIGURE 3. Case 1 in Theorem 3.9, with column lengths $a, b, c,$ and d .

- (I) $\lambda_2 = \mu_q, l_2 \geq l_1$ and $n \geq \rho + 2$
- (II) $\lambda_2 = \mu_q, l_2 < l_1$
- (III) $\lambda_2 = \mu_1, k_1 \geq l_2$ and $n \geq \rho + 2$
- (IV) $\lambda_2 = \mu_1, k_1 < l_2$.
- (V) $\mu_q < \lambda_2 < \mu_1$

Here we omit the cases where $\lambda_2 < \mu_q$ or $\lambda_2 > \mu_1$ since the skew partition λ/μ would be not basic if $\lambda_2 < \mu_q$ and $l_1 = \ell(\mu)$, and not tight otherwise.

Definition 3.10. For a basic skew-shape λ/μ , let $(\lambda/\mu)^{(-k)}$ be the skew-shape obtained by removing the top k boxes in each column of λ/μ and then applying a basic reduction.

Lemma 3.11. Let λ/μ be a basic skew diagram. If $k \leq \min\{CS_d(\lambda/\mu) : 1 \leq d \leq \lambda_1\}$, then $s_{(\lambda/\mu)^{(-k)}}(x_1, \dots, x_{n-k})$ is not multiplicity-free implies $s_{\lambda/\mu}(x_1, \dots, x_n)$ is not multiplicity-free.

Proof. If $s_{(\lambda/\mu)^{(-k)}}(x_1, \dots, x_{n-k})$ is not multiplicity-free, then there exists at least two ballot tableaux of shape $(\lambda/\mu)^{(-k)}$ with the same content ν with $\ell(\nu) \leq n - k$. Consider the following filling of λ/μ : fill in the top k boxes in each column with 1 through k , with values increasing downwards, and fill in the remaining shape by adding k to the corresponding entries in $(\lambda/\mu)^{(-k)}$. It is trivial, using Lemma 2.2, to show that the resulting two tableaux are ballot. Therefore $s_{\lambda/\mu}(x_1, \dots, x_n)$ is not multiplicity-free. \square

Lemma 3.12. If $w = w_1 w_2 \dots w_m$ is a ballot word, then the word $w^{(k)}$ obtained by concatenating $w_m + 1, \dots, w_m + k$ to the end of w is a ballot word.

Proof. For $k = 1$, it suffices to show that the number of occurrences of w_m in w is strictly greater than the number of occurrences of $w_m + 1$. Indeed, if not, then the sequence $w_1 \dots w_{m-1}$ is not ballot, contradicting our assumption that w is ballot. The lemma follows by induction on k \square

Proof of Theorem 3.9: Since λ^\vee is a rectangle and $\text{np}(\mu) \geq 2$, we have $q \geq 3, p = 2$.

Case 1 ($\lambda_2 = \mu_q$): As illustrated by Figure 3, set

$$\begin{aligned}
A &= \{\mu_1 + 1, \dots, \lambda_1\} & a &= l_1 = \text{CS}_k(\lambda/\mu) \text{ for } k \in A \\
B &= \{\mu_{q-1} + 1, \dots, \mu_{q-2}\} & b &= k_{q-1} + k_q = \text{CS}_k(\lambda/\mu) \text{ for } k \in B \\
C &= \{\mu_q + 1, \dots, \mu_{q-1}\} & c &= k_q = \text{CS}_k(\lambda/\mu) \text{ for } k \in C \\
D &= \{1, \dots, \mu_q\} & d &= l_2 = \text{CS}_k(\lambda/\mu) \text{ for } k \in D
\end{aligned}$$

Either a or d equals $\rho(\lambda/\mu)$, and by Corollary 2.4, it suffices for us to establish multiplicity in the case where

$$\lambda = (5^{l_1}, 2^{l_2}) \text{ and } \mu = (4^{k_1}, 3^{k_2}, 2^{k_3}).$$

In λ/μ there are exactly two D -columns and one each of the A, B and C -columns. In order to construct a ballot tableau, there is a unique way to fill the A, B and C -columns (fill each column with 1 through the length of that column).

We consider four subcases: Case 1.1 corresponds to Theorem 3.9 (I) while cases 1.2, 1.3 and 1.4 correspond to Theorem 3.9 (II).

Case 1.1 ($d \geq a$): In this case $\rho = d$. By Lemma 3.11, we reduce to the case where $c = 1$ by setting $k = c - 1$ in the lemma. For filling 1, fill in the right D -column with $[2, d + 2] \setminus \{a\}$ and the left D -column with $[d + 1] \setminus \{b\}$ as in Figure 4(A). For filling 2, fill in the right D -column with $[2, d + 2] \setminus \{b\}$ and the left D -column with $[d + 1] \setminus \{a\}$ as in Figure 4(B). The second filling is obtained from the first by swapping the red entries in the figure with the blue entries, maintaining their vertical order.

It remains to show these are ballot tableaux. The two tableaux are semistandard by construction. Let u and v be the column reading words of filling 1 and 2, respectively. To show that u and v are ballot, it suffices, by Lemma 3.12, to show that the initial factors of u and v that terminate at the underlined entries in Figure 4 are ballot.

In the first filling, Figure 4(A), since $c = 1$, there are three entries equal to 1 and two entries equal to 2 before the underlined 2 in u . There is one entry equal to a , and none equal to $a + 1$, before the underlined $a + 1$ in u . Finally, there are three entries equal to b , and two equal to $b + 1$, before the underlined $b + 1$ in u . Therefore this filling is ballot. By similar reasoning, we conclude that the second filling, Figure 4(B), is ballot. As a result, $s_{\lambda/\mu}(x_1, \dots, x_{\rho+2})$ is not multiplicity-free in this case.

Case 1.2 ($d \leq c + 1$): In this case $\rho = a$. By Lemma 3.11, we reduce to $d = 2$. Consider the filling of the skew partition in Figure 5 and a second filling obtained by swapping the red $b + 1$ -entry with the blue $c + 1$ -entry in the figure. Both tableaux are semistandard. Let u and v be the column reading words of filling 1 and 2, respectively. The initial factors of u and v , ending at the c in the C column, are both ballot. There is one entry equal to a , zero entries equal to $a + 1$, two entries equal to b , one entry equal to $b + 1$, three entries equal to c , and two entries equal to $c + 1$ in each of the two initial factors. As a result both u and v are ballot and thus $s_{\lambda/\mu}(x_1, \dots, x_{\rho+1})$ is not multiplicity-free.

Case 1.3 ($c + 1 < d \leq b$): In this case $\rho = a$. By Lemma 3.11, we reduce to $c = 1$. For filling 1, fill in the right D -column with $[2, d] \cup \{a + 1\}$ and the left D -column with $[d - 1] \cup \{b + 1\}$ as in Figure 6. For filling 2, fill in the right D -column with $[2, d - 1] \cup \{b + 1, a + 1\}$ and the left D -column with $[d]$. Filling 2 arises from filling 1 by swapping the blue $b + 1$ with the red d in the figure. It is again clear that the two tableaux are semistandard. Let u and v be the column reading words of filling 1 and 2, respectively. The initial factors of u and

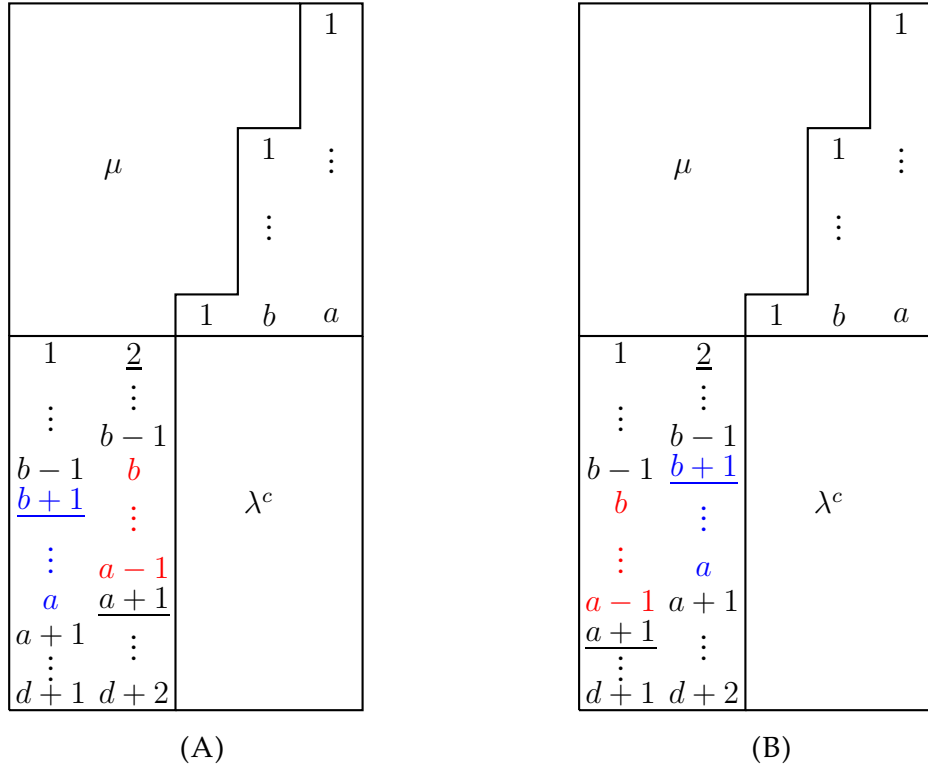

FIGURE 4. Two fillings in Case 1.1

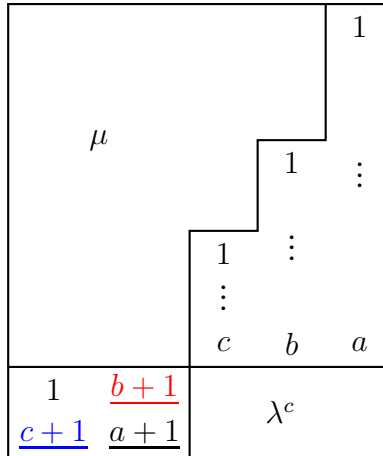

FIGURE 5. Filling in Case 1.2

v , ending at the 1 in the C -column, are both ballot. There is one entry equal to a , zero entries equal to $a + 1$, two entries equal to b , and one entry equal to $b + 1$ in each of the two initial factors. This, combined with Lemma 3.12, implies that u and v are ballot. Thus $s_{\lambda/\mu}(x_1, \dots, x_{\rho+1})$ is not multiplicity-free.

Case 1.4 ($b < d < a$): In this case $\rho = a$. By Lemma 3.11, we reduce to $c = 1$. For filling 1, fill in the right D -column with $[2, d] \cup \{a + 1\}$ and the left D -column with $[d + 1] \setminus \{b\}$ as in Figure 7(A). For filling 2, fill in the right D -column with $[2, d + 1] \cup \{a + 1\} \setminus \{b\}$ and the left D -column with $[d]$ as in Figure 7(B). The second fillings can be obtained from first

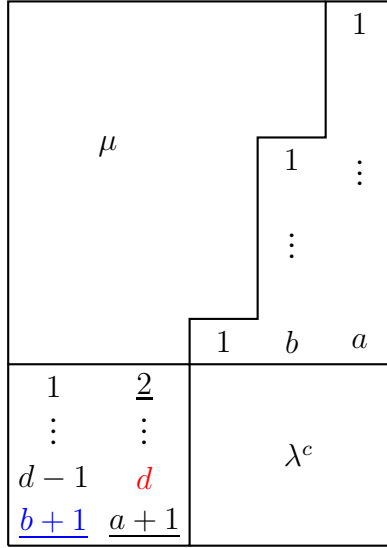

FIGURE 6. Filling in Case 1.3

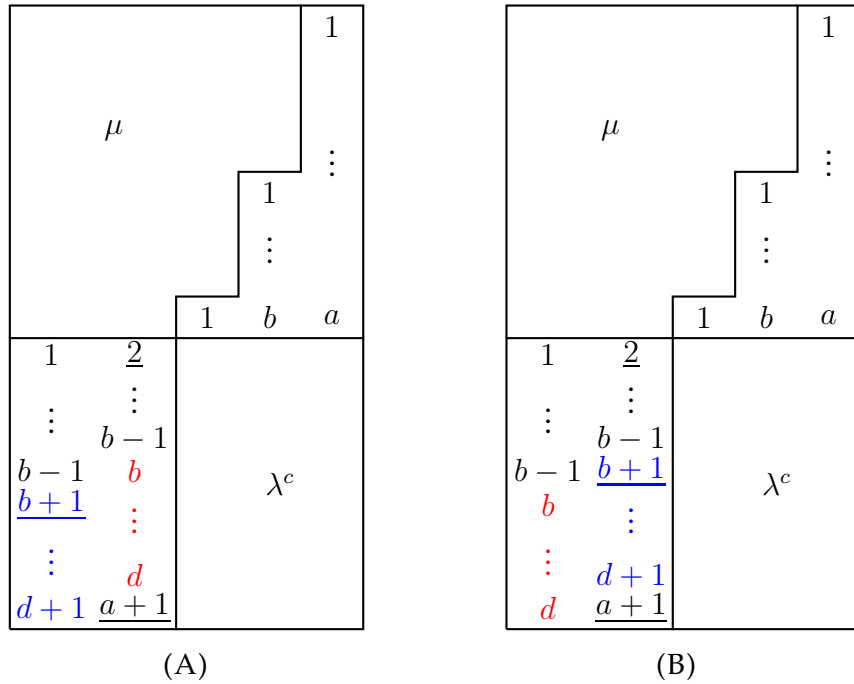

FIGURE 7. Two fillings in Case 1.4

by swapping the red entries with the blue entries, maintaining their vertical order. Both tableaux are semistandard. The ballot condition follows by a similar argument to Case 1.1. Therefore $s_{\lambda/\mu}(x_1, \dots, x_{\rho+1})$ is not multiplicity-free.

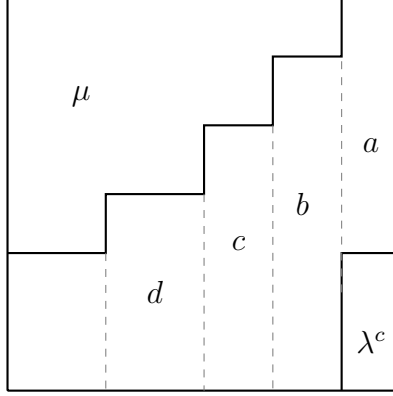

FIGURE 8. Case 2 in Theorem 3.9, with column lengths $a, b, c,$ and d .

Case 2 ($\lambda_2 = \mu_1$): As illustrated by Figure 8, set

$$\begin{aligned}
 A &= \{\mu_1 + 1, \dots, \lambda_1\} & a &= l_1 = \text{CS}_k(\lambda/\mu) \text{ for } k \in A \\
 B &= \{\mu_2 + 1, \dots, \mu_1\} & b &= l_1 + l_2 - k_1 = \text{CS}_k(\lambda/\mu) \text{ for } k \in B \\
 C &= \{\mu_3 + 1, \dots, \mu_2\} & c &= l_1 + l_2 - k_1 - k_2 = \text{CS}_k(\lambda/\mu) \text{ for } k \in C \\
 D &= \{\mu_4 + 1, \dots, \mu_3\} & d &= l_1 + l_2 - k_1 - k_2 - k_3 = \text{CS}_k(\lambda/\mu) \text{ for } k \in D
 \end{aligned}$$

where $\mu_4 = 0$ if $q = 3$.

By Corollary 2.4, it suffices to consider the case where λ/μ consists of exactly two A -columns and one each of the $B, C,$ and D -columns. Thus we consider

$$\lambda = (5^{l_1}, 2^{l_2}) \text{ and } \mu = (3^{k_1}, 2^{k_2}, 1^{k_3})$$

We divide into four subcases: Case 2.1 corresponds to Theorem 3.9 (III) while cases 2.2, 2.3 and 2.4 correspond to Theorem 3.9 (IV). In all subcases we construct two distinct ballot fillings of λ/μ with the same content.

Case 2.1 ($a \geq b$): In this case $\rho = a$. By Lemma 3.11, we reduce to $d = 1$. For filling 1, fill the B -column with $[b - 2] \cup \{a + 1, a + 2\}$, the C -column with $[c - 1] \cup \{a + 1\}$, and the D -column with $\{b - 1\}$ as shown in Figure 9. Filling 2 is defined to be the result of swapping the blue $b - 1$ and red $c - 1$ in Figure 9. Both tableaux are semistandard. Let u and v be the column reading words of filling 1 and 2, respectively. By Lemma 3.12, in order to verify that u and v are ballot, it suffices to check that the initial factors of u and v that terminate at the underlined entries in Figure 9 are ballot. The following remarks hold for both u and v . There are two entries equal to a and two entries equal to $a + 1$. Both a entries appear before the $a + 1$ entries. There are four entries equal to $c - 2$, and three equal to $c - 1$, before the underlined $c - 1$. There are three or four entries equal to $b - 2$, and two entries equal to $b - 1$ before the underlined $b - 1$. Thus u and v are ballot and $s_{\lambda/\mu}(x_1, \dots, x_{\rho+2})$ is not multiplicity-free.

Case 2.2 ($b > a \geq c$): In this case $\rho = b$. By Lemma 3.11, we reduce to $d = 1$. For filling 1, fill the B -column with $[b + 1] \setminus \{a\}$, the C -column by $[c - 2] \cup \{a, a + 1\}$, and the D -column with $\{c - 1\}$ as shown in Figure 10. Filling 2 is defined to be the result of swapping the red a and blue $c - 1$ in Figure 10. Since $b > a$, both tableaux are semistandard. Let u and v be the column reading words of filling 1 and 2, respectively. By Lemma 3.12, in order to verify that u and v are ballot, it suffices to check that the initial factors of u and v that

μ			1	1
			\vdots	\vdots
		1		
		\vdots		
		1	a	a
		\vdots		
		$b-2$	λ^e	
		$\frac{c-1}{a+1}$ $\frac{a+1}{a+2}$		
$\frac{b-1}{a+1}$	$\frac{a+1}{a+2}$	$a+2$		

FIGURE 9. Filling in Case 2.1

μ			1	1
			\vdots	\vdots
		1		
		\vdots		
		1	a	a
		\vdots		
		$a-1$	λ^e	
		$\frac{c-2}{a+1}$ $\frac{a+1}{a+1}$		
$\frac{c-1}{a+1}$	$\frac{a+1}{a+1}$	$b+1$		

FIGURE 10. Filling in Case 2.2

terminate at the underlined entries in Figure 10 are ballot. The following remarks hold for both u and v . There are three entries equal to a , and two equal to $a+1$, in u and v , with at least two a entries appearing prior to the $a+1$ entries. There are three entries equal to $a-1$, and two entries equal to a , before the underlined a . There are four entries equal to $c-2$, and three entries equal to $c-1$, before the underlined $c-1$. Hence u and v are ballot and $s_{\lambda/\mu}(x_1, \dots, x_{\rho+1})$ is not multiplicity-free.

Case 2.3 ($c > a > d$): By Lemma 3.11 we reduce to $d = 1$. For filling 1, fill the B -column with $[b+1] \setminus \{a\}$, the C -column with $[c+1] \setminus \{a-1\}$, and the D -column with $\{a-1\}$ as shown in Figure 11. Filling 2 is defined to be the result of swapping the red a in the C -column with the blue $a-1$ entry in the D -column in Figure 11. Both tableaux are semistandard. By similar reasoning as in Case 2.2, both tableaux are ballot. As a result, $s_{\lambda/\mu}(x_1, \dots, x_{\rho+1})$ is not multiplicity-free.

Case 2.4 ($d \geq a$): By Lemma 3.11 we reduce to $a = 2$. For filling 1, fill the B -column with $[b+1] \setminus \{2\}$, the C -column with $[c+1] \setminus \{2\}$, and the D -column with $[2, d+1]$ as shown in

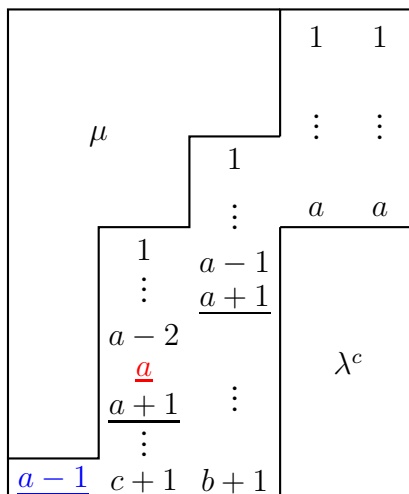

FIGURE 11. Filling in Case 2.3

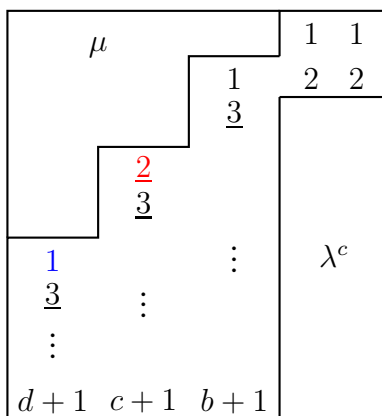

FIGURE 12. Filling in Case 2.4

Figure 12. Obtain filling 2 by swapping the blue 1 in the D -column with the red 2 in the C -column in Figure 12. Both tableaux are semistandard. Their reduced words are easily verified to be ballot by considering the initial factors that terminate at the underlined entries in Figure 12, and then applying Lemma 3.12. Therefore $s_{\lambda/\mu}(x_1, \dots, x_{\rho+1})$ is not multiplicity-free.

Case 3 ($\mu_q < \lambda_2 < \mu_1$): This case corresponds to Theorem 3.9 (V). Because $\lambda_2 > \mu_q$, there exists at least two columns of different length that end in the last row of λ ; namely those starting in row $(\sum_{i=1}^{q-1} k_i) + 1$ and those starting in row $(\sum_{i=1}^q k_i) + 1$. Because $\lambda_2 < \mu_1$, there exist at least two different length columns that end in row l_1 ; namely those starting in row 1 and those starting in row $k_1 + 1$. All four of these columns start in different rows, since $q \geq 3$. We now apply Proposition 3.7 to these four columns to conclude $s_{\lambda/\mu}(x_1, \dots, x_{\rho+1})$ is not multiplicity-free. \square

3.3. λ^\vee is a rectangle of shortness at least 3 and μ is a fat hook of shortness at least 2.

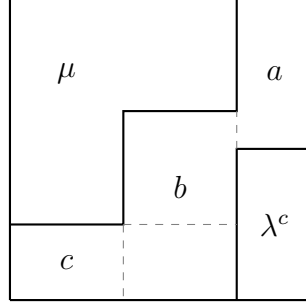

FIGURE 13. Case 1

Theorem 3.13. *If $s_{\lambda/\mu}(x_1, \dots, x_n)$ is a basic, n -sharp, tight skew Schur polynomial such that λ^\vee is a rectangle of shortness at least 3 and μ is a fat hook of shortness at least 2, then $s_{\lambda/\mu}(x_1, \dots, x_n)$ is not multiplicity-free if one of the following conditions holds:*

- (I) $\lambda_2 = \mu_1, l_2 > k_1$ and $n \geq \rho + 2$
- (II) $\lambda_2 = \mu_1, l_2 \leq k_1$ and $n \geq \rho + 3$
- (III) $\mu_1 > \lambda_2 > \mu_2, k_1 \geq l_2$ and $n \geq \rho + 2$
- (IV) $\mu_1 > \lambda_2 > \mu_2, l_2 > k_1$
- (V) $\mu_2 = \lambda_2, l_2 \geq l_1$ and $n \geq \rho + 3$
- (VI) $\mu_2 = \lambda_2, l_1 > l_2$ and $n \geq \rho + 2$

Here we omit the cases where $\lambda_2 < \mu_2$ or $\lambda_2 > \mu_1$ since the skew partition λ/μ would be not basic if $\lambda_2 < \mu_2$ and $l_1 = \ell(\mu)$, and not tight otherwise.

Proof. Let $c_1 = \lambda_1$. Set $c_i = \max(\{k : U(k) \neq U(c_{i-1}) \text{ or } L(k) \neq L(c_{i-1})\})$ for $i = 2, 3, 4$. Since λ and μ are both fat hooks, either c_4 does not exist and $L(c_3) = L(1)$ with $U(c_3) = U(1)$, or $L(c_4) = L(1), U(c_4) = U(1)$. Finally, set

$$\begin{aligned} A &= \{k : L(k) = L(c_1) \text{ and } U(k) = U(c_1)\}, & a &= \text{CS}_k(\lambda/\mu) \text{ for } k \in A, \\ B &= \{k : L(k) = L(c_2) \text{ and } U(k) = U(c_2)\}, & b &= \text{CS}_k(\lambda/\mu) \text{ for } k \in B, \\ C &= \{k : L(k) = L(c_3) \text{ and } U(k) = U(c_3)\}, & c &= \text{CS}_k(\lambda/\mu) \text{ for } k \in C, \end{aligned}$$

and if c_4 exists set

$$D = \{k : L(k) = L(c_4) \text{ and } U(k) = U(c_4)\} \quad d = \text{CS}_k(\lambda/\mu) \text{ for } k \in D.$$

We divide into 4 cases. In each case, we construct two ballot tableaux with the same content to conclude that the skew Schur polynomial is not multiplicity-free.

Case 1 ($\lambda_2 = \mu_1$): In this case c_4 is not defined, and $a = l_1, b = \ell(\lambda) - k_1$, and $c = \ell(\lambda) - \ell(\mu)$. By Corollary 2.4, it is enough to show multiplicity when there are three A -columns, two B -columns, and two C -columns. That is, when

$$\lambda = (7^{l_1}, 4^{l_2}) \text{ and } \mu = (4^{k_1}, 2^{k_2}).$$

Now we consider two sub-cases: Case 1.1 corresponds to Theorem 3.13 (I) while Case 1.2 corresponds to Theorem 3.13 (II).

Case 1.1 ($l_2 > k_1$): In this case, $a < b$ and $\rho = b$. Let T_1 be the filling of λ/μ shown in Figure 14. It is constructed by filling each A -column with $[a]$, the right B -column with $[b+2] \setminus \{a-1, a\}$, and the left B -column with $[b+1] \setminus \{a\}$. The right C -column is filled with $[\min\{c-2, a-3\}] \cup \{a-1\} \cup \{a+1, \dots, \max\{c+2, a+1\}\}$. When $\min\{c-2, a-3\} = 0$,

μ				1 1 1			
				$\vdots \quad \vdots \quad \vdots$			
				1 1		a a a	
				$\vdots \quad \vdots$			
				a-2 a-2		λ^c	
				a-1 <u>a+1</u>			
				<u>a+1</u>			
				$\vdots \quad \vdots$			
1		\vdots					
\vdots		\vdots		$\min\{c-2, a-3\}$			
$\min\{c-1, a-2\}$		<u>a-1</u>		<u>a+1</u>			
<u>a</u>		<u>a+1</u>		\vdots			
\vdots		\vdots					
$\max\{c+1, a\}$		$\max\{c+2, a+1\}$		b+1		b+2	

FIGURE 14. Ballot filling in Case 1.1

the top entry in this column is $a - 1$. If $\min\{c - 2, a - 3\} = c - 2$, then $\max\{c + 2, a + 1\} = a + 1$ and thus there are c entries in this column. If $\min\{c - 2, a - 3\} = a - 3$, then $\max\{c + 2, a + 1\} = c + 2$ and again there are c entries in this column. For the left C -column, fill it with $[\min\{c - 1, a - 2\}] \cup \{a, \dots, \max\{c + 1, a\}\}$. By the same reasoning, there are c entries in this column. Let T_2 be the filling obtained by swapping the blue $a - 1$ entry and the red a entry within the C -columns in Figure 14.

(T_1, T_2 are semistandard): By construction, in both T_1 and T_2 , each column is strictly increasing downwards while the rows are weakly increasing within the A , B , and C -columns. It suffices to check that the entries in the rightmost B and C columns, in both T_1 and T_2 , are less than or equal to their right neighbors. If $a = k_1$, then the entries in the rightmost B column have no right neighbors. If $a > k_1$, then the left neighbor of the bottom box in the leftmost A -column contains $a - k_1 \leq a - 2$, where the inequality follows from μ having shortness at least 2. Thus in both T_1 and T_2 every entry in the rightmost B -column is less than its right neighbor (if their right neighbor exists).

By hypothesis $b > a$, and $b \geq c + 2$ since μ has shortness at least 2. Thus

$$(31) \quad b \geq \max\{c + 2, a + 1\}.$$

Let X_k be the k^{th} box from the bottom in the leftmost B -column. Then X_k has a left neighbor if and only if $k \leq c$. If $k \leq b - a + 1$, then X_k contains $b - k + 2$, and the left neighbor of X_k contains at most $\max\{c + 2, a + 1\} - k + 1 \leq b - k + 2$ (the inequality follows by (31)). If $b - a + 1 < k \leq c$, then X_k contains $b - k + 1$, and the left neighbor of X_k contains at most $\max\{c + 2, a + 1\} - k + 1 \leq b - k + 1$ (the inequality follows by (31)). We conclude that T_1 and T_2 are semistandard.

(T_1, T_2 are ballot): Let u and v be the column reading words of T_1 and T_2 , respectively. By Lemma 3.12, the ballot condition only needs to be checked at the initial factors of u and v terminating at the underlined entries in Figure 14. The following remarks hold for both u and v . There are three entries equal to a that appear before the three underlined $a + 1$.

μ				1	1	1
				\vdots	\vdots	\vdots
		1	1	a	a	a
		\vdots	\vdots	λ^c		
1	\vdots	$b-3$				
\vdots	$c-2$	$b-2$	$\underline{a+1}$			
$c-1$	$\underline{b-2}$	$\underline{a+1}$	$a+2$			
$\underline{b-1}$	$\underline{a+1}$	$a+2$	$a+3$			

FIGURE 15. Ballot filling in Case 1.2

There are at least five entries equal to $a - 2$, and at most four equal to $a - 1$, before the underlined $a - 1$. There are at least four entries equal to $a - 1$, and three entries equal to a , before the underlined a . Thus both T_1 and T_2 are ballot.

Therefore $s_{\lambda/\mu}(x_1, \dots, x_n)$ is not multiplicity-free.

Case 1.2 ($l_2 \leq k_1$): Since $l_2 \leq k_1$, we have $a \geq b$ and thus $\rho = a$. Let T_1 be the filling of λ/μ shown in Figure 14. For each A -column, fill it with $[a]$. Fill the left B -column with $[b - 2] \cup \{a + 1, a + 2\}$, and the right B -column with $[b - 3] \cup \{a + 1, a + 2, a + 3\}$. Fill the left C -column with $[c - 1] \cup \{b - 1\}$, and the right C -column with $[c - 2] \cup \{b - 2, a + 1\}$. Let T_2 be the filling obtained from T_1 by swapping the blue $b - 1$ and red $b - 2$ within the C -columns in Figure 14.

(T_1, T_2 are semistandard): Since $a \geq b \geq c + 2$ and λ has shortness at least 3, it is clear from the construction that both tableaux are semistandard.

(T_1, T_2 are ballot): Let u and v be the column reading words of T_1 and T_2 , respectively. Applying Lemma 3.12, we only need to check that the initial factors of u and v terminating at the underlined entries in Figure 14 are ballot. The following remarks hold for both u and v . There are three entries equal to a preceding the three underlined $a + 1$ entries. There are four $b - 2$, and at least five $b - 3$, before the underlined $b - 2$. There are three $b - 1$, and at least four $b - 2$, before the underlined $b - 1$. Thus T_1 and T_2 are ballot.

Therefore $s_{\lambda/\mu}(x_1, \dots, x_n)$ is not multiplicity-free.

Case 2 ($\mu_2 < \lambda_2 < \mu_1$ with $k_1 + k_2 = l_1$): In this case $a = l_1, b = k_2, c = l_1 + l_2 - k_1$ and $d = \ell(\lambda) - \ell(\mu)$. By Corollary 2.4, it is enough to show multiplicity when there are two A -columns, one B -column, one C -column, and two D -columns; that is,

$$\lambda = (6^{l_1}, 3^{l_2}) \text{ and } \mu = (4^{k_1}, 2^{k_2}).$$

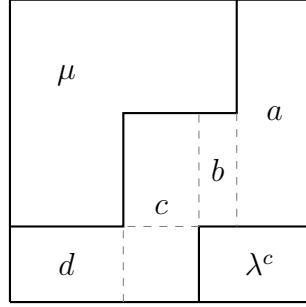

FIGURE 16. Case 2

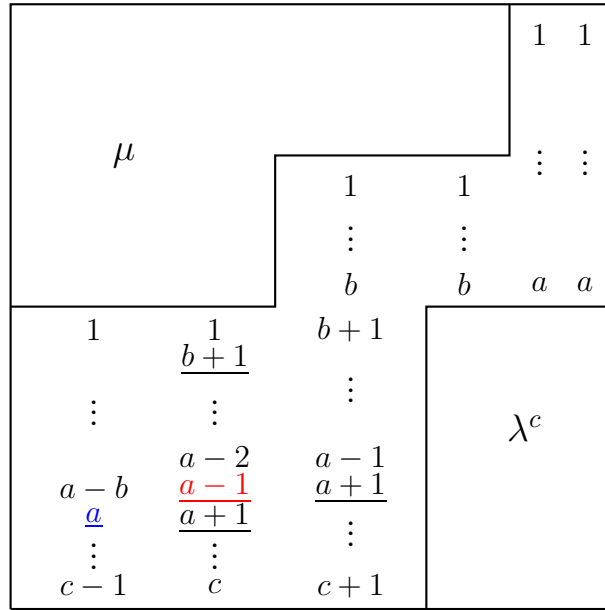

FIGURE 17. Ballot filling in Case 2.1

We consider two subcases: Case 2.1 (together with Case 3.1.1-3.1.3) corresponds to Theorem 3.13 (IV) while Case 2.2 (together with Case 3.2.1 and 3.2.2) corresponds to Theorem 3.13 (III).

Case 2.1 ($l_2 > k_1$): In this case $c > a$ and thus $\rho = c$. Let T_1 be the filling shown in Figure 17. Fill the A - and B -columns with $[a]$ and $[b]$, respectively. Fill in the C -column with $[c+1] \setminus \{a\}$. Fill in the left D -column with $[a-b] \cup \{a, \dots, c-1\}$ and the right D -column with $[c] \setminus (\{2, \dots, b\} \cup \{a\})$. Define T_2 to be the tableau obtained by swapping the blue a and red $a-1$ within the D -columns in Figure 17.

(T_1, T_2 are semistandard:) Since μ has shortness at least two, we know that $a-b \leq a-2$. It is trivial to check that both tableaux are semistandard.

(T_1, T_2 are ballot:) Let u and v be the column reading words of T_1 and T_2 , respectively. Applying Lemma 3.12, we only need to check that the initial factors of u and v terminating at the underlined entries in Figure 17 are ballot. The following remarks hold for both u and v . There are two entries equal to a , and none equal to $a+1$, preceding the two

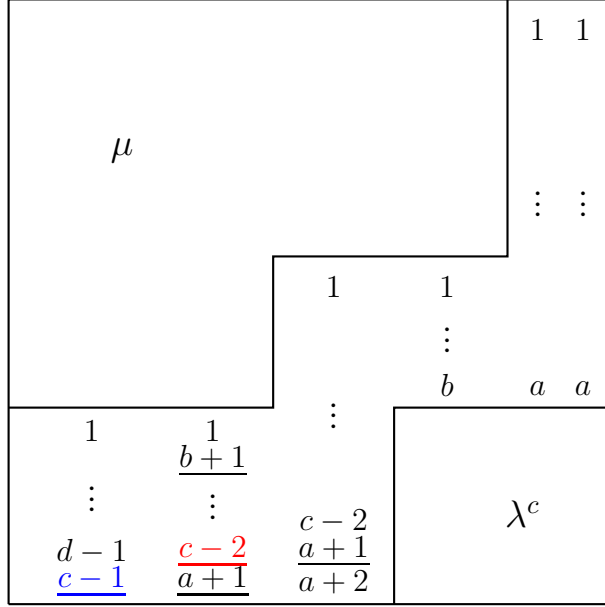

FIGURE 18. Ballot filling in Case 2.2

underlined $a + 1$. Since μ has shortness at least two, we know that

$$(32) \quad b + 1 \leq a - 1.$$

Thus there are four entries equal to b , and three entries equal to $b + 1$, before the underlined $b + 1$. By (32), there are at least four entries equal to $a - 2$, and three entries equal to $a - 1$, before the underlined $a - 1$. Finally, we apply (32) to conclude there are two entries equal to a , and at least three entries equal to $a - 1$, before the underlined a . Thus both T_1 and T_2 are ballot tableaux.

As a result $s_{\lambda/\mu}(x_1, \dots, x_{\rho+1})$ is not multiplicity-free.

Case 2.2 ($l_2 \leq k_1$): In this case we have $a \geq c$ and thus $\rho = a$. Let T_1 be the filling shown in Figure 18. Fill in the A and B -columns with $[a]$ and $[b]$, respectively. Fill in the C -column with $[c - 2] \cup \{a + 1, a + 2\}$. The right D -column is filled with $\{1\} \cup ([c - 2] \setminus [b]) \cup \{a + 1\}$. Since λ^\vee has shortness at least 3, $c - b \geq 3$ and thus $b < c - 2$. Fill in the left D -column with $[d - 1] \cup \{c - 1\}$. Define T_2 to be the tableaux obtained by swapping the blue $c - 1$ and red $c - 2$ within the D -columns in Figure 18.

(T_1, T_2 are semistandard): Since $a \geq c$, it is trivial to check that T_1 and T_2 are semistandard.

(T_1, T_2 are ballot): Let u and v be the column reading words of T_1 and T_2 , respectively. Once again, it suffices, by Lemma 3.12, to check that the initial factors of u and v terminating at the underlined entries in Figure 18 are ballot. The following remarks hold for both u and v . There are exactly two entries equal to a , and none equal to $a + 1$, before the two underlined $a + 1$. There are four entries equal to b , and three entries equal to $b + 1$, before the underlined $b + 1$. If the A columns contain $c - 2$, then they must contain $c - 3$. Since λ^\vee has shortness 3, we have $b < c - 2$, and so $c - 2$ can not appear in the B column. Thus, there is at least one more entry equal $c - 3$ than $c - 2$, before the underlined $c - 2$. As argued previously, $b < c - 2$ implies that $c - 2$ and $c - 1$ do not appear in the B column. If the A columns contain $c - 1$, then they must contain a $c - 2$. Thus there is at least one more entry equal to $c - 2$ than $c - 1$, before the underlined $c - 1$. Thus T_1 and T_2 are ballot.

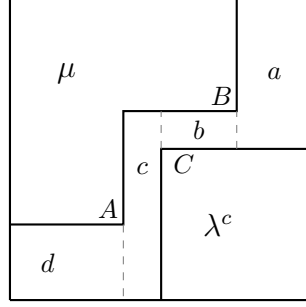

FIGURE 19. Case 3

Therefore $s_{\lambda/\mu}(x_1, \dots, x_{\rho+2})$ is not multiplicity-free.

Case 3 ($\mu_2 < \lambda_2 < \mu_1$ with $k_1 + k_2 > l_1$): By Corollary 2.4, it is enough to show multiplicity when there are two A -columns, one B -column, one C -column, and two D -columns; that is,

$$\lambda = (6^{l_1}, 4^{l_2}) \text{ and } \mu = (4^{k_1}, 2^{k_2}).$$

Since μ has a shortness at least 2, and λ^c has shortness at least 3,

$$(33) \quad c - 2 \geq d \geq 2 \text{ and } a \geq b + 2,$$

$$(34) \quad a \geq 3 \text{ and } c \geq b + 3.$$

Define

$$(35) \quad x = d + a - c.$$

It follows, from (33), that

$$(36) \quad x \leq a - 2.$$

We divide into four subcases: Case 3.1.1 - Case 3.1.3 (together with Case 2.1) correspond to Theorem 3.13 (IV) and Case 3.2.1 and 3.2.2 (together with Case 2.2) correspond to Theorem 3.13 (III).

Case 3.1.1 ($a < c, b < x$): In this case $\rho = c$. Let T_1 be the filling shown in Figure 20. Fill both A -columns with $[a]$ and the B -column with $[b]$. Fill the C -column with $[c+1] \setminus \{a\}$. Fill the left D -column with $[x+1] \cup ([c-1] \setminus [a])$, and the right D -column with $([x] \setminus \{b\}) \cup ([c] \setminus [a-1])$. By (34), the D -columns have d entries. Define T_2 to be the filling that is obtained by swapping the blue $x+1$ and red a in Figure 20.

(T_1, T_2 are semistandard): T_1 and T_2 are semistandard by (36).

(T_1, T_2 are ballot): Let u and v be the column reading words of T_1 and T_2 , respectively. Applying Lemma 3.12, we only need to check that the initial factors of u and v that terminate at the underlined entries in Figure 20 are ballot. The following remarks hold for both u and v . There are three entries equal to $a+1$. There are two entries equal to a before the first underlined $a+1$. There are at least two entries equal to a before the second underlined $a+1$. There are three entries equal to a before the third underlined $a+1$. There are four entries equal to b , and three equal to $b+1$, before the underlined $b+1$. There are at least three entries equal to $a-1$, and two equal to a , before the underlined a . If the B -column contains $x+1$, then it must contain x . This, combined with the fact that there is no x in

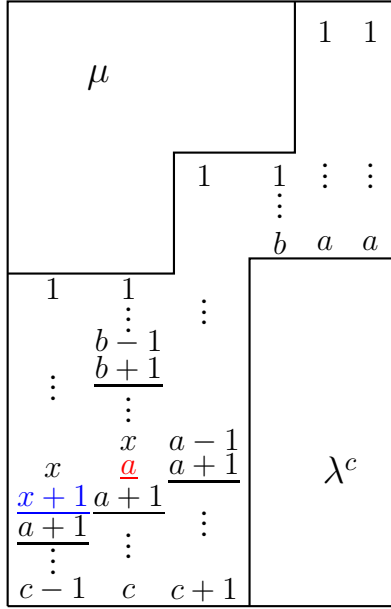

FIGURE 20. Ballot filling in Case 3.1.1

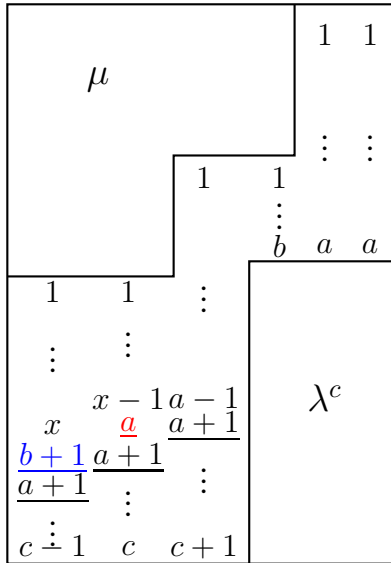

FIGURE 21. Ballot filling in Case 3.1.2

the C -column, implies there is at least one more entry equal to x than $x+1$, before the underlined $x+1$. Thus T_1 and T_2 are ballot.

We conclude $s_{\lambda/\mu}(x_1, \dots, x_{\rho+1})$ is not multiplicity-free.

Case 3.1.2 ($a < c, b \geq x \geq 1$): In this case $\rho = c$. Let T_1 be the filling shown in Figure 21. Fill both A -columns with $[a]$ and the B -column with $[b]$. Fill the C -column with $[c+1] \setminus \{a\}$. Fill the left D -column with $[x] \cup \{b+1\} \cup ([c-1] \setminus [a])$ and the right D -column with $[x-1] \cup ([c] \setminus [a-1])$. If $x = 1$, we will simply start the right D -column with a . It follows, by (35), that there are d entries in each D -column. Define T_2 to be the filling that arises by swapping the blue $b+1$ with the red a in Figure 21.

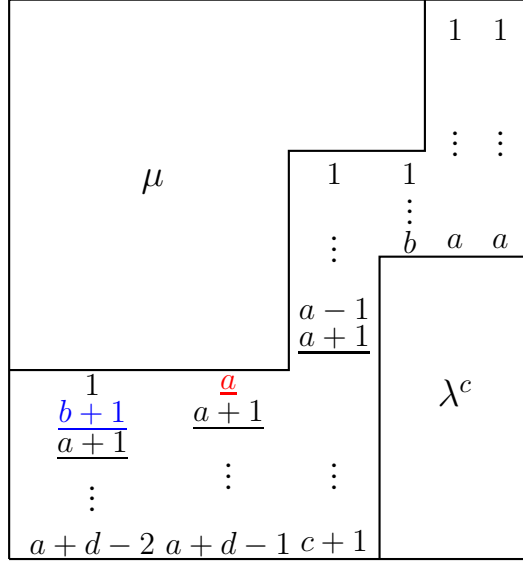

FIGURE 22. Ballot filling in Case 3.1.3

(T_1, T_2 are semistandard): By (33), (36), and the hypothesis of this case, T_1 and T_2 are semistandard.

(T_1, T_2 are ballot:) Let u and v be the column reading words of T_1 and T_2 , respectively. By Lemma 3.12, it suffices to check that the initial factors of u and v terminating at the underlined entries in Figure 21 are ballot. This follows by a similar argument to Case 3.1.1.

Thus $s_{\lambda/\mu}(x_1, \dots, x_{\rho+1})$ is not multiplicity-free.

Case 3.1.3 ($a < c, x < 1$): In this case $\rho = c$. Let T_1 be the filling shown in Figure 22. Fill both A -columns with $[a]$ and the B -column with $[b]$. Fill the C -column with $[c+1] \setminus \{a\}$. Fill the left D -column with $\{1, b+1\} \cup ([a+d-2] \setminus [a])$ and the right D -column with $([a+d-1] \setminus [a-1])$. Define T_2 to be the filling that arises by swapping the blue $b+1$ with the red a in Figure 22.

(T_1, T_2 are semistandard): By (35) we have $a+d-c = x \leq 0$ and thus $a \leq c-d$. Therefore the $a+1$ entry in C -column is in a row above the red a entry in the right D -column. It also follows that $a+d-1 < c+1$. As a result, T_1 and T_2 are semistandard.

(T_1, T_2 are ballot:) Let u and v be the column reading words of T_1 and T_2 , respectively. By Lemma 3.12, it suffices to check that the initial factors of u and v ending at the underlined entries in Figure 21 are ballot. This follows by a similar argument to Case 3.1.1.

Thus $s_{\lambda/\mu}(x_1, \dots, x_{\rho+1})$ is not multiplicity-free.

Case 3.2.1 ($a \geq c, d < b+2$): In this case $\rho = c$. Let T_1 be the filling illustrated in Figure 23. Fill the A -columns with $[a]$ and the B -column with $[b]$. Fill the C -column with $[c-2] \cup \{a+1, a+2\}$. Fill the left D -column with $[d-1] \cup \{b+1\}$ and the right D -column with $[d-2] \cup \{c-1, a+1\}$. Let T be the filling obtained by swapping the blue $b+1$ and red $c-1$ in Figure 23.

(T_1, T_2 are semistandard): T_1 and T_2 are semistandard by the hypothesis of this case.

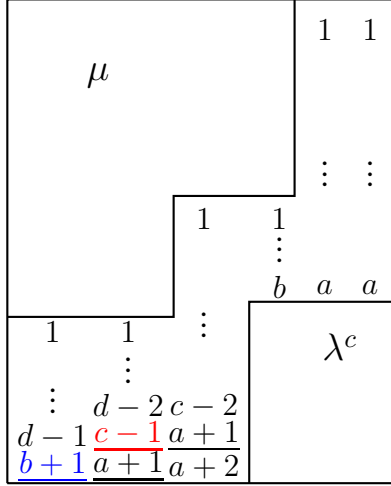

FIGURE 23. Ballot filling in Case 3.2.1

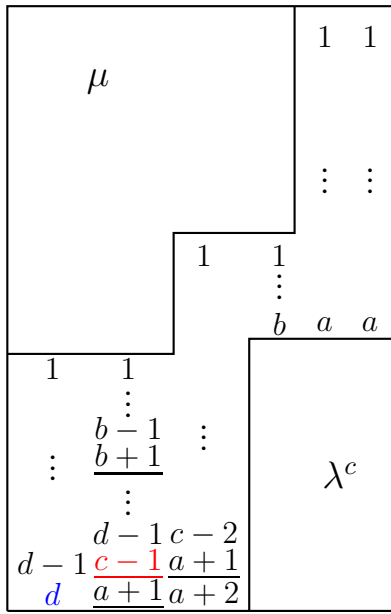

FIGURE 24. Ballot filling in Case 3.2.2

(T_1, T_2 are ballot:) Let u and v be the column reading words of T_1 and T_2 , respectively. Once again, we only need to check that the initial factors of u and v that end at the underlined entries in Figure 23 are ballot. The following statements hold for both u and v . There are exactly two entries equal to $a + 1$, with at least two entries equal to a prior to them. If there is a $c - 1$ in each A -column, then there must be a $c - 2$. Since λ^\vee has shortness at least 3, there is no $c - 2$ or $c - 1$ in the B -column. Thus, since there is no $c - 1$ in the C -column, there is at least one more entry equal to $c - 2$ than $c - 1$, before the underlined $c - 1$. There is at least 4 entries equal to b , and exactly three equal to $b + 1$, before the underlined $b + 1$. Thus T_1 and T_2 are ballot.

Hence $s_{\lambda/\mu}(x_1, \dots, x_{\rho+2})$ is not multiplicity-free.

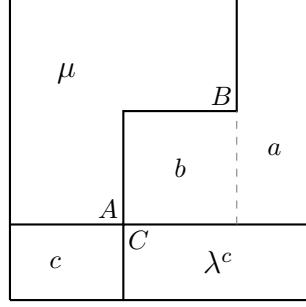

FIGURE 25. Case 4

Case 3.2.2 ($a \geq c, d \geq b + 2$): In this case $\rho = c$. Let T_1 be the filling found in Figure 24. Fill the A -columns with $[a]$ and the B -column with $[b]$. Fill the C -column with $[c-2] \cup \{a+1, a+2\}$. Fill the left D -column with $[d]$, and right D -column with $([d-1] \setminus \{b\}) \cup \{c-1, a+1\}$. The filling T_2 is obtained by swapping the blue d with the red $c-1$ in Figure 24.

(T_1, T_2 are semistandard): T_1 and T_2 are semistandard by the hypothesis of this case.

(T_1, T_2 are ballot:) Let u and v be the column reading words of T_1 and T_2 , respectively. Once again, we only need to check that the initial factors of u and v that end at the underlined entries in Figure 23 are ballot. This follows by a similar argument to Case 3.2.1.

We conclude that $s_{\lambda/\mu}(x_1, \dots, x_{\rho+2})$ is not multiplicity-free.

Case 4 ($\lambda_2 = \mu_2$ with $k_1 + k_2 = l_1$): By Corollary 2.4, it is enough to show multiplicity when there are two A -columns, two B -columns, and three C -columns. Equivalently,

$$\lambda = (7^{l_1}, 3^{l_2}) \text{ and } \mu = (5^{k_1}, 3^{k_2}).$$

Since μ has shortness at least 2, and λ^\vee has shortness at least 3,

$$(37) \quad b \geq 2, c \geq 3, a \geq 4, \text{ and } a - b \geq 2.$$

Let $\tilde{\lambda} = (6^{l_1}, 3^{l_2})$ and $\tilde{\mu} = (4^{k_1}, 2^{k_2})$. Then $|\lambda| - |\mu| = |\tilde{\lambda}| - |\tilde{\mu}|$ and $\tilde{\lambda}/\tilde{\mu}$ satisfies the hypotheses of Case 2 in Theorem 3.13. Let T be a ballot tableau of shape $\tilde{\lambda}/\tilde{\mu}$. Define T^{shift} to be the filling of shape $\lambda/\mu = (7^{l_1}, 3^{l_2})/(5^{k_1}, 3^{k_2})$ where for all $(r, k) \in \lambda/\mu$,

$$T^{\text{shift}}(r, k) = \begin{cases} T(r, k-1) & \text{for } r \leq l_1 \\ T(r, k) & \text{for } r > l_1 \end{cases}$$

Claim 3.14. *If T is a ballot tableau of shape $\tilde{\lambda}/\tilde{\mu}$ and content ν , then T^{shift} is a ballot tableau of shape λ/μ and content ν .*

Proof of Claim 3.14: It is trivial to check that T and T^{shift} have the same content. Since T is semistandard, T^{shift} will be semistandard. By construction the column reading words of T and T^{shift} are identical, and thus both are ballot. \square

By Lemma 3.11 and (37), we reduce to the case where either $c = 3$ or $b = 2$. We divide into 4 subcases: Case 4.2.1 corresponds to Theorem 3.13 (V), and the other cases correspond to Theorem 3.13 (VI).

The column lengths of the A, B, C , and D -columns of $\tilde{\lambda}/\tilde{\mu}$ are $a, b, b+c$, and c , respectively.

Case 4.1.1 ($c = 3, a - b < 3$): By (37), we have $a = b + 2 = b + c - 1$. This implies $\rho = a$. Since $a < b + c$, this implies that $\tilde{\lambda}/\tilde{\mu}$ satisfies the hypotheses of Case 2.1. Let T_1 and T_2 be the two ballot fillings of $\tilde{\lambda}/\tilde{\mu}$ constructed in Case 2.1. T_1 and T_2 had content with length $b + c + 1$. Claim 3.14 implies that T_1^{shift} and T_2^{shift} are two ballot fillings of λ/μ with the same content as T_1 and T_2 . Thus, we have two ballot tableaux of shape λ/μ , with content of length $b + c + 1 = a + 2 = \rho + 2$. Thus $s_{\lambda/\mu}(x_1, \dots, x_{\rho+2})$ is not multiplicity-free.

Case 4.1.2 ($c = 3, a - b \geq 3$): In this case, $a \geq b + c$. This implies $\rho = a$, and that $\tilde{\lambda}/\tilde{\mu}$ satisfies the hypotheses of Case 2.2. By the same argument as in Case 4.1.1, we can find two ballot tableaux of shape λ/μ with content of length $a + 2 = \rho + 2$. Thus $s_{\lambda/\mu}(x_1, \dots, x_{\rho+2})$ is not multiplicity-free.

Case 4.2.1 ($b = 2, a - c < 2$): Since $a < b + c$, $\tilde{\lambda}/\tilde{\mu}$ satisfies the hypotheses of Case 2.2. By the same argument as in Case 4.1.1, we can find two ballot tableaux of shape λ/μ with content ν of length $b + c + 1 = c + 3$. If $a - c = 1$, we have $\rho = a$ and $\ell(\nu) = \rho + 2$. If $a = c$, we have $\rho = c$ and $\ell(\nu) = \rho + 3$. We conclude that for both $a - c = 1$ and $a = c$, $s_{\lambda/\mu}(x_1, \dots, x_{\rho+3})$ is not multiplicity-free.

Case 4.2.2 ($b = 2, a - c \geq 2$): In this case, $a \geq b + c$, which implies $\rho = a$. It also implies that $\tilde{\lambda}/\tilde{\mu}$ satisfies the hypotheses of Case 2.2. Thus we can find two ballot tableaux of shape λ/μ with content of length $a + 2 = \rho + 2$. Thus $s_{\lambda/\mu}(x_1, \dots, x_{\rho+2})$ is not multiplicity-free.

4. TIGHTNESS OF UPPER BOUNDS

In this section, we will show that the upper bounds on $m(\lambda/\mu)$ obtained in the previous section are all tight. We will use the symmetry (9) and interpret $c_{\mu,\nu}^\lambda$ as the number of Littlewood-Richardson tableaux of shape λ/ν and content μ throughout this section. Note that the content μ is guaranteed to be a partition. Let us begin with three lemmas:

Lemma 4.1. *Let T be a ballot tableau of shape λ/ν and content $\mu = (\mu_1, \mu_2, \dots, \mu_k)$. If $1 \leq i < j \leq k$ and $c = \min\{z : \text{column } z \text{ contains } j\}$, then*

$$|\{z : z < c \text{ and column } z \text{ contains } i\}| \leq \mu_i - \mu_j.$$

Proof. Since T is ballot, the initial factor of the column reading word ending at the j entry in column c must contain at least μ_j i 's. Thus, there are at most $\mu_i - \mu_j$ entries equal to i in the column reading word that appear after this initial factor. This implies the columns z , with $z < c$ can contain at most $\mu_i - \mu_j$ i 's. \square

Lemma 4.2. *For a ballot tableau T with content μ , if $\mu_i = \mu_j$ and $i < j$, then i does not appear in the bottom row of T .*

Proof. Suppose, for contradiction, that i appears in the bottom row of T . Let x be the column index of the left-most i in the bottom row of T and y be the column index of the left-most j in T (not necessarily in the bottom row). Then the semistandardness of T implies that $x < y$. Applying Lemma 4.1, we conclude

$$0 < |\{z : z < y \text{ and column } z \text{ contains } i\}| \leq \mu_i - \mu_j = 0.$$

which is a contradiction. Therefore i does not appear in the bottom row of T . \square

Definition 4.3. Let T be a tableau of shape λ/ν and content μ . Define $(\lambda/\nu)^{\text{del}(N)}$ to be the skew diagram obtained from λ/ν by removing the last N rows. Define $T^{\text{del}(N)}$ to be the tableau of shape $(\lambda/\nu)^{\text{del}(N)}$ obtained from T by removing the last N rows.

Lemma 4.4. *If T is a ballot tableau, then $T^{\text{del}(N)}$ is a ballot tableau.*

Proof. Since T is semistandard, $T^{\text{del}(N)}$ must be semistandard. The reverse reading word of T is ballot. Since the reverse reading word of $T^{\text{del}(N)}$ is an initial factor of the reverse reading word of T , $T^{\text{del}(N)}$ is also ballot. \square

As a corollary of Lemma 4.4, we have the following result:

Corollary 4.5. *Suppose that all ballot tableaux of shape λ/ν and content μ are identical in the last N rows. Let $\mu^{(N)}$ be the content of $T^{\text{del}(N)}$, for all ballot tableaux T of shape λ/ν and content μ . If we set $\lambda^{(N)}/\nu^{(N)} := (\lambda/\nu)^{\text{del}(N)}$, then*

$$c_{\mu,\nu}^{\lambda} \leq c_{\mu^{(N)},\nu^{(N)}}^{\lambda^{(N)}},$$

4.1. λ^\vee is a rectangle of shortness at least 3 and μ is a fat hook of shortness at least 2.

Theorem 4.6. *Let $s_{\lambda/\mu}(x_1, \dots, x_n)$ be a basic, n -sharp, tight skew Schur polynomial such that λ^\vee is a rectangle of shortness at least 3 and μ is a fat hook of shortness at least 2. Then the following hold:*

- (I) *If $\lambda_2 = \mu_1, l_2 > k_1$ then $m(\lambda/\mu) = \rho + 2$*
- (II) *If $\lambda_2 = \mu_1, l_2 \leq k_1$ then $m(\lambda/\mu) = \rho + 3$*
- (III) *If $\mu_1 > \lambda_2 > \mu_2, k_1 \geq l_2$ then $m(\lambda/\mu) = \rho + 2$*
- (IV) *If $\mu_1 > \lambda_2 > \mu_2, l_2 > k_1$ then $m(\lambda/\mu) = \rho + 1$*
- (V) *If $\mu_2 = \lambda_2, l_2 \geq l_1$ then $m(\lambda/\mu) = \rho + 3$*
- (VI) *If $\mu_2 = \lambda_2, l_1 > l_2$ then $m(\lambda/\mu) = \rho + 2$*

Proof. By Definition 1.9, the statements in Theorem 4.6 (I)-(VI) are equivalent to the claim that $m(\lambda/\mu) = \rho + r_1(\lambda/\mu) + r_2(\lambda/\mu)$. Thus, by Theorem 3.13 and (9), to prove Theorem 4.6 (I)-(VI), it is enough to show that for any partition ν such that $\ell(\nu) < \rho + r_1(\lambda/\mu) + r_2(\lambda/\mu)$, there is at most one ballot tableau of shape λ/ν and content μ . Equivalently, we want to show that

$$(38) \quad c_{\mu,\nu}^{\lambda} = c_{\nu,\mu}^{\lambda} \leq 1 \text{ for all } \nu \text{ such that } \ell(\nu) < \rho + r_1(\lambda/\mu) + r_2(\lambda/\mu).$$

Note that (38) holds trivially for Theorem 4.6 (IV) since λ/μ is n -sharp.

We consider the same four cases as in the proof of Theorem 3.13, though the order in which we consider the cases is different. In all four cases ν is a partition such that $\ell(\nu) < \rho + r_1(\lambda/\mu) + r_2(\lambda/\mu)$.

Case 1 ($\lambda_2 = \mu_1$): This case will correspond to Theorem 4.6 (I) and (II). If the first l rows of ν and λ have the same length, for some $l \in \mathbb{Z}_{>0}$, then removing the top l rows of both λ and ν does not change the value of $c_{\mu,\nu}^{\lambda}$. Denote $\widehat{\lambda}$ to be the partition obtained by removing the top l rows of λ . If $\widehat{\lambda}$ has shortness at most 2 or is a rectangle, then $s_{\widehat{\lambda}/\mu}$ is multiplicity-free and thus $c_{\mu,\widehat{\nu}}^{\widehat{\lambda}} = c_{\mu,\nu}^{\lambda} \leq 1$ for all ν . Otherwise, $(\widehat{\lambda}, \mu)$ satisfies the hypotheses of Case 1 since (λ, μ) satisfied the hypotheses of Case 1. Therefore, we assume, without loss of generality, that

$$(39) \quad \nu_1 < \lambda_1.$$

Claim 4.7. *In the case of Theorem 4.6 (I) and (II),*

$$\ell(\nu) < \rho + r_1(\lambda/\mu) + r_2(\lambda/\mu) \leq \ell(\lambda).$$

Proof of Claim 4.7: In the case of Theorem 4.6 (I), we have $\rho = l_1 + l_2 - k_1$. Since μ has shortness at least 2 and $r_1(\lambda/\mu) + r_2(\lambda/\mu) = 2$, we obtain

$$\rho + r_1(\lambda/\mu) + r_2(\lambda/\mu) \leq \ell(\lambda) - k_1 + 2 \leq \ell(\lambda).$$

In the case of Theorem 4.6 (II), we have $\rho = l_1$. Since λ has shortness at least 3 and $r_1(\lambda/\mu) + r_2(\lambda/\mu) = 2$, we get

$$\rho + r_1(\lambda/\mu) + r_2(\lambda/\mu) \leq l_1 + 3 \leq \ell(\lambda).$$

□

Claim 4.8. *Let T be any ballot tableau of shape λ/ν and content μ where both λ and μ are fat hooks. If $\ell(\nu) < \ell(\lambda)$ and $\lambda_2 = \mu_1$, then the bottom row of T contains $\mu_1 - \mu_2$ boxes filled by k_1 and μ_2 boxes filled by $k_1 + k_2$.*

Proof of Claim 4.8: Since μ is a fat hook, by Lemma 4.2, $T(\ell(\lambda), c) \in \{k_1, k_1 + k_2\}$ for all $c \in [\mu_1]$. Let z be the column index of the left-most $k_1 + k_2$ in T . By Lemma 4.1,

$$|\{x : x < z \text{ and column } x \text{ contains } k_1\}| \leq \mu_1 - \mu_2.$$

Therefore $z \leq \mu_1 - \mu_2 + 1$ and $T(\ell(\lambda), c) = k_1 + k_2$ for all $c \in [z, \mu_1]$. Since

$$|\{(r, c) : T(r, c) = k_1 + k_2\}| = \mu_2,$$

we get $z \geq \mu_1 - \mu_2 + 1$ hence $z = \mu_1 - \mu_2 + 1$. We can then conclude that $T(\ell(\lambda), c) = k_1$ for $c \in [\mu_1 - \mu_2]$ and $T(\ell(\lambda), c) = k_1 + k_2$ for $c \in [\mu_1 - \mu_2 + 1, \mu_1]$. □

We divide into three subcases.

Case 1.1 ($k_1 + k_2 = l_1$): By (39), we know that $\text{CS}_{\lambda_1}(\lambda/\nu) = k_1 + k_2$. As a result, for any ballot tableaux T of shape λ/ν and content μ , we have $T(l_1, \lambda_1) = k_1 + k_2$.

By Claim 4.7, we know that any triple of partitions (λ, μ, ν) in Theorem 4.6 (I) and (II) satisfies the conditions in Claim 4.8. Therefore by Claim 4.8, $T(r, c) = k_1 + k_2$ only if $r = \ell(\lambda)$ for any ballot tableau T of shape λ/ν and content μ . This contradicts $T(l_1, \lambda_1) = k_1 + k_2$. Therefore no such ballot tableau exists and $c_{\mu, \nu}^\lambda = 0$.

Case 1.2 ($k_1 + k_2 > l_1, l_2 > k_1$): In this case we had $l_1 < l_1 + l_2 - k_1 = \rho$ and $s_{\lambda/\mu}(x_1, \dots, x_{\rho+2})$ is not multiplicity-free. Let $\nu \subset \lambda$ be any partition such that $\ell(\nu) \leq \rho + 1$. In this case

$$(40) \quad \rho + 1 = l_1 + l_2 - k_1 + 1.$$

Therefore ν lies in the region above the gray dashed line in Figure 26(A). By Claim 4.7, there is at least one row below the gray dashed line. Moreover, since $l_2 < k_1$ all rows in λ/ν below the gray line in Figure 26(A) have λ_2 boxes.

Let T be a ballot tableau of shape λ/ν and content μ . Then $T(l_1, \lambda_1) \neq k_1 + k_2$ since $k_1 + k_2 > l_1$. Define $\lambda^{(1)}/\nu^{(1)} = (\lambda/\nu)^{\text{del}(1)}$. By Claim 4.7, $\lambda^{(1)} = (\lambda_1^{l_1}, \lambda_2^{l_2-1})$ and $\nu^{(1)} = \nu$. Thus, by Claim 4.8, $T^{\text{del}(1)}$ is a ballot tableau of shape $\lambda^{(1)}/\nu$ and content $\mu^{(1)} = (\mu_1^{k_1-1}, \mu_2^{k_2})$.

By Corollary 4.5, we have

$$(41) \quad c_{\mu, \nu}^\lambda \leq c_{\mu^{(1)}, \nu}^{\lambda^{(1)}}$$

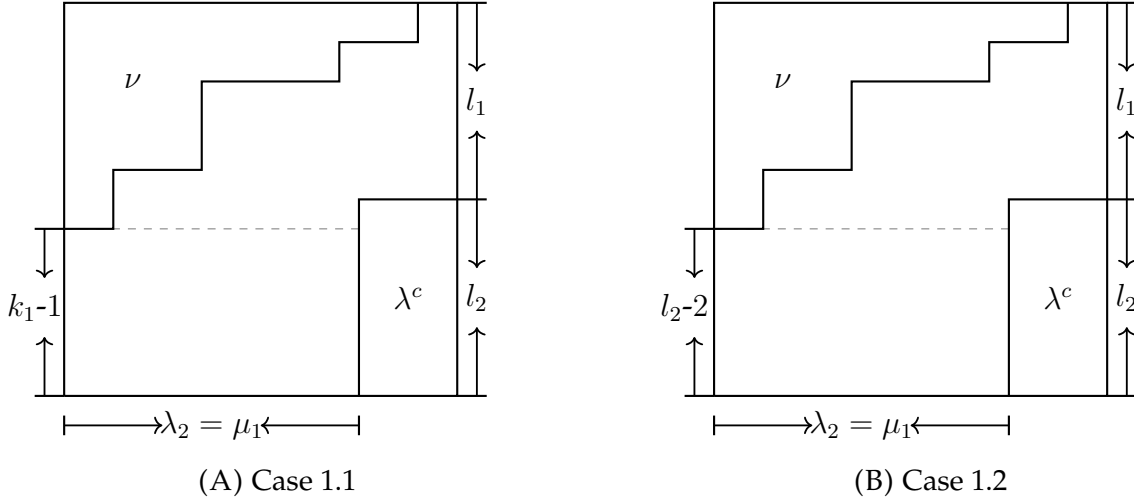

FIGURE 26

We may continue to iterate the above process, constructing $\lambda^{(i+1)}$ and $\mu^{(i+1)}$ from $\lambda^{(i)}$ and $\mu^{(i)}$, so long as the hypotheses of Claim 4.8 and Case 1.2 remain satisfied for $\lambda^{(i)}$ and $\mu^{(i)}$. The Case 1.2 hypotheses are satisfied if $\ell(\mu^{(i)}) > l_1$. If $\ell(\lambda^{(i)}) > \rho + 1$, then $\ell(\lambda^{(i)}) \geq \ell(\nu)$ since, in this case, $\rho + 1 \geq \ell(\nu)$. Further, by (40), if $\ell(\lambda^{(i)}) > \rho + 1$, then $\ell(\lambda^{(i)}) > l_1$ and $\lambda^{(i)}$ is a fat hook. Thus, the hypotheses of Claim 4.8 and Case 1.2 are satisfied if

$$(42) \quad \mu^{(i)} \text{ is a fat hook, } \ell(\mu^{(i)}) > l_1$$

and

$$(43) \quad \ell(\lambda^{(i)}) > \rho + 1$$

If (42) and (43) both hold, then Corollary 4.5 implies

$$(44) \quad c_{\mu^{(i)}, \nu}^{\lambda^{(i)}} \leq c_{\mu^{(i+1)}, \nu}^{\lambda^{(i+1)}}$$

Let m be the minimal index where (42) or (43) is violated. At least one of the three following statements holds:

$$\ell(\lambda^{(m)}) = \rho + 1, \mu^{(m)} = (\mu_2^{k_2}), \text{ and } \ell(\mu^{(m)}) = l_1,$$

Case 1.2.1 ($\ell(\lambda^{(m)}) = \rho + 1$): Here $m = k_1 - 1$ since $\ell(\lambda^{(i+1)}) = \ell(\lambda^{(i)}) - 1$ and (40). Therefore we have $\mu^{(m)} = (\mu_1, \mu_2^{k_2})$. Since $\lambda^{(m)\vee} = ((\lambda_1 - \lambda_2)^{l_2 - k_1 + 1})$ is a rectangle and $\mu^{(m)}$ is a fat hook of shortness 1, by Theorem 3.2 the skew Schur function $s_{\lambda^{(m)}/\mu^{(m)}}$ is multiplicity-free. Thus $c_{\mu^{(m)}, \nu}^{\lambda^{(m)}} \leq 1$. Now, by (41) and (44), we get

$$c_{\mu, \nu}^{\lambda} \leq c_{\mu^{(1)}, \nu}^{\lambda^{(1)}} \leq c_{\mu^{(m)}, \nu}^{\lambda^{(m)}} \leq 1 \text{ for all } \nu \text{ such that } \ell(\nu) \leq \rho + 1.$$

Case 1.2.2 ($\mu^{(m)} = (\mu_2^{k_2})$): Here $m = k_1 > k_1 - 1$. This violates the minimality of m , since if $m = k_1 - 1$, then (40) implies $\ell(\lambda^{(m)}) = \rho + 1$. Hence this case is not possible.

Case 1.2.3 ($\ell(\mu^{(m)}) = l_1$): If T is a ballot tableau T of shape $\lambda^{(m)}/\nu$ and content $\mu^{(m)}$, then $T(l_1, \lambda_1) = k_1 + k_2 - m$. We assume the two previous cases do not hold, since if they did we could apply their arguments to get our desired result. Thus we assume $\mu^{(m)}$ is a fat hook,

and $\ell(\lambda)^{(m)} < \rho + 1$. Combining this with $(\lambda^{(m)})_2 = (\mu^{(m)})_1$ we conclude via Claim 4.8 that T can not exist. Thus (41) and (44) imply

$$c_{\mu,\nu}^\lambda \leq c_{\mu^{(1)},\nu}^{\lambda^{(1)}} \leq c_{\mu^{(m)},\nu}^{\lambda^{(m)}} = 0 \text{ for all } \nu \text{ such that } \ell(\nu) \leq \rho + 1.$$

Combining all subcases, we get $m(\lambda/\mu) = \rho + 2$ in Theorem 4.6 (I) as desired.

Case 1.3 ($k_1 + k_2 > l_1, l_2 \leq k_1$): Here we have $l_1 + l_2 - k_1 \leq l_1 = \rho$ and $s_{\lambda/\mu}(x_1, \dots, x_{\rho+3})$ is not multiplicity-free. Let $\nu \subset \lambda$ be any partition such that $\ell(\nu) \leq \rho + 2$. In this case, we have

$$(45) \quad \rho + 2 = l_1 + 2.$$

Once again, ν lies in the region above the gray dashed line in Figure 26(B). By Claim 4.7, there is at least one row below the gray dashed line. Since $l_2 - 2 < l_2$, all rows in λ/ν below the gray line have λ_2 boxes.

Let T be a ballot tableau of shape λ/ν and content μ . Then $T(l_1, \lambda_1) \neq k_1 + k_2$ since $k_1 + k_2 > l_1$. As in Case 1.2, define $\lambda^{(1)}/\nu^{(1)} = (\lambda/\nu)^{\text{del}(1)}$. By Claim 4.7, $\lambda^{(1)} = (\lambda_1^{l_1}, \lambda_2^{l_2-1})$ and $\nu^{(1)} = \nu$. Thus, Claim 4.8 implies $T^{\text{del}(1)}$ is a ballot tableau of shape $\lambda^{(1)}/\nu$ and content $\mu^{(1)} = (\mu_1^{k_1-1}, \mu_2^{k_2})$.

By Corollary 4.5, we have

$$(46) \quad c_{\mu,\nu}^\lambda \leq c_{\mu^{(1)},\nu}^{\lambda^{(1)}}$$

We may continue to iterate the above process, constructing $\lambda^{(i+1)}$ and $\mu^{(i+1)}$ from $\lambda^{(i)}$ and $\mu^{(i)}$, so long as the hypotheses of Claim 4.8 and Case 1.3 remain satisfied for $\lambda^{(i)}$ and $\mu^{(i)}$. By a similar argument to Case 1.2, these hypotheses are satisfied if

$$(47) \quad \mu^{(i)} \text{ is a fat hook, } \ell(\mu^{(i)}) > l_1$$

and

$$(48) \quad \ell(\lambda^{(i)}) > \rho + 2.$$

If (47) and (48) are satisfied, then Corollary 4.5 implies

$$(49) \quad c_{\mu^{(i)},\nu}^{\lambda^{(i)}} \leq c_{\mu^{(i+1)},\nu}^{\lambda^{(i+1)}}$$

Let m be the minimal index where (47) or (48) is violated. At least one of the three following statements holds:

$$\ell(\lambda^{(m)}) = \rho + 2, \mu^{(m)} = (\mu_2^{k_2}) \text{ and } \ell(\mu^{(m)}) = l_1.$$

Case 1.3.1 ($\ell(\lambda^{(m)}) = \rho + 2$): Since $\ell(\lambda^{(i+1)}) = \ell(\lambda^{(i)}) - 1$ and (45), we have $m = l_2 - 2$. Therefore $\lambda^{(m)} = (\lambda_1^{l_1}, \lambda_2^2)$ and thus has shortness 2. Since $\mu^{(m)}$ is either a fat hook or a rectangle by construction, the skew Schur function $s_{\lambda^{(m)}/\mu^{(m)}}$ is multiplicity-free by Theorem 3.2. Therefore $c_{\mu^{(m)},\nu}^{\lambda^{(m)}} \leq 1$, and so (46) and (49) imply

$$c_{\mu,\nu}^\lambda \leq c_{\mu^{(1)},\nu}^{\lambda^{(1)}} \leq c_{\mu^{(m)},\nu}^{\lambda^{(m)}} \leq 1 \text{ for all } \nu \text{ such that } \ell(\nu) \leq \rho + 2.$$

Case 1.3.2 ($\mu^{(m)} = (\mu_2^{k_2})$): In this case $m = k_1$. By the Case 1.3 hypotheses,

$$k_1 \geq l_2 > l_2 - 2.$$

This violates the minimality of m , since if $m = l_2 - 2$, then (45) implies $\ell(\lambda^{(m)}) = \rho + 2$.

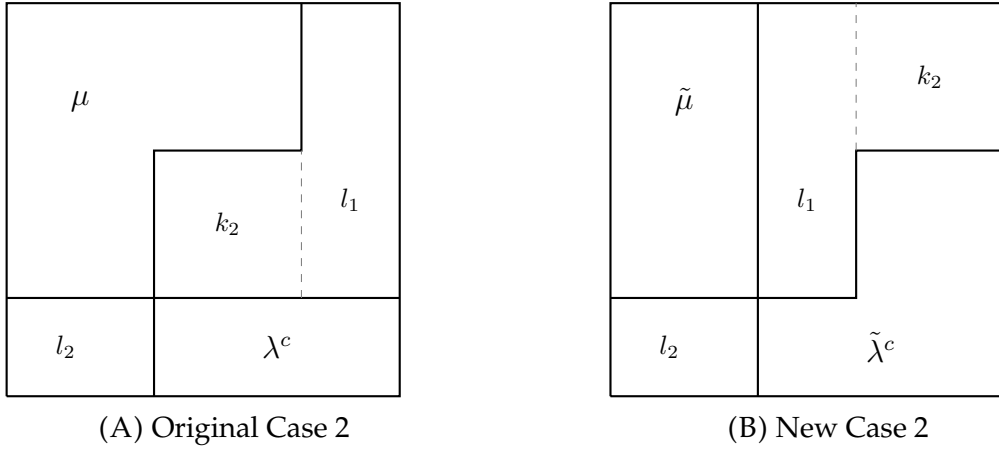

FIGURE 27. Case 2

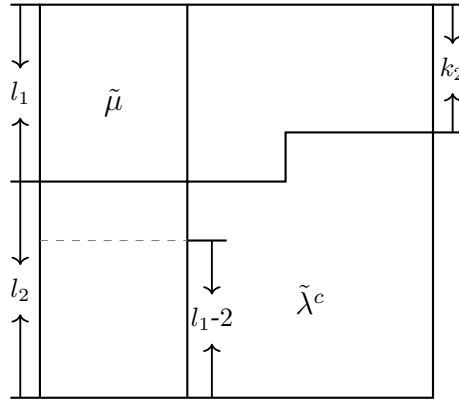

FIGURE 28. Case 2.1

Case 1.3.3 ($\ell(\mu^{(m)}) = l_1$): By the same argument as in Case 1.2.3, we have $c_{\mu,\nu}^\lambda = 0$.

Thus $m(\lambda/\mu) = \rho + 3$ in Theorem 4.6 (II) as desired.

Case 2 ($\lambda_2 = \mu_2, k_1 + k_2 = l_1$): We follow the notation of Theorem 3.13 Case 4. By Lemma 2.6, we can obtain $\tilde{\lambda}/\tilde{\mu}$ with $\tilde{\lambda} = (\tilde{\lambda}_1^{k_2}, \tilde{\lambda}_2^{k_1}, \tilde{\lambda}_3^{l_2})$ and $\tilde{\mu} = (\tilde{\mu}_1^{l_1})$ where $\tilde{\mu}_1 = \tilde{\lambda}_3 = \mu_2$ as shown in Figure 27. In addition we have

$$c_{\mu,\nu}^\lambda = c_{\tilde{\mu},\nu}^{\tilde{\lambda}} \text{ for all partitions } \nu,$$

and

$$(50) \quad m(\lambda/\mu) = m(\tilde{\lambda}/\tilde{\mu}).$$

Case 2.1 ($\rho = l_2 \geq l_1$): By Theorem 3.13, we know that $m(\lambda/\mu) \leq l_2 + 3$. Let $\nu \subset \tilde{\lambda}$ with $\ell(\nu) < l_2 + 3$. Then ν lies above the gray line in Figure 28. Since λ has shortness at least 3, we know $l_1 - 2 \geq 2$ and thus the bottom row of $\tilde{\lambda}/\nu$ has size $\tilde{\lambda}_3$. Since $\tilde{\mu}$ is a rectangle, by Lemma 4.2,

$$T(\ell(\tilde{\lambda}), c_1) = T(\ell(\tilde{\lambda}), c_2) \text{ for all } 1 \leq c_1, c_2 \leq \tilde{\lambda}_3.$$

for any ballot tableau T of shape $\tilde{\lambda}/\nu$ and content $\tilde{\mu}$. By Lemma 4.1,

$$\min\{z : \text{column } z \text{ contains } l_1\} = 1.$$

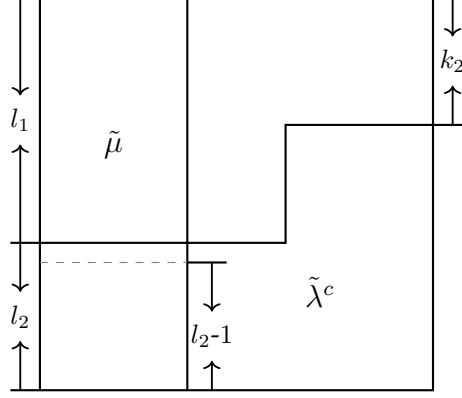

FIGURE 29. Case 2.2

Therefore

$$(51) \quad T(\ell(\tilde{\lambda}), c) = l_1 \text{ for all } c \in [\tilde{\lambda}_3].$$

Define $\tilde{\lambda}^{(1)}/\nu^{(1)} = (\tilde{\lambda}/\nu)^{\text{del}(1)}$. Then $\tilde{\lambda}^{(1)} = (\tilde{\lambda}_1^{k_2}, \tilde{\lambda}_2^{k_1}, \tilde{\lambda}_3^{l_2-1})$ and $\nu^{(1)} = \nu$. Thus, (51) implies $T^{\text{del}(1)}$ is a ballot tableau of shape $\tilde{\lambda}^{(1)}/\nu$ and content $\tilde{\mu}^{(1)} = (\tilde{\mu}_1^{l_1-1})$. By Corollary 4.5

$$c_{\tilde{\mu}, \nu}^{\tilde{\lambda}} \leq c_{\tilde{\mu}^{(1)}, \nu}^{\tilde{\lambda}^{(1)}}.$$

By repeatedly applying the above argument, we can conclude that the last $l_1 - 2$ rows of $\tilde{\lambda}/\nu$ are filled by $\{3, \dots, l_1\}$ where every row is filled by exactly one number. Set $\tilde{\lambda}^{(l_1-2)}/\tilde{\nu}^{(l_1-2)} = (\tilde{\lambda}/\nu)^{\text{del}(l_1-2)}$ and set $\tilde{\mu}^{(l_1-2)} = (\tilde{\mu}_1^2)$. By Corollary 4.5

$$c_{\tilde{\mu}, \nu}^{\tilde{\lambda}} \leq c_{\tilde{\mu}^{(l_1-2)}, \nu}^{\tilde{\lambda}^{(l_1-2)}}.$$

Since $\tilde{\mu}^{(l_1-2)}$ is a rectangle of shortness two and $\tilde{\lambda}^{(l_1-2)}$ is a fat hook, we know by Theorem 3.2 that the skew Schur function $s_{\tilde{\lambda}^{(l_1-2)}/\tilde{\mu}^{(l_1-2)}}$ is multiplicity-free and thus

$$c_{\tilde{\mu}^{(l_1-2)}, \nu}^{\tilde{\lambda}^{(l_1-2)}} \leq 1.$$

Therefore

$$c_{\tilde{\mu}, \nu}^{\tilde{\lambda}} \leq c_{\tilde{\mu}^{(l_1-2)}, \nu}^{\tilde{\lambda}^{(l_1-2)}} \leq 1 \text{ for all } \nu \text{ such that } \ell(\nu) \leq \rho + 2.$$

Thus $m(\lambda/\mu) = m(\tilde{\lambda}/\tilde{\mu}) = \rho + 3$ as required in Theorem 4.6 (V).

Case 2.2 ($\rho = l_1 > l_2$): Let $\nu \subset \tilde{\lambda}$ with $\ell(\nu) < l_1 + 1$. Then ν lies in the region above the gray line in Figure 29. Since λ has shortness at least 3, we have $l_2 - 1 \geq 2$ and thus the bottom row of $\tilde{\lambda}/\nu$ has size $\tilde{\lambda}_3$. By a similar argument as in Case 2.1, we know that the last $l_2 - 1$ rows of any ballot tableau T of shape $\tilde{\lambda}/\nu$ and content $\tilde{\mu}$ must be filled by $\{l_1 - l_2 + 2, \dots, l_1\}$. In addition, every row is filled by the same value. By Corollary 4.5, we conclude

$$c_{\tilde{\mu}, \nu}^{\tilde{\lambda}} \leq c_{\tilde{\mu}^{(l_2-1)}, \nu}^{\tilde{\lambda}^{(l_2-1)}}.$$

Since $\tilde{\lambda}^{(l_2-1)}$ is a fat hook of shortness 1 and $\tilde{\mu}^{(l_2-1)}$ is a rectangle, Theorem 3.2 implies that $s_{\tilde{\lambda}^{(l_2-1)}/\tilde{\mu}^{(l_2-1)}}$ is multiplicity-free. Therefore,

$$c_{\tilde{\mu}^{(l_2-1)}, \nu}^{\tilde{\lambda}^{(l_2-1)}} \leq 1,$$

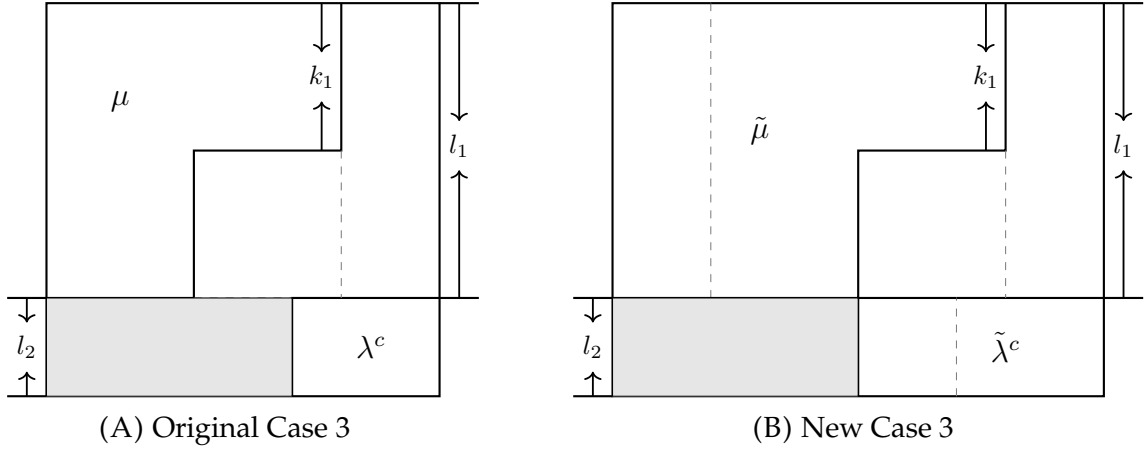

FIGURE 30. Case 3

and thus

$$c_{\bar{\mu}, \nu}^{\bar{\lambda}} = c_{\bar{\mu}^{(0)}, \nu}^{\bar{\lambda}^{(0)}} \leq c_{\bar{\mu}^{(l_2-1)}, \nu}^{\bar{\lambda}^{(l_2-1)}} \leq 1 \text{ for all } \nu \text{ such that } \ell(\nu) \leq \rho + 1.$$

By (50) we conclude that $m(\lambda/\mu) = \rho + 2$ in Theorem 4.6 (VI).

The remaining two cases correspond to Theorem 4.6 (III).

Case 3 ($\mu_2 < \lambda_2 < \mu_1$, $k_1 + k_2 = l_1$, $k_1 \geq l_2$): In this case $\rho = l_1$ and we interpret $c_{\mu, \nu}^{\lambda}$ as number of ballot tableaux of shape λ/μ and content ν .

Let T_0, T_1 be two distinct ballot tableaux of shape λ/μ with content ν such that $\ell(\nu) = m(\lambda/\mu)$. We can shift all the rows in T_0, T_1 that are below the bottom row of μ to the left so that the new shape satisfies the hypotheses of Theorem 4.6 Case 2. This shift is visualized in Figure 30(A) and Figure 30(B). Let \bar{T}_0, \bar{T}_1 be the resulting tableaux of shape $\bar{\lambda}/\bar{\mu}$, as in Figure 30(B). For $i \in \{0, 1\}$, \bar{T}_i remains semistandard and the row reading word of T_i is the same as \bar{T}_i . As a result, \bar{T}_0, \bar{T}_1 are two ballot tableaux whose contents are both ν as well. Therefore, by the definition of $m(\lambda/\mu)$,

$$(52) \quad m(\lambda/\mu) \geq m(\bar{\lambda}/\bar{\mu}).$$

Since $\bar{\lambda}/\bar{\mu}$ satisfies the hypotheses of Theorem 4.6 Case 2, we know that

$$(53) \quad m(\bar{\lambda}/\bar{\mu}) = \rho(\bar{\lambda}/\bar{\mu}) + 2.$$

Since we have $k_1 \geq l_2$, we have

$$(54) \quad \rho(\bar{\lambda}/\bar{\mu}) = \rho(\lambda/\mu).$$

Combining (52), (53), and (54) we get

$$m(\lambda/\mu) \geq \rho(\lambda/\mu) + 2.$$

By Theorem 3.13 $m(\lambda/\mu) \leq \rho(\lambda/\mu) + 2$, and so we conclude that $m(\lambda/\mu) = \rho + 2$.

Case 4 ($\mu_2 < \lambda_2 < \mu_1$, $k_1 + k_2 > l_1$, $k_1 \geq l_2$): In this case $\rho = l_1$. By (10), it suffices to show

$$c_{\lambda^\vee, \nu}^{\mu} \leq 1 \text{ for all } \nu \text{ such that } \ell(\nu) \leq \rho + 1.$$

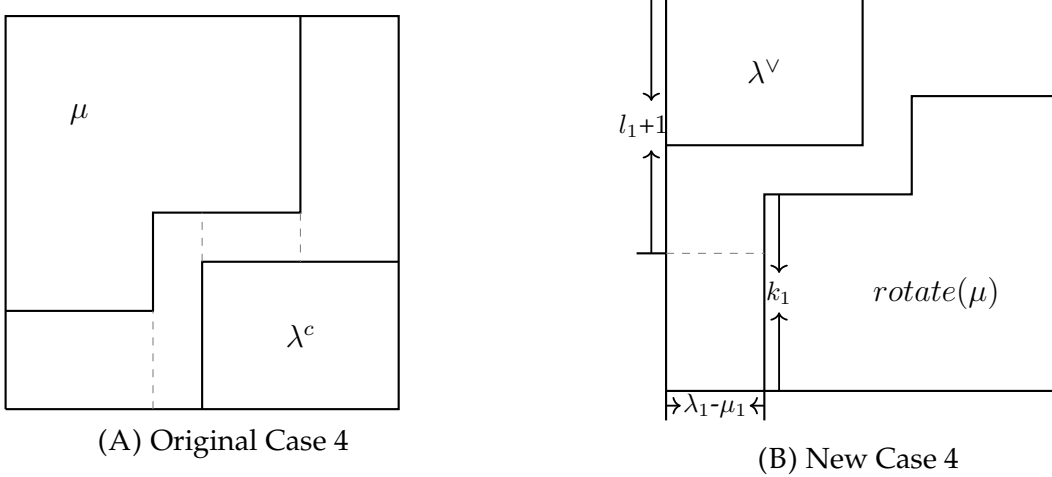

FIGURE 31. Case 4

Let $\nu \subset \mu^\vee$ with $\ell(\nu) < l_1$. We show there is at most one ballot tableau of shape μ^\vee/ν and content λ^\vee . Any such ν lies above the gray dashed line in Figure 31(B). We have

$$\lambda^\vee = ((\lambda_1 - \lambda_2)^{l_2}) \text{ and } \mu^\vee = (\lambda_1^{l_1+l_2-k_1-k_2}, (\lambda_1 - \mu_2)^{k_2}, (\lambda_1 - \mu_1)^{k_1}).$$

We write ν as

$$\nu = (\nu_1, \nu_2, \dots, \nu_{\ell(\nu)}).$$

Let T be a ballot tableau of shape μ^\vee/ν and content λ^\vee . Since $\rho = l_1$, there are $l_2 - 1$ rows below the gray dashed line in Figure 31(B). Since λ^\vee is a rectangle, Lemma 4.2 implies

$$T(\ell(\lambda), c) = l_2 \text{ for all } c \in [\lambda_1 - \mu_1].$$

Thus the second row from the bottom of T cannot contain any entry equal to l_2 . Again by Lemma 4.2, the row must be entirely filled by $l_2 - 1$. Since $k_1 \geq l_2 > l_2 - 1$, we know that all rows below the gray line have the same size. We can then apply Lemma 4.2 $l_2 - 1$ times and conclude that the last $l_2 - 1$ rows of T are filled by $\{2, \dots, l_2\}$. Set

$$\lambda^{(l_2-1)} = ((\lambda_1 - \lambda_2), (\mu_1 - \lambda_2)^{l_2-1}) \text{ and } \mu^{(l_2-1)} = (\lambda_1^{l_1+l_2-k_1-k_2}, (\lambda_1 - \mu_2)^{k_2}, (\lambda_1 - \mu_1)^{k_1-l_2+1}).$$

Since $k_1 \geq l_2$, we have

$$(55) \quad k_1 - l_2 + 1 > 0$$

and $\mu^{(l_2-1)}$ is a partition. By Corollary 4.5, we have

$$(56) \quad c_{\lambda^\vee, \nu}^{\mu^\vee} \leq c_{\lambda^{(l_2-1)}, \nu}^{\mu^{(l_2-1)}} \text{ for all } \nu \text{ such that } \ell(\nu) \leq \rho + 1.$$

By (55), there is least one row of size $\lambda_1 - \mu_1$ in $\mu^{(l_2-1)}$.

Case 4.1 ($\nu_{l_1+1} = \lambda_1 - \mu_1$): Since $\ell(\mu^{(l_2-1)}) = l_1 + 1$, the first $\lambda_1 - \mu_1$ columns in $\mu^{(l_2-1)}/\nu$ are empty. Let $\tilde{\mu}^{(l_2-1)}/\tilde{\nu}$ be the skew diagram that arises from deleting the first $\lambda_1 - \mu_1$ columns in $\mu^{(l_2-1)}/\nu$. Now $\tilde{\mu}^{(l_2-1)}$, $\tilde{\nu}$, and $\lambda^{(l_2-1)}$ are all contained in $(\mu_1^{l_1+l_2-k_1})$. Fix $(\mu_1^{l_1+l_2-k_1})$ as our ambient rectangle. Then $\tilde{\mu}^{(l_2-1)\vee}$ is a rectangle and $\lambda^{(l_2-1)}$ is a fat hook of shortness 1. Notice by construction that $\lambda_i^{(l_2-1)} < \tilde{\mu}_i^{(l_2-1)}$ for all $i \in [l_1 + l_2 - k_1]$. Thus the skew partition $\tilde{\mu}^{(l_2-1)}/\lambda^{(l_2-1)}$ is basic unless $\lambda_1^{(l_2-1)} > \tilde{\mu}_2^{(l_2-1)}$. If the skew partition is not basic, the basic demolition will remove column $\tilde{\mu}_2^{(l_2-1)} + 1$ through $\lambda_1^{(l_2-1)}$. Thus $(\lambda^{(l_2-1)})^{\text{ba}}$ would be a fat

hook of shortness 1 and $((\tilde{\mu}^{(l_2-1)})^{\text{ba}})^\vee$ would be a rectangle. Therefore by Theorem 3.2, the skew Schur function $s_{\tilde{\mu}^{(l_2-1)}/\lambda^{(l_2-1)}}$ is multiplicity-free. As a result, by (56),

$$c_{\lambda^\vee, \nu}^{\mu^\vee} \leq c_{\lambda^{(l_2-1)}, \nu}^{\mu^{(l_2-1)}} = c_{\lambda^{(l_2-1)}, \tilde{\nu}}^{\tilde{\mu}^{(l_2-1)}} \leq 1,$$

Case 4.2 ($\nu_{l_1+1} < \lambda_1 - \mu_1$): Since for any ballot tableau T of shape μ^\vee/ν and content λ^\vee , $T(l_1+2, c) = 2$ for all $c \in [\lambda_1 - \mu_1]$, we know that $T(l_1+1, c) = 1$ for all $c \in [\nu_{l_1+1}+1, \lambda_1 - \mu_1]$. Therefore if there exists a box in the bottom row of $\mu^{(l_2-1)}$ such that the box above it is not in ν , then any filling will violate semistandardness. As a result

$$(57) \quad \nu_{l_1} \geq \lambda_1 - \mu_1.$$

Let $x = (\lambda_1 - \mu_1) - \nu_{l_1+1}$ be the number of entries in the bottom row of $\mu^{(l_2-1)}/\nu$. Remove the bottom row of $\mu^{(l_2-1)}$ and its content as well as any box in the $(l_1 + 1)^{\text{th}}$ row of ν to obtain

$$\begin{aligned} \lambda^{(l_2)} &= ((\lambda_1 - \lambda_2 - x), (\mu_1 - \lambda_2)^{l_2-1}) \\ \mu^{(l_2)} &= (\lambda_1^{l_1+l_2-k_1-k_2}, (\lambda_1 - \mu_2)^{k_2}, (\lambda_1 - \mu_1)^{k_1-l_2}), \\ \nu^{(1)} &= (\nu_1, \nu_2, \dots, \nu_{l_1}). \end{aligned}$$

By Corollary 4.5, we obtain

$$c_{\lambda^\vee, \nu}^{\mu^\vee} \leq c_{\lambda^{(l_2)}, \nu^{(1)}}^{\mu^{(l_2)}}.$$

By (57), the first $\lambda_1 - \mu_1$ columns in $\mu^{(l_2)}/\nu^{(1)}$ are empty. Let $\tilde{\mu}^{(l_2)}/\tilde{\nu}^{(1)}$ be the skew partition that arises from deleting the first $\lambda_1 - \mu_1$ columns in $\mu^{(l_2)}/\nu^{(1)}$. Then $\tilde{\mu}^{(l_2)}$ lies in the rectangle $(\mu_1^{l_1+l_2-k_1})$. Fix $(\mu_1^{l_1+l_2-k_1})$ as the ambient rectangle. Then $\tilde{\mu}^{(l_2)\vee}$ is a rectangle and $\lambda^{(l_2)}$ is either a fat hook of shortness 1 or a rectangle. Notice by construction that $\lambda_i^{(l_2)} < \tilde{\mu}_i^{(l_2)}$ for all $i \in [l_1 + l_2 - k_1]$. The skew partition $\tilde{\mu}^{(l_2)}/\lambda^{(l_2)}$ is basic unless $\lambda_1^{(l_2)} > \tilde{\mu}_2^{(l_2)}$. If the skew partition is not basic, the basic demolition will remove column $\tilde{\mu}_2^{(l_2)} + 1$ through $\lambda_1^{(l_2)}$. Thus $(\lambda^{(l_2)})^{\text{ba}}$ would be a fat hook of shortness 1 and $((\tilde{\mu}^{(l_2)})^{\text{ba}})^\vee$ would be a rectangle. Therefore, by Theorem 3.2, the skew Schur function $s_{\mu^{(l_2)}/\lambda^{(l_2)}}$ is multiplicity-free. As a result,

$$c_{\lambda^\vee, \nu}^{\mu^\vee} \leq c_{\lambda^{(l_2)}, \nu^{(1)}}^{\mu^{(l_2)}} \leq 1.$$

We conclude

$$c_{\lambda^\vee, \nu}^{\mu^\vee} \leq 1 \text{ for all } \nu \text{ such that } \ell(\nu) \leq \rho + 1.$$

Combining Case 3 with Case 4, we have $m(\lambda/\mu) = \rho + 2$ in Theorem 4.6 (III). \square

4.2. λ^\vee is a rectangle of shortness at least 2 and $\text{np}(\mu) > 2$.

Theorem 4.9. *Let $s_{\lambda/\mu}(x_1, \dots, x_n)$ be a basic, n -sharp, tight skew Schur polynomial such that λ^\vee is a rectangle of shortness at least 2 and μ is not a fat hook, then the following are true:*

- (I) *If $\lambda_2 = \mu_q, l_2 \geq l_1$ then $m(\lambda/\mu) = \rho + 2$.*
- (II) *If $\lambda_2 = \mu_q, l_2 < l_1$ then $m(\lambda/\mu) = \rho + 1$.*
- (III) *If $\lambda_2 = \mu_1, k_1 \geq l_2$ then $m(\lambda/\mu) = \rho + 2$.*
- (IV) *If $\lambda_2 = \mu_1, k_1 < l_2$ then $m(\lambda/\mu) = \rho + 1$.*
- (V) *If $\mu_q < \lambda_2 < \mu_1$ then $m(\lambda/\mu) = \rho + 1$.*

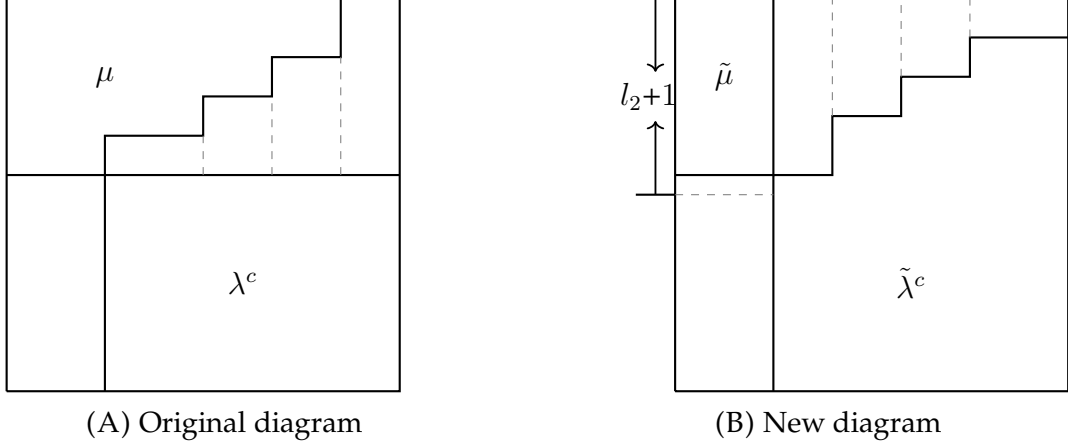

FIGURE 32. Theorem 4.9 (I)

Proof. Similar to Theorem 4.6, it is enough to show (38) holds in each of the five cases. Note that (38) holds trivially for Theorem 4.9 (II), (IV) and (V) since λ/μ is n -sharp.

Case 1 ($\lambda_2 = \mu_q, l_2 \geq l_1$): By Lemma 2.6, we can obtain $\tilde{\lambda}/\tilde{\mu}$ by setting

$$\tilde{\lambda} = (\tilde{\lambda}_1^{k_q}, \dots, \tilde{\lambda}_q^{k_1}, \tilde{\lambda}_{q+1}^{l_2}) \text{ and } \tilde{\mu} = (\tilde{\mu}_1^{l_1}),$$

where $\tilde{\lambda}_i = \lambda_1 + \mu_q - \mu_{q-i+1}$ for $i \in [q]$ and $\tilde{\lambda}_{q+1} = \tilde{\mu}_1 = \lambda_2$. This is visualized in Figure 32(A) and Figure 32(B). We then have

$$c_{\mu, \nu}^{\lambda} = c_{\tilde{\mu}, \nu}^{\tilde{\lambda}} \text{ for all partitions } \nu$$

Therefore we may equivalently show that $s_{\tilde{\lambda}/\tilde{\mu}}(x_1, \dots, x_{\rho+1})$ is multiplicity-free.

Since $\rho = l_2$, by (9), it is equivalent to show that there is at most one ballot tableau of shape $\tilde{\lambda}/\nu$ and content $\tilde{\mu}$ for any partition ν such that $\ell(\nu) \leq l_2 + 1$. Any such ν lies entirely in the region above the gray dashed line in Figure 32(B). Since $l_2 + 1 > l_1$, all rows in $\tilde{\lambda}/\nu$ below the gray line have the same size. By Lemma 4.2,

$$T(\ell(\tilde{\lambda}), c) = l_1 \text{ for all } c \in [\tilde{\lambda}_{q+1}].$$

Define $\tilde{\lambda}^{(1)}/\nu^{(1)} = (\tilde{\lambda}/\nu)^{\text{del}(1)}$. Since λ has shortness at least 2, $l_1 - 1 > 0$ and thus $\ell(\nu) < \ell(\tilde{\lambda})$, $\tilde{\lambda}^{(1)} = (\tilde{\lambda}_1^{k_q}, \dots, \tilde{\lambda}_q^{k_1}, \tilde{\lambda}_{q+1}^{l_2-1})$, $\nu^{(1)} = \nu$ and $\tilde{\mu}^{(1)} = (\tilde{\mu}_1^{l_1-1})$. By Corollary 4.5, we know that

$$c_{\tilde{\mu}, \nu}^{\tilde{\lambda}} \leq c_{\tilde{\mu}^{(1)}, \nu}^{\tilde{\lambda}^{(1)}}.$$

We may continue to apply Lemma 4.2 and Corollary 4.5, removing the bottom row of the skew diagram, as long as the bottom row of $\tilde{\lambda}^{(i)}$ and $\tilde{\mu}^{(i)}$ are of the same size and $\ell(\tilde{\lambda}^{(i)}) > \ell(\nu)$. We have $\ell(\tilde{\lambda}) - \ell(\nu) \geq l_2 - 1 \geq l_1 - 1$ and $\ell(\tilde{\mu}) = l_1$. Thus we may iterate this process $l_1 - 1$ times and get

$$\tilde{\lambda}^{(l_1-1)} = (\tilde{\lambda}_1^{k_q}, \dots, \tilde{\lambda}_q^{k_1}, \tilde{\lambda}_{q+1}^1) \text{ and } \tilde{\mu}^{(l_1-1)} = (\tilde{\mu}_1),$$

and

$$c_{\tilde{\mu}, \nu}^{\tilde{\lambda}} \leq c_{\tilde{\mu}^{(a-1)}, \nu}^{\tilde{\lambda}^{(a-1)}}.$$

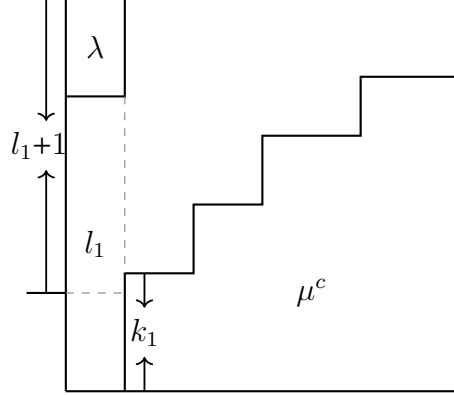

FIGURE 33. Theorem 4.9 (III) with μ^\vee

Since $\tilde{\mu}^{(a-1)}$ is a one row rectangle, it has shortness 1. As a result, by Theorem 3.2, the skew Schur function $s_{\tilde{\lambda}^{(a-1)}/\tilde{\mu}^{(a-1)}}$ is multiplicity-free and thus

$$c_{\tilde{\mu}^{(a-1)}, \nu}^{\tilde{\lambda}^{(a-1)}} \leq 1.$$

Thus $s_{\tilde{\lambda}/\tilde{\mu}}(x_1, \dots, x_{\rho+1})$ is multiplicity-free and $m(\lambda/\mu) = \rho + 1$ in Theorem 4.9 (I).

Case 2 ($\lambda_2 = \mu_1, k_1 \geq l_2$) Here we have $\rho = l_1$. By (10), it is enough to show

$$c_{\lambda^\vee, \nu}^{\mu^\vee} \leq 1 \text{ for all partition } \nu \subseteq \mu^\vee \text{ such that } \ell(\nu) \leq l_1 + 1.$$

Since $k_1 \geq l_2$, we get $l_1 + 1 > l_1 + l_2 - k_1$. Therefore all $l_2 - 1$ rows in $\tilde{\lambda}/\nu$ below the horizontal gray dashed line in Figure 33 have the same size for any ν such that $\ell(\nu) \leq l_1 + 1$. Write

$$\lambda^\vee = ((\lambda_1 - \mu_1)^{l_2}) \text{ and } \mu^\vee = (\lambda_1^{l_1+l_2-\ell(\mu)}, (\lambda_1 - \mu_q)^{k_q}, \dots, (\lambda_1 - \mu_1)^{k_1}).$$

By applying Lemma 4.2 and Corollary 4.5 $l_2 - 1$ times, we get

$$c_{\lambda, \nu}^{\mu} \leq c_{\lambda^{\vee(l_2-1)}, \nu}^{\mu^{\vee(l_2-1)}}$$

where

$$\lambda^{\vee(l_2-1)} = (\lambda_1 - \mu_1) \text{ and } \mu^{\vee(l_2-1)} = (\lambda_1^{l_1+l_2-\ell(\mu)}, (\lambda_1 - \mu_q)^{k_q}, \dots, (\lambda_1 - \mu_1)^{k_1-l_2+1}).$$

Since $\lambda^{\vee(l_1-1)}$ has shortness 1, the skew Schur function $s_{\mu^{\vee(l_1-1)}/\lambda^{\vee(l_1-1)}}$ is multiplicity-free and thus

$$c_{\mu, \nu}^{\lambda} = c_{\lambda^\vee, \nu}^{\mu^\vee} = c_{\lambda^{\vee(l_1-1)}, \nu}^{\mu^{\vee(l_1-1)}} \leq 1 \text{ for all } \nu \text{ such that } \ell(\nu) \leq \rho + 1.$$

Thus $s_{\lambda/\mu}(x_1, \dots, x_{\rho+1})$ is multiplicity-free and $m(\lambda/\mu) = \rho + 2$ in Theorem 4.9 (III). \square

ACKNOWLEDGMENTS

We thank Alexander Yong for helpful discussions. RH was partially supported by an AMS-Simons Travel Grant.

REFERENCES

- [ACM19] O. Azenhas, A. Conflitti, and R. Mamede. Multiplicity-free skew Schur functions with full interval support. *Sém. Lothar. Combin.* 75 ([2015-2019]), Art. B75j, 35 pp
- [AP14] R. Avdeev and A. Petukhov. Spherical actions on flag varieties. *Mat. Sb.*, 205(9):3–48, 2014.
- [FH91] William Fulton and Joe Harris. *Representation theory*, volume 129 of *Graduate Texts in Mathematics*. Springer-Verlag, New York, 1991. A first course, Readings in Mathematics.
- [FMS19] A. Fink, K. Mészáros, and A. St. Dizier. Zero-one Schubert polynomials. arXiv:1903.10332, March 2019.
- [G10] C. Gutschwager. On multiplicity-free skew characters and the Schubert calculus. *Ann. Comb.*, 14(3):339–353, 2010.
- [HL19] R. Hodges and V. Lakshmibai. A classification of spherical Schubert varieties in the Grassmannian. arXiv:1809.08003, 2019.
- [HY20] R. Hodges and A. Yong. Multiplicity-free key polynomials. arXiv:2007.09229, July 2020.
- [H95] Howe, Roger. Perspectives on invariant theory: Schur duality, multiplicity-free actions and beyond. The Schur lectures (1992) (Tel Aviv) 1–182, *Israel Math. Conf. Proc.*, 8, Bar-Ilan Univ., Ramat Gan, 1995
- [MWZ01] P. Magyar, J. Weyman, and A. Zelevinsky. Multiple flag varieties of finite type. *Adv. Math.*, 141(1):97–118, 1999.
- [P14] N. Perrin. On the geometry of spherical varieties. *Transform. Groups*, 19(1):171–223, 2014.
- [S99] R.P. Stanley. Enumerative combinatorics. Vol. 2. Cambridge Studies in Advanced Mathematics, 62. Cambridge University Press, Cambridge, 1999.
- [S01] J. Stembridge. Multiplicity-free products of Schur functions. *Ann. Comb.*, 5(2):113–121, 2001.
- [S03] ———, Multiplicity-free products and restrictions of Weyl characters. *Rep. Theory*, 7:404–439, 2003.
- [TY10] H. Thomas and A. Yong. Multiplicity-free Schubert calculus. *Canad. Math. Bull.*, 53(1):171–186, 2010.

DEPT. OF MATHEMATICS, U. ILLINOIS AT URBANA-CHAMPAIGN, URBANA, IL 61801, USA

Email address: sgao23@illinois.edu, rhodges@illinois.edu, gidono2@illinois.edu