

Snap-and-Chat Protocols: System Aspects

Joachim Neu, Ertem Nusret Tas, and David Tse

{jneu,nusret,dntse}@stanford.edu

Abstract. The availability-finality dilemma [13] says that blockchain protocols cannot be both available under dynamic participation and safe under network partition. Snap-and-chat protocols have recently been proposed as a resolution to this dilemma [19]. A snap-and-chat protocol produces an always available ledger containing a finalized prefix ledger which is always safe and catches up with the available ledger whenever network conditions permit. In contrast to existing handcrafted finality gadget based designs like Ethereum 2.0’s consensus protocol Gasper [3], snap-and-chat protocols are constructed as a black-box composition of off-the-shelf BFT and longest chain protocols. In this paper, we consider system aspects of snap-and-chat protocols and show how they can provide two important features: 1) accountability, 2) support of light clients. Through this investigation, a deeper understanding of the strengths and challenges of snap-and-chat protocols is gained.

1 Introduction

Due to a variant [13] of the infamous CAP theorem [11], there cannot be a secure state machine replication (SMR) consensus protocol with transactions as input and a ledger as output in an environment that exhibits both dynamic participation of validators and network partitions. Due to this dilemma, protocol designers had to decide whether to favor liveness or safety. To obviate a system-wide determination and leave the choice to the end-user, recent constructions output not a single ledger, but two ledgers, a dynamically *available* (full) *ledger* in conjunction with a *finalized* (prefix) *ledger*. When conditions permit, both ledgers are secure. During periods of low participation or network partitions (*i.e.*, when the CAP theorem is an active constraint), the available ledger remains live but might suffer from inconsistencies, while the finalized ledger remains safe but might stall (Figure 1). Once the environment has returned to favorable conditions, the available ledgers across nodes are reconciled to a single ‘common account of history’ and the finalized ledger catches up with the available ledger. Users choose whether to favor liveness (adopt the available ledger) or safety (adopt the finalized ledger). Eventually, all users will agree on a single history but in the process might temporarily lose safety or liveness, if network conditions do not allow otherwise. The above mechanics and properties have recently been formalized as an *ebb-and-flow property* in [19].

JN and ENT contributed equally and are listed alphabetically. Contact author: DT.

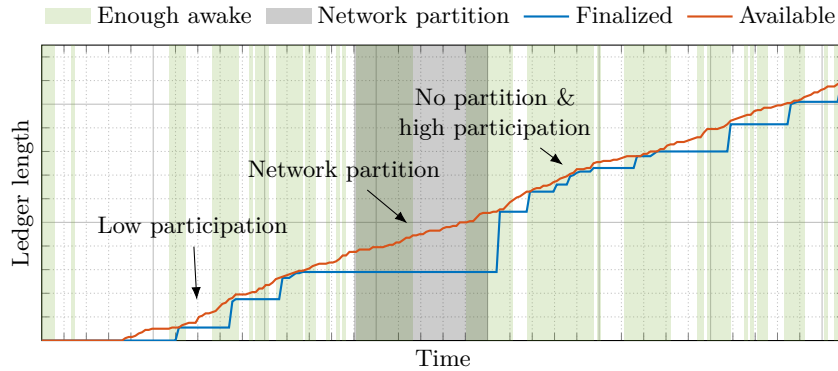

Fig. 1. Simulated run of a snap-and-chat protocol under dynamic participation and network partition. Lengths of the two ledgers are plotted over time. During network partition or when few nodes are awake, the finalized ledger falls behind the available ledger, but catches up after the network heals or when a sufficient number of nodes wake up. Modified from Figure 2 in [19].

Gasper [3], the current candidate for Ethereum 2.0’s beacon chain, combines the finality gadget Casper FFG [2] with the latest message driven (LMD) GHOST fork choice rule, and aims to be a secure ebb-and-flow protocol. However, [18, 19] demonstrated a bouncing-type liveness attack on Gasper in the synchronous network model. The attack causes Gasper to lose liveness of the finalized ledger and safety of the available ledger indefinitely, raising concerns about its suitability for the Ethereum 2.0 beacon chain. In the same work, *snap-and-chat protocols* have been proposed as a provably secure alternative, readily constructed via an almost-black-box composition of an off-the-shelf permissioned dynamically available protocol such as [7, 20] and an off-the-shelf partially synchronous Byzantine fault tolerant (BFT) consensus protocol such as [5, 6, 23].

However, besides security, many features required for an Internet-scale open-participation consensus infrastructure such as Ethereum 2.0 have been left to be desired in [19]. For instance, aspects of cryptoeconomic security and incentive compatibility have been neglected in [19]. Furthermore, since snap-and-chat protocols aim to be an alternative to Gasper as Ethereum 2.0’s beacon chain protocol, support for light clients is imperative but missing in [19].

Contributions We contribute solutions to the aforementioned shortcomings of snap-and-chat protocols. In particular, we show:

1. Snap-and-chat protocols, when constructed from typical BFT protocols following the propose-and-vote paradigm, such as HotStuff [23] or Streamlet [6], provide *accountable safety*. That is, a safety violation implies that at least a third of validators have provably violated the protocol’s so called *slashing conditions*. As a punitive and deterrent, those validators’ stake can be slashed, and since stake carries value, this attaches a price tag to safety violations and provides a notion of cryptoeconomic security.

2. Many users of, *e.g.*, a blockchain-based cryptocurrency, are only interested in the outcome of a small subset of the transactions. These users should not have to download all of the system’s data. Instead, it should suffice if they follow only the block headers (*light clients*) with respect to which they can later convince themselves (using auxiliary information furnished by an untrusted *full node* that maintains the whole system state) of the outcome of the transactions of interest. Standard approaches to supporting light clients fall short for snap-and-chat protocols due to particularities of the ledger extraction. We show how to tweak the standard approaches to apply them to snap-and-chat protocols to obtain light client support.

How we provide these features turns the spotlight on strengths and challenges of snap-and-chat protocols. Due to the modular construction of snap-and-chat protocols, some features of the constituent protocols are readily inherited by the snap-and-chat protocol – a strength of the approach exemplified by our treatment of accountability. On the flip side, in contrast to finality gadget (FG) based constructions, the more involved ledger extraction procedure of snap-and-chat protocols brings new challenges as it breaks, *e.g.*, standard approaches to light client support. We showcase how to overcome this challenge with a twist to the current techniques.

Outline In Section 2, we review the construction of snap-and-chat protocols and the ebb-and-flow security property they provide, so as to make the present paper self-contained. We also contrast snap-and-chat protocols with finality-gadget-based constructions and highlight resulting strengths and challenges. We show in Section 3 how accountable safety can be readily inherited from the BFT sub-protocol. To serve as a drop-in replacement, *e.g.*, for Gasper as Ethereum 2.0’s beacon chain protocol, it is important to support light clients, which we enable with a twist to standard techniques, shown in Section 4.

2 Snap-and-Chat Protocols

In this section, we briefly recapitulate the construction of snap-and-chat protocols and the ebb-and-flow security property they provide, as detailed in [19]. We also compare snap-and-chat protocols with finality gadget based designs such as [2, 3] and highlight strengths and challenges of snap-and-chat protocols.

Snap-and-chat protocols are constructed from an off-the-shelf dynamically available protocol Π_{lc} , *e.g.*, a longest chain (LC) protocol, and an off-the-shelf partially synchronous BFT protocol Π_{bft} (see Figure 2a). Nodes execute the snap-and-chat protocol Π_{sac} by executing the two sub-protocols in parallel. The Π_{lc} sub-protocol receives transactions txs from the environment and outputs an ever-increasing ledger LOG_{lc} of transactions. Over time, each node takes *snapshots* of this ledger based on its own current view, and inputs these snapshots into the second sub-protocol Π_{bft} . The output ledger LOG_{bft} of Π_{bft} is an ever-increasing ordered list of such snapshots, *i.e.*, of *prefixes* of LOG_{lc} . To create the finalized ledger LOG_{fn} of transactions (see Figure 2b), LOG_{bft} is flattened

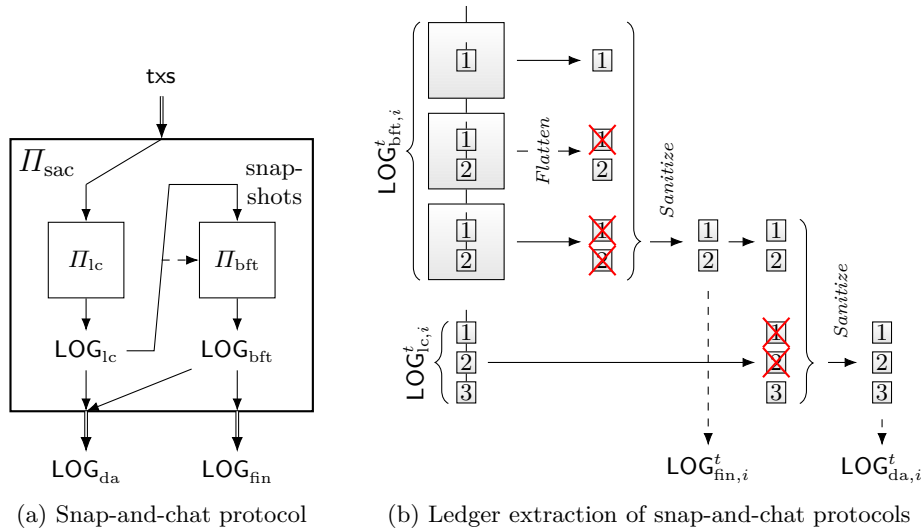

Fig. 2. Illustration of inner workings of snap-and-chat protocols. Variants of LOG with subscript i and superscript t denote ledgers as viewed by node i at time t .

(*i.e.*, all snapshots included in LOG_{bft} are concatenated as ordered) and sanitized (*i.e.*, all but the first occurrence of each block are removed). Finally, LOG_{fin} is prepended to LOG_{lc} and sanitized to form the available ledger LOG_{da} . This ensures the desired prefix property, namely that all users irrespective of whether they follow LOG_{da} or LOG_{fin} eventually agree on a single account of history.

An adversary could, in an attempt to break safety, input into Π_{bft} an ostensible snapshot of the ledger LOG_{lc} which really contains unconfirmed transactions. To rule out this possibility, each honest node boycotts in Π_{bft} the finalization of snapshots that are not locally viewed as confirmed in Π_{lc} . This requires a minor modification to the BFT protocol, which is provided in [19] for PBFT [5], Hotstuff [23] and Streamlet [6].

When any of these slightly modified BFT protocols is used in conjunction with a permissioned LC protocol [7, 20], the resulting snap-and-chat protocol satisfies the desired goal of a secure ebb-and-flow protocol with optimal resilience:

Theorem (Informal version of Theorem 1 in [19]). *Consider a network environment where:*

1. *Communication is asynchronous until a global stabilization time GST after which communication becomes synchronous, and*
2. *honest nodes sleep and wake up until a global awake time GAT after which all nodes are awake. Adversary nodes are always awake.*

Then

1. **P1 – Finality:** The finalized ledger LOG_{fin} is guaranteed to be safe at all times, and live after $\max\{\text{GST}, \text{GAT}\}$, provided that fewer than 33% of all the nodes are adversarial.
2. **P2 – Dynamic Availability:** If $\text{GST} = 0$, the available ledger LOG_{da} is guaranteed to be safe and live at all times, provided that at all times fewer than 50% of the awake nodes are adversarial.
3. **Prefix:** Under all circumstances, LOG_{fin} is a prefix of LOG_{da} .

The proof can be found in [19]. Here we give some intuition why this theorem is true, giving some insights into the design of snap-and-chat protocols:

- Under **P1**, which is the classical partially synchronous environment, the BFT sub-protocol Π_{bft} is safe. Hence, the finalized ledger LOG_{fin} , being the sanitized and flattened output of Π_{bft} is safe as well. This holds regardless of whether the dynamically available protocol Π_{lc} is safe. Moreover, both the sub-protocols Π_{lc} and Π_{bft} are safe and live after $\max\{\text{GST}, \text{GAT}\}$. Hence the finalized ledger LOG_{fin} is safe and live as well after this time.
- Under **P2**, the dynamically available sub-protocol Π_{lc} is safe and live. Regardless of whether Π_{bft} is safe, the snapshots that are fed into Π_{bft} are prefixes of each other and whatever Π_{bft} finalizes is always consistent with the output ledger LOG_{lc} of Π_{lc} . Thus, the finalized ledger LOG_{fin} is a prefix of LOG_{lc} , and the available ledger LOG_{da} , obtained by prepending LOG_{fin} to LOG_{lc} , is just LOG_{lc} , and is hence safe and live.

Comparison to Finality Gadget Based Designs An alternative approach to obtain ebb-and-flow protocols is to design a finality gadget (FG) [2, 8, 17, 21, 22] in conjunction with a dynamically available LC protocol as block proposal mechanism. The key difference between snap-and-chat protocols and typical FG-based designs is how consistency between the available and the finalized ledger is maintained. For FG-based designs, the ledger LOG_{lc} of the dynamically available block proposal mechanism and the ledger LOG_{bft} of the FG are output unaltered as LOG_{da} and LOG_{fin} , respectively. To ensure that LOG_{fin} is always a prefix of LOG_{da} , the fork choice rule of the dynamically available protocol has to be modified to honor prior finalizations. This feedback from the FG into the LC protocol renders security arguments intricate and can be a gateway for attacks [4, 16]. Snap-and-chat protocols, on the other hand, compute LOG_{da} and LOG_{fin} from LOG_{lc} and LOG_{bft} via a ledger extraction procedure (Figure 2b) that absorbs any inconsistencies that may arise. The modular design and absence of feedback from Π_{bft} to Π_{lc} facilitates a stringent security proof.

What is more, the modular construction of snap-and-chat protocols allows the use of state-of-the-art dynamically available protocols and state-of-the-art partially synchronous BFT protocols without the need to reinvent the wheel. As a result, snap-and-chat protocols can take advantage of future advances in the design of dynamically available protocols and in the design of partially synchronous BFT protocols. Furthermore, snap-and-chat protocols can readily take advantage of additional features provided by its unmodified sub-protocols. This

strength is showcased in Section 3 where a cryptoeconomic security property (accountable safety) of HotStuff and Streamlet is readily inherited by snap-and-chat protocols using either of the two BFT protocols as Π_{bft} . In contrast, FG-based designs entail handcrafting of the finality voting, the fork choice rule of the underlying Nakamoto-style chain, and all additional required features.

However, as a result of how they maintain consistency between the ledgers, FG-based designs and snap-and-chat protocols differ when it comes to determining transaction validity. In an FG-based design, both ledgers come from a single chain in the underlying LC protocol. Hence, if a transaction tx becomes part of one of the ledgers via an LC block b , then the transactions that precede tx in the ledger are those in the prefix of b . Hence, the validity of tx can be determined at the time b is produced. As a consequence, it is a typical requirement that valid blocks only contain valid transactions. This avoids wasting resources on invalid transactions and is leveraged in standard light client constructions.

On the other hand, in snap-and-chat protocols it is possible for two snapshots in Π_{bft} to come from two conflicting LC chains that were produced, *e.g.*, during a period of asynchrony. In this case, transactions from the first LC chain enter into LOG_{fin} before transactions from the second LC chain, potentially invalidating some of the latter although they seemed valid at the time the containing LC block b was composed considering the prefix of b . Consequently, unlike for FG-based constructions, it is not possible to determine with certainty at the time of composing an LC block b whether a contained transaction b will be considered valid when it is finally inserted into LOG_{fin} .¹ Since LOG_{fin} is prepended to LOG_{lc} to obtain LOG_{da} , the same argument applies to LOG_{da} . While the non-trivial ledger extraction of snap-and-chat protocols allows to decouple the sub-protocols and thus enables a stringent security proof for snap-and-chat protocols, it poses challenges when it comes to light client support, as standard techniques cannot be applied readily. Nonetheless, in Section 4 we present a twist to enable light clients for snap-and-chat protocols.

3 Accountability

A typical partially synchronous BFT protocol is secure as long as less than a third of validators are adversarial, and this threshold is optimal [9]. But what if more than a third of validators deviate from the protocol? A safety violation can then not be avoided. However, *accountable safety* provides a *cryptoeconomic notion of security*, where a safety violation cannot be prevented, but at least it can be attributed irrefutably to the wrongdoing of the validators that have caused it, and in response these validators’ stake can be confiscated. With such a retribution mechanism in place, a safety violation comes at a cost to the malicious actors, leading to better incentive alignment of protocol participants.

¹ Reorganization of transactions as they enter LOG_{fin} occurs only in the context of network partitions. Once honest validators have caught up with each other after a partition, no further reorganizations take place and nodes can predict the validity of transactions – until the next network partition.

Following [2,3], we develop accountability around a set of *slashing conditions* that a malicious validator must violate to produce a safety violation (in which case the misconduct will be observable to honest validators that suffer from the safety violation) and that an honest validator will never violate.

Definition 1. *A protocol provides α -accountable safety iff:*

1. *In the case of a safety violation of the produced ledger, (at least) $\alpha \cdot n$ validators can be irrefutably accused of protocol violations. (In particular, they must have violated one of the protocol's slashing conditions.)*
2. *An honest validator cannot be credibly falsely accused. (In particular, honest validators never violate the protocol's slashing conditions.)*

We show that both Streamlet [6] and HotStuff [23] provide $\frac{1}{3}$ -accountable safety. Since a necessary condition for a safety violation of LOG_{fin} of a snap-and-chat protocol is a safety violation of Π_{bft} , the following readily follows:

Theorem 1. *Snap-and-chat protocols, when constructed using Streamlet or HotStuff as Π_{bft} , provide $\frac{1}{3}$ -accountable safety for LOG_{fin} .*

This showcases a strength of the almost black-box construction of snap-and-chat protocols. Some properties and features of the constituent protocols can readily be inherited by the resulting snap-and-chat protocol.

First, we identify candidate slashing conditions for Streamlet:

Definition 2 (Streamlet slashing conditions). *Let B denote a BFT block at depth $|B|$, produced in Streamlet epoch e_B . A validator's stake is slashed if:*

1. *The validator votes for B_1, B_2 such that $e_{B_1} = e_{B_2}$.*
2. *The validator votes for B_1, B_2 such that $e_{B_1} < e_{B_2}$ but $|B_1| > |B_2|$.*

Accountable safety (with parameter α) has two complementary aspects, which we prove subsequently (for $\alpha = \frac{1}{3}$):

Lemma 1. *In the case of a safety violation in Streamlet, we can pinpoint $\alpha \cdot n$ validators that must have violated a slashing condition.*

Lemma 2. *Honest validators never violate a slashing condition in Streamlet.*

The proof of Lemma 1 proceeds along the safety argument of Streamlet.

Proof. Suppose there is a safety violation (see Figure 3), *i.e.*, from blocks B_1, B_2, B_3 of epochs $e-1, e, e+1$ and blocks B'_1, B'_2, B'_3 of epochs $e'-1, e', e'+1$, finalizing conflicting blocks B_2, B'_2 . Without loss of generality, let $|B_2| \leq |B'_2|$. Then there must be a block $B \neq B_2$ with $|B| = |B_2|$, let it be from epoch e_B . All blocks must be notarized, *i.e.*, $\geq 2n/3$ validators have voted for each block.

If $e_B \in \{e-1, e, e+1\}$, then by quorum intersection $\geq 1/3$ of validators have voted for both B and one of $\{B_1, B_2, B_3\}$ in the same epoch e_B . A violation of the first slashing condition.

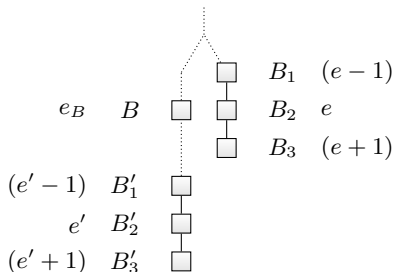

Fig. 3. Safety violation in Streamlet

If $e_B < e - 1$, then by quorum intersection $\geq 1/3$ of validators have first voted in epoch e_B for B of height $|B|$ and at a later epoch $e - 1$ voted for B_1 of lesser height $|B_1| = |B| - 1 < |B|$. A violation of the second slashing condition.

If $e + 1 < e_B$, then by quorum intersection $\geq 1/3$ of validators have first voted in epoch $e + 1$ for B_3 of height $|B_3|$ and at a later epoch e_B voted for B of lesser height $|B| = |B_3| - 1 < |B_3|$. A violation of the second slashing condition. \square

The proof of Lemma 2 follows by inspecting the Streamlet pseudocode [6].

Proof. An honest validator does not violate the first slashing condition because it only votes once per epoch. An honest validator does not violate the second slashing condition because if it has had a notarized chain in view of length $|B_1| - 1$ in epoch e_{B_1} (otherwise it would not have voted for B_1), then it will not vote for B_2 of depth $|B_2| \leq |B_1| - 1 < |B_1|$ in a later epoch e_{B_2} because B_2 does not extend the longest notarized chain (which is at least of length $|B_1| - 1$). \square

From Lemmas 1 and 2 readily follows:

Theorem 2. *Partially synchronous Streamlet provides $\frac{1}{3}$ -accountable safety.*

Thanks to the similarities between Streamlet and HotStuff, a very similar argument establishes accountable safety for HotStuff. Details in Appendix A. An independent contemporaneous work [12] reaches a similar conclusion and in particular details how to acquire proof of slashing condition violations.

4 Light Clients and Simple Payment Verification

Simple payment verification by light clients [15] (which only follow the blockchain headers but not the transaction data) can be supported after adding a few metadata to LC and BFT blocks and extending the block validity rules to ensure the proper calculation of these auxiliary fields. This metadata serves as a trust anchor with respect to which full nodes can answer light clients' queries verifiably.

The goal is to design simple payment verification such that if a light client obtains an answer to its query, then a full client would have received the same answer. In some circumstances where the full client can obtain an answer (but

only one that is potentially invalidated in the future due to a safety violation in LOG_{da}), the light client’s query might not be answerable in the given state from the given metadata, and the light client is asked to check back later.

In the following, we first describe the additional metadata added to BFT and LC blocks to enable light clients. Then, we describe the process of simple payment verification (SPV), which is the light client algorithm. Light clients use data availability proofs [1, 10, 24] before accepting a block’s header to ensure that the block is available for full nodes to answer light client queries.

BFT Blocks When a validator proposes a BFT block B extending B' , it knows the prefix $\text{LOG}_{\text{fin}}(B')$ the block B will have once it appears in LOG_{fin} (and also in LOG_{da}). It can thus extract the sequence of transactions $\Delta\text{txs}(B)$ that are newly introduced by B into the ledgers after sanitization, *i.e.*, $\Delta\text{txs}(B)$ is the sequence of transactions such that

$$\text{LOG}_{\text{fin}}(B) = \text{LOG}_{\text{fin}}(B') \parallel \Delta\text{txs}(B). \quad (1)$$

We refer to $\Delta\text{txs}(B)$ as the *innovation* brought by B . The BFT block producer commits to $\Delta\text{txs}(B)$ using, *e.g.*, a Merkle tree [14], the root of which is put into the header of B . All other validators can verify that the Merkle root was computed correctly and only then consider B valid.

LC Blocks When a validator proposes an LC block b extending b' , it knows which prefix $\text{LOG}_{\text{lc}}(b')$ the block b will have once it appears in LOG_{lc} . Furthermore, the validator i knows what prefix it would have in LOG_{da} if LOG_{lc} was prefixed with the current $\text{LOG}_{\text{fin},i}^t$ (*i.e.*, LOG_{fin} as it currently stands).² Thus, the validator can extract the *innovation*, *i.e.*, the sequence of transactions that are introduced by b and its prefix into LOG_{da} after sanitization, *assuming the current* LOG_{fin} . It commits to this sequence, *e.g.*, using a Merkle tree, the root of which is put into the header of b . Furthermore, the block producer adds to the LC block a reference (see Figure 4, ) pointing to the BFT block B representing $\text{LOG}_{\text{fin},i}^t$ to provide additional information on what state of LOG_{fin} was underlying the computation of the Merkle tree. Other validators can verify that the Merkle root was computed correctly and only then consider b valid. Furthermore, they consider b valid only if the referenced BFT block (representing $\text{LOG}_{\text{fin},i}^t$) is of no smaller depth than the BFT block referenced in b' , the parent of b . This ensures that the reference LOG_{fin} gets pushed forward frequently by the honest validators, and the adversary cannot downgrade to earlier, grossly outdated, reference LOG_{fin} .

Simple Payment Verification (SPV) Note that just like full clients, light clients either believe in network partitions or not. Based on this belief they decide whether to follow LOG_{fin} or LOG_{da} .

² To avoid overhead caused by invalid transactions, the validator should not include transactions in b that are invalidated by the current prefix, although the validator cannot be expected to avoid all conflicts with future prefixes and thus might include transactions that will be invalidated by later LOG_{fin} .

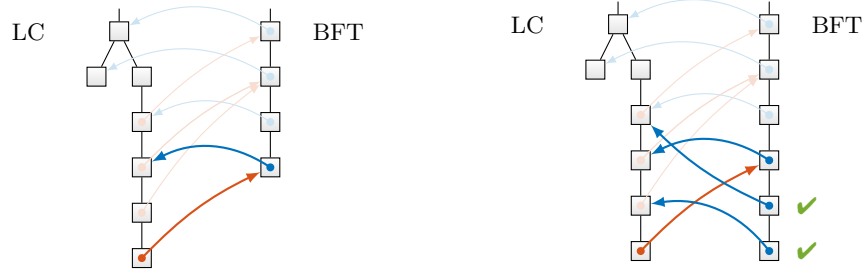

(a) The latest BFT block is the LOG_{fin} reference included in the most recent LC block – SPV can proceed.

(b) Snapshots introduced by BFT blocks since the last LOG_{fin} reference are consistent with the most recent LC block – SPV can proceed.

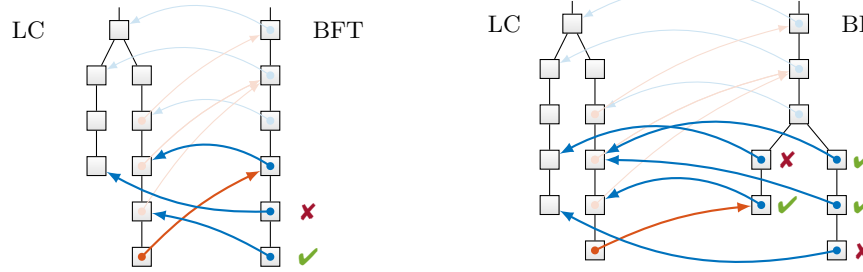

(c) Snapshots introduced by BFT blocks since the last LOG_{fin} reference are *not* consistent with the most recent LC block – SPV is unavailable.



(d) Complicated example of fictional ledger reorganization during which it is unsafe to use SPV because latest snapshots could introduce inconsistencies.

Fig. 4. Whether simple payment verification can be conducted by the light client depends on whether the latest BFT blocks since the LOG_{fin} reference (→) included in the latest LC block introduce incompatible snapshots or not (↔).

If a light client follows LOG_{fin} , then the metadata introduced above into the BFT block headers suffices to succinctly prove to a client that a certain transaction has been executed at a certain point in LOG_{fin} , by pointing the light client to the respective block B (the header of which the light client knows, including the Merkle root) and providing the Merkle proof corresponding to the transaction. This mechanism is directly analogous to SPV for Bitcoin [15].

If a light client follows LOG_{da} , then the metadata introduced above into the BFT and LC block headers can be used to succinctly prove to a client that a certain transaction has been executed at a certain point in LOG_{da} in most ordinary circumstances. If the latest confirmed LC block computed its light client auxiliary information based on a LOG_{fin} reference (→) that corresponds to the latest state of LOG_{fin} as viewed by the light client (see Figure 4a), then

the light client can be convinced that a certain transaction has taken place by providing the Merkle proof corresponding to the transaction relative to a Merkle root in either the LC block or in one of the BFT blocks in the prefix of the LOG_{fin} reference (depending on where the transaction was introduced).

If new BFT blocks have been finalized, so that LOG_{fin} as viewed by the light client is ahead of the LOG_{fin} reference of the latest confirmed LC block (Figure 4b), but all the additional BFT blocks' snapshots () lie in the prefix of the LC block, then the additional BFT blocks are harmless () in the sense that they merely move transactions from LOG_{da} to LOG_{fin} but without changing the order or introducing or removing transactions, and thus it is safe to rely on the light client metadata for SPV.

If new BFT blocks have been finalized whose snapshots lie outside of the prefix of the LC block (Figure 4c), then this is dangerous () as new transactions were potentially introduced in LOG_{fin} that can invalidate some of the transactions in the latest LC block. The light client metadata is potentially stale and cannot be used. In this case, the light client is not given a definitive answer and is instead asked to wait for the next LC block that will hopefully update the LOG_{fin} reference. Note, that this situation appears only under network condition/adversary **P1** when LOG_{da} is undergoing a safety violation to maintain prefix consistency with LOG_{fin} . In this case, LOG_{da} is unreliable. Still, we uphold that if the light client receives an answer to its query, then it must be the same answer that a full client would have received in the same situation. As that cannot be provided in this case, no answer is given to the light client.

The general rule is that the light client is not given a response to its query if on the path from the LOG_{fin} reference to the current LOG_{fin} as viewed by the light client there are snapshots that are not entirely contained in the prefix of the LC block. A more complicated problematic case is shown in Figure 4d. In the example at hand, moving from the LOG_{fin} reference to the latest finalized BFT block potentially changes the order in which transactions from the left/right LC chain enter into LOG_{fin} . Thus, the light client cannot answer the query using the auxiliary information. Note that this scenario is fictional as it involves a safety violation of BFT, which is possible only under network condition/adversary **P2**, under which in turn LC is safe and thus all snapshots are really fully contained in the prefix of the LC block. Thus, within the environments considered for ebb-and-flow protocols, this case cannot occur and is purely illustrative.

Pseudocode of SPV is given by Algorithm 1, which also details how LC blocks and BFT blocks are composed to produce the required light client auxiliary information. The function `Sanitize(.)` takes a sequence of transactions, determines for each transaction its validity with respect to its prefix, and outputs the sequence of valid transactions. The function `Merkleize(.)` takes a list and constructs a vector commitment that also allows efficient data availability checks. The commitment is part of the block header and as such downloaded by light clients, while the list itself is only kept by full nodes. The function `AcceptOpeningsWrt(.)` takes a set of commitments with respect to which the light client will accept responses provided by full nodes to its queries. The relation ' \preceq ' means 'is in the prefix of'.

Algorithm 1 Pseudocode for light client support of snap-and-chat protocols

```

1: function COMPOSEBFTBLOCK( $B^*, b^*$ )           ▷ Input: tips of BFT and LC chain
2:    $\Delta\text{txs} \leftarrow \text{Sanitize}(\text{LOG}_{\text{fin}}(B^*) \parallel \text{LOG}_{\text{lc}}(b^*)) \setminus \text{LOG}_{\text{fin}}(B^*)$ 
3:   return ( $\text{prev} = B^*, b = b^*, \text{auxinnov} = \text{Merkleize}(\Delta\text{txs})$ )
4: end function
5: function COMPOSELCBLOCK( $B^*, b^*, \text{txs}_{\text{new}}$ )
6:    $\Delta\text{txs} \leftarrow \text{Sanitize}(\text{LOG}_{\text{fin}}(B^*) \parallel \text{LOG}_{\text{lc}}(b^*) \parallel \text{txs}_{\text{new}}) \setminus \text{LOG}_{\text{fin}}(B^*)$ 
7:   return ( $\text{prev} = b^*, \text{txs} = \text{txs}_{\text{new}}, \text{auxref} = B^*, \text{auxinnov} = \text{Merkleize}(\Delta\text{txs})$ )
8: end function
9: function SIMPLEPAYMENTVERIFICATIONFORAVAILABLELEDGER( $B^*, b^*$ )
10:  if  $|\{B \in (\text{path from } b^*. \text{auxref to } B^*) \mid B.b \not\preceq b^* \wedge b^* \not\preceq B.b\}| > 0$  then
11:    return  $\text{AcceptOpeningsWrt}(\{B.\text{auxinnov} \mid B \preceq B^*\})$ 
12:  else
13:    return  $\text{AcceptOpeningsWrt}(\{b^*.\text{auxinnov}\} \cup \{B.\text{auxinnov} \mid B \preceq B^*\})$ 
14:  end if
15: end function

```

Following the ledger extraction (Figure 2b), ledgers with respect to the tips B and b of the BFT and LC chain, respectively, are defined recursively:

$$\text{LOG}_{\text{lc}}(b_{\text{genesis}}) = \emptyset \quad \text{LOG}_{\text{lc}}(b) = \text{Sanitize}(\text{LOG}_{\text{lc}}(b.\text{prev}) \parallel b.\text{txs}) \quad (2)$$

$$\text{LOG}_{\text{fin}}(B_{\text{genesis}}) = \emptyset \quad \text{LOG}_{\text{fin}}(B) = \text{Sanitize}(\text{LOG}_{\text{fin}}(B.\text{prev}) \parallel \text{LOG}_{\text{lc}}(B.b)) \quad (3)$$

$$\text{LOG}_{\text{da}}(B, b) = \text{Sanitize}(\text{LOG}_{\text{fin}}(B) \parallel \text{LOG}_{\text{lc}}(b)) \quad (4)$$

Finally, we prove the security of the construction, namely that a light client does not suffer from any safety violations other than those a full client in its stead would have also suffered from. If the client follows LOG_{fin} , it is obvious that this is the case. We proceed to show it for LOG_{da} .

Theorem 3. *If a light client following LOG_{da} accepts a transaction tx as valid at time t , then a full client in its stead would have done the same.*

Proof is given in Appendix B. Note that a trivial SPV procedure that does not accept any transaction satisfies the above security criterion. Hence, an SPV procedure that satisfies Theorem 3 is only useful if it can also ‘often’ verify the validity of transactions. The SPV procedure outlined by Algorithm 1 can quickly confirm the validity of transactions *under good network conditions*:

Theorem 4. *When LOG_{lc} is secure, a light client following LOG_{da} can confirm the validity of any transaction as quickly as a full client in the same situation.*

Proof is given in Appendix B. Recall from Section 2, LOG_{lc} is always secure under **P2** (in which case LOG_{da} is also live) and it regains its security after $\max\{\text{GST}, \text{GAT}\}$ under **P1** (in which case LOG_{fin} also becomes live). Hence, whenever LOG_{da} is secure and thus LOG_{lc} is secure, or LOG_{fin} is live, by Theorem 4, any transaction verifiable by a full client is verifiable by a light client.

Acknowledgment

We thank Sreeram Kannan for fruitful discussions. JN is supported by the Reed-Hodgson Stanford Graduate Fellowship. ENT is supported by the Stanford Center for Blockchain Research.

References

1. Al-Bassam, M., Sonnino, A., Buterin, V.: Fraud and data availability proofs: Maximising light client security and scaling blockchains with dishonest majorities. [arXiv:1809.09044](https://arxiv.org/abs/1809.09044) [cs.CR] (2018)
2. Buterin, V., Griffith, V.: Casper the friendly finality gadget. [arXiv:1710.09437](https://arxiv.org/abs/1710.09437) [cs.CR] (2017)
3. Buterin, V., Hernandez, D., Kamphefner, T., Pham, K., Qiao, Z., Ryan, D., Sin, J., Wang, Y., Zhang, Y.X.: Combining GHOST and Casper. [arXiv:2003.03052](https://arxiv.org/abs/2003.03052) [cs.CR] (2020)
4. Buterin, V., Stewart, A.: Beacon chain Casper mini-spec (comments #17 and #19) (2018), <https://ethresear.ch/t/beacon-chain-casper-mini-spec/2760/17>
5. Castro, M., Liskov, B.: Practical Byzantine fault tolerance. In: Proceedings of the Third Symposium on Operating Systems Design and Implementation. p. 173–186. OSDI '99, USENIX Association, USA (1999)
6. Chan, B.Y., Shi, E.: Streamlet: Textbook streamlined blockchains. Cryptology ePrint Archive, Report 2020/088 (2020)
7. David, B., Gazi, P., Kiayias, A., Russell, A.: Ouroboros Praos: An adaptively-secure, semi-synchronous proof-of-stake blockchain. In: EUROCRYPT 2018, Tel Aviv, Israel. pp. 66–98. LNCS, Springer (2018). https://doi.org/10.1007/978-3-319-78375-8_3
8. Dinsdale-Young, T., Magri, B., Matt, C., Nielsen, J.B., Tschudi, D.: Afgjort: A partially synchronous finality layer for blockchains. Cryptology ePrint Archive, Report 2019/504 (2019)
9. Dwork, C., Lynch, N., Stockmeyer, L.: Consensus in the presence of partial synchrony. *J. ACM* **35**(2), 288–323 (Apr 1988)
10. Feist, D.: Data availability checks (2019), <https://dankradfeist.de/ethereum/2019/12/20/data-availability-c>
11. Gilbert, S., Lynch, N.: Brewer’s conjecture and the feasibility of consistent, available, partition-tolerant web services. *SIGACT News* **33**(2), 51–59 (Jun 2002)
12. Kannan, S., Nayak, K., Sheng, P., Viswanath, P., Wang, G.: BFT protocol forensics. [arXiv:2010.06785](https://arxiv.org/abs/2010.06785) [cs.CR] (2020)
13. Lewis-Pye, A., Roughgarden, T.: Resource pools and the CAP theorem. [arXiv:2006.10698](https://arxiv.org/abs/2006.10698) [cs.DC] (2020)
14. Merkle, R.C.: A digital signature based on a conventional encryption function. In: Advances in Cryptology - CRYPTO '87. LNCS, vol. 293, pp. 369–378. Springer (1987). https://doi.org/10.1007/3-540-48184-2_32
15. Nakamoto, S.: Bitcoin: A peer-to-peer electronic cash system. <https://bitcoin.org/bitcoin.pdf> (2008)
16. Nakamura, R.: Analysis of bouncing attack on FFG (2019), <https://ethresear.ch/t/analysis-of-bouncing-attack-on-ffg/6113>
17. Nakamura, R.: Hierarchical finality gadget (2020), <https://ethresear.ch/t/hierarchical-finality-gadget/6829>

18. Neu, J., Tas, E.N., Tse, D.: A balancing attack on Gasper, the current candidate for Eth2’s beacon chain (2020), <https://ethresear.ch/t/a-balancing-attack-on-gasper-the-current-candidate-for-eth2s-beacon-chain/>
19. Neu, J., Tas, E.N., Tse, D.: Ebb-and-flow protocols: A resolution of the availability-finality dilemma. [arXiv:2009.04987](https://arxiv.org/abs/2009.04987) [cs.CR] (2020)
20. Pass, R., Shi, E.: The sleepy model of consensus. In: ASIACRYPT 2017, Hong Kong, China. LNCS, vol. 10625, pp. 380–409. Springer (2017). https://doi.org/10.1007/978-3-319-70697-9_14
21. Skidanov, A.: Fast finality and resilience to long range attacks with proof of space-time and Casper-like finality gadget. Whitepaper (2019), <http://near.ai/post>
22. Stewart, A., Kokoris-Kogia, E.: GRANDPA: a Byzantine finality gadget. [arXiv:2007.01560](https://arxiv.org/abs/2007.01560) [cs.DC] (2020)
23. Yin, M., Malkhi, D., Reiter, M.K., Gueta, G.G., Abraham, I.: HotStuff: BFT consensus with linearity and responsiveness. In: Proceedings of the 2019 ACM Symposium on Principles of Distributed Computing. p. 347–356. PODC ’19, ACM (2019)
24. Yu, M., Sahraei, S., Li, S., Avestimehr, S., Kannan, S., Viswanath, P.: Coded Merkle tree: Solving data availability attacks in blockchains. In: Financial Cryptography and Data Security - FC 2020, Kota Kinabalu, Malaysia. LNCS, vol. 12059, pp. 114–134. Springer (2020). https://doi.org/10.1007/978-3-030-51280-4_8

A Accountable Safety for HotStuff

First, we establish slashing conditions for HotStuff:

Definition 3 (HotStuff slashing conditions). *Recall that in HotStuff votes contain besides a block and the view number also a type (one of: PREPARE, PRE-COMMIT, COMMIT). A validator’s stake is slashed if:*

1. *The validator votes for the same type and the same view more than once.*
2. *The validator votes for conflicting blocks B_1, B_2 in two views $v_1 < v_2$ first COMMIT in view v_1 and later PREPARE in view v_2 (unless there has been a $\frac{2}{3}$ -majority for PREPARE for an earlier conflicting block B in view $v_1 < v < v_2$).*

Again, α -accountable safety has two complementary aspects (analogous to Lemmas 1 and 2), which we prove subsequently (for $\alpha = \frac{1}{3}$):

Lemma 3. *In the case of a safety violation in HotStuff, we can pinpoint $\alpha \cdot n$ validators that must have violated a slashing condition.*

Lemma 4. *Honest validators never violate a slashing condition in HotStuff.*

The proof of Lemma 3 proceeds along the safety argument of HotStuff.

Proof. Suppose there is a safety violation. For this, it is necessary that there are two quorum certificates (*i.e.*, a collection of $\geq 2/3$ votes – think of Streamlet notarizations) of type COMMIT for conflicting blocks B_1, B_2 .

If the certificates are of the same view, $v_1 = v_2$, then $\geq 1/3$ of validators have voted twice COMMIT in the same view, violating the first slashing condition.

So we can assume that the two quorum certificates come from different views $v_1 \neq v_2$. Without loss of generality, assume that the COMMIT quorum certificate for B_1 comes from a smaller view than that of B_2 , $v_1 < v_2$.

Now denote by v the lowest view higher than v_1 for which there is a valid quorum certificate of type PREPARE and the referenced block B conflicts with B_1 . Such v exists, because at least v_2 satisfies the above requirements (to obtain a COMMIT quorum certificate for v_2 , a PREPARE quorum certificate must have been issued before, otherwise honest validators will not contribute their (required!) shares in producing the COMMIT in v_2).

Now, $\geq 2/3$ of validators have contributed to the quorum certificates of type COMMIT in view v_1 and of type PREPARE in view v . So, at least $\geq 1/3$ of validators have first voted COMMIT in view v_1 and later voted PREPARE in view v , violating the second slashing condition.

Note that an honest node would not have violated the second slashing condition in this case, for the following reason. Consider a validator i from the intersection of the quorums. During view v_1 , i locked on a PRE-COMMIT of B_1 . By minimality of v , that lock cannot have been changed, as for a change of the lock another PRE-COMMIT and for that another PREPARE quorum certificate would have been required (otherwise honest validators do not contribute their votes, which are required to reach quorum), which contradicts minimality of v .

Thus, in view v , the proposed block would not have been considered safe ('SAFENODE'), as (a) it is not consistent with the lock on PRE-COMMIT of B_1 , and (b) the liveness exception of the safety rule is also not satisfied, because if it was, *i.e.*, if the justification for the proposal in v is a PREPARE quorum certificate that is of view higher than v_1 (but lower than v , otherwise it is invalid), then that contradicts the minimality of v . Thus, in view v , the validator i would not have voted PREPARE for the proposal that conflicts with B_1 . \square

The proof of Lemma 4 follows by inspecting the HotStuff pseudocode [23].

Proof. An honest validator does not violate the first slashing condition because it only votes once per type and view. An honest validator does not violate the second slashing condition because of the argument given at the end of the proof of Lemma 4. \square

From Lemmas 3 and 4 readily follows:

Theorem 5. *HotStuff provides $\frac{1}{3}$ -accountable safety.*

B Security Proof for Light Clients and SPV

B.1 Proof of Theorem 3

Proof. Assume that a light client following LOG_{da} accepts a transaction tx as valid at time t . Let b^* denote the LC block at the tip of the LC chain as viewed by the light client at time t and B denote the BFT block referenced () by b^* . Similarly, let B^* denote the tip of the BFT chain as viewed by the light client at

time t . By line 10 of Algorithm 1, the light client querying tx follows either the metadata of the BFT blocks in the prefix of B^* or the metadata in b^* , only if all of the BFT blocks in the path from B to B^* reference (\leftarrow) snapshots that are prefixes of $\text{LOG}_{\text{lc}}(b^*)$. Then, the transactions preceding tx within LOG_{da} at time t come from either $\text{LOG}_{\text{lc}}(b^*)$ or $\text{LOG}_{\text{fin}}(B)$, with respect to which tx is valid. (See the procedure for composing LC blocks in Algorithm 1.) Consequently, a full client in the same situation as the light client would also see tx as a valid transaction in LOG_{da} at time t . \square

B.2 Proof of Theorem 4

Proof. Assume that a light client following LOG_{da} queries a transaction tx and let b^* denote the tip of the LC chain. Note that when LOG_{lc} is secure, final BFT blocks cannot reference snapshots of LOG_{lc} that conflict with each other. Then, the BFT blocks on the path from the BFT block referenced (\rightarrow) by b^* to the tip of the BFT chain seen by the light client all reference (\leftarrow) snapshots that do not conflict with $\text{LOG}_{\text{lc}}(b^*)$. Hence, SPV can use the metadata in b^* (see lines 10 and 13 of Algorithm 1) through which the light client can verify the validity of tx as quickly as a full client in the same situation. \square