

TAIL BOUNDS FOR THE AVERAGED EMPIRICAL DISTRIBUTION ON A GEODESIC IN FIRST-PASSAGE PERCOLATION

CHRISTOPHER JANJIGIAN, WAI-KIT LAM, AND XIAO SHEN

ABSTRACT. We establish tail estimates for the averaged empirical distribution of edge weights along geodesics in first-passage percolation on \mathbb{Z}^d . Our upper bounds also come with exponentially decaying tail estimates for the empirical distribution. As an application, we show that if the edge weight distribution has finite positive moments of any order, then any limit point of the averaged empirical distribution of finite geodesics has finite positive moments of all orders.

CONTENTS

1. Introduction	1
2. Setting and main results	2
3. Upper bound for the upper tail	7
4. Lower bound for the upper tail	9
5. Upper bounds for general events	26
6. Lower tail exponents	27
Appendix A. Technical results	29
Appendix B. k -dependent greedy lattice animals	32
References	35

1. INTRODUCTION

First-passage percolation has been a central object of study in probability theory since it was originally introduced by Hammersley and Welsh [9] nearly sixty years ago as a model of the flow of fluid through a porous medium. It also arises naturally in a number of other settings, the most relevant of which for our purpose is as defining a random pseudo-metric on \mathbb{Z}^d . The model is constructed by attaching to each edge between nearest-neighbor sites on \mathbb{Z}^d a random non-negative weight, the collection of which we will assume to be i.i.d.. The distance between two sites is then the infimum of the weights collected by the self-avoiding nearest-neighbor paths connecting those two sites. Finite minimizing paths between two sites, called geodesics, exist under mild hypotheses on the weights.

Because geodesics are minimizers of this variational problem, it is natural to expect that the weights seen along a geodesic will be smaller than the typical weights seen in the environment as a whole. This is not entirely obvious and indeed is not necessarily true in general; with low probability, a geodesic may have to cross many edges with large weights in order to connect two sites. A natural tool to study questions about the size of weights along a geodesic is the empirical distribution of the weights along that geodesic. To compare the weights on the geodesic to typical weights in the environment as a whole, we then might choose to compare

this random measure to the marginal distribution of one of the weights. But, as noted previously, one still needs to account for the rare events where the empirical distribution behaves atypically. It is natural then to instead consider the expected value of the empirical distribution, which we call the averaged empirical distribution.

In 2015, at an American Institute of Mathematics workshop, Hoffman [10] conjectured that the empirical distribution along an infinite geodesic should converge in probability as the distance to the origin tends to infinity and asked whether limits were absolutely continuous with respect to the laws of the edge weights. We include a precise statement of these questions below as equation (2.9). It is natural to expect that the same should hold for the empirical distribution along a directional geodesic as the distance to the origin is sent to infinity. Heuristic arguments suggest that under natural hypotheses, in either of these cases, one should expect that any such limit in probability of the empirical distribution should be deterministic. Bates [4] recently posted a preprint stating that the empirical distribution of geodesics converges to a deterministic limit, so long as the weight distribution lies in some dense set. Our results show that when such deterministic limits exist, they will be absolutely continuous with respect to the law of the weights.

The present paper considers the empirical distribution on finite geodesics and gives new upper and lower bounds for the the upper and lower tails of the averaged empirical distribution. Our upper bounds for the upper tail are of particular interest. We prove an estimate on the expectation of the supremum over all empirical distributions from the origin to sites sufficiently far from the origin of the empirical probability of an upper tail event. Our proof also produces an exponentially decaying tail estimate for the empirical distribution in this regime. Because our result is uniform, our averaged tail bound passes both to limits of the empirical distribution of arbitrary finite directed geodesics and to limits of the empirical distribution along an infinite geodesic. An immediate consequence is that as soon as the weight distribution has any finite positive moment, any limit of the averaged empirical distribution will have finite moments of all orders.

Our methodology is inspired by a shell construction in the recent work of Nakajima [16] on the size of the maximal edge weight seen along a geodesic as well as the now-classical modification argument of van den Berg and Kesten [17]. In order to obtain the uniformity mentioned in the previous paragraph, we prove new some results about k -dependent greedy lattice animals in Appendix B which may be of independent interest.

Acknowledgements. This project was initiated at the 2019 AMS Mathematics Research Community on Stochastic Spatial Models. This manuscript was strongly influenced by discussions with and suggestions of Michael Damron. The authors are grateful to Ujan Gangopadhyay, Toby Johnson, and Pengfei Tang for helpful conversations at and after the MRC. This material is based upon work supported by the National Science Foundation under grant number DMS-1641020. C.J. was supported in part by NSF grant DMS-1954204.

2. SETTING AND MAIN RESULTS

Let $d \geq 2$ be an integer and denote by \mathcal{E}^d the set of nearest neighbor edges on the integer lattice \mathbb{Z}^d . The norms $|\bullet|_1$ and $|\bullet|_\infty$ denote the ℓ^1 and ℓ^∞ norms in \mathbb{R}^d . With some abuse of notation, $|\bullet|$ denotes either the absolute value of a real number or the number of edges in a nearest neighbor path depending on the input.

Let $\{\tau_e : e \in \mathcal{E}^d\}$ be a family of i.i.d. non-negative random variables which are defined on a probability space $(\Omega, \mathcal{F}, \mathbb{P})$. We denote the distribution of τ_e by μ , and its cumulative distribution function by F . The essential infimum of τ_e is denoted by r .

We denote by $p_c = p_c(d)$ the critical probability for Bernoulli bond percolation on \mathbb{Z}^d , and $\vec{p}_c = \vec{p}_c(d)$ the critical probability for oriented percolation on \mathbb{Z}^d . Throughout this paper, we always assume

$$F(r) < \begin{cases} p_c & \text{if } r = 0, \\ \vec{p}_c & \text{if } r > 0. \end{cases} \quad (2.1)$$

A path γ of length n is an alternating sequence of vertices and undirected edges subject to the following constraints. Writing $\gamma = (x_0, \gamma_0, x_1, \gamma_1, \dots, x_{n-1}, \gamma_{n-1}, x_n)$, the vertices and edges satisfy $|x_i - x_{i+1}|_1 = 1$ and $\gamma_i = \{x_i, x_{i+1}\} \in \mathcal{E}^d$ for all $0 \leq i \leq n-1$. Such a path is said to be vertex self-avoiding if each vertex $x \in \mathbb{Z}^d$ appears at most once in γ .

The *passage time* of a path γ is given by

$$\mathsf{T}(\gamma) = \sum_{e \in \gamma} \tau_e.$$

For $x, y \in \mathbb{Z}^d$, the *first-passage time* from x to y is defined by

$$\mathsf{T}(x, y) = \inf_{\gamma: x \rightarrow y} \mathsf{T}(\gamma)$$

where the infimum is over all vertex self-avoiding lattice paths γ which begin at the vertex x and end at the vertex y .

Any vertex self-avoiding path γ which begins at x , ends at y , and satisfies $\mathsf{T}(x, y) = \mathsf{T}(\gamma)$ is called a *geodesic*. We denote the collection of geodesics between x and y by $\Pi(x, y) = \{\gamma : \mathsf{T}(x, y) = \mathsf{T}(\gamma)\}$. Fix an arbitrary deterministic ordering of all vertex self-avoiding finite lattice paths. We denote by $\pi(x, y)$ the first geodesic in this ordering from x to y . We will denote $\Pi(0, x)$ by Π^x and $\pi(0, x)$ by π^x .

Given a geodesic π and a site $x \in \mathbb{Z}^d$, our interest will be in the random Borel measures on $\mathbb{R}_{\geq 0}$ defined by

$$\begin{aligned} \nu^\pi(B) &= \frac{1}{|\pi|} \# \{e \in \pi : \tau_e \in B\} = \frac{1}{|\pi|} \sum_{i=0}^{|\pi|-1} \mathbb{1}_{\{\tau_{\pi_i} \in B\}} \quad \text{for } B \in \mathcal{B}(\mathbb{R}_{\geq 0}), \\ \nu^{(x)}(B) &= \frac{1}{|\pi^x|} \# \{e \in \pi^x : \tau_e \in B\} = \frac{1}{|\pi^x|} \sum_{i=0}^{|\pi^x|-1} \mathbb{1}_{\{\tau_{\pi_i^x} \in B\}} \quad \text{for } B \in \mathcal{B}(\mathbb{R}_{\geq 0}). \end{aligned}$$

Here, π_i denotes the $(i+1)$ -st edge of π , with a similar convention for π^x , and $\mathcal{B}(\mathbb{R}_{\geq 0})$ denotes the set of all Borel sets in $\mathbb{R}_{\geq 0}$.

Our main results, Theorems 2.3, 2.5, 2.6, and 2.7 below, establish upper and lower bounds for the upper and lower tails of the averaged empirical distribution $\mathbb{E}[\nu^{(x)}]$.

Before continuing, we make the following observations about condition (2.1).

Remark 2.1. In dimensions $d \geq 3$, we need $F(0) < p_c$ to guarantee that there a.s. exists a finite geodesic between any two points [3, Proposition 4.4]. When $F(0) = p_c$, the existence of a finite geodesic is still open [3, Question 4.1.1]; the case when $F(0) > p_c$ is solved in [18, Theorem 2]. Furthermore, provided $F(0) \geq p_c$ and finite geodesics exist, the limiting empirical distribution converges weakly in probability to δ_0 . If $r > 0$ and $F(r) > \vec{p}_c$ then,

in the directions of the “percolation cone”, the empirical distribution converges to δ_r . For a proof, see [4, Theorem 1.6, Example 1.7].

Intuitively, we should expect that geodesics prefer to choose edge-weights which are smaller than what would be typical under μ . The next lemma shows that this intuition can be made rigorous as a quick consequence of the FKG inequality.

Lemma 2.2. *For any $t > 0$ and $e \in \mathcal{E}^d$, $\mathbb{P}(\tau_e \leq t | e \in \pi^x) \geq \mathbb{P}(\tau_e \leq t)$.*

Proof. Note that there exists a (possibly negative) random variable d_e which is measurable with respect to $\mathcal{G}_e = \sigma(\tau_{e'} : e' \neq e)$ so that $e \in \pi^x$ if and only if $\tau_e \leq d_e$. Note that the events $\{\tau_e \leq t\}$ and $\{\tau_e \leq d_e\}$ are both decreasing. In the latter case, this is after freezing the values of $\tau_{e'}$ for $e' \neq e$. From the independence of τ_e and \mathcal{G}_e , the FKG inequality gives

$$\mathbb{P}(\tau_e \leq t, \tau_e \leq d_e | \mathcal{G}_e) \geq \mathbb{P}(\tau_e \leq t) \mathbb{P}(\tau_e \leq d_e | \mathcal{G}_e) \quad \mathbb{P}\text{-a.s.}$$

Taking expectations, it then follows that

$$\mathbb{P}(\tau_e \leq t, e \in \pi^x) \geq \mathbb{P}(\tau_e \leq t) \mathbb{P}(e \in \pi^x). \quad \square$$

Conversely, it is also natural to expect that the upper tail of the empirical distribution should typically decay faster than the upper tail of μ . The next result gives our main upper bound for the upper tail of the averaged empirical distribution.

Theorem 2.3. *Suppose (2.1) holds. For each $k \in \mathbb{N}$ there exist constants $C_1, C_2 > 1$ and $C_3, C_4, C_5 > 0$ such that the following hold. For any $M \geq 0$, there exists $n_1 \in \mathbb{N}$ such that for any $s > C_2$*

$$\mathbb{P} \left(\sup_{|x|_1 \geq n_1} \max_{\pi \in \Pi^x} \nu^\pi[M, \infty) \geq s \mu[M/C_1, \infty)^{(1-\frac{1}{d})k} \right) \leq C_3 e^{-C_4 s}. \quad (2.2)$$

Moreover,

$$\mathbb{E} \left[\sup_{|x|_1 \geq n_1} \max_{\pi \in \Pi^x} \nu^\pi[M, \infty) \right] \leq C_5 \mu[M/C_1, \infty)^{(1-\frac{1}{d})k}. \quad (2.3)$$

Theorem 2.3 implies that for $k \in \mathbb{N}$ and $M > 1$, if $(x_n : n \in \mathbb{N}) \subset \mathbb{Z}^d$ is any sequence of random variables with $|x_n|_1 \rightarrow \infty$ almost surely, then any limit point of the averaged empirical distributions $\mathbb{E}[\nu^{(x_n)}(\bullet)]$, denoted by ν , will satisfy

$$\nu(M, \infty) \leq C_5 \mu[M/C_1, \infty)^{(1-\frac{1}{d})k}. \quad (2.4)$$

In particular, if μ has finite positive moments of any order, then ν will have finite positive moments of all orders. This observation also passes to in-probability limits $\nu^{(x_n)} \Rightarrow \nu$, provided that ν is deterministic.¹ Bates’ recent preprint [4] states the result that for each $\xi \in \mathbb{R}^d$ with $|\xi| = 1$ and for a dense set of edge-weight distributions, the almost sure weak limit of the empirical distribution $\nu^{(\lfloor n\xi \rfloor)}$ exists and is deterministic.

¹To see this, pass to a subsequence along which the convergence is almost sure. Let M be a continuity point of ν , so that $\nu^{(x_n)}(M, \infty) \rightarrow \nu(M, \infty)$ almost surely; apply Fatou’s lemma to obtain (2.4). Continuity points are co-countable, so the claim about moments follows.

Remark 2.4. Arguments similar to those in the proof of Theorem 2.3 can be used to show that if (2.1) holds and if $\mathbb{E}[\min\{\tau_{e_1}, \tau_{-e_1}, \dots, \tau_{e_d}, \tau_{-e_d}\}^p] < \infty$ for some $p > 1$, then for any $\ell \geq 1$, there exists a constant $C_6 > 0$ such that for each $k \in \mathbb{N}$ sufficiently large (depending on d, p , and ℓ) and for all $x \in \mathbb{Z}^d$ with $|x|_1 \geq 2(2k)^d$,

$$\mathbb{E} \left[\int_0^\infty t^\ell d\nu^{(x),k}(t) \right] \leq C_6.$$

Here, $\nu^{(x),k}$ is the empirical distribution of the segment of π^x obtained by removing the first and last $(2k)^d$ steps from π^x . This truncation is necessary because the distribution of the edges near 0 and x in π^x cannot have faster tail decay than the minimum of a small number of independent μ -distributed random variables. The moment assumption is used in the proof in order to obtain quantitative control on the length of the geodesic.

Given the upper bounds established above, it is natural to wonder if there are limitations on how much lighter the tail of the averaged empirical distribution can be than the original distribution. For example, if μ has polynomial tail decay, might it be the case that $\mathbb{E}[\nu^{(x)}]$ has sub-exponential or even sub-Gaussian upper tails? Our next result gives limitations on how strong the improvement in upper-tail behavior can be. For most named distributions, this bound can typically be rewritten in the form

$$\mathbb{E}[\nu^{(x)}[M, \infty)] \geq \mu[M, \infty)^{C_M}.$$

For example, the next result implies that if the weights have polynomial tails, then the a limit point of the averaged empirical distribution cannot be sub-Gaussian; similarly, if the weights are exponentially distributed, then one cannot hope for tail decay which is better than sub-Gaussian.

Theorem 2.5. *Suppose (2.1) holds. Fix $\gamma, L \in \mathbb{N}$. There exist constants $C_7, C_8, M_1 > 0$ such that for all $M \geq M_1$, and $x \in \mathbb{Z}^d$ with $|x|_1 \geq C_8 M^2$*

$$\mathbb{E}[\nu^{(x)}[M, \infty)] \geq \left[\mu[M, \gamma M]^{C_7} \mu[M, \infty)^{C_7 M} \right] \vee \left[\sum_{i=0}^L \gamma^{-i} \mu[\gamma^i M, \gamma^{i+1} M]^{C_7 \gamma^i M} \right]. \quad (2.5)$$

Moreover,

$$\begin{aligned} & \liminf_{|x| \rightarrow \infty} \mathbb{E}[\nu^{(x)}[M, \infty)] \\ & \geq \left[\mu[M, \gamma M]^{C_7} \mu[M, \infty)^{C_7 M} \right] \vee \left[\sum_{i=0}^{\infty} \gamma^{-i} \mu[\gamma^i M, \gamma^{i+1} M]^{C_7 \gamma^i M} \right]. \end{aligned} \quad (2.6)$$

In the previous result we include the more complicated second term in the maximum instead of using only the first term because it is possible that along a sequence in M , $\mu[M, \gamma M]$ may be identically zero.

The next result limits the extent to which the empirical distribution can deviate from the marginal distribution of the edge weights, μ . Returning to our heuristic, we expect that geodesics not only avoid large weights, but also tend to take a relatively large number of edges with weights near the infimum of the support of μ , which we denoted by r . Therefore, one might expect that the empirical distribution on the geodesic should have a larger mass near r than μ . Our bound limits this effect.

Theorem 2.6. *Suppose (2.1) holds. There exist constants $C_9, C_{10}, C_{11}, C_{12} > 0$ such that that for any Borel set $B \subset \mathbb{R}$ with $\mu(B) > 0$, there exists an index $n_2 = n_2 \in \mathbb{N}$ so that for all $s > C_9$,*

$$\mathbb{P} \left(\sup_{|x|_1 \geq n_2} \max_{\pi \in \Pi^x} \nu^\pi(B) > s\mu(B)^{\frac{1}{d}} \right) \leq C_{10} e^{-C_{11}s}. \quad (2.7)$$

Moreover,

$$\mathbb{E} \left[\sup_{|x|_1 \geq n_2} \max_{\pi \in \Pi^x} \nu^\pi(B) \right] \leq C_{12} \mu(B)^{\frac{1}{d}}. \quad (2.8)$$

As mentioned in the introduction, Hoffman posed the following question at an American Institute of Mathematics workshop in 2015 [10]:

Given the sequence of edges along an infinite geodesic (π_0, π_1, \dots) , prove (2.9)

that $\left[n^{-1} \sum_{i=0}^{n-1} \delta_{\tau_{\pi_i}} \right]$ converges (weakly) to some probability measure. Is

this measure singular with respect to the original law on the edge weights?

Theorem 2.6 implies that if $(x_n : n \in \mathbb{N}) \subset \mathbb{Z}^d$ is any sequence of random variables with $|x_n|_1 \rightarrow \infty$ almost surely, then any limit point of the averaged empirical distributions $\mathbb{E}[\nu^{(x_n)}(\bullet)]$ is absolutely continuous with respect to μ . Assuming the existence of an in-probability limit $\nu^{(x_n)} \Rightarrow \nu$, where ν is deterministic and $(x_n : n)$ is a measurable selection of the sequence of sites along an infinite geodesic, this gives a negative answer to the second part of the question in (2.9). The question of whether there exist exceptional directions or infinite geodesics where absolute continuity of the limit of the empirical distribution fails remains open, even if we assume the existence of such limits.

Next, we give a lower bound for the the lower tail of the averaged empirical distribution.

Theorem 2.7. *Suppose (2.1) holds. There exists a constant C_{13} so that for any $\epsilon \geq 0$, there exists an index $n_3 \in \mathbb{N}$ such that for all $|x|_1 \geq n_3$,*

$$\mathbb{E} \left[\nu^{(x)}[r, r + \epsilon] \right] \geq C_{13} \mu[r, r + \epsilon]. \quad (2.10)$$

It is natural to wonder which, if any, of the exponents $1/d$ and 1 in the bounds in Theorem 2.6 and Theorem 2.7 are sharp. The former bound comes from comparison to greedy lattice paths: any self-avoiding path which begins at 0 and takes on the order of n many steps will only encounter at most on the order of $n\mu[r, r + \epsilon]^{1/d}$ many weights taking values in the interval $[r, r + \epsilon]$. It is natural to expect that this mechanism is essentially sharp for Bernoulli FPP. This is the content of our next result.

Proposition 2.8. *Fix $p_0 < p_c(d)$. Let $a_n = n(e_1 + \dots + e_d)$ and suppose that τ_e is Bernoulli distributed with $\mathbb{P}(\tau_e = 0) = p$ and $p < p_0$. There exist a constant $C_{14} = C_{14}(d, p_0)$ and an index $n_4 = n_4(d, p) \in \mathbb{N}$, so that for all $n \geq n_4$,*

$$C_{14} n p^{1/d} \leq \mathbb{E} \left[\# \left\{ e \in \pi^{(a_n)} : t_e = 0 \right\} \right].$$

Furthermore, there exists an index $n_5 = n_5(d, p)$ such that for $n \geq n_5$, we have

$$C_{14} p^{1/d} \leq \mathbb{E} \left[\nu^{(a_n)}(\{0\}) \right].$$

It would be interesting to know if the exponent 1 in the lower bound in Theorem 2.7 might be optimal for certain edge-weight distributions. Identifying the correct rate of decay of the lower tail for edge-weights with a continuous distribution would be of particular interest in future work.

Finally, we provide a general upper bound when the interval that we are measuring is bounded away from the infimum of the support of μ .

Proposition 2.9. *Fix $b > r$ with $\mu(r, b) > 0$. There exists a constant $C_{15} > 0$ and an index $n_6 \in \mathbb{N}$, depending on d, b and μ , such that for any $(c, h) \subset [b, \infty)$ and $|x|_1 \geq n_6$,*

$$\mathbb{E} \left[\nu^{(x)}(c, h) \right] \leq C_{15} \mu(c, h).$$

The remainder of the paper is organized as follows. Section 3 is devoted to the proof of Theorems 2.3, which give bounds on the upper tail behavior of the empirical distribution. Section 4 contains the proof of Theorem 2.5, which comes from a van den Berg–Kesten style modification argument. Section 5 is devoted to proving Theorem 2.6, which controls the number of edges along a geodesic which can lie within a given arbitrary Borel set. In Section 6, we turn to the question of the lower tail exponents and prove Theorem 2.7 and Propositions 2.8 and 2.9. Appendix A collects our technical results and Appendix B contains some results on k -dependent greedy lattice animals.

3. UPPER BOUND FOR THE UPPER TAIL

This section is devoted to the proof of Theorem 2.3. Part of the proof is similar to the shell argument used by Nakajima in Section 2 of [16]; we give an illustration of the main idea in the case of $d = 2$ in Figure 3.1.

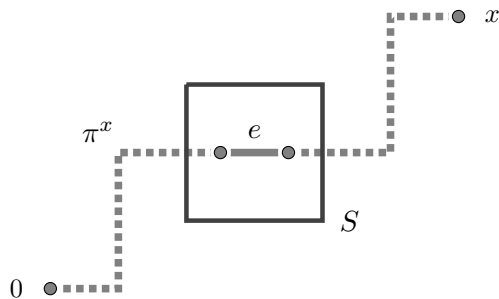

FIGURE 3.1. If the geodesic π^x goes through the edge e and $\tau_e \geq M$, then there must exist some edge e' in the shell S with $\tau_{e'} \geq \frac{M}{\# \text{ of edges in } S}$. Otherwise, the geodesic can take a path on the shell S instead of going through e .

For $e = (a, b) \in \mathcal{E}^d$, define $v_e = \arg \min_{x \in \{a, b\}} |x|_1$. For each edge e , v_e is uniquely defined. For $k \geq 1$, define

$$S_k^{e'} = \{z \in \mathbb{Z}^d : |v_e - z|_\infty = k\}, \quad (3.1)$$

$$S_k^e = \{\{x, y\} \in \mathcal{E}^d : x, y \in S_k^{e'}\}. \quad (3.2)$$

We also define $S_0^{e'}$ to be the set containing only the two vertices of e and $S_0^e = \{e\}$. S_k^e can be thought as a shell of radius k around the edge e . Note that any path that goes through e must enter and exit these shells.

For $x, y \in S_k^{e'}$, define the passage time on S_k^e to be

$$T_{S_k^e}(x, y) = \min_{\substack{\gamma: x \rightarrow y \\ \gamma \subset S_k^e}} T(\gamma),$$

where the minimum is taken over the (finitely many) self-avoiding paths γ connecting x to y without exiting S_k^e .

Definition 3.1. For fixed $M > 0$, we say that an edge $e \in \mathcal{E}^d$ is (k, M) -large if for each $h = 0, 1, \dots, k$, there exist $u, v \in S_h^{e'}$ with $T_{S_h^e}(u, v) \geq M$, i.e.

$$\{e \text{ is } (k, M)\text{-large}\} = \bigcap_{h=0}^k \{\exists u, v \in S_h^{e'} : T_{S_h^e}(u, v) \geq M\}.$$

The following lemma shows a simple relation between a large edge weight on the geodesic and its shells. We say a shell $S_k^{e'}$ encloses a vertex x if x is not in the unbounded component of $(S_k^{e'})^c$.

Lemma 3.2. Fix $e \in \mathcal{E}^d$, assume $e \in \pi^x$ and $\tau_e \geq M$. For any k with the property that $S_k^{e'}$ does not enclose 0 or x , the edge e is (k, M) -large.

Proof. Fix $h \in \{1, \dots, k\}$. By the path structure, π^x must both enter and exit S_h^e at least once in order to go from 0 to e to x . Let u be the first vertex of π^x in $S_h^{e'}$ (when traversing π^x from 0 to x) and let v be the last vertex of $S_h^{e'}$. Then the hypotheses that $e \in \pi^x$ and $\tau_e \geq M$ imply that $T_{S_h^e}(u, v) \geq M$. \square

Next, we give an estimate for $\mathbb{P}(e \text{ is } (k, M)\text{-large})$.

Lemma 3.3. Fix $M > 0$ and $k \in \mathbb{N}$. There exist constants $C_{16} > 0$ and $C_{17} \geq 1$, depending only on k and d so that for $e \in \mathcal{E}^d$

$$\mathbb{P}(e \text{ is } (k, M)\text{-large}) \leq C_{16} \left(\mathbb{P}(\tau_e \geq M/C_{17})^k \right)^{d-1}$$

Proof. Fix $h \in \{1, \dots, k\}$ and $u, v \in S_h^{e'}$. There is a deterministic way of picking $d-1$ vertex self-avoiding paths which only use edges in S_h^e , which begin at u , and which end at v . Enumerate these paths as $\{\gamma_i^h\}_{i=1}^{d-1}$. Then there is a constant $C_{18} = C_{18}(k, d) \geq 1$ so that for each $i \in \{1, \dots, d-1\}$ and each $h \in \{0, \dots, k\}$,

$$\mathbb{P} \left(\sum_{e \in \gamma_i^h} \tau_e \geq M \right) \leq |\gamma_i^h| \mathbb{P}(\tau_e \geq M/|\gamma_i^h|) \leq C_{18} \mathbb{P}(\tau_e \geq M/C_{18}), \quad (3.3)$$

The inclusion

$$\{T_{S_h^e}(u, v) \geq M\} \subset \bigcap_{i=1}^{d-1} \left\{ \sum_{e \in \gamma_i^h} \tau_e \geq M \right\}$$

and counting over all possible pairs of distinct points in $S_h^{e'}$, combined with a union bound, gives

$$\mathbb{P}(\exists u, v \in S_h^{e'} : T_{S_h^e}(u, v) \geq M) \leq C_{18}^{d-1} (10h)^{(10d)} \mathbb{P}(\tau_e \geq M/C_{18})^{d-1}. \quad (3.4)$$

Using the independence of edges in different shells, we find

$$\begin{aligned} \mathbb{P}(e \text{ is } (k, M)\text{-large}) &= \prod_{h=1}^k \mathbb{P}(\exists u, v \in S_h^{e'} : \mathbb{T}_{S_h^e}(u, v) \geq M) \\ &\leq C_{18}^{dk} (10k)^{10kd} \mathbb{P}(\tau_e \geq M/C_{18})^{k(d-1)}. \end{aligned} \quad (3.5)$$

We are now ready to prove Theorem 2.3.

Proof of Theorem 2.3. Set $C_1 = C_{17} \geq 1$. Without loss of generality, we restrict to considering M with $\mathbb{P}(\tau_e \geq M/C_{17}) > 0$. Let π^k denote the truncated geodesic obtained by removing the first and last $(2k)^d$ edges from $\pi \in \Pi^x$. For any $n \in \mathbb{N}$ with $n > 2(2k)^d$ we have,

$$\sup_{|x|_1 \geq n} \max_{\pi \in \Pi^x} \nu^\pi[M, \infty) \leq \sup_{|x|_1 \geq n} \max_{\pi \in \Pi^x} \frac{\#\{e \in \pi^k : \tau_e \geq M\}}{|\pi|} + \frac{2(2k)^d}{n}.$$

Set $X_e = \mathbb{1}_{\{e \text{ is } (k, M)\text{-large}\}}$ and define

$$N_j = \sup_{\gamma \in \Xi_j} \sum_{e \in \gamma} X_e,$$

where Ξ_j denotes the set of vertex self-avoiding lattice paths with j edges which start at 0. By Lemma 3.2, with $p = \mathbb{P}(e \text{ is } (k, M)\text{-large})$, we have for each $n \geq 2(2k)^d$,

$$\sup_{|x|_1 \geq n} \max_{\pi \in \Pi^x} \frac{\#\{e \in \pi^k : \tau_e \geq M\}}{|\pi|} \leq \sup_{j \geq n} \frac{N_j}{j}.$$

Take $n_1 \in \mathbb{N}$ sufficiently large that

$$n_1 = n_1(p) \geq \lceil p^{-2/d} \rceil \vee \left(\frac{1}{2(2k)^d} \mathbb{P}(\tau_e \geq M/C_{17})^{-k(1-1/d)} \right) \vee 2(2k)^d,$$

so that for $n \geq n_1$, we have

$$\sup_{|x|_1 \geq n} \max_{\pi \in \Pi^x} \nu^\pi[M, \infty) \leq \mathbb{P}(\tau_e \geq M/C_{17})^{k(1-1/d)} + \sup_{j \geq n} \frac{N_j}{j}.$$

Both claims now follow immediately from Lemma B.1, parts (ii) and (iii). \square

4. LOWER BOUND FOR THE UPPER TAIL

We begin by proving Proposition 4.1 below using a van den Berg–Kesten modification argument which is partially inspired by a construction in Section 3 of [16].

Proposition 4.1. *Suppose (2.1) holds. Fix $\gamma, L > 1$ with $L \in \mathbb{N}$. There exist constants $K_1, M_2, C_{19}, \epsilon > 0$ such that for all $M \geq M_2$, $K \geq K_1$, and $x \in \mathbb{Z}^d$ with $|x|_1 \geq \gamma^{2(L+1)} K^2 M^2$*

$$\begin{aligned} &\mathbb{E}[\#\{e \in \pi^x : \tau_e \geq M\}] \\ &\geq \frac{C_{19}}{M} \mu[r, r+c]^{C_{19}M} \left[\mu[M, \gamma M]^{C_{19}} \mu[M, \infty)^{C_{19}M} \right] \vee \left[\sum_{i=0}^L \gamma^{-i} \mu[\gamma^i M, \gamma^{i+1} M]^{C_{19}\gamma^i M} \right] |x|_1. \end{aligned} \quad (4.1)$$

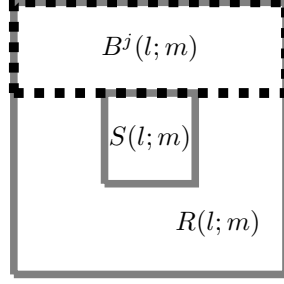

FIGURE 4.1. The three type of boxes, illustrated in \mathbb{Z}^2 . $B^j(l; m)$ is one of the four boxes which surround $S(l; m)$. In this picture, $j = 2$, which corresponds to the vector $e_2 \in \{\pm e_1, \pm e_2\}$.

We next define the boxes on which we will modify our weights, mostly following the notation in [17]. Fix $l = (l_1, \dots, l_d) \in \mathbb{Z}^d$ and define

$$S(l; m) = \{v \in \mathbb{Z}^d : ml_i \leq v_i < m(l_i + 1), 1 \leq i \leq d\}, \quad (4.2)$$

$$R(l; m) = \{v \in \mathbb{Z}^d : m(l_i - 1) \leq v_i < m(l_i + 2), 1 \leq i \leq d\}. \quad (4.3)$$

The collection $\{S(l; m) : l \in \mathbb{Z}^d\}$ consists of hypercubes which form a partition of \mathbb{Z}^d . $R(l; m)$ is an enlarged version of $S(l; m)$, with side length $3m$. For $j \in \{\pm 1, \dots, \pm d\}$, we define

$$B^j(l; m) = R(l; m) \cap R(l + 2\text{sgn}(j)e_{|j|}; m). \quad (4.4)$$

These are the hyper-rectangles inside $R(l; m)$ that surround $S(l; m)$. They are boxes of size $3m \times \dots \times 3m \times m \times 3m \times \dots \times 3m$, where the position of m is determined by the index j . The three kinds of boxes are illustrated in Figure 4.1 in the case $d = 2$.

The size of our boxes will be variable throughout our arguments, so we now introduce the parameters which tune these sizes. For $M > 0, K > 1$, and $s \in (0, 1)$, we set

$$m = m(K, M) = \lfloor KM \rfloor, \quad m_1 = m_1(K, M, s) = \lfloor sKM \rfloor. \quad (4.5)$$

We fix a constant $\rho \geq 1$, the value of which is specified in Proposition 4.7 below. Assume that $s \in (0, 1/\rho)$ and note that $B^j(l; m)$ has a lexicographically minimal vertex v at its lower-left corner. There exists an index k so that $B^j(l; m)$ is the unique hyper-rectangle in \mathbb{Z}^d with the property that the line segments $[v, v + 3me_i]$ for $i \neq k$ and $[v, v + me_k]$ in \mathbb{R}^d are faces of the convex hull of $B^j(l; m)$. For this value of k , $\check{B}^j(l; m; \rho)$ is the unique hyper-rectangle in \mathbb{Z}^d with the property that for $i \neq k$ the line segments

$$\left[v + \rho m_1 \sum_{j=1}^d e_j, v + \rho m_1 \sum_{j=1}^d e_j + (3m - 2\rho m_1)e_i \right] \text{ and}$$

$$\left[v + \rho m_1 \sum_{j=1}^d e_j, v + \rho m_1 \sum_{j=1}^d e_j + (m - 2\rho m_1)e_k \right]$$

in \mathbb{R}^d are faces of the convex hull of $\check{B}^j(l; m; \rho)$. $\check{B}^j(l; m; -\rho)$ is defined similarly, with ρ replaced by $-\rho$ in the expressions above. For all large m , $\check{B}^j(l; m; \rho)$ is contained inside $B^j(l; m)$ and $B^j(l; m; -\rho)$ contains $B^j(l; m)$.

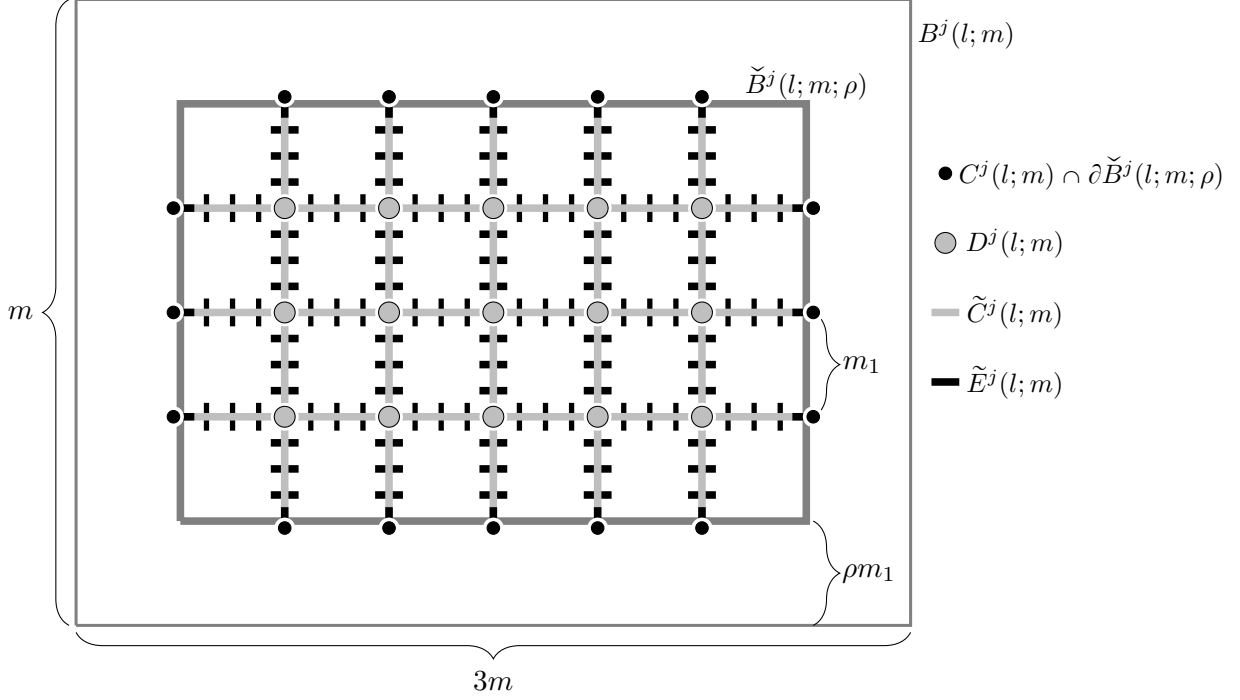

FIGURE 4.2. The sets $B^j(l; m)$, $C^j(l; m)$, $D^j(l; m)$, $\check{C}^j(l; m)$, $\check{E}^j(l; m)$, and $\check{B}^j(l; m; \rho)$ when $s < 1/\rho$, for M sufficiently large in dimension 2.

Next, we define sets of vertices and edges inside $\check{B}^j(l; m; \rho)$. We suppress the notation ρ in some of these definitions, and some of these collections are illustrated in Figure 4.2. The boundary of $\check{B}^j(l; m; \rho)$ is defined to be

$$\partial \check{B}^j(l; m; \rho) = \{v \in \check{B}^j(l; m; \rho) : \exists w \notin \check{B}^j(l; m; \rho) \text{ and } |v - w|_1 = 1\}. \quad (4.6)$$

We define two more collections of vertices

$$\begin{aligned} D^j(l; m) &= \{v \in \check{B}^j(l; m; \rho) \cap m_1 \mathbb{Z}^d : d_\infty(v, \check{B}^j(l; m; \rho)^c) > m_1\}, \\ C^j(l; m) &= \{v + ke_i \in \check{B}^j(l; m; \rho) : v \in D^j(l; m), k \in \mathbb{Z}, i \in \{1, \dots, d\}\}, \end{aligned}$$

as well as two collections of edges:

$$\check{C}^j(l; m) = \{\{v, w\} : v, w \in C^j(l; m) \text{ and } |v - w|_1 = 1\}, \quad (4.7)$$

$$\check{E}^j(l; m) = \{\{v, w\} : v \in C^j(l; m), w \notin C^j(l; m) \setminus \partial \check{B}^j(l; m; \rho), |v - w|_1 = 1\}. \quad (4.8)$$

In words, $D^j(l; m)$ defines an equally spaced sublattice of vertices which is contained inside of $\check{B}^j(l; m; \rho)$ and separated from the complement of $\check{B}^j(l; m; \rho)$. The set $C^j(l; m)$ then extends axes in each of the coordinate directions e_i , $i = 1, 2, \dots, d$, out from each of the sites in the sublattice $D^j(l; m)$. The collection $\check{C}^j(l; m)$ are the edges which connect nearest-neighbor sites in $C^j(l; m)$. The collection $\check{E}^j(l; m)$ consists of all edges which are adjacent to sites in $C^j(l; m)$ but which do not lie in $\check{C}^j(l; m)$.

We note that because m_1/m is approximately equal to s , there exists $C_{20} > 0$ such that

$$\begin{aligned} |\tilde{E}^j(l; m)|, |\tilde{C}^j(l; m)| &\leq C_{20}m, \\ |C^j(l; m) \cap \partial B^j(l; m)| &\leq C_{20}. \end{aligned} \quad (4.9)$$

We next introduce a coloring scheme on the m -boxes $B^j(l; m)$. Boxes colored black will be those on which we may modify edge weights. In order to state that definition, it will be helpful to introduce one of our main tools, which will be the following result about oriented (edge) FPP in two dimensions.

Proposition 4.2. *There exists a constant $C_{21} = C_{21}(\mu)$ such that*

$$\lim_{n \rightarrow \infty} \mathbb{P}(\exists \text{ an oriented path } \gamma \text{ from } (0, 0) \text{ to } (n, n) : T(\gamma) \leq C_{21}n) = 1. \quad (4.10)$$

In Proposition 4.2, an oriented path is a path with edge increments in the set $\{e_1, e_2\}$. Let C_{22} be a deterministic constant satisfying $C_{22} > C_{21}$ and

$$\mathbb{P}(\tau_e \leq C_{22}) > \max \left\{ p_c(d), \bar{p}_c(2), 1 - 3^{-(d+(d+1)7^d)} \right\}. \quad (4.11)$$

The last condition comes from equation (2.20) in [12], and is needed in order to apply Lemma 2.24 from that manuscript. We will set

$$\begin{aligned} C_{23} &= [13(1609 + (104)^{d-1}) + 10]\rho d C_{22} \text{ and} \\ C_{24} &= 13[1609 + (104)^{d-1}] + 10, \end{aligned}$$

where ρ is the constant from the Antal–Pisztora large deviation bound for the chemical distance in supercritical bond percolation [1], which we record as Proposition 4.7 below. We also recall [17, Lemma 5.5].

Lemma 4.3. [17, Lemma 5.5] *Under (2.1), there exist $\delta_1 > 0$ and $C_{25} > 0$ such that for any $x, y \in \mathbb{Z}^d$,*

$$\mathbb{P}(T(x, y) < (r + \delta_1)|x - y|_1) \leq e^{-C_{25}|x - y|_1}. \quad (4.12)$$

With these definitions in hand, we next give the condition on an m -box which will allow us to modify geodesics.

Definition 4.4. An m -box $B^j(l; m)$ is m_1 -black if the following two conditions hold:

(B1) For any $v, w \in B^j(l; m)$ with $|v - w|_1 \geq m$, we have

$$T(v, w) \geq (r + \delta_1)|v - w|_1, \quad (4.13)$$

where δ_1 is the constant in Lemma 4.3.

(B2) There exists a “good barrier” G for $\partial B^j(l; m)$. A “good barrier” for $\partial B^j(l; m)$ is a (random) collection of vertices contained inside the annulus

$$A^j(l; m) = \check{B}^j(l; m; -\rho) \setminus \check{B}^j(l; m; \rho)$$

satisfying the following properties. (i) Any path originating at a site $v \in \partial B^j(l; m)$ with diameter strictly greater than $m_1/10000$ must cross a vertex in the barrier. (ii) Starting from any point on the barrier, there exists a path to $C^j(l; m) \cap \partial \check{B}^j(l; m; \rho)$ which remains inside of $A^j(l; m)$ (except at the endpoints) with passage time $\leq C_{23}m_1$ and length $\leq C_{24}m_1$.

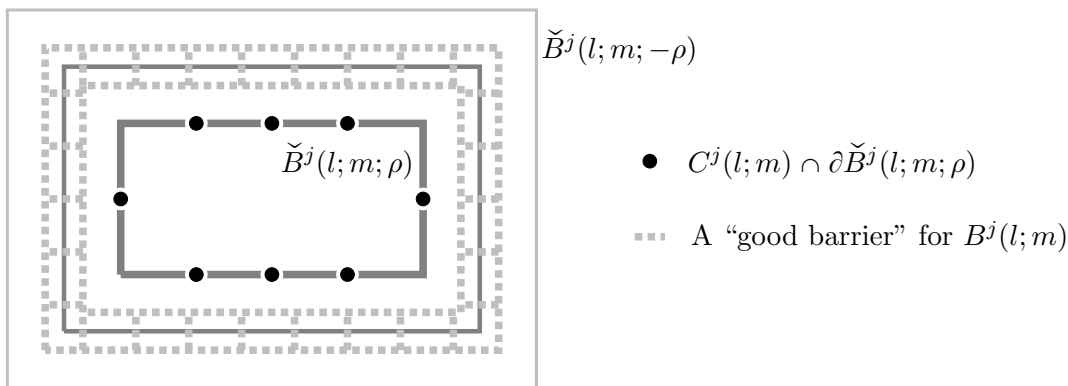

FIGURE 4.3. An illustration of a “good barrier” as in definition (B2).

For m and m_1 as in (4.5) and whenever there is no danger of confusion, we omit the m_1 in the statement and say that $B^j(l; m)$ is black or not black. An m -cube $S(l; m)$ is said to be black if all of its surrounding m -boxes are black.

Proposition 4.5.

$$\lim_{m \rightarrow \infty} \mathbb{P}(B^j(l; m) \text{ is black}) = 1. \quad (4.14)$$

Turning to our tool, Proposition 4.2, we appeal to a few classical results for oriented planar Bernoulli (bond) percolation from [8]. We will follow the notation of [8] for these arguments in order to simplify the comparison to that paper. To unify our notation with the notation of that paper, we rotate our picture by 45° counter-clockwise and work on

$$\mathbb{L} = \{(m, n) \in \mathbb{Z}^2 : m + n \text{ is even}, n \geq 0\}.$$

Starting from the point (m, n) , a directed edge will go to either $(m + 1, n + 1)$ or $(m - 1, n + 1)$. In this new notation, we would like to show that

$$\lim_{n \rightarrow \infty} \mathbb{P}(\exists \text{ oriented path } \gamma \text{ between } (0, 0) \text{ and } (0, 2n) \text{ such that } T(\gamma) \leq C_{21} 2n) = 1. \quad (4.15)$$

Proof of Proposition 4.2. Define an edge to be open if $\tau_e \leq C_{21}$ where C_{21} is chosen so that the probability of being open is $\mu[0, C_{21}] > \vec{p}_c(2)$.

We will fix a sequence $\{k(n)\}_n$ with the property that $k(n) \rightarrow \infty$, at a rate slower than n . This rate will be specified shortly. For each fixed n , we color the vertices $S_{1,n} = \{(i, k(n)) : -k(n) \leq i \leq k(n)\}$ and $S_{2,n} = \{(i, 2n - k(n)) : -k(n) \leq i \leq k(n)\}$ dark gray. See Figure 4.4.

Our goal is to create an oriented path γ from $(0, 0)$ to $(0, 2n)$ which satisfies $T(\gamma) \leq C_{22} 2n$. This is done in two steps: the first step is to connect the vertices $(0, 0)$ and $(0, 2n)$ with the dark gray segments, and the second step is to connect the two dark gray segments.

Step 1: The passage time of any directed path from $(0, 0)$ to the gray segment must be no larger than the sum of all the edge weights inside the triangle formed by the vertex and gray segment, i.e. all of the directed edges connecting vertices in $\{(i, j) : 0 \leq i \leq k(n), -i \leq j \leq i\}$. There are fewer than $k(n)^2$ many edges inside this triangle. Write $q(n) = k(n)^2$ and let $X_i \stackrel{i.i.d.}{\sim} \mu$. We will choose $k(n)$ so that $k(n) \rightarrow \infty$ and

$$\lim_{n \rightarrow \infty} \mathbb{P}\left(\sum_{i=1}^{q(n)} X_i \leq C_{21} n\right) = 1. \quad (4.16)$$

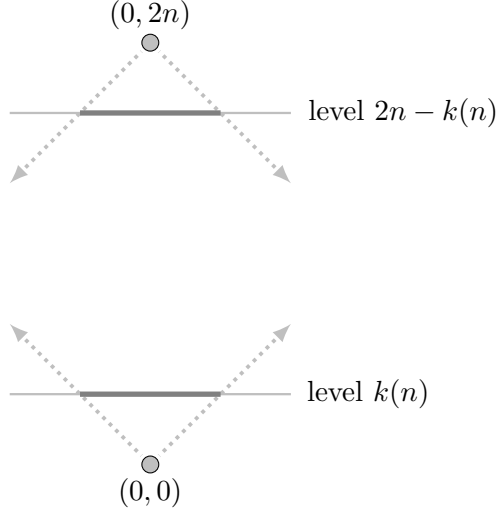

FIGURE 4.4. Setup for the proof of Proposition 4.2. Here $\{k(n)\}$ is a sequence going to infinity much slower than n . Note the number of integer points on the two dark gray segments grows to infinity as $n \rightarrow \infty$.

We have

$$\mathbb{P} \left(\sum_{i=1}^{q(n)} X_i \leq C_{21}n \right) \geq \mathbb{P} \left(\max_{1 \leq i \leq q(n)} X_i \leq \frac{C_{21}n}{q(n)} \right) = \mathbb{P} \left(X_1 \leq \frac{C_{21}n}{q(n)} \right)^{q(n)}. \quad (4.17)$$

Set

$$f(q) = \min \left\{ k \in \mathbb{Z}_+ : \mu \left[C_{21} \frac{k}{q}, \infty \right) \leq \frac{1}{q^2} \right\} + \lceil e^q \rceil. \quad (4.18)$$

The second term in equation (4.18) ensures both $f(q) \rightarrow \infty$ as $q \rightarrow \infty$ and $f(q) > f(q-1)$. Define $q(n) = \min\{q : f(q) \geq n\}$ and $k(n) = \sqrt{q(n)}$. By construction, we have $q(n) \rightarrow \infty$ as $n \rightarrow \infty$, while the second term in (4.18) ensures that $q(n) \leq \ln(n)$. Moreover, we have $f(q(n)) \geq n$ and therefore, using the first term in (4.18) in (4.17),

$$\begin{aligned} \mathbb{P} \left(X_1 \leq \frac{C_{21}n}{q(n)} \right)^{q(n)} &= \left(1 - \mu \left[\frac{C_{21}n}{q(n)}, \infty \right) \right)^{q(n)} \\ &\geq \left(1 - \mu \left[\frac{C_{21}f(q(n))}{q(n)}, \infty \right) \right)^{q(n)} \geq \left(1 - \frac{1}{q(n)^2} \right)^{q(n)} \rightarrow 1. \end{aligned}$$

Step 2: We say that a directed path is open if all of its edges are open. We will use oriented percolation to show that with probability tending to one as $n \rightarrow \infty$, there exists an open directed path between the two dark gray segments.

On the event that $(0,0)$ lies in an infinite open cluster, we denote the x -coordinates of the rightmost and leftmost reachable points in this open cluster at level i by $r_i^{\{0\}}$ and $l_i^{\{0\}}$ respectively. By [8, Eq. (7)], on this event, almost surely, the rightmost and leftmost reachable

points in the infinite cluster will satisfy the following two limits for some constant $\alpha \in (0, 1]$:

$$r_i^{\{0\}}/i \rightarrow \alpha, \quad l_i^{\{0\}}/i \rightarrow -\alpha \quad \text{as } i \rightarrow \infty. \quad (4.19)$$

This means the infinite cluster reaches out to both sides of the vertical line $x = 0$ on a linear scale with respect to the levels.

Next, we focus on the bottom gray line. Define the event

$$E_n = \{\exists \text{ a point in the bottom gray segment, } S_{1,n}, \text{ which touches an infinite open cluster}\}.$$

Since the number of integer points on the dark gray segment goes to infinity as $n \rightarrow \infty$, by [8, Sec. 10], $\mathbb{P}(E_n) \rightarrow 1$. On the event E_n , we show that the infinite cluster also reaches out to both sides of the vertical line $x = 0$ in a linear scale with respect to the levels.

To simplify the notation, we shift the weights so the bottom gray segment lies on level 0 and is centered at $(0, 0)$. For $A \subseteq \mathbb{R}$, define r_n^A to be the x -coordinate of the rightmost reachable point at level n by any open path starting at any point $(y, 0)$ with $y \in A$. On the (shift of the) event E_n , almost surely,

$$r_n^{(-\infty, -k(n))} \leq r_n^{[-k(n), k(n)]}. \quad (4.20)$$

Also note that by shift invariance, we have

$$\mathbb{P}\left(r_n^{(-\infty, -k(n))} \leq \alpha n/5\right) = \mathbb{P}\left(r_n^{(-\infty, 0]} \leq \alpha n/5 + k(n)\right) \rightarrow 0 \text{ as } n \rightarrow \infty \quad (4.21)$$

where the limit follows from the fact that $r_n^{(-\infty, 0]}/n \rightarrow \alpha$ as $n \rightarrow \infty$ almost surely. See [8, Eq. (5)].

(4.20), (4.21), and the properties of $k(n)$ then imply that

$$\mathbb{P}\left(E_n \cap \{r_n^{[-k(n), k(n)]} \geq \alpha n/10 \geq k(n)\}\right) \rightarrow 1 \text{ as } n \rightarrow \infty.$$

This means that with probability tending to one, the parts of the infinite cluster which intersect $S_{1,n}$ will reach far to the right of the upper gray segment $S_{2,n}$ as $n \rightarrow \infty$.

From left-right symmetry of the model, we see that

$$\mathbb{P}\left(E_n \cap \{r_n^{[-k(n), k(n)]} \geq \alpha n/10 \geq k(n)\} \cap \{l_n^{[-k(n), k(n)]} \leq -\alpha n/10 \leq -k(n)\}\right) \rightarrow 1. \quad (4.22)$$

Therefore, in the limit as $n \rightarrow \infty$, with probability tending to one, there exist semi-infinite paths of open directed edges which extend from the bottom gray segment $S_{1,n}$ and to the left and right of the top gray segment. Call the event in (4.22) G_n^{bottom} . The same argument with the picture rotated by 180° shows that from the top gray line, with open paths directed downward, the same result holds on an event of probability tending to one as $n \rightarrow \infty$. Call this event G_n^{top} . Then $\mathbb{P}(G_n^{\text{bottom}} \cap G_n^{\text{top}}) \rightarrow 1$. Therefore, when the two clusters intersect, there exists a directed open path γ between the two gray segments, provided that we reverse the orientation of the edges emanating from $S_{2,n}$. By the definition of an edge being open, the passage time along this path satisfies

$$T(\gamma) \leq 2C_{21}n. \quad (4.23)$$

We have therefore shown that

$$\lim_{n \rightarrow \infty} \mathbb{P}(\exists \text{ an oriented path } \gamma \text{ from } (0, 0) \text{ to } (0, 2n) \text{ such that } T(\gamma) \leq 4C_{22}n) = 1. \quad \square$$

Next, we give a generalization of the above proposition by relaxing the end point (n, n) . Define $B_k(n, n) = \{v \in \mathbb{Z}^2 : |v - (n, n)|_1 \leq k\}$.

Lemma 4.6. *There exists a constant C_{26} such that for any fixed $k \in \mathbb{N}$,*

$$\lim_{n \rightarrow \infty} \mathbb{P}(\forall v \in B_k(n, n), \exists \text{ an oriented path } \gamma \text{ between } 0 \text{ and } v \text{ and } T(\gamma) \leq C_{26}n) = 1. \quad (4.24)$$

Proof. Define $C_{26} = 2C_{21}$ where C_{21} is the constant from Proposition 4.2. Note that

$$\begin{aligned} & \mathbb{P}(\forall v \in B_k(n, n), \exists \text{ an oriented path } \gamma \text{ between } 0 \text{ and } v \text{ and } T(\gamma) \leq C_{26}n) \\ & \geq \mathbb{P}\left(\left\{\exists \text{ an oriented path } \gamma \text{ between } (0, 0) \text{ and } (n, n) \text{ such that } T(\gamma) \leq C_{21}n\right\}\right. \\ & \quad \left. \cap \left\{\sum_{e \subset B_k(n, n)} \tau_e \leq C_{21}n\right\}\right). \end{aligned}$$

The probability of the first term in the intersection goes to 1 by Proposition 4.2. The probability of the second term goes to 1 because the number of terms in the sum is bounded, and the edge weights are finite almost surely. \square

Turning toward the proof of Proposition 4.5, our initial goal will be to construct a random surface that consists entirely of edges with uniformly bounded weights. We then connect this surface to the collection of points on $C^j(l; m) \cap \check{B}^j(l; m; \rho)$ with paths that have passage times on the order of m_1 . Our main tools in this construction will be a coupling with Bernoulli bond percolation and Lemma 4.6.

We begin with a few preliminary points. Recall the constant C_{22} defined in (4.11). For $e \in \mathcal{E}^d$, define

$$\omega_e = \begin{cases} 1 & \text{if } \tau_e \leq C_{22} \\ 0 & \text{if } \tau_e > C_{22} \end{cases}. \quad (4.25)$$

Define an equivalence relation between sites $u, v \in \mathbb{Z}^d$ by $u \leftrightarrow v$ if and only if there is a path from u to v consisting of nearest-neighbor edges e with $\omega_e = 1$.

The chemical distance $d_C(u, v)$ is defined to be the minimum length of such a path, with $d_C(u, v) = \infty$ if no path from u to v with all edges having $\omega_e = 1$ exists. Given a vertex set $A \subset \mathbb{Z}^d$ and two points $u, v \in A$, the restricted chemical distance $d_{C,A}(u, v)$ is the minimum length of a path from u to v with edges which have at least one vertex in A and which satisfy $\omega_e = 1$.

The following result is a consequence of Theorems 1.1 and 1.2 and Corollary 1.3 of [1].

Proposition 4.7. *There is a constant $\rho \in [1, \infty) \cap \mathbb{N}$ such that*

(1)

$$\overline{\lim}_{|y|_1 \rightarrow \infty} \frac{1}{|y|_1} \log \mathbb{P}(0 \leftrightarrow y, d_C(0, y) > \rho|y|) < 0.$$

(2) For any $y \in \mathbb{Z}^d$,

$$\overline{\lim}_{\ell \rightarrow \infty} \frac{1}{\ell} \log \mathbb{P}(0 \leftrightarrow y, d_C(0, y) > \ell) < 0.$$

(3) \mathbb{P} -almost surely,

$$\limsup_{|y|_1 \rightarrow \infty} \frac{1}{|y|_1} d_C(0, y) \mathbb{1}_{\{0 \leftrightarrow y\}} \leq \rho.$$

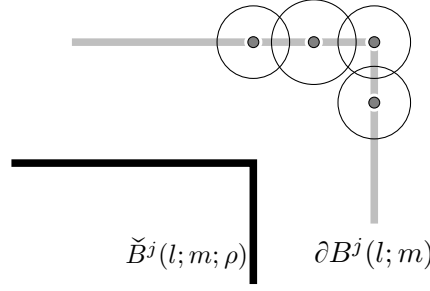

FIGURE 4.5. The barrier G is constructed from shells $S(v)$ (shown as circles) around each point $x \in \mathbb{Z}^d$ for which there exists $v \in \partial B^j(l; m)$ with $|x - v|_\infty \leq 1$.

Proof of Proposition 4.5. For the first part of the claim, we observe that using a union bound and Lemma 4.3, we have

$$\mathbb{P}(B^j(l; m) \text{ fails condition (B1)}) \leq (3m)^{2d} e^{-C_{25} m/10000} \xrightarrow{m \rightarrow \infty} 0. \quad (4.26)$$

To prove that (B2) holds, we will construct a good barrier using a “shells argument,” following the ideas and notation of Lemma 2.24 in [12]. See also Lemma 6.3 in [2] for a similar argument. Define a graph \mathcal{L} with the same vertex set as \mathbb{Z}^d , but with edges between vertices u and v which satisfy $|v - u|_\infty = 1$. If A is an \mathcal{L} -connected set of vertices, we define the *black cluster* of A on \mathcal{L} , denoted by $C(A, b)$, to be the union of A and the collection of vertices $v \in \mathcal{L}$ for which there exists a path in \mathcal{L} from v to a site in A , where all of the edges in the path have $\omega_e = 0$ and all of vertices along the path except the last vertex do not lie in A . Similarly, for an \mathcal{L} -connected set of vertices A , the *white cluster* of A , denoted $C(A, w)$, is the union of A and the collection of vertices v for which there exists a path from v to a site in A , where all of the edges in the path have $\omega_e = 1$ and all of vertices along the path except the last vertex do not lie in A . We will write $C(v, b)$ instead of $C(\{v\}, b)$ and $C(v, w)$ instead of $C(\{v\}, w)$ when A is a singleton. By definition, we always have $A \subset C(A, b)$ and $A \subset C(A, w)$.

Define the rectangle

$$D_k(v) = [v(1) - k, v(1) + k] \times \cdots \times [v(d) - k, v(d) + k].$$

Let $n(v)$ be the minimal k for which there exists a vertex $u \in D_k(v)$ with the property that $C(u, w)$ is an infinite subset of \mathbb{Z}^d . Such a u exists by our hypothesis that $\mathbb{P}(\tau_e \leq C_{22}) \geq p_c(d)$.

Given an \mathcal{L} -connected set A , the exterior boundary of A is defined by

$$\partial_{\text{ext}} A := \left\{ v \notin A: \begin{array}{l} v \text{ is adjacent to } A \text{ in } \mathcal{L} \text{ and there exists a path on } \mathbb{Z}^d \\ \text{from } v \text{ to } \infty \text{ which is disjoint from } A \end{array} \right\}.$$

Denote by

$$S(v) = \partial_{\text{ext}} C(D_{n(v)}(v), b).$$

Lemma 2.24 in [12] shows that $C(D_{n(v)}(v), b)$ is almost surely finite and connected. By equation (2.22) of [12], all of the vertices in $S(v)$ are white. Lemma 2.23 of [12] shows that $S(v)$ is an \mathcal{L} -connected set and separates v from infinity, i.e. any semi-infinite path originating at v crosses at least one vertex in $S(v)$. Moreover, Lemma 2.24 of [12] also gives constants $C_{27}, C_{28} > 0$ so that

$$\mathbb{P}(n(v) > k) \leq C_{27}(k+1)3^{-k}, \quad \mathbb{P}(\text{diam}(S(v)) > k) \leq C_{28}(k+3)^{d-1}3^{-k/4}.$$

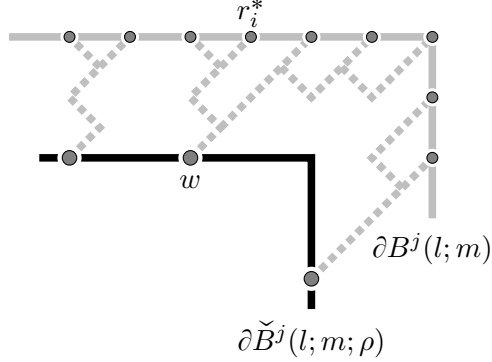

FIGURE 4.6. Points in $C^j(l; m) \cap \partial B^j(l; m)$ are connected to $\{r_1^*, \dots, r_T^*\}$ which are sites adjacent to $\{r_1, \dots, r_T\}$.

In the previous expression, $\text{diam}(A) = \max\{|x - y|_1 : x, y \in A\}$.

Call E_1 the event where $\text{diam}(S(x)) < m_1/10000$ for all $x \in \mathbb{Z}^d$ for which there exists $v \in \partial B^j(l; m)$ with $|x - v|_\infty \leq 1$. Note that as $m \rightarrow \infty$ $\mathbb{P}(E_1) \rightarrow 1$.

On E_1 , define

$$G = \bigcup_{\substack{x: \exists v \in \partial B^j(l; m): \\ |v - x|_\infty \leq 1}} S(x). \quad (4.27)$$

We claim that on E_1 , any path originating from a site $v \in \partial B^j(l; m)$ with diameter strictly more than $m_1/10000$ must cross a vertex in G . Since $\text{diam}(S(v)) < m_1/10000$ for all $v \in \partial B^j(l; m)$, any path which starts at a site $v \in \partial B^j(l; m)$ with diameter strictly greater than $m_1/10000$ must end outside of $S(v)$. Any such path must intersect $S(v)$ because $S(v)$ separates v from infinity. This holds because we can extend such a path to a semi-infinite path which adds no additional crossings of $S(v)$. Note also that the fact that $\text{diam}(S(v)) < m_1/10000$ for each v implies that $G \subset \check{B}^j(l; m; -\rho) \setminus \check{B}^j(l; m; \rho)$.

The closure of $\check{B}^j(l; m; \rho)$ in \mathbb{R}^d is an intersection of finitely many half spaces which are parallel to the coordinate axes. For any $w \in \partial \check{B}^j(l; m; \rho)$, there exists at least one such a half space which contains w on its boundary. Take the lexicographically minimal such half space, ordered by which coordinate axis the half space is parallel to, and denote the union of the complement and boundary of this half-space by H_w .

Since the size of $B^j(l; m)$ is of order m , there exist a non-random constant T (depending only on s and d) and non-random points $r_1, r_2, \dots, r_T \in \partial B^j(l; m)$ so that for each $v \in \partial B^j(l; m)$, there exists $r(v) \in \{r_1, r_2, \dots, r_T\}$ with

$$m_1/500 \leq |v - r(v)|_1 \leq m_1/100. \quad (4.28)$$

Now, for each $i \in \{1, \dots, T\}$, there exists at least one site on $\partial \check{B}^j(l; m; \rho)$ which is within ℓ^1 distance at most $2\rho dm_1$ of r_i . Any such site is within ℓ^1 distance $9dm_1$ of some $w \in C^j(l; m) \cap \partial \check{B}^j(l; m; \rho)$ for which $r_i \in H_w$. Denote this site, choosing the lexicographically minimal such site if there are several, by $w_i = w(r_i)$. We then have $|r_i - w_i|_1 \leq 12\rho dm_1$ and $r_i \in H_{w_i}$. For each $r_i \in \{r_1, \dots, r_T\}$, we denote by $r_i^* = r^*(r_i)$ the new point obtained from r_i by adding one to each of the coordinates of r_i for which $(w_i - r_i) \cdot e_k$ is odd. Then $r_i^* \in H_{w_i}$

and, by construction, we have

$$m_1 - d \leq |w - r_i^*|_1 \leq 13\rho dm_1.$$

For each $i \in \{1, \dots, T\}$, applying Lemma A.6, we may connect r_i^* with w_i using at most $1609 + (104)^{d-1}$ concatenated directed paths with length between $13\rho dm_1/100$ and $13\rho dm_1/10$ which remain inside of H_{w_i} and never exit the annulus $A^j(l; m)$. This is illustrated in Figure 4.6. Here, saying that a path is directed means the path has exactly two admissible steps, one being an element of $\{e_j, -e_j\}$ and the other being an element of $\{e_k, -e_k\}$, where $j \neq k$. Applying Proposition 4.2 to the endpoints constructed in Lemma A.6, with probability tending to one as $m \rightarrow \infty$, we may choose the paths in such a way that the passage time of each path is less than $13\rho dC_{21}m_1$. Note that the diameter of this concatenation of paths is greater than $m_1/10000$ and so this concatenation of paths must first intersect $S(r_i^*)$ at some point, which we denote by $q_i = q(r_i^*)$.

Our final claim is that with probability tending to one, every $u \in G$ is connected to some $q_i \in \{q_1, \dots, q_T\}$ using a path which has passage time bounded from above by $d\rho C_{22}m_1$ and which remains inside of $A^j(l; m)$. If we show this, then we are done, as we can then concatenate this path to the path segment from w_i to q_i that we just constructed and bound the passage time on this segment by the total passage time from w_i to r_i^* .

Fix any $u \in G$. We must have $u \in S(x)$ for some x which satisfies $|v - x|_\infty \leq 1$ for some $v = v(u) \in \partial B^j(l; m)$. In both choices, take the lexicographically minimal vertex if there are multiple options. For each such v , there exists $r = r(v(u)) \in \{r_1, \dots, r_T\}$ as described just above (4.28). Denote by $r' = r'(u) = r^*(r(v(u)))$ and $q' = q'(u) = q(r^*(r(v(u))))$. We have

$$m_1/500 - d \leq |v - r'|_1 \leq m_1/100 + d.$$

On E_1 , the diameters of $S(x)$ and $S(r')$ are both less than $m_1/10000$. Therefore,

$$|u - v|_1 \leq m_1/10000 + d, \quad |q' - r'|_1 \leq m_1/10000.$$

These combine to imply that for all m sufficiently large,

$$m_1/1000 - 2d \leq |q' - u|_1 \leq m_1/50 + 2d. \quad (4.29)$$

Note that $S(r')$ and $S(x)$ are both \mathcal{L} -connected collections of white edges which touch the infinite cluster of white edges. Therefore, we have $u \leftrightarrow q'$. Further, we have the following inequalities:

$$d_1(u, \partial B^j(l; m)) \leq m_1/10000, \quad d_1(q'_i, \partial B^j(l; m)) \leq m_1/10000, \quad (4.30)$$

where d_1 is the distance in the ℓ^1 norm. We have

$$\mathbb{1}_{\{u \leftrightarrow q' \text{ and } d_{C, A^j(l; m)}(u, q') \geq \rho m_1/10\}} = \mathbb{1}_{\{u \leftrightarrow q' \text{ and } d_C(u, q') \geq \rho m_1/10\}} \quad \text{a.s.} \quad (4.31)$$

This is because in order for the shortest path consisting of edges with $\omega_e = 1$ from u to q' in the environment to exist and exit the annulus $A^j(m; l)$, $d_C(u, q')$ must be within $m_1/10000$ of the ℓ^1 distance in \mathbb{Z}^d between $\partial \tilde{B}^j(l; m)$ and the boundary of the annulus, which is at least ρm_1 , i.e. $d_C(u, q') \geq \rho m_1 - m_1/10000$. From [1, Theorem 1.1], the expectation of the right hand side above decays exponentially:

$$\mathbb{P}(u \leftrightarrow q' \text{ and } d_C(u, q') \geq \rho m_1/10) \leq e^{-C_{29}m_1}.$$

Call E_2^c the event where a pair of points which satisfy (4.29) and (4.30) also satisfy the condition in (4.31). A union bound shows that E_2^c has exponentially decaying probability. On the event, E_2 , each pair of points which satisfy (4.29) and (4.30) and which are connected

by a path consisting of edges which all satisfy $\omega_e = 1$ are connected by such a path which remains inside of $A^j(l; m)$.

Collecting the above results, on $E_1 \cap E_2$, we have shown that G separates $\partial B^j(l; m)$ and that for any $u \in G$, there exists a path to some $w \in C^j(l; m) \cap \partial \tilde{B}^j(l; m; \mu)$ which remains inside of $A^j(l; m)$ and which has passage time at most $[13(1609 + (104)^{d-1}) + 10]\rho d C_{22} m_1 = C_{23} m_1$. \square

The following lemma is a Peierls argument similar to [17, Lemma 5.2].

Lemma 4.8. *For each $\delta_2 \in (0, 1)$, there exist a constant $C_{30} = C_{30}(\delta_2) > 0$ and an index $n_7 = n_7(\delta_2)$ such that for any $m \geq n_7$, any $x \in \mathbb{Z}^d$ with $|x|_1 \geq m^2$, and any $\delta \leq \delta_2$,*

$$\mathbb{P} \left(\pi^x \text{ visits at most } \delta \frac{|x|_1}{m} \text{ distinct black } m\text{-cubes} \right) \leq 2 \exp \left(-C_{30} \frac{|x|_1^{\frac{1}{d}}}{m} \right).$$

Proof. Fix δ_2 as in the statement. By Lemma A.1, we may work on the event where $|\pi^x| \leq C_{36}|x|_1$, where C_{36} is the fixed non-random constant in that lemma, since

$$\mathbb{P} (|\pi^x| > C_{36}|x|_1) \leq e^{-C_{37}|x|_1^{1/d}}$$

where $C_{37} > 0$ is also as in that lemma.

Each m steps in a nearest-neighbor path can visit at most 2^d many distinct m -cubes. Then the total number of possible box configurations of these cubes that can be visited by any path of length m is bounded by 2^{2^d} . Thus the total number of configurations of m -cubes that can be visited by any path from 0 to x with length less than or equal to $C_{36}|x|_1$ is then bounded by $(2^{2^d})^{C_{36} \lceil \frac{|x|_1}{m} \rceil}$.

Fix a deterministic path γ from the origin to x of length less than or equal to $C_{36}|x|_1$. Such a path must visit at least $\lfloor \frac{|x|_1}{m} \rfloor$ many distinct m -cubes, $B^j(l; m)$. Our next goal is to control the probability that a small fraction of these cubes are colored black. To do this, we will use Proposition A.5, which requires that these events be k -dependent. It is clear from the definition of black that there is a dimension-dependent constant $k_d \in \mathbb{N}$ so that for any event in the set $\{\{B^j(l; m) \text{ is not black}\} : l \in \mathbb{Z}^d, j = \pm 1, \dots, \pm d\}$, there are only at most k_d many other such events which are not independent of it.

From (4.14) and the definition of black, for any fixed $\eta \in (0, 1)$, there exists an index $n_8 = n_8(\eta)$ such that for all $m \geq n_8$, each $l \in \mathbb{Z}^d$ and $j \in \{\pm 1, \dots, \pm d\}$,

$$\mathbb{P}(B^j(l; m) \text{ is black}) \geq 1 - \eta.$$

With the notation $\varphi(y) = (1 + y) \log(1 + y) - y$ for $y > -1$, we consider η sufficiently small that

$$\eta < \frac{1 - \delta_2}{2} \quad \text{and} \quad \log \left(2^{2^{C_{36} d}} \right) - \frac{\varphi \left(\frac{(1 - \delta_2)/2 - \eta}{5\eta} \right)}{(k_d + 1)(1 - \eta)} < 0$$

and let $n_7 = n_8(\eta)$ for this η .

Enumerate the indicator functions of the events in $\{\{B^j(l; m) \text{ is not black}\} : l \in \mathbb{Z}^d, j = \pm 1, \dots, \pm d\}$ which correspond to boxes intersecting γ as $\{X_i : i \leq T\}$, where $T \leq \lceil |x|_1/m \rceil$.

Call $t = \lceil (1 - \delta) \frac{|x|_1/m}{\lfloor |x|_1/m \rfloor} - \eta \rceil$. We may apply Proposition A.5 whenever $\delta/2 + \eta < 1/2$ to obtain

$$\begin{aligned} \mathbb{P} \left(\gamma \text{ visits at most } \delta \left\lfloor \frac{|x|_1}{m} \right\rfloor \text{ distinct black } m\text{-cubes} \right) &\leq \mathbb{P} \left(\sum_{i=1}^T X_i - \lfloor x_1/m \rfloor \eta > t \lfloor |x|_1/m \rfloor \right) \\ &\leq \exp \left\{ -\frac{\lfloor |x|_1/m \rfloor}{(k_d + 1)(1 - \eta)} \varphi(4t/5\eta) \right\} \leq \exp \left\{ -\frac{\varphi \left(\frac{(1-\delta)/2 - \eta}{5\eta} \right)}{(k_d + 1)(1 - \eta)} \right\}^{\lfloor |x|_1/m \rfloor}. \end{aligned}$$

A union bound over all possible configurations of m -boxes that π^x can intersect with positive probability on the event where $|\pi^x| \leq C_{36}|x|_1$ implies that

$$\begin{aligned} &\mathbb{P} \left(|\pi^x| \leq C_{36}|x|_1 \text{ and } \pi^x \text{ visits at most } \delta \left\lfloor \frac{|x|_1}{m} \right\rfloor \text{ distinct black } m\text{-cubes} \right) \\ &\leq \left(2^{2^d} \right)^{C_{36} \frac{|x|_1}{m}} \exp \left\{ -\frac{\varphi \left(\frac{(1-\delta)/2 - \eta}{5\eta} \right)}{(k_d + 1)(1 - \eta)} \right\}^{\lfloor |x|_1/m \rfloor} \\ &\leq \exp \{ -C_{31}|x|_1/m \}, \end{aligned} \tag{4.32}$$

for some constant $C_{31} = C_{31}(\delta_2)$. We conclude that

$$\mathbb{P} \left(\pi^x \text{ visits at most } \delta \frac{|x|_1}{m} \text{ distinct black } m\text{-cubes} \right) \leq 2 \exp \{ -C_{32} \min(|x|_1^{1/d}, |x|_1/m) \},$$

for a constant $C_{32} = C_{32}(\delta_2) > 0$. \square

Any path which starts inside of $S(l; m)$ and ends outside of $R(l; m)$, must have a segment which lies entirely in one of the surrounding m -boxes $B^j(l; m)$ and which connects two of the large faces of that box. Graphically, this means that in the natural sense, the path crosses the box in the ‘‘short direction.’’ In what follows, when we say that a path crosses an m -box $B^j(l; m)$, we will always mean that it crosses in this sense (i.e. in the ‘‘short direction’’). Using the Markov inequality and Lemma 4.8 with $\delta_2 = 1/10$, we immediately obtain the following lemma.

Lemma 4.9. *There exists an index $n_9 \in \mathbb{N}$ so that for all $m \geq n_9$ and all $x \in \mathbb{Z}^d$ with $|x|_1 \geq m^2$,*

$$\mathbb{E} [\#\{\text{distinct black } B^j(l; m) \text{ such that } \pi^x \text{ crosses } B^j(l; m)\}] \geq \frac{1}{20} \frac{|x|_1}{m}. \tag{4.33}$$

We will modify the the weights inside of one of the m -boxes $B^j(l; m)$ which the geodesic crosses in order to force the geodesic to take a large weight. To that end, we introduce the following notions of ‘‘goodness’’.

Definition 4.10. For $x \in \mathbb{Z}^d$ and $0 < L \leq M$, an m -box $B^j(l; m)$ is said to be

- (x, M) -good if there exists $e \in \pi^x$ such that both vertices of e are in $B^j(l; m)$ and $\tau_e \geq M$.
- (x, L, M) -good if there exists $e \in \pi^x$ such that both vertices of e are in $B^j(l; m)$ and $L \leq \tau_e \leq M$.

Recall the set $\tilde{E}^j(l; m)$ which was defined in (4.8). We split this set into two disjoint subsets:

$$\begin{aligned}\tilde{E}_1^j(l; m) &= \{e \in \tilde{E}^j(l; m) : e \text{ touches } \partial\check{B}^j(l; m; \rho)\}, \\ \tilde{E}_2^j(l; m) &= \tilde{E}^j(l; m) \setminus \tilde{E}_1^j(l; m).\end{aligned}$$

Definition 4.11. For $j \in \{\pm 1, \dots, \pm d\}$, $l \in \mathbb{Z}^d$, $m \in \mathbb{N}$, and $c, \gamma, M > 0$, a configuration $\tau = \{\tau_e\}_{e \in \mathcal{E}^d}$ satisfies condition $Q^j(l; m; c; \gamma; M)$, denoted $\tau \in Q^j(l; m; c; \gamma; M)$ or $\tau \in Q$ when there is no danger of confusion, if

$$\begin{cases} M \leq \tau_e \leq \gamma M & \text{if } e \in \tilde{E}_1^j(l; m), \\ M \leq \tau_e & \text{if } e \in \tilde{E}_2^j(l; m), \\ \tau_e \leq r + c & \text{if } e \in \tilde{C}_1^j(l; m) \setminus \tilde{E}^j(l; m). \end{cases} \quad (4.34)$$

Similarly, for $i \in \mathbb{N}$, we say that a configuration τ satisfies condition $\tilde{Q}^j(l; m; c; \gamma; M, i)$, denoted $\tau \in \tilde{Q}$ when there is no danger of confusion, if

$$\begin{cases} \gamma^i M \leq \tau_e < \gamma^{i+1} M & \text{where } e \in \tilde{E}_1^j(l; m) \cup \tilde{E}_2^j(l; m), \\ \tau_e \leq r + c & \text{where } e \in \tilde{C}_1^j(l; m) \setminus \tilde{E}^j(l; m). \end{cases} \quad (4.35)$$

For fixed $j \in \{\pm 1, \dots, \pm d\}$, $l \in \mathbb{Z}^d$, $m \in \mathbb{N}$, we define a resampling operator denoted with a superscript $*$: $\tau^* = \{\tau_e^*\}_{e \in \mathcal{E}^d}$ where

$$\begin{cases} \tau_e^* = \tau_e & \text{if } e \in \mathcal{E}^d \setminus (\tilde{C}^j(l; m) \cup \tilde{E}^j(l; m)), \\ \tau_e^* \text{ is an i.i.d. copy of } \tau_e & \text{if } e \in \tilde{C}^j(l; m) \cup \tilde{E}^j(l; m). \end{cases}$$

Whenever we apply the resampling operator, we will abuse notation and assume that we always work on the enlarged the probability space which contains both configurations.

Proposition 4.12. Fix $\gamma > 1$ and $L \in \mathbb{N}$. There exist $M_3, K_2, s_1, c_1 > 0$ so that for $M \geq M_3, K \geq K_2$, $s \leq s_1$ and $c \leq c_1$, whenever $x \in \mathbb{Z}^d$ satisfies $|x|_1 \geq M^2$, and j, l, m are such that $0 \notin B^j(l; m)$ and $x \notin B^j(l; m)$,

$$\begin{aligned}\mathbb{P}(B^j(l; m) \text{ is } (x, M)\text{-good in } \tau) &= \mathbb{P}(B^j(l; m) \text{ is } (x, M)\text{-good in } \tau^*) \\ &\geq \mathbb{P}(\tau^* \in Q, B^j(l; m) \text{ is black in } \tau, \pi^x \text{ crosses } B^j(l; m) \text{ in } \tau),\end{aligned}$$

where $Q = Q(l; m; c; \gamma; M)$. Moreover, with $\tilde{m} = \lfloor K\gamma^i M \rfloor$ and $\tilde{m}_1 = \lfloor sK\gamma^i M \rfloor$, for all $i \leq L$,

$$\begin{aligned}\mathbb{P}(B^j(l; \tilde{m}) \text{ is } (x, \gamma^i M, \gamma^{i+1} M)\text{-good in } \tau) &= \mathbb{P}(B^j(l; \tilde{m}) \text{ is } (x, \gamma^i M, \gamma^{i+1} M)\text{-good in } \tau^*) \\ &\geq \mathbb{P}(\tau^* \in \tilde{Q}, B^j(l; \tilde{m}) \text{ is } \tilde{m}_1\text{-black in } \tau, \pi^x \text{ crosses } B^j(l; \tilde{m}) \text{ in } \tau),\end{aligned}$$

where $\tilde{Q} = \tilde{Q}(l; \tilde{m}; c; \gamma; M; i)$.

Proof. In both claims, the first equality is clear. For the inequalities, we will show that under the events in the two last probabilities, $B^j(l; m)$ is (x, M) -good in τ^* and $(x, \gamma^i M, \gamma^{i+1} M)$ -good in τ^* , respectively. Notationally, we think of the conditions $\tau^* \in Q$ and $\tau^* \in \tilde{Q}$ modifications of τ . In these modified environments, our strategy will be to construct a path from π^x , π^* , which has passage time strictly smaller than that of π^x in τ . The existence of such a path forces $\pi^{x,*}$, the geodesic from 0 to x in the environment τ^* , to use the modified weights. Any path which uses modified weights must contain at least one edge in $\tilde{E}^j(l; m)$, from which the claims follow by construction. Our path modification is illustrated in Figure 4.7.

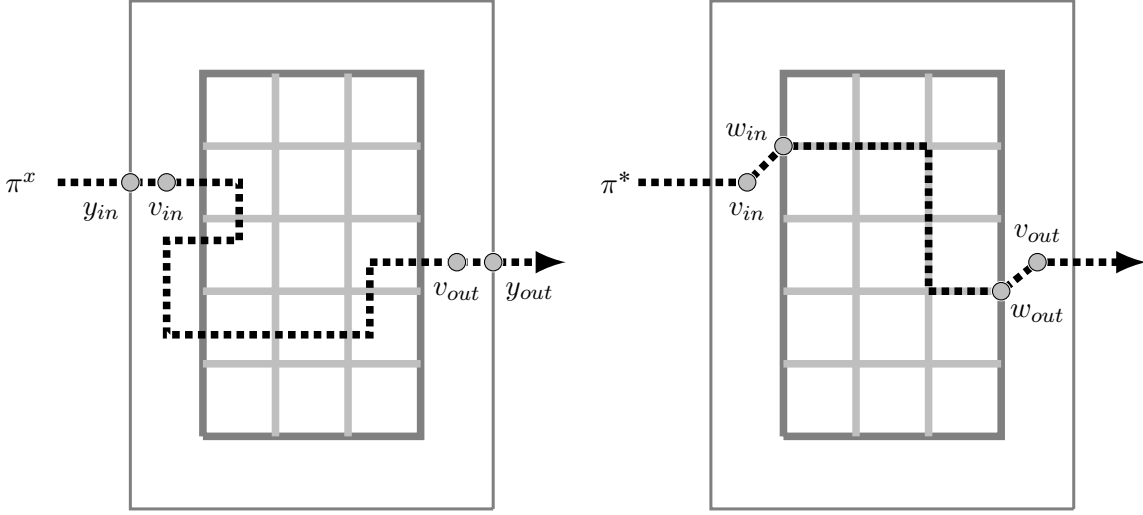
FIGURE 4.7. Modifying π^x to obtain the new path π^* .

Working on $\{\tau^* \in Q, B^j(l; m) \text{ is black in } \tau, \pi^x \text{ crosses } B^j(l; m) \text{ in } \tau\}$ first, the condition that π^x crosses $B^j(l; m)$ means that it touches two points y_{in} and y_{out} which lie on opposite faces of $B^j(l; m)$ and the segment of π^x between y_{in} and y_{out} stays inside $B^j(l; m)$. By (B2), there exists a pair of points v_{in} and v_{out} with the following properties:

- $v_{in}, v_{out} \in G$, where G is the good barrier for $B^j(l; m)$ as in (B2).
- $|v_{in} - y_{in}|_1 \leq m_1/10000$, $|v_{in} - y_{in}|_1 \leq m_1/10000$.
- v_{in} and v_{out} lie on the segment of π^x between y_{in} and y_{out} .

Furthermore, we obtain two vertices w_{in} and w_{out} in $C^j(l; m) \cap \partial \tilde{B}^j(l; m)$ and two paths $\pi_{v_{in} \rightarrow w_{in}}, \pi_{w_{out} \rightarrow v_{out}}$ (which may not be geodesics) such that

$$\mathbb{T}(\pi_{v_{in} \rightarrow w_{in}}) \vee \mathbb{T}(\pi_{w_{out} \rightarrow v_{out}}) \leq C_{23} m_1 \quad \text{and} \quad |v_{in} - w_{in}|_1 \vee |v_{out} - w_{out}|_1 \leq C_{24} m_1.$$

Let $\pi_{w_{in} \rightarrow w_{out}}$ be any path which only uses edges in $\tilde{C}^j(l; m)$, which has endpoints w_{in} and w_{out} , such that the first and last steps are in $\tilde{E}_1^j(l; m)$, and which satisfies $|\pi_{w_{in} \rightarrow w_{out}}| = |w_{in} - w_{out}|_1$.

The new path π^* is constructed as follows. It agrees with π^x until it first reaches v_{in} and after it last exits v_{out} . Replace the entire segment of π^x between those two points by concatenating the paths $\pi_{v_{in} \rightarrow w_{in}}, \pi_{w_{in} \rightarrow w_{out}}$ and $\pi_{w_{out} \rightarrow v_{out}}$ constructed above, in that order. Denote by $\pi_{v_{in}, v_{out}}^{(x)}$ the segment of π^x between v_{in} and v_{out} and use similar notation for π^* . We have

$$\begin{aligned} \text{[by (B1)]} \quad & \sum_{e \in \pi_{v_{in}, v_{out}}^{(x)}} \tau_e \geq (r + \delta_1) |v_{in} - v_{out}|_1, \\ \text{[by (B2) and (4.34)]} \quad & \sum_{e \in \pi_{v_{in}, v_{out}}^*} \tau_e^* \leq 2C_{23} m_1 + 2\gamma M + (r + c) |w_{in} - w_{out}|_1 \\ & \leq 2C_{23} m_1 + 2\gamma M + (r + c) (|v_{in} - v_{out}|_1 + 2C_{24} m_1). \end{aligned}$$

Recall $m = \lfloor KM \rfloor$, $m_1 = \lfloor sKM \rfloor$, and $|v_{in} - v_{out}|_1 \geq m - m_1/5000$. So

$$\begin{aligned} & T(0, x) - T^*(\pi^*) \\ & \geq (\delta_1 - c)|v_{in} - v_{out}|_1 - (2(r+c)C_{24} + 2C_{23})m_1 - 2\gamma M \\ & \geq (\delta_1 - c)(m - m_1/5000) - (2(r+c)C_{24} + 2C_{23})m_1 - 2\gamma M. \end{aligned}$$

If we divide by M and send M to infinity, the final term in this bound will converge to

$$K[(\delta_1 - c)(1 - s/5000) - (2(r+c)C_{24} + 2C_{23})s] - 2\gamma.$$

Therefore, if we choose $c \leq \delta_1/2$ and $s \leq \delta_1/[16(r+\delta_1/2)C_{24} + 16C_{23}]$ and then $K \geq 32\gamma/\delta_1$, and if we note that $1 - s/5000 > 1/2$ for all $s \in (0, 1)$, we see that for all M sufficiently large, on the event $\{\tau^* \in Q, B^j(l; m)$ is black in τ, π^x crosses $B^j(l; m)$ in $\tau\}$, we have

$$T(0, x) - T^*(\pi^*) \geq \gamma M.$$

It follows that $T(0, x) - T^*(0, x) \geq \gamma M$.

The other case is essentially identical, but the modification takes place on larger boxes. Working under the event $\{\tau^* \in \tilde{Q}, B^j(l; \tilde{m})$ is \tilde{m}_1 -black in τ, π^x crosses $B^j(l; \tilde{m})$ in $\tau\}$, the argument through the construction of π^* is identical after replacing every instance of m with $\tilde{m} = \lfloor K\gamma^i M \rfloor$ and every instance of m_1 with $\tilde{m}_1 = \lfloor sK\gamma^i M \rfloor$. As above, we have

$$\begin{aligned} & \text{[by (B1)]} \quad \sum_{e \in \pi_{v_{in}, v_{out}}^{(x)}} \tau_e \geq (r + \delta_1)|v_{in} - v_{out}|_1, \\ & \text{[by (B2) and (4.35)]} \quad \sum_{e \in \pi_{v_{in}, v_{out}}^*} \tau_e^* \leq 2C_{23}\tilde{m}_1 + 2\gamma^{i+1}M + (r+c)|w_{in} - w_{out}|_1 \\ & \leq 2C_{23}\tilde{m}_1 + 2\gamma^{i+1}M + (r+c)(|v_{in} - v_{out}|_1 + 2C_{24}\tilde{m}_1). \end{aligned}$$

We now have $|v_{in} - v_{out}|_1 \geq \tilde{m} - \tilde{m}_1/5000$. Then

$$T(0, x) - T^*(\pi^*) \geq (\delta_1 - c)(\tilde{m} - \tilde{m}_1/5000) - (2(r+c)C_{24} + 2C_{23})\tilde{m}_1 - 2\gamma^{i+1}M.$$

Once again, if we choose $c \leq \delta_1/2$ and $s \leq \delta_1/[16(r+\delta_1/2)C_{24} + 16C_{23}]$ and then $K \geq 32\gamma/\delta_1$, we obtain $T(0, x) - T^*(\pi^*) > 0$.

In either case, this means $\pi^{x,*}$ must use edge weights on $\tilde{C}^j(l; m)$ (resp. $\tilde{C}^j(l; \tilde{m})$) or $\tilde{E}^j(l; m)$ (resp. $\tilde{E}^j(l; \tilde{m})$) because all other edge weights are the same in τ and τ^* . In order to access weights on $\tilde{C}^j(l; m)$ (resp. $\tilde{C}^j(l; \tilde{m})$), however, $\pi^{x,*}$ would have to cross an edge in $\tilde{E}^j(l; m)$ (resp. $\tilde{E}^j(l; \tilde{m})$), from which the result follows. \square

With Proposition 4.12 in hand, we can now turn to the proofs of Proposition 4.1 and Theorem 2.5.

Proof of Proposition 4.1. We break the proof into two parts, corresponding to the first and second terms in the maximum in equation (4.1). With γ and L as in the statement of Proposition 4.12, fix $K = K_2$ and $s = s_1$, where these are the constants in the statement of Proposition 4.12. Assume that $M \geq M_3$ and $c \leq c_1$ also as in the statement of that proposition. We assume further that M is sufficiently large that $m = \lfloor MK_2 \rfloor$ satisfies the hypotheses of Lemma 4.9. Using (4.34) and counting the number of edges modified, there is

a constant $C_{33} = C_{33}(s, d)$, which depend only on s and d , so that

$$\mathbb{P}(\tau^* \in Q) \geq \mu[M, \gamma M]^{C_{33}} \mu[M, \infty)^{C_{33}M} \mu[r, r+c]^{C_{33}M} \text{ and} \quad (4.36)$$

$$\mathbb{P}(\tau^* \in \tilde{Q}) \geq \mu[\gamma^i M, \gamma^{i+1} M]^{C_{33}} \mu[r, r+c]^{C_{33}M}, \quad (4.37)$$

where $Q = Q(l; m; c; \gamma; M)$ and $\tilde{Q} = \tilde{Q}(l; \tilde{m}; c; \gamma; M; i)$. Recalling that $m = \lfloor KM \rfloor$,

$$\begin{aligned} & \mathbb{E}[\#\{e \in \pi^x : \tau_e \geq M\}] \\ & \geq \frac{1}{2d} \sum_{l \in \mathbb{Z}^d} \mathbb{P}(B^j(l; m) \text{ is } (x, M)\text{-good}) \\ \text{[Proposition 4.12]} & \geq \frac{1}{2d} \sum_{l \in \mathbb{Z}^d} \mathbb{P}(\tau^* \in Q, B^j(l; m) \text{ is black in } \tau, \pi^x \text{ crosses } B^j(l; m) \text{ in } \tau) \\ & = \frac{1}{2d} \sum_{l \in \mathbb{Z}^d} \mathbb{P}(\tau^* \in Q) \mathbb{P}(B^j(l; m) \text{ is black, } \pi^x \text{ crosses } B^j(l; m)) \\ \text{[(4.36)]} & \geq \frac{1}{2d} \mu[M, \gamma M]^{C_{33}} \mu[M, \infty)^{C_{33}M} \mu[r, r+c]^{C_{33}M} \times \\ & \quad \mathbb{E} \left[\#\{\text{distinct black } B^j(l; m) \text{ crossed by } \pi^x \text{ in } \tau\} \right] \\ \text{[(4.33)]} & \geq \mu[M, \gamma M]^{C_{33}} \mu[M, \infty)^{C_{33}M} \mu[r, r+c]^{C_{33}M} \frac{1}{40d} \frac{|x|_1}{K_2 M}. \end{aligned}$$

Identical steps with Q replaced by \tilde{Q} and m replaced by \tilde{m} give

$$\mathbb{E}[\#\{e \in \pi^x : \tau_e \in [\gamma^i M, \gamma^{i+1} M)\}] \geq \mu[\gamma^i M, \gamma^{i+1} M]^{C_{33}} \mu[r, r+c]^{C_{33}M} \frac{|x|_1}{40d K_2 \gamma^i M}.$$

Summing over $i = 1, 2, \dots, L$ completes the proof. \square

The proof of Theorem 2.5 is essentially identical to that of Proposition 4.1.

Proof of Theorem 2.5. Let C_{36} be the constant in Lemma A.1. Fix $K = K_2$ and $s = s_1$, where these are the constants in the statement of Proposition 4.12. We begin with the observation that

$$\begin{aligned} \mathbb{E}[\nu^{(x)}[M, \infty)] & \geq \mathbb{E}[\nu^{(x)}[M, \infty) \mathbb{1}_{\{|\pi^x| \leq C_{36}|x|_1\}}] \\ & \geq \mathbb{E} \left[\frac{1}{C_{36}|x|_1} \#\{e \in \pi^x : \tau_e \geq M\} \mathbb{1}_{\{|\pi^x| \leq C_{36}|x|_1\}} \right]. \end{aligned} \quad (4.38)$$

Combining Lemma A.1 and Lemma 4.8, there exist a constant $C_{34} > 0$ and $n_{10} \in \mathbb{N}$ so that for all $m \geq n_{10}$ and all $x \in \mathbb{Z}^d$ with $|x|_1 \geq m^2$,

$$\mathbb{P} \left(|\pi^x| > C_{36}|x|_1 \text{ or } \pi^x \text{ visits at most } \frac{|x|_1}{10m} \text{ distinct black } m\text{-cubes} \right) \leq e^{-C_{34}|x|_1^{1/d}/m}.$$

It follows that there is n_{11} so that for $m \geq n_{11}$ and x with $|x|_1 \geq m^2$,

$$\mathbb{E} \left[\#\{\text{distinct black } B^j(l; m) \text{ such that } \pi^x \text{ crosses } B^j(l; m)\} \mathbb{1}_{\{|\pi^x| \leq C_{36}|x|_1\}} \right] \geq \frac{1}{20} \frac{|x|_1}{m}.$$

Arguing as in the proof of Proposition 4.1, we find that

$$\begin{aligned} & \mathbb{E}[\#\{e \in \pi^x : \tau_e \geq M\} \mathbb{1}_{\{|\pi^x| \leq C_{36}|x|_1\}}] \\ & \geq \frac{1}{2d} \mathbb{P}(\tau \in Q) \left[\sum_{l \in \mathbb{Z}^d} \mathbb{P}(B^j(l; m) \text{ is black in } \tau, \pi^x \text{ crosses } B^j(l; m), |\pi^x| \leq C_{36}|x|_1) \right] \\ & \geq \frac{|x|_1}{40dK_0M} \mu[r, r+c]^{C_{33}M} \mu[M, \gamma M]^{C_{33}} \mu[M, \infty)^{C_{33}M}. \end{aligned}$$

Similarly,

$$\begin{aligned} & \mathbb{E}[\#\{e \in \pi^x : \gamma^i M \leq \tau < \gamma^{i+1} M\} \mathbb{1}_{\{|\pi^x| \leq C_{36}|x|_1\}}] \\ & \geq \frac{1}{2d} \mathbb{P}(\tau \in \tilde{Q}) \left[\sum_{l \in \mathbb{Z}^d} \mathbb{P}(B^j(l; \tilde{m}) \text{ is black in } \tau, \pi^x \text{ crosses } B^j(l; \tilde{m}), |\pi^x| \leq C_{36}|x|_1) \right] \\ & \geq \frac{|x|_1}{40dK_0M\gamma^i} \mu[r, r+c]^{C_{33}M} \mu[\gamma^i M, \gamma^{i+1} M]^{C_{33}} \gamma^i M. \end{aligned}$$

Fix $M_1 \geq M_2$ such that

$$\frac{1}{M_1} \geq \mu[r, r+c]^{C_{33}M_1} \geq \mu[M_1, \infty)^{C_{33}M_1}.$$

The first claimed result follows by summing over $i = 1, 2, \dots, L$. The second claim follows from observing that this bound is valid with constants which do not depend on L for all $x \in \mathbb{Z}^d$ with $|x|_1$ sufficiently large, depending on L . Considering the liminf as $|x|_1 \rightarrow \infty$, the bound becomes valid for any L . \square

5. UPPER BOUNDS FOR GENERAL EVENTS

Proof of Theorem 2.6. Set $X_e = \mathbb{1}_{\{\tau_e \in B\}}$ and notice that these random variables are independent as e varies. Define

$$N_j = \max_{\gamma \in \Xi_j} \left\{ \sum_{e \in \gamma} X_e \right\},$$

where Ξ_j denotes the set of vertex self-avoiding lattice paths with j edges which start at 0. For each $n \in \mathbb{N}$, we have

$$\sup_{|x|_1 \geq n} \max_{\pi \in \Pi^x} \nu^{(x)}(B) \leq \sup_{j \geq n} \frac{N_j}{j}$$

The claims now follow from Lemma B.1 (ii) and (iii) with $n_2 = \lceil \mu(B)^{-2/d} \rceil$. \square

Theorem 2.6 also has an analogue in terms of edge counting which will be useful in what follows.

Lemma 5.1. *Suppose (2.1) holds. There exists a constant $C_{35} = C_{35}(d, \mu)$ such that for any Borel set $B \subset \mathbb{R}$ with $\mu(B) > 0$, there exists an index $n_{12} = n_{12}(\mu, B)$ such that for any $|x|_1 \geq n_{12}$*

$$\mathbb{E}[\#\{e \in \pi^x : \tau_e \in B\}] \leq C_{35} \mu(B)^{\frac{1}{d}} |x|_1. \quad (5.1)$$

The proof of this lemma is similar to the proof of Theorem 2.6. We start by rewriting the expectation as

$$\begin{aligned} \mathbb{E} [\#\{e \in \pi^x : \tau_e \in B\}] &\leq \mathbb{E} \left[\#\{e \in \pi^x : \tau_e \in B\} \mathbb{1}_{\{\forall x: |x|_1 \geq n_{12}, |\pi^x| \leq C_{36}|x|_1\}} \right] \\ &\quad + \mathbb{E} \left[|\pi^x| \mathbb{1}_{\{\forall x: |x|_1 > n_{12}, |\pi^x| > C_{36}|x|_1\}} \right]. \end{aligned}$$

The first term is bounded by a greedy lattice path comparison using Lemma B.1 (i). By Lemma A.3 (ii), we may choose $n_{12} \in \mathbb{N}$ such that the second term is bounded by $\mu(B)^{1/d}|x|_1$.

6. LOWER TAIL EXPONENTS

Proposition 6.1. *For any $\epsilon \geq 0$ and $x \in \mathbb{Z}^d$,*

$$\mathbb{E} [\#\{e \in \pi^x : \tau_e \leq r + \epsilon\}] \geq |x|_1 \mu[r, r + \epsilon].$$

Proof. By Lemma 2.2,

$$\begin{aligned} \mathbb{E} [\#\{e \in \pi^x : \tau_e \leq r + \epsilon\}] &= \sum_{e \in \mathcal{E}^d} \mathbb{P}(e \in \pi^x, \tau_e \leq r + \epsilon) \geq \sum_{e \in \mathcal{E}^d} \mathbb{P}(\tau_e \leq r + \epsilon) \mathbb{P}(e \in \pi^x) \\ &= \mu[r, r + \epsilon] \mathbb{E}[|\pi^x|] \geq |x|_1 \mu[r, r + \epsilon]. \quad \square \end{aligned}$$

Next, we prove the lower bound in Theorem 2.7.

Proof of Theorem 2.7. Without loss of generality, we only consider $\epsilon = 0$ if $\mu\{r\} > 0$. First, observe that

$$\mathbb{E} \left[\nu^{(x)}[r, r + \epsilon] \right] \geq \frac{1}{C_{36}|x|_1} \mathbb{E} \left[\#\{e \in \pi^x : \tau_e \leq r + \epsilon\} \mathbb{1}_{\{|\pi^x| \leq C_{36}|x|_1\}} \right].$$

Lemma A.3 (ii) gives constants $C_{41}, C_{42} > 0$ so that

$$\begin{aligned} &\mathbb{E} \left[\#\{e \in \pi^x : \tau_e \leq r + \epsilon\} \mathbb{1}_{\{|\pi^x| \leq C_{36}|x|_1\}} \right] \\ &= \mathbb{E} [\#\{e \in \pi^x : \tau_e \leq r + \epsilon\}] - \mathbb{E} \left[\#\{e \in \pi^x : \tau_e \leq r + \epsilon\} \mathbb{1}_{\{|\pi^x| > C_{36}|x|_1\}} \right] \\ &\geq |x|_1 \mu[r, r + \epsilon] - C_{41} e^{-C_{42}|x|_1^{1/d}}, \end{aligned}$$

where in the second-to-last step, we also applied Proposition 6.1. The result now follows by taking $|x|_1$ sufficiently large that the second term above is less than $|x|_1 \mu[r, r + \epsilon]/2$. \square

We next turn to Proposition 2.8, which gives an example where the exponent $1/d$ in Theorem 2.6 is sharp.

Proof of Proposition 2.8. First, we show that with probability greater than $1/2$, there exists a directed path between 0 and $n(e_1 + e_2 + \dots + e_d)$ which has on the order of $np^{1/d}$ many zeros along its path. Because such a directed path takes the minimal number of steps needed to travel between these two points and the weights are Bernoulli distributed, we know that any geodesic between these two points must collect at least as many zeros as the path we construct.

Recall the notation $S(l; m)$ defined in (4.2) and call $v = e_1 + e_2 + \dots + e_d$. We cover the diagonal line from 0 to nv with boxes of side length $\lceil L/p^{1/d} \rceil$ where L is a large constant which we will choose independent of p , provided that p is bounded uniformly away from 1. Specifically, we fix L sufficiently large that the probability of seeing at least one zero inside the

box $S(v; \lceil L/p^{1/d} \rceil)$ is greater than 0.9 for all $p < 1/2$. This is possible because the probability of seeing no zeros in this box is $(1-p)^{\lceil L/p^{1/d} \rceil}$.

We consider the collection of disjoint boxes $\{S(v; \lceil L/p^{1/d} \rceil k) : k \leq \lfloor n/\lceil L/p^{1/d} \rceil \}$ with L as above. By construction, the probability that at least half of these boxes contain at least one zero is at least $1/2$. On this event, we construct a directed path from 0 to nv passing through each of these boxes inductively according to the following rules. If $k \geq 1$ is the minimal index for which $\lceil L/p^{1/d} \rceil k \geq n$, construct a directed path from $\lceil L/p^{1/d} \rceil (k-1)v$ to nv . If the box $S(v; \lceil L/p^{1/d} \rceil (k-1))$ contains at least one zero, then order the zeros in lexicographic order. Construct a directed path from $\lceil L/p^{1/d} \rceil (k-1)v$ to the first zero in this order, then concatenate a directed path from this site to $\lceil L/p^{1/d} \rceil kv$. Otherwise, construct a directed path from $\lceil L/p^{1/d} \rceil (k-1)v$ to $\lceil L/p^{1/d} \rceil kv$. Since the event on which at least half of the boxes have a zero in them has probability at least $1/2$, we conclude that

$$\frac{1}{4} \lfloor n/\lceil L/p^{1/d} \rceil \rfloor \leq \mathbb{E} \left[\# \left\{ e \in \pi^{(nv)} : t_e = 0 \right\} \right].$$

For n sufficiently large, we can further bound the left hand side from below by $(np^{1/d})/(8L)$, which gives the first part of the statement.

Next, we prove the lower bound for the empirical distribution. We have

$$\begin{aligned} \mathbb{E}[\nu^{(nv)}(\{0\})] &\geq \mathbb{E} \left[\nu^{(nv)}(\{0\}) \mathbb{1}_{\{|\pi^{(nv)}| \leq C_{38} |nv|\}} \right] \\ &\geq \mathbb{E} \left[\frac{1}{C_{38} |nv|} \# \left\{ e \in \pi^{(nv)} : \tau_e = 0 \right\} \mathbb{1}_{\{|\pi^{(nv)}| \leq C_{38} |nv|\}} \right]. \end{aligned}$$

Therefore it suffices to bound the expectation in the last line from below. Provided that $p \leq p_0 < p_c(d)$, using Lemma A.3 (ii), we have

$$\begin{aligned} &\mathbb{E} \left[\# \left\{ e \in \pi^{(nv)} : \tau_e = 0 \right\} \mathbb{1}_{\{|\pi^{(nv)}| \leq C_{36} |nv|\}} \right] \\ &= \mathbb{E} \left[\# \left\{ e \in \pi^{(nv)} : \tau_e = 0 \right\} \right] - \mathbb{E} \left[\# \left\{ e \in \pi^{(nv)} : \tau_e = 0 \right\} \mathbb{1}_{\{|\pi^{(nv)}| > C_{36} |nv|\}} \right] \\ &\geq (np^{1/d})/(8L) - C_{41} e^{-C_{42} (nd)^{1/d}}. \end{aligned}$$

By Remark A.4, the constants C_{41} , C_{42} above only depend on p_0 and d . The result now follows by taking n sufficiently large. \square

Finally, we prove Proposition 2.9.

Proof of Proposition 2.9. Fix $a, b, c \geq 0$ such that $r \leq a < b \leq c$ and $F(b) - F(a) > 0$ (we recall that F is the cumulative distribution function of τ_e). Let $\mathcal{G}_e = \sigma(\tau_{e'} : e \neq e')$. Recall the definition of d_e in the proof of Lemma 2.2. Note that for $h > c$,

$$\begin{aligned} \mathbb{E}[\# \{e \in \pi^x : \tau_e \in (c, h]\}] &= \sum_{e \in \mathcal{E}^d} \mathbb{E}[\mathbb{P}(\tau_e \leq d_e, \tau_e \in (c, h] \mid \mathcal{G}_e)] \\ &= \sum_{e \in \mathcal{E}^d} \mathbb{E}[F(h \wedge d_e) - F(c \wedge d_e)] \\ &= \sum_{e \in \mathcal{E}^d} \mathbb{E}[(F(h \wedge d_e) - F(c \wedge d_e)) \mathbb{1}_{\{d_e > c\}}] \\ &\leq (F(h) - F(c)) \sum_{e \in \mathcal{E}^d} \mathbb{P}(d_e > c) \end{aligned}$$

$$= \frac{F(h) - F(c)}{F(b) - F(a)} \sum_{e \in \mathcal{E}^d} \mathbb{E} [(F(b) - F(a)) \mathbb{1}_{\{d_e > c\}}].$$

On the event $\{d_e > c\}$, we have

$$F(b) - F(a) = F(b \wedge d_e) - F(a \wedge d_e).$$

Therefore,

$$\begin{aligned} \sum_{e \in \mathcal{E}^d} \mathbb{E} [(F(b) - F(a)) \mathbb{1}_{\{d_e > c\}}] &= \sum_{e \in \mathcal{E}^d} \mathbb{E} [(F(b \wedge d_e) - F(a \wedge d_e)) \mathbb{1}_{\{d_e > c\}}] \\ &\leq \sum_{e \in \mathcal{E}^d} \mathbb{E} [(F(b \wedge d_e) - F(a \wedge d_e)) \mathbb{1}_{\{d_e > a\}}] \\ &= \mathbb{E} [\#\{e \in \pi^x : \tau_e \in (a, b)\}]. \end{aligned}$$

The last step comes from reading the argument above in reverse, starting from the third equality, with $(c, h]$ replaced by $(a, b]$. We conclude that

$$\mathbb{E} [\#\{e \in \pi^x : \tau_e \in (c, h]\}] \leq \frac{F(h) - F(c)}{F(b) - F(a)} \mathbb{E} [\#\{e \in \pi^x : \tau_e \in (a, b]\}]$$

Choose $a = r$ and fix $b > r$ such that $\mu(r, b] > 0$. Applying Lemma 5.1 to the expectation on the right gives

$$\mathbb{E} [\#\{e \in \pi^x : \tau_e \in (c, h]\}] \leq (C_{35} \mu(r, b]^{\frac{1}{d}} \mu(r, b]^{-1}) \mu(c, h] |x|_1. \quad \square$$

APPENDIX A. TECHNICAL RESULTS

Geodesic length estimates. Our next result recalls [3, Theorem 4.9], which plays an important role in many of our arguments.

Lemma A.1. *Suppose that (2.1) holds. There are constants $C_{36} > 1, C_{37} > 0$, so that*

$$\mathbb{P} \left(\max_{\pi \in \Pi^x} |\pi| > C_{36} |x|_1 \right) \leq e^{-C_{37} |x|_1^{1/d}}.$$

The dependence of the constants C_{36}, C_{37} on μ may be taken to be uniform over Bernoulli distributed edge weights with $\mathbb{P}(\tau_e = 0) \leq p_0 < p_c(d)$. This is proved in the next lemma.

Lemma A.2. *Fix $p_0 < p_c(d)$. For i.i.d. Bernoulli distributed weights τ_e satisfying $\mathbb{P}(\tau_e = 0) \leq p_0 < p_c(d)$, there are constants $C_{38} = C_{38}(d, p_0) > 1, C_{39} = C_{39}(d, p_0) > 0$ so that*

$$\mathbb{P} \left(\max_{\pi \in \Pi^x} |\pi| > C_{38} |x|_1 \right) \leq e^{-C_{39} |x|_1}.$$

Proof. Since the weights take values in $\{0, 1\}$, we have $T(0, x) \leq |x|_1$. First, we fix Bernoulli distributed edge weights with $\mathbb{P}(\tau_e = 0) = p_0 < p_c(d)$. The estimate we want to prove in the lemma follows directly from the following estimate of Kesten which also appeared as [3, Lemma 4.5]

$$\mathbb{P}(\exists \text{ vertex self-avoiding } \Gamma \text{ starting at } 0 \text{ with } |\Gamma| \geq n \text{ but with } T(\Gamma) < an) \leq e^{-Cn}$$

where the constant a and C depend on p_0 . Coupling together the different Bernoulli weights using common uniform random variables, we see that if we have $\mathbb{P}(\tau_e = 0) \leq p_0 < p_c(d)$, this estimate will hold with the same constants a and C . \square

The next result is an immediate consequence of the previous one:

Lemma A.3. *Suppose that (2.1) holds. Then*

(i) *There is a constant $C_{40} = C_{40}(d) > 0$ so that for each $n \in \mathbb{N}$,*

$$\mathbb{P}\left(\exists x \in \mathbb{Z}^d \text{ with } |x|_1 \geq n \text{ and } \max_{\pi \in \Pi^x} |\pi| > C_{36}|x|_1\right) \leq e^{-C_{40}n^{1/d}}.$$

(ii) *There exist constants $C_{41} = C_{41}(d, \mu), C_{42} = C_{42}(d, \mu) > 0$ so that for all $x \in \mathbb{Z}^d$,*

$$\mathbb{E}\left[\max_{\pi \in \Pi^x} |\pi| \mathbb{1}_{\{\max_{\pi \in \Pi^x} |\pi| > C_{36}|x|_1\}}\right] \leq C_{41} e^{-C_{42}|x|_1^{1/d}}$$

Proof. Part (i) is immediate from Lemma A.1 and a union bound. Turning to part (ii), equation [3, Eq. (4.4)] implies that there are constants $C_{43}, C_{44} > 0$ depending only on μ and d so that for all $\lambda > C_{43}$,

$$\mathbb{E}\left[\max_{\pi \in \Pi^x} |\pi| \mathbb{1}_{\{\max_{\pi \in \Pi^x} |\pi| > C_{43}|x|_1^d\}}\right] = |x|_1^d \int_{C_{43}}^{\infty} \mathbb{P}(\max_{\pi \in \Pi^x} |\pi| > \lambda |x|_1^d) d\lambda \leq |x|_1^d \int_{C_{43}}^{\infty} e^{-C_{44}\lambda^{1/d}|x|_1} d\lambda.$$

The last integral can be computed explicitly and has the form of a polynomial in $|x|_1^{1/d}$ multiplied by $\exp\{-C_{44}^{1/d}|x|_1\}$. We also have

$$\mathbb{E}\left[\max_{\pi \in \Pi^x} |\pi| \mathbb{1}_{\{C_{36}|x| \leq \max_{\pi \in \Pi^x} |\pi| < C_{43}|x|_1^d\}}\right] \leq C_{43}|x|_1^d \mathbb{P}\left(\max_{\pi \in \Pi^x} |\pi| > C_{36}|x|_1\right).$$

Lemma A.1 then implies the result. \square

Remark A.4. Similar to Lemma A.2, the constants in the lemma above can also be made uniform for Bernoulli edge weight distributions with $\mathbb{P}(\tau_e = 0) \leq p_0 < p_c(d)$. To obtain [3, Eq. (4.4)] with uniform constants, follow the proof in [3] and replace the use of [3, Theorem 4.8] by Lemma A.2 in that argument.

k -dependent Bernoulli tail bounds. The next lemma records some consequences of results in [11] giving tail bounds for the probability that a sum of k -dependent Bernoulli random variables is large.

Proposition A.5. *Fix $p \in (0, 1)$. Let $\{X_i\}_{i=1}^n$ be a family of Bernoulli(p) random variables and suppose that for each i , there exists a set $S \subset \{1, 2, \dots, n\}$ with $\#S \leq m$ such that X_i is independent of $\{X_j : j \notin S\}$. Then, for all $t > 0$, we have the following inequalities:*

$$\begin{aligned} \mathbb{P}\left(\sum_{i=1}^n X_i - np > t\right) &\leq \exp\left\{-\frac{np}{(m+1)(1-p)} \left[\left(1 + \frac{4t}{5np}\right) \ln\left(1 + \frac{4t}{5np}\right) - \frac{4t}{5np}\right]\right\}, \\ \mathbb{P}\left(\sum_{i=1}^n X_i - np > t\right) &\leq \exp\left\{-2\frac{t^2}{(m+1)n}\right\}. \end{aligned}$$

Proof. These are consequences of Corollaries 2.2 and 2.4 in [11], where the bound of $m+1$ on the chromatic number of the dependency graph of the random variables $\{X_i\}_{i=1}^n$ follows from Brooks' theorem [5, 14]. \square

Connecting points using directed paths. Recall that we denote by e_1, \dots, e_d the standard coordinate vectors in \mathbb{Z}^d . The following lemma gives a construction which allows us to connect points in \mathbb{Z}^d through a collection of directed paths with lengths of a given order in such a way that the path remains in a ball intersected with a half space.

Lemma A.6. *Suppose that H is a hyperplane parallel to one of the coordinate axes, i.e. $H = \{h \in \mathbb{R}^d : h \cdot e_l = c\}$ for some $c \in \mathbb{R}$, and $x, y \in \mathbb{Z}^d$ satisfy*

$$x \cdot e_l \geq c \quad \text{and} \quad y \cdot e_l > c.$$

Define a finite collection of vectors

$$V = \{e_i + e_j, e_i - e_j, -e_i + e_j, -e_i - e_j \text{ for } i, j = 1, \dots, d\}.$$

Fix any integer $m \geq 1000$, and suppose that $|x - y|_1 \leq m$. Then there exists $y^* \in \mathbb{Z}^d$ with $y^* \cdot e_l > c$ and $|y - y^*|_\infty \leq 1$, an integer $K \leq 1609 + (104)^{d-1}$, a set of vectors $(v_i)_{i=1}^K$ with $v_i \in V$ for all i , and a set of integers $\{a_k\}_{k=1}^K$ which satisfy for each $k \leq K$,

$$\frac{m}{1000} \leq |a_k| \leq \frac{m}{10}, \quad \left| x + \sum_{i=1}^k a_i v_i - y \right|_\infty \leq 2m, \quad \text{and} \quad \left(\sum_{i=1}^k a_i v_i \right) \cdot e_l > c, \quad (\text{A.1})$$

so that $y^* - x = \sum_{i=1}^K a_i v_i$.

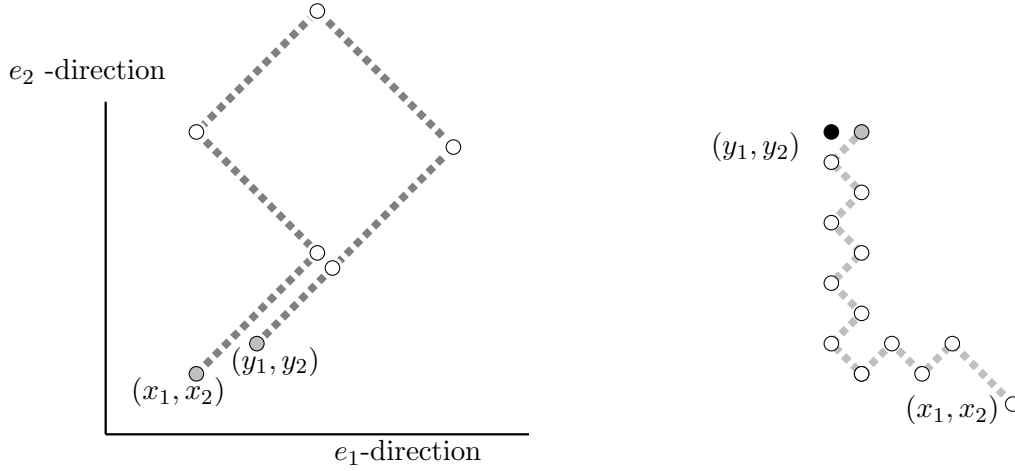

FIGURE A.1. *Left:* Connecting two points x, y that are within l^∞ -distance $m/300$. Each segment has length at least $m/1000$. *Right:* For distant points, we connect x to a point near y and then reduce to the case on the left.

Proof. The desired y^* is obtained from y by adding 1 to its i^{th} coordinate whenever $x_i - y_i$ is odd. For notational simplicity and without loss of generality, we will assume that $y = y^*$, $l = 2$ and $c = 0$, i.e. $H = \{h \in \mathbb{R}^d : h \cdot e_2 = 0\}$. We construct the coefficients a_i and vectors v_i iteratively, matching coordinates two at a time, beginning with matching (x_1, x_2) and (y_1, y_2) , then matching (y_2, x_3) and (y_2, y_3) , and so on. For notational convenience, we consider these maps in \mathbb{Z}^2 , with the understanding that we are fixing all but two coordinates in the argument:

$$x \xrightarrow{(x_1, x_2) \rightarrow (y_1, y_2)} (y_1, y_2, x_3, \dots, x_d) \xrightarrow{(y_2, x_3) \rightarrow (y_2, y_3)} (y_1, y_2, y_3, \dots, x_d) \rightarrow \dots \rightarrow y$$

The main idea behind our construction is illustrated in Figure A.1. We first consider the case where (x_1, x_2) and (y_1, y_2) satisfy $|(x_1, x_2) - (y_1, y_2)|_\infty \leq m/300$. In this case, we list the six

vectors in our decomposition below.

$$\begin{aligned} a_1 v_1 &= \lfloor \frac{m}{100} \rfloor (e_1 + e_2), & a_2 v_2 &= \lfloor \frac{m}{100} \rfloor (-e_1 + e_2), & a_3 v_3 &= \lfloor \frac{m}{100} \rfloor (e_1 + e_2), \\ a_4 v_4 &= \left(\lfloor \frac{m}{100} \rfloor + \frac{(x_2 - y_2) - (x_1 - y_1)}{2} \right) (e_1 - e_2), & a_5 v_5 &= \lfloor \frac{m}{100} \rfloor (-e_1 - e_2), \\ a_6 v_6 &= \left(\lfloor \frac{m}{100} \rfloor + \frac{(x_2 - y_2) + (x_1 - y_1)}{2} \right) (-e_1 - e_2). \end{aligned}$$

The coefficient in front of each of the six vectors in V above is between $m/1000$ and $m/10$ because of our restriction on the pairs (x_1, x_2) and (y_1, y_2) .

When $|(x_1, x_2) - (y_1, y_2)|_\infty > m/300$, we first connect (x_1, x_2) to a point within $m/300$ of (y_1, y_2) and then reduce to the previous case. See the right hand side of Figure A.1. Consider the case where $x_1 > y_1$ and $x_2 \leq y_2$. Starting from (x_1, x_2) , add $\lfloor m/800 \rfloor (-e_1 + e_2)$. If the e_1 coordinate is still not within $m/300$ of y_1 , add $\lfloor m/800 \rfloor (-e_1 + e_2)$, then add $\lfloor m/800 \rfloor (-e_1 - e_2)$ and repeat, alternating between those two vectors, until we reach a site with e_1 coordinate within $m/300$ of y_1 . This process repeats no more than 801 times. From this site, similarly alternate adding $\lfloor m/800 \rfloor (-e_1 + e_2)$ and $\lfloor m/800 \rfloor (e_1 + e_2)$, beginning with $\lfloor m/800 \rfloor (-e_1 + e_2)$, until we reach a site with both coordinates within $m/300$ of (y_1, y_2) . Again, this can take no more than 801 repetitions. By construction, at each step the dot product with e_2 is strictly greater than $x \cdot e_2$. The other cases can be argued similarly.

Next, we connect (y_2, x_3) with (y_2, y_3) . We give the argument for the case of $y_3 > x_3$, with the case $y_3 < x_3$ being similar. Add together $\lfloor m/100 \rfloor (e_2 + e_3)$ followed by $\lfloor m/100 \rfloor (-e_2 + e_3)$ until reaching a site of the form (y_2, z) , where $2\lfloor m/1000 \rfloor \leq z - x_3 < 2\lfloor m/10 \rfloor$. By construction, $z - x_3$ must be even, so we may finish by adding the vector $\frac{z - x_3}{2} (e_2 + e_3)$ followed by $\frac{z - x_3}{2} (-e_2 + e_3)$. Note that in each step of this construction, the dot product with e_2 is at least y_2 and, because $|x_3 - y_3| \leq m$, this algorithm cannot require adding together more than 104 vectors of the type above. More generally, this argument can be used to go from (y_k, x_{k+1}) to (y_k, y_{k+1}) .

In both cases, we never exit the ℓ^∞ ball of radius $2m$ around y . \square

APPENDIX B. k -DEPENDENT GREEDY LATTICE ANIMALS

Recall for $e = \{a, b\} \in \mathcal{E}^d$, we have $v_e = \arg \min_{x \in \{a, b\}} |x|_1$. Fix $k \in \mathbb{N}$ and let $\{X_e : e \in \mathcal{E}^d\}$ be a family of marginally identically distributed Bernoulli(p) random variables where X_e is independent of $\{X_{\bar{e}} : |v_e - v_{\bar{e}}|_\infty \geq k\}$. This is illustrated in the Figure B.1. We denote the joint probability distribution of these random variables by \mathbb{P}_p . Let Ξ_n denote the set of all vertex self-avoiding paths starting from 0 of length n . Define a *greedy lattice animal* N_n by

$$N_n = \max_{\gamma \in \Xi_n} \left\{ \sum_{e \in \gamma} X_e \right\}.$$

Lemma B.1. *There exist constants $C_{45}, C_{46}, C_{47}, C_{48} > 0$, all depending only on d and k , such that*

(i) *For all $p \in [0, 1]$, for any $n \in \mathbb{N}$,*

$$\mathbb{E}_p N_n \leq C_{45} p^{1/d} n.$$

(ii) *For each $p \in (0, 1]$,*

$$\mathbb{E}_p \left[\sup_{n \geq \lceil p^{-2/d} \rceil} \frac{N_n}{n} \right] \leq C_{45} p^{1/d}.$$



X_e and $X_{\bar{e}}$ may be dependent.

X_e and $X_{\bar{e}}$ are independent

FIGURE B.1. The dependence of the edge weights.

(iii) For each $p \in (0, 1)$ and all $s > C_{46}$,

$$\mathbb{P} \left(\sup_{n \geq \lceil p^{-2/d} \rceil} \frac{N_n}{n} > sp^{1/d} \right) \leq C_{47} e^{-C_{48} s}.$$

As a tool, in the proof of Lemma B.1 we recall the following lemma from [6], which describes how a finite connected subset $\alpha \subseteq \mathbb{Z}^d$ can be covered by boxes $B(\ell) = [-\ell, \ell]^d$.

Lemma B.2. [6, Lemma 1] *Let $\alpha \subset \mathbb{Z}^d$ be connected, with $0 \in \alpha$ and $\#\alpha = n$. Let $\ell \in \{1, \dots, n\}$. There exists a sequence of $x_0, x_1, \dots, x_r \in \mathbb{Z}^d$, where $r = \lfloor 2n/\ell \rfloor$, such that $x_0 = 0$,*

$$\alpha \subset \bigcup_{i=0}^r (\ell x_i + B(2\ell)),$$

and $|x_{i+1} - x_i|_\infty \leq 1$ for $i = 0, 1, \dots, r-1$.

Our proof of Lemma B.1 is modeled on the proof of [7, Lemma 6.8]. Similar arguments have also appeared previously in the proofs of [13, Theorem 2] and [15, Proposition 2.2].

Proof of Lemma B.1. There is nothing to be shown if $p \in \{0, 1\}$, so fix $p \in (0, 1)$. First, we prove part (i). If $np^{1/d} \leq 1$, we have

$$\frac{\mathbb{E}_p N_n}{np^{1/d}} \leq \frac{1}{np^{1/d}} \sum_{e \in [-n, n]^d} \mathbb{E}_p X_e \leq \frac{2d(2n+1)^d p}{np^{1/d}} \leq 2d(3^d)(np^{1/d})^{d-1} \leq 3^{d+1}d.$$

If $np^{1/d} > 1$, set $l = \lceil p^{-1/d} \rceil$. We have

$$\begin{aligned} \mathbb{P}_p \left(\frac{N_n}{np^{1/d}} \geq s \right) &= \mathbb{P}_p \left(\max_{\gamma \in \Xi_n} \left\{ \sum_{e \in \gamma} X_e \right\} \geq snp^{1/d} \right) \\ &\leq \mathbb{P}_p \left(\sup_{x_0, \dots, x_r} \left\{ \sum_{\substack{e=\{x,y\} \\ x,y \in \bigcup_{i=0}^r (\ell x_i + B(2\ell))}} X_e \right\} \geq snp^{1/d} \right) \\ &\leq \sum_{x_0, \dots, x_r} \mathbb{P}_p \left(\sum_{\substack{e=\{x,y\} \\ x,y \in \bigcup_{i=0}^r (\ell x_i + B(2\ell))}} X_e \geq snp^{1/d} \right), \end{aligned} \quad (\text{B.1})$$

where both the supremum \sup_{x_0, \dots, x_r} and sum \sum_{x_0, \dots, x_r} are over all subsets $\{x_0, \dots, x_r\} \subset \mathbb{Z}^d$ of cardinality $r+1 = 1 + \lfloor 2(n+1)/l \rfloor \leq 5np^{1/d}$, which satisfy $x_0 = 0$ and $|x_{i+1} - x_i|_\infty \leq 1$ for $i = 0, \dots, r-1$. The number of terms in the outer sum (B.1) is bounded by $3^{d(r+1)} \leq 3^{5dnp^{1/d}}$. Fix such a collection $\mathbf{x} = (x_0, \dots, x_r)$ and denote by

$$U_{\mathbf{x}} = \sum_{\substack{e=\{x,y\} \\ x,y \in \bigcup_{i=0}^r (lx_i + B(2l))}} X_e.$$

The number of vertices in $B(2l)$ is $(4l+1)^d$ and so

$$\#\left\{e = \{x, y\} : x, y \in \bigcup_{i=0}^r (lx_i + B(2l))\right\} \leq (r+1)2d(4l+1)^d \leq C_{49}np^{1/d-1},$$

where $C_{49} = C_{49}(d) > 0$ is a dimension-dependent constant. It follows that $\mathbb{E}_p U_{\mathbf{x}} \leq C_{49}np^{1/d}$. Call $\varphi(x) = (1+x)\log(1+x) - x$. By Proposition A.5, for $s > C_{49}$, if $p \in (0, 1/2]$ we have

$$\mathbb{P}_p\left(U_{\mathbf{x}} \geq snp^{1/d}\right) \leq \mathbb{P}_p\left(U_{\mathbf{x}} - \mathbb{E}U_{\mathbf{x}} \geq (s/C_{49} - 1)C_{49}np^{1/d}\right) \leq e^{-\frac{2}{k+1}np^{1/d}\varphi(4(s/C_{49}-1)/5)}.$$

If, on the other hand, $p \in (1/2, 1)$, then using the other bound in Proposition A.5, we have

$$\begin{aligned} \mathbb{P}_p\left(U_{\mathbf{x}} \geq snp^{1/d}\right) &\leq \mathbb{P}_p\left(U_{\mathbf{x}} - \mathbb{E}U_{\mathbf{x}} \geq (s/C_{49} - 1)C_{49}np^{1/d}\right) \\ &\leq e^{-2\frac{(s/C_{49}-1)^2 C_{49}np^{1/d+1}}{k+1}} \leq e^{-\frac{C_{49}np^{1/d}}{k+1}(s/C_{49}-1)^2}. \end{aligned}$$

Let $C_{50} > 8(1+\exp(C_{49})) \vee (C_{49}d(k+1)\log 3)$. For $s > C_{50}$, we have both $\varphi(4(s/C_{49}-1)/5) \geq s/2$ and $(s/C_{49}-1)^2 \geq s$. Then, if $p \in (0, 1)$, for $s > C_{50}$, we have

$$\mathbb{P}_p\left(\frac{N_n}{np^{1/d}} \geq s\right) \leq e^{-\frac{np^{1/d}}{k+1}(s/C_{49}-d(k+1)\log 3)}. \quad (\text{B.2})$$

Using $np^{1/d} > 1$, we have

$$\begin{aligned} \mathbb{E}\left[\frac{N_n}{np^{1/d}}\right] &\leq C_{50} + \int_{C_{50}}^{\infty} \mathbb{P}\left(\frac{N_n}{np^{1/d}} > s\right) ds \\ &\leq C_{50} + \int_{C_{50}}^{\infty} e^{-\frac{1}{k+1}(s/C_{49}-d(k+1)\log 3)} ds < \infty. \end{aligned}$$

Turning to parts (ii) and (iii), we continue from (B.2). For $s > C_{50}$, we have

$$\begin{aligned} \mathbb{P}_p\left(\sup_{n \geq \lceil p^{-2/d} \rceil} \left\{\frac{N_n}{n}\right\} \geq sp^{1/d}\right) &\leq \sum_{n=\lceil p^{-2/d} \rceil}^{\infty} \mathbb{P}_p\left(N_n \geq snp^{1/d}\right) \\ &\leq \sum_{n=\lceil p^{-2/d} \rceil}^{\infty} e^{-\frac{np^{1/d}}{k+1}(s/C_{49}-d(k+1)\log 3)} \leq \sum_{n=1}^{\infty} e^{-\frac{\sqrt{n}}{k+1}(s/C_{49}-d(k+1)\log 3)} \\ &\leq e^{-\frac{1}{k+1}(s/C_{49}-d(k+1)\log 3)} + \int_1^{\infty} e^{-\frac{\sqrt{x}}{k+1}(s/C_{49}-d(k+1)\log 3)} dx. \end{aligned}$$

In the third inequality above, we used $np^{1/d} \geq \sqrt{n}$ and then bounded the sum from $n = \lceil p^{-2/d} \rceil$ to infinity by a sum beginning at $n = 1$. Computing the integral above gives claim (iii). Arguing as above and integrating this estimate gives claim (ii). \square

REFERENCES

- [1] Peter Antal and Agoston Pisztora. On the chemical distance for supercritical Bernoulli percolation. *Ann. Probab.*, 24(2):1036–1048, 1996.
- [2] Antonio Auffinger, Michael Damron, and Jack Hanson. Rate of convergence of the mean for sub-additive ergodic sequences. *Adv. Math.*, 285:138–181, 2015.
- [3] Antonio Auffinger, Michael Damron, and Jack Hanson. *50 years of first-passage percolation*, volume 68 of *University Lecture Series*. American Mathematical Society, Providence, RI, 2017.
- [4] Erik Bates. Empirical distributions, geodesic lengths, and a variational formula in first-passage percolation, 2020. [arXiv: 2006.12580](https://arxiv.org/abs/2006.12580).
- [5] R. L. Brooks. On colouring the nodes of a network. *Proc. Cambridge Philos. Soc.*, 37:194–197, 1941.
- [6] J. Theodore Cox, Alberto Gandolfi, Philip S. Griffin, and Harry Kesten. Greedy lattice animals. I. Upper bounds. *Ann. Appl. Probab.*, 3(4):1151–1169, 1993.
- [7] Michael Damron, Jack Hanson, and Philippe Sosoe. Sublinear variance in first-passage percolation for general distributions. *Probab. Theory Related Fields*, 163(1-2):223–258, 2015.
- [8] Richard Durrett. Oriented percolation in two dimensions. *Ann. Probab.*, 12(4):999–1040, 1984.
- [9] John M. Hammersley and Dominic J. A. Welsh. First-passage percolation, subadditive processes, stochastic networks, and generalized renewal theory. In *Proc. Internat. Res. Semin., Statist. Lab., Univ. California, Berkeley, Calif*, pages 61–110. Springer-Verlag, New York, 1965.
- [10] Christopher Hoffman. AIM problem list: First passage percolation, problem 4.4, 2015. <http://aimpl.org/firstpercolation/4/> .
- [11] Svante Janson. Large deviations for sums of partly dependent random variables. *Random Structures Algorithms*, 24(3):234–248, 2004.
- [12] Harry Kesten. Aspects of first passage percolation. In *École d’été de probabilités de Saint-Flour, XIV—1984*, volume 1180 of *Lecture Notes in Math.*, pages 125–264. Springer, Berlin, 1986.
- [13] Sungchul Lee. The power laws of M and N in greedy lattice animals. *Stochastic Process. Appl.*, 69(2):275–287, 1997.
- [14] L. Lovász. Three short proofs in graph theory. *J. Combinatorial Theory Ser. B*, 19(3):269–271, 1975.
- [15] James B. Martin. Linear growth for greedy lattice animals. *Stochastic Process. Appl.*, 98(1):43–66, 2002.
- [16] Shuta Nakajima. Maximal edge-traversal time in first passage percolation, 2016. [arXiv: 1605.04787](https://arxiv.org/abs/1605.04787).
- [17] J. van den Berg and H. Kesten. Inequalities for the time constant in first-passage percolation. *Ann. Appl. Probab.*, 3(1):56–80, 1993.
- [18] Yu Zhang. Supercritical behaviors in first-passage percolation. *Stochastic Process. Appl.*, 59(2):251–266, 1995.

CHRISTOPHER JANJIGIAN, PURDUE UNIVERSITY
Email address: cjanjigi@purdue.edu

WAI-KIT LAM, UNIVERSITY OF MINNESOTA
Email address: wlam@umn.edu

XIAO SHEN, UNIVERSITY OF WISCONSIN - MADISON
Email address: xshen@math.wisc.edu