GLUING RESOURCE PROOF-STRUCTURES: INHABITATION AND INVERTING THE TAYLOR EXPANSION

GIULIO GUERRIERI, LUC PELLISSIER, AND LORENZO TORTORA DE FALCO

University of Bath, Department of Computer Science, Bath, United Kingdom
e-mail address: g.guerrieri@bath.ac.uk

Inria, LIX & École Polytechnique, Palaiseau, France
e-mail address: luc.pellissier@inria.fr

Università Roma Tre, Dipartimento di Matematica e Fisica, Rome, Italy
e-mail address: tortora@uniroma3.it

ABSTRACT. A Multiplicative-Exponential Linear Logic (MELL) proof-structure can be expanded into a set of resource proof-structures: its Taylor expansion. We introduce a new criterion characterizing those sets of resource proof-structures that are part of the Taylor expansion of some MELL proof-structure, through a rewriting system acting both on resource and MELL proof-structures. As a consequence, we prove also the semi-decidability of the type inhabitation problem for MELL proof-structures.

1. INTRODUCTION

Resource λ -calculus and the Taylor expansion. Girard’s linear logic (LL, [Gir87]) is a refinement of intuitionistic and classical logic that isolates the infinitary parts of reasoning in two (dual) modalities: the *exponentials* ! and ?. They give a logical status to the operations of memory management such as *copying* and *erasing*: a linear proof corresponds—via the Curry–Howard isomorphism—to a program that uses its argument *linearly*, *i.e.* exactly once, while an exponential proof corresponds to a program that can use its argument at will.

The intuition that linear programs are analogous to linear functions (as studied in linear algebra) while exponential programs mirror a more general class of analytic functions got a technical incarnation in Ehrhard’s work [Ehr02, Ehr05] on LL-based denotational semantics for the λ -calculus. This investigation has been then internalized in the syntax, yielding the *resource λ -calculus* [Bou93, ER03, ER08]: there, copying and erasing are forbidden and replaced by the possibility to apply a function to a *bag* of resource λ -terms which specifies how many times (in a finite number) an argument can be linearly passed to the function, so as to represent only bounded computations.

The *Taylor expansion* associates with an ordinary λ -term a (generally infinite) set of resource λ -terms, recursively approximating the usual application: the Taylor expansion of the λ -term MN is made of resource λ -terms of the form $t[u_1, \dots, u_n]$, where t is a resource

Key words and phrases: linear logic, Taylor expansion, proof-structure, pullback, natural transformation.

λ -term in the Taylor expansion of M , and $[u_1, \dots, u_n]$ is a bag of arbitrarily finitely many (possibly 0) resource λ -terms in the Taylor expansion of N . Roughly, the idea is to decompose a program into a set of purely “resource-sensitive programs”, all of them containing only bounded (although possibly non-linear) calls to inputs. The notion of Taylor expansion has many applications in the theory of the λ -calculus, *e.g.* in the study of linear head reduction [ER06a], normalization [PTV16, Vau17], Böhm trees [BHP13, KMP18, BM20], λ -theories [MR14], intersection types [MPV18]. More generally, understanding the relation between a program and its Taylor expansion renews the logical approach to the quantitative analysis of computation started with the inception of LL.

A natural question is the *inverse Taylor expansion problem*: how to characterize which sets of resource λ -terms are contained in the Taylor expansion of a same λ -term? Ehrhard and Regnier [ER08] defined a simple *coherence* binary relation such that a finite set of resource λ -terms is included in the Taylor expansion of a λ -term if and only if the elements of this set are pairwise coherent. Coherence is crucial in many structural properties of the resource λ -calculus, such as in the proof that in the λ -calculus normalization and Taylor expansion commute [ER06a, ER08].

We aim to solve the inverse Taylor expansion problem in the more general context of LL, more precisely in the *multiplicative-exponential fragment* MELL of LL, being aware that for MELL no coherence relation can solve the problem (see below). As a side effect of this investigation, we solve also another open problem, apparently unrelated to the notion of Taylor expansion: the *type inhabitation problem* for MELL proof-structures (again, see below).

Proof-nets, proof-structures and their Taylor expansion: seeing trees behind graphs. In MELL, linearity and the sharp analysis of computations naturally lead to represent proofs in a more general *graph*-like syntax instead of a term-like or tree-like one.¹ Indeed, linear negation is involutive and classical duality can be interpreted as the possibility of juggling between different conclusions, without a distinguished output [Par92]. Graphs representing proofs in MELL are called *proof-nets*: their syntax is richer and more expressive than the λ -calculus. Contrary to λ -terms, proof-nets are special inhabitants of the wider land of *proof-structures*. A proof-structure is any “graph” that can be build in the language of proof-nets and it need not represent a proof in MELL. Proof-nets can be characterized, among proof-structures, by abstract (geometric) conditions called correctness criteria [Gir87].

Proof-structures are well-behaved for performing computations: indeed, the procedure of cut-elimination can be applied to proof-structures, and proof-nets can also be seen as the proof-structures with a good behavior with respect to cut-elimination [Béc98]. Furthermore, proof-structures can be interpreted in denotational models and proof-nets can be characterized among them by semantic means [Ret97]. It is then natural to attack problems in the general framework of proof-structures. In our work, correctness plays no role at all, hence we will consider proof-structures and not only proof-nets. MELL proof-structures are a particular kind of graphs, whose edges are labeled by MELL formulæ and vertices by MELL connectives, and for which special subgraphs are highlighted, the *boxes*, representing the parts of the proof-structure that can be copied and discarded (*i.e.* called an unbounded number of times). A box is delimited from the rest of a proof-structure by exponential modalities: its border is made of one !-cell, its principal door, and arbitrarily many ?-cells,

¹A term-like object is essentially a tree, with one output (its root) and many inputs (its other leaves).

its auxiliary doors. Boxes are nested or disjoint (they cannot partially overlap), so as to add a tree-like structure to proof-structures *aside* from their graph-like nature.

As in λ -calculus, one can define [ER06b] box-free *resource* (or DiLL_0) *proof-structures*², where !-cells make resources available boundedly, and the *Taylor expansion* of MELL proof-structures into these resource proof-structures, that recursively copies the content of the boxes an arbitrary number of times. In fact, as somehow anticipated by Boudes [Bou09], such a Taylor expansion operation can be carried on any tree-like structure. This primitive, abstract, notion of Taylor expansion can then be pulled back to the structure of interest, as shown in [GPT19] and put forth again here.

The question of coherence for proof-structures. The *inverse Taylor expansion problem* has a natural counterpart in the world of MELL proof-structures: given a set of resource proof-structures, is there a MELL proof-structure the expansion of which contains the set? Pagani and Tasson [PT09] give the following answer: it is possible to decide whether a finite set of resource proof-structures is a subset of the Taylor expansion of a same MELL proof-structure (and even possible to do it in non-deterministic polynomial time); but unlike the λ -calculus, the structure of the relation “being part of the Taylor expansion of a same proof-structure” is *much more* complicated than a binary (or even n -ary) coherence. Indeed, for any $n > 1$, it is possible to find $n + 1$ resource proof-structures such that any n of them are in the Taylor expansion of some MELL proof-structure, but there is no MELL proof-structure whose Taylor expansion has all the $n + 1$ as elements (see our Example 8.3 and [Tas09, pp. 244-246]).

In this work, we introduce a new combinatorial criterion, *glueability*, for deciding whether a set of resource proof-structures is a subset of the Taylor expansion of some MELL proof-structure, based on a *rewriting system* on lists of MELL formulæ. Our criterion is more general (and, we believe, simpler) than the one of [PT09], which is limited to the *cut-free* case with *atomic axioms* and characterizes only *finite* sets: we do not have these limitations. We believe that our criterion is a useful tool for studying proof-structures. We conjecture that it can be used to show that, for a suitable geometric restriction, a binary coherence relation does exist for resource proof-structures. It might also shed light on correctness and sequentialization.

As the proof-structures we consider are typed, an unrelated difficulty arises: a resource proof-structure might not be in the Taylor expansion of any MELL proof-structure, not because it does not respect the structure imposed by the Taylor expansion, but because its type is impossible to realize.³ To solve this issue we enrich the resource (but not MELL) proof-structure syntax with a “universal” proof-structure: a special \boxtimes -cell (*daimon*) that can have any number of outputs of any types, representing information plainly missing (see Section 9 for more details and the way this matter is handled by Pagani and Tasson [PT09]).

Our contribution. This paper is the long version of [GPT20] and we keep its structure and main results: the *glueability* criterion that solves the inverse Taylor problem in MELL proof-structures (Theorem 8.2), and the way we prove it, which consists in showing that the Taylor

²Also known as differential proof-structure [dC16], differential net [ER06b, MP07, dC18], simple net [PT09].

³ Similarly, in the λ -calculus, there is no closed λ -term of type $X \rightarrow Y$ with $X \neq Y$ atomic, but the resource λ -term $(\lambda f.f)[\]$ can be given that type: the empty bag $[\]$ kills any information on the argument.

expansion defines a *natural transformation* (Theorem 7.3) from the realm of resource proof-structures to the realm of MELL proof-structures (see Section 2 for an informal explanation). With respect to [GPT20], the main novelties are:

- (1) Following [GPT19], we introduce rigorous definitions of all the notions of graph theory (Section 3) involved in the definition of proof-structures and Taylor expansion. In this way, we can present here a purely graphical definition of MELL proof-structures (Section 4), so as to keep Girard’s original intuition of a proof-structure as a graph even in MELL and to avoid *ad hoc* technicalities to identify the border and the content of a box. This is not only an aesthetic issue but also practical, because our MELL proof-structures are manageable: sophisticated operations on them can be easily defined. For instance, we give an elegant definition of their Taylor expansion by means of *pullbacks* (Section 5).
- (2) With respect to [GPT20], here we use daimons in a different and more limited way. In particular, unlike [GPT20], our MELL proof-structures do not contain any \boxtimes -cell. Thus, our results refer to a more standard and interesting definition of MELL proof-structures, and we deal with less syntactic categories than in [GPT20], simplifying the presentation.
- (3) As a consequence of the previous point, our results (in particular glueability and natural transformation) are more informative, and allow us to solve the *inhabitation problem* for MELL proof-structures (it could not be solved with the results proven in [GPT20]): our rewrite system *semi-decides* if, given a list Γ of MELL formulæ, there is a MELL proof-structure of type Γ (we can guess a sequence of rewritings and check that they indeed are rewritings; but, as there is no bound on the length on the rewritings, this is only a semi-algorithm). This kind of problems are well-studied in many type systems for the λ -calculus, but as far as we know, no results are in the literature for MELL. At first sight, it is quite surprising that the rewriting system we introduce to solve the inverse Taylor expansion problem can also solve the (apparently unrelated) inhabitation problem.

2. OUTLINE AND TECHNICAL ISSUES

The rewritings. The essence of our rewriting system is not located on proof-structures but on lists of MELL formulæ (Definition 6.1). In a very down-to-earth way, this rewriting system is generated by elementary steps akin to rules of sequent calculus read from the *bottom up*: they act on a list of conclusions, analogous to a monolaterous right-handed sequent. These steps are actually more sequentialized than sequent calculus rules, as they do not allow for commutation. For instance, the rule corresponding to the introduction of a \otimes on the i -th formula, is defined as $\otimes_i : (\gamma_1, \dots, \gamma_{i-1}, A \otimes B, \gamma_{i+1}, \dots, \gamma_n) \rightarrow (\gamma_1, \dots, \gamma_{i-1}, A, B, \gamma_{i+1}, \dots, \gamma_n)$.

These rewrite steps then act on MELL proof-structures, coherently with their type, by modifying (most of the times, erasing) the cells directly connected to the conclusion of the proof-structure. Formally, this means that there is a functor **qMELL** from the rewrite steps into the category **Rel** of sets and relations, associating with a list of formulæ the set of MELL proof-structures with these conclusions, and with a rewrite step a relation implementing it (Definition 6.4). The rules *deconstruct* the proof-structure, starting from its conclusions. The rule \otimes_1 acts by removing a \otimes -cell on the first conclusion, replacing it by two conclusions.

These rules can only act on specific proof-structures, and indeed, capture a lot of their structure: \otimes_i can be applied to a MELL proof-structure R if and only if R has a \otimes -cell in

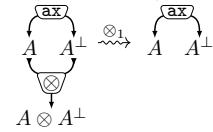

the conclusion i (as opposed to, say, an axiom). So, in particular, every proof-structure is completely characterized by any sequence rewriting it to the empty proof-structure.

Naturality. The same rules act also on sets of resource proof-structures, defining the functor \mathfrak{PqDiLL}_0 from the rewrite steps into the category **Rel** (Definition 7.2). When carefully defined, the Taylor expansion induces a *natural transformation* from \mathfrak{PqDiLL}_0 to **qMELL** (Theorem 7.3). By applying this naturality repeatedly, we get our characterization (Theorem 8.2): a set of resource proof-structures Π is a subset of the Taylor expansion of a **MELL** proof-structure if and only if there is a sequence rewriting Π to the singleton of the *empty* proof-structure.

The naturality property is not only a mean to get our characterization, but also an interesting result in itself: natural transformations can often be used to express fundamental properties in a mathematical context. In this case, the *Taylor expansion is natural* with respect to the possibility to build a (**MELL** or resource) proof-structure by adding a cell to its conclusions or boxing it. Said differently, naturality of the Taylor expansion roughly means that the rewrite rules that deconstruct a **MELL** proof-structure R and a set of resource proof-structures in the Taylor expansion of R mimic each other.

Quasi-proof-structures and mix. Our rewrite rules consume proof-structures from their conclusions. The rule corresponding to boxes in **MELL** opens a box by deleting its principal door (a $!$ -cell) and its border, while for a resource proof-structure it deletes a $!$ -cell and separates the different copies of the content of the box (possibly) represented by such a $!$ -cell. This operation is problematic in a twofold way. In a resource proof-structure, where the border of boxes is not marked, it is not clear how to identify such copies. On the other side, in a **MELL** proof-structure the content of a box is not to be treated as if it were at the same level as what is outside of the box: it can be copied many times or erased, while what is outside boxes cannot, and treating the content in the same way as the outside suppresses this distinction, which is crucial in **LL**. So, we need to remember that the content of a box, even if it is at depth 0 (*i.e.* not contained in any other box) after erasing the box wrapping it by means of our rewrite rules, is not to be mixed with the rest of the structure at depth 0.

In order for our proof-structures to provide this information, we need to generalize them and consider that a proof-structure can have not just a tree of boxes, but a *forest*: this yields the notion of *quasi-proof-structure* (Definition 4.4). In this way, according to our rewrite rules, opening a box by deleting its principal door amounts to taking a box in the tree and disconnecting it from its root, creating a new tree. We draw this in a quasi-proof-structure by surrounding elements having the same root with a dashed line, open from the bottom, remembering the phantom presence of the border of the box, even if it was erased. This allows one to open the box only when it is “alone”, surrounded by a dashed line (see Definition 6.3).

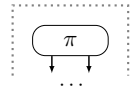

This is not merely a technical remark, as this generalization gives a status to the *mix* rule of **LL**: indeed, mixing two proofs amounts to taking two proofs and considering them as one, without any other modifications. Here, it amounts to taking two proofs, each with its box-tree, and considering them as one by merging the roots of their trees (see the *mix* step in Definition 6.3). We embed this design decision up to the level of formulae, which

are segregated in different zones that have to be mixed before interacting (see the notion of partition of a finite sequence of formulæ in Section 4.1).

Geometric invariance and emptiness: the filled Taylor expansion. The use of forests instead of trees for the nesting structure of boxes, where the different roots are thought of as the contents of long-gone boxes, has an interesting consequence in the Taylor expansion: indeed, an element of the Taylor expansion of a proof-structure contains an arbitrary number of copies of the contents of the boxes, in particular *zero*. If we think of the part at depth 0 of a MELL proof-structure as inside an invisible box, its content can be deleted in some elements of the Taylor expansion just as any other box.⁴ As erasing completely conclusions would cause the Taylor expansion not preserve the conclusions (which would lead to technical complications), we introduce the *filled Taylor expansion* (Definition 5.6), which contains not only the elements of the usual Taylor expansion, but also elements of the Taylor expansion where one component has been erased and replaced by a \boxtimes -cell (*daimon*), representing a lack of information, apart from the number and types of the conclusions.

Atomic axioms. Our paper focuses on the case where proof-structures are restricted to *atomic axioms*. In [GPT20, Sec. 7] we sketched how to adapt our method to the non-atomic case. That sketch is still valid here, we omit it for the lack of space and because it requires some *ad hoc* and inelegant adjustments to deal with \boxtimes -cells in resource proof-structures.

Outline. Section 3 recalls some preliminary notions on graph theory. In Section 4 we define (MELL and DiLL₀) proof-structures and quasi-proof-structures. Section 5 defines the notion of Taylor expansion. Section 6 introduces the rewriting rules on lists of lists of formulæ and lifts them to MELL quasi-proof-structures via the functor $\mathfrak{q}\text{MELL}$. In Section 7 we lift the rewriting rules to DiLL₀ quasi-proof-structures via the functor $\mathfrak{P}\mathfrak{q}\text{DiLL}_0$ and we show our first main result: the Taylor expansion induces a natural transformation between the two functors. Section 8 proves our other main results: the solution of the inverse Taylor expansion problem (via a glueability criterion) and the solution of the type inhabitation problem in MELL. Section 9 concludes with some final remarks.

3. PRELIMINARIES ON GRAPHS

Graphs with half-edges. There are many formalizations of the familiar notion of graph. Here we adopt the one due to [BM07]:⁵ a graph is still a set of edges and a set of vertices, but edges are now split in halves, allowing some of them to be hanging. Splitting every edge in two has at least four features of particular interest to represent LL proof-structures:

- two half-edges are connected by an involution, thus defining an edge linking two vertices (possibly the same vertex). The fixed points of this involution are “hanging” edges, linked a vertex only on one endpoint: they are suited to represent the conclusions of a proof-structure. In this way it is also easy to define some intuitive but formally tricky operations such as the graft or the substitution of a graph for another graph (see Example 3.4);

⁴The dual case, of copying the contents of a box, poses no problem in our approach.

⁵The folklore attributes the definition of graphs with half-edges to Kontsevitch and Manin, but the idea can actually be traced back to Grothendieck’s *dessins d’enfant*.

- given any vertex v in a graph τ , it is natural to define the *corolla* of v , that is v itself with the half-edges linked to it; τ is the union of its corollas, glued together by the involution;
- while studying proof-structures, it is often necessary to treat them both as directed and undirected graphs. With this definition of graph, an orientation, so as a labeling and a coloring, are structures on top of the structure of the undirected graph (see Definition 3.3);
- this definition of graph allows a uniform syntax to represent both proof-structures and other structures of interest (*e.g.*, the box-tree of a proof-structure). In this way, we avoid appealing to *ad hoc* conditions in the definitions of proof-structure and Taylor expansion, which are then more compact and rely only on notions from graph theory.

Definition 3.1 (graph). A (finite⁶) *graph* is a quadruple $\tau = (F_\tau, V_\tau, \partial_\tau, j_\tau)$, where

- F_τ is a finite set, whose elements are called *flags* of τ ;
- V_τ is a finite set, whose elements are called *vertices* of τ ;
- $\partial_\tau: F_\tau \rightarrow V_\tau$ is a function associating with each flag its *endpoint*;
- $j_\tau: F_\tau \rightarrow F_\tau$ is an involution, *i.e.* $j_\tau \circ j_\tau(f) = f$ for any $f \in F_\tau$.

The graph τ is *empty* if $V_\tau = \emptyset$.⁷

A flag that is a fixed point of the involution j_τ is a *tail* of τ . A two-element orbit $\{f, f'\}$ of j_τ is an *edge* of τ between vertices $\partial_\tau(f)$ and $\partial_\tau(f')$, and f, f' are the *halves* of the edge.

Given two graphs τ and τ' , it is always possible to consider their disjoint union $\tau \sqcup \tau'$ defined as the disjoint union of the underlying sets and functions.

A one-vertex graph with set of flags F and involution the identity function id_F on F is called a *corolla* (the endpoint of each flag is the only vertex); it is usually denoted by $*_F$.

Given a graph $\tau = (F_\tau, V_\tau, \partial_\tau, j_\tau)$, a vertex v defines a corolla $\tau_v = (F_v, \{v\}, \partial_\tau|_{F_v}, \text{id}_{F_v})$ where $F_v = \partial_\tau^{-1}(v)$. Every graph can be described as the set of corollas of its vertices, together with the involution gluing some flags in edges.

Definition 3.2 (graph morphism and isomorphism). Let τ, σ be two graphs. A *graph morphism* $h: \tau \rightarrow \sigma$ from τ to σ is a couple of functions $(h_F: F_\tau \rightarrow F_\sigma, h_V: V_\tau \rightarrow V_\sigma)$ such that $h_V \circ \partial_\tau = \partial_\sigma \circ h_F$ and $h_F \circ j_\tau = j_\sigma \circ h_F$.

A graph morphism is *injective* if its component functions are. A *graph isomorphism* is a graph morphism whose component functions are bijections.

Intuitively, a graph morphism preserves tails and edges. The category **Graph** has graphs as objects and graph morphisms as arrows: indeed, graph morphisms compose (by composing the underlying functions) and the couple of identities (on vertices and flags) is neutral for such a composition. It is a monoidal category, with disjoint union as a monoidal product.

Graphs with structure. Some structure can be put on top of a graph.

Definition 3.3 (structured graph). Let $\tau = (F_\tau, V_\tau, \partial_\tau, j_\tau)$ be a graph.

- A *labeled graph* (τ, ℓ_τ) with labels in I is a graph τ and a function $\ell_\tau: V_\tau \rightarrow I$.
- A *colored graph* (τ, \mathbf{c}_τ) is a graph τ with a function $\mathbf{c}_\tau: F_\tau \rightarrow C$ such that $\mathbf{c}_\tau(f) = \mathbf{c}_\tau(f')$ for the two halves f, f' of any edge of τ .

⁶The finiteness condition on F_τ and V_τ can be dropped, so as to allow for possibly infinite graphs. We require it because we only deal with finite graphs.

⁷This implies that ∂_τ is the empty function and $F_\tau = \emptyset$.



FIGURE 1. A directed labeled colored ordered corolla (on the left), and a directed labeled colored ordered two-vertex graph (on the right).

- A *directed graph* (τ, \mathbf{o}_τ) is a graph τ with a function $\mathbf{o}_\tau: F_\tau \rightarrow \{\mathbf{in}, \mathbf{out}\}$ such that $\mathbf{o}_\tau(f) \neq \mathbf{o}_\tau(f')$ for the two halves f, f' of any edge of τ . If $\mathbf{o}_\tau(f) = \mathbf{out}$ and $\mathbf{o}_\tau(f') = \mathbf{in}$, $\{f, f'\}$ is said an *edge* of τ from $\partial_\tau(f)$ to $\partial_\tau(f')$; **in**-oriented (resp. **out**-oriented) tails of τ are called *inputs* (resp. *outputs*) of τ ; if v is a vertex of τ , the *inputs* (resp. *outputs*) of v are the elements of the set $\mathbf{in}_\tau(v) = \partial_\tau^{-1}(v) \cap \mathbf{o}_\tau^{-1}(\mathbf{in})$; (resp. $\mathbf{out}_\tau(v) = \partial_\tau^{-1}(v) \cap \mathbf{o}_\tau^{-1}(\mathbf{out})$);
- An *ordered graph* $(\tau, <_\tau)$ is a graph together with an order on the flags.

Different structures on a graph τ can combine, *e.g.* τ can be endowed with both a labeling ℓ_τ and an orientation \mathbf{o}_τ . Intuitively, a graph is labeled (resp. colored) when labels are associated with its vertices (resp. edges and “hanging” edges). In a directed graph, an input (resp. output) of a vertex v is a—half or hanging—edge incoming in (resp. outgoing from) v .

Graphs can be depicted in diagrammatic form. As a graph is just a disjoint union of corollas glued by the involution, we only need to depict corollas (as in Figure 1, on the left) and place the two halves of an edge next to each other (as in Figure 1, on the right). In directed graphs, inputs of a corolla are depicted above, outputs are below; arrows also show the orientation. The color of a flag f (if any) is written next to f . The label of a vertex v (if any) is written inside v . If ordered, flags of a corolla are depicted increasing from left to right.

Example 3.4. The directed labeled colored ordered corolla $\mathbf{5} = (*_{\mathbf{5}}, \mathbf{o}_{\mathbf{5}}, \ell_{\mathbf{5}}, \mathbf{c}_{\mathbf{5}}, <_{\mathbf{5}})$ depicted in Figure 1 (on the left) has $*$ as only vertex and $F_{\mathbf{5}} = \{0, 1, 2, 3, 4\}$ as set of flags; it is endowed with the order $0 <_{\mathbf{5}} 4$ and $1 <_{\mathbf{5}} 2 <_{\mathbf{5}} 3$, the labeling $\ell_{\mathbf{5}}(*) = \star$, and the orientation $\mathbf{o}_{\mathbf{5}}: F_{\mathbf{5}} \rightarrow \{\mathbf{in}, \mathbf{out}\}$ defined by $\mathbf{o}_{\mathbf{5}}(0) = \mathbf{o}_{\mathbf{5}}(4) = \mathbf{out}$ and $\mathbf{o}_{\mathbf{5}}(1) = \mathbf{o}_{\mathbf{5}}(2) = \mathbf{o}_{\mathbf{5}}(3) = \mathbf{in}$, the coloring $\mathbf{c}_{\mathbf{5}}: F_{\mathbf{5}} \rightarrow \{a_0, \dots, a_4\}$ defined by $\mathbf{c}(i) = a_i$ for all $i \in F_{\mathbf{5}}$.

Consider also the directed labeled colored corolla $\sigma_{\mathbf{ax}}$, whose only vertex is labeled by \mathbf{ax} , and whose only flags are the outputs $\mathbf{5}$ (colored by a_2) and $\mathbf{6}$ (colored by a_3). The directed labeled colored ordered two-vertex graph ρ depicted in Figure 1 (on the right) is obtained from the corollas $\mathbf{5}$ and $\sigma_{\mathbf{ax}}$ by defining the involution $j_\rho: \{0, \dots, 6\} \rightarrow \{0, \dots, 6\}$ as $j_\rho(i) = j_{\tau_{\mathbf{5}}}(i)$ for $i \in \{0, 1, 4\}$, and $j_\rho(i) = i + 3$ for $i \in \{2, 3\}$, and $j_\rho(i) = i - 3$ for $i \in \{5, 6\}$.

Each enrichment of the structure of graphs introduced in Definition 3.3 induces a notion of morphism that preserves such a structure, and an associated category. For instance, given two directed graphs (τ, \mathbf{o}_τ) and $(\sigma, \mathbf{o}_\sigma)$, a *directed graph morphism* $h: (\tau, \mathbf{o}_\tau) \rightarrow (\sigma, \mathbf{o}_\sigma)$ is a graph morphism $h = (h_F, h_V): \tau \rightarrow \sigma$ such that $\mathbf{o}_\sigma \circ h_F = \mathbf{o}_\tau$; this means that h_F maps input (resp. output) flags of τ into input (resp. output) flags of σ .

Trees and paths. An *undirected path* on a graph τ is a finite and even sequence of flags $\varphi = (f_1, \dots, f_{2n})$ for some $n \in \mathbb{N}$ such that, for all $1 \leq i \leq n$, $j_\tau(f_{2i-1}) = f_{2i} \neq f_{2i-1}$ and (if $i \neq n$) $\partial_\tau(f_{2i}) = \partial_\tau(f_{2i+1})$ with $f_{2i} \neq f_{2i+1}$. We say that φ is *between* $\partial_\tau(f_1)$ and $\partial_\tau(f_{2n})$ if $n > 0$ (and it is a *cycle* if moreover $\partial_\tau(f_1) = \partial_\tau(f_{2n})$), otherwise it is the *empty (undirected) path*, which is between any vertex and itself; the *length* of φ is n . Two vertices are *connected* if there is an undirected path between them.

Let τ be a graph: τ is *connected* if any vertices $v, v' \in V_\tau$ are connected; a *connected component* of τ is a maximal (with respect to the inclusion of flags and vertices) connected sub-graph of τ ; τ is *acyclic* (or a *forest*) if it has no cycles; τ is a *tree* if it is a connected forest. Note that a *forest* can be seen as a list of *trees*, each tree is a *connected component*.

A *rooted tree* τ is a directed tree such that each vertex has exactly one output. Thus, by finiteness, τ has exactly one output tail f : the endpoint of f is called the *root* of τ .

Remark 3.5. Let τ and τ' be two rooted trees, and $h: \tau \rightarrow \tau'$ be a directed graph morphism. As h_F preserves tails and orientation, h_V maps the root of τ to the root of τ' . Rooted trees and directed graph morphisms form a category **RoTree**.

A *directed path* on a directed graph τ is an undirected path $\varphi = (f_1, \dots, f_{2n})$ for some $n \in \mathbb{N}$ where f_{2i-1} is output and f_{2i} is input for all $1 \leq i \leq n$. We say that φ is *from* $\partial_\tau(f_1)$ to $\partial_\tau(f_{2n})$ if $n > 0$; otherwise it is the *empty (directed) path*, which is from any vertex to itself.

The set of directed paths on a directed tree τ is finite. As such, we define the *reflexive-transitive closure*, or *free category*, τ° of τ as the directed graph with same vertices and same tails as τ , and with an edge from v to v' for any directed path from v to v' in τ . The operator $(\cdot)^\circ$ lifts to a functor from the category **RoTree** to the category of directed graphs.

Pullback in the category of graphs. The category of graphs has all pullbacks, a fact that we use extensively. We recall here all the definitions and facts that are packed in that affirmation.

Definition 3.6 (pullback). Let \mathcal{C} be a category. Let X, Y, Z be objects of \mathcal{C} , and $f: X \rightarrow Z$ and $g: Y \rightarrow Z$ be arrows of \mathcal{C} . A *pullback* of f and g is the triple $(P, !_X, !_Y)$ where P is an object of \mathcal{C} and $!_X: P \rightarrow X$ and $!_Y: P \rightarrow Y$ are arrows of \mathcal{C} such that diagram (3.1) commutes and, for any $(Q, h: Q \rightarrow X, k: Q \rightarrow Y)$ making the same diagram commute, there is a unique arrow $u: Q \rightarrow P$ factorizing h and k , *i.e.* such that diagram (3.2) commutes.

$$\begin{array}{ccc}
 P & \xrightarrow{!_X} & X \\
 !_Y \downarrow & & \downarrow f \\
 Y & \xrightarrow{g} & Z
 \end{array} \quad (3.1)$$

$$\begin{array}{ccc}
 Q & \xrightarrow{h} & X \\
 \downarrow u & & \downarrow !_X \\
 P & \xrightarrow{!_X} & X \\
 \downarrow k & & \downarrow !_Y \\
 Y & \xrightarrow{g} & Z
 \end{array} \quad (3.2)$$

$$\begin{array}{ccc}
 X \times_Z Y & \xrightarrow{!_X} & X \\
 !_Y \downarrow & \lrcorner & \downarrow f \\
 Y & \xrightarrow{g} & Z
 \end{array} \quad (3.3)$$

A pullback $(P, !_X, !_Y)$ of $f: X \rightarrow Z$ and $g: Y \rightarrow Z$ is unique (up to unique isomorphism); P is usually denoted by $X \times_Z Y$ (leaving f, g implicit) and depicted like in diagram (3.3).

All pullbacks exist in the category **Graph** of graphs. Let us show it explicitly. Let $\tau = (F_\tau, V_\tau, \partial_\tau, j_\tau)$, $\sigma = (F_\sigma, V_\sigma, \partial_\sigma, j_\sigma)$ and $\rho = (F_\rho, V_\rho, \partial_\rho, j_\rho)$ be graphs, and let $g = (g_F, g_V): \sigma \rightarrow \tau$ and $h = (h_F, h_V): \rho \rightarrow \tau$ be graph morphisms. Consider the sets

$$F = \{(f_\sigma, f_\rho) \in F_\sigma \times F_\rho \mid g_F(f_\sigma) = h_F(f_\rho)\} \quad V = \{(v_\sigma, v_\rho) \in V_\sigma \times V_\rho \mid g_V(v_\sigma) = h_V(v_\rho)\}.$$

They are both equipped with their natural projections $\pi_\sigma^F: F \rightarrow F_\sigma$, $\pi_\rho^F: F \rightarrow F_\rho$ and $\pi_\sigma^V: V \rightarrow V_\sigma$, $\pi_\rho^V: V \rightarrow V_\rho$. Let $f \in F$.

$$\begin{aligned} g_V \circ \partial_\sigma \circ \pi_\sigma^F(f) &= \partial_\tau \circ g_F \circ \pi_\sigma^F(f) && \text{because } g \text{ is a graph morphism} \\ &= \partial_\tau \circ h_F \circ \pi_\rho^F(f) && \text{by definition of } F \\ &= h_V \circ \partial_\rho \circ \pi_\rho^F(f) && \text{because } h \text{ is a graph morphism.} \end{aligned}$$

Hence, we can define $\partial: F \rightarrow V$ by $\partial(f) = (\partial_\sigma \circ \pi_\sigma^F(f), \partial_\rho \circ \pi_\rho^F(f))$. In the same way, we define $j: F \rightarrow F$ by $j(f) = (j_\sigma \circ \pi_\sigma^F(f), j_\rho \circ \pi_\rho^F(f))$, and check that it is an involution.

Thus, $\sigma \times_\tau \rho = (F, V, \partial, j)$ is a graph and $\pi_\sigma = (\pi_\sigma^F, \pi_\sigma^V): \sigma \times_\tau \rho \rightarrow \sigma$ and $\pi_\rho = (\pi_\rho^F, \pi_\rho^V): \sigma \times_\tau \rho \rightarrow \rho$ are graph morphisms such that diagram (3.4) below commutes.

$$\begin{array}{ccc} \sigma \times_\tau \rho & \xrightarrow{\pi_\rho} & \rho \\ \pi_\sigma \downarrow & & \downarrow h \\ \sigma & \xrightarrow{g} & \tau \end{array} \quad (3.4) \qquad \begin{array}{ccc} \mu & \xrightarrow{p} & \rho \\ q \downarrow & & \downarrow h \\ \sigma & \xrightarrow{g} & \tau \end{array} \quad (3.5)$$

Consider now any graph $\mu = (F_\mu, V_\mu, \partial_\mu, j_\mu)$ and graph morphisms $p = (p_F, p_V): \mu \rightarrow \rho$ and $q = (q_F, q_V): \mu \rightarrow \sigma$ such that diagram (3.5) above commutes. For $f \in F_\mu$, let $r_F(f) = (p_F(f), q_F(f))$ and for $v \in V_\mu$, let $r_V(v) = (p_V(v), q_V(v))$. It is easy to check that it defines a graph morphism $r = (r_F, r_V): \mu \rightarrow \sigma \times_\tau \rho$ that is the unique one to factorize p and q . Therefore, $(\sigma \times_\tau \rho, \pi_\rho, \pi_\sigma)$ is the pullback of h and g .

Roughly, the pullback $\sigma \times_\tau \rho$ is obtained as a sort of “lax intersection” of the “similar” vertices of σ and ρ (they are “similar” when they are sent to the same vertex in τ , by g_V and h_V respectively), and keeping whatever flags that are in the “intersection”. So, $\sigma \times_\tau \rho$ is the maximal graph that is “compatible” with both σ and ρ .

The pullback construction lifts to directed, labeled, colored and ordered graphs.

4. MELL PROOF-STRUCTURES AND QUASI-PROOF-STRUCTURES

We present here a purely graphical definition of MELL proof-structures, following the non-inductive approach of [GPT19]: a MELL proof-structure R is essentially a labeled directed graph $|R|$ together with some additional information to identify its boxes. Our definition is completely based on standard notions (recalled in Section 3) from graph theory: it is formal (with an eye towards complete computer formalization) but avoids *ad hoc* technicalities to identify boxes. Indeed, the inductive and ordered structure of the boxes of R is recovered by means of a tree \mathcal{A}_R and a graph morphism box_R from $|R|$ to \mathcal{A}_R which allows us to recognize the content and the border of all boxes in R . We use n -ary vertices of type ? collapsing weakening, dereliction and contraction (like in [DR95]). In this way, we get a *canonical* representation of MELL proof-structures with respect to operations like associativity and commutativity of contractions, or neutrality of weakening with respect to contraction.

4.1. MELL formulæ and lists. Given a countably infinite set of propositional variables X, Y, Z, \dots , **MELL formulæ** are defined by the following inductive grammar:

$$A, B ::= X \mid X^\perp \mid \mathbf{1} \mid \perp \mid A \otimes B \mid A \wp B \mid !A \mid ?A$$

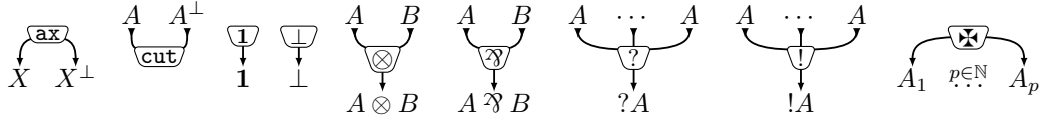

FIGURE 2. Cells, with their labels and their typed inputs and outputs.

Linear negation $(\cdot)^\perp$ is defined via De Morgan laws $\mathbf{1}^\perp = \perp$, $(A \otimes B)^\perp = A^\perp \wp B^\perp$ and $(!A)^\perp = ?A$, so as to be involutive, *i.e.* $A^{\perp\perp} = A$ for any MELL formula A . Variables and their negations are *atomic* formulas; \otimes and \wp (resp. $!$ and $?$) are *multiplicative* (resp. *exponential*) *connectives*; $\mathbf{1}$ and \perp are *multiplicative units*.

For a list $\Gamma = (A_1, \dots, A_m)$ of **MELL formulæ**, a *partition* of Γ is a list $\Gamma' = (\Gamma_1, \dots, \Gamma_n)$ of lists of **MELL formulæ** such that there are $0 = i_0 < \dots < i_n = m$ with $\Gamma_j = (A_{i_{j-1}+1}, \dots, A_{i_j})$ for all $1 \leq j \leq n$; the partition Γ' of Γ is also denoted by $(A_1, \dots, A_{i_1}; \dots; A_{i_{n-1}+1}, \dots, A_m)$, with lists separated by semi-colons. The *flattening* of Γ' is Γ . The *empty list* is denoted by ε .

4.2. Proof-structures. We define here proof-structures corresponding to some fragments or extension of LL: MELL, DiLL and DiLL₀. Full differential linear logic (DiLL) is an extension of MELL (with the same language as MELL) provided with both promotion rule (*i.e.* boxes) and co-structural rules (the duals of the structural rules handling the $?$ -modality) for the $!$ -modality: DiLL₀ and MELL are particular subsystems of DiLL, respectively the promotion-free one (*i.e.* without boxes) and the one without co-structural rules. As the study of cut-elimination is left to future work, our interest for DiLL is just to have an unitary syntax subsuming both MELL and DiLL₀: this is why, unlike [Pag09, Tra11], our DiLL proof-structures are not allowed to contain a set of DiLL proof-structures inside a box. We reuse the syntax of proof-structures given in [GPT19], based on the graph notions introduced in Section 3. Note that, unlike [PT09], we allow the presence of cuts (vertices of type **cut**).

Definition 4.1 (module, proof-structure). A (DiLL) *module* $M = (|M|, \ell, \mathbf{o}, \mathbf{c}, <)$ is a labeled (ℓ), directed (\mathbf{o}), colored (\mathbf{c}), ordered ($<$) graph $|M|$ such that:

- $\ell: V_{|M|} \rightarrow \{\mathbf{ax}, \mathbf{cut}, \mathbf{1}, \perp, \otimes, \wp, ?, !, \boxtimes\}$ associates with each vertex v its *type* $\ell(v)$;
- $\mathbf{c}: F_{|M|} \rightarrow \mathcal{F}_{\text{MELL}}$ associates with each flag f its *type* $\mathbf{c}(f)$;
- $<$ is a strict order on the flags of $|M|$ that is total on the tails of $|M|$ and on the inputs of each vertex of type \wp or \otimes ;
- for every vertex $v \in V_{|M|}$,
 - if $\ell(v) = \mathbf{cut}$, v has no output and two inputs i_1 and i_2 , such that $\mathbf{c}(i_1) = \mathbf{c}(i_2)^\perp$;
 - if $\ell(v) = \mathbf{ax}$, v has no inputs and two outputs o_1 and o_2 , with $\mathbf{c}(o_1) = \mathbf{c}(o_2)^\perp$ *atomic*;
 - if $\ell(v) \in \{\mathbf{1}, \perp\}$, v has no inputs and only one output o , with $\mathbf{c}(o) = \ell(v)$;
 - if $\ell(v) \in \{\otimes, \wp\}$, v has two inputs $i_1 < i_2$ and one output o , with $\mathbf{c}(o) = \mathbf{c}(i_1) \ell(v) \mathbf{c}(i_2)$;
 - if $\ell(v) \in \{?, !\}$, v has $n \geq 0$ inputs i_1, \dots, i_n and one output o , such that $\mathbf{c}(o) = \ell(v) \mathbf{c}(i_j)$ for all $1 \leq j \leq n$;⁸
 - if $\ell(v) = \boxtimes$, v has no inputs and $p \geq 0$ outputs o_1, \dots, o_p .⁹

In Figure 2 we depicted the corollas associated with all types of vertices.

A (DiLL) *proof-structure* is a triple $R = (|R|, \mathcal{A}, \text{box})$ where:

⁸This implies that $\mathbf{c}(i_j) = \mathbf{c}(i_k)$ for all $1 \leq j, k \leq n$.

⁹Note that there are not conditions on the number of outputs o_1, \dots, o_p or on their types.

- $|R| = (\|R\|, \ell_R, \circ_R, \mathbf{c}_R, <_R)$ is a **module** with no input tails, called the *structured graph* of R (and $\|R\| = (F_{\|R\|}, V_{\|R\|}, \partial_{\|R\|}, j_{\|R\|})$ is the *graph* of R);
- \mathcal{A} is a rooted tree with no input tails, called the *box-tree* of R ;¹⁰
- $\mathbf{box} = (\mathbf{box}_F, \mathbf{box}_V): |R| \rightarrow \mathcal{A}^\circ$ is a directed graph morphism,¹¹ called the *box-function* of R , such that \mathbf{box}_F induces a partial bijection from the set $\bigcup_{v \in V_{\|R\|}, \ell(v)=!} \mathbf{in}_{|R|}(v)$ of inputs of the vertices of type $!$ in $|R|$ and the set of inputs flags in \mathcal{A} .¹² Also, for any vertex $v \in V_{\|R\|}$ and any input f of v , if $\mathbf{box}_V(\partial_{\|R\|} \circ j_{\|R\|}(f)) \neq \mathbf{box}_V(\partial_{\|R\|}(f))$ then $\ell(v) \in \{!, ?\}$.¹³

A (DiLL) **proof-structure** $R = (|R|, \mathcal{A}, \mathbf{box})$ is said:

- (1) **MELL** if the structured graph $|R|$ has no vertices of type \boxtimes and
 - all vertices in $|R|$ of type $!$ have exactly one input;
 - the partial bijection induced by \mathbf{box}_F is total.¹⁴
- (2) **DiLL₀** (or *resource*) if \mathcal{A} contains only the root with its output, and either $|R|$ has no vertices of type \boxtimes or $|R|$ is a *daimon*, i.e. $|R|$ has only one vertex and it is of type \boxtimes .
- (3) **Empty** (which is both **DiLL₀** and **MELL**) if the *structured graph* $|R|$ and the *box-tree* \mathcal{A} are empty graphs. It is denoted by ε .

Our **MELL proof-structures** correspond to the usual notion of MELL proof-structures (as in [dCT12]). Our **DiLL₀ proof-structures** correspond to the usual notion of DiLL₀ proof-structures (as in [ER06b]) except that we allow also *daimons*. Daimons will be used in the Taylor expansion to deal with the content of a box taken 0 times (see Section 5).

Given a proof-structure $R = (|R|, \mathcal{A}, \mathbf{box})$, the output tails of $|R|$ are the *conclusions* of R . The *type* of R is the list of the types of these conclusions, ordered according to $<_{|R|}$. We often identify the conclusions of R with a finite initial segment of \mathbb{N} .

Borrowing the terminology from [ER06b, Laf90], in proof-structures, we speak of *cells* instead of vertices, and of ℓ -*cell* for a cell of type ℓ . An *hypothesis* is a cell without inputs.

Remark 4.2 (box). In our syntax, boxes do not have explicit constructors or cells, hence boxes and depth of a proof structure $R = (|R|, \mathcal{A}_R, \mathbf{box}_R)$ are recovered in a non-inductive way.

Roughly, any non-root vertex v in \mathcal{A}_R induces a subgraph of \mathcal{A}_R° made up of all vertices “above v ” with their inputs and outputs: the preimage of this subgraph through \mathbf{box}_R is

¹⁰Intuitively, \mathcal{A} represents the tree-structure of the nested boxes of R , see Remark 4.2 below.

¹¹The structured graph $|R|$ of R is more structured (it is also labeled, colored, ordered) than an oriented graph such as \mathcal{A}° . When we talk of a morphism between two structured graphs where one of the two, say σ , is less structured than the other, say τ , we mean that τ must be only considered with the same structure as σ . Thus, in this case, \mathbf{box} is a morphism from $(\|R\|, \circ_R)$ —discarding $\ell_R, \mathbf{c}_R, <_R$ —to \mathcal{A}° .

¹²It means that for any input flag f' in \mathcal{A} there is exactly one input f of some vertex of type $!$ in $|R|$ such that $\mathbf{box}_F(f) = f'$; but, for any input f of some vertex of type $!$ in $|R|$, $\mathbf{box}_F(f)$ need not be an input flag in \mathcal{A} (by definition of directed graph morphism, $\mathbf{box}_F(f)$ is necessarily an input flag in \mathcal{A}°). Intuitively, a vertex v of type $!$ represents a generalized co-contraction (in particular, a co-weakening if it has no inputs), and a box is associated with (and only with) each input f of v such that $\mathbf{box}_F(f)$ is an input flag in \mathcal{A} (and not only in \mathcal{A}°): f represents the principal door in the border of such a box (by definition of directed graph morphism, $\mathbf{box}_V(\partial_{\|R\|} \circ j_{\|R\|}(f)) \neq \mathbf{box}_V(\partial_{\|R\|}(f))$ for such a f , and if $f \neq f' \in F_{\|R\|}$ then $\mathbf{box}_F(f') \neq \mathbf{box}_F(f)$).

¹³Roughly, it says that the border of a box is made of inputs of vertices of type $!$ or $?$ in $|R|$.

¹⁴It means that for any input flag f' in \mathcal{A} there is exactly one vertex of type $!$ in $|R|$ whose unique input f is such that $\mathbf{box}_F(f) = f'$; and, if f is the (only) input some vertex of type $!$ in $|R|$, $\mathbf{box}_F(f)$ is an input flag in \mathcal{A} . Intuitively, a box is associated with (and only with) the unique input of each vertex of type $!$ in $|R|$.

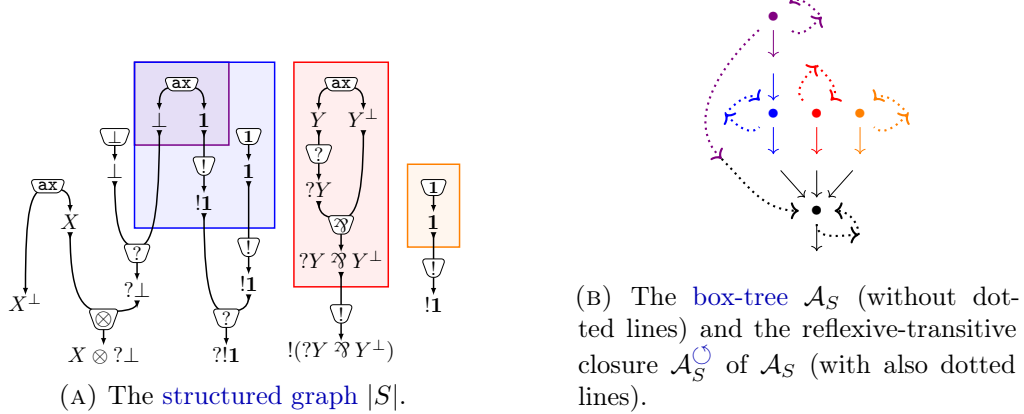

FIGURE 3. A MELL proof-structure $S = (|S|, \mathcal{A}_S, \text{box}_S)$.

the *box* of v in $|R|$. The preimage of the root of \mathcal{A}_R through box_R is the part of $|R|$ outside any box.

More precisely, with every flag f of $|R|$ such that $\text{box}_{R_F}(f)$ is an input flag of \mathcal{A}_R ¹⁵ is associated a *box* B_f , that is the subgraph of $|R|$ (which is actually a proof-structure) made up of all the cells v (with their inputs and outputs) such that there is a directed path on \mathcal{A}_R from $\text{box}_{R_V}(v)$ to $\text{box}_{R_V}(\partial_{\parallel R \parallel} \circ j_{\parallel R \parallel}(f))$ (note that f and the $!$ -cell of which f is an input are not in B_f). A *conclusion* of such a box B_f is any output flag f' in B_f such that $\partial_{\parallel R \parallel} \circ j_{\parallel R \parallel}(f')$ is not in B_f . The tree-structure of \mathcal{A}_R expresses the usual *nesting condition* of boxes: two boxes in $|R|$ are either disjoint or contained one in the other.

The *depth* of a cell v of R is the length of the directed path in \mathcal{A}_R from $\text{box}_R(v)$ to the root of \mathcal{A}_R . The *depth* of R is the maximal depth of the cells of R .

Example 4.3. In Figure 3 a MELL proof-structure $S = (|S|, \mathcal{A}_S, \text{box}_S)$ is depicted. The box-function box_S is kept implicit by means of colors: the colored areas in $|S|$ represent boxes (the preimages of non-root vertices of \mathcal{A}_S through box_S), and the same color is used on \mathcal{A}_S to show where each box is mapped by box_S .

4.3. Quasi-proof-structures. We need to consider more general structures in order to accommodate our rewrite rules, as discussed in Section 2, p. 5 (the rewrite rules are defined in Sections 6 and 7). This is why we extend all the definitions to *tuples* of proof-structures.

Definition 4.4 (quasi-proof-structure). A (DiLL) *quasi-proof-structure* is a tuple $R = (R_1, \dots, R_n)$ of proof-structures; for all $1 \leq i \leq n$, R_i is a *component* of R .

For convenience, given a proof-structure $R_i = (|R_i|, \mathcal{A}_{R_i}, \text{box}_{R_i})$ for all $1 \leq i \leq n$, we denote the quasi-proof-structure $R = (R_1, \dots, R_n)$ as $R = (|R|, \mathcal{F}_R, \text{box}_R)$, where $|R| = (|R_1|, \dots, |R_n|)$ is the *structured graph* of R , and $\mathcal{F}_R = (\mathcal{A}_{R_1}, \dots, \mathcal{A}_{R_n})$ is the *box-forest* of R , and $\text{box}_R = (\text{box}_{R_1}, \dots, \text{box}_{R_n})$ is the *box-function* of R .

A *conclusion* of R is any *conclusion* of any component of R .

¹⁵By the constraints on box_R , this condition can be fulfilled only by inputs of $!$ -cells in $|R|$, and an input of a $!$ -cell need not fulfill it; in particular, if R is a MELL proof-structure, then this condition is fulfilled by all and only the inputs of $!$ -cells (and such an input is unique for any $!$ -cell) in $|R|$; but if R is a DiLL₀ proof-structure, this condition is not fulfilled by any flag in $|R|$ (since \mathcal{A}_R has no inputs) and so box_R is a directed graph morphism associating the root of \mathcal{A}_R with any cell of R . Thus, in a DiLL₀ proof-structure $\rho = (|\rho|, \mathcal{A}_\rho, \text{box}_\rho)$, there are no boxes, \mathcal{A}_ρ and box_ρ do not induce any structure on $|\rho|$: ρ can be identified with $|\rho|$.

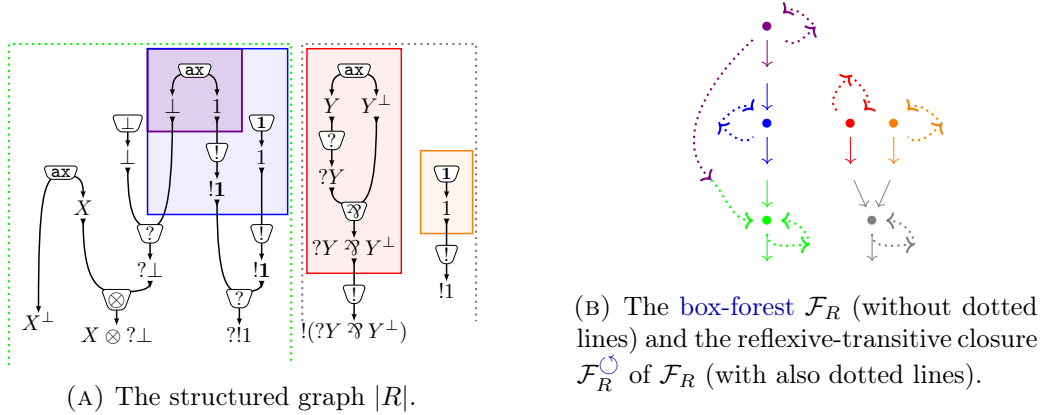

FIGURE 4. A MELL quasi-proof-structure $R = (|R|, \mathcal{F}_R, \mathbf{box}_R)$.

A quasi-proof-structure R is **MELL** (resp. **DiLL₀**) if all components of R are MELL (resp. DiLL₀) proof-structures.

The short notation $R = (|R|, \mathcal{F}_R, \mathbf{box}_R)$ for quasi-proof-structures makes sense because the structured graph $|R| = (|R_1|, \dots, |R_n|)$ can be seen as the disjoint union of its components $|R_1|, \dots, |R_n|$, and similarly for \mathcal{F} and \mathbf{box}_R . In particular, the box-forest \mathcal{F}_R is the disjoint union of the box-trees $\mathcal{A}_{R_1}, \dots, \mathcal{A}_{R_n}$ of R_1, \dots, R_n . The box-function \mathbf{box}_R locates not only the boxes on $|R|$, but also the different components of R on $|R|$.

The only delicate point is the definition of the order $<_{|R|}$ for the conclusions of the quasi-proof-structure $R = (R_1, \dots, R_n)$, given the order $<_{|R_i|}$ for each component $|R_i|$. Given the conclusions f, f' of R , we set $f <_{|R|} f'$ if either f is a conclusion of R_i and f' is a conclusion of $R_{i'}$ with $i < i'$, or f and f' are conclusions of the same component R_j and $f <_{|R_j|} f'$.

We often identify the conclusions of R with a finite initial segment of \mathbb{N} , and its order.

The *type* of a quasi-proof-structure $R = (R_1, \dots, R_n)$ is a list $\Gamma = (\Gamma_1, \dots, \Gamma_n)$ of lists of MELL formulæ such that Γ_i is the *type* of R_i for all $1 \leq i \leq n$. When $n = 1$, we often identify R and R_1 (a quasi-proof-structure with only one component and a proof-structure), or Γ and Γ_1 (the type of a quasi-proof-structure with only one component and the type of a proof-structure). So, the type of a quasi-proof-structure R determines if R is a proof-structure.

Example 4.5. The graph in Figure 4 is a MELL **quasi-proof-structure** R . The colored areas represent the pre-images of boxes, and each dashed box represents a components of R .

A subtle difference arises between DiLL₀ proof-structure and DiLL₀ quasi-proof-structure. Both do not have boxes. In the former, its box-tree and box-function do not induce any structure on its structured graph, so we can identify a DiLL₀ proof-structure with its structured graph. In the latter, its box-forest and box-function do induce some structure on its structured graph: indeed, its box-forest is made up only of roots with their output and its box-function separates the components of its structured graph, by mapping the vertices to the roots. So, we cannot identify a DiLL₀ quasi-proof-structure with its structured graph.

5. THE TAYLOR EXPANSION

The *Taylor expansion* $\mathcal{T}(R)$ [ER08] of a MELL (or more in general DiLL) proof-structure R is a possibly infinite set of DiLL₀ proof-structures: roughly, each element of $\mathcal{T}(R)$ is obtained from R by replacing each box B in R with n_B copies of its content (for some $n_B \in \mathbb{N}$),

recursively on the depth of R . Note that n_B depends not only on B but also on which “copy” of all boxes containing B we are considering. Usually, the Taylor expansion of MELL proof-structure is defined globally and inductively [MP07, PT09]: with every MELL proof-structure R is directly associated its Taylor expansion (the whole set!) by induction on the depth of R .

Following [GPT19], we adopt an alternative non-inductive approach, which strongly refines [GPT16]: the Taylor expansion is defined pointwise (see Example 5.2 and Figure 5). Indeed, proof-structures have a tree structure made explicit by their **box-function**. The definition of the Taylor expansion uses this tree structure: first, we define how to “*expand*” a tree via the notion of **thick subtree** [Bou09] (Definition 5.1; roughly, it states the number of copies of each box to be taken, recursively), we then take all the expansions of the tree structure of a proof-structure and we *pull* the approximations *back* to the underlying graphs (Definition 5.3), finally we *forget* the tree structures associated with them (Definition 5.4).

An advantage of our approach is that it smoothly generalizes to quasi-proof-structures.

Definition 5.1 (thick subtree and subforest). Let σ be a **rooted tree**. A **thick subtree** of σ is a pair (τ, h) of a rooted tree τ and a directed graph morphism $h = (h_F, h_V): \tau \rightarrow \sigma$.

Let $\sigma = (\sigma_1, \dots, \sigma_n)$ be a **forest** of **rooted trees**. A **thick subforest** of σ is a tuple $((\tau_1, h_1), \dots, (\tau_n, h_n))$ where (τ_i, h_i) is a thick subtree of σ_i for all $1 \leq i \leq n$. It is denoted by (τ, h) , where $\tau = (\tau_1, \dots, \tau_n)$ and $h = (h_1, \dots, h_n)$.

Example 5.2. The following is a graphical presentation of a **thick subforest** (τ, h) of the **box-forest** \mathcal{F} of the **quasi-proof-structure** in Figure 3, where the directed graph morphism $h = (h_F, h_V): \tau \rightarrow \mathcal{F}$ is depicted chromatically (same color means same image via h).

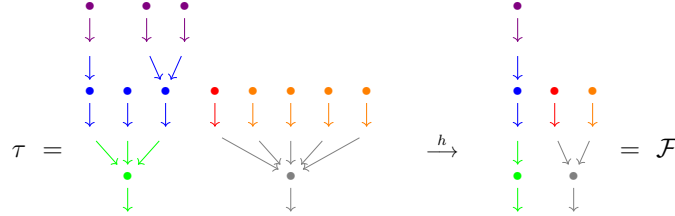

Intuitively, it means that τ is obtained from \mathcal{F} by taking 3 copies of the blue box, 1 copy of the red box and 4 copies of the orange box; in the first (resp. second; third) copy of the blue box, 1 copy (resp. 0 copies; 2 copies) of the purple box has been taken.

The crucial point is to pull back the expansion of a forest to quasi-proof-structures.

Definition 5.3 (proto-Taylor expansion). Let $R = (|R|, \mathcal{F}_R, \text{box}_R)$ be a **quasi-proof-structure**. The **proto-Taylor expansion** of R is the set $\mathcal{T}^{\text{proto}}(R)$ of thick subforests of \mathcal{F}_R .

Let $t = (\tau_t, h_t) \in \mathcal{T}^{\text{proto}}(R)$. The **t -expansion** of R is the **pullback** (R_t, p_t, p_R) below, computed in the category of directed graphs and directed graph morphisms.¹⁶

$$\begin{array}{ccc}
 R_t & \xrightarrow{p_t} & \tau_t^\circ \\
 p_R \downarrow & \lrcorner & \downarrow h_t^\circ \\
 |R| & \xrightarrow{\text{box}_R} & \mathcal{F}_R^\circ
 \end{array}$$

¹⁶So, $|R|$ is considered as directed graph (see Footnote 11), forgetting that it is colored, labeled, ordered.

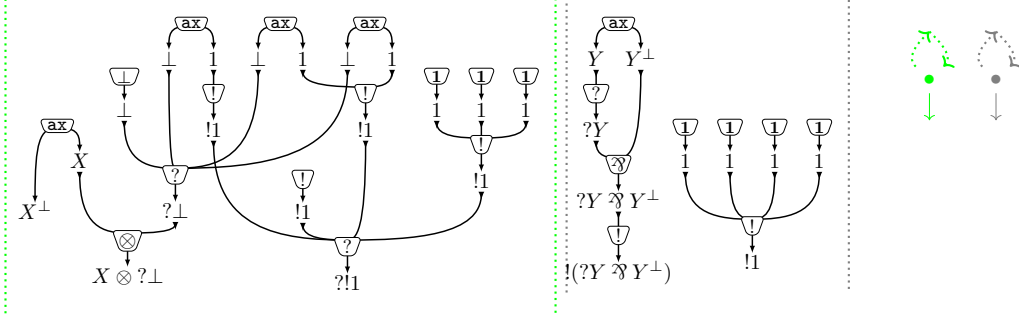

FIGURE 5. The element ρ of the Taylor expansion of the MELL quasi-proof-structure R in Figure 4 obtained from the element of $\mathcal{T}^{\text{proto}}(R)$ in Example 5.2.

Given a quasi-proof-structure R and $t = (\tau_t, h_t) \in \mathcal{T}^{\text{proto}}(R)$, the directed graph R_t inherits the types of its vertices and flags by pre-composition of $\ell_{|R|}$ and $\mathbf{c}_{|R|}$ with the graph morphism $p_R: R_t \rightarrow |R|$. The order on the flags of R_t is induced by the one on $|R|$ via p_R .

Let $[\tau_t]$ be the forest made up of the roots of τ_t and $\iota: \tau_t \rightarrow [\tau_t]$ be the graph morphism sending each vertex of τ_t to the root below it; ι° induces by post-composition a morphism $\overline{h}_t = \iota^\circ \circ p_t: R_t \rightarrow [\tau_t]^\circ$. The triple $(R_t, [\tau_t], \overline{h}_t)$ is a DiLL_0 quasi-proof-structure, and it is a DiLL_0 proof-structure if R is a proof-structure. We can then define the *Taylor expansion* $\mathcal{T}(R)$ of a quasi-proof-structure R (an example of an element of a Taylor expansion is in Figure 5).

Definition 5.4 (Taylor expansion). Let R be a quasi-proof-structure. The *Taylor expansion* of R is the set of DiLL_0 quasi-proof-structures $\mathcal{T}(R) = \{(R_t, [\tau_t], \overline{h}_t) \mid t = (\tau_t, h_t) \in \mathcal{T}^{\text{proto}}(R)\}$.

An element $(R_t, [\tau_t], \overline{h}_t)$ of the Taylor expansion of a quasi-proof-structure R has much less structure than the pullback (R_t, p_t, p_R) : the latter indeed is a DiLL_0 quasi-proof-structure R_t coming with its projections $|R| \xleftarrow{p_R} R_t \xrightarrow{p_t} \tau_t^\circ$, which establish a precise correspondence between cells and flags of R_t and cells and flags of R : a cell in R_t is labeled (via the projections) by both the cell of $|R|$ and the branch of the box-forest of R it arose from. But $(R_t, [\tau_t], \overline{h}_t)$ where R_t is without its projections p_t and p_R loses the correspondence with R .

Remark 5.5 (conclusions). From the definition, it follows the Taylor expansion preserves conclusions and type: each element of the Taylor expansion of a quasi-proof-structure R has the *same conclusions* and the *same type* as R . More precisely, there is a bijection φ from the conclusions of a quasi-proof-structure R to the ones in each element ρ of $\mathcal{T}(R)$ such that i and $\varphi(i)$ have the same type and the same root (*i.e.* $\text{box}_R(i) = \text{box}_\rho(\varphi(i))$) up to isomorphism). Therefore, the types of R and ρ are the same (as a list of lists).

5.1. The filled Taylor expansion. As discussed in Section 2 (p. 6), the rewriting rules we will introduce in Section 6 method needs to “represent” the emptiness introduced by the Taylor expansion (taking 0 copies of a box) so as to preserve the conclusions. So, an element of the *filled Taylor expansion* $\mathcal{T}^\star(R)$ of a quasi-proof-structure R (an example is in Figure 6) is obtained from an element of $\mathcal{T}(R)$ where some **components** can be erased and replaced by **daimons** with the same conclusions (hence $\mathcal{T}(R) \subseteq \mathcal{T}^\star(R)$).

Definition 5.6 (filled Taylor expansion). An *emptying* of a DiLL_0 quasi-proof-structure $\rho = (|\rho|, \mathcal{A}, \text{box})$ is the DiLL_0 quasi-proof-structure with the same conclusions as ρ , obtained from ρ by replacing some *component* of ρ with a *daimon* with the same outputs tails.

The *filled Taylor expansion* $\mathcal{T}^{\boxtimes}(R)$ of a quasi-proof-structure R is the set of all the emptyings of every element of its Taylor expansion $\mathcal{T}(R)$.

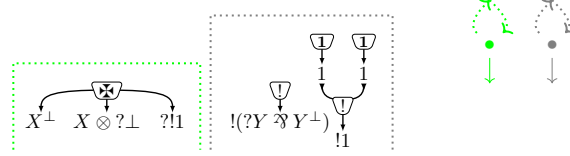

FIGURE 6. An element of the filled Taylor expansion of the MELL quasi-proof-structure R in Figure 4, obtained as an emptying of ρ in Figure 5.

6. MEANS OF DESTRUCTION: UNWINDING MELL QUASI-PROOF-STRUCTURES

Our aim is to deconstruct (MELL or DiLL_0) proof-structures from their conclusions. To do that, we introduce the category of schedulings. The arrows of this category are sequences of deconstructing rules, acting on lists of lists of MELL formulæ. These arrows act through functors on quasi-proof-structures, exhibiting their sequential structure.

Definition 6.1 (the category **Sched**). Let **Sched** be the category of *schedulings* whose

- objects are lists $\Gamma = (\Gamma_1; \dots; \Gamma_n)$ of lists of MELL formulæ;
- arrows are freely generated by composition of the *elementary schedulings* in Figure 7.

We call a *scheduling* any arrow $\xi: \Gamma \rightarrow \Gamma'$. We write the composition of schedulings by juxtaposition in the diagrammatic order; so, if $\xi: \Gamma \rightarrow \Gamma'$ and $\xi': \Gamma' \rightarrow \Gamma''$, then $\xi\xi': \Gamma \rightarrow \Gamma''$.

Example 6.2. $\wp_1 \wp_2 \wp_3 \otimes_1 \otimes_3 \text{exc}_1 \text{exc}_2 \text{mix}_2, \text{ax}_1 \text{exc}_2 \text{mix}_2 \text{ax}_1 \text{ax}_1$ is a scheduling from $((X \otimes Y^\perp) \wp ((Y \otimes Z^\perp) \wp (X^\perp \wp Z)))$ to the empty list ε of lists of MELL formulæ.

The category **Sched** acts on MELL quasi-proof-structures, exhibiting a sequential structure in their construction. For Γ a list of lists of MELL formulæ, $\text{qMELL}(\Gamma)$ is the set of MELL quasi-proof-structures of type Γ . To ease the reading of the rewrite rules acting on a MELL quasi-proof-structures R , we only draw the relevant component of R and omit the components left unchanged; *e.g.*, if we consider an **ax**-cell whose outputs are the conclusions

i and $i+1$, and it is the only cell in a component, we write $\begin{array}{c} \boxed{\text{ax}} \\ \downarrow \\ i \quad i+1 \end{array}$ ignoring the rest of R .

Definition 6.3 (action of schedulings on MELL quasi-proof-structures). An *elementary scheduling* $a: \Gamma \rightarrow \Gamma'$ defines a relation $\overset{a}{\rightsquigarrow} \subseteq \text{qMELL}(\Gamma) \times \text{qMELL}(\Gamma')$, called the *action* of a , as the smallest relation containing all the cases in Figure 8, with the following remarks:

- exchange:** it swaps the order between two consecutive conclusions in the same component.
- mix:** read in reverse, a quasi-proof-structure with two components is in relation with a quasi-proof-structure with the same *module* but the two *roots* of such *components* merged.
- hypothesis:** if $a \in \{\text{ax}_i, \mathbf{1}_i, \perp_i, \text{?}_i\}$, the rules have all in common to act by deleting a *cell* without inputs that is the only cell in its *component*. We have drawn the axiom case in Figure 8c, the others vary only by their number of conclusions.

$$\begin{array}{l}
(\Gamma_1; \dots; \Gamma_k, \mathbf{c}(i), \mathbf{c}(i+1), \Gamma'_k; \dots; \Gamma_n) \xrightarrow{\text{exc}_i} (\Gamma_1; \dots; \Gamma_k, \mathbf{c}(i+1), \mathbf{c}(i), \Gamma'_k; \dots; \Gamma_n) \\
(\Gamma_1; \dots; \Gamma_k, \mathbf{c}(i), \mathbf{c}(i+1), \Gamma'_k; \dots; \Gamma_n) \xrightarrow{\text{mix}_i} (\Gamma_1; \dots; \Gamma_k, \mathbf{c}(i); \mathbf{c}(i+1), \Gamma'_k; \dots; \Gamma_n) \\
(\Gamma_1; \dots; \Gamma_k; \mathbf{c}(i), \mathbf{c}(i+1); \Gamma_{k+2}; \dots; \Gamma_n) \xrightarrow{\text{ax}_i} (\Gamma_1; \dots; \Gamma_k; \Gamma_{k+2}; \dots; \Gamma_n) \text{ with } \mathbf{c}(i) = \mathbf{c}(i+1)^\perp \\
(\Gamma_1; \dots; \Gamma_k; \dots; \Gamma_n) \xrightarrow{\text{cut}^i} (\Gamma_1; \dots; \Gamma_k, \mathbf{c}(i), \mathbf{c}(i+1); \dots; \Gamma_n) \text{ with } \mathbf{c}(i) = \mathbf{c}(i+1)^\perp \\
(\Gamma_1; \dots; \Gamma_k; \mathbf{c}(i); \Gamma_{k+2}; \dots; \Gamma_n) \xrightarrow{\mathbf{1}_i} (\Gamma_1; \dots; \Gamma_k; \Gamma_{k+2}; \dots; \Gamma_n) \text{ with } \mathbf{c}(i) = \mathbf{1} \\
(\Gamma_1; \dots; \Gamma_k; \mathbf{c}(i); \Gamma_{k+2}; \dots; \Gamma_n) \xrightarrow{\perp_i} (\Gamma_1; \dots; \Gamma_k; \Gamma_{k+2}; \dots; \Gamma_n) \text{ with } \mathbf{c}(i) = \perp \\
(\Gamma_1; \dots; \Gamma_k, \mathbf{c}(i); \dots; \Gamma_n) \xrightarrow{\otimes_i} (\Gamma_1; \dots; \Gamma_k, A, B; \dots; \Gamma_n) \text{ with } \mathbf{c}(i) = A \otimes B \\
(\Gamma_1; \dots; \Gamma_k, \mathbf{c}(i); \dots; \Gamma_n) \xrightarrow{\wp_i} (\Gamma_1; \dots; \Gamma_k, A, B; \dots; \Gamma_n) \text{ with } \mathbf{c}(i) = A \wp B \\
(\Gamma_1; \dots; \Gamma_k, \mathbf{c}(i); \dots; \Gamma_n) \xrightarrow{?_i} (\Gamma_1; \dots; \Gamma_k, ?A, ?A; \dots; \Gamma_n) \text{ with } \mathbf{c}(i) = ?A \\
(\Gamma_1; \dots; \Gamma_k, \mathbf{c}(i); \dots; \Gamma_n) \xrightarrow{?_i} (\Gamma_1; \dots; \Gamma_k, A; \dots; \Gamma_n) \text{ with } \mathbf{c}(i) = ?A \\
(\Gamma_1; \dots; \Gamma_k; \mathbf{c}(i); \Gamma_{k+2}; \dots; \Gamma_n) \xrightarrow{?_i} (\Gamma_1; \dots; \Gamma_k; \Gamma_{k+2}; \dots; \Gamma_n) \text{ with } \mathbf{c}(i) = ?A \\
(\Gamma_1; \dots; ?\Gamma_k, \mathbf{c}(i); \dots; \Gamma_n) \xrightarrow{\text{Box}_i} (\Gamma_1; \dots; ?\Gamma_k, A; \dots; \Gamma_n) \text{ with } \mathbf{c}(i) = !A
\end{array}$$

FIGURE 7. The generators of **Sched**. In the source $\Gamma = (\Gamma_1; \dots; \Gamma_n)$ of each arrow, $\mathbf{c}(i)$ is the i^{th} formula in the **flattening** of Γ (the rule keeps track of i).

cut: read in reverse, a quasi-proof-structure with two conclusions i and $i+1$ is in relation with the quasi-proof-structure where these two conclusions are cut by a **cut-cell** of **depth** 0. This rule, from left to right, is non-deterministic (as there are many possible cuts).

binary multiplicatives: these rules delete a binary multiplicative connective. We have only drawn the \otimes case in Figure 8e, the \wp case is similar.

contraction: it splits a **?-cell** with $h+k+2$ inputs into two **?-cells** with $h+1$ and $k+1$ inputs, respectively. This rule, from left to right, is non-deterministic.

dereliction: it only applies if the **?-cell** (with 1 input) does not shift a level in the **box-forest**, *i.e.* it is not just outside a **box**.

box: it only applies if a box (and its border) is alone in its **component**.

The rewrite relation is extended by composition of relations to define, for any **scheduling** $\xi: \Gamma \rightarrow \Gamma'$, a relation $\overset{\xi}{\rightsquigarrow} \subseteq \mathbf{qMELL}(\Gamma) \times \mathbf{qMELL}(\Gamma')$, called the **action** of ξ .

Except **mix**, the **action** of an **elementary scheduling** is a rewrite rule on quasi-proof-structures that destroys either a **cut-cell** of **depth** 0 or a cell whose output is a conclusion. The **action of a scheduling** is just a composition of these rewrite rules.

Among the **actions of elementary schedulings** in Figure 8, the cases **mix**, **box** and **hypothesis** are the only ones that change the **box-forest** of a quasi-proof-structure: **mix** splits a tree in two distinct trees by splitting its root, **box** merges a root of a tree with a non-root vertex just above it, while **hypothesis** discards a tree made up only of a root with its output. For instance, the action mix_i rewrites the **MELL** proof-structure S in Figure 3 into the **MELL** quasi-proof-structure R in Figure 4, when i is the conclusion of S of type **?!1**.

We can see **actions of schedulings** as arrows in the category **Rel** of set and relations.

Definition 6.4 (functor **qMELL**). We define a functor **qMELL: Sched** \rightarrow **Rel** by:

- *on objects*: $\mathbf{qMELL}(\Gamma)$ is the set of **MELL** quasi-proof-structures of type Γ ;
- *on arrows*: for any $\xi: \Gamma \rightarrow \Gamma'$, $\mathbf{qMELL}(\xi)$ is $\overset{\xi}{\rightsquigarrow}: \mathbf{qMELL}(\Gamma) \rightarrow \mathbf{qMELL}(\Gamma')$ (Definition 6.3).

Our rewrite rules have two useful properties, expressed by Lemma 6.5 and Proposition 6.7.

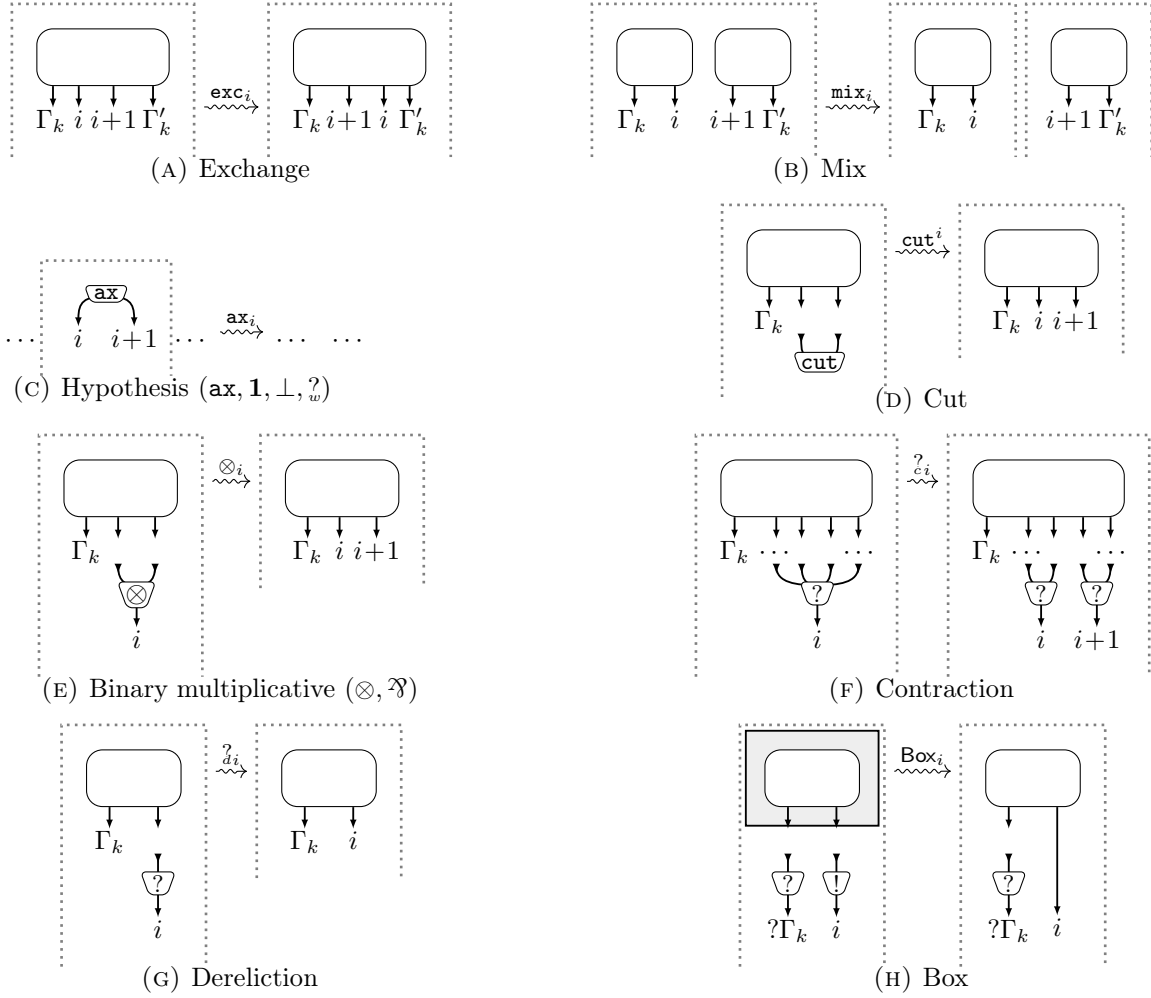

FIGURE 8. Actions of elementary schedulings on MELL quasi-proof-structures.

Lemma 6.5 (co-functionality). *Let $\xi: \Gamma \rightarrow \Gamma'$ be a scheduling. The action ξ of ξ is a co-function from $\mathbf{qMELL}(\Gamma)$ to $\mathbf{qMELL}(\Gamma')$, that is, a function $\xi_{\text{op}}^{\xi}: \mathbf{qMELL}(\Gamma') \rightarrow \mathbf{qMELL}(\Gamma)$.*

Given two MELL quasi-proof-structures R and R' , we say that an **elementary scheduling** a *applies* to R if there are elementary schedulings $\text{exc}_{i_1}, \dots, \text{exc}_{i_n}$ such that $R \xrightarrow{\text{exc}_{i_1} \dots \text{exc}_{i_n} a} R'$.

Lemma 6.6 (applicability of actions). *Let R be a non-empty MELL quasi-proof-structure. Then either $R \xrightarrow{m^i} R'$ or an elementary scheduling in $\{\mathbf{ax}_i, \mathbf{1}_i, \perp_i, \otimes_i, \wp_i, ?_c^i, ?_d^i, ?_w^i, \text{cut}^i, \text{Box}_i\}$ applies to R , for some conclusion i of R (or some input i of a cut-cell of depth 0 in R).*

Lemmas 6.5 and 6.6 are proven by simple inspection of the rewrite rules of Figure 8.

Proposition 6.7 (termination). *Let R be a MELL quasi-proof-structure of type Γ . Then, there exists a scheduling $\xi: \Gamma \rightarrow \varepsilon$ such that $R \xrightarrow{\xi} \varepsilon$.*

Proof. By Lemma 6.6, it is enough show that the size of MELL quasi-proof-structures is left unchanged by mix_i and strictly decreases for each other action in Figure 8, according to the following definition of size. The *size* of a quasi-proof-structure R is the triple (p, q, r) where

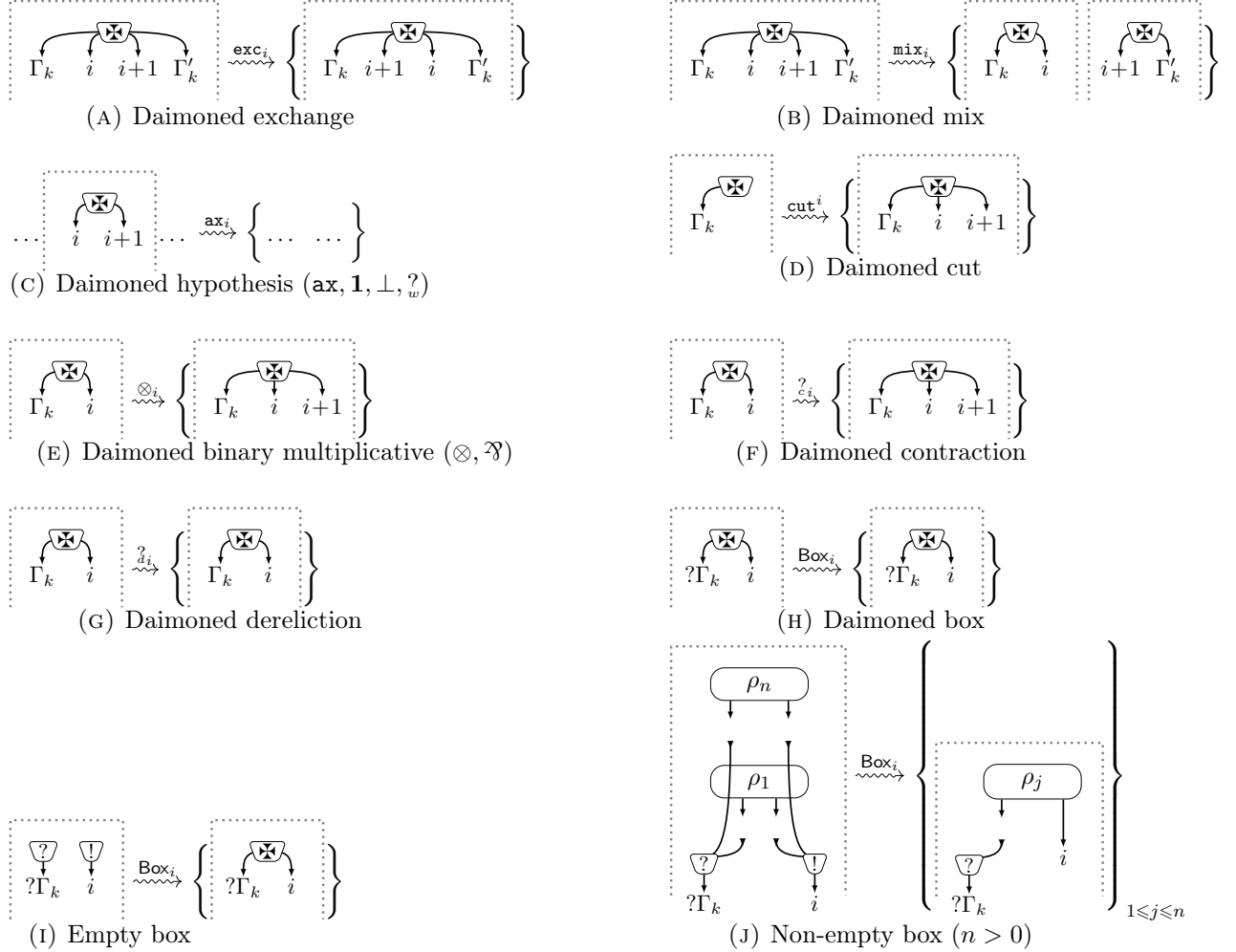
FIGURE 9. Actions of elementary schedulings on DiLL_0 quasi-proof-structures.

- p is the (finite) multiset of the number of inputs of each $?$ -cell in R ;
- q is the number of cells in R ;
- r is the (finite) multiset of the number of **conclusions** of each **component** of R .

Multisets are well-ordered as usual, triples are well-ordered lexicographically. \square

The action of a scheduling ξ such that $R \xrightarrow{\xi} \varepsilon$, read in reverse from right to left, can be seen as a sequentialization of elementary steps to build R from the empty proof-structure ε .

7. NATURALITY OF UNWINDING DiLL_0 QUASI-PROOF-STRUCTURES

We show here how the actions of schedulings act on DiLL_0 quasi-proof-structures, mimicking the behavior of the actions of schedulings on MELL quasi-proof-structures seen in Section 6. **Schedulings** are the same, the novelty is that DiLL_0 have no boxes and might have daimons.

For Γ a list of lists of MELL formulæ, $\mathbf{qDiLL}_0(\Gamma)$ is the set of DiLL_0 quasi-proof-structures of type Γ . For any set X , its powerset is denoted by $\wp(X)$.

Definition 7.1 (action of schedulings on DiLL_0 quasi-proof-structures). An **elementary scheduling** $a: \Gamma \rightarrow \Gamma'$ defines a relation $\rightsquigarrow \subseteq \text{qDiLL}_0(\Gamma) \times \mathfrak{P}(\text{qDiLL}_0(\Gamma'))$, called the **action** of a , as the smallest relation containing all the rules in Figure 8—except Figure 8h, and with the same remarks—and in Figure 9. We extend it to a relation on $\mathfrak{P}(\text{qDiLL}_0(\Gamma)) \times \mathfrak{P}(\text{qDiLL}_0(\Gamma'))$ by the monad multiplication of $X \mapsto \mathfrak{P}(X)$.¹⁷ The rewrite relation on $\mathfrak{P}(\text{qDiLL}_0(\Gamma)) \times \mathfrak{P}(\text{qDiLL}_0(\Gamma'))$ is extended by composition of relations to define, for any **scheduling** $\xi: \Gamma \rightarrow \Gamma'$, a relation $\rightsquigarrow^\xi: \mathfrak{P}(\text{qDiLL}_0(\Gamma)) \rightarrow \mathfrak{P}(\text{qDiLL}_0(\Gamma'))$, called the **action** of ξ .

Roughly, all the rewrite rules in Figure 9—except Figures 9i and 9j—mimic the behavior of the corresponding rule in Figure 8 using a \boxtimes -cell. The **action** in Figure 9i creates a \boxtimes -cell: erasing a co-weakening (a $!$ -cell without inputs) with output of type $!A$ would make lose the information about the type A , this is why a \boxtimes -cell is needed. Intuitively, a co-weakening represents a box taken 0 times, so there is no information about the content of the box. The daimon is a “universal” DiLL_0 proof-structure representing information plainly missing.

The **action** in Figure 9j requires that, on the left of $\overset{\text{Box}_i}{\rightsquigarrow}$, ρ_j is not connected to $\rho_{j'}$ for $j \neq j'$, except for the $!$ -cell and the $?$ -cells in the conclusions. Read in reverse, the rule associates with a non-empty finite set of DiLL_0 quasi-proof-structures $\{\rho_1, \dots, \rho_n\}$ the merging of ρ_1, \dots, ρ_n , that is the DiLL_0 quasi-proof-structure depicted on the left of $\overset{\text{Box}_i}{\rightsquigarrow}$. Intuitively, ρ_1, \dots, ρ_n represent $n > 0$ possible copies of a box, which then have to be analyzed “in parallel”: this is why the **action** rewrites to a *set* of DiLL_0 quasi-proof-structures.

Note that a \boxtimes -cell can be erased only by the **action of elementary scheduling** $\text{ax}_i, \mathbf{1}_i, \perp_i, ?_{w_i}$.

Definition 7.2 (functor $\mathfrak{P}\text{qDiLL}_0$). We define a functor $\mathfrak{P}\text{qDiLL}_0: \mathbf{Sched} \rightarrow \mathbf{Rel}$ by:

- *on objects*: for Γ a list of lists of MELL formulæ, $\mathfrak{P}\text{qDiLL}_0(\Gamma) = \mathfrak{P}(\text{qDiLL}_0(\Gamma))$, the set of sets of DiLL_0 quasi-proof-structures of type Γ ;
- *on arrows*: for any $\xi: \Gamma \rightarrow \Gamma'$, $\mathfrak{P}\text{qDiLL}_0(\xi)$ is $\rightsquigarrow^\xi: \mathfrak{P}\text{qDiLL}_0(\Gamma) \rightarrow \mathfrak{P}\text{qDiLL}_0(\Gamma')$ (Def. 7.1).

We can now compare the functors qMELL and $\mathfrak{P}\text{qDiLL}_0$ from \mathbf{Sched} to \mathbf{Rel} .

Theorem 7.3 (naturality). *The filled Taylor expansion defines a natural transformation*

$$\mathfrak{T}^{\boxtimes}: \mathfrak{P}\text{qDiLL}_0 \Rightarrow \text{qMELL}: \mathbf{Sched} \rightarrow \mathbf{Rel}$$

by: for Γ a list of lists of formulæ, $(\Pi, R) \in \mathfrak{T}^{\boxtimes}$ iff $\emptyset \neq \Pi \subseteq \mathcal{T}^{\boxtimes}(R)$ and the type of R is Γ .

In other words, diagram (7.1) below commutes for every scheduling $\xi: \Gamma \rightarrow \Gamma'$.

$$\begin{array}{ccc} \mathfrak{P}\text{qDiLL}_0(\Gamma) & \xrightarrow{\mathfrak{P}\text{qDiLL}_0(\xi)} & \mathfrak{P}\text{qDiLL}_0(\Gamma') \\ \mathfrak{T}^{\boxtimes} \downarrow & & \downarrow \mathfrak{T}^{\boxtimes} \\ \text{qMELL}(\Gamma) & \xrightarrow{\text{qMELL}(\xi)} & \text{qMELL}(\Gamma') \end{array} \quad (7.1) \quad \begin{array}{ccc} \Pi & \rightsquigarrow^\xi & \Pi' \\ \mathfrak{T}^{\boxtimes} \downarrow & & \downarrow \mathfrak{T}^{\boxtimes} \\ R & \rightsquigarrow^\xi & R' \end{array} \quad (7.2) \quad \begin{array}{ccc} \Pi & \rightsquigarrow^\xi & \Pi' \\ \mathfrak{T}^{\boxtimes} \downarrow & & \downarrow \mathfrak{T}^{\boxtimes} \\ R & \rightsquigarrow^\xi & R' \end{array} \quad (7.3)$$

That is, given $\Pi \rightsquigarrow^\xi \Pi'$ with $\emptyset \neq \Pi' \subseteq \mathcal{T}^{\boxtimes}(R')$, we can simulate backwards the rewriting to R (here the co-functionality of actions on qMELL expressed by Lemma 6.5 comes handy) so that $R \rightsquigarrow^\xi R'$ and $\Pi \subseteq \mathcal{T}^{\boxtimes}(R)$ (square (7.2)); and conversely, given $R \rightsquigarrow^\xi R'$, we can simulate the rewriting for any $\emptyset \neq \Pi \subseteq \mathcal{T}^{\boxtimes}(R)$, so that $\Pi \rightsquigarrow^\xi \Pi'$ for some $\Pi' \subseteq \mathcal{T}^{\boxtimes}(R')$ (square (7.3)). Note that, in both squares, the same kind of action is performed on DiLL_0 and on MELL .

¹⁷It means that, given $\Pi, \Pi' \subseteq \text{qDiLL}_0(\Gamma)$, if $\Pi \rightsquigarrow \Pi'$ then $\Pi' = \bigcup \{\rho' \subseteq \text{qDiLL}_0(\Gamma) \mid \text{there is } \rho \in \Pi \text{ such that } \rho \rightsquigarrow \rho'\}$ and $\rho \rightsquigarrow \rho' \subseteq \Pi'$ for every $\rho \in \Pi$.

Proof. $\mathfrak{S}^{\mathfrak{X}}$ is a family of arrows of **Rel** indexed by the objects in **Sched**. We have to show that squares (7.2)–(7.3) commute for any scheduling $\xi: \Gamma \rightarrow \Gamma'$, and actually, it is enough to show commutation for elementary schedulings. Let $a: \Gamma \rightarrow \Gamma'$ be an elementary scheduling.

(1) *Square (7.3):* Let us prove that $\mathbf{qMELL}(a) \circ \mathfrak{S}_{\Gamma}^{\mathfrak{X}} \subseteq \mathfrak{S}_{\Gamma'}^{\mathfrak{X}} \circ \mathfrak{PqDiLL}_0(a)$.

Let $(\Pi, R') \in \mathbf{qMELL}(a) \circ \mathfrak{S}_{\Gamma}^{\mathfrak{X}}$. Let $R = (|R|, \mathcal{F}, \text{box}) \in \mathbf{qMELL}(\Gamma)$ be a witness of composition, that is an element such that $(\Pi, R) \in \mathfrak{S}_{\Gamma}^{\mathfrak{X}}$ and $R \xrightarrow{\mathfrak{S}} R'$.

Let $p: t \rightarrow \mathcal{F}$ be a **thick subforest** of \mathcal{F} , let r_1, \dots, r_n be some roots of \mathcal{F} , and let $\rho_{r_1 \dots r_n} \in \Pi$ be the element of the **filled Taylor expansion** $\mathcal{T}^{\mathfrak{X}}(R)$ of R associated with p and r_1, \dots, r_n (*i.e.* $\rho_{r_1 \dots r_n}$ is the emptying on the components r_1, \dots, r_n of the element of $\mathcal{T}(R)$ obtained via the thick subforest (t, p) of \mathcal{F}). By Remark 5.5 and the definition of emptying, we can identify the conclusions of R and $\rho_{r_1 \dots r_n}$. The case $a = \text{exc}_i$ is trivial since it just swaps the order of two consecutive conclusions. Other cases for a :

- If $a = \text{mix}_i$, then, in R , the conclusions $1, \dots, i, i+1, \dots, k$ are exactly the conclusions of a root in the box-forest of R , and i and $i+1$ are not connected in R (seen as an undirected graph, *i.e.* in $\|R\|$). By Definitions 5.4 and 5.6, since $\rho_{r_1 \dots r_n} \in \Pi \subseteq \mathcal{T}^{\mathfrak{X}}(R)$, we have that the conclusions $1, \dots, i, i+1, \dots, k$ are exactly the conclusions of a root r in the box-forest of $\rho_{r_1 \dots r_n}$, and we have two possibilities:
 - the connected components of i and $i+1$ are disjoint in $\rho_{r_1 \dots r_n}$;
 - i and $i+1$ belong to the same connected component, in which case $r \in \{r_1, \dots, r_n\}$ and $\rho_{r_1 \dots r_n}$ is a \mathfrak{X} -cell with conclusion $1, \dots, i, i+1, \dots, k$.

In both cases the rule mix_i is also applicable in $\rho_{r_1 \dots r_n}$, yielding a DiLL_0 quasi-proof-structure ρ' . The box-forest \mathcal{F}' of R' is obtained from the box-forest \mathcal{F} of R by replacing a root b by two roots b_1, b_2 . Let $p': t' \rightarrow \mathcal{F}'$ be such that all the boxes $d \neq b_1, b_2$ have the same inverse image than by p : $p'^{-1}(d) = p^{-1}(d)$, and, $p'^{-1}(b_1) = p^{-1}(b) \times \{1\}$, $p'^{-1}(b_2) = p^{-1}(b) \times \{2\}$. We verify that ρ' is the element of the filled Taylor expansion $\mathcal{T}^{\mathfrak{X}}(R')$ of R' through p' .

- If $a \in \{\text{ax}_i, \mathbf{1}_i, \perp_i, \text{?}_{wi}\}$, let k be such that the rule a acts on the conclusions $i-k, \dots, i$ in R ($k \in \{0, 1\}$), and let ℓ be the type of the cell in R whose outputs are $i-k, \dots, i$. In $\rho_{r_1 \dots r_n}$ there is a cell of type ℓ or \mathfrak{X} whose outputs are the same conclusions. Clearly a is applicable to $\rho_{r_1 \dots r_n}$, which yields a DiLL_0 quasi-proof-structure ρ' . The box-forest \mathcal{F}' of R' is obtained from the box-forest \mathcal{F} of R by erasing a root b . Let $p': t' \rightarrow \mathcal{F}'$ be such that all the boxes $d \neq b$ have the same inverse image than by p : $p'^{-1}(d) = p^{-1}(d)$. We verify that ρ' is the element of the filled Taylor expansion $\mathcal{T}^{\mathfrak{X}}(R')$ of R' through p' .

- If $a \in \{\otimes_i, \mathfrak{X}_i, \text{?}_{di}, \text{?}_{ci}\}$, let k be such that the rule a acts on the conclusions $i-k, \dots, i$ in R , and let ℓ be the type of the cell in R whose output is the conclusion i . In $\rho_{r_1 \dots r_n}$ there is a cell of type ℓ or \mathfrak{X} whose outputs are the same conclusions. Clearly a is applicable to $\rho_{r_1 \dots r_n}$, which yields a DiLL_0 quasi-proof-structure ρ' .

R' has the same box-forest \mathcal{F} as R . We verify that ρ' is the element of the filled Taylor expansion $\mathcal{T}^{\mathfrak{X}}(R')$ of R' through p .

- If $a = \text{cut}^i$, let c be the **cut-cell** of depth 0 in R to which the rule is applied. The **cut-cell** c has either one image in $\rho_{r_1 \dots r_n}$ or is represented by a \mathfrak{X} -cell. In both cases, cut^i is applicable to $\rho_{r_1 \dots r_n}$, yielding ρ' .

R' has the same box-forest \mathcal{F} as R . We verify that ρ' is the element of the filled Taylor expansion $\mathcal{T}^{\mathfrak{X}}(R')$ of R' through p .

- If $a = \mathbf{Box}_i$, let k be such that the rule a acts on the conclusions $i - k, \dots, i$ in R . In $\rho_{r_1 \dots r_n}$ we have one of the following possibilities:
 - $\rho_{r_1 \dots r_n}$ consists of a unique \boxtimes -cell with the same conclusions $i - k, \dots, i$;
 - $\rho_{r_1 \dots r_n}$ consists of a $!$ -cell in i with no premises and k $?$ -cells with no premises above the other k conclusions;
 - there is a $!$ -cell above the conclusion i and a $?$ -cell above each of the other k conclusions; and the other cells of this root can be identified by their image $1, \dots, \ell$ in t : we have ℓ pairwise disconnected sub-quasi-proof-structures π_1, \dots, π_ℓ .

In any case, the rule \mathbf{Box}_i can be applied, yielding either a family $\rho'_1, \dots, \rho'_\ell$ of \mathbf{DiLL}_0 proof-structures or a \mathbf{DiLL}_0 quasi-proof-structure ρ'_1 . More precisely, in the first (resp. second, third) case, we apply the Daimoned (resp. Empty, Non-empty) box rule, see Figure 9h (resp. Figure 9i, Figure 9j).

The box-forest \mathcal{F}' of R' is obtained from the box-forest \mathcal{F} of R by erasing the root of the conclusions $i - k, \dots, i$: the new root b' of this tree of \mathcal{F}' is the unique vertex connected to the root of \mathcal{F} (its unique son). We have $p^{-1}(b') = \{b'_1, \dots, b'_\ell\}$, and ℓ trees t'_1, \dots, t'_ℓ , where b'_i is the root of t'_i . The morphisms $p'_i : t'_i \rightarrow \mathcal{F}'$ are defined accordingly, and ρ'_i is the element of filled Taylor expansion $\mathcal{T}^{\boxtimes}(R')$ of R' through p'_i .

- (2) *Square (7.2)*: Let us prove that $\mathfrak{T}_{\Gamma'}^{\boxtimes} \circ \mathfrak{PqDiLL}_0(a) \subseteq \mathbf{qMELL}(a) \circ \mathfrak{T}_{\Gamma}^{\boxtimes}$.

Let $(\Pi, R') \in \mathfrak{T}_{\Gamma'}^{\boxtimes} \circ \mathfrak{PqDiLL}_0(a)$. Let Π' be a witness of composition, that is a set of $\mathfrak{PqDiLL}_0(\Gamma')$ such that $(\Pi, \Pi') \in \mathfrak{PqDiLL}_0(a)$ and $(\Pi', R') \in \mathfrak{T}_{\Gamma'}^{\boxtimes}$.

We want to exhibit a \mathbf{MELL} quasi-proof-structure R such that $R \xrightarrow{\mathfrak{A}} R'$ and Π is a part of the filled Taylor expansion $\mathcal{T}^{\boxtimes}(R)$ of R . By co-functionality of $\mathbf{qMELL}(a)$ (Lemma 6.5), we have a candidate for such an R : the pre-image of R' by this co-functional relation $\xrightarrow{\mathfrak{A}}$. In other terms: if $a : \Gamma \rightarrow \Gamma'$ and $R' \in \mathbf{qMELL}(\Gamma')$, then there exists a unique $R \in \mathbf{qMELL}(\Gamma)$ such that $R \xrightarrow{\mathfrak{A}} R'$ (Lemma 6.5). We only have to check that Π is a part of the filled Taylor expansion $\mathcal{T}^{\boxtimes}(R)$ of such a R , *i.e.* $\Pi \subseteq \mathcal{T}^{\boxtimes}(R)$.

- If $a \neq ?_c^i$, there exists (a unique) $R \in \mathbf{qMELL}(\Gamma)$ such that $R \xrightarrow{\mathfrak{A}} R'$. The case $a = ?_c^i$ is a bit more delicate: in this case too there exists (a unique) $R \in \mathbf{qMELL}(\Gamma)$ such that $R \xrightarrow{\mathfrak{A}} R'$, but here we use the fact that the types of the axiom conclusions are atomic. Indeed, thanks to this choice every conclusion of R' of type $?A$ is the output of a $?$ -cell.

- Let R be the unique pre-image of R' through $\mathbf{qMELL}(a)$ (*i.e.* $R \xrightarrow{\mathfrak{A}} R'$). We have to show that Π is a part of the filled Taylor expansion $\mathcal{T}^{\boxtimes}(R)$ of R . Let $\rho \in \Pi$ and $\{\rho'_1, \dots, \rho'_n\} \subseteq \Pi'$ such that $\rho \xrightarrow{\mathfrak{A}} \{\rho'_1, \dots, \rho'_n\}$. In all cases except \mathbf{Box} , this set is a singleton $\{\rho'_1\}$. In that cases, let $p' : t' \rightarrow \mathcal{F}'$ and r'_1, \dots, r'_k be the conclusions of R' such that $\rho'_1 = \rho_{r'_1 \dots r'_k}$ is the element of the filled Taylor expansion $\mathcal{T}^{\boxtimes}(R')$ of R' associated with p' and r'_1, \dots, r'_k .

If $a \in \{\mathbf{ax}_i, \mathbf{1}_i, \perp_i, ?_{w_i}\}$, let r be the root of the conclusion i in R and let s be the root of the conclusion i in ρ . \mathcal{F} is the disjoint union of \mathcal{F}' and the root r . Let t be the disjoint union of t' and the root s , and $p : t \rightarrow \mathcal{F}$ be defined as p' over t' and $p(s) = r$. If the cell with output i in ρ is a \boxtimes -cell, then we check that ρ is the element of the filled Taylor expansion $\mathcal{T}^{\boxtimes}(R)$ of R associated with p and r, r'_1, \dots, r'_k , else associated with p and r'_1, \dots, r'_k .

If $a \in \{\mathbf{cut}^i, \otimes_i, \wp_i, ?_{d_i}, ?_{c_i}\}$, then $\mathcal{F} = \mathcal{F}'$, $p = p'$ and we check that ρ is the element of the filled Taylor expansion $\mathcal{T}^{\boxtimes}(R)$ of R associated with p and r'_1, \dots, r'_k .

If $a = \text{mix}_i$, let r'_1 and r'_2 be the respective roots of the conclusion i and $i + k$ in R' , and let r be the root of the conclusion i in R . Consider the roots s'_1 and s'_2 in t' such that i is produced from s'_1 and $i + k$ from s'_2 , let t be equal to t' except that the two roots s'_1 and s'_2 are merged and change p' into p accordingly. We check that ρ is the element of the filled Taylor expansion $\mathcal{T}^{\mathfrak{X}}(R)$ of R associated with p and r'_1, \dots, r'_k . If $a = \text{Box}_i$, we describe the case of the Non-empty box rule (Figure 9j), leaving the two easier cases of the Daimoned (resp. Empty) box rule of Figure 9h (resp. Figure 9i) to the reader.

Let $p'_1 : t'_1 \rightarrow \mathcal{F}', \dots, p'_n : t'_n \rightarrow \mathcal{F}'$ be such that ρ'_1, \dots, ρ'_n are the expansions of R' associated with, respectively, p'_1, \dots, p'_n . The forests t'_1, \dots, t'_n differ by only one tree. Consider the forest t which has all the trees on which the n forests do not differ and the union of the trees on which the forests differ, all connected with a root, and define p accordingly. We check that ρ is the element of the filled Taylor expansion $\mathcal{T}^{\mathfrak{X}}(R)$ of R associated with p and r'_1, \dots, r'_k . \square

8. GLUEABILITY OF DiLL_0 QUASI-PROOF-STRUCTURES AND INHABITATION

Naturality (Theorem 7.3) allows us to prove our main original results:

- (1) the characterization of the sets of DiLL_0 proof-structures that are in the Taylor expansion of some MELL proof-structure (inverse Taylor expansion problem, Theorem 8.2);
- (2) the characterization of the lists of MELL formulas inhabited by some MELL proof-structure (type inhabitation problem for MELL proof-structures, Theorem 8.4).

Both characterizations are *constructive*, in the sense that, when we claim the existence of an object (a MELL proof-structure satisfying a certain property), we are actually able to construct a witness to it, thanks to our rewriting rules. However, our procedure is *non-deterministic* because the rewriting is not unique.

Definition 8.1 (glueability). A set Π of DiLL_0 quasi-proof-structures of type Γ is *glueable* if there exists a *scheduling* $\xi : \Gamma \rightarrow \varepsilon$ such that $\Pi \xrightarrow{\xi} \{\varepsilon\}$.

Theorem 8.2 (glueability criterion). *Let Π be a set of DiLL_0 proof-structures without \mathfrak{X} -cells: Π is glueable if and only if $\Pi \subseteq \mathcal{T}(R)$ for some MELL proof-structure R .*

Proof. If $\Pi \subseteq \mathcal{T}(R)$ for some MELL proof-structure R , then by termination (Proposition 6.7) $R \xrightarrow{\xi} \varepsilon$ for some scheduling $\xi : \Gamma \rightarrow \varepsilon$, where Γ is the type of R (and of each element of Π , according to Remark 5.5). Therefore, $\Pi \xrightarrow{\xi} \{\varepsilon\}$ by naturality (Theorem 7.3, as $\mathcal{T}^{\mathfrak{X}}(\varepsilon) = \{\varepsilon\}$).

Conversely, if $\Pi \xrightarrow{\xi} \{\varepsilon\}$ for some scheduling $\xi : \Gamma \rightarrow \varepsilon$ (where Γ is the type of each element of Π), then by naturality (Theorem 7.3, as $\mathcal{T}(\varepsilon) = \{\varepsilon\}$ and each element of Π is without \mathfrak{X} -cells) $\Pi \subseteq \mathcal{T}(R)$ for some MELL quasi-proof-structure R . The type of R is Γ by Remark 5.5, so R is a proof-structure since each element of Π is so. \square

Theorem 8.2 means that the action of a scheduling rewriting a set Π of DiLL_0 proof-structures to the empty proof-structure can be seen, read in reverse, as a sequentialization of elementary steps to build a MELL proof structure that contains Π in its Taylor expansion.

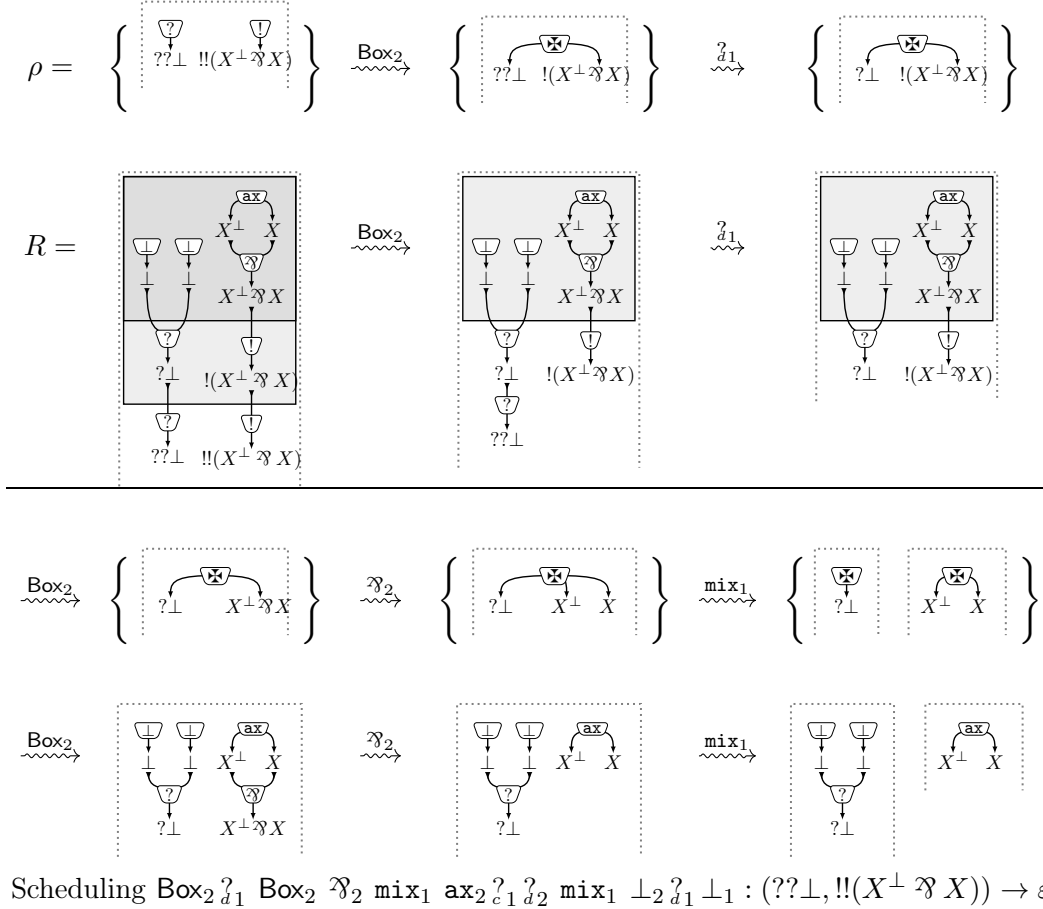
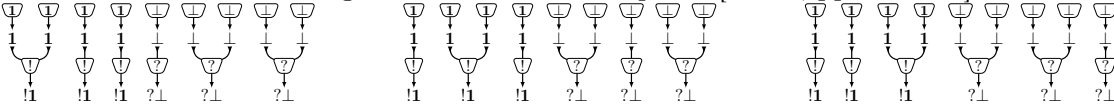

FIGURE 10. The action of a scheduling witnessing that $\rho \in \mathcal{T}(R)$ (to be continued on Figure 11). Actions exc_i are omitted.

Example 8.3. The three DiLL_0 proof-structures ρ_1, ρ_2, ρ_3 below are not glueable as a whole, but are glueable two by two. In fact, there is no MELL proof-structure whose Taylor expansion contains ρ_1, ρ_2, ρ_3 , but any pair of them is in the Taylor expansion of some MELL proof-structure. This is a slight variant of the example in [Tas09, pp. 244-246].



An example of the action of a path starting from a DiLL_0 proof-structure ρ and ending in $\{\varepsilon\}$ can be found in Figures 10 and 11. Note that it is by no means the shortest possible path. When replayed backwards, it induces a MELL proof-structure R such that $\rho \in \mathcal{T}(R)$.

Theorem 8.4 (inhabitation). *Let Γ be a list of MELL formulae. There is a MELL proof-structure of type Γ iff $\rho \xrightarrow{\xi} \{\varepsilon\}$ for some scheduling $\xi: (\Gamma) \rightarrow \varepsilon$, where ρ is a daimon of type Γ .*

Proof. If R is a MELL proof-structure of type Γ , then there is a scheduling $\xi: (\Gamma) \rightarrow \varepsilon$ such that $R \xrightarrow{\xi} \varepsilon$ by termination (Proposition 6.7). By naturality (Theorem 7.3), $\rho \xrightarrow{\xi} \{\varepsilon\}$ since $\rho \in \mathcal{T}^{\text{ax}}(R)$ (indeed ρ is the emptying of any element of $\mathcal{T}(R)$) and $\mathcal{T}^{\text{ax}}(\varepsilon) = \{\varepsilon\}$.

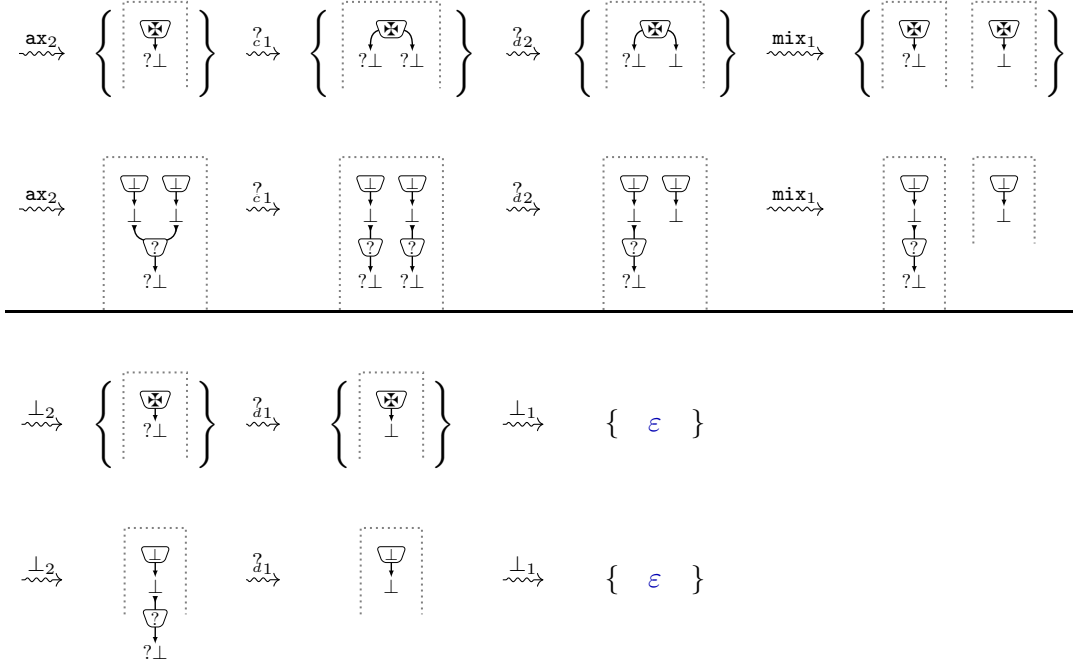

Scheduling $\text{Box}_2 \text{?}_1 \text{Box}_2 \text{?}_2 \text{mix}_1 \text{ax}_2 \text{?}_1 \text{?}_2 \text{mix}_1 \perp_2 \text{?}_1 \perp_1 : (??\perp, !!(X^\perp \wp X)) \rightarrow \varepsilon$

FIGURE 11. The action of a scheduling witnessing that $\rho \in \mathcal{T}(R)$ (continued from Figure 10). Actions exc_i are omitted.

Conversely, if $\rho \xrightarrow{\xi} \{\varepsilon\}$ for some scheduling $\xi : (\Gamma) \rightarrow \varepsilon$, then by naturality (Theorem 7.3) there is a MELL quasi-proof-structure $R \xrightarrow{\xi} \varepsilon$ such that $\rho \in \mathcal{T}^{\mathbf{X}}(R)$ (since $\mathcal{T}(\varepsilon) = \{\varepsilon\}$). As Γ is a list of MELL fomulæ and the type of R (by Remark 5.5), R is a proof-structure. \square

For some daimon ρ there is no scheduling ξ such that $\rho \xrightarrow{\xi} \{\varepsilon\}$. For instance, if $X \neq Y$ are propositional variables and ρ is the daimon below, then (because of the type) the only actions that can be applied to ρ are mix and exc , but they do not reduce ρ to $\{\varepsilon\}$.

$$\rho = \begin{array}{c} \text{X} \\ \swarrow \quad \searrow \\ Y \quad X \end{array}$$

Theorem 8.4 states that the action of a scheduling rewriting a daimon to the empty proof-structure can be seen, when read in reverse, as a sequentialization of elementary steps to build a MELL proof structure from the empty proof-structure. As there is no bound on the lenght on the rewritings, Theorem 8.4 proves the *semi-decidability* of the type inhabitation problem for MELL proof-structures.

Remark 8.5. Theorem 8.4 can also be read in connection with the question of deciding whether a MELL formula is provable: indeed, a MELL formula A is provable if and only if there is a *correct* MELL proof-structure of type A (for some notion of correctness).

For the time being, it is known that decidability of MLL provability is **NP**-complete while full LL provability is undecidable [LMSS92], but it is not known whether provability in MELL is decidable or not. Our result does not even yield a semi-algorithm for the MELL provability

problem: indeed, there might be an infinite number of schedulings of type $(A) \rightarrow \varepsilon$, and apart from testing the correctness of each of them, we have no tools to discriminate and know whether there is a correct one. Nonetheless, it offers a fresh perspective on a hard problem.

9. CONCLUSIONS AND PERSPECTIVES

Daimons for empty boxes. Our glueability criterion (Theorem 8.2) solves the inverse Taylor expansion problem in a “asymmetric” way: we characterize the sets of DiLL_0 proof-structures without \boxtimes -cells that are included in the Taylor expansion of some MELL proof-structure, but in general DiLL_0 proof-structures might contain \boxtimes -cells (while MELL proof-structures cannot, see Definition 4.1). *Daimons* and *emptyings* are needed to get a natural transformation (with respect to the *filled* Taylor expansion, Theorem 7.3), which is the main ingredient to prove our glueability criterion. But we are interested in frameworks without \boxtimes -cells. This asymmetry is technically inevitable, due to the fact that a glueable set of DiLL_0 proof-structures might not contain any information on the content of some box, when they take 0 copies of it.

Comparison with Pagani and Tasson [PT09]. Pagani and Tasson’s solution of the inverse Taylor expansion problem [PT09] is less general than ours, because it characterizes *finite* sets of DiLL_0 proof-structures that are included in the Taylor expansion of some *cut-free* MELL proof-structure with *atomic axioms*. We do not have these limitations (finite, cut-free, atomic axioms).¹⁸ We believe that our rewriting rules are also simpler than the ones in [PT09] and rely on a more abstract and less *ad hoc* property (naturality), that allows us also to prove the semi-decidability of another problem: *type inhabitation* in MELL proof-structures.

Finally, Pagani and Tasson’s solution of the inverse Taylor expansion problem is affected by another limitation, even though not particularly emphasized in [PT09]: their Theorem 2 (analogous to the left-to-right part of our Theorem 8.2) assumes not only that their rewriting starting from a set of DiLL_0 proof-structures terminates but also that it ends on a MELL proof-structure, according to their definition of MELL proof-structure. This is limiting when in the set of DiLL_0 proof-structures there is not information about the content of a box. For instance, consider the singletons Π and Π' of DiLL_0 proof-structures below:

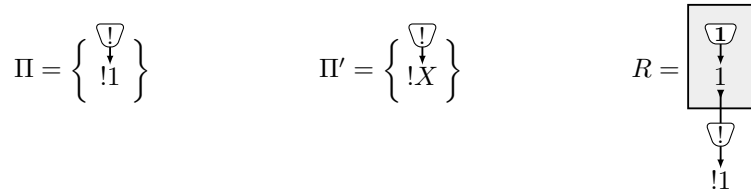

Pagani and Tasson’s rewriting rules do not distinguish the two singletons, each one is included in the Taylor expansion of MELL proof-structures with an “empty box”, due to the lack of information (so their notion of MELL proof-structures is wider and non-standard). On the contrary, our rewriting rules distinguish Π and Π' : the former rewrites to $\{\varepsilon\}$ and is included in the Taylor expansion of the MELL proof-structure R above, the latter do not rewrite to $\{\varepsilon\}$ and is not included in the Taylor expansion of any MELL proof-structure.

¹⁸As explained in Section 1, we deal with the non-atomic case in [GPT20, Sec. 7].

Summing-up, our characterization follows the standard notion of MELL proof-structures (unlike [PT09]) and is more fine-grained than the one in [PT09].

The λ -calculus, connectedness and coherence. Our rewriting system and glueability criterion might help to prove that a binary coherence relation can solve the inverse Taylor expansion problem for MELL proof-structures fulfilling some geometric property related to connectedness, despite the impossibility for the full MELL fragment. Such a coherence would extend the coherence criterion for resource λ -terms. Note that our glueability criterion is actually an extension of the criterion for resource λ -terms. Indeed, in the case of the λ -calculus, there are three rewrite steps, corresponding to abstraction, application and variable (which can be encoded in our rewrite steps), and coherence is defined inductively: if a set of resource λ -terms is coherent, then any set of resource λ -term that rewrites to it is also coherent.

Presented in this way, the main difference between the λ -calculus and “connected” MELL (concerning the inverse Taylor expansion problem) would not be because of the rewriting system but because the structure of any resource λ -term univocally determines the rewriting path, while, for DiLL₀ proof-structures, we have to quantify existentially over all possible paths. This is an unavoidable consequence of the fact that proof-structures do not have a tree-structure, contrary to λ -terms.

Moreover, it is possible to match and mix different sequences of rewriting. Indeed, consider three DiLL₀ proof-structures pairwise glueable. Proving that they are glueable as a whole amounts to computing a rewriting path from the rewriting paths witnessing the three glueabilities. Our paths were designed with that mixing-and-matching operation in mind, in the particular case where the boxes are connected. This is reminiscent of [GPT16], where we also showed that a certain property enjoyed by the λ -calculus can be extended to proof-structures, provided they are connected inside boxes. We leave it as future work.

Functoriality and naturality. Our functorial point of view on proof-structures might unify many results. Let us cite two of them:

- a sequent calculus proof of $\vdash \Gamma$ can be translated into a path from the empty sequence into Γ . This could be the starting point for the formulation of a new correctness criterion;
- the category **Sched** can be extended with higher structure, allowing to represent cut-elimination. The functors **qMELL** and **qDiLL₀** can also be extended to such higher functors, proving via naturality that cut-elimination and the Taylor expansion commute.

REFERENCES

- [Béc98] Denis Bécet. Minimality of the correctness criterion for multiplicative proof nets. *Mathematical Structures in Computer Science*, 8(6):543–558, 1998.
- [BHP13] Pierre Boudes, Fanny He, and Michele Pagani. A characterization of the Taylor expansion of lambda-terms. In *Computer Science Logic 2013 (CSL 2013)*, volume 23 of *LIPICs*, pages 101–115. Schloss Dagstuhl - Leibniz-Zentrum fuer Informatik, 2013.
- [BM07] Dennis V. Borisov and Yuri I. Manin. *Generalized Operads and Their Inner Cohomomorphisms*, volume 265 of *Progress in Mathematics*, pages 247–308. Birkhäuser Basel, Basel, 2007.
- [BM20] Davide Barbarossa and Giulio Manzonetto. Taylor subsumes scott, berry, kahn and plotkin. *Proc. ACM Program. Lang.*, 4(POPL):1:1–1:23, 2020.
- [Bou93] Gérard Boudol. The lambda-calculus with multiplicities (abstract). In *4th International Conference on Concurrency Theory (CONCUR '93)*, volume 715 of *Lecture Notes in Computer Science*, pages 1–6. Springer, 1993.

- [Bou09] Pierre Boudes. Thick subtrees, games and experiments. In *Typed Lambda Calculi and Applications, 9th International Conference (TLCA 2009)*, volume 5608 of *Lecture Notes in Computer Science*, pages 65–79. Springer, 2009.
- [dC16] Daniel de Carvalho. The relational model is injective for multiplicative exponential linear logic. In *25th Annual Conference on Computer Science Logic (CSL 2016)*, volume 62 of *LIPICs*, pages 41:1–41:19. Schloss Dagstuhl - Leibniz-Zentrum fuer Informatik, 2016.
- [dC18] Daniel de Carvalho. Taylor expansion in linear logic is invertible. *Logical Methods in Computer Science*, 14(4), 2018.
- [dCT12] Daniel de Carvalho and Lorenzo Tortora de Falco. The relational model is injective for multiplicative exponential linear logic (without weakenings). *Annals of Pure and Applied Logic*, 163(9):1210–1236, 2012.
- [DR95] Vincent Danos and Laurent Regnier. Proof-nets and the Hilbert Space. In *Proceedings of the Workshop on Advances in Linear Logic*, pages 307–328. Cambridge University Press, 1995.
- [Ehr02] Thomas Ehrhard. On Köthe sequence spaces and linear logic. *Mathematical Structures in Computer Science*, 12(5):579–623, 2002.
- [Ehr05] Thomas Ehrhard. Finiteness spaces. *Mathematical Structures in Computer Science*, 15(4):615–646, 2005.
- [ER03] Thomas Ehrhard and Laurent Regnier. The differential lambda-calculus. *Theoretical Computer Science*, 309(1-3):1–41, 2003.
- [ER06a] Thomas Ehrhard and Laurent Regnier. Böhm Trees, Krivine’s Machine and the Taylor Expansion of Lambda-Terms. In *Second Conference on Computability in Europe (CiE 2006)*, volume 3988 of *Lecture Notes in Computer Science*, pages 186–197. Springer, 2006.
- [ER06b] Thomas Ehrhard and Laurent Regnier. Differential interaction nets. *Theoretical Computer Science*, 364(2):166–195, 2006.
- [ER08] Thomas Ehrhard and Laurent Regnier. Uniformity and the Taylor expansion of ordinary lambda-terms. *Theoretical Computer Science*, 403(2-3):347–372, 2008.
- [Gir87] Jean-Yves Girard. Linear logic. *Theoretical Computer Science*, 50(1):1–101, 1987.
- [GPT16] Giulio Guerrieri, Luc Pellissier, and Lorenzo Tortora de Falco. Computing connected proof(-structure)s from their Taylor expansion. In *1st International Conference on Formal Structures for Computation and Deduction (FSCD 2016)*, volume 52 of *LIPICs*, pages 20:1–20:18. Schloss Dagstuhl - Leibniz-Zentrum fuer Informatik, 2016.
- [GPT19] Giulio Guerrieri, Luc Pellissier, and Lorenzo Tortora de Falco. Proof-net as graph, Taylor expansion as pullback. In *Logic, Language, Information, and Computation - 26th International Workshop (WoLLIC 2019)*, volume 11541 of *Lecture Notes in Computer Science*, pages 282–300. Springer, 2019.
- [GPT20] Giulio Guerrieri, Luc Pellissier, and Lorenzo Tortora de Falco. Glueability of resource proof-structures: inverting the Taylor expansion. In *28th EACSL Annual Conference on Computer Science Logic, CSL 2020*, volume 152 of *LIPICs*, pages 24:1–24:18. Schloss Dagstuhl, 2020.
- [KMP18] Emma Kerinec, Giulio Manzonetto, and Michele Pagani. Revisiting call-by-value Böhm trees in light of their Taylor expansion. *CoRR*, abs/1809.02659, 2018.
- [Laf90] Yves Lafont. Interaction nets. In *Seventeenth Annual ACM Symposium on Principles of Programming Languages (POPL 1990)*, pages 95–108. ACM Press, 1990.
- [LMSS92] Patrick Lincoln, John Mitchell, Andre Scedrov, and Natarajan Shankar. Decision problems for propositional linear logic. *Annals of Pure and Applied Logic*, 56(1):239 – 311, 1992.
- [MP07] Damiano Mazza and Michele Pagani. The separation theorem for differential interaction nets. In *Logic for Programming, Artificial Intelligence, and Reasoning, 14th International Conference (LPAR 2007)*, volume 4790 of *Lecture Notes in Computer Science*, pages 393–407. Springer, 2007.
- [MPV18] Damiano Mazza, Luc Pellissier, and Pierre Vial. Polyadic approximations, fibrations and intersection types. *PACMPL*, 2(POPL):6:1–6:28, 2018.
- [MR14] Giulio Manzonetto and Domenico Ruoppolo. Relational graph models, Taylor expansion and extensionality. *Electronic Notes in Theoretical Computer Science*, 308:245–272, 2014.
- [Pag09] Michele Pagani. The cut-elimination theorem for differential nets with promotion. In *Typed Lambda Calculi and Applications, 9th International Conference, (TLCA 2009)*, volume 5608 of *Lecture Notes in Computer Science*, pages 219–233. Springer, 2009.

- [Par92] Michel Parigot. $\lambda\mu$ -calculus: An algorithmic interpretation of classical natural deduction. In *Logic Programming and Automated Reasoning, International Conference (LPAR '92)*, volume 624 of *Lecture Notes in Computer Science*, pages 190–201. Springer, 1992.
- [PT09] Michele Pagani and Christine Tasson. The inverse Taylor expansion problem in linear logic. In *24th Annual Symposium on Logic in Computer Science (LICS 2009)*, pages 222–231. IEEE Computer Society, 2009.
- [PTV16] Michele Pagani, Christine Tasson, and Lionel Vaux. Strong normalizability as a finiteness structure via the Taylor expansion of λ -terms. In *Foundations of Software Science and Computation Structures - 19th International Conference (FOSSACS 2016)*, volume 9634 of *Lecture Notes in Computer Science*, pages 408–423. Springer, 2016.
- [Ret97] Christian Retoré. A semantic characterisation of the correctness of a proof net. *Mathematical Structures in Computer Science*, 7(5):445–452, 1997.
- [Tas09] Christine Tasson. *Sémantiques et Syntaxes Vectorielles de la Logique Linéaire*. PhD thesis, Université Paris Diderot, France, December 2009.
- [Tra11] Paolo Tranquilli. Intuitionistic differential nets and lambda-calculus. *Theor. Comput. Sci.*, 412(20):1979–1997, 2011.
- [Vau17] Lionel Vaux. Taylor expansion, lambda-reduction and normalization. In *26th EACSL Annual Conference on Computer Science Logic (CSL 2017)*, volume 82 of *LIPICs*, pages 39:1–39:16. Schloss Dagstuhl - Leibniz-Zentrum fuer Informatik, 2017.