

# Wreath/cascade products and related decomposition results for the concurrent setting of Mazurkiewicz traces (extended version)

**Bharat Adsul**

IIT Bombay, India  
adsul@cse.iitb.ac.in

**Paul Gastin** 

LSV, ENS Paris-Saclay, CNRS, Université Paris-Saclay, France  
paul.gastin@ens-paris-saclay.fr

**Saptarshi Sarkar**

IIT Bombay, India  
sapta@cse.iitb.ac.in

**Pascal Weil**

Univ. Bordeaux, LaBRI, CNRS UMR 5800, F-33400 Talence, France  
CNRS, ReLaX, IRL 2000, Siruseri, India  
pascal.weil@labri.fr

---

## Abstract

We develop a new algebraic framework to reason about languages of Mazurkiewicz traces. This framework supports true concurrency and provides a non-trivial generalization of the wreath product operation to the trace setting. A novel local wreath product principle has been established. The new framework is crucially used to propose a decomposition result for recognizable trace languages, which is an analogue of the Krohn-Rhodes theorem. We prove this decomposition result in the special case of acyclic architectures and apply it to extend Kamp's theorem to this setting. We also introduce and analyze distributed automata-theoretic operations called local and global cascade products. Finally, we show that aperiodic trace languages can be characterized using global cascade products of localized and distributed two-state reset automata.

**2012 ACM Subject Classification** Theory of computation → Distributed computing models; Theory of computation → Algebraic language theory

**Keywords and phrases** Mazurkiewicz traces, asynchronous automata, wreath product, cascade product, Krohn Rhodes decomposition theorem, local temporal logic over traces

**Funding** *Paul Gastin*: Supported by IRL ReLaX

*Pascal Weil*: Partially supported by the DeLTA project (ANR-16-CE40- 0007)

## 1 Introduction

Transformation monoids provide an abstraction of transition systems. One of the key tools in their analysis is the notion of wreath product [6, 19, 17] which, when translated to the language of finite state automata, corresponds to the cascade product. In the cascade product of automata  $A$  and  $B$ , with  $A$  ‘followed by’  $B$ , the automaton  $A$  runs on the input sequence, while the automaton  $B$  runs on the input sequence as well as the state sequence produced by the automaton  $A$ . The wreath product principle (see [19, 17, 16]) is a key result which relates a language accepted by a cascade/wreath product to languages accepted by the individual automata.

In this work, we are interested in generalizing the wreath product operation from the sequential setting to the concurrent setting involving multiple processes. Towards this, we work with Mazurkiewicz traces (or simply traces) [11, 5] which are well established as models

of true concurrency, and asynchronous automata [20] which are natural distributed finite state devices working on traces. A trace represents a concurrent behaviour as a labelled partial order which faithfully captures the distribution of events across processes, and causality and concurrency between them. An asynchronous automaton runs on the input trace in a distributed fashion and respects the underlying causality and concurrency between events. During the run, when working on an event, only the local states of the processes participating in that event are updated; the rest of the processes remain oblivious to the occurrence of the event at this point.

A natural generalization of the above mentioned sequential cascade product to asynchronous automata  $A$  and  $B$  is as follows: the asynchronous automaton  $A$  runs on the input trace, thus assigning, for each event, a local state for every process participating in that event. Now the asynchronous automaton  $B$  runs on the input trace with the *same* set of events which are *additionally* labelled by the previous local states of the participating processes in  $A$ . It is easy to capture this operational semantics by another asynchronous automaton which we call the *local* cascade product of  $A$  and  $B$ . Such a construction is used in [1] to provide an asynchronous automata-theoretic characterization of aperiodic trace languages.

Here we propose a new algebraic framework to deal with the issues posed by the concurrent setting. More precisely, we introduce a new class of transformation monoids called *asynchronous transformation monoids* (in short, *atm*). These monoids make a clear distinction between local and global ‘states’ and allow us to reason about whether a global transformation is essentially induced by a particular subset of processes. Recall that, from a purely algebraic viewpoint, the set of all traces forms a free partially commutative monoid in which *independent* actions commute [5]. In order to recognize a trace language via an atm, we introduce the notion of an *asynchronous morphism* which exploits the locality of the underlying atm. It is rather easy to see that asynchronous morphisms are the algebraic counterparts of asynchronous automata.

One of the central results of this work is a wreath product principle in the new algebraic framework. It turns out that the *standard* wreath product operation yields an operation on asynchronous transformation monoids. Let  $T_1$  and  $T_2$  be atm’s and  $T_1 \wr T_2$  be the wreath product atm. Our *local* wreath product principle describes a trace language recognized by  $T_1 \wr T_2$  in terms of a *local asynchronous transducer* which is a natural *causality and concurrency preserving* map from traces to traces (over an appropriately extended alphabet), and trace languages recognized by  $T_1$  and  $T_2$ . It is a novel generalization of the standard wreath product principle. The work [7] presents a wreath product principle for traces in the setting of transformation monoids but it seems less significant since it uses *non-trace* structures.

The importance of the standard wreath product operation is clearly highlighted by the fundamental Krohn-Rhodes decomposition theorem [10] which, broadly speaking, says that any finite transformation monoid can be simulated by wreath products of ‘simple’ transformation monoids. The wreath product principle along with the Krohn-Rhodes theorem can be used to provide alternate and conceptually simpler proofs (see [13, 2]) of several interesting classical results about formal languages of words such as Schützenberger’s theorem [18], McNaughton-Papert’s theorem [12] and Kamp’s theorem [8] which together show the equivalence between star-free, aperiodic, first-order-definable and linear-temporal-logic definable word languages. Motivated by these applications, we investigate an analogue of the fundamental Krohn-Rhodes decomposition theorem over traces. We use the new algebraic framework to propose a simultaneous generalization of the Krohn-Rhodes theorem (for word languages) and the Zielonka theorem (for trace languages). The proof of this

generalization for the special case of acyclic architectures is another significant result. As an application, we extend Kamp's theorem: we formulate a natural local temporal logic and show that it is expressively complete.

It turns out that asynchronous morphisms into wreath products correspond to the aforementioned distributed automata-theoretic local cascade products. We also introduce the *global* cascade product operation and show that it can be realized as the local cascade product with the help of the ubiquitous gossip automaton from [15].

Our final major contribution concerns aperiodic trace languages and is in the spirit of the Krohn-Rhodes theorem for the aperiodic case. We establish that aperiodic trace languages can be characterized using global cascade products of localized and distributed two-state reset automata. The proof of this characterization crucially uses an expressively complete process-based local temporal logic over traces from [3].

The rest of the paper is organized as follows. After setting up the preliminaries in Section 2, we develop the new algebraic framework in Section 3. In Section 3.4, we establish the local wreath product principle. In Section 4, we postulate a new decomposition result, and we establish it for acyclic architectures. We introduce and analyze local and global cascade products in Section 5. The global cascade product based characterization of aperiodic trace languages appears in Section 6. Finally, we conclude in Section 7.

## 2 Preliminaries

### 2.1 Basic Notions in Trace Theory

Let  $\mathcal{P}$  be a finite set of agents/processes. A *distributed alphabet* over  $\mathcal{P}$  is a family  $\tilde{\Sigma} = \{\Sigma_i\}_{i \in \mathcal{P}}$ . Let  $\Sigma = \bigcup_{i \in \mathcal{P}} \Sigma_i$ . For  $a \in \Sigma$ , we set  $\text{loc}(a) = \{i \in \mathcal{P} \mid a \in \Sigma_i\}$ . By  $(\Sigma, I)$  we denote the corresponding trace alphabet, i.e.,  $I$  is the *independence relation*  $\{(a, b) \in \Sigma^2 \mid \text{loc}(a) \cap \text{loc}(b) = \emptyset\}$  induced by  $\tilde{\Sigma}$ . The corresponding *dependence relation*  $\Sigma^2 \setminus I$  is denoted by  $D$ .

A  $\Sigma$ -labelled poset is a structure  $t = (E, \leq, \lambda)$  where  $E$  is a set,  $\leq$  is a partial order on  $E$  and  $\lambda: E \rightarrow \Sigma$  is a labelling function. For  $e, e' \in E$ , define  $e < e'$  if and only if  $e < e'$  and for each  $e''$  with  $e \leq e'' \leq e'$  either  $e = e''$  or  $e' = e''$ . For  $X \subseteq E$ , let  $\downarrow X = \{y \in E \mid y \leq x \text{ for some } x \in X\}$ . For  $e \in E$ , we abbreviate  $\downarrow\{e\}$  by simply  $\downarrow e$ .

A *trace* over  $\tilde{\Sigma}$  is a finite  $\Sigma$ -labelled poset  $t = (E, \leq, \lambda)$  such that

- If  $e, e' \in E$  with  $e < e'$  then  $(\lambda(e), \lambda(e')) \in D$
- If  $e, e' \in E$  with  $(\lambda(e), \lambda(e')) \in D$ , then  $e \leq e'$  or  $e' \leq e$

Let  $TR(\tilde{\Sigma})$  denote the set of all traces over  $\tilde{\Sigma}$ . Henceforth a trace means a trace over  $\tilde{\Sigma}$  unless specified otherwise. Let  $t = (E, \leq, \lambda) \in TR(\tilde{\Sigma})$ . The elements of  $E$  are referred to as *events* in  $t$  and for an event  $e$  in  $t$ ,  $\text{loc}(e)$  abbreviates  $\text{loc}(\lambda(e))$ . Further, let  $i \in \mathcal{P}$ . The set of  $i$ -events in  $t$  is  $E_i = \{e \in E \mid i \in \text{loc}(e)\}$ . This is the set of events in which process  $i$  participates. It is clear that  $E_i$  is totally ordered by  $\leq$ .

A subset  $c \subseteq E$  is a *configuration* of  $t$  if and only if  $\downarrow c = c$ . We let  $\mathcal{C}_t$  denote the set of all configurations of  $t$ . Notice that  $\emptyset$ , the empty set, and  $E$  are configurations. More importantly,  $\downarrow e$  is a configuration for every  $e \in E$ . There are two natural transition relations that one may associate with the configurations of  $t$ . The event based transition relation  $\Rightarrow_t \subseteq \mathcal{C}_t \times E \times \mathcal{C}_t$  is defined by  $c \xrightarrow{e}_t c'$  if and only if  $e \notin c$  and  $c \cup \{e\} = c'$ . The action based transition relation  $\rightarrow_t \subseteq \mathcal{C}_t \times \Sigma \times \mathcal{C}_t$  is defined by  $c \xrightarrow{a}_t c'$  if and only if there exists  $e \in E$  such that  $\lambda(e) = a$  and  $c \xrightarrow{e}_t c'$ .

Now we turn our attention to the important operation of concatenation of traces. Let  $t = (E, \leq, \lambda) \in TR(\tilde{\Sigma})$  and  $t' = (E', \leq', \lambda') \in TR(\tilde{\Sigma})$ . Without loss of generality, we can assume  $E$  and  $E'$  to be disjoint. We define  $tt' \in TR(\tilde{\Sigma})$  to be the trace  $(E'', \leq'', \lambda'')$  where

## Wreath products in the concurrent setting (extended version)

- $E'' = E \cup E'$ ,
- $\leq''$  is the transitive closure of  $\leq \cup \leq' \cup \{(e, e') \in E \times E' \mid (\lambda(e), \lambda'(e')) \in D\}$ ,
- $\lambda'': E'' \rightarrow \Sigma$  where  $\lambda''(e) = \lambda(e)$  if  $e \in E$ ; otherwise,  $\lambda''(e) = \lambda'(e)$ .

This operation, henceforth referred to as *trace concatenation*, gives  $TR(\widetilde{\Sigma})$  a monoid structure. Observe that, with  $a$  (resp.  $b$ ) denoting the singleton trace with the only event labelled  $a$  (resp.  $b$ ), if  $(a, b) \in I$  then  $ab = ba$  in  $TR(\widetilde{\Sigma})$ .

A basic result in trace theory gives a presentation of the trace monoid as a quotient of the *free* word monoid  $\Sigma^*$ . See [5] for more details. Let  $\sim_I \subseteq \Sigma^* \times \Sigma^*$  be the congruence generated by  $ab \sim_I ba$  for  $(a, b) \in I$ .

► **Proposition 1.** *The canonical morphism from  $\Sigma^* \rightarrow TR(\widetilde{\Sigma})$ , sending a letter  $a \in \Sigma$  to the trace  $a$ , factors through the quotient monoid  $\Sigma^*/\sim_I$  and induces an isomorphism from  $\Sigma^*/\sim_I$  to the trace monoid  $TR(\widetilde{\Sigma})$ .*

## 2.2 Transformation Monoids and Trace Languages

A map from a set  $X$  to itself is called a *transformation* of  $X$ . Under function composition, the set of all such transformations forms a monoid; let us denote this monoid by  $\mathcal{F}(X)$ . The function composition  $f_1 f_2$  (sometimes also denoted  $f_1 \circ f_2$ ) applies from left-to-right, that is,  $(f_1 f_2)(\cdot) = f_2(f_1(\cdot))$ .

A *transformation monoid* (or simply *tm*) is a pair  $T = (X, M)$  where  $M$  is a submonoid of  $\mathcal{F}(X)$ . The tm  $(X, M)$  is called *finite* if  $X$  is finite.

► **Example 2.** Consider  $X = \{1, 2\}$  with the monoid  $M = \{\text{id}_X, r_1, r_2\}$  where  $\text{id}_X$  is the identity transformation and  $r_i$  maps every element in  $X$  to element  $i$ . Note that  $r_1 r_2 = r_2$  and  $r_2 r_1 = r_1$ . Then  $(X, M)$  is a tm. We will refer to it as  $U_2$ .

Let  $T = (X, M)$  be a tm. By a morphism  $\varphi$  from  $TR(\widetilde{\Sigma})$  to  $T$ , we mean a (monoid) morphism  $\varphi: TR(\widetilde{\Sigma}) \rightarrow M$ . We abuse the notation and also write this as  $\varphi: TR(\widetilde{\Sigma}) \rightarrow T$ . Observe that, if  $(a, b) \in I$ , then as  $ab = ba$  in  $TR(\widetilde{\Sigma})$ ,  $\varphi(a)$  and  $\varphi(b)$  must commute in  $M$ . In fact, in view of Proposition 1, any function  $\varphi: \Sigma \rightarrow M$  which has the property that  $\varphi(a)$  and  $\varphi(b)$  commute for every  $(a, b) \in I$ , can be uniquely extended to a morphism from  $TR(\widetilde{\Sigma})$  to  $M$ .

Transformation monoids can be naturally used to recognize trace languages. Let  $L \subseteq TR(\widetilde{\Sigma})$  be a trace language. We say that  $L$  is *recognized by* a tm  $T = (X, M)$  if there exists a morphism  $\varphi: TR(\widetilde{\Sigma}) \rightarrow T$ , an *initial* element  $x_{\text{in}} \in X$  and a *final* subset  $X_{\text{fin}} \subseteq X$  such that  $L = \{t \in TR(\widetilde{\Sigma}) \mid \varphi(t)(x_{\text{in}}) \in X_{\text{fin}}\}$ . A trace language is said to be *recognizable* if it is recognized by a finite tm.

## 3 New Algebraic Framework

### 3.1 Asynchronous Transformation Monoids

Recall that we have a fixed finite set  $\mathcal{P}$  of processes. If  $\mathcal{P}$  is clear from the context, we use the simpler notation  $\{X_i\}$  to denote the  $\mathcal{P}$ -indexed family  $\{X_i\}_{i \in \mathcal{P}}$ . The elements of the sets in a  $\mathcal{P}$ -indexed family will be typically called *states*.

We begin with some notation involving local and global states. Suppose that each process  $i \in \mathcal{P}$  is equipped with a finite non-empty set of *local  $i$ -states*, denoted  $S_i$ . We set  $S = \bigcup_{i \in \mathcal{P}} S_i$  and call  $S$  the set of *local states*. We let  $P$  range over non-empty subsets of  $\mathcal{P}$  and let  $i, j$  range over  $\mathcal{P}$ . A  *$P$ -state* is a map  $s: P \rightarrow S$  such that  $s(j) \in S_j$  for every  $j \in P$ . We let  $S_P$  denote the set of all  $P$ -states. We call  $S_{\mathcal{P}}$  the set of all *global states*.

If  $P' \subseteq P$  and  $s \in S_P$  then  $s_{P'}$  is  $s$  restricted to  $P'$ . We use the shorthand  $-P$  to indicate the complement of  $P$  in  $\mathcal{P}$ . We sometimes split a global state  $s \in S_P$  as  $(s_P, s_{-P}) \in S_P \times S_{-P}$ . We let  $S_a$  denote the set of all  $\text{loc}(a)$ -states which we also call  $a$ -states for simplicity. Thus if  $\text{loc}(a) \subseteq P$  and  $s$  is a  $P$ -state we shall write  $s_a$  to mean  $s_{\text{loc}(a)}$ .

Now we are ready to introduce a new class of transformation monoids.

► **Definition 3.** An asynchronous transformation monoid (in short, atm)  $T$  (over  $\mathcal{P}$ ) is a pair  $(\{S_i\}, M)$  where

- $S_i$  is a finite non-empty set for each process  $i \in \mathcal{P}$ .
- $M$  is a submonoid of  $\mathcal{F}(S_P)$ , the monoid of all transformations from  $S_P$  to itself.

Note that this definition is dependent on  $\mathcal{P}$  and an atm  $T = (\{S_i\}, M)$  naturally induces the tm  $(S_P, M)$ . We abuse the notation and write  $T$  also for this tm.

A crucial feature of the definition of an atm is that it makes a clear distinction between local and global states. Observe that the underlying transformations operate on global states. It will be useful to know whether a global transformation is essentially induced by a particular subset of processes. We develop some notions to make this precise.

Fix an atm  $(\{S_i\}, M)$  and  $P \subseteq \mathcal{P}$ . Let  $f: S_P \rightarrow S_P$  be a map. We define  $g: S_P \rightarrow S_P$  as: for  $s \in S_P$ ,

$$g(s) = s' \text{ iff } f(s_P) = s'_P \text{ and } s_{-P} = s'_{-P}$$

We refer to  $g$  as the extension of  $f$ . More generally,  $h: S_P \rightarrow S_P$  is said to be a  $P$ -map if it is the extension of some  $f: S_P \rightarrow S_P$ . Note that, in this case, for all  $s = (s_P, s_{-P}) \in S_P$ ,  $h((s_P, s_{-P})) = (f(s_P), s_{-P})$  and  $f$  is uniquely determined by  $h$ . It is worth pointing out that a map  $h: S_P \rightarrow S_P$  with the property that for every  $s \in S_P$  there exists  $s'_P \in S_P$  such that  $h((s_P, s_{-P})) = (s'_P, s_{-P})$  is *not* necessarily a  $P$ -map. This condition merely says that the  $(-P)$ -component of a global state is not updated by  $h$ . The update of the  $P$ -component may still depend on the  $(-P)$ -component.

The following lemma provides a characterization of  $P$ -maps. We skip the easy proof.

► **Lemma 4.** Let  $h: S_P \rightarrow S_P$ . Then  $h$  is a  $P$ -map if and only if for every  $s$  in  $S_P$ ,  $[h(s)]_{-P} = s_{-P}$  and for every  $s, s'$  in  $S_P$ ,  $s_P = s'_P$  implies that  $[h(s)]_P = [h(s')]_P$ .

A simple but crucial observation regarding  $P$ -maps is recorded in the following lemma.

► **Lemma 5.** Let  $f, g: S_P \rightarrow S_P$  be such that  $f$  is a  $P$ -map and  $g$  is a  $P'$ -map. If  $P \cap P' = \emptyset$ , then  $fg = gf$ .

**Proof.** Let  $f$  (resp.  $g$ ) be the extension of some  $f': S_P \rightarrow S_P$  (resp.  $g': S_{P'} \rightarrow S_{P'}$ ). With  $Q = \mathcal{P} - (P \cup P')$ , we can split a global state  $s \in S_P$  as  $s = (s_P, s_{P'}, s_Q)$ . In the split notation, we have

$$\begin{aligned} fg((s_P, s_{P'}, s_Q)) &= g((f'(s_P), s_{P'}, s_Q)) = (f'(s_P), g'(s_{P'}), s_Q) \\ gf((s_P, s_{P'}, s_Q)) &= f((s_P, g'(s_{P'}), s_Q)) = (f'(s_P), g'(s_{P'}), s_Q) \end{aligned}$$

This shows that  $f$  and  $g$  commute. ◀

► **Example 6.** Fix a process  $\ell \in \mathcal{P}$ . We define the atm  $U_2[\ell] = (\{S_i\}, M)$  where,  $S_\ell = \{1, 2\}$  and for each  $i \neq \ell$ ,  $S_i$  has exactly one element. Observe that  $S_P$  has only two global states which are completely determined by their  $\ell$ -components. We will identify a global state with its  $\ell$ -component. The monoid  $M$  is  $\{\text{id}_{S_P}, r_1, r_2\}$  where  $\text{id}_{S_P}$  is the identity transformation and  $r_i$  maps every global state to the global state  $i$ . Note that  $r_1$  and  $r_2$  are  $\{\ell\}$ -maps.

### 3.2 Asynchronous Morphisms

Now we fix a distributed alphabet  $\tilde{\Sigma} = \{\Sigma_i\}_{i \in \mathcal{P}}$  over  $\mathcal{P}$  and introduce special morphisms from the trace monoid  $TR(\tilde{\Sigma})$  to atm's.

► **Definition 7.** Let  $T = (\{S_i\}, M)$  be an atm. An asynchronous morphism from  $TR(\tilde{\Sigma})$  to  $T$  is a (monoid) morphism  $\varphi: TR(\tilde{\Sigma}) \rightarrow M$  such that for  $a \in \Sigma$ ,  $\varphi(a)$  is an  $a$ -map.

It is important to observe that, contrary to the sequential case, a morphism from  $TR(\tilde{\Sigma})$  to  $M$  is not necessarily an asynchronous morphism from  $TR(\tilde{\Sigma})$  to the atm  $T = (\{S_i\}, M)$ . In a morphism  $\psi: TR(\tilde{\Sigma}) \rightarrow M$ , for  $(a, b) \in I$ ,  $\psi(a)$  and  $\psi(b)$  must commute; however  $\psi(a)$  (resp.  $\psi(b)$ ) may not be an  $a$ -map (resp.  $b$ -map).

A fundamental result about asynchronous morphisms is stated in the following lemma.

► **Lemma 8.** Let  $T = (\{S_i\}, M)$  be an atm. Further, let  $\varphi: \Sigma \rightarrow M$  be such that, for  $a \in \Sigma$ ,  $\varphi(a)$  is an  $a$ -map. Then  $\varphi$  can be uniquely extended to an asynchronous morphism from  $TR(\tilde{\Sigma})$  to  $T$ .

**Proof.** As the word monoid  $\Sigma^*$  is the free monoid generated by  $\Sigma$ , the map  $\varphi$  uniquely extends to a morphism from  $\Sigma^*$  to  $M$ . Recall that, by Proposition 1,  $TR(\tilde{\Sigma})$  is the quotient of  $\Sigma^*$  by the relations of the form  $ab = ba$  where  $(a, b) \in I$ . Therefore, in order to complete the proof, we simply need to show that  $\varphi(a)$  and  $\varphi(b)$  commute. If  $(a, b) \in I$ , then  $\text{loc}(a) \cap \text{loc}(b) = \emptyset$ . As  $\varphi(a)$  is an  $a$ -map and  $\varphi(b)$  is a  $b$ -map, by Lemma 5,  $\varphi(a)$  and  $\varphi(b)$  commute. ◀

► **Example 9.** Consider  $\tilde{\Sigma} = \{\Sigma_{p_1} = \{a, b\}, \Sigma_{p_2} = \{b, c\}, \Sigma_{p_3} = \{c\}\}$ . A function  $\varphi(a) = r_1$ ,  $\varphi(b) = r_2$  and  $\varphi(c) = \text{id}$  extends to an asynchronous morphism from  $TR(\tilde{\Sigma})$  to  $U_2[p_1]$ .

Now we extend the notion of trace-language recognition from tm's to atm's via asynchronous morphisms. Let  $L \subseteq TR(\tilde{\Sigma})$  be a trace language. We say that  $L$  is recognized by an atm  $T = (\{S_i\}, M)$  if there exists an asynchronous morphism  $\varphi: TR(\tilde{\Sigma}) \rightarrow T$ , an initial element  $s_{\text{in}} \in S_{\mathcal{P}}$  and a final subset  $S_{\text{fin}} \subseteq S_{\mathcal{P}}$  such that

$$L = \{t \in TR(\tilde{\Sigma}) \mid \varphi(t)(s_{\text{in}}) \in S_{\text{fin}}\}$$

In the rest of this subsection, we bring out the intimate relationship between asynchronous morphisms and asynchronous automata. We begin with the description of an asynchronous automaton – a model introduced by Zielonka for concurrent computation on traces.

An asynchronous automaton  $A$  over  $\tilde{\Sigma}$  is a structure  $(\{S_i\}_{i \in \mathcal{P}}, \{\delta_a\}_{a \in \Sigma}, s_{\text{in}})$  where

- $S_i$  is a finite non-empty set of local  $i$ -states for each process  $i$
- For  $a \in \Sigma$ ,  $\delta_a: S_a \rightarrow S_a$  is a transition function on  $a$ -states
- $s_{\text{in}} \in S_{\mathcal{P}}$  is an initial global state

Observe that an  $a$ -transition of  $A$  reads and updates only the local states of the agents which participate in  $a$ . As a result, actions which involve disjoint sets of agents are processed concurrently by  $A$ . For  $a \in \Sigma$ , let  $\Delta_a: S_{\mathcal{P}} \rightarrow S_{\mathcal{P}}$  be the extension of  $\delta_a: S_a \rightarrow S_a$ . Clearly, if  $(a, b) \in I$  then  $\Delta_a$  and  $\Delta_b$  commute. Similar to  $\mathcal{P}$ -indexed families, we will follow the convention of writing  $\{Y_a\}$  to denote the  $\Sigma$ -indexed family  $\{Y_a\}_{a \in \Sigma}$ .

Now we describe the notion of a run of  $A$  on an input trace. A trace run is easiest to define using configurations. Towards this, fix a trace  $t = (E, \leq, \lambda) \in TR(\tilde{\Sigma})$ . Recall that (Section 2.1)  $\mathcal{C}_t$  is the set of all configurations of  $t$  and  $\rightarrow_t \subseteq \mathcal{C}_t \times \Sigma \times \mathcal{C}_t$  is the natural action based transition relation on configurations. A trace run of  $A$  over  $t \in TR(\tilde{\Sigma})$  is a map  $\rho: \mathcal{C}_t \rightarrow S_{\mathcal{P}}$  such that  $\rho(\emptyset) = s_{\text{in}}$ , and for every  $(c, a, c')$  in  $\rightarrow_t$ , we have  $\Delta_a(\rho(c)) = \rho(c')$ . As  $A$  is deterministic,  $t$  admits a unique trace run; it will be denoted by  $\rho_t$ .

Let  $L \subseteq TR(\tilde{\Sigma})$  be a trace language. We say that  $L$  is *accepted* by  $A$  if there exists a subset  $S_{\text{fin}} \subseteq S_{\mathcal{P}}$  of final global states such that  $L = \{t = (E, \leq, \lambda) \in TR(\tilde{\Sigma}) \mid \rho_t(E) \in S_{\text{fin}}\}$ .

Our aim is to associate with  $A$ , a natural atm  $T_A$  and an asynchronous morphism  $\varphi_A$  such that languages accepted by  $A$  are precisely the languages recognized via  $\varphi_A$ .

We first describe the *transition* monoid  $M_A$  associated to  $A$ . It is possible to extend the global transition functions  $\{\Delta_a\}$  to arbitrary traces using Proposition 1. For  $t \in TR(\tilde{\Sigma})$ , we denote this extended global transition function by  $\Delta_t: S_{\mathcal{P}} \rightarrow S_{\mathcal{P}}$ . It is easy to check that, for  $t = (E, \leq, \lambda) \in TR(\tilde{\Sigma})$ ,  $\Delta_t(s_{\text{in}}) = \rho_t(E)$ . Further, as expected, for  $t, t' \in TR(\tilde{\Sigma})$ , the function composition  $\Delta_t \Delta_{t'}$  is identical to  $\Delta_{tt'}$ . We let  $M_A$  be the finite set of functions  $\{\Delta_t \mid t \in TR(\tilde{\Sigma})\}$ . Clearly, it is a monoid under the usual composition of functions.

Next, we define the *transition* atm of  $A$  to be  $T_A = (\{S_i\}, M_A)$  and the natural map  $\varphi_A: TR(\tilde{\Sigma}) \rightarrow M_A$  sending  $t$  to  $\Delta_t$ . It is clear that  $\varphi_A$  is a morphism of monoids. Furthermore, it is an asynchronous morphism from  $TR(\tilde{\Sigma})$  to  $T_A$ ; this is because, for  $a \in \Sigma$ ,  $\varphi_A(a) = \Delta_a$  is in fact an  $a$ -map of the atm  $T_A$ . The map  $\varphi_A$  is called the *transition* (asynchronous) morphism of  $A$ . Note that, for  $t = (E, \leq, \lambda) \in TR(\tilde{\Sigma})$ ,

$$\varphi_A(t)(s_{\text{in}}) = \Delta_t(s_{\text{in}}) = \rho_t(E)$$

We refer to the above statement as the *duality* between a run of  $A$  and an evaluation of  $\varphi_A$ .

The following lemma summarizes the above discussion for later reference and its proof is immediate.

► **Lemma 10.** *Given an asynchronous automaton  $A = (\{S_i\}, \{\delta_a\}, s_{\text{in}})$  over  $\tilde{\Sigma}$ , the transition atm  $T_A = (\{S_i\}, M_A)$  and the transition asynchronous morphism  $\varphi_A: TR(\tilde{\Sigma}) \rightarrow T_A$  are effectively constructible. Moreover, if  $L$  is a trace language, then  $L$  is accepted by  $A$  if and only if it is recognized by  $T_A$  via  $\varphi_A$  with  $s_{\text{in}}$  as the initial state.*

We now provide a form of converse to Lemma 10. Towards this, we fix an atm  $T = (\{S_i\}, M)$ , a state  $s_{\text{in}} \in S_{\mathcal{P}}$  and an asynchronous morphism  $\varphi: TR(\tilde{\Sigma}) \rightarrow T$ . Since  $\varphi$  is an asynchronous morphism,  $\varphi(a)$  is an  $a$ -map, and is an extension of some  $\delta_a: S_a \rightarrow S_a$  over  $a$ -states. We set  $A_\varphi = (\{S_i\}, \{\delta_a\}, s_{\text{in}})$  over  $\tilde{\Sigma}$ . It turns out that the transition monoid of  $A_\varphi$  is the image of  $\varphi$ , a submonoid of  $M$  and the transition morphism of  $A_\varphi$  is the appropriate restriction of  $\varphi$  to this submonoid. The next lemma is easy to prove and we skip its proof.

► **Lemma 11.** *Given  $T = (\{S_i\}, M)$ ,  $\varphi: TR(\tilde{\Sigma}) \rightarrow T$  and  $s_{\text{in}} \in S_{\mathcal{P}}$ , the asynchronous automaton  $A_\varphi$  over  $\tilde{\Sigma}$  is effectively constructible. Moreover, a trace language  $L \subseteq TR(\tilde{\Sigma})$  is recognized by  $T$  via  $\varphi$  (with initial state  $s_{\text{in}}$ ) if and only if it is accepted by  $A_\varphi$ .*

### 3.3 Asynchronous Wreath Product

We begin with the crucial definition of a wreath product of transformation monoids. For sets  $U$  and  $V$ , we denote the set of all functions from  $U$  to  $V$  by  $\mathcal{F}(U, V)$ .

► **Definition 12 (Wreath Product).** *Let  $T_1 = (X, M)$  and  $T_2 = (Y, N)$  be two tm's. We define  $T = T_1 \wr T_2$  to be the tm  $(X \times Y, M \times \mathcal{F}(X, N))$  where, for  $m \in M$  and  $f \in \mathcal{F}(X, N)$ ,  $(m, f)$  represents the following transformation on  $X \times Y$ :*

$$\text{for } (x, y) \in X \times Y, \quad (m, f)((x, y)) = (m(x), f(x)(y))$$

The tm  $T$  is called the wreath product of  $T_1$  and  $T_2$ . It turns out that, for  $(m_1, f_1), (m_2, f_2)$  in  $M \times \mathcal{F}(X, N)$ , the composition law  $(m_1, f_1)(m_2, f_2) = (m, f)$  is such that  $m = m_1 m_2$  and for  $x \in X$ ,  $f(x) = f_1(x) + f_2(m_1(x))$ . Here  $+$  denotes the composition operation of  $N$ .

It is a standard fact that the wreath product operation is associative [6]. We now adapt this operation to asynchronous transformation monoids.

► **Definition 13.** Let  $T_1 = (\{S_i\}, M)$  and  $T_2 = (\{Q_i\}, N)$  be two atm's. We define their asynchronous wreath product, also denoted by  $T_1 \wr T_2$ , to be the atm  $(\{S_i \times Q_i\}, M \times \mathcal{F}(S_{\mathcal{P}}, N))$ . An element  $(m, f) \in M \times \mathcal{F}(S_{\mathcal{P}}, N)$  represents the following global<sup>1</sup> transformation on  $S_{\mathcal{P}} \times Q_{\mathcal{P}}$ :

$$\text{for } (s, q) \in S_{\mathcal{P}} \times Q_{\mathcal{P}}, \quad (m, f)((s, q)) = (m(s), f(s)(q))$$

The composition law on  $M \times \mathcal{F}(S_{\mathcal{P}}, N)$  is the same as in Definition 12.

An important observation is that the tm associated with  $T_1 \wr T_2$  is the wreath product of the tms  $(S_{\mathcal{P}}, M)$  and  $(Q_{\mathcal{P}}, N)$  associated with  $T_1$  and  $T_2$  respectively. Sometimes, we will refer to the asynchronous wreath product simply as wreath product. The associativity of the asynchronous wreath product operation follows immediately.

We now present an important combinatorial lemma regarding the ‘support’ of a global transformation in the wreath product. It plays a crucial role later.

► **Lemma 14.** Fix atms  $T_1 = (\{S_i\}, M)$  and  $T_2 = (\{Q_i\}, N)$ . Let  $(m, f) \in M \times \mathcal{F}(S_{\mathcal{P}}, N)$  represent a  $P$ -map in  $T_1 \wr T_2$  for some subset  $P \subseteq \mathcal{P}$ . Then

- $m$  is a  $P$ -map in  $T_1$ .
- For every  $s \in S_{\mathcal{P}}$ ,  $f(s)$  is a  $P$ -map in  $T_2$ . Further, if  $s, s' \in S_{\mathcal{P}}$  are such that  $s_P = s'_P$ , then  $f(s) = f(s')$ .

**Proof.** Fix  $x_0 \in S_{-P}$  and  $y_0 \in Q_{-P}$ . We define  $g_1: S_{\mathcal{P}} \rightarrow S_{\mathcal{P}}$  and  $g_2: S_{\mathcal{P}} \times Q_{\mathcal{P}} \rightarrow Q_{\mathcal{P}}$  by  $g_1(x) = [m((x, x_0))]_P$  and  $g_2(x, y) = [f((x, x_0))(y, y_0)]_P$ . We first show that for all  $s \in S_{\mathcal{P}}, q \in Q_{\mathcal{P}}$ ,  $(m, f)((s, q)) = ((g_1(s_P), s_{-P}), (g_2(s_P, q_P), q_{-P}))$ . Take an arbitrary  $(s, q) \in S_{\mathcal{P}} \times Q_{\mathcal{P}}$ . Then consider the global state  $((s_P, x_0), (q_P, y_0))$  sharing the same  $P$ -component as  $(s, q)$  and the fixed  $-P$ -component  $(x_0, y_0)$ . By the wreath product action (see Definition 12),  $(m, f)((s_P, x_0), (q_P, y_0)) = (m((s_P, x_0)), f((s_P, x_0))((q_P, y_0)))$ . Being a  $P$ -map,  $(m, f)$  does not change the  $-P$ -component of any global state. So we have  $m((s_P, x_0)) = ([m((s_P, x_0))]_P, x_0)$  and  $f((s_P, x_0))((q_P, y_0)) = ([f((s_P, x_0))((q_P, y_0))]_P, y_0)$ .

Let  $(m, f)((s, q)) = (s', q')$ . Since  $(m, f)$  is a  $P$ -map and the two global states  $(s, q)$  and  $((s_P, x_0), (q_P, y_0))$  share the same  $P$ -component, by Lemma 4,  $s'_P = [m((s_P, x_0))]_P$  and  $q'_P = [f((s_P, x_0))((q_P, y_0))]_P$ . Further,  $s'_{-P} = s_{-P}$  and  $q'_{-P} = q_{-P}$ . Using the definitions of  $g_1$  and  $g_2$ , we immediately see that  $(m, f)((s, q)) = ((g_1(s_P), s_{-P}), (g_2(s_P, q_P), q_{-P}))$ . However, by the wreath product action,  $(m, f)((s, q)) = (m(s), f(s)(q))$ . Comparing this with the previous expression, we have  $m(s) = (g_1(s_P), s_{-P})$  and  $f(s)(q) = (g_2(s_P, q_P), q_{-P})$ . The result now follows from Lemma 4. ◀

### 3.4 Local Wreath Product Principle

Let  $A = (\{S_i\}, \{\delta_a\}, s_{in})$  be an asynchronous automaton over  $\tilde{\Sigma}$ . Based on  $A$  and  $\tilde{\Sigma}$ , we define the alphabet  $\Sigma^{\parallel s} = \{(a, s_a) \mid a \in \Sigma, s \in S_{\mathcal{P}}\}$  where a letter  $a$  in  $\Sigma$  is extended with local  $a$ -state information of  $A$ . This can naturally be viewed as a distributed alphabet  $\widetilde{\Sigma}^{\parallel s}$  where  $\forall a \in \Sigma, \forall s \in S_{\mathcal{P}}, (a, s_a) \in \Sigma_i^{\parallel s}$  if and only if  $a \in \Sigma_i$ . Then  $A$  induces the following transducer over traces.

<sup>1</sup> a global state (resp.  $P$ -state) of  $T_1 \wr T_2$  is canonically identified with an element of  $S_{\mathcal{P}} \times Q_{\mathcal{P}}$  (resp.  $S_{\mathcal{P}} \times Q_{\mathcal{P}}$ )



► **Definition 15** (Local Asynchronous Transducer). Let  $\chi_A: TR(\widetilde{\Sigma}) \rightarrow TR(\widetilde{\Sigma}^{\parallel s})$  be defined as follows. If  $t = (E, \leq, \lambda) \in TR(\widetilde{\Sigma})$ , then  $\chi_A(t) = t'$  where  $t' = (E, \leq, \mu) \in TR(\widetilde{\Sigma}^{\parallel s})$  with the labelling  $\mu: E \rightarrow \Sigma^{\parallel s}$  defined by:

$$\forall e \in E, \mu(e) = (a, s_a) \text{ where } a = \lambda(e) \text{ and } s = \rho_t(\downarrow e \setminus \{e\})$$

(recall that  $\rho_t$  is the unique trace run of  $A$  over  $t$ ). We call  $\chi_A$  the local asynchronous transducer of  $A$ .

► **Example 16.** Let  $\chi$  be the local asynchronous transducer associated to  $A_\varphi$  where  $\varphi$  is as in Example 9. Figure 1 shows the run of  $A_\varphi$  on a trace  $t \in TR(\widetilde{\Sigma})$  (by showing local process states before and after each event), and the resulting trace  $\chi(t) \in TR(\widetilde{\Sigma}^{\parallel s})$ .

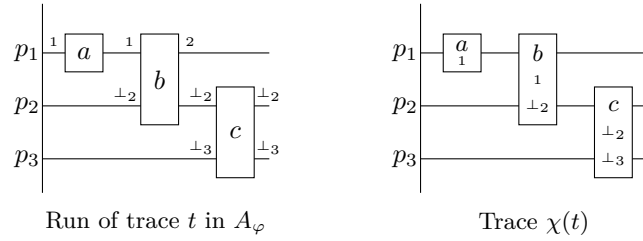

■ **Figure 1** Local asynchronous transducer output on a trace;  $S_{p_2} = \{\perp_2\}$ ,  $S_{p_3} = \{\perp_3\}$ .

Note that, in general,  $\chi_A$  is not a morphism of monoids. The following lemma is a straightforward consequence of the definition of  $\chi_A$  and the duality between trace runs of  $A$  and evaluations of the asynchronous morphism  $\varphi_A$ .

► **Lemma 17.** Let  $t \in TR(\widetilde{\Sigma})$  with factorization  $t = t'a$  (where  $a \in \widetilde{\Sigma}$ ), and  $s = \varphi_A(t')(s_{in})$ . Then the trace  $\chi_A(t) \in TR(\widetilde{\Sigma}^{\parallel s})$  factors as  $\chi_A(t) = \chi_A(t')(a, s_a)$ .

► **Theorem 18.** Let  $A$  be an asynchronous automaton over  $\widetilde{\Sigma}$  and  $\chi_A$  be the corresponding local asynchronous transducer. If  $L \subseteq TR(\widetilde{\Sigma}^{\parallel s})$  is recognized by an atm  $T$ , then  $\chi_A^{-1}(L)$  is recognized by the atm  $T_A \wr T$ .

**Proof.** Let  $\psi: TR(\widetilde{\Sigma}^{\parallel s}) \rightarrow T = (\{Q_i\}, N)$  be an asynchronous morphism, which recognizes  $L$  with  $q_{in} \in Q_{\mathcal{P}}$  as the initial global state, and  $Q_{fin} \subseteq Q_{\mathcal{P}}$  as the set of final global states. Then  $L = \{t \in TR(\widetilde{\Sigma}^{\parallel s}) \mid \psi(t)(q_{in}) \in Q_{fin}\}$ . Note that, for  $(a, s_a) \in \Sigma^{\parallel s}$ ,  $\psi((a, s_a))$  is an  $a$ -map (that is, an extension of a map from  $Q_a$  to  $Q_a$ ; recall that  $\text{loc}((a, s_a)) = \text{loc}(a)$ ).

For  $a \in \Sigma$ , we set  $\eta(a) = (\varphi_A(a), f_a)$  where  $f_a: S_{\mathcal{P}} \rightarrow N$  is defined by  $f_a(s) = \psi((a, s_a))$ . It is easy to check that  $\eta(a)$  is an  $a$ -map (that is, an extension of a map from  $S_a \times Q_a$  to  $S_a \times Q_a$ ). By Lemma 8, this uniquely defines an asynchronous morphism  $\eta: TR(\widetilde{\Sigma}) \rightarrow T_A \wr T$ .

Let  $t = (E, \leq, \lambda) \in TR(\widetilde{\Sigma})$ . We write  $\eta(t) = (\pi_1(t), \pi_2(t))$ . It follows from the definition of wreath product that  $\pi_1(t) = \varphi_A(t)$ . Now we claim that  $\pi_2(t)(s_{in}) = \psi(\chi_A(t))$ . We prove this by induction on the cardinality of  $E$ . Suppose  $t = t'a$ . Then  $\eta(t) = \eta(t')\eta(a)$ . As a result, we have  $(\pi_1(t), \pi_2(t)) = (\pi_1(t'), \pi_2(t'))(\pi_1(a), \pi_2(a))$ . Therefore, for  $s \in S_{\mathcal{P}}$ ,  $\pi_2(t)(s) = \pi_2(t')(s) + \pi_2(a)(\pi_1(t')(s))$ . In particular, it holds with  $s = s_{in}$ . Recall that

$\pi_1(t') = \varphi_A(t')$ . Also, by induction,  $\pi_2(t')(s_{\text{in}}) = \psi(\chi_A(t'))$ . Hence, with  $s = \varphi_A(t')(s_{\text{in}})$ ,

$$\begin{aligned} \pi_2(t)(s_{\text{in}}) &= \pi_2(t')(s_{\text{in}}) + \pi_2(a)(\pi_1(t')(s_{\text{in}})) \\ &= \psi(\chi_A(t')) + \pi_2(a)(s) \\ &= \psi(\chi_A(t')) + \psi((a, s_a)) \\ &= \psi(\chi_A(t')(a, s_a)) \\ &= \psi(\chi_A(t)) \end{aligned}$$

The last equality follows from Lemma 17. So,  $t \in \chi_A^{-1}(L)$  if and only if  $\chi_A(t) \in L$  if and only if  $\psi(\chi_A(t))(q_{\text{in}}) \in Q_{\text{fin}}$  if and only if  $\pi_2(t)(s_{\text{in}})(q_{\text{in}}) \in Q_{\text{fin}}$  if and only if  $\eta(t)(s_{\text{in}}, q_{\text{in}}) \in S_{\mathcal{P}} \times Q_{\text{fin}}$ . This shows that  $\eta$  recognizes  $\chi_A^{-1}(L)$  with  $(s_{\text{in}}, q_{\text{in}}) \in S_{\mathcal{P}} \times Q_{\mathcal{P}}$  as the initial global state, and  $S_{\mathcal{P}} \times Q_{\text{fin}} \subseteq S_{\mathcal{P}} \times Q_{\mathcal{P}}$  as the set of final global states.  $\blacktriangleleft$

Now we focus our attention on what is usually termed as the wreath product principle.

► **Theorem 19.** *Let  $T_1$  and  $T_2$  be atms and let  $L \subseteq TR(\tilde{\Sigma})$  be a trace language recognized by an asynchronous morphism  $\eta: TR(\tilde{\Sigma}) \rightarrow T_1 \wr T_2$ , with initial global state  $(s_{\text{in}}, q_{\text{in}})$ . For each  $a \in \Sigma$ , let  $\eta(a) = (m_a, f_a)$ . Then  $\varphi: TR(\tilde{\Sigma}) \rightarrow T_1$ , defined by  $\varphi(a) = m_a$ , is an asynchronous morphism. Finally, let  $A = A_\varphi$  be the asynchronous automaton associated to  $\varphi$  and  $s_{\text{in}}$ , and let  $\chi_A$  be the corresponding local asynchronous transducer. Then  $L$  is a finite union of languages of the form  $U \cap \chi_A^{-1}(V)$ , where  $U \subseteq TR(\tilde{\Sigma})$  is recognized by  $T_1$ , and  $V \subseteq TR(\Sigma^{\parallel s})$  is recognized by  $T_2$ .*

**Proof.** We write  $T_1 = (\{S_i\}, M)$  and  $T_2 = (\{Q_i\}, N)$ . Consider  $a \in \Sigma$  and the  $a$ -map  $\eta(a) = (m_a, f_a) \in M \times \mathcal{F}(S_{\mathcal{P}}, N)$ . This means that  $\eta(a)$  is an extension of a map from  $S_a \times Q_a$  to  $S_a \times Q_a$ . By Lemma 14,  $m_a \in M$  is an  $a$ -map (of  $T_1$ ) and  $f_a: S_{\mathcal{P}} \rightarrow N$  is such that, for  $s \in S_{\mathcal{P}}$ ,  $f_a(s) \in N$  is an  $a$ -map (of  $T_2$ ) and it depends only on  $s_a$ . In particular,  $f_a: S_{\mathcal{P}} \rightarrow N$  may be viewed as  $f_a: S_a \rightarrow N$ . Below we will use  $f_a$  in this sense.

Now we define an asynchronous morphism  $\psi: TR(\Sigma^{\parallel s}) \rightarrow T_2$  as follows:  $\psi((a, s_a)) = f_a(s_a)$ . Note that, by Lemma 8,  $\psi$  is indeed an asynchronous morphism as  $f_a(s_a)$  is an  $a$ -map. Further, as  $m_a$  is an  $a$ -map,  $\varphi: TR(\tilde{\Sigma}) \rightarrow T_1$ , defined by  $\varphi(a) = m_a$ , also extends to an asynchronous morphism.

Our aim is to express  $L$  in terms of languages recognized by  $T_1$  and  $T_2$ . It suffices to show the result when  $L$  is recognized with a single final global state, say  $(s_{\text{fin}}, q_{\text{fin}})$ . Then  $L = \{t \in TR(\tilde{\Sigma}) \mid \eta(t)((s_{\text{in}}, q_{\text{in}})) = (s_{\text{fin}}, q_{\text{fin}})\}$ .

For  $t \in TR(\tilde{\Sigma})$ , we write  $\eta(t) = (\pi_1(t), \pi_2(t))$ . It follows from the definition of  $\varphi$  that  $\varphi(t) = \pi_1(t)$ . Hence, we can alternatively write  $L$  as

$$L = \{t \in TR(\tilde{\Sigma}) \mid \varphi(t)(s_{\text{in}}) = s_{\text{fin}} \text{ and } \pi_2(t)(s_{\text{in}})(q_{\text{in}}) = q_{\text{fin}}\}$$

Let  $U = \{t \in TR(\tilde{\Sigma}) \mid \varphi(t)(s_{\text{in}}) = s_{\text{fin}}\}$ . Then, with  $W = \{t \in TR(\tilde{\Sigma}) \mid \pi_2(t)(s_{\text{in}})(q_{\text{in}}) = q_{\text{fin}}\}$ ,  $L = U \cap W$ . By using essentially the same ideas as in the proof of Theorem 18, we can show that  $\pi_2(t)(s_{\text{in}}) = \psi(\chi_A(t))$ . Therefore,  $W = \{t \in TR(\tilde{\Sigma}) \mid \psi(\chi_A(t))(q_{\text{in}}) = q_{\text{fin}}\}$ .

It follows that, with  $V = \{t' \in TR(\Sigma^{\parallel s}) \mid \psi(t')(q_{\text{in}}) = q_{\text{fin}}\}$ ,  $W = \chi_A^{-1}(V)$ . Clearly,  $U$  is recognized by the atm  $T_1$  (via  $\varphi$ ),  $V$  is recognized by the atm  $T_2$  (via  $\psi$ ) and  $L = U \cap \chi_A^{-1}(V)$ . This completes the proof.  $\blacktriangleleft$

## 4 Towards a Decomposition Result

In this section, we use the algebraic framework developed so far to propose an analogue of the fundamental Krohn-Rhodes decomposition theorem over traces. We first recall the

Krohn-Rhodes theorem in the purely algebraic setting of transformation monoids. We briefly explain how it is used to analyze/decompose morphisms from the free monoid and point out some difficulties that arise when we consider morphisms from the trace monoid.

Let  $M$  and  $N$  be monoids. We say that  $M$  divides  $N$  (in notation,  $M \prec N$ ) if  $M$  is a homomorphic image of some submonoid of  $N$ . This notion can be extended to transformation monoids. Let  $(X, M)$  and  $(Y, N)$  be two tm's. We say that  $(X, M)$  divides  $(Y, N)$ , denoted  $(X, M) \prec (Y, N)$ , if there exists a pair of mappings  $(f, \varphi)$  where  $f: Y \rightarrow X$  is a surjective function and  $\varphi: N' \rightarrow M$  is a surjective morphism from a submonoid  $N'$  of  $N$ , such that  $\varphi(n)(f(y)) = f(n(y))$  for all  $n \in N'$  and all  $y \in Y$ .

Recall that  $U_2 = (\{1, 2\}, \{\text{id}, r_1, r_2\})$  denotes the *reset* transformation monoid on two elements. Along with it, the following class of transformation monoids plays an important role in the Krohn Rhodes theorem.

► **Example 20.** Let  $G$  be a group. Then  $(G, G)$  is a tm where the monoid element  $g$  represents the transformation  $m_g: G \rightarrow G$  of the set  $G$ , which is the right multiplication by  $g$ . In other words, for  $h \in G$ ,  $m_g(h) = hg$ .

We are now in a position to state the Krohn-Rhodes theorem [10]. See [19] for a classical proof of the theorem, and [4] for a modern proof.

► **Theorem 21 (Krohn-Rhodes Theorem).** *Every finite transformation monoid  $T = (X, M)$  divides a wreath product of the form  $T_1 \wr \dots \wr T_n$  where each factor  $T_i$  is either  $U_2$  or is of the form  $(G, G)$  for some non-trivial simple group  $G$  dividing  $M$ .*

Henceforth, we will be dealing with only finite tms and sometimes we will omit the qualifier 'finite'. Now we turn our attention to the use of this decomposition theorem for analysing word languages recognized by morphisms from the free monoid.

► **Definition 22.** *Let  $\varphi: \Sigma^* \rightarrow T = (X, M)$  be a morphism. Further, let  $\psi: \Sigma^* \rightarrow T' = (Y, N)$  be another morphism. We say that  $\psi$  simulates  $\varphi$  if there exists a surjective function  $f: Y \rightarrow X$  such that, for all  $a \in \Sigma$  and all  $y \in Y$ ,  $f(\psi(a)(y)) = \varphi(a)(f(y))$ .*

$$\begin{array}{ccc} Y & \xrightarrow{\psi(a)} & Y \\ f \downarrow & & \downarrow f \\ X & \xrightarrow{\varphi(a)} & X \end{array}$$

■ **Figure 2** Visual illustration of condition  $f(\psi(a)(y)) = \varphi(a)(f(y))$  in Definition 22

Observe that if  $\psi$  simulates  $\varphi$  then a language recognized by  $\varphi$  is also recognized by  $\psi$ .

► **Proposition 23.** *Let  $\varphi: \Sigma^* \rightarrow T = (X, M)$  be a morphism. Then there exists a morphism  $\psi: \Sigma^* \rightarrow T'$  which simulates  $\varphi$  such that the tm  $T'$  is of the form  $T_1 \wr \dots \wr T_n$  where each factor  $T_i$  is either  $U_2$  or  $(G, G)$  for some non-trivial simple group  $G$  dividing  $M$ .*

**Proof.** Given  $T$ , we get  $T' = T_1 \wr \dots \wr T_n = (Y, N)$  by the Krohn-Rhodes theorem. Since  $T \prec T'$ , there exists a pair of mappings  $(f, \theta)$  where  $f: Y \rightarrow X$  is a surjective function and  $\theta: N' \rightarrow M$  is a surjective morphism from a submonoid  $N'$  of  $N$ , such that  $\theta(n)(f(y)) = f(n(y))$  for all  $n \in N'$  and all  $y \in Y$ . Construct  $\psi: \Sigma \rightarrow N$  by mapping  $\psi(a)$ , for each  $a$  in  $\Sigma$ , to an arbitrary element in  $\theta^{-1}(\varphi(a))$ . Thanks to the fact that  $\Sigma^*$  is a free monoid,  $\psi$  uniquely extends to a morphism  $\psi: \Sigma^* \rightarrow T'$ . It is easily checked that  $\psi$  simulates  $\varphi$ . ◀

Combined with the wreath product principle, the above proposition provides a powerful inductive tool to prove many non-trivial results in the theory of finite words. See [13, 2].

Motivated by these applications, we look for an analogue of the above proposition for the setting of traces. We now point to some problems that arise if one tries to naively lift the Krohn-Rhodes theorem to the setting of traces. The first problem is that, unlike in the word scenario, division does not imply simulation of morphisms from the *trace monoid*. By simulation of morphisms from the trace monoid, we simply mean an obvious adaptation of the Definition 22 to the morphisms from the trace monoid.

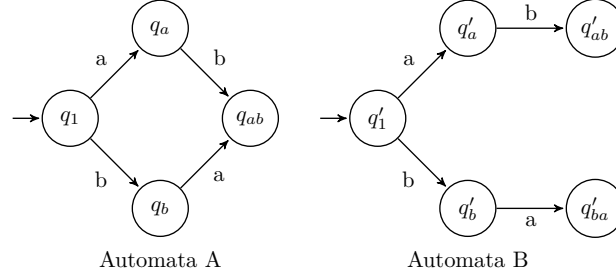

■ **Figure 3** Automata  $A$  and  $B$  on the alphabet  $\{a, b\}$

► **Example 24** (Example for Problem 1 of lifting Krohn Rhodes theorem to trace monoid). Consider the transition  $\text{tm}(X, M)$  (resp.  $(Y, N)$ ) of the automata  $A$  (resp.  $B$ ) in Figure 3; assume both are complete, with any transition not shown in the figure going to trap state  $q_t$  in  $A$  and  $q'_t$  in  $B$ . So  $X = \{q_1, q_a, q_b, q_{ab}, q_t\}$  and  $M = \{1_M, m_a, m_b, m, 0_M\}$  where  $1_M$  is the identity transformation of the empty word, and  $m_a, m_b$  and  $m$  respectively represent the state transformations by  $a, b$  and  $ab$  (or equivalently,  $ba$ ).  $0_M$  represents the transformation by any other word. Hence the multiplication table of  $M$  is the left one in Table 1. Similarly,  $Y = \{q'_1, q'_a, q'_b, q'_{ab}, q'_{ba}, q'_t\}$  and  $N = \{1_N, n_a, n_b, n_{ab}, n_{ba}, 0_N\}$  with its multiplication given by the right one in Table 1. Observe that  $(X, M) \prec (Y, N)$  by the pair  $(f, \psi)$  where  $\psi(n_a) = m_a$

■ **Table 1** Multiplication table of  $M$  and  $N$

|       |       |       |       |       |       |          |          |          |          |          |          |       |
|-------|-------|-------|-------|-------|-------|----------|----------|----------|----------|----------|----------|-------|
| $M$   | $1_M$ | $m_a$ | $m_b$ | $m$   | $0_M$ | $N$      | $1_N$    | $n_a$    | $n_b$    | $n_{ab}$ | $n_{ba}$ | $0_N$ |
| $1_M$ | $1_M$ | $m_a$ | $m_b$ | $m$   | $0_M$ | $1_N$    | $1_N$    | $n_a$    | $n_b$    | $n_{ab}$ | $n_{ba}$ | $0_N$ |
| $m_a$ | $m_a$ | $0_M$ | $m$   | $0_M$ | $0_M$ | $n_a$    | $n_a$    | $0_N$    | $n_{ab}$ | $0_N$    | $0_N$    | $0_N$ |
| $m_b$ | $m_b$ | $m$   | $0_M$ | $0_M$ | $0_M$ | $n_b$    | $n_b$    | $n_{ba}$ | $0_N$    | $0_N$    | $0_N$    | $0_N$ |
| $m$   | $m$   | $0_M$ | $0_M$ | $0_M$ | $0_M$ | $n_{ab}$ | $n_{ab}$ | $0_N$    | $0_N$    | $0_N$    | $0_N$    | $0_N$ |
| $0_M$ | $0_M$ | $0_M$ | $0_M$ | $0_M$ | $0_M$ | $n_{ba}$ | $n_{ba}$ | $0_N$    | $0_N$    | $0_N$    | $0_N$    | $0_N$ |
|       |       |       |       |       |       | $0_N$    | $0_N$    | $0_N$    | $0_N$    | $0_N$    | $0_N$    | $0_N$ |

and  $\psi(n_b) = m_b$  extends to a surjective monoid morphism from  $N$  to  $M$ . The surjective function  $f$  maps  $q'_{ab}$  and  $q'_{ba}$  both to  $q_{ab}$ . Remaining details of the function are obvious. In particular, both the  $\text{tm}$ 's can recognize the language  $L = \{ab, ba\}$ .

Now consider the distributed alphabet  $\tilde{\Sigma} = (\Sigma_1 = \{a\}, \Sigma_2 = \{b\})$ . Clearly  $aIb$ , and  $L$  is a trace language. Consider the function  $\varphi: \Sigma \rightarrow M$  where  $\varphi(a) = m_a$  and  $\varphi(b) = m_b$ . As  $m_a$  and  $m_b$  commute,  $\varphi$  indeed extends to a morphism from the trace monoid, and can recognize  $L$ , for example. However, there is no morphism from  $TR(\tilde{\Sigma})$  to  $(Y, N)$  that simulates  $\varphi$ . Note that the 'lifts'  $n_a$  and  $n_b$ , of  $m_a$  and  $m_b$  resp., don't commute, and so the function that extends to a simulating morphism  $\psi$  in the word case as in the proof of Proposition 23, does not work here for traces.

The second problem is that even if there is a morphism from  $TR(\tilde{\Sigma})$  to a wreath product of tm's, in general it does not induce morphisms from trace monoids to the individual tm's beyond the first one. This is primarily because the output of the *sequential* transducer associated with the first tm is *not* a trace.

► **Example 25.** Assume the DFA in Figure 4 represents the induced morphism to the first tm in a wreath product chain. The figure below shows the outputs of the sequential transducer associated with this DFA on three different linearizations of a single input trace. These outputs have different sets of letters and can not constitute a single trace.

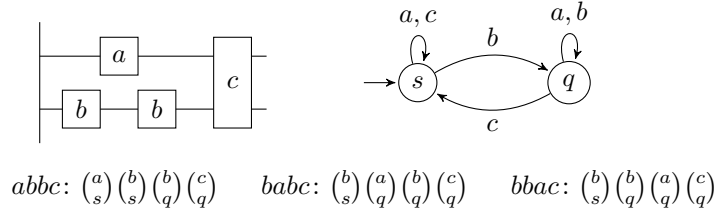

■ **Figure 4** Sequential transducer outputs for all linearizations of a trace

Prior work in [7] devised a wreath product principle for traces, but it uses non-trace structures to circumvent the second problem, thus limiting its applicability.

As seen in the previous sections, the new algebraic framework of asynchronous structures supports true concurrency and is well suited to reason about trace languages. Most importantly, an asynchronous morphism to a wreath product chain gives rise to asynchronous morphisms to individual atm's of the chain (see the proof of Theorem 19 for an illustration). This can be seen as a resolution of the second problem mentioned above.

Going ahead, we extend the notion of simulation to the case when the 'simulating' morphism is an asynchronous morphism to an atm.

► **Definition 26.** Let  $\varphi: TR(\tilde{\Sigma}) \rightarrow T = (X, M)$  be a morphism to a tm. Further, let  $T' = (\{S_i\}, N)$  be an atm and  $\psi: TR(\tilde{\Sigma}) \rightarrow T'$  be an asynchronous morphism. We say that  $\psi$  is an asynchronous simulation of  $\varphi$  (or simply  $\psi$  simulates  $\varphi$ ) if there exists a surjective function  $f: S_{\mathcal{P}} \rightarrow X$  such that, for all  $a \in \Sigma$  and all  $s \in S_{\mathcal{P}}$ ,  $f(\psi(a)(s)) = \varphi(a)(f(s))$ .

The fundamental theorem of Zielonka [20] states that every recognizable language is accepted by some asynchronous automata. See [14] for another proof of the theorem. From the viewpoint of our algebraic setup and the previous definition, it guarantees the existence of a simulating asynchronous morphism.

► **Theorem 27 (Zielonka Theorem).** Let  $\varphi: TR(\tilde{\Sigma}) \rightarrow T$  be a morphism to a finite tm. There exists an asynchronous morphism  $\psi: TR(\tilde{\Sigma}) \rightarrow T'$ , to a finite atm, which simulates  $\varphi$ .

Recall that the atm  $U_2[\ell]$ , defined in Example 6, is a natural extension of the tm  $U_2$  to the process  $\ell$ . In a similar vein, for a group  $G$ , the atm  $G[\ell]$  denotes the natural extension of the tm  $(G, G)$  from Example 20 to the process  $\ell$ . We will use a similar notation to extend a tm to an atm localized to a particular process.

Now we formulate the following decomposition question:

► **Question 1.** Let  $\varphi: TR(\tilde{\Sigma}) \rightarrow (X, M)$  be a morphism to a finite tm. Does there exist an asynchronous morphism  $\psi: TR(\tilde{\Sigma}) \rightarrow T'$  to a finite atm, such that  $\psi$  simulates  $\varphi$ , and the atm  $T'$  is of the form  $T_1 \wr \dots \wr T_n$  where each factor  $T_i$  is, for some  $\ell \in \mathcal{P}$ , either the atm  $U_2[\ell]$  or is of the form  $G[\ell]$  for some non-trivial simple group  $G$  dividing  $M$  ?

In view of our discussion so far, it is clear that the above question asks for a simultaneous generalization of the Krohn-Rhodes theorem for the setting of words (that is, Proposition 23), and the Zielonka theorem for the setting of traces (that is, Theorem 27). Question 1 in general remains open. However we answer it positively in a particular case, namely that of acyclic architectures, which is general enough to include the common client-server settings.

► **Definition 28.** Let  $\tilde{\Sigma} = \{\Sigma_i\}_{i \in \mathcal{P}}$  be a distributed alphabet. Then its communication graph is  $G = (\mathcal{P}, E)$  where  $E = \{(i, j) \in \mathcal{P} \times \mathcal{P} \mid i \neq j \text{ and } \Sigma_i \cap \Sigma_j \neq \emptyset\}$ . If the communication graph is acyclic, then the distributed alphabet is called an acyclic architecture.

Observe that if  $\tilde{\Sigma}$  is an acyclic architecture, then no action is shared by more than two processes. The work [9] provides a simpler proof of Zielonka’s theorem in this case.

► **Theorem 29.** If  $\tilde{\Sigma}$  is an acyclic architecture, then Question 1 admits a positive answer.

**Proof.** The proof is by induction on the number of processes. The base case with only one process follows from Proposition 23.

For the general case, let  $\mathcal{P} = \{1, 2, \dots, k\}$ . Since the communication graph is acyclic, there exists a ‘leaf’ process which communicates with at most one other process. Without loss of generality, let the leaf process be 1, and its only neighbouring process be 2 (if process 1 has no neighbour, then process 2 can be any other process). We ‘split’ the given morphism  $\varphi: TR(\tilde{\Sigma}) \rightarrow (X, M)$  based on the chosen leaf process 1.

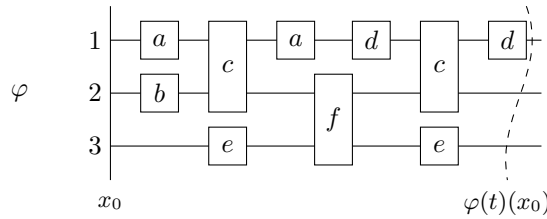

■ **Figure 5** Initial and final states of  $(X, M)$  under  $\varphi$

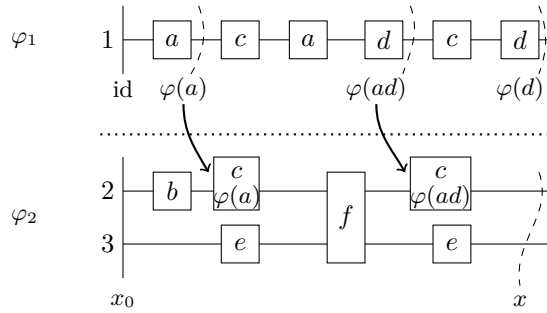

■ **Figure 6** Transfer of state information from  $\varphi_1$  to  $\varphi_2$ . The final states of the two atm’s are  $\varphi(d)$  and  $x$ . Note that  $\varphi(d)(x) = \varphi(t)(x_0)$ .

**Defining  $\varphi_1$  and  $\varphi_2$**

Let  $N$  be the submonoid of  $M$  generated by  $\{\varphi(a) \mid \text{loc}(a) = \{1\}\}$ . Also let  $\bar{N}$  be the semigroup of *reset* (that is, constant) functions from  $N$  into itself. If  $n \in N$ , we denote by  $\bar{n}$  the function on  $N$  which maps every element to  $n$ .

We define  $\varphi_1: \Sigma_1^* \rightarrow (N, N \cup \overline{N})$  by setting

$$\begin{aligned} \varphi_1(a) &= \varphi(a) & \text{if } \text{loc}(a) &= \{1\} \\ \varphi_1(a) &= \overline{\text{id}} & \text{if } \text{loc}(a) &= \{1, 2\} \end{aligned}$$

Note that at any point,  $\varphi_1$  records in the state of the tm, the evaluation  $\varphi(w)$  where  $w \in (\Sigma_1 \setminus \Sigma_2)^*$  is the word read by process 1 since the last joint action with its neighbour. As a result, the sequential transducer associated with  $\varphi_1$  adds the corresponding information at each process 1 event.

In particular, the information supplied at the joint events of process 1 and 2, will be used by  $\varphi_2$ . For this, let us define a suitable distributed alphabet  $\widetilde{\Sigma}' = \{\Sigma'_2, \Sigma'_3, \dots, \Sigma'_k\}$  over  $\mathcal{P} \setminus \{1\}$ , where  $\Sigma'_2 = (\Sigma_2 \setminus \Sigma_1) \cup ((\Sigma_1 \cap \Sigma_2) \times N)$ . We define  $\varphi_2: TR(\widetilde{\Sigma}') \rightarrow (X, M)$  by letting

$$\begin{aligned} \varphi_2(a) &= \varphi(a) & \text{if } 1 \notin \text{loc}(a) \\ \varphi_2((a, n)) &= n\varphi(a) & \text{if } \text{loc}(a) = \{1, 2\} \end{aligned}$$

We denote the total alphabet corresponding to  $\widetilde{\Sigma}$  and  $\widetilde{\Sigma}'$  by  $\Sigma$  and  $\Sigma'$  respectively. For any two letters  $a, b \in \Sigma \cap \Sigma' = \Sigma \setminus \Sigma_1$ , if  $a$  and  $b$  are independent in the new distributed alphabet  $\widetilde{\Sigma}'$ , then they must have been independent in  $\widetilde{\Sigma}$ . For independent letters  $(a, n)$  and  $b$  in  $\widetilde{\Sigma}'$ , it is easy to show that, process 1 being a leaf process,  $a$  and  $b$  are independent in  $\widetilde{\Sigma}$ , and that  $\varphi(b)$  and  $n$  commute. Based on these, we can verify that  $\varphi_2$  is indeed a morphism.

### Simulating $\varphi_1$ and $\varphi_2$

By induction hypothesis, we get a simulating morphism of  $\varphi_1$ , namely  $\widehat{\varphi}_1: \Sigma_1^* \rightarrow T_1 \wr T_2 \wr \dots \wr T_n$  where each factor is of the form  $U_2$  or  $(G, G)$  for some non-trivial simple group  $G$  dividing  $N \cup \overline{N}$ . Let  $T_1 \wr T_2 \wr \dots \wr T_n = T = (Y, M_1)$ . Then, by definition of simulation, there exists a surjective mapping  $f_1: Y \rightarrow N$  such that for any  $y \in Y$  and any  $a \in \Sigma_1$ ,  $f_1(\widehat{\varphi}_1(a)(y)) = \varphi_1(a)(f_1(y))$ .

We define a morphism  $\psi_1: TR(\widetilde{\Sigma}) \rightarrow T[1]$  by setting

$$\begin{aligned} \psi_1(a) &= \widehat{\varphi}_1(a) & \text{if } a \in \Sigma_1 \\ \psi_1(a) &= \text{id} & \text{otherwise} \end{aligned}$$

It is easy to check that  $\psi_1$  is an asynchronous morphism. Also, it's not difficult to see that  $T[1] = T_1[1] \wr \dots \wr T_n[1]$ . We write  $T[1]$  as  $(\{Y_i\}, M_1)$ . Since the process 1 local states represent the global states of  $T[1]$ , we can consider  $f_1$  as a surjective function from  $Y_{\mathcal{P}}$  to  $N$  such that for any  $y \in Y_{\mathcal{P}}$ , and  $a \in \Sigma_1$ , we have  $f_1(\psi_1(a)(y)) = \varphi_1(a)(f_1(y))$ .

Note that, by construction, each  $T_m[1]$  is of the form  $U_2[1]$  or  $G[1]$  for some non-trivial simple group  $G$  dividing  $N \cup \overline{N}$ . If  $G \prec N \cup \overline{N}$ , namely there exists a surjective morphism  $\tau$  from a submonoid  $N'$  of  $N \cup \overline{N}$  onto  $G$ , then  $\tau(\overline{n}) = \text{id}_G$  for every  $n \in N$ . Indeed  $\overline{n}$  is an idempotent, so its  $\tau$ -image must be the only idempotent in  $G$ , namely  $\text{id}_G$ . Clearly  $N'' = N' \cap N$  is a sub-monoid of  $N$  and  $\tau': N'' \rightarrow G$  defined by  $\tau'(n) = \tau(n)$  is a surjective morphism from  $N''$  to  $G$ . So,  $G \prec N$  and since division is transitive,  $G \prec M$ .

Similarly for  $\varphi_2$ , by the induction hypothesis, we have a simulating morphism  $\widehat{\varphi}_2: TR(\widetilde{\Sigma}') \rightarrow T'$ , where  $T' = T'_1 \wr \dots \wr T'_n$ , with each factor of the form  $U_2[\ell]$  or  $G[\ell]$  for some simple group  $G$  dividing  $M$ , and some  $\ell \in \{2, \dots, k\}$ . Similar to what we did previously, we tweak these atm's to make them work over  $\mathcal{P}$ , by adding a singleton set of local states for process 1. If we denote this by  $T'_m[\uparrow 1]$ , then  $T'[\uparrow 1] = T'_1[\uparrow 1] \wr \dots \wr T'_n[\uparrow 1]$ . Consider the distributed alphabet

$\widetilde{\Sigma}'' = (\Sigma'_1, \Sigma'_2, \Sigma_2, \dots, \Sigma_k)$ , where  $\Sigma'_1 = (\Sigma_1 \setminus \Sigma_2) \cup ((\Sigma_1 \cap \Sigma_2) \times N)$ . We devise a morphism  $\psi_2: TR(\widetilde{\Sigma}'') \rightarrow T'[\uparrow 1]$  by setting

$$\begin{aligned} \psi_2(a) &= \text{id} && \text{if } a \in \Sigma_1 \setminus \Sigma_2 \\ \psi_2(a) &= \widehat{\varphi}_2(a) && \text{otherwise} \end{aligned}$$

Let us denote  $T'[\uparrow 1]$  as the atm  $(\{Z_i\}, M_2)$ . Due to the canonical bijection between global states of  $T'$  and  $T'[\uparrow 1]$ , there is a surjective function  $f_2: Z_{\mathcal{P}} \rightarrow X$  such that for any  $a \in \Sigma \setminus \Sigma_1$ , and any  $z \in Z_{\mathcal{P}}$ , we have  $f_2(\psi_2(a)(z)) = \varphi_2(a)(f_2(z))$ . Furthermore, for  $(a, n) \in (\Sigma_1 \cap \Sigma_2) \times N$ , and any  $z \in Z_{\mathcal{P}}$ , we have  $f_2(\psi_2((a, n))(z)) = \varphi_2((a, n))(f_2(z))$ .

### Asynchronously simulating $\varphi$

The final step is to combine  $\psi_1$  and  $\psi_2$  to get asynchronous morphism  $\psi: TR(\widetilde{\Sigma}) \rightarrow (\{Y_i\}, M_1) \wr (\{Z_i\}, M_2)$  such that  $\psi$  simulates  $\varphi$ . Recall that  $(\{Y_i\}, M_1) \wr (\{Z_i\}, M_2) = (\{Y_i \times Z_i\}, M_1 \times \mathcal{F}(Y_{\mathcal{P}}, M_2))$ . We define  $\psi$  as follows:

$\psi(a) = (\psi_1(a), \gamma_a)$  where  $\gamma_a: Y_{\mathcal{P}} \rightarrow M_2$  is given by

$$\begin{aligned} \gamma_a(y) &= \text{id} && \text{if } \text{loc}(a) = \{1\} \\ \gamma_a(y) &= \psi_2((a, f_1(y))) && \text{if } \text{loc}(a) = \{1, 2\} \\ \gamma_a(y) &= \psi_2(a) && \text{if } 1 \notin \text{loc}(a) \end{aligned}$$

For  $a \in \Sigma_1 \cap \Sigma_2$ , recall that in the first atm  $T[1]$ , any global state is completely determined by its process 1 state. So,  $\psi(a)$  is an  $a$ -map, and hence  $\psi$  is an asynchronous morphism.

$$\begin{array}{ccc} Y_{\mathcal{P}} \times Z_{\mathcal{P}} & \xrightarrow{\psi(a)} & Y_{\mathcal{P}} \times Z_{\mathcal{P}} \\ f \downarrow & & \downarrow f \\ X & \xrightarrow{\varphi(a)} & X \end{array}$$

■ **Figure 7**  $\psi$  simulates  $\varphi$

We now show that there exists a surjective function  $f: Y_{\mathcal{P}} \times Z_{\mathcal{P}} \rightarrow X$  such that  $f(\psi(a)(y, z)) = \varphi(a)(f(y, z))$  for all  $(y, z) \in Y_{\mathcal{P}} \times Z_{\mathcal{P}}$ . We define  $f(y, z) = f_1(y)(f_2(z))$ . It is surjective because both  $f_1$  and  $f_2$  are surjective, and  $N$  contains an identity element. Simple calculations show that  $\psi$  simulates  $\varphi$ . We give a case by case argument as to why this should be true.

$f(\psi(a)(y, z))$  refers to the new state of  $(X, M)$  that we get by first reading the letter  $a$  at state  $(y, z)$  in the atm  $(\{Y_i\}, M_1) \wr (\{Z_i\}, M_2)$ , and then mapping back to the corresponding state of  $(X, M)$  using  $f$ .

**Case  $a \in \Sigma_1 \cap \Sigma_2$ :** When  $a \in \Sigma_1 \cap \Sigma_2$ , it is a joint letter of process 1 and process 2. Recall from the definition of  $\varphi_1$ , that these joint letters reset the state of the tm  $(N, N \cup \overline{N})$  to the id state. Because  $\psi_1$  simulates  $\varphi_1$  on letters from  $\Sigma_1$ , it should be clear that the new state  $\psi_1(a)(y)$  of  $(\{Y_i\}, M_1)$  maps to state id in the tm  $(N, N \cup \overline{N})$ . That is  $f_1(\psi_1(a)(y)) = \text{id}$ .

The local asynchronous transducer of the first atm adds the process 1 state (equivalent to global state in the first atm)  $y$  to the letter  $a$ . This corresponds to the letter  $(a, f_1(y))$  as input to  $\varphi_2$ . Before reading the letter, the tm  $(X, M)$  (for  $\varphi_2$ ) is in state  $f_2(z)$ . Thus,



from the definition of  $\varphi_2$ , and because  $\psi_2$  simulates  $\varphi_2$  on the extended letters, we know that the new state  $\psi_2(a, f_1(y))(f_2(z))$  in  $(\{Z_i\}, M_2)$  should map to the state  $f_1(y).\varphi(a)(f_2(z)) = \varphi(a)(f(y, z))$  in  $(X, M)$ . That is,  $f_2(\psi_2(a, f_1(y))(f_2(z))) = \varphi(a)(f(y, z))$ . The overall state of  $(X, M)$  is then given by  $\text{id}(\varphi(a)(f(y, z))) = \varphi(a)(f(y, z))$ . Hence in this case  $\psi$  simulates  $\varphi$ .

$$\begin{aligned} f(\psi(a)(y, z)) &= f(\psi_1(a)(y), \psi_2(a, f_1(y)(z))) \\ &= f_1(\psi_1(a)(y))(f_2(\psi_2(a, f_1(y)(z)))) \\ &= \varphi_1(a)f_1(y)(\varphi_2(a, f_1(y))(f_2(z))) \\ &= \text{id}(f_1(y)\varphi(a)(f_2(z))) \\ &= \varphi(a)(f(y, z)) \end{aligned}$$

**Case  $a \in \Sigma_1 \setminus \Sigma_2$ :** In this case, state of  $(X, M)$  (from  $\varphi_2$ ) doesn't change, that is, it remains  $f_2(z)$ . The state of  $(N, N \cup \bar{N})$  should be  $\varphi(a)$  applied to the old state  $f_1(y)$ . That is, the new state of  $(X, M)$  should be  $\varphi(a)(f_1(y))(f_2(z))$ . Note that  $\varphi(a)(f_1(y))$  is the element  $f_1(y).\varphi(a)$  in  $N$ . Thus new state is  $f_1(y).\varphi(a)(f_2(z)) = \varphi(a)(f(y, z))$ . Hence, in this case  $\psi$  simulates  $\varphi$ .

$$\begin{aligned} f(\psi(a)(y, z)) &= f(\psi_1(a)(y), \text{id}(z)) \\ &= f_1(\psi_1(a)(y))(f_2(z)) \\ &= \varphi_1(a)f_1(y)(f_2(z)) \\ &= \varphi(a)(f(y, z)) \end{aligned}$$

**Case  $a \notin \Sigma_1$ :** In this case, state of tm for  $\varphi_1$  should not update. So its new state is the old state  $f_1(y)$ . The new state of  $(X, M)$  (for  $\varphi_2$ ) should be  $\varphi(a)$  applied to old state  $f_2(z)$ . Thus, the new overall state of  $(X, M)$  is  $f_1(y)(\varphi(a)(f_2(z))) = \varphi(a).f_1(y)(f_2(z))$ . Since  $a \notin \Sigma_1$ , note that  $f_1(y) \in N$  commutes with  $\varphi(a)$ . Thus, new state is  $f_1(y)\varphi(a)(f_2(z)) = \varphi(a)(f(y, z))$ . hence in this case also,  $\psi$  simulates  $\varphi$ . and  $\varphi(a)$

$$\begin{aligned} f(\psi(a)(y, z)) &= f(\psi_1(a)(y), \psi_2(a)(z)) \\ &= f_1(\psi_1(a)(y))(f_2(\psi_2(a)(z))) \\ &= f_1(y)(\varphi_2(a)(f_2(z))) \\ &= \varphi_2(a)f_1(y)(f_2(z)) \\ &= f_1(y)\varphi_2(a)(f_2(z)) \\ &= \varphi(a)(f(y, z)) \end{aligned}$$

◀

## 5 Local and Global Cascade Products

In this section, we introduce distributed automata-theoretic operations called local and global cascade products.

## 5.1 Local Cascade Product

► **Definition 30.** Let  $A_1 = (\{S_i\}, \{\delta_a\}, s_{in})$  over  $\tilde{\Sigma}$ , and  $A_2 = (\{Q_i\}, \{\delta_{(a,s_a)}\}, q_{in})$  over  $\tilde{\Sigma}^{\parallel s}$  be two asynchronous automata. We define the local cascade product of  $A_1$  and  $A_2$ , denoted  $A_1 \circ_\ell A_2$ , to be the asynchronous automaton  $(\{S_i \times Q_i\}, \{\Delta_a\}, (s_{in}, q_{in}))$  over  $\tilde{\Sigma}$ , where, for  $a \in \Sigma$  and  $(s_a, q_a) \in S_a \times Q_a$ ,  $\Delta_a((s_a, q_a)) = (\delta_a(s_a), \delta_{(a,s_a)}(q_a))$ .

The operational working of  $A = A_1 \circ_\ell A_2$  can be understood in terms of  $A_1$  and  $A_2$  using the local asynchronous transducer  $\chi_{A_1} : TR(\tilde{\Sigma}) \rightarrow TR(\tilde{\Sigma}^{\parallel s})$  (associated with  $A_1$ ) as follows: for an input trace  $t \in TR(\tilde{\Sigma})$ , the run of  $A$  on  $t$  ends in global state  $(s, q)$  if and only if the run of  $A_1$  on  $t$  ends in global state  $s$  and the run of  $A_2$  on  $\chi_{A_1}(t)$  ends in global state  $q$ . This *operational cascade* of  $A_1$  followed by  $A_2$  is summarized in the right part of

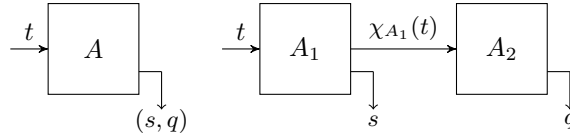

■ **Figure 8** Operational view of local cascade product

the Figure 8. It is not difficult to check that the local cascade product is associative and  $\chi_{A_1 \circ_\ell A_2}(t) = \chi_{A_2}(\chi_{A_1}(t))$  for all  $t \in TR(\tilde{\Sigma})$ .

Local cascade product is the automata-theoretic counterpart of local wreath product, and Figure 8 shows the essence of the local wreath product principle discussed in Section 3.4. To explain this further, let  $T_1 = (\{S_i\}, M)$ ,  $T_2 = (\{Q_i\}, N)$  be two atm's. Consider an asynchronous morphism  $\eta : TR(\tilde{\Sigma}) \rightarrow T_1 \wr T_2$ . Let  $A$  be the asynchronous automaton over  $\tilde{\Sigma}$  corresponding to the morphism  $\eta$  with a fixed choice of  $(s_{in}, q_{in}) \in S_{\mathcal{P}} \times Q_{\mathcal{P}}$  as the initial global state.

Recall that, as seen in the proof of Theorem 19,  $\eta$  gives rise to canonical asynchronous morphisms  $\varphi : TR(\tilde{\Sigma}) \rightarrow T_1$  and  $\psi : TR(\tilde{\Sigma}^{\parallel s}) \rightarrow T_2$  as follows: for  $a \in \Sigma$  and  $s_a \in S_a$ ,

$$\eta(a) = (m_a, f_a) \implies \varphi(a) = m_a \text{ and } \psi((a, s_a)) = f_a(s_a)$$

Let  $A_1$  (resp.  $A_2$ ) be the asynchronous automaton over  $\tilde{\Sigma}$  (resp.  $\tilde{\Sigma}^{\parallel s}$ ) corresponding to the morphisms  $\varphi$  (resp.  $\psi$ ) with  $s_{in}$  (resp.  $q_{in}$ ) as the initial global state. Then it turns out that  $A$  is the local cascade product of  $A_1$  and  $A_2$ . Following lemma summarizes this.

► **Lemma 31.** Let  $\eta : TR(\tilde{\Sigma}) \rightarrow (\{S_i\}, M) \wr (\{Q_i\}, N)$  canonically give rise to the two asynchronous morphism  $\varphi : TR(\tilde{\Sigma}) \rightarrow (\{S_i\}, M)$  and  $\psi : TR(\tilde{\Sigma}^{\parallel s}) \rightarrow (\{Q_i\}, N)$  defined by  $\eta(a) = (m_a, f_a) \implies \varphi(a) = m_a$  and  $\psi((a, s_a)) = f_a(s_a)$ . If  $A$  is the asynchronous automata corresponding to  $\eta$  with  $(s_{in}, q_{in})$  as its initial state, and  $A_1$  (resp.  $A_2$ ) is the asynchronous automata corresponding to  $\varphi$  (resp.  $\psi$ ) with  $s_{in}$  (resp.  $q_{in}$ ) as its initial state, then  $A = A_1 \circ_\ell A_2$ .

**Proof.** The proof follows easily from the definitions and skipped. ◀

## 5.2 Global Asynchronous Transducer and its Local Implementation

Let  $A = (\{S_i\}, \{\delta_a\}, s_{in})$  be an asynchronous automaton over  $\tilde{\Sigma}$ . Recall that the local asynchronous transducer  $\chi_A$  preserves the underlying set of events and, at an event, simply records the previous local states of the processes *participating* in that event.

Now we introduce a natural variant of  $\chi_A$  which is called the *global asynchronous transducer*. In this variant, at an event, we record the *best global state* that causally precedes the current event. This is the best global state that the processes participating in the current event are (collectively) aware of. It is important to note that the global and local asynchronous transducers coincide in the sequential setting.

We first setup some notation. Based on  $A$  and  $\tilde{\Sigma}$ , we define the alphabet  $\Sigma^{S_{\mathcal{P}}} = \Sigma \times S_{\mathcal{P}}$  where each letter in  $\Sigma$  is extended with global state information of  $A$ . This can naturally be viewed as a distributed alphabet  $\widetilde{\Sigma}^{S_{\mathcal{P}}}$  where for all  $a \in \Sigma$  and  $s \in S_{\mathcal{P}}$ , we have  $(a, s) \in \Sigma_i^{S_{\mathcal{P}}}$  if and only if  $a \in \Sigma_i$ .

► **Definition 32** (Global Asynchronous Transducer). *Let  $A$  be an asynchronous automaton over  $\tilde{\Sigma}$ . The global asynchronous transducer of  $A$  is the map  $\theta_A: TR(\tilde{\Sigma}) \rightarrow TR(\Sigma^{S_{\mathcal{P}}})$  defined as follows. If  $t = (E, \leq, \lambda) \in TR(\tilde{\Sigma})$ , then  $\theta_A(t) = (E, \leq, \mu) \in TR(\Sigma^{S_{\mathcal{P}}})$  with the labelling  $\mu: E \rightarrow \Sigma \times S_{\mathcal{P}}$  defined by:*

$$\forall e \in E, \mu(e) = (a, s) \text{ where } a = \lambda(e) \text{ and } s = \rho_t(\downarrow e \setminus \{e\})$$

► **Example 33.** For the same trace  $t$  and asynchronous automata  $A_{\varphi}$  from Example 16, Figure 9 shows its global asynchronous transducer output  $\theta(t)$ . Note the difference from Figure 1. For example, here the  $p_3$ -event has process  $p_1$  state 2 in its label (which is the best process  $p_1$  state in its causal past) even though process  $p_1$  and process  $p_3$  never interact directly.

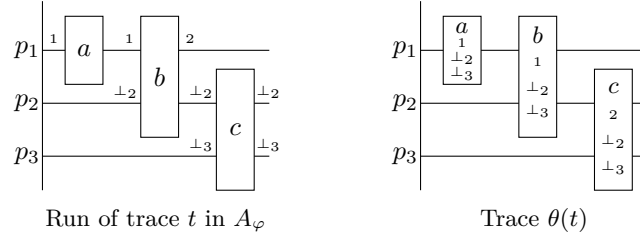

■ **Figure 9** Global asynchronous transducer output on a trace

Below we give a uniform translation from the automaton  $A$  to another automaton  $\mathcal{G}(A)$  such that the global asynchronous transducer of  $A$  is realized by the local asynchronous transducer of  $\mathcal{G}(A)$ .

### Gossip Automaton

It turns out that one must make crucial use of the latest information that the agents have about each other when defining the automaton  $\mathcal{G}(A)$ . It has been shown in [15] that this information can be kept track of by a deterministic asynchronous automaton whose size depends only on  $\tilde{\Sigma}$ .

To bring out the relevant properties of this automaton, we start with more notation. Let  $t = (E, \leq, \lambda) \in TR(\tilde{\Sigma})$ ,  $c \in \mathcal{C}_t$  and  $i, j \in \mathcal{P}$ . Then  $\downarrow^i(c)$  is the  $i$ -view of  $c$  and it is defined by:  $\downarrow^i(c) = \downarrow(c \cap E_i)$ . We note that  $\downarrow^i(c)$  is also a configuration. It is the “best” configuration that the agent  $i$  is aware of at  $c$ . It is easy to see that if  $\downarrow^i(c) \neq \emptyset$ , then there exists  $e \in E_i$  such that  $\downarrow^i(c) = \downarrow e$ . For  $P \subseteq \mathcal{P}$  and  $c \in \mathcal{C}_t$ , we let  $\downarrow^P(c)$  denote the set  $\bigcup_{i \in P} \downarrow^i(c)$ . Once again,  $\downarrow^P(c)$  is a configuration. It represents the collective knowledge of the processes in  $P$  about  $c$ .

For each subset  $P$  of processes, the function  $\text{latest}_{t,P}: \mathcal{C}_t \times \mathcal{P} \rightarrow P$  is given by  $\text{latest}_{t,P}(c, j) = \ell$  if and only if  $\ell$  is the least<sup>2</sup> member of  $P$  with  $\downarrow^j(\downarrow^k(c)) \subseteq \downarrow^j(\downarrow^\ell(c))$  for all  $k$  in  $P$ . In other words, among the agents in  $P$ , process  $\ell$  has the best information about  $j$  at  $c$ .

► **Theorem 34** (Gossip Automaton [15]). *There exists an asynchronous automaton  $\mathcal{G} = (\{\Upsilon_i\}, \{\nabla_a\}, v_{\text{in}})$  such that for each  $P = \{i_1, i_2, \dots, i_n\}$ , there exists a function  $\text{gossip}_P: \Upsilon_{i_1} \times \Upsilon_{i_2} \times \dots \times \Upsilon_{i_n} \times \mathcal{P} \rightarrow P$  with the following property. Let  $t \in TR(\tilde{\Sigma})$ ,  $c \in \mathcal{C}_t$ ,  $j \in \mathcal{P}$  and let  $\rho_t$  be the unique run of  $\mathcal{G}$  over  $t$  with  $\rho_t(c) = v$ . Then  $\text{latest}_{t,P}(c, j) = \text{gossip}_P(v(i_1), \dots, v(i_n), j)$ .*

Henceforth, we refer to  $\mathcal{G}$  as the *gossip automaton*.

### Translation

Now we describe the construction of  $\mathcal{G}(A)$  from  $A$ . Roughly speaking, in the automaton  $\mathcal{G}(A)$ , each process  $i$  keeps track of the best global state of  $A$  that it is aware of, and its local gossip state in the gossip automaton. When processes synchronize, they use the joint gossip-state information to correctly update the best global state that they are aware of at the synchronizing event. Of course, they also update their own local gossip states.

Recall that  $A = (\{S_i\}, \{\delta_a\}, s_{\text{in}})$ . For each  $i \in \mathcal{P}$ , let  $S_i^{\mathcal{G}} = \Upsilon_i \times S_{\mathcal{P}}$ . Further, let  $P = \{i_1, i_2, \dots, i_n\}$ . We define the function  $\text{globalstate}_P: S_P^{\mathcal{G}} \rightarrow S_{\mathcal{P}}$  as follows. Let  $(v_{i_1}, s_{i_1}) \in S_{i_1}^{\mathcal{G}}$ ,  $(v_{i_2}, s_{i_2}) \in S_{i_2}^{\mathcal{G}}$ ,  $\dots$ ,  $(v_{i_n}, s_{i_n}) \in S_{i_n}^{\mathcal{G}}$ . Then

$$\text{globalstate}_P((v_{i_1}, s_{i_1}), (v_{i_2}, s_{i_2}), \dots, (v_{i_n}, s_{i_n})) = s \in S_{\mathcal{P}}$$

where, for each  $i \in \mathcal{P}$ ,

$$s(i) = s_\ell(i) \text{ with } \ell = \text{gossip}_P(v_{i_1}, v_{i_2}, \dots, v_{i_n}, i)$$

We define the asynchronous automaton  $\mathcal{G}(A)$  to be  $(\{S_i^{\mathcal{G}}\}, \{\delta_a^{\mathcal{G}}\}, s_{\text{in}}^{\mathcal{G}})$ . The initial state  $s_{\text{in}}^{\mathcal{G}}$  is defined by letting, for each  $i \in \mathcal{P}$ ,  $s_{\text{in}}^{\mathcal{G}}(i) = v_{\text{in}}(i) \times s_{\text{in}}$ . Now we describe the transition functions  $\{\delta_a^{\mathcal{G}}: S_a^{\mathcal{G}} \rightarrow S_a^{\mathcal{G}}\}_{a \in \Sigma}$ . Let  $a \in \Sigma$  with  $\text{loc}(a) = \{i_1, i_2, \dots, i_n\}$  and  $s_a^{\mathcal{G}} \in S_a^{\mathcal{G}}$  with  $s_a^{\mathcal{G}}(i) = (v_i, s_i)$  for each  $i \in \text{loc}(a)$ . Suppose  $\nabla_a((v_{i_1}, v_{i_2}, \dots, v_{i_n})) = ((v'_{i_1}, v'_{i_2}, \dots, v'_{i_n}))$ . Now we set  $\delta_a^{\mathcal{G}}(s_a^{\mathcal{G}}) = s_a'^{\mathcal{G}}$ , such that, for each  $i \in \text{loc}(a)$ ,  $s_a'^{\mathcal{G}}(i) = (v'_i, s')$  where  $s' = \Delta_a(s)$  (recall that  $\Delta_a$  is the global transition function of  $A$ ) and  $s = \text{globalstate}_{\text{loc}(a)}(s_a^{\mathcal{G}})$ .

The next proposition says that, the best global state of  $A$  that a subset  $P$  of processes are collectively aware of, can be recovered from the *local*  $P$ -joint state of  $\mathcal{G}(A)$ . Thanks to Theorem 34, the proof is not very difficult albeit notationally somewhat cumbersome. We skip the proof here.

► **Proposition 35.** *With the notation above, the family of functions  $\{\text{globalstate}_P\}_{P \subseteq \mathcal{P}}$  has the following property. Let  $t \in TR(\tilde{\Sigma})$  and  $c \in \mathcal{C}_t$ . Further, let  $\rho_t$  and  $\rho_t^{\mathcal{G}}$  be the unique runs of  $A$  and  $\mathcal{G}(A)$  over  $t$  with  $\rho_t^{\mathcal{G}}(c) = s^{\mathcal{G}}$ . Then  $\rho_t(\downarrow^P(c)) = \text{globalstate}_P(s_P^{\mathcal{G}})$ , for each  $P \subseteq \mathcal{P}$ .*

Let  $\text{globalstate}: \Sigma^{\parallel S_{\mathcal{G}}} \rightarrow \Sigma^{S_{\mathcal{P}}}$  be defined as follows. For  $a \in \Sigma$  and  $s_a^{\mathcal{G}} \in S_a^{\mathcal{G}}$ , we set

$$\text{globalstate}((a, s_a^{\mathcal{G}})) = (a, \text{globalstate}_{\text{loc}(a)}(s_a^{\mathcal{G}}))$$

Now we are ready to state one of the main results of this section. It asserts that the global asynchronous transducer output of  $A$  can be obtained from the local asynchronous transducer output of  $\mathcal{G}(A)$  by a simple relabelling letter-to-letter morphism given by the  $\text{globalstate}$  function. Its proof is immediate and skipped.

<sup>2</sup> we assume an arbitrary total order on  $\mathcal{P}$

► **Theorem 36.** *Let  $A$  be an asynchronous automaton, let  $\theta_A: TR(\widetilde{\Sigma}) \rightarrow TR(\widetilde{\Sigma}^{\mathcal{SP}})$  be its global asynchronous transducer and let  $\chi_{\mathcal{G}(A)}: TR(\widetilde{\Sigma}) \rightarrow TR(\widetilde{\Sigma}^{\parallel_{S^{\mathcal{G}}}})$  be the local asynchronous transducer of  $\mathcal{G}(A)$ . Then if  $t = (E, \leq, \lambda) \in TR(\widetilde{\Sigma})$  and  $\chi_{\mathcal{G}(A)}(t) = (E, \leq, \mu)$ , then  $\theta_A(t) = (E, \leq, \nu) \in TR(\widetilde{\Sigma}^{\mathcal{SP}})$  where, for  $e \in E$ ,  $\nu(e) = \text{globalstate}(\mu(e))$*

### 5.3 Global Cascade Product

Now we are ready to define a cascade model which uses the global asynchronous transducer.

► **Definition 37 (Operational Global Cascade Product).** *Let  $A_1 = (\{S_i\}, \{\delta_a\}, s_{in})$  be an asynchronous automaton over  $\widetilde{\Sigma}$ , and  $A_2 = (\{Q_i\}, \{\delta_{(a,s)}\}, q_{in})$  be an asynchronous automaton over  $\widetilde{\Sigma}^{\mathcal{SP}}$ . Then their operational global cascade product, denoted by  $A_1 \circ_g A_2$ , is a cascade model where, for any input trace  $t \in TR(\widetilde{\Sigma})$ ,  $A_1$  runs on  $t$  (and ‘outputs’  $\theta_{A_1}(t)$ ) and  $A_2$  runs on  $\theta_{A_1}(t)$ . See Figure 10.*

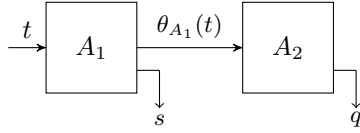

■ **Figure 10** Operational view of global cascade product

Note that  $A_1 \circ_g A_2$  is not, a priori, an asynchronous automaton, but in view of the discussion in the preceding subsection, it is simulated by the asynchronous automaton  $\mathcal{G}(A_1) \circ_\ell A_2$ .

For simplicity, we view  $A_1 \circ_g A_2$  as an (asynchronous) automaton with same state space as  $A_1 \circ_\ell A_2$ , and extend the notions of run, acceptance etc. to it in a natural way. Thus, a run of  $A_1 \circ_g A_2$  on  $t \in TR(\widetilde{\Sigma})$  is a tuple  $(\rho_t, \rho_{\theta_{A_1}(t)})$ . As  $t$  and  $\theta_{A_1}(t)$  have the same set of underlying events with identical causality and concurrent relationships, both  $t$  and  $\theta_{A_1}(t)$  admit the same set of configurations. In view of this, we abuse the notation slightly and write the run as  $(\rho_t^1, \rho_t^2)$  where  $\rho_t^1: \mathcal{C}_t \rightarrow \mathcal{S}_{\mathcal{P}}$  and  $\rho_t^2: \mathcal{C}_t \rightarrow \mathcal{Q}_{\mathcal{P}}$ . Similarly, the label of any event  $e$  in  $t$  (resp.  $\theta_{A_1}(t)$ ) is denoted by  $\lambda^1(e)$  (resp.  $\lambda^2(e)$ ). We also use  $A_1 \circ_g A_2$  to accept a language by specifying a final subset (of global states)  $F \subseteq \mathcal{S}_{\mathcal{P}} \times \mathcal{Q}_{\mathcal{P}}$ . As expected, an input trace  $t = (E, \leq, \lambda) \in TR(\widetilde{\Sigma})$  is accepted if  $(\rho_t^1(E), \rho_t^2(E)) \in F$ . Henceforth, we refer to the operational global cascade product as the simply global cascade product.

We consider an asynchronous automaton  $A$  as a *base* global cascade product. Now we use structural induction to define the *binary* global cascade product  $B_1 \circ_g B_2$  where  $B_1$  and  $B_2$  are themselves global cascade products: global states of  $B_1 \circ_g B_2$  is the product of global states of  $B_1$  and  $B_2$ ; its run on  $t$  consists of a run of  $B_1$  on  $t$  and a run of  $B_2$  on  $\theta_{B_1}(t)$ ; its global asynchronous transducer is  $\theta_{B_1} \circ \theta_{B_2}$ . We also define the notion of a language being accepted by  $B_1 \circ_g B_2$  as expected.

It is easy to see that, for automata  $A_1, A_2, A_3$ , the global cascade products  $(A_1 \circ_g A_2) \circ_g A_3$  and  $A_1 \circ_g (A_2 \circ_g A_3)$  can be identified naturally in terms of global states, runs, accepted languages etc. In this sense, the global cascade product is associative. See Figure 11 for an intuitive explanation of this associativity.

Thanks to this, we can talk about the global cascade product of a *sequence* of asynchronous automata. The earlier notations, such as  $(\rho_t^1, \rho_t^2)$  of a run etc., are easily extended. In this general setting, the distributed alphabet for the  $m$ -th asynchronous automata in the sequence is denoted by  $\widetilde{\Sigma}^m$ . So, for instance, in Definition 37, we have  $\widetilde{\Sigma}^1 = \widetilde{\Sigma}$  and  $\widetilde{\Sigma}^2 = \widetilde{\Sigma}^{\mathcal{SP}}$ .

The following *global cascade product principle* is an easy consequence of the definitions.

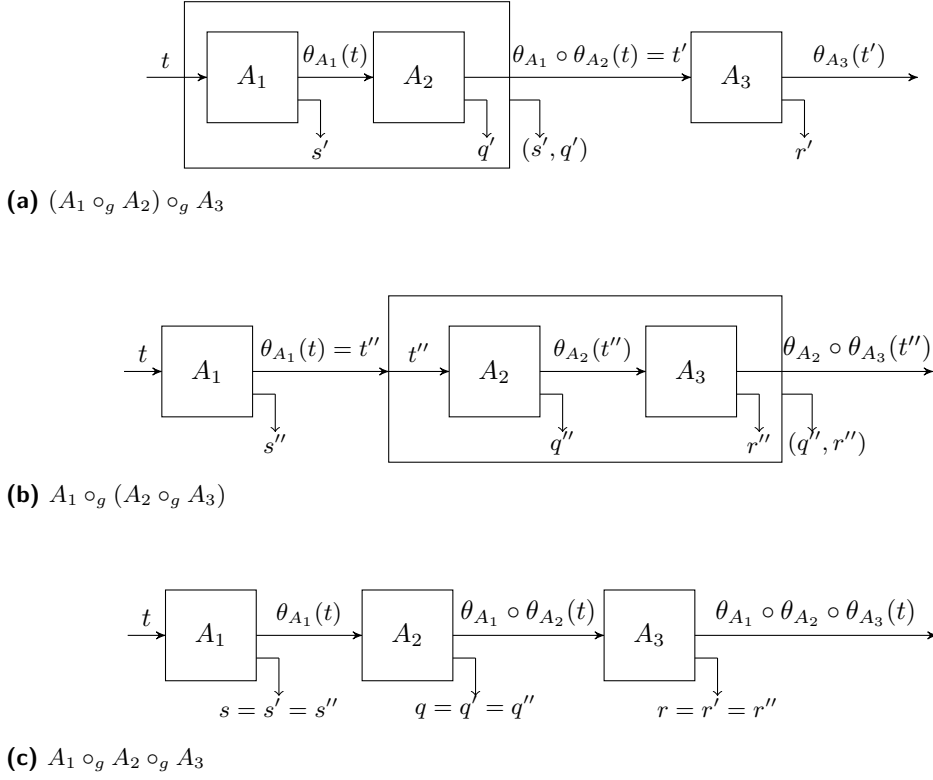

■ **Figure 11** Associativity of global cascade product

► **Theorem 38.** *Let  $A$  (resp.  $B$ ) be a global cascade product over  $\tilde{\Sigma}$  (resp.  $\tilde{\Sigma}^{S_{\mathcal{P}}}$ ), where  $S_{\mathcal{P}}$  is the set of global states of  $A$ . Then any language  $L \subseteq TR(\tilde{\Sigma})$  accepted by  $A \circ_g B$  is a finite union of languages of the form  $U \cap \theta_A^{-1}(V)$  where  $U \subseteq TR(\tilde{\Sigma})$  is accepted by  $A$ , and  $V \subseteq TR(\tilde{\Sigma}^{S_{\mathcal{P}}})$  is accepted by  $B$ .*

## 6 Temporal Logics, Aperiodic Trace Languages & Cascade Products

An automata-theoretic consequence of Theorem 29 is that any aperiodic trace language (that is, a trace language recognized by an aperiodic monoid) over an acyclic architecture is accepted by a local cascade product of localized two-state reset automata. In this section, we generalize this result to any distributed alphabet, but using global cascade product of the same distributed resets. We call these automata  $U_2[\ell]$  as well; that is, in this section,  $U_2[\ell]$  refers to an asynchronous automata whose transition atm (recall discussion of Lemma 10) is a sub-atm of  $U_2[\ell]$  from Example 6. So  $U_2[\ell] = (\{S_i\}, \{\delta_a\}, s_{\text{in}})$  where  $S_\ell = \{1, 2\}$  and  $S_i$  is a singleton set for  $i \neq \ell$ . A global state of  $U_2[\ell]$  is identified with its  $\ell$ -component. Furthermore  $\Sigma_\ell$  has two disjoint subsets  $R_1, R_2$  that reset the state of the automata to 1 and 2 respectively. All remaining letters do not change states.

Our proof uses a process-based past local temporal logic (over traces) called  $\text{LocTL}[Y_i, S_i]$  that exactly defines aperiodic trace languages. This expressive completeness property of  $\text{LocTL}[Y_i, S_i]$  is an easy consequence of a non-trivial result from [3], where the future version of

a similar local temporal logic is shown to coincide with first-order logic definable, equivalently, aperiodic trace languages. The syntax of  $\text{LocTL}[Y_i, S_i]$  is as follows.

$$\begin{aligned} \text{Event formula } \alpha &= a \mid \neg\alpha \mid \alpha \vee \beta \mid Y_i \alpha \mid \alpha S_i \alpha & a \in \Sigma, i \in \mathcal{P} \\ \text{Trace formula } \beta &= \exists_i \alpha \mid \neg\beta \mid \beta \vee \gamma \end{aligned}$$

The semantics of the logic is given below. Each event formula is evaluated at an event of a trace. Let  $t = (E, \leq, \lambda) \in \text{TR}(\tilde{\Sigma})$  be a trace with  $e \in E$ . For any event  $x$  in  $t$  and  $i \in \mathcal{P}$ , we denote by  $x_i$  the unique maximal event of  $(\downarrow x \setminus \{x\}) \cap E_i$ , if it exists.

$$\begin{aligned} t, e \models a & \quad \text{if } \lambda(e) = a \\ t, e \models \neg\alpha & \quad \text{if } t, e \not\models \alpha \\ t, e \models \alpha \vee \beta & \quad \text{if } t, e \models \alpha \text{ or } t, e \models \beta \\ t, e \models Y_i \alpha & \quad \text{if } e_i \text{ exists, and } t, e_i \models \alpha \\ t, e \models \alpha S_i \alpha' & \quad \text{if } e \in E_i \text{ and } \exists f \in E_i \text{ such that } f < e \text{ and } t, f \models \alpha' \\ & \quad \text{and } \forall g \in E_i \ f < g < e \Rightarrow t, g \models \alpha \end{aligned}$$

Note that the since operator is a strict version.  $\text{LocTL}[Y_i, S_i]$  trace formulas are evaluated for traces, with the following semantics.

$$t \models \exists_i \alpha \quad \text{if there exists a maximal } i\text{-event } e \text{ in } t \text{ such that } t, e \models \alpha$$

The semantics of the boolean combinations of trace formulas are obvious. Any  $\text{LocTL}[Y_i, S_i]$  trace formula  $\beta$  over  $\tilde{\Sigma}$  defines the trace language  $L_\beta = \{t \in \text{TR}(\tilde{\Sigma}) \mid t \models \beta\}$ . The following lemma shows that  $\text{LocTL}[Y_i, S_i]$  is expressively complete.

► **Lemma 39.** *A trace language is defined by a  $\text{LocTL}[Y_i, S_i]$  formula if and only if it is defined by an FO formula.*

**Proof.** In paper [3], a process based pure future local temporal logic is shown to be expressively equivalent to first order logic over traces. We consider its past dual here with following syntax and semantics for the event formulas.

$$\alpha = \top \mid a \mid \neg\alpha \mid \alpha \vee \beta \mid Y_i \alpha \mid \alpha S_i \alpha \quad a \in \Sigma, i \in \mathcal{P}$$

$$\begin{aligned} t, e \models \alpha S_i \alpha' & \quad \text{if } \exists f \in E_i \text{ such that } f \leq e \text{ and } t, f \models \alpha' \\ & \quad \text{and } \forall g \in E_i \text{ if } f < g \leq e \text{ then } t, g \models \alpha \end{aligned}$$

We only need to show that  $\text{LocTL}[Y_i, S_i]$  is expressive enough to define the  $S_i$  operator. Consider the  $\text{LocTL}[Y_i, S_i]$  formulas  $\gamma = \alpha' \vee (\alpha \wedge \alpha S_i \alpha')$  and  $i = \bigvee_{a \in \Sigma_i} a$ . Then  $\alpha S_i \alpha'$  is equivalent to the  $\text{LocTL}[Y_i, S_i]$  formula  $(i \wedge \gamma) \vee (\neg i \wedge Y_i \gamma)$ . ◀

► **Theorem 40.** *A trace language is defined by a  $\text{LocTL}[Y_i, S_i]$  formula if and only if it is accepted by a global cascade product of  $U_2[\ell]$ .*

In conjunction with Lemma 39, Theorem 40 gives a new characterization of first order definable trace languages. Before giving its proof, we provide a local temporal logic characterization for local cascade product of  $U_2[\ell]$ . The corresponding local temporal logic  $\text{LocTL}[S_i]$  is simply the fragment of  $\text{LocTL}[Y_i, S_i]$  where  $Y_i$  is disallowed. The semantics is inherited. It is unknown whether the logic  $\text{LocTL}[S_i]$  is as expressive as  $\text{LocTL}[Y_i, S_i]$ .

► **Theorem 41.** *A trace language is defined by a  $\text{LocTL}[S_i]$  formula if and only if it is recognized by local cascade product of  $U_2[\ell]$ .*

**Proof.** ( $\Leftarrow$ ) Consider a local cascade product  $A = U_2[j] \circ_\ell B$ . By the wreath product principle of Theorem 19, and the relation between local cascade of automata and asynchronous morphism into local wreath product of atm, we know that any language recognized by  $A$  is a union of languages of the form  $L_1 \cap \chi^{-1}(L_2)$  where  $L_1 \subseteq TR(\widetilde{\Sigma})$  is recognized by  $U_2[j]$ , the language  $L_2 \subseteq TR(\widetilde{\Sigma}^{\parallel s})$  is recognized by  $B$ , and  $\chi$  is the local asynchronous transducer associated to  $U_2[j]$  and its initial state, say 1.

With global accepting state 2, the language accepted by  $U_2[j]$  is defined by the formula  $\exists_j(R_2 \vee (\neg R_1 \wedge ((\neg R_1) S_j R_2)))$ . The language accepted by  $U_2[j]$  with global accepting state 1 can be defined with a similar formula. The difference is that, 1 being the initial state, we also have to consider the case where process  $j$  contains no events or no events from  $R_2$ . Hence we use the formula  $(\neg \exists_j \top) \vee \exists_j(R_1 \vee (\neg R_2 \wedge \neg(\neg R_1 S_j R_2)))$ .

By induction on the number of  $U_2[\ell]$ s in the local cascade product, we know that  $L_2$  is  $\text{LocTL}[S_i]$  definable over alphabet  $\widetilde{\Sigma}^{\parallel s}$ . Thus we only need to prove that  $\chi^{-1}(L_2)$  is  $\text{LocTL}[S_i]$  definable over  $\widetilde{\Sigma}$ . We prove this by structural induction on  $\text{LocTL}[S_i]$  formulas over  $\widetilde{\Sigma}^{\parallel s}$ . For  $\text{LocTL}[S_i]$  event formula  $\alpha$  over  $\widetilde{\Sigma}^{\parallel s}$ , we provide  $\hat{\alpha}$  over  $\widetilde{\Sigma}$  such that for any trace  $t \in TR(\widetilde{\Sigma})$ , and any event  $e$  in  $t$ , we have  $t, e \models \hat{\alpha}$  if and only if  $\chi(t), e \models \alpha$ . The non-trivial case here is the base case of letter formula  $\alpha = (a, s_a)$ . If  $j \notin \text{loc}(a)$ , then  $\hat{\alpha} = a$ , else if  $[s_a]_j = 2$ , then  $\hat{\alpha} = a \wedge (\neg R_1) S_j R_2$ . Other cases can be handled similarly.

( $\Rightarrow$ ) For any  $\text{LocTL}[S_i]$  event formula  $\alpha$ , we create an asynchronous automaton  $A_\alpha$  such that for any trace  $t$  and its event  $e$ , from the local state  $[\rho_t(\downarrow e)]_i$  for any  $i \in \text{loc}(e)$ , one can deduce whether  $t, e \models \alpha$ . Furthermore the asynchronous automaton  $A_\alpha$  is a local cascade product of  $U_2[\ell]$ s. The construction is done by structural induction on the  $\text{LocTL}[S_i]$  event formulas.

**Base Case:** When  $\alpha = a \in \Sigma$ , let  $A_\alpha = (\{S_i\}, \{\delta_a\}, s_{\text{in}})$  where  $S_i = \{\perp\}$  for all  $i \notin \text{loc}(a)$ , and  $S_i = \{\top, \perp\}$  for all  $i \in \text{loc}(a)$ . For any  $P$ -state  $s$ , if for all  $i \in P$  we have  $s_i = \perp$ , then we denote  $s = \perp$ ; similarly for  $\top$ . Initial state  $s_{\text{in}} = \perp$ . For local transitions,  $\delta_b$  is a reset to  $\top$  if  $b = a$ , and it is a reset to  $\perp$  otherwise. By construction we ensure that, for all  $i \in \text{loc}(a)$  we have  $[\rho_t(\downarrow e)]_i = \top$  if and only if  $t, e \models \alpha$ . It is also easy to see that  $A_\alpha$  is a local cascade product of  $U_2[j]$  for  $j \in \text{loc}(a)$ .

**Inductive Case:** The non-trivial case is  $\alpha = \beta S_j \gamma$ . By inductive hypothesis, we can assume  $A_\beta$  and  $A_\gamma$  are available. For simplicity, we assume  $A = (\{S_i\}, \{\delta_a\}, s_{\text{in}})$  simultaneously provides truth value of  $\beta$  and  $\gamma$  at any event. We construct  $B = (\{Q_i\}, \{\delta_{(a, s_a)}\}, q_{\text{in}})$  over  $\widetilde{\Sigma}^{\parallel s}$  such that  $A \circ_\ell B$  is the required asynchronous automaton. Let  $Q_i = \{\top, \perp\}$  for all  $i \in \mathcal{P}$ . Again, we denote a  $P$ -state  $q$  as  $\perp$  if  $q_i = \perp$  for all  $i \in P$ ; similarly for  $\top$ . Initial state  $q_{\text{in}} = \perp$ . For any  $a \notin \Sigma_j$ ,  $\delta_{(a, s_a)}$  is a reset to  $\perp$ . Note that if  $\chi$  is the local asynchronous transducer associated with  $A$ , and in  $\chi(t)$  a  $j$ -event  $e$  is labelled  $(a, s_a)$ , then  $[s_a]_j$  tells us the truth value of  $\beta$  and  $\gamma$  at the previous  $j$ -event  $e_j$ , if it exists. Let us denote this by  $[s_a]_j \vdash \beta$  (resp.  $[s_a]_j \vdash \neg\beta$ ) if at the previous  $j$ -event,  $\beta$  is true (resp. false) according to the  $j$  state of



$s_a$ . Then the transition for  $a \in \Sigma_j$  is given by

$$\begin{aligned} \delta_{(a,s_a)} &= \text{reset to } \top && \text{if } [s_a]_j \vdash \gamma \\ \delta_{(a,s_a)} &= \text{reset to } \perp && \text{if } [s_a]_j \vdash \neg\gamma \text{ and } [s_a]_j \vdash \neg\beta \\ \delta_{(a,s_a)}(q_a) &= \top && \text{if } [s_a]_j \vdash \neg\gamma \text{ and } [s_a]_j \vdash \beta \text{ and } [q_a]_j = \top \\ \delta_{(a,s_a)}(q_a) &= \perp && \text{if } [s_a]_j \vdash \neg\gamma \text{ and } [s_a]_j \vdash \beta \text{ and } [q_a]_j = \perp \end{aligned}$$

The transitions make sense if we recall the identity  $\beta \mathbf{S}_j \gamma \equiv \mathbf{O}_j(\gamma \vee (\beta \wedge (\beta \mathbf{S}_j \gamma)))$ , where  $\mathbf{O}_j \chi \equiv \perp \mathbf{S}_j \chi$ . Note that in the last two transitions above,  $\delta_{(a,s_a)}$  is the identity transformation on the process  $j$  state; the other processes of  $\text{loc}(a)$  can update their states mimicking process  $j$  state update if they have the previous process  $j$  state information available. In view of this, it is easy to verify that  $B$  is a local cascade product of  $U_2[j]$  followed by  $U_2[\ell]$  for  $\ell \neq j$ . ◀

We now give the proof of Theorem 40.

**Proof of Theorem 40.** ( $\Leftarrow$ ) Consider a global cascade product  $A = U_2[\ell] \circ_g B$ . By the global cascade product principle of Theorem 38, any language recognized by  $A$  is a union of languages of the form  $L_1 \cap \theta^{-1}(L_2)$  where  $L_1 \subseteq TR(\widetilde{\Sigma})$  is recognized by  $U_2[\ell]$ , and the language  $L_2 \subseteq TR(\widetilde{\Sigma}^{\mathcal{S}_P})$  is recognized by  $B$ , and  $\theta$  is the global asynchronous transducer associated with  $U_2[\ell]$  and its initial state, say 1. We have seen in the proof of Theorem 41 that  $L_1$  is  $\text{LocTL}[S_i]$  definable over alphabet  $\widetilde{\Sigma}$ .

By induction on the number of  $U_2[j]$ s in the global cascade product, we know that  $L_2$  is  $\text{LocTL}[Y_i, S_i]$  definable over alphabet  $\widetilde{\Sigma}^{\mathcal{S}_P}$ . Thus we only need to prove that  $\theta^{-1}(L_2)$  is  $\text{LocTL}[Y_i, S_i]$  definable over  $\widetilde{\Sigma}$ . We prove this by structural induction on  $\text{LocTL}[Y_i, S_i]$  formulas over  $\widetilde{\Sigma}^{\mathcal{S}_P}$ . For  $\text{LocTL}[Y_i, S_i]$  event formula  $\alpha$  over  $\widetilde{\Sigma}^{\mathcal{S}_P}$ , we provide  $\hat{\alpha}$  over  $\widetilde{\Sigma}$  such that for any trace  $t \in TR(\widetilde{\Sigma})$ , and any event  $e$  in  $t$ , we have  $t, e \models \hat{\alpha}$  if and only if  $\theta(t), e \models \alpha$ . The non-trivial case here is the base case of letter formula, say  $\alpha = (a, 2)$ . In this case  $\hat{\alpha} = a \wedge Y_\ell(R_2 \vee (\neg R_1 \wedge ((\neg R_1) S_\ell R_2)))$ . Inductive cases are trivial. For instance  $\widehat{Y_i \alpha} = Y_i \hat{\alpha}$ . Other cases are similar.

( $\Rightarrow$ ) For any  $\text{LocTL}[Y_i, S_i]$  event formula  $\alpha$ , we create an asynchronous automaton  $A_\alpha$  such that for any trace  $t$  and its event  $e$ , from the local state  $[\rho_t(\downarrow e)]_i$  for any  $i \in \text{loc}(e)$ , one can deduce whether  $t, e \models \alpha$ . Furthermore  $A_\alpha$  is a global cascade product of  $U_2[\ell]$ s. The construction is done by structural induction on the  $\text{LocTL}[Y_i, S_i]$  event formulas. Since the  $\text{LocTL}[S_i]$  proof is done, we only need to deal with the inductive case of  $Y_j \beta$ .

**Inductive Case:** Suppose  $\alpha = Y_j \beta$ . By inductive hypothesis, we can assume  $A_\beta$  is available, and provides truth value of  $\beta$  at any event. We construct  $B = (\{Q_i\}, \{\delta_{(a,s_a)}\}, q_{\text{in}})$  over  $\widetilde{\Sigma}^{\mathcal{S}_P}$  such that  $A_\alpha = A_\beta \circ_g B$ . Let  $Q_i = \{\top, \perp\}$  for all  $i \in \mathcal{P}$ . We denote a  $P$ -state  $q$  as  $\perp$  if  $q_i = \perp$  for all  $i \in P$ ; similarly for  $\top$ . Initial state  $q_{\text{in}} = \perp$ . Let  $\theta$  be the global asynchronous transducer associated with  $A_\beta$ . For any trace  $t \in TR(\widetilde{\Sigma})$ , let  $e$  be an event in  $t$ . If the label of  $e$  in  $\theta(t)$  is  $(a, s)$ , then note that  $s_j$  tells us the truth value of  $\beta$  at the event  $e_j$ , if it exists. Let us denote this by  $s_j \vdash \beta$  and  $s_j \vdash \neg\beta$  depending on whether  $\beta$  is respectively true and false at  $e_j$ , according to  $s_j$ . The transition rules are simple

$$\begin{aligned} \delta_{(a,s)} &= \text{reset to } \top && \text{if } s_j \vdash \beta \\ \delta_{(a,s)} &= \text{reset to } \perp && \text{if } s_j \vdash \neg\beta \end{aligned}$$

This state update works same for all processes, and it is easy to see that  $B$  is, in fact, a local cascade product of  $U_2[\ell]$ s. However,  $B$  requires the global state information from  $A_\beta$ , and so there is a global cascade product between  $A_\beta$  and  $B$ .

This completes the proof. ◀

Note that if our postulated decomposition (see Question 1) were true, it would imply that  $\text{LocTL}[S_i]$  is expressively complete, which would be a stronger temporal logic characterization for aperiodic, or equivalently first-order logic definable trace languages than what is currently known. In particular, by Theorem 29,  $\text{LocTL}[S_i]$  is expressively complete over tree architecture. And this holds true for any distributed alphabet where Question 1 admits a positive answer.

## 7 Conclusion

We have presented an algebraic framework equipped with wreath products and proved a wreath product principle which is well suited for the analysis of trace languages. Building on this framework, we have postulated a natural decomposition theorem which has been proved for the case of acyclic architectures. This special case already provides an interesting generalization of the Krohn-Rhodes theorem. It simultaneously proves Zielonka's theorem for acyclic architectures.

The wreath product operation in the new framework, when viewed in terms of automata, manifests itself in the form of a local cascade product of asynchronous automata. We have also proposed global cascade products of asynchronous automata and applied them to arrive at a novel decomposition of aperiodic trace languages. This is a non-trivial and truly concurrent generalization of the cascade decomposition of aperiodic word languages using two-state reset automata.

---

## References

- 1 Bharat Adsul and Milind A. Sohoni. Asynchronous automata-theoretic characterization of aperiodic trace languages. In *FSTTCS 2004: Foundations of Software Technology and Theoretical Computer Science, 24th International Conference, Chennai, India, December 16-18, 2004, Proceedings*, pages 84–96, 2004. doi:10.1007/978-3-540-30538-5\_8.
- 2 Joëlle Cohen, Dominique Perrin, and Jean-Eric Pin. On the expressive power of temporal logic. *Journal of Computer and System Sciences*, 46(3):271–294, 1993.
- 3 Volker Diekert and Paul Gastin. Pure future local temporal logics are expressively complete for mazurkiewicz traces. *Inf. Comput.*, 204(11):1597–1619, 2006. doi:10.1016/j.ic.2006.07.002.
- 4 Volker Diekert, Manfred Kufleitner, and Benjamin Steinberg. The Krohn-Rhodes theorem and local divisors. *Fundam. Inform.*, 116(1-4):65–77, 2012. doi:10.3233/FI-2012-669.
- 5 Volker Diekert and Grzegorz Rozenberg. *The Book of Traces*. World Scientific Publishing Co., Inc., USA, 1995.
- 6 Samuel Eilenberg. *Automata, Languages and Machines*, volume B. Academic Press, 1976.
- 7 Giovanna Guaiana, Raphaël Meyer, Antoine Petit, and Pascal Weil. An extension of the wreath product principle for finite Mazurkiewicz traces. *Information Processing Letters*, 67(6):277 – 282, 1998. doi:10.1016/S0020-0190(98)00123-9.
- 8 Hans Kamp. *Tense Logic and the Theory of Linear Order*. PhD thesis, UCLA, 1968.
- 9 Siddharth Krishna and Anca Muscholl. A quadratic construction for Zielonka automata with acyclic communication structure. *Theor. Comput. Sci.*, 503(C):109–114, September 2013.
- 10 Kenneth Krohn and John Rhodes. Algebraic theory of machines I. prime decomposition theorem for finite semigroups and machines. *Transactions of The American Mathematical Society*, 116, 04 1965. doi:10.2307/1994127.

- 11 Antoni Mazurkiewicz. Concurrent program schemes and their interpretations. *DAIMI Report Series*, 6(78), Jul. 1977. doi:10.7146/dpb.v6i78.7691.
- 12 Robert McNaughton and Seymour A. Papert. *Counter-Free Automata*. M.I.T. Research Monograph Nr 65. The MIT Press, 1971.
- 13 Albert R. Meyer. A note on star-free events. *J. ACM*, 16(2):220–225, April 1969. doi:10.1145/321510.321513.
- 14 Madhavan Mukund. Automata on distributed alphabets. In Deepak D’Souza and Priti Shankar, editors, *Modern applications of automata theory*, pages 257–288. World Scientific, 2012.
- 15 Madhavan Mukund and Milind A. Sohoni. Keeping track of the latest gossip in a distributed system. *Distributed Computing*, 10(3):137–148, 1997. doi:10.1007/s004460050031.
- 16 Dominique Perrin and Jean-Eric Pin. *Infinite words - automata, semigroups, logic and games*, volume 141 of *Pure and applied mathematics series*. Elsevier Morgan Kaufmann, 2004.
- 17 Jean-Éric Pin. Mathematical foundations of automata theory. [www.irif.fr/~jep/PDF/MPRI/MPRI.pdf](http://www.irif.fr/~jep/PDF/MPRI/MPRI.pdf), 2019.
- 18 M.P. Schützenberger. On finite monoids having only trivial subgroups. *Information and Control*, 8(2):190 – 194, 1965. doi:10.1016/S0019-9958(65)90108-7.
- 19 Howard Straubing. *Finite automata, formal logic, and circuit complexity*. Birkhäuser Verlag, Basel, Switzerland, 1994.
- 20 Wiesław Zielonka. Notes on finite asynchronous automata. *RAIRO-Theoretical Informatics and Applications*, 21(2):99–135, 1987.