

A Finite Time Combinatorial Algorithm for Instantaneous Dynamic Equilibrium Flows

Lukas Graf and Tobias Harks *

Augsburg University, Institute of Mathematics, 86135 Augsburg
{lukas.graf,tobias.harks}@math.uni-augsburg.de

April 19, 2022

Instantaneous dynamic equilibrium (IDE) is a standard game-theoretic concept in dynamic traffic assignment in which individual flow particles myopically select en route currently shortest paths towards their destination. We analyze IDE within the Vickrey bottleneck model, where current travel times along a path consist of the physical travel times plus the sum of waiting times in all the queues along a path. Although IDE have been studied for decades, several fundamental questions regarding equilibrium computation and complexity are not well understood. In particular, all existence results and computational methods are based on fixed-point theorems and numerical discretization schemes and no exact finite time algorithm for equilibrium computation is known to date. As our main result we show that a natural extension algorithm needs only finitely many phases to converge leading to the first finite time combinatorial algorithm computing an IDE. We complement this result by several hardness results showing that computing IDE with natural properties is NP-hard.

1 Introduction

Flows over time or dynamic flows are an important mathematical concept in network flow problems with many real world applications such as dynamic traffic assignment, production systems and communication networks (e. g., the Internet). In such applications, flow particles that are send over an edge require a certain amount of time to travel through each edge and when routing decisions are being made, the dynamic flow propagation leads to later effects in other parts of the network. A key characteristic of such applications, especially in traffic assignment, is that the network edges have a limited flow capacity which, when exceeded, leads to congestion. This phenomenon can be captured by the the *fluid queueing model model* due to Vickrey [24]. The model is based on a directed graph $G = (V, E)$, where every edge e has an associated physical transit time $\tau_e \in \mathbb{R}_+$ and a maximal rate capacity

*The research of the authors was funded by the Deutsche Forschungsgemeinschaft (DFG, German Research Foundation) - HA 8041/1-1 and HA 8041/4-1.

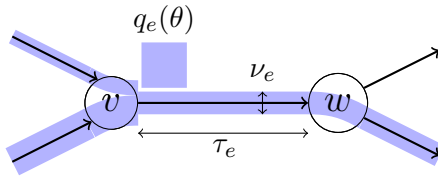

Figure 1: An edge $e = vw$. As the inflow rate at node v exceeds the edge's capacity, a queue forms at its tail.

$\nu_e \in \mathbb{R}_+$. If flow enters an edge with higher rate than its capacity the excess particles start to form a queue at the edge's tail, where they wait until they can be forwarded onto the edge (cf. Figure 1). Thus, the total travel time experienced by a single particle traversing an edge e is the sum of the time spent waiting in the queue of e and the physical transit time τ_e .

This physical flow model then needs to be enhanced with a *behavioral model* prescribing the actions of flow particles. There are two main standard behavioral models in the traffic assignment literature known as *dynamic equilibrium (DE)* (cf. Ran and Boyce [20, § V-VI] and *instantaneous dynamic equilibrium (IDE)* ([20, § VII-IX]). Under DE, flow particles have complete information on the state of the network for all points in time (including the future evolution of all flow particles) and based on this information travel along a shortest path. The full information assumption is usually justified by assuming that the game is played repeatedly and a DE is then an attractor of a learning process. The behavioral model of IDE is based on the idea that drivers are informed in real-time about the current traffic situation and, if beneficial, reroute instantaneously no matter how good or bad that route will be in hindsight. Thus, at every point in time and at every decision node, flow only enters those edges that lie on a currently shortest path towards the respective sink. This concept assumes far less information (only the network-wide queue lengths which are continuously measured) and leads to a distributed dynamic using only present information that is readily available via real-time information. IDE has been proposed already in the late 80's (cf. Boyce, Ran and LeBlanc [1, 21] and Friesz et al. [7]).

A line of fairly recent works starting with Koch and Skutella [16] and Cominetti, Correa and Larré [3] derived very elegant combinatorial characterizations of DE for the fluid queueing model of Vickrey. They derived a complementarity description of DE flows via so-called *thin flows with resetting* which leads to an α -extension property stating that for any equilibrium up to time θ , there exists $\alpha > 0$ so that the equilibrium can be extended to time $\theta + \alpha$. An extension that is maximal with respect to α is called a *phase* in the construction of an equilibrium and the existence of equilibria on the whole \mathbb{R}_+ then follows by a limit argument over phases using Zorn's lemma. In the same spirit, Graf, Harks and Sering [9] established a similar characterization for IDE flows and also derived an α -extension property.

For both models (DE or IDE), it is an open question whether for constant inflow rates and a finite time horizon, a *finite number of phases* suffices to construct an equilibrium, see [3, 16] and [9]. This problem remains even unresolved for single-source single-sink series-parallel graphs as explicitly mentioned by Kaiser [15]. Proving finiteness of the number of phases would imply an exact finite time combinatorial algorithm. Such algorithm is not

known to date neither for DE nor for IDE.¹ More generally, the computational complexity of equilibrium computation is widely open.

1.1 Our Contribution and Proof Techniques

In this paper, we study IDE flows and derive algorithmic and computational complexity results. As our main result we settle the key question regarding finiteness of the α -extension algorithm.

Theorem 3.7: For single-sink networks with piecewise constant inflow rates for a finite time horizon, there is an α -extension algorithm computing an IDE after finitely many extension phases. This implies the first finite time combinatorial exact algorithm computing IDE within the Vickrey model.

The Vickrey model is arguably one of the most important traffic models (see Li, Huang and Yang [18] for a research overview of the past 50 years), and yet, to the best of our knowledge, our algorithm is the first finite time algorithm computing a dynamic instantaneous equilibrium in the continuous formulation. Let us remark that for dynamic equilibrium, such an algorithm is still not known to date.

The proof of our result is based on the following ideas. We first consider the case of *acyclic* networks and use a topological order of vertices in order to schedule the extension phases in the algorithm. The key argument for the finiteness of the number of extensions phases is that for a single node v and any interval with linearly changing distance labels of nodes closer to the sink and constant inflow rate into v this flow can be redistributed to the outgoing edges in a finite number of phases of constant outflow rates from v . We show this using the properties (derivatives) of suitable edge label functions for the outgoing edges (see Figure 4). The overall finiteness of the algorithm follows by induction over the nodes and time. We then generalize to arbitrary single-sink networks by considering *dynamically* changing topological orders depending on the current set of active edges. Finally, a closer inspection of the proofs also enables us to give an explicit upper bound on the number of extension steps in the order of

$$\mathcal{O}\left(P\left(2(\Delta + 1)^{4\Delta+1}\right)^{2L \cdot |E| \cdot T \cdot |V|}\right),$$

where P is the number of constant phases of the network inflow rates, Δ the maximum out degree in the network, T the termination time and L a bound on the derivatives of the distance labels depending on the network inflow rates and the edge capacities of the given network.

We then turn to the computational complexity of IDE flows. Our first result here is a lower bound on the output complexity of any algorithm. We construct an instance in which the unique IDE flow oscillates with a changing periodicity (see Figure 5).

¹Algorithms for DE or IDE computation used in the transportation science literature are *numerical*, that is, only approximate equilibrium flows are computed given a certain numerical precision, see the related work for a more detailed comparison.

Theorem 4.1: There are instances for which the output complexity of an IDE flow is not polynomial in the encoding size of the instance, even if we are allowed to use periodicity to reduce the encoding size of the flow.

We also show that several natural decision problems about the existence of IDE flows with certain properties are NP-hard.

Theorem 4.8: The following decision problems are all NP-hard:

- Given a specific edge: Is there an IDE using/not using this edge?
- Given some time horizon T : Is there an IDE that terminates before T ?
- Given some $k \in \mathbb{N}$: Is there an IDE with of at most k phases?

The proof is a reduction from 3SAT, wherein for any given 3SAT-formula we construct a network (see Figure 11) with the following properties: If the 3SAT-formula is satisfiable there exists a quit simple IDE flow, where all flow particles travel on direct paths towards the sink. If, on the other hand, the 3SAT-formula is unsatisfiable all IDE flows in the corresponding network lead to congestions diverting a certain amount of flow into a separate part of the network. Placing different gadgets in this part of networks then allows for the reduction to various decision problems involving IDE flows.

1.2 Related Work

The concept of flows over time was studied by Ford and Fulkerson [5]. Shortly after, Vickrey [24] introduced a game-theoretic variant using a deterministic queueing model. Since then, dynamic equilibria have been studied extensively in the transportation science literature, see Friesz et al. [7]. New interest in this model was raised after Koch and Skutella [16] gave a novel characterization of dynamic equilibria in terms of a family of static flows (thin flows). Cominetti, Correa and Larré [3] refined this characterization and Koch and Sering [23] incorporated spillbacks in the fluid queueing model. In a very recent work, Kaiser [15] showed that the thin flows needed for the extension step in computing dynamic equilibria can be determined in polynomial time for series-parallel networks. The papers [3, 15] explicitly mention the problem of possible non-finiteness of the extension steps.

In the traffic assignment literature, the concept of IDE was studied by several papers such as Ran and Boyce [20, § VII-IX], Boyce, Ran and LeBlanc [1, 21], Friesz et al. [7]. These works develop an optimal control-theoretic formulation and characterize instantaneous user equilibria by Pontryagin’s optimality conditions. For solving the control problem, Boyce, Ran and LeBlanc [1] proposed to discretize the model resulting in finite dimensional NLP whose optimal solutions correspond to approximative IDE. While this approach only gives an approximative equilibrium, there are further difficulties. The control-theoretic formulation is actually not compatible with the deterministic queueing model of Vickrey. In Boyce, Ran and LeBlanc [1], a differential equation per edge governing the cumulative edge flow (state variable) is used. The right-hand side of the differential equation depends on the exit flow function which is assumed to be differentiable and strictly positive for any positive inflow. Both assumptions (positivity and differentiability) are not satisfied for the Vickrey model. For example, flow entering an empty edge needs a strictly positive time after which it leaves

the edge again, thus, violating the strict positiveness of the exit flow function. More importantly, differentiability of the exit flow function is not guaranteed for the Vickrey queueing model. Non-differentiability (or equivalently discontinuity w.r.t. the state variable) is a well-known obstacle in the convergence analysis of a discretization of the Vickrey model, see for instance Han et al. [10]. It is a priori not clear how to obtain convergence of a discretization scheme for an arbitrary flow over time (disregarding equilibrium properties) within the Vickrey model. Indeed, Otsubo and Rapoport [19] report "significant discrepancies" between the continuous and a discretized solution for the Vickrey model. To overcome the discontinuity issue, Han et al. [10] reformulated the model using a PDE formulation. They obtained a discretized model whose limit points correspond to dynamic equilibria of the continuous model. The algorithm itself, however, is numerical in the sense that a precision is specified and within that precision an approximate equilibrium is computed. The overall discretization approach mentioned above stands in line with a class of numerical algorithms based on fixed point iterations computing approximate equilibrium flows within a certain numerical precision, see Friesz and Han [6] for a recent survey.

The long term behavior of dynamic equilibria with infinitely lasting constant inflow rate at a single source was studied by Cominetti, Correa and Olver [4]. They introduced the concept of a steady state and showed that dynamic equilibria always reach a stable state provided that the inflow rate is at most the capacity of a minimal s - t cut.

Ismaili [13, 14] considered a discrete version of DE and IDE, respectively. He investigated the computational complexity of computing best responses for DE showing that the best-response optimization problem is not approximable, and that deciding the existence of a Nash equilibrium is complete for the second level of the polynomial hierarchy. In [14] a sequential version of a discrete routing game is studied and PSPACE hardness results for computing an optimal routing strategy are derived. For further results regarding a discrete packet routing model, we refer to Cao et al. [2], Scarsini et al.[22], Harks et al. [11] and Hofer et al. [12].

2 Model

Throughout this paper we always consider networks $\mathcal{N} = (G, (\nu_e)_{e \in E}, (\tau_e)_{e \in E}, (u_v)_{v \in V \setminus \{t\}}, t)$ given by a directed graph $G = (V, E)$, edge capacities $\nu_e \in \mathbb{N}^*$, edge travel times $\tau_e \in \mathbb{N}^{*2}$, and a single sink node $t \in V$ which is reachable from anywhere in the graph. Every other node $v \in V \setminus \{t\}$ has a corresponding (network) inflow rate $u_v : \mathbb{R}_{\geq 0} \rightarrow \mathbb{Q}_{\geq 0}$ indicating for every time $\theta \in \mathbb{R}_{\geq 0}$ the rate $u_v(\theta)$ at which the infinitesimal small agents enter the network at node v and start traveling through the graph until they leave the network at the common sink node t . We will assume that these network inflow rates are right-constant step functions with bounded support and finitely many, rational jump points and denote by $P \in \mathbb{N}^*$ the total number of jump points for all network inflow rates.

Then, a *flow over time* is a tuple $f = (f^+, f^-)$ where $f^+, f^- : E \times \mathbb{R}_{\geq 0} \rightarrow \mathbb{R}_{\geq 0}$ are integrable functions. For any edge $e \in E$ and time $\theta \in \mathbb{R}_{\geq 0}$ the value $f_e^+(\theta)$ describes the (*edge*) *inflow rate* into e at time θ and $f_e^-(\theta)$ is the (*edge*) *outflow rate* from e at time θ . For

²We restrict ourselves to integer travel times and edge capacities in order to make the statements and proofs cleaner. However, all results can be easily applied to instances with rational travel times and capacities by simply rescaling the instance appropriately. Note, however, that by upscaling edge travel times shorter than 1 all explicit bounds will scale accordingly.

any such flow over time f we define the *cumulative (edge) in- and outflow rates* F^+ and F^- by

$$F_e^+(\theta) := \int_0^\theta f_e^+(\zeta) d\zeta \quad \text{and} \quad F_e^-(\theta) := \int_0^\theta f_e^-(\zeta) d\zeta,$$

respectively. The queue length of edge e at time θ is then defined as

$$q_e(\theta) := F_e^+(\theta) - F_e^-(\theta + \tau_e). \quad (1)$$

Such a flow f is called a *feasible flow* for the given set of inflow rates $u_v : \mathbb{R}_{\geq 0} \rightarrow \mathbb{R}_{\geq 0}$, if it satisfies the following constraints (2) to (5). The *flow conservation constraints* are modeled for all nodes $v \neq t$ as

$$\sum_{e \in \delta_v^+} f_e^+(\theta) - \sum_{e \in \delta_v^-} f_e^-(\theta) = u_v(\theta) \quad \text{for all } \theta \in \mathbb{R}_{\geq 0}, \quad (2)$$

where $\delta_v^+ := \{vu \in E\}$ and $\delta_v^- := \{uv \in E\}$ are the sets of outgoing edges from v and incoming edges into v , respectively. For the sink node t we require

$$\sum_{e \in \delta_t^+} f_e^+(\theta) - \sum_{e \in \delta_t^-} f_e^-(\theta) \leq 0 \quad (3)$$

and for all edges $e \in E$ we always assume

$$f_e^-(\theta) = 0 \text{ f.a. } \theta < \tau_e. \quad (4)$$

Finally we assume that the queues operate at capacity which can be modeled by

$$f_e^-(\theta + \tau_e) = \begin{cases} \nu_e, & \text{if } q_e(\theta) > 0 \\ \min \{ f_e^+(\theta), \nu_e \}, & \text{if } q_e(\theta) \leq 0 \end{cases} \quad \text{for all } e \in E, \theta \in \mathbb{R}_{\geq 0}. \quad (5)$$

Following the definition in [9] we call a feasible flow an IDE flow if whenever a particle arrives at a node $v \neq t$, it can only ever enter an edge that is the first edge on a currently shortest v - t path. In order to formally describe this property we first define the *current* or *instantaneous travel time* of an edge e at θ by

$$c_e(\theta) := \tau_e + \frac{q_e(\theta)}{\nu_e}. \quad (6)$$

We then define time dependent node labels $\ell_v(\theta)$ corresponding to current shortest path distances from v to the sink t . For $v \in V$ and $\theta \in \mathbb{R}_{\geq 0}$, define

$$\ell_v(\theta) := \begin{cases} 0, & \text{for } v = t \\ \min_{e=vw \in E} \{ \ell_w(\theta) + c_e(\theta) \}, & \text{else.} \end{cases} \quad (7)$$

We say that an edge $e = vw$ is *active* at time θ , if $\ell_v(\theta) = \ell_w(\theta) + c_e(\theta)$ and denote the set of active edges by $E_\theta \subseteq E$.

Definition 2.1. A feasible flow over time f is an *instantaneous dynamic equilibrium (IDE)*, if for all $\theta \in \mathbb{R}_{\geq 0}$ and $e \in E$ it satisfies

$$f_e^+(\theta) > 0 \Rightarrow e \in E_\theta. \quad (8)$$

In [9, Section 3] the existence of IDE flows in single-sink networks is proven by the following almost constructive argument: An IDE flow up to some time θ can always be extended for some non-trivial additional time interval on a node by node bases (starting with the nodes closest to the sink t). The existence of IDE flows for the whole $\mathbb{R}_{\geq 0}$ then follows by applying Zorn's lemma or a limit argument. This leads to a natural algorithm for computing IDE flows in single-sink networks, which we make explicit here as Algorithm 1.

Algorithm 1: IDE-Construction Algorithm from [9]

Input: A single-sink network \mathcal{N} with piecewise constant network inflow rates
Output: An IDE flow f in \mathcal{N}

- 1 Let f be an IDE flow up to time $\theta \leftarrow 0$
- 2 **while** *not all flow particles have reached the sink t* **do**
- 3 Let $t = v_1 < v_2 < \dots < v_n$ be a topological order w.r.t. $G[E_\theta]$
- 4 Choose the largest $\alpha_0 > 0$ such that all u_v and f_e^- are constant over $(\theta, \theta + \alpha_0)$
- 5 **for** $i = 1, \dots, n$ **do**
- 6 Compute the (constant) inflow into v_i during $[\theta, \theta + \alpha_{i-1}]$ and find a constant distribution to the outgoing edges from v_i such that only active edges are used
- 7 Determine the largest $\alpha_i \leq \alpha_{i-1}$ such that the set of active edges does not change during $(\theta, \theta + \alpha_i)$
- 8 **end for**
- 9 Extend the flow f up to time $\theta + \alpha_n$ and set $\theta \leftarrow \theta + \alpha_n$
- 10 **end while**

The extension at a single node can be easily computed in polynomial time using a simple water filling procedure (see [9, Algorithm 1 (electronic supplementary material)]). It is, however, not obvious whether a finite number of extension phases suffices to construct an IDE flow for all of $\mathbb{R}_{\geq 0}$. Since IDE flows always have a finite termination time in single-sink networks ([9, Theorem 4.6]) it is actually enough to extend the flow for some finite time horizon (in an upcoming paper [8] we will even provide a way to explicitly compute such a time horizon). This leaves the possibility of some Zeno-type behavior of the lengths of the extension phases as possible reason for Algorithm 1 not to terminate within finite time. Thus, the question of whether IDE flows can actually be computed was left as an open question in [9]. A first partial answer was found in [17], where finite termination was shown for graphs obtained by series composition of parallel edges. In the following section we give a full answer by showing that the α -extension algorithm terminates for all single-sink networks.

3 Finite IDE-Construction Algorithm

In this chapter we will show that IDE flows can be constructed in finite time using Algorithm 1 or slight variations thereof. We will first show this only for acyclic networks since there we can use a single constant order of the nodes for the whole construction. Building on that,

we will then prove the general case by showing that we can always compute IDE flows while changing the node order only finitely many times.

3.1 Acyclic Networks

For an acyclic network we can use a single static topological order of the nodes with respect to the whole graph instead of determining a new topological order with respect to the currently active edges for every extension phase. This allows us to rearrange the order of the extension steps, leading to Algorithm 2. Note however, that this does not change the the result of the algorithm.

Algorithm 2: IDE-Construction Algorithm for acyclic networks

Input: An acyclic single-sink network \mathcal{N} with piecewise constant network inflow rates
Output: An IDE flow f in \mathcal{N}

- 1 Choose $T \in \mathbb{N}$ large enough such that all IDE flows in \mathcal{N} terminate before T
- 2 Let f be an IDE flow up to time 0 and $t = v_1 < \dots < v_n$ a topological order
- 3 **for** $\theta = 0, \dots, T - 1$ **do**
- 4 **for** $i = 1, \dots, n$ **do**
- 5 Compute the inflow function into node v_i over the interval $[\theta, \theta + 1]$
- 6 Distribute this inflow for the whole interval $[\theta, \theta + 1]$ to active edges in $\delta_{v_i}^+$ using maximal sub-phases of constant flow distribution
- 7 **end for**
- 8 **end for**

Observation 3.1. For acyclic networks both variants of the general algorithm (Algorithm 1 and Algorithm 2) construct the same IDE flow provided that they use the same tie-breaking rules. Thus, showing that one of them terminates in finite time, also proves the same for the other variant.

Using [9, Algorithm 1] we can compute an IDE compliant flow distribution with constant edge-inflow rates at a node v_i for any interval wherein the inflow into node v_i is constant, the labels on all the nodes w with $v_i w \in \delta_{v_i}^+$ change linearly and the set of active edges leaving v_i remains constant. We call such an interval a *sub-phase*. Thus, it suffices to show that in line 6 we can always subdivide the extension interval $[\theta, \theta + 1]$ into a finite number of such sub-phases. We will show this by induction over $\theta \in [T]$ and $i \in [n]$ using the following key-lemma:

Lemma 3.2. *Let \mathcal{N} be a single-sink network on an acyclic graph with some fixed topological order on the nodes, v some node in \mathcal{N} and $\theta_1 < \theta_2$ two times. If f is a flow over time in \mathcal{N} such that*

- *f is an IDE flow up to time θ_1 for all nodes,*
- *f is an IDE flow up to time θ_2 for all nodes closer to the sink t than v ,*
- *the inflow rate into node v over the interval $[\theta_1, \theta_2]$ is constant and*
- *the labels at the nodes reachable via direct edges from v change linearly over this time interval,*

then we can extend f to an IDE flow up to time θ_2 at v using a finite number of sub-phases.

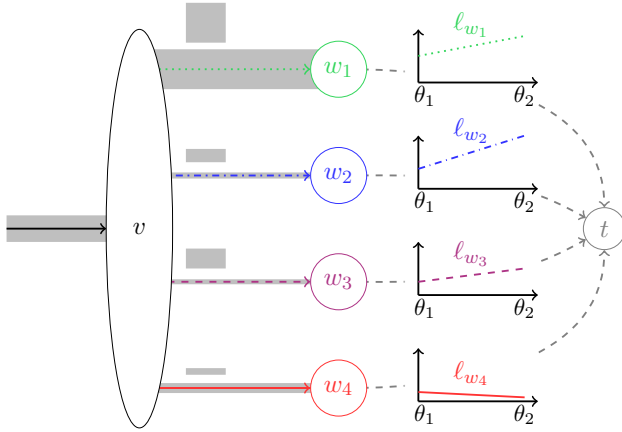

Figure 2: *The situation in Lemma 3.2: We have an acyclic graph with some topological order on the nodes (here from left to right) and an IDE flow up to some time θ_2 for all nodes closer to the sink t than v and up to some earlier time θ_1 for v and all nodes further away than v from t . Additionally, over the interval $[\theta_1, \theta_2]$ the edges leading into v have a constant outflow rate (and a physical travel time of at least $\theta_2 - \theta_1$) and the nodes w_i all have affine label functions ℓ_{w_i} . The edges vw_i start with some current queue lengths $q_{vw_i}(\theta_1) \geq 0$.*

Proof. We want to show that a finite number of maximal constant extensions of the flow at node v using the water filling algorithm [9, Algorithm 1] is enough to extend the given flow for the whole interval $[\theta_1, \theta_2]$ at node v . So, let f be the flow after an, a priori, infinite number of extension steps getting us to an IDE flow up to some $\hat{\theta} \in (\theta_1, \theta_2)$ at node v .

Let $\delta_v^+ = \{vw_1, \dots, vw_p\}$ be the set of outgoing edges from v . Then by the lemma's assumption the label functions $\ell_{w_i} : [\theta_1, \theta_2] \rightarrow \mathbb{R}_{\geq 0}$ are affine functions and, since we extended f at node v up to $\hat{\theta}$, the queue length functions q_{vw_i} are well defined on the interval $[\theta_1, \hat{\theta}]$. Thus, for all $i \in [p]$ we can define functions

$$h_i : [\theta_1, \hat{\theta}] \rightarrow \mathbb{R}_{\geq 0}, \theta \mapsto \tau_{vw_i} + \frac{q_{vw_i}(\theta)}{\nu_{vw_i}} + \ell_{w_i}(\theta)$$

such that $h_i(\theta)$ is the shortest current travel time to the sink t for a particle entering edge vw_i at time θ and for any edge $vw_i \in \delta_v^+$ and any time $\theta \in [\theta_1, \hat{\theta}]$ we have

$$vw_i \in E_\theta \iff h_i(\theta) = \min \{ h_j(\theta) \mid j \in [p] \} = \ell_v(\theta). \quad (9)$$

We start by showing two key-properties of these functions, which are also visualized in Figures 3 and 4:

Claim 1. *If an edge vw_i is inactive during some interval $[a, b] \subseteq [\theta_1, \hat{\theta}]$ the graph of h_i is convex on this interval.*

Claim 2. *A new sub-phase starts at time θ if and only if one of the following two events happens:*

- *An edge vw_i becomes newly active at time θ , i.e. $h_i(\theta) = \ell_v(\theta)$ and the left side derivative of h_i is strictly smaller than that of ℓ_v at time θ . In this case the right-side derivative of ℓ_v at θ is at most its left-side derivative and at least the left-side derivative of h_i , i.e. $\partial_- h_i(\theta) \leq \partial_+ \ell_v(\theta) \leq \partial_- \ell_v(\theta)$.*
- *The queue of an active edge vw_i runs empty at time θ , i.e. $h_i(\theta) = \ell_v(\theta)$, $q_{vw_i}(\theta) = 0$ and the left side derivative of q_{vw_i} at time θ is strictly negative. In this case the left-side derivative of ℓ_v at θ is at most its right-side derivative and strictly smaller than the right-side derivative of h_i , i.e. $\partial_- \ell_v(\theta) \leq \partial_+ \ell_v(\theta)$ and $\partial_- \ell_v(\theta) < \partial_+ h_i(\theta)$.*

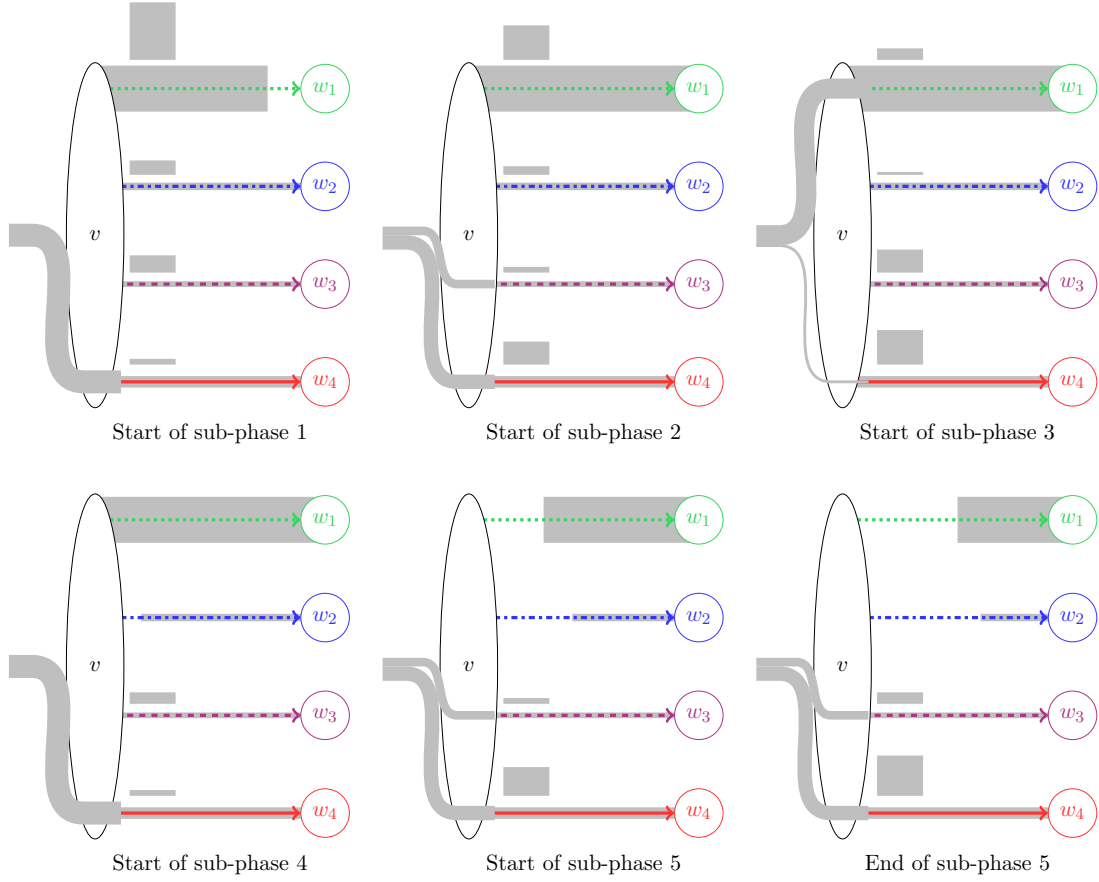

Figure 3: A possible flow distribution from the node v in five sub-phases for the situation depicted in Figure 2. The corresponding functions h_i are depicted in Figure 4

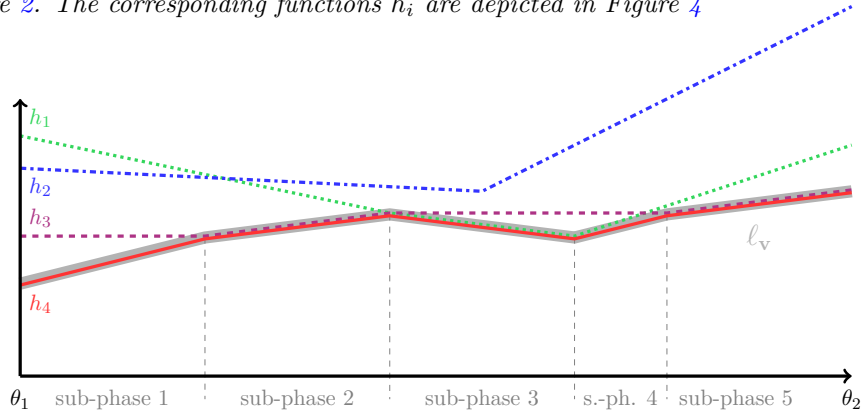

Figure 4: The functions h_i corresponding to the five sub-phase flow distribution depicted in Figure 3 for the situation depicted in Figure 2. The second, third and fifth sub-phase start because an edge becomes newly active (edges vw_3 , vw_1 and vw_3 again, respectively). The fourth sub-phase starts because the queue on the active edge vw_1 runs empty. By Claim 2 these are the only two possible events which can trigger the beginning of a new sub-phase. Edge vw_2 is inactive for the whole time interval and – as stated in Claim 1 – has a convex graph. The bold gray line marks the graph of the function ℓ_v . Also, note the slope changes of the function h_i and ℓ_v at the beginning of the sub-phases in accordance with Claim 2.

Proof of Claim 1. By the lemma's assumption ℓ_{w_i} is linear on the whole interval $[\theta_1, \theta_2]$ and for an inactive edge e its queue length function consists of at most two linear sections: One where the queue depletes at a constant rate of $-\nu_e$ and one where it remains constant 0. Thus, h_i is convex as the sum of two convex functions for any interval, where vw_i is inactive. ■

Proof of Claim 2. The fact that the beginning of a new sub-phase can only be triggered in the two ways described in the claim is a direct consequence of (9), the definition of h_i and the fact that ℓ_{w_i} are linear on the given interval.

In the case that an edge vw_i becomes newly active we have $h_i(\theta) = \ell_v(\theta) = h_j(\theta)$ for all previously active edges vw_j and $h_i(\theta + \varepsilon) = \ell_v(\theta + \varepsilon) \leq h_j(\theta + \varepsilon)$ for $\varepsilon > 0$ small enough, which implies

$$\partial_+ h_i(\theta) = \partial_+ \ell_v(\theta) \leq \partial_+ h_j(\theta) \quad (10)$$

for the right-side derivatives. Since, as an inactive edge, vw_i had no inflow before θ we have $\partial_- h_i(\theta) \leq \partial_+ h_i(\theta)$. Similarly, as the previously active edges vw_j have smaller or at most equal inflow rates after θ compared to before, we get $\partial_+ h_j(\theta) \leq \partial_- h_j(\theta) = \partial_- \ell_v(\theta)$. Together with (10) this yields the first part of the claim.

In the case that the queue of an active edge vw_i runs empty at time θ the set of active edges after θ are a subset of the active edges from before θ . The inflow into these edges vw_j after θ can only be larger or at least equal to the inflow before. Thus, we get $\partial_+ \ell_v(\theta) = \partial_+ h_j(\theta) \geq \partial_- h_j(\theta)$ and, as all these edge were active before θ as well, $\partial_- h_j(\theta) = \partial_- \ell_v(\theta)$ holds as well. Finally, since vw_i had a depleting queue before θ and has a stagnant or even growing queue afterwards we have $\partial_+ h_i(\theta) > \partial_- h_i(\theta) = \partial_- \ell_v(\theta)$ (as vw_i was active before θ), which concludes the prove of the second part of the claim. ■

We also need the following observation which is an immediate consequence of the way the water filling algorithm [9, Algorithm 1] determines the flow distribution combined with the lemma's assumption that all label functions ℓ_{w_i} have constant derivative during the interval $[\theta_1, \theta_2]$.

Claim 3. *There are uniquely defined numbers $\ell_{I,J}$ for all subsets $J \subseteq I \subseteq [p]$ such that $\ell'_v(\theta) = \ell_{I,J}$ within all sub-phases, where $\{vw_i \mid i \in I\}$ is the set of active edges in δ_v^+ and $\{vw_i \mid i \in J\}$ is the subset of such active edges that also have a non-zero queue during this sub-phase.* ■

Using these properties we can now first show a claim which implies that the smallest $\ell_{I,J}$ can only be the derivative of ℓ_v for a finite number of intervals. Inductively the same then holds for all of the finitely many $\ell_{I,J}$. The proof of the lemma then concludes by the observation that an interval with constant derivative of ℓ_v can contain only finitely many sub-phases.

Claim 4. *Let $[a_1, b_1], [a_2, b_2] \subseteq [\theta_1, \hat{\theta}]$ be two disjoint maximal intervals with constant $\ell'_v(\theta) = c$ for some $c \in \{\ell_{I,J} \mid J \subseteq I \subseteq [p]\}$. If $b_1 < a_2$ and $\ell'_v(\theta) \geq c$ for all $\theta \in (b_1, a_2)$ where the derivative exists, then there exists an edge vw_i such that*

1. *the first sub-phase of the interval $[a_2, b_2]$ begins because vw_i becomes newly active at time $\theta = a_2$ and*
2. *this edge is not active between a_1 and a_2 .*

In particular, the first sub-phase of $[a_1, b_2]$ is not triggered by vw_i becoming newly active.

Proof of Claim 4. The first part of the claim follows directly from Claim 2 and the fact that $\partial_- \ell_v(a_2) > c = \partial_+ \ell_v(a_2)$. For the second part let $\tilde{\theta} < a_2$ be the last time before the second interval, where vw_i was active. By Claim 2 we know then that $\partial_- h_i(a_2) \leq \partial_+ \ell_v(a_2) = c$ and by Claim 1 this extends to $h'_i(\theta) \leq c$ for the whole interval $[\tilde{\theta}, a_2]$. At the same time we have $\ell'_v(\theta') \geq c$ for all of $[a_1, a_2]$ and $\ell'_v(\theta') > c$ for at least some proper subinterval all of $[b_1, a_2]$, since the intervals $[a_1, b_1]$ and $[a_2, b_2]$ were chosen to be maximal. Combining these two facts with $\ell_v(\theta) = h_i(\theta)$ immediately shows $\ell_v(\theta') < h_i(\theta')$ for all $\theta' \in [\tilde{\theta}, a_2] \cap [a_1, a_2]$. This gives $\tilde{\theta} < a_1$ and, thus, vw_i is inactive for all of $[a_1, a_2]$, which proves the claim. ■

This claim directly implies that the lowest derivative of ℓ_v during $[\theta_1, \hat{\theta}]$ only appears in a finite number of intervals, as each of these intervals has to start with a different edge becoming newly active. But then, iteratively applying this claim for the intervals between these intervals shows that any derivative of ℓ_v can only appear in a finite number of intervals. Since, by Claim 3, ℓ'_v can only attain a finite number of values, this implies that $[\theta_1, \hat{\theta}]$ consists of a finite number of intervals with constant derivative of ℓ_v .

Claim 5. *Let $[a, b] \subseteq [\theta_1, \hat{\theta}]$ be an interval during which ℓ'_v is constant. Then $[a, b]$ contains at most $2p$ sub-phases.*

Proof of Claim 5. By Claim 1 an edge that changes from active to inactive during the interval $[a, b]$ will remain inactive for the rest of this interval. Thus, at most p sub-phases can start because an edge becomes newly active. By Claim 2 if a sub-phase begins because the queue on an active edge e runs empty, this edge will become inactive. Thus, at most p sub-phases start because the queue of an active edge runs empty. Since, also by Claim 2, these are the only two ways to start a new sub-phase, we can have at most $2p$ sub-phases start during $[a, b]$. ■

Combining Claims 4 and 5 we can finally conclude that $[\theta_1, \hat{\theta}]$ only contains a finite number of sub-phases and, thus, we can achieve $\hat{\theta} = \theta_2$ with a finite number of extensions. □

With this lemma the proof of the following theorem is straightforward.

Theorem 3.3. *For any acyclic single-sink network with piecewise constant network-inflow rates an IDE flow can be constructed in finite time using Algorithm 2.*

Proof. We show this by induction over $\theta \in [T]$ and $i \in [n]$, i.e. we can assume that the currently constructed flow f is an IDE flow up to time θ for all nodes $v_j, j \geq i$ and up to time $\theta + 1$ for all nodes $v_j, j < i$ with only a finite number of (sub-)phases. In particular, this means that we can partition the interval $[\theta, \theta + 1]$ into a finite number of subintervals such that within each such subinterval there is a constant inflow rate into node v_i and the labels at all the vertices w with $v_i w \in \delta_{v_i}^+$ change linearly. Then, by Lemma 3.2, we can distribute the flow at node v_i to the outgoing edges using a finite number of sub-phases for each of these subintervals. Note that, aside from the queue lengths on the edges leaving v_i , the so distributed flow has no influence on the flow distribution in later subintervals and, in particular, does not influence the partition into subintervals or the flow distribution at nodes closer to t than v_i . Thus, we can distribute the outflow from v_i for the whole interval $[\theta, \theta + 1]$ using only a finite number of sub-phases. □

Closer inspection of the proofs above also allows us to derive a rough but explicit bound on the number of sub-phases the constructed IDE flow can have.

Proposition 3.4. *For any acyclic single-sink network with piecewise constant network-inflow rates the number of sub-phases of any IDE flow constructed by Algorithm 2 is bounded by*

$$\mathcal{O}\left(P\left(2(\Delta+1)^{4\Delta+1}\right)^{T|V|}\right),$$

where $\Delta := \max\{|\delta_v^+| \mid v \in V\}$ the maximum out-degree in the given network and P is the number of intervals with constant network inflow rates.

Proof. First, we look at an interval $[\theta_1, \theta_2]$ and a single node v as in Lemma 3.2. Here we can use Claim 4 to bound the number of intervals of constant derivative of ℓ_v by

$$\left(|\delta_v^+| + 1\right)^{|\{(I,J) \mid J \subseteq I \subseteq [|\delta_v^+|]\}|} \leq \left(|\delta_v^+| + 1\right)^{4^{|\delta_v^+|}},$$

each of them containing at most $2^{|\delta_v^+|}$ sub-phases by Claim 5. Together this shows that any such interval will be subdivided into at most $2(\Delta+1)^{4\Delta+1}$ sub-phases. Thus, whenever we execute line 6 of Algorithm 2 every currently existing sub-phase may be subdivided further into at most $2(|\Delta|+1)^{4\Delta+1}$ sub-phases. Thus, for every $\theta \in [T]$ the number of sub-phases can be multiplied by at most $\prod_{v \in V} \left(2(|\Delta|+1)^{4\Delta+1}\right)$ in total during the extension over the interval $[\theta, \theta+1]$. Combining this with the at most P sub-phases triggered by changing network inflow rates results in the bound of

$$\mathcal{O}\left(P\left(2(\Delta+1)^{4\Delta+1}\right)^{T|V|}\right). \quad \square$$

3.2 General Single-Sink Networks

We now want to extend this result to general single-sink networks, i.e. we want to show that Algorithm 1 terminates within finite time not only for acyclic graphs, but for all graphs. We first note that the requirement for input-graphs of Algorithm 2 to be acyclic is somewhat too strong. It is actually enough to have some (static) order on the nodes such that it is always a topological order with respect to the active edges of the network. That is, for a general single-sink network we can still apply Algorithm 2 to determine an IDE-extension with finitely many phases for any interval during which we have such a static node ordering. Thus, Algorithm 1 can also use finitely many extension phases for each interval with such a static ordering. This observation gives rise to Algorithm 3, another slight variant of Algorithm 1.

We will prove that this algorithm does indeed construct an IDE flow for arbitrary single-sink networks within finite time by first showing that this algorithm is a special case of the original algorithm. Thus, it is correct and uses only a finite number of phases for any interval in which the topological order does not change. We can then conclude the proof by showing that it is enough to change the topological order a finite number of times for any given time horizon.

Lemma 3.5. *Algorithm 3 is a special case of Algorithm 1. In particular it is correct.*

Proof. First note, that \tilde{E} is clearly always acyclic (except in lines 12 and 13) which guarantees that we can always find a topological order with respect to \tilde{E} . We now only need to show that such an ordering is also a topological order with respect to the active edges, i.e. that for any time θ we have $E_\theta \subseteq \tilde{E}$. For this we will use the following observation

Algorithm 3: IDE-Construction Algorithm for general single-sink networks

Input: A single-sink network \mathcal{N} with piecewise constant network inflow rates

Output: An IDE flow f in \mathcal{N}

- 1 Choose T large enough such that all IDE flows in \mathcal{N} terminate before T
 - 2 Let f be an IDE flow up to time $\theta \leftarrow 0$ and $\tilde{E} \leftarrow E_0$
 - 3 Determine a topological order $t = v_1 < v_2 < \dots < v_n$ w.r.t. the edges in \tilde{E}
 - 4 **while** $\theta < T$ **do**
 - 5 Choose the largest $\alpha_0 > 0$ such that all u_v and f_e^- are constant over $(\theta, \theta + \alpha_0)$
 - 6 **for** $i = 1, \dots, n$ **do**
 - 7 Compute the (constant) inflow into v_i during $[\theta, \theta + \alpha_{i-1}]$ and find a constant distribution to the outgoing edges from v_i such that only active edges are used
 - 8 Determine the largest $\alpha_i \leq \alpha_{i-1}$ such that the set of active edges does not change during $(\theta, \theta + \alpha_i)$
 - 9 **end for**
 - 10 Extend the flow f up to time $\theta + \alpha_n$ and set $\theta \leftarrow \theta + \alpha_n$
 - 11 **if** $E_\theta \setminus \tilde{E} \neq \emptyset$ **then**
 - 12 Define $\tilde{E} \leftarrow \tilde{E} \cup E_\theta$.
 - 13 For each cycle in \tilde{E} remove the edge $e = xy$ with the largest value $\ell_y(\theta) - \ell_x(\theta)$ of all edges on this cycle
 - 14 Determine a topological order $t = v_1 < v_2 < \dots < v_n$ w.r.t. the edges in \tilde{E}
 - 15 **end if**
 - 16 **end while**
-

Claim 6. Any edge xy removed from \tilde{E} in line 13 of Algorithm 3 satisfies $\ell_x(\theta) < \ell_y(\theta)$.

Proof. Let $C \subseteq \tilde{E}$ be a cycle the removed edge xy was part of. Since \tilde{E} was acyclic before we added the newly active edges in line 12, this cycle also has to contain some currently active edge vw . This gives us

$$\begin{aligned} \sum_{e=uz \in C \setminus \{vw\}} (\ell_z(\theta) - \ell_u(\theta)) &= \sum_{e=uz \in C} (\ell_z(\theta) - \ell_u(\theta)) - (\ell_w(\theta) - \ell_v(\theta)) \\ &= 0 - \ell_w(\theta) + \left(\ell_w(\theta) + \tau_{vw} + \frac{q_{vw}(\theta)}{\nu_{vw}} \right) \\ &= \tau_{vw} + \frac{q_{vw}(\theta)}{\nu_{vw}} \geq 1. \end{aligned}$$

Thus, C contains at least one edge uz with $\ell_z(\theta) - \ell_u(\theta) > 0$ and, by the way it was chosen, this then holds in particular for edge xy . ■

The claim then immediately implies that in line 13 we only remove inactive edges and that, afterwards, we still have $E_\theta \subseteq \tilde{E}$. □

Lemma 3.6. For any single-sink network there exists some constant $C > 0$ such that for any time interval of length C the set \tilde{E} changes at most $|E|$ times during this interval in Algorithm 3.

Proof. The proof of this lemma mainly rest on the following claim stating that for any fixed network we can bound the slope of the node labels of any flow in this network by some constant.

Claim 7. *For any given network there exists some constant $L > 0$ such that for all flows, all nodes v and all times θ we have $|\ell'_v(\theta)| \leq L$.*

Proof. First note that for any node v we can bound the maximal inflow rate into this node by some constant L_v as follows:

$$\sum_{e \in \delta_v^-} f_e^-(\theta) + u_v(\theta) \stackrel{(5)}{\leq} \sum_{e \in \delta_v^-} \nu_e + \max \{ u_v(\theta) \mid \theta \in \mathbb{R}_{\geq 0} \} =: L_v.$$

Using flow conservation (2) this, in turn, allows us to bound the inflow rates into all edges $e \in \delta_v^+$ and, thus, the rate at which the queue length and the current travel time on these edges can change:

$$-1 \leq c'_e(\theta) \stackrel{(1),(6)}{\leq} \frac{f_e^+(\theta)}{\nu_e} \leq \frac{L_v}{\nu_e} =: L_e.$$

Finally, setting $L := \sum_{e \in E} \max \{ 1, L_e \}$ proves the claim, as for all nodes v and times θ we then have

$$|\ell'_v(\theta)| \leq \sum_{e \in E} |c'_e(\theta)| \leq \sum_{e \in E} L_e = L. \quad \blacksquare$$

Now, from Claim 6 we know that, when we remove an edge xy from \tilde{E} at time θ we must have $\ell_x(\theta) < \ell_y(\theta)$. But at time θ' where we last added this edge to \tilde{E} it must have been active (since we only ever add active edges to \tilde{E}) and, thus, we had $\ell_x(\theta') = \ell_y(\theta') + c_{xy}(\theta') \geq \ell_y(\theta') + 1$. Therefore, the difference between the labels at x and y has changed at least by 1 between θ' and θ . Claim 7 then directly implies $\theta - \theta' \geq \frac{1}{2L}$. So, for any time interval of length at most $\frac{1}{2L}$ each edge can be added at most once to \tilde{E} . Since \tilde{E} only ever changes when we add at least one new edge to it, setting $C := \frac{1}{2L}$ proves the lemma. \square

Theorem 3.7. *For any single-sink network with piecewise constant network-inflow rates an IDE flow can be constructed in finite time using Algorithm 3.*

Proof. By Lemma 3.5 Algorithm 3 is a special case of Algorithm 1. Thus, for any interval with static \tilde{E} it produces the same flow as Algorithm 2. In particular, by Theorem 3.3, for any such interval the constructed flow consists of finitely many phases. Finally, Lemma 3.6 shows that the whole relevant interval $[0, T]$ can be partitioned into a finite number of intervals with static set \tilde{E} . Consequently, Algorithm 3 constructs an IDE flow with finitely many phases and, thus, terminates within finite time. \square

As in the acyclic case we can again also extract an explicit upper bound on the number of sub-phases.

Proposition 3.8. *For any single-sink network with piecewise constant network inflow rates the number of sub-phases of any IDE flow constructed by Algorithm 3 is bounded by*

$$\mathcal{O} \left(P \left(2(\Delta + 1)^{4\Delta + 1} \right)^{2L \cdot |E| \cdot T \cdot |V|} \right),$$

where, again, $\Delta := \max \{ |\delta_v^+| \mid v \in V \}$ is the maximum out-degree in the given network, P is the number of intervals with constant network inflow rates and L the bound on the slopes of the label functions from Claim 7.

Proof. For any time interval with fixed node order Algorithm 3 is equivalent to Algorithm 2 and, thus, the bound from Proposition 3.4 applies. Also note, that in Algorithm 2 we could change the node order after every unit time step without any impact on correctness or the bound on the number of sub-phases (as long as we always choose an order which is a topological order with respect to the active edges). As, by Lemma 3.6, the node order in Algorithm 3 changes at most $2L \cdot |E|$ times during any unit time interval, replacing T by $2L \cdot |E| \cdot T$ in the bound for Algorithm 2 yields a valid bound for the number of sub-phases of Algorithm 3. \square

Remark 3.9. If presented with rational input data (i.e. rational capacities, node inflow rate, current queue lengths, current distance labels and slopes of distance labels of neighbouring nodes) the water filling procedure from [9] again produces a rational output (i.e. rational edge inflow rates and rational maximal extension length α). Thus, Algorithm 3 can be implemented as an exact combinatorial algorithm.

4 Computational Complexity of IDE-Flows

While Theorem 3.7 shows that IDE flows can be constructed in finite time, the bound provided in Proposition 3.8 is clearly superpolynomial. We now want to show that in some sense this is to be expected. Namely, we first look at the output complexity of any such algorithm, i.e. how complex the structure of IDE flows can be. Then we show that many natural decision problems involving IDE flows are actually NP-hard.

4.1 Output Complexity and Steady State

As before we call an open interval $(a, b) \subseteq \mathbb{R}_{\geq 0}$ a *phase* of a feasible flow f , if all edge in- and outflow rates remain constant during this interval. Then the output of any algorithm computing feasible flows certainly has to contain in some way a set of phases and corresponding in- and outflow rates. In particular, the number of phases of a flow is a lower bound for the runtime of any algorithm determining that flow. This observation will allow us to give an exponential lower bound for the output complexity and therefore also for the worst case runtime of any algorithm determining IDE flows. This remains true even if we only look at acyclic graphs and we allow for our algorithm to recognize periodic behavior and abbreviate the output accordingly.

Theorem 4.1. *The worst case output complexity of calculating IDE flows is not polynomial in the encoding size of the instance, even if we are allowed to use periodicity to reduce the encoding size of the determined flow. This is true even for series parallel graphs.*

Proof. For any given $U \in \mathbb{N}^*$ consider the network pictured in Figure 5 with a constant inflow rate of 2 at s over the interval $[0, U]$. This network can clearly be encoded in $\mathcal{O}(\log U)$ space. The unique (up to changes on a set of measure zero) IDE flow is displayed up to time $\theta = 6.5$ in Figure 5 and described for all times in Table 1. As this pattern is clearly non-periodic and continues up to time $\theta = U$, it exhibits $\Omega(U)$ distinct phases. This proves the theorem. \square

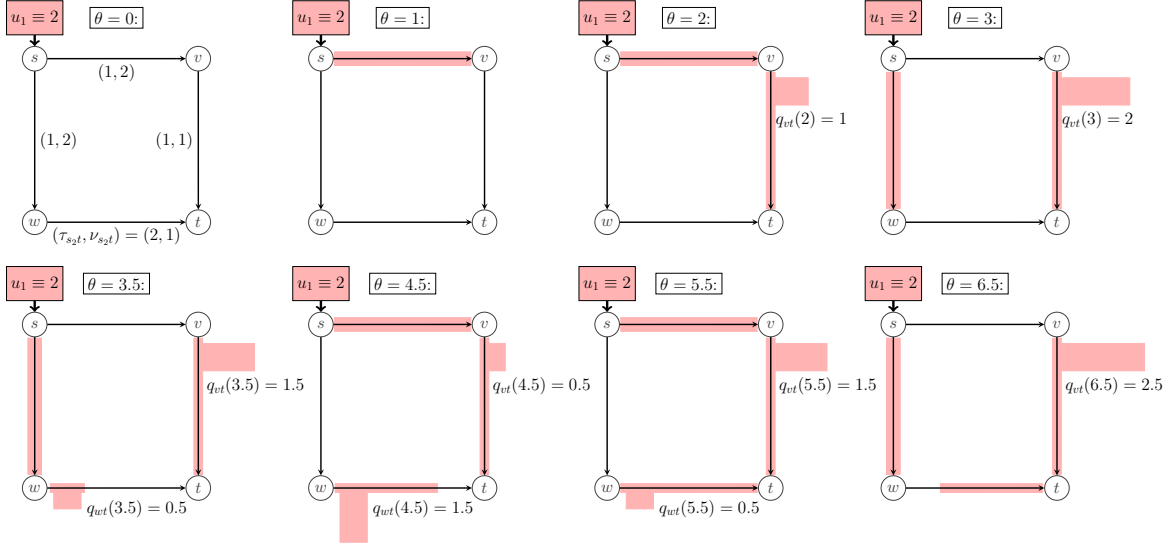

Figure 5: A network (top left picture) where constant inflow rate of 2 over $[0, U]$ leads to an IDE flow with $\Omega(U)$ different phases. The following pictures show the first states of the network, which are described in general in Table 1.

$\theta =$	$f_{vt}^+(\theta)$	$f_{wt}^+(\theta)$	$q_{vt}(\theta)$		$q_{wt}(\theta)$		$f_{sv}^+(\theta)$	$f_{st}^+(\theta)$
$4k + 2^{-k} - 1$	0	2	$2 - 2^{-k}$	\searrow	$1 - 2^{-k}$	\nearrow	2	0
$4k + 2^{-k}$	2	0	$1 - 2^{-k}$	\nearrow	$2 - 2^{-k}$	\searrow	2	0
$4k + 2^{-k} + 1$	2	0	$2 - 2^{-k}$	\nearrow	$1 - 2^{-k}$	\searrow	0	2
$4k + 2^{-k} + 2$	0	2	$3 - 2^{-k}$	\searrow	0	\nearrow	0	2

Table 1: Phases of the (unique) IDE flow in the instance of Figure 5. For all $k \in \mathbb{N}_0$ the table includes the (constant) inflow rates into all edges on the intervals $(4k + 2^{-k} - 1, 4k + 2^{-k})$, $(4k + 2^{-k}, 4k + 2^{-k} + 1)$, $(4k + 2^{-k} + 1, 4k + 2^{-k} + 2)$ and $(4k + 2^{-k} + 2, 4k + 2^{-(k+1)} + 3)$ as well as the queue lengths on the edges vt and wt at the beginning of these intervals and the rate of change for the queue lengths over the following interval (\nearrow stands for an increase at rate 1, \searrow for a decrease at rate -1).

Remark 4.2. In [4, Example 2] Cominetti et al. sketch an instance with $\mathcal{O}(d^2)$ vertices where a dynamic equilibrium flow exhibits an exponential number of phases (of order $\Omega(2^d)$) before it reaches a stable state. From this, we can conclude that a similar result holds for dynamic equilibria. However, since the details of this example are not yet published we do not know whether the phases do exhibit periodic behavior and how complicated the constructed instance is.

The network constructed in the above proof can also be used to gain some insights into the long term behavior of IDE flows, i.e. how such flows behave if the inflow rates continue forever. In order to analyze this long term behavior of dynamic equilibrium flows Cominetti et al. define in [4, Section 3] the concept of a steady state:

Definition 4.3. A feasible flow f with forever lasting constant inflow rate reaches a *steady state* if there exists a time $\tilde{\theta}$ such that after this time all queue lengths stay the same forever i.e.

$$q_e(\theta) = q_e(\tilde{\theta}) \text{ f.a. } e \in E, \theta \geq \tilde{\theta}.$$

For dynamic equilibrium flows Cominetti et al. then show that the obvious necessary condition that the inflow rate is at most the minimal total capacity of any s - t cut is also a sufficient condition for any dynamic equilibrium in such a network to eventually reach a steady state ([4, Theorem 4]). We will show that this is not true for IDE flows - even if we consider a weaker variant of steady states:

Definition 4.4. A feasible flow f reaches a *periodic state* if there exists a time $\tilde{\theta}$ and a periodicity $p \in \mathbb{R}_{\geq 0}$ such that after time $\tilde{\theta}$ all queue lengths change in a periodic manner, i.e.

$$q_e(\theta + kp) = q_e(\theta) \text{ f.a. } e \in E, \theta \geq \tilde{\theta}, k \in \mathbb{N}^*.$$

Note that, in particular, every flow reaching a stable state also reaches a periodic state (with arbitrary periodicity).

Theorem 4.5. *There exists a series parallel network with a forever lasting constant inflow rate u at a single node s , satisfying $u \leq \sum_{e \in \delta_X^+} \nu_e$ for all s - t cuts X , where no IDE flow ever reaches a periodic state.*

Proof. Consider the network constructed in the proof of Theorem 4.1, i.e the one pictured in Figure 5, but with a constant inflow rate of 2 at s for all of $\mathbb{R}_{\geq 0}$. A minimal cut is $X = \{s, v, w\}$ with $\sum_{e \in \delta_X^+} \nu_e = 2$. The unique IDE flow is still the one described in Table 1 and, thus, never reaches a periodic state. \square

Remark 4.6. In contrast the (again unique) dynamic equilibrium for the network from Figure 5 is displayed in Figure 6 and does indeed reach a steady state at time $\theta = 4$.

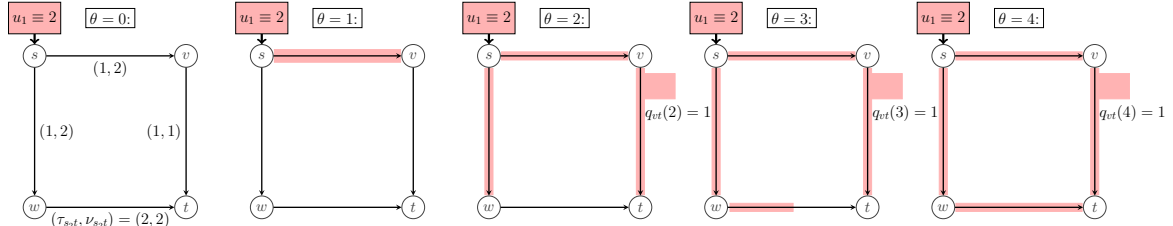

Figure 6: The dynamic equilibrium flow for the network constructed in the proof of Theorem 4.5.

4.2 NP-Hardness

We will now show that the decision problem whether in a given network there exists an IDE with certain properties is often NP-hard – even if we restrict ourselves to only single-source single-sink networks on acyclic graphs. Note, however, that due to the non-uniqueness of IDE flows this does not automatically imply that computing *any* IDE flow must be hard. We first show that the restriction to a single source can be made without loss of generality.

Lemma 4.7. *For any multi-source single-sink network \mathcal{N} with piecewise constant inflow rates with finitely many jump points there exists a (larger) single-source single-sink network \mathcal{N}' with constant inflow rate such that*

- the encoding size of \mathcal{N}' is linearly bounded in that of \mathcal{N} ,*
- if \mathcal{N} is acyclic, so is \mathcal{N}' ,*
- \mathcal{N} is a subnetwork of \mathcal{N}' (except for the sources),*

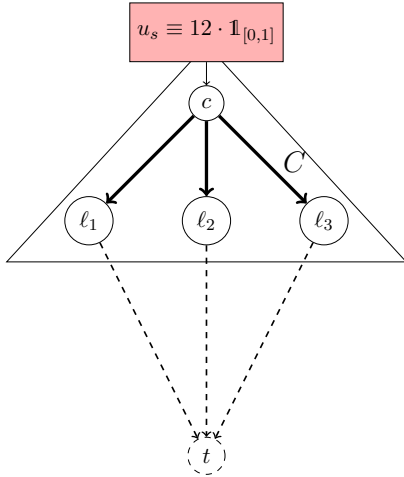

Figure 7: The clause gadget C consists of a source node and three edges leaving it, each with capacity 12 and travel time 1. If embedded in a larger network in such a way that the shortest paths from ℓ_1, ℓ_2 and ℓ_3 to t all have the same length (and no queues during the interval $[0, 1]$), the inflow at node s can be distributed in any way among the three edges. In particular, it is possible to send all flow over only one of the three edges. In any distribution there has to be at least one edge which carries a flow volume of at least 4.

d) the restriction map composed with some constant translation is a one-to-one correspondence between the IDE-flows in \mathcal{N}' and those in \mathcal{N} :

$$\{ \text{IDE-flows in } \mathcal{N}' \} \rightarrow \{ \text{IDE-flows in } \mathcal{N} \}, f \mapsto f|_{\mathcal{N}}(_ - c).$$

Proof. This can be accomplished by using the construction from the proof of [9, Theorem 6.3], which clearly satisfies all four properties. \square

Theorem 4.8. *The following decision problems are NP-hard:*

- Given a network and a specific edge: Is there an IDE not using this edge?
- Given a network and a specific edge: Is there an IDE using this edge?
- Given a network and a time horizon T : Is there an IDE that terminates before T ?
- Given a network and some $k \in \mathbb{N}$: Is there an IDE consisting of at most k phases?

All these decision problems remain NP-hard even if we restrict them to single-source instances with constant inflow rate on acyclic graphs. The last problem becomes NP-complete if we restrict k by some polynomial in the encoding size of the whole instance.

Proof. We will show this theorem by reducing the NP-complete problem 3SAT to the above problems. The main idea of the reduction is as follows: For any given instance of 3SAT we construct a network which contains a source node for each clause with three outgoing edges corresponding to the three literals of the clause. Any satisfying interpretation of the 3SAT-formula translates to a distribution of the network inflow to the literal edges, which leads to an IDE flow that passes through the whole network in a straightforward manner. If, on the other hand, the formula is unsatisfiable every IDE flow will cause a specific type of congestion which will divert a certain amount of flow into a different part of the graph. This part of the graph may contain an otherwise unused edge the diverted flow is then forced to use or a gadget which produces many phases (e.g. the graph constructed for the proof of Theorem 4.1) or a long travel time (e.g. an edge with very small capacity).

We start by providing two types of gadgets: One for the clauses and one for the variables of a 3SAT-formula. The clause gadget C (see Figure 7) consists of a source node c with a constant network inflow rate of 12 over some interval of length 1 and three edges with capacity 12 and travel time 1 connecting c to the nodes ℓ_1, ℓ_2 and ℓ_3 , respectively. This gadget will later be embedded into a larger network in such a way that the shortest paths from the nodes ℓ_1, ℓ_2 and ℓ_3 to the sink t all have the same length. Thus, the flow entering the

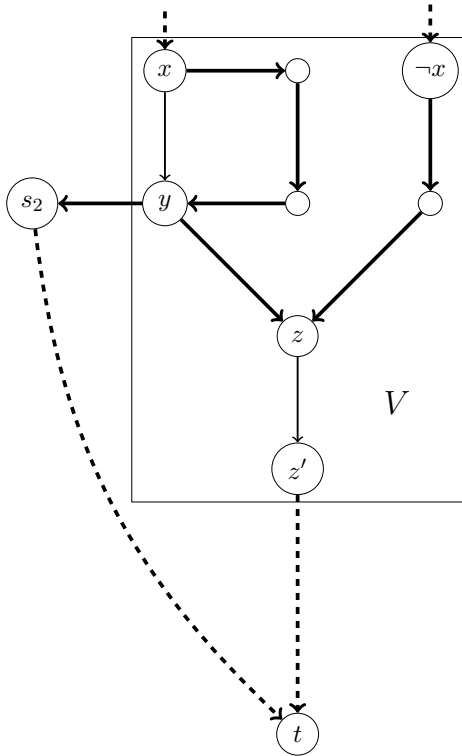

Figure 8: *The variable gadget V . The edges xy and zz' have capacity 1, all other edges have infinite capacity. The travel times on all (solid) edges are 1 while the dashed lines represent paths with a length such that the travel time from s_2 to t is the same as from y over z and z' to t . If flow enters this gadget at any rate over a time interval of length one at either x or $\neg x$ all flow will travel over the edge zz' to the sink t . If, on the other hand, at both x and $\neg x$ a flow of volume at least 4 enters the gadget over an interval of length 1 a flow volume of more than 1 will be diverted towards s_2 .*

gadget at the source node c can be distributed in any way over the three outgoing edges. We will have a copy of this gadget for any clause of the given 3SAT-formula with the three nodes ℓ_1 , ℓ_2 and ℓ_3 corresponding to the three literals of the respective clause. Setting a literal to true will then correspond to sending a flow volume of at least 4 towards the respective node.

The variable gadget V (see Figure 8) has two nodes x and $\neg x$ over which flow can enter the gadget. From both of these nodes there is a path consisting of two edges of length 1 leading towards a common node z , from where another edge of length and capacity 1 leads to node z' . From there the gadget will be connected to the sink node t somewhere outside the gadget. The path from $\neg x$ to z has infinite capacity³, while the path from x to z consists of one edge with capacity 1 followed by one edge of infinite capacity with a node y between the two edges. The first edge can be bypassed by a path of length 3 and infinite capacity. From the middle node y there is also a path leaving the gadget towards t via some node s_2 outside the gadget. This path has a total length of one more than the path via z and z' to t .

We will have a copy of this gadget for every variable of the given 3SAT-formula. Similarly to the clause gadget we will interpret the variable x to be set to true if a flow of volume at least 4 traverses node x and the variable to be set to false if a flow volume of at least 4 passes through node $\neg x$. Now, if flow travels through only one of these two nodes over the course of an interval of length 1 (i.e. the variable x is set consistently) then all this flow will travel to t via z . If, on the other hand, both x and $\neg x$ each are traversed by a flow of volume at least 4 over the span of a time interval of length 1 a flow of volume more than 1 will leave the gadget via the edge ys_2 during the unit length time interval three time steps later.

³Throughout this construction whenever we say that an edge has “infinite capacity” by that we mean some arbitrary capacity high enough such that no queues will ever form on this edge. Since the network we construct will be acyclic such capacities can be constructed inductively similarly to the constant L_e in the proof of Claim 7

To verify this, assume that the flow enters at nodes x and $\neg x$ during $[0, 1]$. Then the flow entering through $\neg x$ will start to form a queue on edge zz' two time steps later. This queue will have reached a length of at least 2 at time 3 and, thus, still has a length of at least 1 at time 4. The flow entering through x at first only uses edge xy until a queue of length 2 has build up there. After that, flow will only enter this edge at a rate of 1 to keep the queue length constant, while the rest of the flow travels through the longer path towards y . This flow (of volume at least 1) as well as some non-zero amount of flow from the queue on edge xy will arrive at node y during the interval $[3, 4]$. Because of the queue on edge zz' all of this flow (of volume more than 1) will be diverted towards s_2 .

We can now transform a 3SAT-formula into a network as follows: Take one copy of the clause gadget c for every clause of the formula, one copy of the variable gadget V for every variable and connect them in the obvious way (e.g. if the first literal of some clause is $\neg x_1$ connect the node ℓ_1 of this clause's copy of C with the node $\neg x$ of the variable x_1 's copy of V and so on). Then add a sink node t and connect the nodes z' of all variable gadgets to t via edges of travel time 1 and infinite capacity. Finally, connect the node s_2 (which is the same for all variable gadgets) to t by first an edge s_2v of travel time 1 and then another edge of travel time 2 and infinite capacity. The resulting network (see Figure 9) has an IDE flow not using edge s_2v if and only if the 3SAT-formula is satisfiable. If, on the other hand, the 3SAT-formula is unsatisfiable every IDE flow will sent a flow volume of more than 1 over edge s_2v during the interval $[4, 5]$. This shows that the first problem stated in Theorem 4.8 is NP-hard.

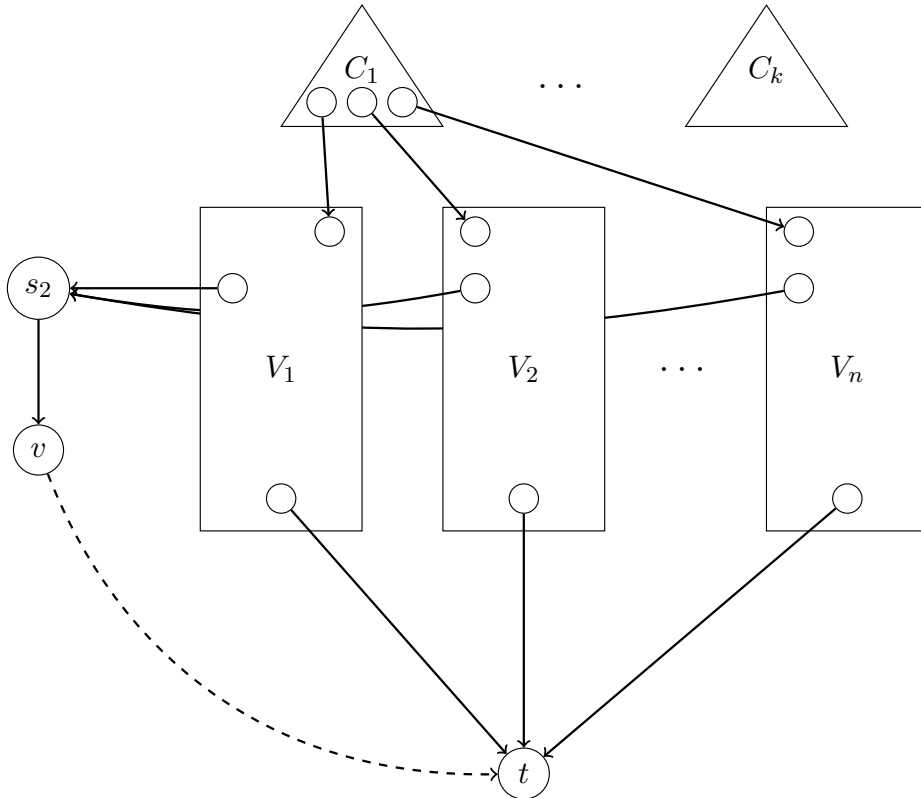

Figure 9: Schematic representation of the whole network corresponding to a 3SAT-formula with clauses C_1, \dots, C_k in variables x_1, \dots, x_n . The triangles are clause gadgets (cf. fig. 7), the rectangles are variable gadgets (cf. fig. 8).

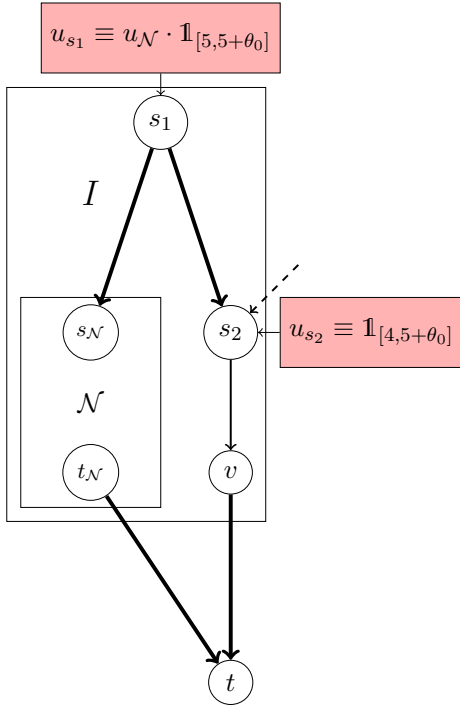

Figure 10: *The indicator gadget I for a single-source single-sink network \mathcal{N} with network inflow rate $u_{\mathcal{N}}\mathbb{1}_{[0, \theta_0]}$. All bold edges have infinite capacity, the edge s_2v has capacity 1. The edges $s_1s_{\mathcal{N}}$ and s_1s_2 both have travel time θ_0 , edge s_2v has a travel time of 1 and the edges $t_{\mathcal{N}}t$ and vt can have any travel time such that the shortest s_1-t path through \mathcal{N} has a length of exactly one more than the s_1-t path using edge s_2v . If within the interval $[4, 5]$ a flow of volume more than 1 arrives at s_2 over the dashed edge, all flow entering the network at s_1 will travel through \mathcal{N} (it will arrive at that sub-network's source node $s_{\mathcal{N}}$ at a rate of $u_{\mathcal{N}}$ during the interval $[5 + \theta_0, 5 + 2\theta_0]$). If, on the other hand, a flow volume of at most 1 reaches s_2 via the dashed edge up to time $5 + \theta_0$ all flow originating at s_2 will bypass \mathcal{N} using edge s_2v and \mathcal{N} will forever remain empty.*

In order to show that the other problems are NP-hard as well, we will introduce a third type of gadget: The indicator gadget I (see Figure 10). We can construct such a gadget for any given single-source single-sink network \mathcal{N} with constant inflow rate over the interval $[0, \theta_0]$ at its source node. It consists of a new source node s_1 with the same inflow rate as \mathcal{N} 's source node shifted by 5 time steps. The node s_1 is connected to the sink node t (outside the gadget) by two paths: One through the network \mathcal{N} (entering it at its original source node $s_{\mathcal{N}}$ and leaving it from its sink node $t_{\mathcal{N}}$) and one through two additional nodes s_2 and v and an edge of capacity and travel time 1 between them. All other edges outside \mathcal{N} have infinite capacity. The two outgoing edges from s_1 both have a length of θ_0 . The path through the gadget has length one more than the path via s_2 and v . The node s_2 has a constant network inflow rate of 1 starting at time 4 and ending at time $5 + \theta_0$. When embedding this gadget into a larger network (with sink t) the gadget is connected to the larger network by one or more incoming edges into s_2 .

If no flow ever enters the gadget via this edge, all flow generated at s_1 will travel through the path containing s_2v . If, on the other hand, a flow of volume more than 1 comes through this edge before the inflow at node s_1 starts, all the flow generated there will travel through the subnetwork \mathcal{N} . Adding this gadget to the network constructed from the 3SAT-formula as described above results in a network with the following properties (see Figure 11 for an example):

- If the 3SAT-formula is satisfiable there exists an IDE flow where the subnetwork \mathcal{N} inside gadget I is never used but edge s_1s_2 is used.
- If the 3SAT-formula is unsatisfiable every IDE flow will be such that its restriction to the subnetwork \mathcal{N} inside I is a (time shifted) IDE flow in the original stand alone network \mathcal{N} and the edge s_1s_2 is never used.

Accordingly, if for example we use the network from Figure 5 as sub-network we have a reduction from 3SAT to the fourth problem from Theorem 4.8. Any network \mathcal{N} gives us a reduction to the second problem (with edge s_1s_2 as the special edge). And just an edge with

a very small capacity allows a reduction to the third problem. Alternatively, one could also use a network wherein flow gets caught in cycles for a long time before it reaches the sink as, for example, the network constructed to prove the lower bound on the termination time of IDE in [8]. \square

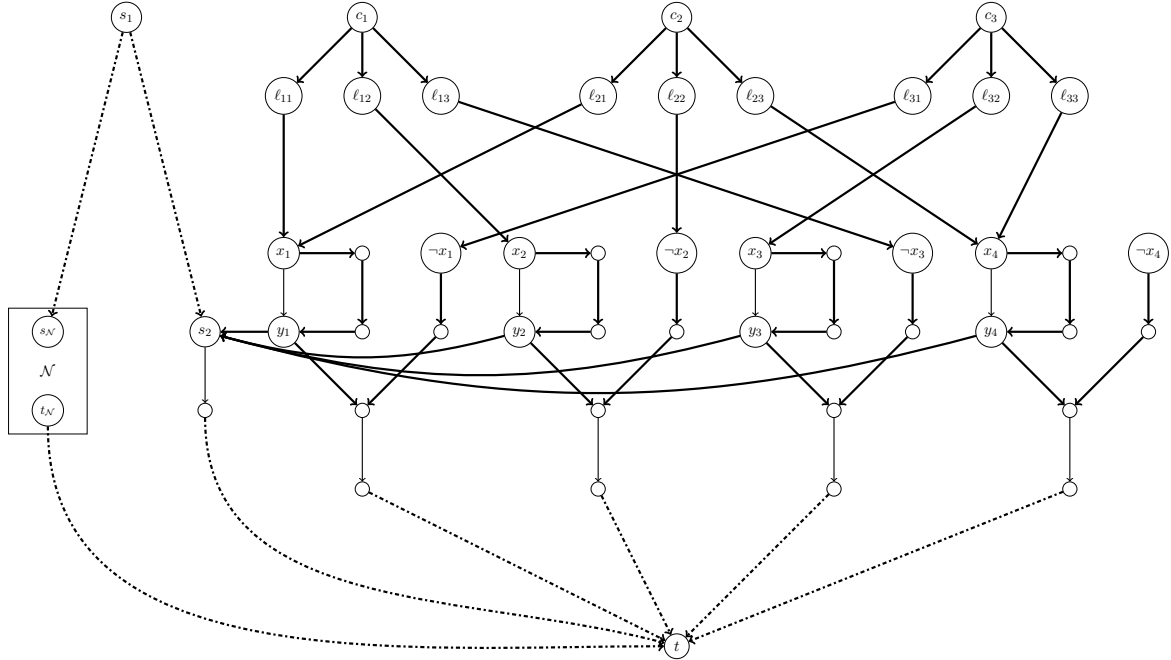

Figure 11: *The whole network for the 3SAT-formula $(x_1 \vee x_2 \vee \neg x_3) \wedge (x_1 \vee \neg x_2 \vee x_4) \wedge (\neg x_1 \vee x_3 \vee x_4)$. The bold edges have infinite capacity, while all other edges have capacity 1. The solid edges have a travel time of 1, the dashdotted edges may have variable travel time (depending on the subnetwork \mathcal{N}).*

Remark 4.9. Combining a construction similar to the one above with the single-source multi-sink network constructed in the proof of [9, Theorem 6.3] to show that multi-commodity IDE flows may cycle forever, shows that the problem to decide whether a given multi-sink network has an IDE terminating in finite time is NP-hard as well.

Remark 4.10. The above construction also shows the following aspect of IDE flows: While a network may trivially contain edges that are never used in any IDE, edges that are only used in some IDE flows and edges that are used in every IDE, there can also be edges that are either not used at all or used for some flow volume of at least c , but never with any flow volume strictly between 0 and c .

5 Conclusions and Open Questions

We showed that Instantaneous Dynamic Equilibria can be computed in finite time for single-sink networks by applying the natural α -extension algorithm. The obtained explicit bounds on the required number of extension steps are quite large and we do not think that they are tight. A further analysis is needed.

We then turned to the computational complexity of IDE flows. We gave an example of a small instance which only allows for IDE flows with rather complex structure, thus, implying

that the worst case output complexity of any algorithm computing IDE flows has to be exponential in the encoding size of the input instances. Furthermore, we showed that several natural decision problems involving IDE flows are NP-hard by describing a reduction from 3SAT.

One common observation that can be drawn from many proofs involving IDE flows (in this paper as well as in [9] and [8]) is that they often allow for some kind of *local analysis* of their structure – something which seems out of reach for Dynamic Equilibrium flows. This local argumentation allowed us to analyse the behavior of IDE flows in the rather complex instance from section 4.2 by looking at the local behavior inside the much simpler gadgets from which the larger instance is constructed. At the same time, this was also a key aspect of the positive result in section 3 where it allowed us to use inductive reasoning over the single nodes of the given network. We think that this local approach to the analysis of IDE flows might also help to answer further open questions about IDE flows in the future. One such topic might be a further investigation of the computational complexity of IDE flows. While both our upper bound on the number of extension steps as well as our lower bound for the worst case computational complexity are superpolynomial bounds, the latter is at least still polynomial in the termination time of the constructed flow, which is not the case for the former. Thus, there might still be room for improvement on either bound.

Acknowledgments: We thank the Deutsche Forschungsgemeinschaft (DFG) for their financial support.

References

- [1] David E. Boyce, Bin Ran, and Larry J. LeBlanc. Solving an instantaneous dynamic user-optimal route choice model. *Transp. Sci.*, 29(2):128–142, 1995.
- [2] Zhigang Cao, Bo Chen, Xujin Chen, and Changjun Wang. A network game of dynamic traffic. In Constantinos Daskalakis, Moshe Babaioff, and Hervé Moulin, editors, *Proceedings of the 2017 ACM Conference on Economics and Computation, EC '17, Cambridge, MA, USA, June 26-30, 2017*, pages 695–696. ACM, 2017.
- [3] Roberto Cominetti, José R. Correa, and Omar Larré. Dynamic equilibria in fluid queuing networks. *Oper. Res.*, 63(1):21–34, 2015.
- [4] Roberto Cominetti, José R. Correa, and Neil Olver. Long term behavior of dynamic equilibria in fluid queuing networks. In *Integer Programming and Combinatorial Optimization - 19th International Conference, IPCO 2017, Waterloo, ON, Canada, June 26-28, 2017, Proceedings*, pages 161–172, 2017.
- [5] Lester R. Ford and Delbert R. Fulkerson. *Flows in Networks*. Princeton University Press, 1962.
- [6] Terry L. Friesz and Ke Han. The mathematical foundations of dynamic user equilibrium. *Transportation Research Part B: Methodological*, 126:309 – 328, 2019.
- [7] Terry L. Friesz, Javier Luque, Roger L. Tobin, and Byung-Wook Wie. Dynamic network traffic assignment considered as a continuous time optimal control problem. *Oper. Res.*, 37(6):893–901, 1989.

- [8] Lukas Graf and Tobias Harks. The price of anarchy for instantaneous dynamic equilibrium flows. Working paper, 2020.
- [9] Lukas Graf, Tobias Harks, and Leon Sering. Dynamic flows with adaptive route choice. *Mathematical Programming*, 2020. <https://link.springer.com/content/pdf/10.1007/s10107-020-01504-2.pdf>.
- [10] Ke Han, Terry L. Friesz, and Tao Yao. A partial differential equation formulation of Vickrey’s bottleneck model, part ii: Numerical analysis and computation. *Transportation Research Part B: Methodological*, 49:75 – 93, 2013.
- [11] Tobias Harks, Britta Peis, Daniel Schmand, Bjoern Tauer, and Laura Vargas Koch. Competitive packet routing with priority lists. *ACM Trans. Economics and Comput.*, 6(1):4:1–4:26, 2018.
- [12] Martin Hoefer, Vahab S. Mirrokni, Heiko Röglin, and Shang-Hua Teng. Competitive routing over time. *Theor. Comput. Sci.*, 412(39):5420–5432, 2011.
- [13] Anisse Ismaili. Routing games over time with fifo policy. In Nikhil R. Devanur and Pinyan Lu, editors, *Web and Internet Economics*, pages 266–280. Springer International Publishing, 2017. There is also a version available on arXiv: <http://arxiv.org/abs/1709.09484>.
- [14] Anisse Ismaili. The complexity of sequential routing games. *CoRR*, abs/1808.01080, 2018.
- [15] Marcus Kaiser. Computation of dynamic equilibria in series-parallel networks. *Math. Oper. Res.*, 2020. forthcoming.
- [16] Ronald Koch and Martin Skutella. Nash equilibria and the price of anarchy for flows over time. *Theory Comput. Syst.*, 49(1):71–97, 2011.
- [17] Georg Kraus. Calculation of IDE-flows in SP-networks, 2020. Master’s Thesis (unpublished).
- [18] Zhi-Chun Li, Hai-Jun Huang, and Hai Yang. Fifty years of the bottleneck model: A bibliometric review and future research directions. *Transportation Research Part B: Methodological*, 139:311 – 342, 2020.
- [19] Hironori Otsubo and Amnon Rapoport. Vickrey’s model of traffic congestion discretized. *Transportation Research Part B: Methodological*, 42(10):873 – 889, 2008.
- [20] Bin Ran and David E. Boyce. *Dynamic urban transportation network models: theory and implications for intelligent vehicle-highway systems*. Lect. Notes Econ. Math. Syst. Springer, Berlin, New York, Paris, 1996.
- [21] Bin Ran, David E. Boyce, and Larry J. LeBlanc. A new class of instantaneous dynamic user-optimal traffic assignment models. *Oper. Res.*, 41(1):192–202, 1993.
- [22] Marco Scarsini, Marc Schröder, and Tristan Tomala. Dynamic atomic congestion games with seasonal flows. *Oper. Res.*, 66(2):327–339, 2018.

- [23] Leon Sering and Laura Vargas-Koch. Nash flows over time with spillback. In *Proc. 30th Annual ACM-SIAM Sympos. on Discrete Algorithms*, ACM, 2019.
- [24] William S. Vickrey. Congestion theory and transport investment. *Am. Econ. Rev.*, 59(2):251–60, May 1969.