

# TECHNICAL REPORT

## Design and Implementation of SMARTHO – A Network Initiated Handover mechanism in NG-RAN, on P4-based Xilinx NetFPGA switches

Phanindra Palagummi and Krishna M. Sivalingam

*Department of Computer Science and Engineering*

*Indian Institute of Technology Madras, Chennai, INDIA*

Emails: {phanindra.palagummi@gmail.com, skrishnam@iitm.ac.in, krishna.sivalingam@gmail.com}

July 7, 2020

### Abstract

This report deals with the design of handover schemes for radio access networks (RAN) in 5G networks, using programmable data plane switches. The network architecture is expected to be a centralized cloud infrastructure, connected via a backhaul network to many edge-computing clouds that are closer to the end-user. Some of the network services can be implemented in edge devices to improve network performance.

In 5G networks, the C-RAN architecture splits the Base Band Unit (BBU) into Central and Distributed Units (CU and DU). This structure has created a mid-haul Network, connecting CUs and DUs. The mid-haul network has created a dataplane challenge that does not exist in traditional distributed RANs – the need for efficient connections between the CUs and DUs. Traditional encapsulation techniques can be used to transport packets across the CU and DU. However, the recent advancements in dataplane programmability can be used to enhance the system performance. In this report, we show how P4 switches can be used to parse the packets between DU, CU, and Back Haul (Core Network) for potential system improvements. In particular, we consider the scenario of mobile handover, that arises when a user moves between different cells in the mobile network. The proposed protocol is called *SMARTHO*, illustrating a smart handover.

*Programming Protocol-Independent Packet Processors (P4)* is a programming language designed to support specification and programming the forwarding plane behavior of network switches/routers. With P4 switches, the protocol designer can define customized packet headers, parsing of headers, and defining new match-action routines. In *SMARTHO*, we use P4 Switches to intervene in the handover process for fixed-path mobile users. Such users could be those in a train, drones, devices with high-degree of predictable mobility, etc. A resource pre-allocation scheme that reserves resources before the UE reaches a future cell, is proposed. The solution is implemented using a P4-based switch introduced between the CU and the DU. The P4 switch is used to spoof the behavior of User Equipment (UE) and perform the resource allocation in advance. This is expected to reduce the handover time as the user moves along its path.

The proposed *SMARTHO* framework is implemented in the *mininet* emulation environment and in a reconfigurable hardware environment using NetFPGA-SUME boards. For Mininet based simulation, we used virtual hosts connected using P4 switches, using the P4 behavior model (P4BMv2) software switch. User and control traffic is also generated to simulate the mobile traffic and measure the HO performance. User traffic is represented using ICMP ping packets over a tag. The results show a handover response time improvement of 18% for a tandem of two HOs and 25% for a tandem of three HOs. For testbed implementation, we used

NetFPGA-SUME boards as P4 switches. The Xilinx SDNet tool-chain is used to compile P4 programs directly to NetFPGA-SUME. Raw data packets are generated using the *scapy* tool. The handover time was measured to be approximately 50 milliseconds in the experiments conducted.

### Index Terms

Programmable Data Plane, P4 language, Prototype, Mininet Emulation, Mobility Management, 5G Networks, Next Generation-Radio Access Network (NG-RAN), Handover Mechanism.

## I. INTRODUCTION

This report deals with improving handover performance in 5G Wireless networks, using the programmable data plane switch paradigm. A large number of operators are now evaluating Next-Generation RAN (NG-RAN) as a way to meet future service requirements. NG-RAN is an enhancement to the earlier Cloud-RAN (C-RAN) architecture that is fully-centralized and fixed, but not adaptive to network traffic. Part of this work was published as a short paper [1] and as a M.S. (by Research) Thesis at Indian Institute of Technology Madras, Chennai, INDIA [2].

In the NG-RAN architecture, real-time (RT) functions are deployed near the antenna site to manage air interface resources, by the Distributed Units (DU). At the same time, non-real-time (NRT) control functions are hosted centrally in the Central Unit. This split functionality is now part of the 3GPP specification [3]. The services offered by the CU and DU can be virtualized in software and placed in Commercial off-the-shelf (COTS) servers, using Network Function Virtualization (NFV) [4]–[7].

In this report, we design a solution for handling mobile device handover, using programmable data-plane switches based on P4 programming language [8]. P4-based switches are used to parse the packets and to invoke additional actions defined by the protocol designer. These actions can be made to perform simple forwarding or can aid functional behaviour of the system.

In particular, we propose a Smart Handover (SMARTHO) process for fixed-path mobile devices, such as LTE users in a train, drones, predictable mobility devices, etc. is considered. In particular, the handover is considered for Intra-CU HO from one Radio Head (RH) to another RH in a different DU, but connected to the same CU. This scenario is shown in Figure 1. A resource allocation scheme that reserves resources ahead of the UE in its path is proposed. The solution is implemented using a P4-based switch introduced between the CU and the DU. We use the P4 switch to spoof the behaviour of User Equipment (UE) and perform the resource allocation in advance. Using an implementation based on Mininet and P4BM software switch, it is seen that the proposed method results in an 18% and 25% improvement in the sequence of two and three handovers, respectively. A prototype of the mechanism has also been implemented in a reconfigurable hardware environment using Xilinx NetFPGA-SUME boards, using the P4 Programmable Data Plane (PDP) language [8]–[10].

We have considered the Intra-CU handover in this report; however, this idea can be applied to other HO processes specified in 3GPP [3].

## II. BACKGROUND

This section presents the relevant background material.

### A. 5G NG-RAN

There are several service dimensions in 5G networks [11], including support for massive Machine-Type Communications (mMTC), enhanced Mobile Broadband (eMBB), and Ultra-Reliable Low-Latency Communications

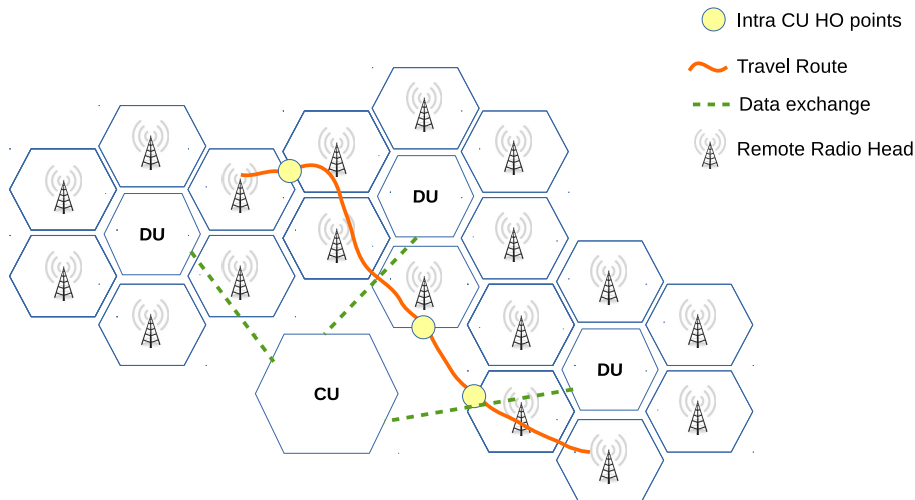

Figure 1: Intra-CU Handover.

(UR-LCC) services. Each service has very different performance requirements and traffic profiles. To serve these new markets and to increase revenues substantially, operators need highly scalable and flexible networks. A large number of operators are now evaluating Next-Generation RAN (NG-RAN) as a way to meet future service requirements. From the initial days of deploying Cloud-RAN [12], which was business oriented to save operational costs, the focus has now evolved to meet the future complex and varied service requirements.

1) *C-RAN and NG-RAN*: The traditional C-RAN architecture is fully-centralized and fixed, which is not adaptive to the movable traffic and the advanced software defined networking concepts. As a result, it is urgent to improve the friable capability of C-RANs. This led the research community to work on functional split options in C-RAN. In FluidNet [13], the novel concept of re-configurable fronthaul is proposed, to flexibly support one-to-one and one-to-many logical mappings between Base Band Units (BBUs) and Radio Resource Heads (RRHs) to perform proper transmission strategies. R-FFT [14] proposed IFFT/FFT the PHY layer split, which would reduce the fronthaul bitrate requirements and enable statistical multiplexing. An optimal functional split is discussed by wang et al., team [15]. The technical report [16] sets out various options for the RAN and its interfaces to the core network.

In the NG-RAN architecture, real-time (RT) functions are deployed near the antenna site to manage air interface resources, while non-real-time (NRT) control functions are hosted centrally to coordinate transmissions across the coverage area. In NG-RAN, this is being formalized with the Centralized Unit (CU) and Distributed Unit (DU) functional split. This functional architecture is now native to the 3GPP specification [3].

### B. Architectural Principles of CU and DU Split

The implementation of the NG-RAN architecture and its subsequent deployment in the network depends on the functional split between distributed radio and centralized control, called the DU-CU split. The DU will process low-level radio protocol and real-time services while the CU will process non-real-time radio protocols.

3GPP has recognized eight different split options [16]. Of these option-2 and option-3, are the most widely discussed two splits. In option-2 the function split will have “Radio Resources Control” (RRC), “Packet Data Convergence Protocol” (PDCP) in the CU. DU will perform the low-level stack of “Radio Link Control” (RLC), “Media Access Control” (MAC), while the physical layer and RF will be in Remote Radio Unit (RRU).

In the option-3 split, low RLC (a partial function of RLC), MAC, physical layer are in DU. PDCP and high RLC (the other partial function of RLC) are in the CU. These split options are discussed in 3GPP status meeting [17]. The services of CU and DU can be virtualized and put in Commercial off-the-shelf (COTS) servers, these virtualized network nodes or Virtual Network Functions (VNFs) can be realized with a network architectural concept called Network Function Virtualization (NFV) [4]. NFV offers a new way to design, deploy and manage virtual network nodes. It also enables us to decouple suppliers hardware and software business models, opening new innovations and opportunities for SW integrators.

The management and operational aspects of NG-RAN with CU and DU splits would be easy to handle using NFV. There are several research papers which already attempted in virtualizing mobile network functions [5]–[7].

### C. Intra-CU Handover

In a wireless network, user equipment (UE) handover from one cell to another cell is an important aspect of mobility management. In this report, we consider intra-DU handover within a single CU. Typically, there are 3 phases in a handover (HO) process: Preparation Execution and Completion.

The preparation phase deals primarily with resource allocation for the UE in the next DU. In this phase, the Measurement Report (MR) message from the Source\_DU will be transmitted to the CU, which would select the Target\_DU for the HO. The CU will send the HO request (UE Context Request), containing Target-DU-ID, UE context info & UE History Information. When the Target\_DU receives the HO request, it begins handover preparation to ensure seamless service provision for the UE. The Target\_DU would respond with setting up Access Stratum (AS) security keys, uplink bearers connecting to the backhaul, reserve Radio Resource Control (RRC) resources to be used by the mobile device over the radio link and allocates Cell-Radio Network Temporary Identifier. Once the resources are allocated by the Target\_DU, a response message called the “UE context setup response” is sent to the CU.

Once handover preparation between the two DUs (Source\_DU and Target\_DU) is completed, the execution phase will start to have the UE perform a handover. The Source\_DU instructs the UE to perform a handover by sending RRC Connection Reconfiguration message that includes all the information needed to access the Target\_DU. The Target\_DU sends an Uplink RRC Transfer message to the CU to convey the received RRCConnectionReconfigurationComplete message. Then, downlink packets are sent to the UE. Also, uplink packets are sent from the UE, which are forwarded to the CU through the Target\_DU.

In the final completion phase, the CU sends the UE context release command to the Source\_DU which would release all the bearers from CU to Source\_DU.

In this report, we deal with the preparation phase, by proposing a advanced resource allocation scheme along a set of pre-defined DU nodes. The proposed design, working model and elements involved in SMARTHO are discussed in Section III.

### D. Related Work

There are several papers that deal with handover procedures involving high mobility. We focus on works dealing with handover support for fixed-path mobile users, such as those on a train.

In [18], a dual\_link HO scheme is studied for wireless Mobile communication in high\_speed rails. Here, an extra antenna is used, one for handover and other for data communication with the base station. In [19], a radio-over-fibre based approach has been proposed to provide communications inside long tunnels using

distributed antenna systems, and performing HO over these antennae. In [20], a multiple-tunnel based approach with multiple interfaces and a modified "Hierarchical Mobile IPv6" (HMIPv6) Mobility Management method, is considered. In, [21], mobility prediction based handover with RAN-Cache has been studied for HetNets.

In [22], a variant of Proxy Mobile Internet Protocol (PMIP) is developed to reduce ping-pong (PP) events and handover failures. In [23], vertical handover is considered by introducing a layer between MAC and PHY layers; this extra layer performs the handover across different technologies.

A measurement of LTE performance on high velocity environment is studied in [24]. Some papers have studied approaches on the Time To Trigger (TTT) for handover. The work in [25] showed that a lower value of TTT for HO would decrease the handover failure, but would increase the ping-pong effect. The work [26] suggested that handover margin is more appropriate than TTT to adjust handover timing, in response to the change in mobility conditions. In [27], the relation between the TTT and the position of high speed train was investigated. The work in [28] presents an integrated HO algorithm in LTE networks, while a Received Signal Strength (RSS) based TTT algorithm has been studied in [29].

In all above papers dealing with fixed-path user mobility, pre-allocation of resources along the path have not been considered. In this report, We attempt this approach with the use of programmable data-plane entities.

### *E. Programmable Data Plane Switches*

The recent Software Defined Networking networking paradigm (SDN) and associated protocols and implementations such as OpenFlow Protocol [30] and Open VSwitch (OVS) [31] allow programmability in the data plane. However, these are not protocol independent. When these switches are used in mobile networks where protocol stack largely differ from the standard protocols, the forwarding behaviour would be limited to encapsulation/tunneling mechanisms. The strict parsers and forwarding routines can help improve the forwarding behaviour [32]–[34], but would not aid in adding new system functions.

Programming Protocol independent Packet Parsers (P4) provides is an upcoming framework for realizing programmable data-plane switches [8]. P4 switches are expected to perform better than traditional L2-L3/Open Flow switches due to the additional functionality enabled. For instance, we show that a simple tag based forwarding approach over an IP-based encapsulation mechanism is showing 27% improvement using a P4 behaviour model (P4BM) software switch. Hence, this report considered the use of P4-based switches for improving handover performance in future wireless networks.

## III. PROPOSED SMARTHO FRAMEWORK

This section presents the details of the proposed Smart Handover (SMARTHO) mobility management framework.

### *A. SMARTHO Architecture and Components*

This section presents the architecture, components and message exchanges involved in SMARTHO model. 3GPP has already discussed the NG-RAN architecture [3]. For SMARTHO, we introduce programmability into the data plane without changing the existing architectural framework.

The main components of the proposed CU and DU architecture are COTS compute servers, P4 switches, and a Network Controller. The compute servers will implement the functions of CU and DU, P4 switches, and Network Controller. The interconnections and components of SMARTHO framework are shown in Figure 2.

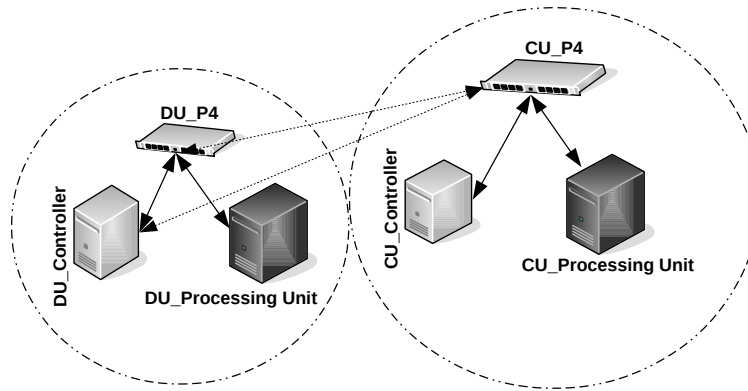

Figure 2: Proposed SMARTHO Framework.

The network controller at the CU (CU\_Controller) will store the “UE Mobility Information” and the “UE Context Information”. The network controller at the DU (DU\_Controller) will store the RRC Connection Reconfiguration (RRCCR) message. The P4 switches will process the messages from processing units and perform the SMARTHO process, by sending appropriate instruction messages to CU and DU Controllers.

The first handover of a given UE will set the UE context information in the CU\_Controller. After the first HO is completed, the SMARTHO initiation will happen which automates the subsequent handovers. The P4 switches in CU (CU\_P4) and DU (DU\_P4) will send the instruction messages to CU\_Controller to access the mobility information and DU\_P4 switches to store the RRCCR message respectively.

These P4 switches can be hardware switches [35] or a virtual switch [36]. Placement of P4 switches in CU and DU can impact the routing performance of the system. A study of this aspect is not in the scope of this report. Hence, without loss of generality, we assume all the P4 switches are at the access layer connected directly to servers and controller as shown in Figure 3.

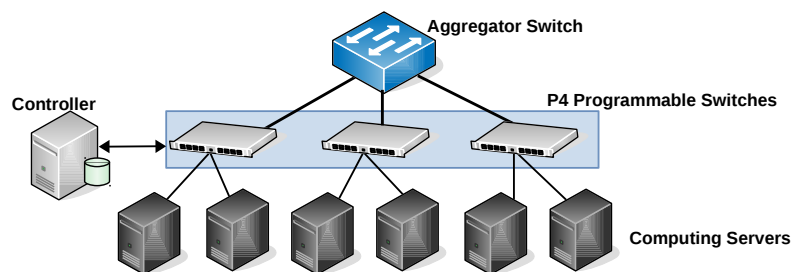

Figure 3: Topology interconnecting CU and DUs.

### B. Modified Handover Sequence

The entire 3GPP process with P4 switches in CU with sequence of messages is shown in Figure 4. In the first handover, P4 switches will parse the incoming packets and negotiate with local storage at CU to determine if the UE is having a fixed path. If so, after the completion of first HO, the P4-switch will generate "UE Context Setup Request" message and forward it to the Target HO entities, on behalf of the UE. This is referred to a Smart Handover (SMARTHO) in this report. This action will trigger the HO preparation phase, even before UE reaches the specified HO points, as shown in Figure 1.

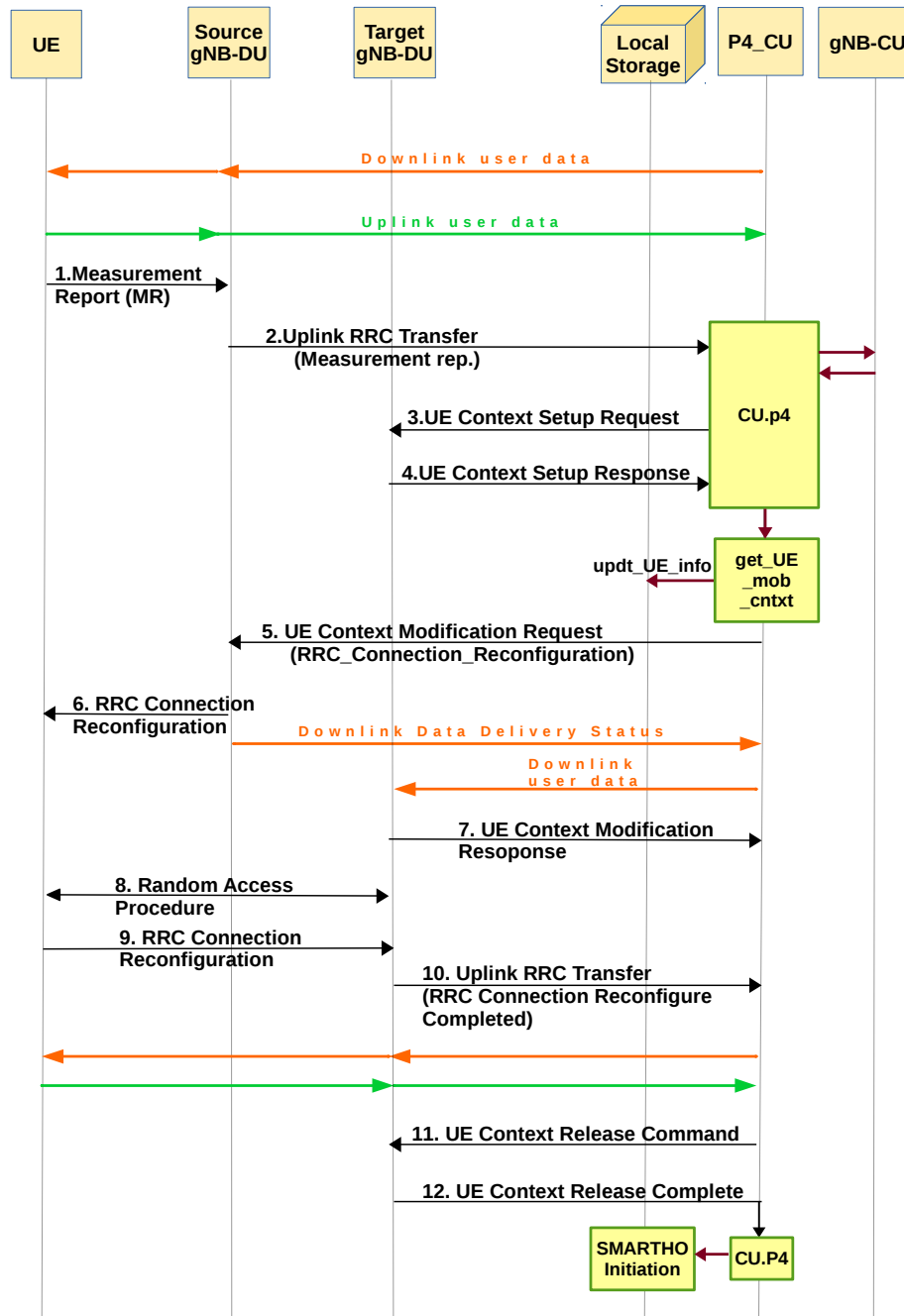

Figure 4: Sequence diagram of Intra-CU Handover.

This would make all the Target HO entities to reserve resources and respond to CU with appropriate “UE Context Setup Response”. The “UE Context Setup Response” message would be saved at Source\_DU and can be later forwarded by the P4-switch as a response to the UE MR. By this spoofing approach, we parallelize the HO preparation phase, which will improve the performance of the handover process.

### C. Architecture and Design of P4 switches

There are several switch architectures such as Pisces [37] and Portable Switch Architecture (PSA) [38] that support protocol independent switches. In this report, we use the Very Simple Switch (VSS) Architecture [39].

VSS has basic programming blocks needed for protocol independent switch, which are sufficient to implement the SMARTHO process.

The programming blocks of VSS are: (i) Parser; (ii) Match-Action Pipeline; and (iii) De-parser. The parser is a Finite State Machine (FSM), which either accepts or rejects the packet. For every packet the P4 switch receives, it will parse the packets and would extract the header information. The header information obtained is used in the Match-Action Pipeline to invoke a necessary action routine in Match-Action control block. The De-parser will reconstruct the packet, putting back the extracted content of the header with necessary modifications, if needed.

Next generation mobile networks have a complex packet structure. Designing a parser for entire packet structure would overload the functionality of the P4 switch, increasing the complexity of the parser. Also, the structure of the packets for mobile networks would depend on the state information. P4 switches are not scalable to parse such packets as of now. To simplify this process, we design a *tag*-based approach to identify necessary packets for SMARTHO. The tag will be added by the processing units or controller. The P4-switches in the SMARTHO model handles three types of packets:

- 1) User packets of the 5G system: These packets are ICMP packets encapsulated over the tag, the forwarding is done using tag information.
- 2) Control packets for HO: In case of Intra CU HO, the entire HO process has twelve control messages exchanging, shown in Figure 4. These packets have to be identified and will be sent to P4 switches or controller for processing.
- 3) Instruction packets: These packets will either instruct the P4 switch to initiate specific methods in Match-Action control block or the controller to store/retrieve the data.

#### D. Custom Data Structures

Three special data structures have been defined to store the necessary state information: Mobility Table (MT), Controller Cache (CC) and RRC Table (RRCT). MT and CC will reside in CU\_Controller and RRCT will reside in DU\_Controller. The details are given below.

A data structure is defined to store the necessary information needed for the SMARTHO process. We define three data structures Mobility Table (MT), Controller Cache (CC) and RRC Table (RRCT). MT and CC will reside in CU\_Controller and RRCT will reside in DU\_Controller

1) *Mobility Table (MT)*: MT stores the mobility information of the UE. With the details in MT, P4 switch will identify the Target\_DU for the next HO. The controller would use MT information to trigger the SMARTHO-Initiation (discussed in the Section IV-B) at an appropriate time. Every MT entry contains:

- UE-ID: Identification of the user equipment
- Source DU ID: The source DU global identification
- Target DU ID: The next target DU global identification for the current Source DU ID
- Time Interval: Appropriate time interval after which the SMARTHO process is triggered.

2) *Controller Cache (CC)*: The UE Context Information is retrieved from the message "UE Context Setup Request", which is triggered from CU processing unit. This information thus retrieved is stored in CU Controller Cache (CC). CU\_P4 switch forwards the "UE Context Setup Request" to CU Controller as shown in Figure 6 to update the UE context information in CC. Every CC entry contains:

- UE-ID: Identification of the user equipment
- UE-AMBR: Aggregated Max Bit Rate



- UE-Security-Algorithm: Encryption algorithm used by UE
- Security-Base-Key: Base key to encryption keys

3) *RRCT Table (RRCT)*: RRCT will store the final HO preparation message (UEModReq/RRCCR) at DU\_Controller. The DU\_P4 switch will instruct the DU\_Controller to store the UEModReq message. The RRCT contains all the fields of UEModReq message, as shown below.

- UE-ID: Identification of the user equipment
- Target DU ID: Aggregated Max Bit Rate
- Bearer information: Bearer ID allocated by the Target\_DU
- Security-Algorithm: Security algorithm at the Target DU

All the three types of packets are encoded with the respective tags. The differentiation is done based on the extracted tag and examining the valid/invalid bit [39]. The parser in P4 switch should be indicated about the appropriate tag, for this we use, Ethernet-Type from Ethernet header. IEEE802.3 has assigned EtherType 0x0101-0x01FF as experimental, we can use any of these for indication of tag header. The parser routine of the P4 switch in CU is shown in Algorithm 1.

---

**Algorithm 1** parser block for cu.p4

---

```

header_union Tag{
    FrwdTag t1;
    CntrlTag t2;
    InstTag t3;}
struct Parsed_packet {
    Ethernet ethernet;
    Tag tag;}
parser Simple_Parser(packet_in packet,
                    out Parsed_packet hdr){
    state start
        packet.extract(hdr.ethernet);
        transition select(hdr.ethernet.etherType)
            16w0x0101 : parse_inst_tag;
            16w0x0102 : parse_cntrl_tag;
            default : parse_frwd_tag;
    state parse_inst_tag
        packet.extract(hdr.tag.t3);
        transition accept;
    state parse_cntrl_tag
        packet.extract(hdr.tag.t2);
        transition accept;
    state parse_frwd_tag
        packet.extract(hdr.tag.t1);
        transition accept;
    }

```

---

#### IV. IMPLEMENTATION DETAILS

The HO preparation is a resource allocation phase, in the case of fixed path mobile devices the resource allocation can be done a priori. The idea is to preset all the subsequent HOs with appropriate timing delays based on the first HO request.

The preparation phase for the second Intra-CU HO is done before the UE reaches the second Intra-CU HO point. The P4 switch initiates the preparation phase for the Second Intra CU HO, i.e., CU\_P4 switch along with CU\_Controller spoofs the UE and sends a “UE Message Setup Request” to the Target\_DU. When the UE reaches the vicinity of the second HO point, UE will trigger the MR message to Source\_DU; subsequently, the Source\_DU\_P4 will respond with the RRCCR message.

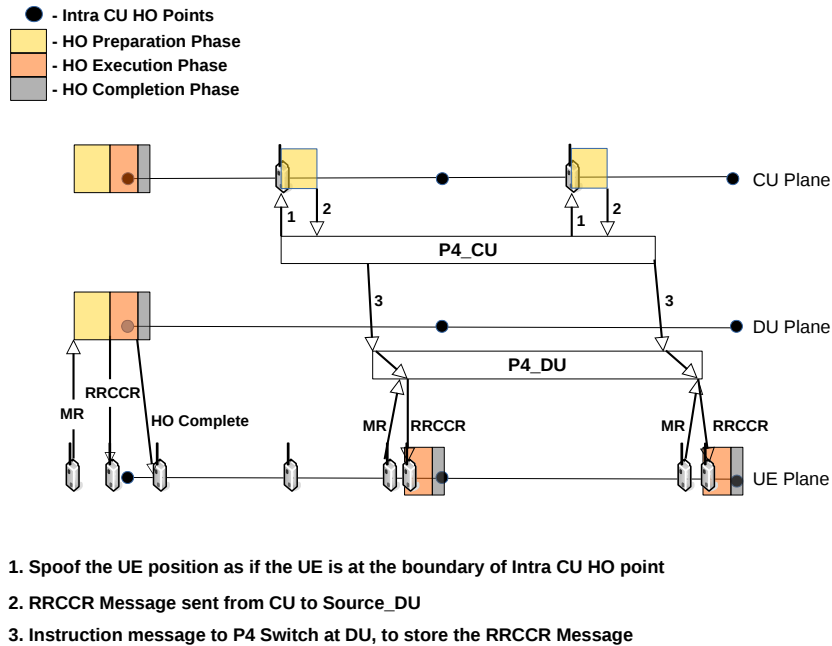

Figure 5: Operation of handover process, using P4 switches.

As described earlier, we perform the HO preparation phase in advance of the UE movement, in order to decrease the overall HO time. Figure 5 presents the working details of SMARTHO, with a sequence of three Intra-CU handover (HO) points. The operation of SMARTHO has three phases: SMARTHO-Data Setup, SMARTHO-Initiation and SMARTHO-Completion, as described below.

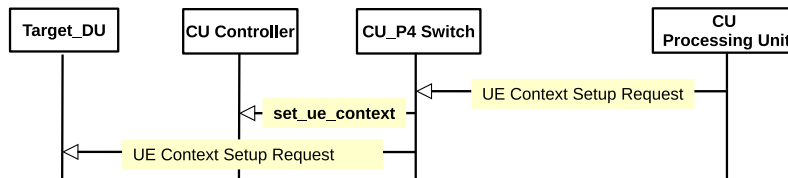

Figure 6: Trigger sequence of SMARTHO.

### A. Data Setup

The current context of the UE has to be retrieved, before the start of the SMARTHO process. The context information of UE can be retrieved from the “UE Context Setup Request” message, which is exchanged between CU and Target\_DU as shown in Figure 4. The UE context information is updated in the data table CC.

This message is sent to the CU\_P4 switch. The CU\_P4 switch can identify the control packets for HO, this can be done by changing the code at CU part, to send the HO message “UE Context Setup Request” with tag

value 0x03, as discussed in Section III-C. The CU\_P4 will identify the tag and execute a routine to send the message `set_ue_context` to the CU\_Controller, which will store the UE context information in CC, as shown in Figure 6. The `set_ue_context` contains the UE identifier, Aggregate Maximum Bit Rate (AMBR) for the UE, and other relevant information.

---

**Algorithm 2** `cu.p4`

---

```

control Ingress(inout headers hdr,
               inout metadata meta,
               inout standard_metadata_t standard_metadata) {
  table etherforward
    key = hdr.ether.dst_addr : exact;
    actions =
      ether_port_forward;
      operation_drop;
      const default_action = operation_drop();
  action cu_controller_forward()
    standard_metadata.egress_spec
      = controller_port;
  table source_gnb_controllerforward
    key = hdr.ue_context.src_gnb_addr : exact;
    actions =
      prepare__port_forward;
      operation_drop;
      const default_action = operation_drop();
  apply{
    if (hdr.tag.isValid())
      if(hdr.ue_context.isValid())
        cu_controller_forward();
      else
        source_gnb_controller_forward.apply();
    else
      etherforward.apply();
  }
}

```

---

The P4 switch at CU identifies the `set_ue_context` message and forwards it to the CU\_Controller, this is shown at a high level in Algorithm 2. Once the CU\_Controller receives the `set_ue_context` message, it updates its CC using a packet sniffer at the controller.

### B. SMARTH0 - Initiation

The initiation of the SMARTH0 process is shown in Figure 7. The Source\_gNB\_DU sends the “UE Context Release Complete” message with a tag value of 0x0c to the CU\_P4. This switch parses the packet and identifies the message with the tag value and initiates the process of SMARTH0. This is done by sending the `smartho_init` message to the CU\_Controller with a tag value of 0x02. The purpose of the `smartho_init` message is to retrieve the address of Target\_gNB\_DU from MT for the next HO and *delay* information of the UE. This delay value is used to hold the process before starting the preparation phase.

The CU\_Controller runs a packet sniffer at the ingress port. When a `smartho_init` message is received, the sniffer runs a background process. This will send the `smartho_trigger` message to the CU\_P4 switch with a tag

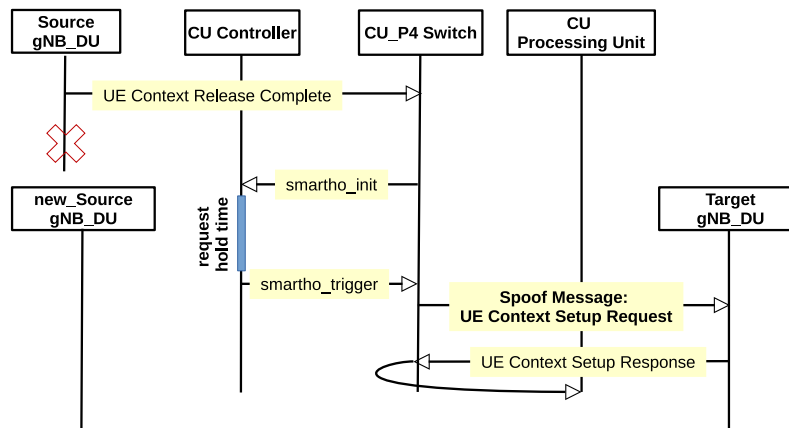

Figure 7: Initiation sequence of SMARTHO.

value of 0x02 as shown in Algorithm 3. The `smartho_trigger` message is sent after a particular delay value, as discussed later in Section IV-D.

The `smartho_trigger` message is the basis to send the spoofed “UE Context Setup Request” message for the next HO to the `Target_gNB_DU`. This will initiate the HO preparation phase for the subsequent HO.

---

**Algorithm 3** `smarthoInit`

---

```

1: global variables
2:   mobility_tag = 2
3: end global variables
4: function TriggerSmartho(ue_id,src_du)
5:   mobility_details[]=query_mobility_table(ue_id,src_du)
6:   context_details[]=query_controller_cache(ue_id)
7:   delay(mobility_details[time_interval])
8:   ether=Ether(dst_addr, type=0x0101)
9:   tag=Tag(mobility_tag)
10:  context_info=create_header(context_details)
11:  ue_context_req_pkt = ether/tag/context_info
12:  srp1(ue_context_req_pkt, iface="eth")
13: end function

```

---

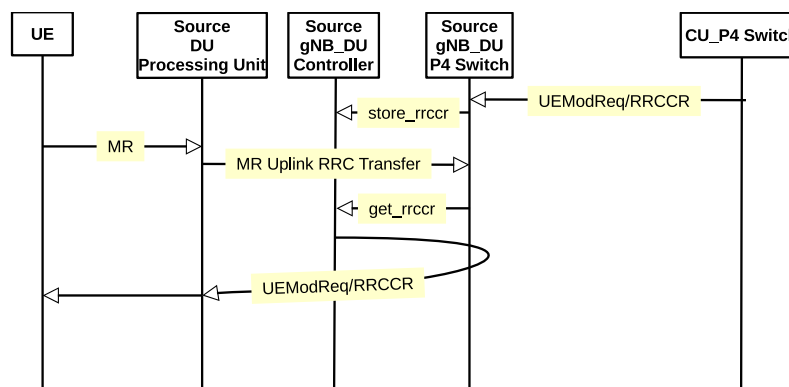

Figure 8: Completion sequence of SMARTHO.

### C. SMARTH0 Completion

The final phase of SMARTH0 is to handover the UEModReq/RRCCR message as a response to UE MR, as shown in Figure 8. The UEModReq/RRCCR message that is sent from CU to Source\_DU is intercepted by the Source\_DU\_P4 switch. This would instruct the Source\_DU\_Controller to store UEModReq/RRCCR message. This message contains the UEModReq information that is updated in the RRCT of DU\_Controller. Algorithm 4 and the P4 code segment shown in Algorithm 5 present the details of this operation.

When a UE sends the MR to Source\_DU, the Source\_DU would respond with “Uplink RRC Transfer message” to CU. The DU\_P4 switch intercepts this message and instructs the controller to get the UEModReq/RRCCR message which is forwarded to UE as shown in Figure 8.

---

#### Algorithm 4 DUController

---

```

1: global variables
2:   store_rrc_tag = 15
3:   mr_uplink_rrc_tag = 1
4: end global variables
5: function Data_Updt(packet)
6:   if packet.tag == store_rrc_tag then
7:     rrc_packet_data[]=extract_packet_content(packet)
8:     query load rrct rrc_packet_data[]
9:   end if
10:  if packet.tag == mr_uplink_rrc_tag then
11:    query uemod_reqmsg=get rrct(packet.ue)
12:    srp1(uemod_reqmsg, iface="eth")
13:  end if
14: end function
15: procedure main
16:   sniff(iface="eth",prn=DATA_UPDT)
17: end procedure

```

---

---

**Algorithm 5** du.p4

---

1: **global variables***ue\_context\_tag* = 1*mobility\_tag* = 22: **end global variables**3: **function** Parser(*packet\_in* packet, *out headers* hdr)**parser** Simple\_Parser(*packet\_in* packet,  
                          *out headers* hdr){  *state* start {    packet.*extract*(hdr.ethernet);    *transition select*(hdr.ethernet.etherType) {

0x0101 : parse\_inst;

*default* : *accept*;                          }

}

*state* parse\_inst {    packet.*extract*(hdr.tag);    *transition select*(hdr.tag.tag\_value) {

0x01 : parse\_ue\_context;

*default* : *accept*;                          }

}

*state* parse\_ue\_context {    packet.*extract*(hdr.ue\_context);    *transition* *accept*;

}

}

4: **end function**

---

*D. Delay Estimation for Early Resource Allocation*

The UE context setup is done by the Target\_DU before allocating the resources, as described earlier. Once the UE context set-up is done at the T\_DU, the T\_DU waits for the ‘‘Random Access Procedure’’. If this is not received before timer expiry, the ‘‘UE Context Release Request’’ will be initiated to release all the necessary bearers. The timer expiry is triggered based on the user inactivity or by policy controls [40]. In SMARTHO, the advanced allocation of resources would be wasted. Hence, an appropriate delay has to be put before SMARTHO Initiation.

To estimate the delay ( $t_{delay}$ ) to initiate the SMARTHO process, we need three inputs: (i) Estimated arrival of Measurement Report (MR) for next HO ( $t_{MR}$ ); (ii) Total Response time for HO preparation ( $t_{prep\_HO}$ ); (iii) Trigger time, for ‘‘UE Context Release Request’’ by T\_DU ( $t_{trig}$ )

Using Machine Learning techniques with the features such as traffic intensity at switches, history information and so on, we can predict the estimated arrival time of the MR message.

The HO preparation time ( $t_{prep\_HO}$ ) would include the processing times of CU and DU cloud units and processing times of routers connecting CU, DU and RRH. For estimating this we model the system as a simple network of queues. We assume that the packet arrival process at a UE is Poisson; service time is exponential; and routers have limited buffer capacity. We model the routers as a  $M/M/1/B$  queue, and the CU and DU entities as  $M/M/1$ . We model the system as a tandem of  $M/M/1/B$  and  $M/M/1$  queuing system. The variables are shown in Table I.

For  $M/M/1/B_x$  system, the response time is given by:

Table I: Variables in queuing model

$t_{pd\_sDU\_CU}$	Propagation delay from Source_DU to CU
$t_{pd\_tDU\_CU}$	Propagation delay from Target_DU to CU
$t_{pc\_cd}$	Expected response time at CU and DU in HO preparation phase
$t_{pc\_rt}$	Expected delay by routers in HO preparation phase
$n^{r\_sd}$	number of routers between RRH and Source_DU
$n^{r\_td}$	number of routers between RRH and Target_DU
$n^{sd\_cu}$	number of routers between Source_DU and CU
$n^{td\_cu}$	number of routers between Target_DU and CU
$n$	total number of routers between RRH, Source_DU, Target_DU and CU. Each router indexed as $x \in \{1 \dots n\}$ $n = n^{td\_cu} + n^{sd\_cu} + n^{r\_sd} + n^{r\_td}$
$B_x$	Buffer size in router $x$ , present between CU and DU, $x \in 1, 2, \dots, n$
$\lambda_x$	packet arrival rates in router $x$
$\mu_x$	router $x$ processing rates in
$E[r_x]$	expected response time of router $x$

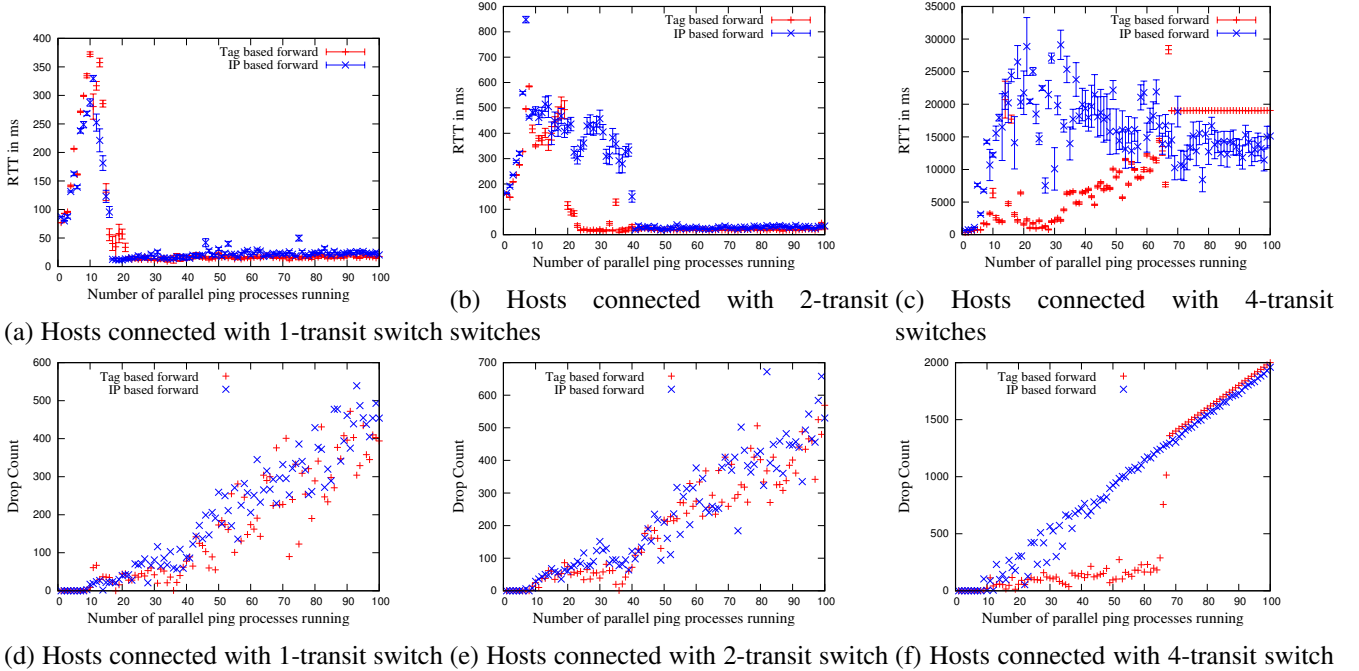

Figure 9: Comparison of Tag- and IP-based forwarding mechanisms.

$$E[r_x] = \frac{\lambda_x}{\mu_x - \lambda_x} + \frac{B_x \lambda_x^{B_x+1}}{\mu_x (\mu_x^{B_x} - \lambda_x^{B_x})} \quad (1)$$

For CU and DU as  $M/M/1$ , the steady-state response time is given by:

$$E[r_X] = \frac{1}{\mu_X - \lambda_X} \text{ where, } X \in \{\text{CU}, \text{S\_DU}, \text{T\_DU}\} \quad (2)$$

The total time taken for HO preparation is processing the Context Requests and Measurement report. The four messages indexed 2,3,4,5 shown in Figure 4 are HO preparation messages.

The processing time taken by the routers in HO preparation phase ( $t_{proc\_rt}$ ) is,

$$t_{proc\_rt} = 2 \left( \sum_{x=1}^{n^{sd\_cu}} E[r_x] + \sum_{x=1}^{n^{td\_cu}} E[r_x] \right)$$

The processing time taken by the CU and DU in HO preparation phase ( $t_{proc\_cd}$ ) is,

$$t_{proc\_cd} = 2 * (E[r_{S\_DU}] + E[r_{T\_DU}])$$

Total time taken for HO preparation is,

$$t_{prep\_HO} = 2 * t_{pd\_sDU\_CU} + 2 * t_{pd\_tDU\_CU} + t_{pc\_rt} + t_{pc\_cd}$$

The trigger time ( $t_{trig}$ ) will include the trigger time and uplink transfer time, approximated as:

$$t_{trig} = \text{trigger time} + t_{pd\_tDU\_CU} + \sum_{x=1}^{n^{td\_cu}} E[r_x]$$

$$t_{delay} = t_{MR} - (t_{prep\_HO} - t_{trig})$$

This value of delay of  $t_{delay}$  is used an approximate value during SMARTHO initiation, described earlier in Section IV-B.

## V. IMPLEMENTATION IN MININET EMULATOR

The proposed SMARTHO framework was implemented in the mininet emulation environment [41], where mininet-based hosts emulate the CU and DU. Mininet hosts are connected using P4 switches, developed using the P4 behaviour model (P4BM) with VSS model architecture, [36]. Raw data packets are created using the *scapy* tool [42], that sends a continuous sequence of raw data packets from one host to another. User and control traffic are also generated to simulate the mobile traffic and measure the HO performance. User traffic is represented using ICMP ping packets over a tag. The measurement of IP and tag based forwarding is done on user traffic. Control traffic is generated to simulate the HO procedure, packets are created with customized headers containing UE identification, over the tag. The tag of the control packet is also used as the identification for the HO message.

### A. Comparison of Tag and IP-based forwarding

In order to study tag- and IP-based forwarding, user traffic is sent among the hosts. P4 switches between these hosts parse the packets and either forward the packet or execute the SMARTHO process. This kind of tag-based



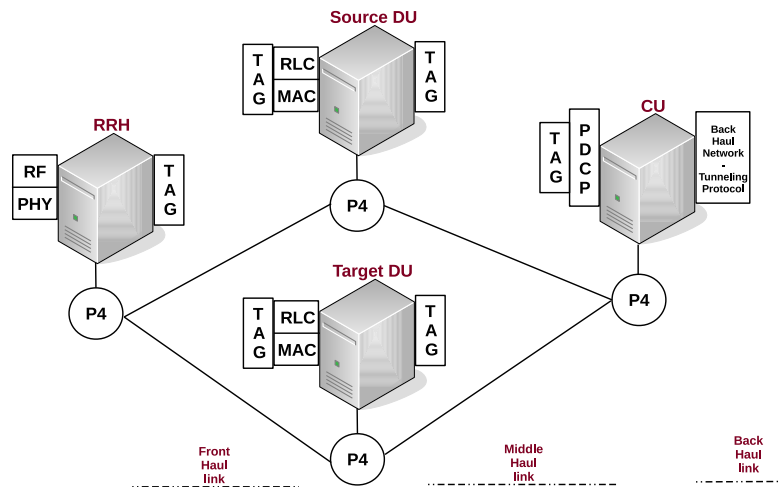

Figure 10: Network topology for Performance study of SMARTHO.

approach is already investigated by Fayazbakhsh et al. [43], where they used the tag for origin binding.

The comparison results are shown in Figure 9, with hosts separated by one, two or four intermediate switches. The metrics measured are the average response time and drop count of the packets. As seen, tag-based forwarding performs better than IP based forwarding. Consider Figure 9f and x-axis range of (20,60) parallel ping process. Here, it is clearly seen that tag-based forwarding is showing much lower packet drops when the number of hops increase.

In specialized environments such mobile networks, which are not connected to the Internet until the Packet Gateway, a tag-based forwarding approach is better. The tag-based identification of packets makes the P4 parser simple, allowing innovations in other aspects too, such as network slicing.

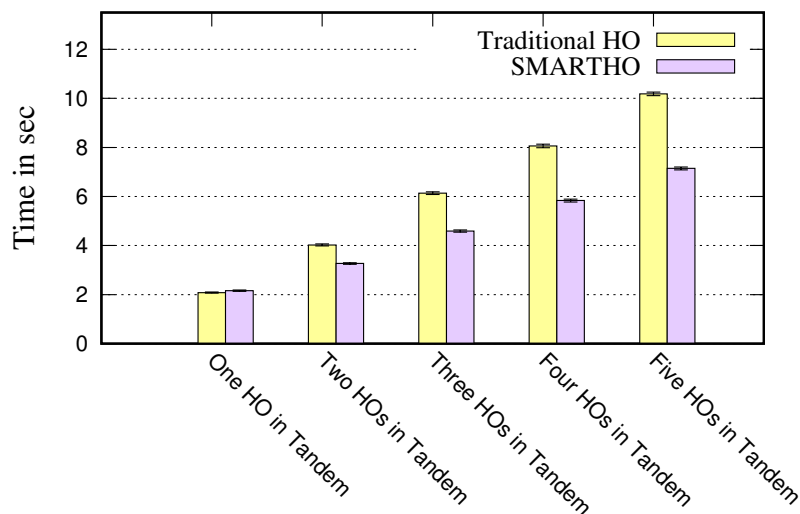

Figure 11: Performance of Intra-CU HOs in tandem.

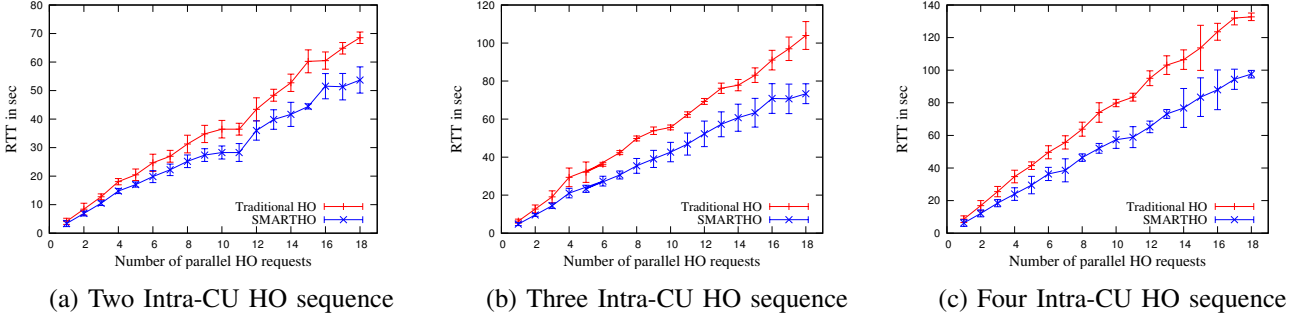

Figure 12: Performance comparison of traditional handover and SMARTHO in terms of Intra CU-HO time.

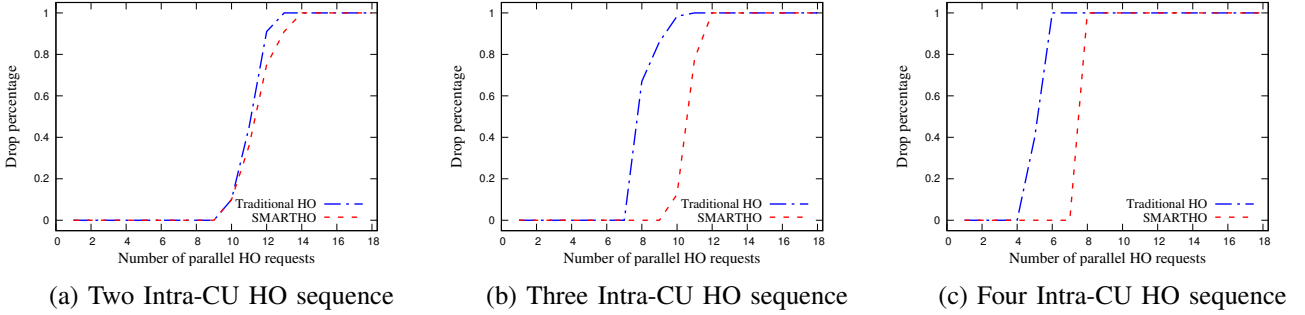

Figure 13: Analysis of handover failure percentages.

### B. Performance of SMARTHO handover

For this study, a mininet environment as shown in Figure 10 was created. We considered a tandem of Intra-CU handovers, sending user packets between the RRH and CU. User packets are generated as parallel ping process in RRH to simulate varying arrival rates. The inter-arrival time between Intra-CU HO was exponential. The HO procedure begins at the RRH by sending MR message to Source\_DU as shown in the simulation architecture. The HO time is measured from the moment RRH has sent the MR message to the Source\_DU, to the RRCCR message received at RRH indicating the HO is completed.

Figure 11 presents the performance for handover time on a single UE. The graph shows the total time spent for handover. As seen, the SMARTHO process performs better than the traditional HO process. There is no improvement of HO response time with single HO, this is because the SMARTHO process will perform the data setup in first HO and automates the subsequent HOs. Improvement of 18% for two tandem HOs and 25% for three tandem HOs is achieved and this improvement will increase as the tandem of HOs increases. This is because the overall time spent on HOs will proportionally decrease as the HO preparation phase is done in advance for all the subsequent HOs.

In the next study, we increased the intensity of HO requests, with multiple UEs requesting handovers. Figure 12 presents the response time. The results show that the SMARTHO process performs better than the traditional HO process, with higher improvements with increase in the number of transmit nodes.

Figure 13 presents the drop percentage of the HOs, where a handover is considered dropped when the response exceeds a threshold. It is observed that the proposed SMARTHO process is better when the number of intermediate nodes is higher.

## VI. XILINX NETFPGA BASED PROTOTYPE TESTBED

This section presents the details of the proof-of-concept prototype implementation of the proposed SMARTHO architecture using Xilinx NetFPGAs. The implementation details of the testbed, its architecture, and evaluation results, challenges faced in the development and the performance results of the testbed is also discussed.

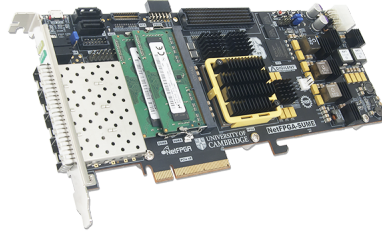

(a) NetFPGA SUME Board

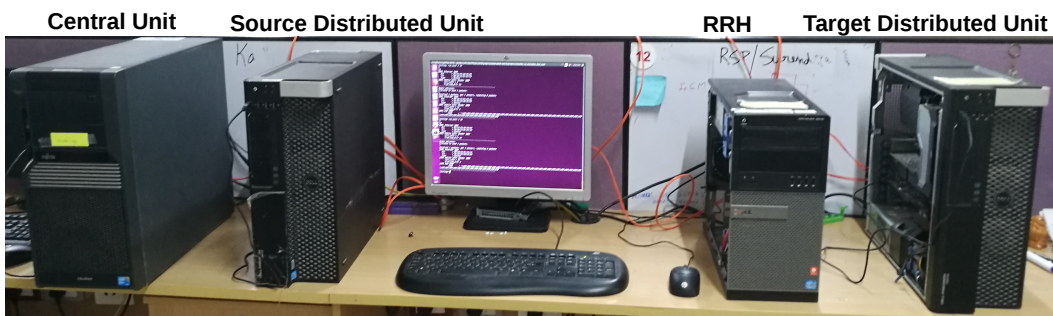

(b) Overall Prototype View



(c) Ports nf1 and nf2.

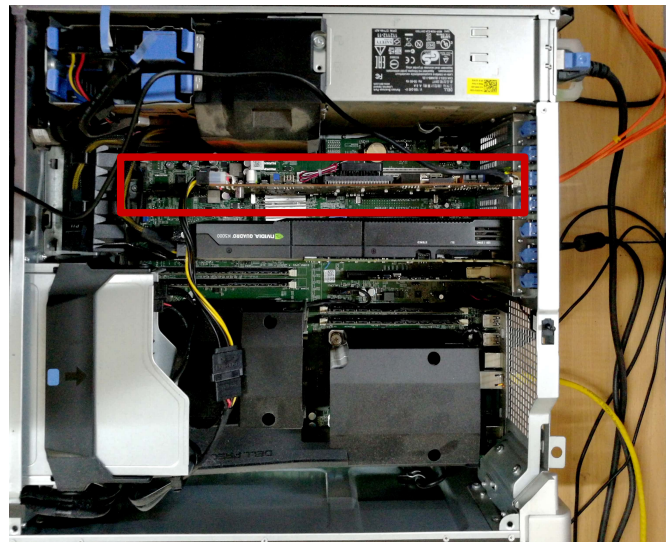

(d) NetFPGA SUME with PCIe connection.

Figure 14: Testbed setup for evaluating SMARTHO performance.

### A. Xilinx NetFPGA-SUME based prototype

Xilinx NetFPGA-SUME boards [44] were used as P4 switches for the testbed implementation. The NetFPGA-SUME boards (Figure 14a) enable researchers to prototype high-performance applications in hardware. We used

Xilinx SDNet toolchain [9], which simplifies the design of packet processing data planes that target FPGA hardware. The overall prototype system is shown in Figure 14b.

Four hosts are needed to emulate the behavior of Intra\_CU\_HO, shown earlier in Figure 10. The testbed set-up has three Intel-Xeon, 2.6 GHz i7 core CPU with 64 GB RAM for Source\_DU, Target\_DU, and CU. For RRH we used Intel Core i7, 32GB RAM. Systems are integrated with 10G Ethernet and NetFPGA-SUME switch, as shown in Figure 14b. SFP+ fiber-optic LC connector ports are fixed to NetFPGA-SUME and 10G Ethernet boards, and boards are connected with LC 50/125 optical fibers as shown in Figure 14c.

The NetFPGA-SUME board is installed in the host PCI-e slot, as shown in Figure 14d. NetFPGA\_Sume boards have four SFP+ 10Gbps ports, Xilinx refers to these interfaces as nf0, nf1, nf2, and nf3 where nf0 is the port closest to the link lights on the board. Loading driver modules (summe\_riffa), the ports on NetFPGA-SUME is recognized, as shown in Figure 15. These network interfaces are the means by which the host machine can communicate with the dataplane in the FPGA.

For traffic generation, a 10Gbps Ethernet card is used at the RRH. The systems are interconnected using nf1 and nf2 ports. Listed below are the port connections for the testbed.

- nf1 port of RRH is connected to nf1 port of Source\_DU
- nf2 port of Source\_DU connected to nf1 port of Target\_DU
- nf2 port of Target\_DU is connected to nf1 port of CU

Overall, three optical LC 50/125 optical fibres and six SFP+ fiber-optic LC connector ports are used.

### B. Working model

For simulating mobile traffic, we used the Scapy tool [42] at the RRH. The Scapy tool generates raw data packets that mimic the control messages for HO. The Scapy programs are executed at RRH and custom packets are created to emulate the control messages of Intra\_CU\_HO. The format of the header is shown in Procedure 6. These custom packets defined in Scapy were used as mobile HO control messages. By invoking Smartho(2,4) a packet is created with control\_information as 2 and forwarding\_tag as 4. The forwarding\_tag field is used to set the destination port, control\_information will represent a HO message as shown in Figure 16, i.e., Smartho(1,4) represent the measurement report, Smartho(2,4) represents the uplink RRC measurement message, and so on.

---

#### Procedure 6 smartho\_header.py

---

```
class Smartho(Packet)
    name = "Smartho",
    fields_desc = [
        IntField("ctrl_info",1),
        IntField("frwd_tag_prt",4),
    ]
    def mysummary(self):
        return self.sprintf("ctrl_info=%ctrl_info% frwd_tag_prt=%frwd_tag_prt%")
    bind_layers(Ether, Calc, type=SMARTHO_TYPE)
    bind_layers(Smartho, Raw)
```

---

The Xilinx SDNet tool provides the metadata list to configure the destination port and to know the source port. There is also one bit for each of the interfaces (nf0, nf1, nf2, and nf3) in the src\_port and dst\_port fields (bits 1, 3, 5, and 7). So for example, if the data-plane wants to send a packet up to the host and have it arrive on the nf0 Linux network interface then it must set bit 1 of the dst\_port field (e.g., dst\_port = 0b00000010). The destination

```

root@phani-Precision-T5610: ~/projects/P4-NetFPGA/contrib-projects/sume-sdnet-switch/projects/smartho_target_du/simple_sume_switch/bitfiles

lxcbr0    Link encap:Ethernet  HWaddr 92:6c:d9:bc:2d:60
          inet addr:10.0.3.1  Bcast:10.0.3.255  Mask:255.255.255.0
          UP BROADCAST RUNNING MULTICAST  MTU:1500  Metric:1
          RX packets:0 errors:0 dropped:0 overruns:0 frame:0
          TX packets:6851 errors:0 dropped:0 overruns:0 carrier:0
          collisions:0 txqueuelen:1000
          RX bytes:0 (0.0 B)  TX bytes:738742 (738.7 KB)

nf0       Link encap:Ethernet  HWaddr 02:53:55:4d:45:00
          inet6 addr: fe80::53:55ff:fe4d:4500/64 Scope:Link
          UP BROADCAST RUNNING MULTICAST  MTU:1500  Metric:1
          RX packets:0 errors:0 dropped:0 overruns:0 frame:0
          TX packets:9 errors:0 dropped:0 overruns:0 carrier:0
          collisions:0 txqueuelen:1000
          RX bytes:0 (0.0 B)  TX bytes:1262 (1.2 KB)

nf1       Link encap:Ethernet  HWaddr 02:53:55:4d:45:01
          inet6 addr: fe80::53:55ff:fe4d:4501/64 Scope:Link
          UP BROADCAST RUNNING MULTICAST  MTU:1500  Metric:1
          RX packets:0 errors:0 dropped:0 overruns:0 frame:0
          TX packets:8 errors:0 dropped:1 overruns:0 carrier:0
          collisions:0 txqueuelen:1000
          RX bytes:0 (0.0 B)  TX bytes:920 (920.0 B)

nf2       Link encap:Ethernet  HWaddr 02:53:55:4d:45:02
          inet6 addr: fe80::53:55ff:fe4d:4502/64 Scope:Link
          UP BROADCAST RUNNING MULTICAST  MTU:1500  Metric:1
          RX packets:0 errors:0 dropped:0 overruns:0 frame:0
          TX packets:10 errors:0 dropped:0 overruns:0 carrier:0
          collisions:0 txqueuelen:1000
          RX bytes:0 (0.0 B)  TX bytes:1604 (1.6 KB)

nf3       Link encap:Ethernet  HWaddr 02:53:55:4d:45:03
          inet6 addr: fe80::53:55ff:fe4d:4503/64 Scope:Link
          UP BROADCAST RUNNING MULTICAST  MTU:1500  Metric:1
          RX packets:0 errors:0 dropped:0 overruns:0 frame:0
          TX packets:9 errors:0 dropped:0 overruns:0 carrier:0
          collisions:0 txqueuelen:1000
          RX bytes:0 (0.0 B)  TX bytes:1262 (1.2 KB)

root@phani-Precision-T5610:~/projects/P4-NetFPGA/contrib-projects/sume-sdnet-switch/projects/smartho_target_du/simple_sume_switch/bitfiles# █

```

Figure 15: Four ports of NetFPGA after installation of PCI-e drivers.

port can be set by the P4 program with variable `sume_metadata.dst_port`. When `sume_metadata.dst_port` is set as one the packets are egress to `nf0` port, for SMARTHO, all the systems are connected using `nf1` and `nf2` ports alone i.e., `sume_metadata.dst_port` should be either set to 4 or 16.

There are three operations performed by the NetFPGA-SUME switches in SMARTHO testbed implementation:

**Change of control information:** Control message received at the host (discussed in Section VI-B), is changed as per the next sequence message, as shown in Figure 16 & Figure 19.

**Setting the `sume_metadata.dst_port`:** Extract the value of `forwarding_tag_port` and set this to `sume_metadata.dst_port`.

This would set the egress port for the control message.

**Change the `forwarding_tag_port`:** We used `look_up_table` to change the `forwarding_tag_port`. The `look_up_table` is statically set and does an exact match with control message and `src_port` information put together. Since the architecture setup is static, the `look_up_table` is loaded at compile time. Based on the `control_message`

and `sume_metadata.src_port` the forwarding port is decided. This forwarding information will be extracted and updated to the header `forwarding_tag_port`. The `forwarding_tag_port` will then be used to set the egress port by the next host.

1) *Traditional HO process*: For traditional HO, the sequence of messages that is exchanged in the testbed is shown in Figure 16. This emulation represents the complete traditional HO procedure. The custom function `Smartho(x,y)` would add a custom header over Ethernet (Procedure 6 shows the high-level packet contents). The initial control message (Measurement report) `Smartho(1,4)` is sent from RRH, to Source\_DU to trigger the HO process.

In the Figure 16, the exchange of sequence of HO messages is shown. In the preparation phase the Measurement Report (MR) message from the RRU would be transmitted to the CU. CU would select the Target\_DU for the HO by sending HO request (UE Context Request - `Smartho(3,4)`). In reality, the UE Context Request should contain Target-DU-ID, UE context information & UE History Information. In testbed we emulated the process creating a custom header with context information as three. Upon Target\_DU receiving the HO request it begins handover preparation to ensure seamless service provision for the UE. The Target\_DU would respond with setting up Access Stratum (AS) security keys, uplink bearers connecting to the backhaul, reserve Radio Resource Control (RRC) resources to be used by the mobile device over the radio link and allocates Cell-Radio Network Temporary Identifier. This was not implemented in Target\_DU hosts. To emulate this, we add a 2 ms delay after sending a `Smartho(3,4)` message. HO execution and completion phase are emulated as data exchange as shown in Figure 16 between the hosts.

For simulation of more than one tandem of HOs we sent `Smartho(1,4)` multiple times from RRH, i.e., after the first HO is completed, RRH would resend `Smartho(1,4)` to Source\_DU to simulate the subsequent HO. Figure 17 & Figure 18 shows the screenshot of traditional HO with single and two HOs in tandem.

2) *SMARTHO process*: For a single HO, the SMARTHO process does not show any difference from the traditional HO approach. This was discussed in Section IV.

The control messaging for SMARTHO process with the tandem of two HOs is shown in Figure 19. Here, after first HO is completed, the subsequent HOs are performed from the HO execution phase. In the testbed, we did not implement the controller part, i.e., after the first HO messages are executed, the subsequent HOs will send message `Smartho(6,4)` as a reply for message `Smartho(1,4)`. Figure 20 shows the screenshot of SMARTHO for two-HOs in tandem; similar screenshot is shown in Figure 21 to demonstrate SMARTHO for three-HOs in tandem.

Figure 22 presents the performance of SMARTHO and the Traditional HO approaches, obtained using the prototype. The experiments are performed on a single UE. In future work, we can increase the intensity of HOs by sending HO requesting messages in parallel, from multiple UEs, to emulate the behavior of LTE-R nodes. We see that as the number of HOs increases, the total time taking to complete all the HOs is also increased. It is seen that handover in both approaches takes around 50 milliseconds. Since we measure HO per UE, the difference is not much, and also the ‘Time per HO’ is almost the same in both Traditional and SMARTHO. This is not exactly what was expected; however, the knowledge and expertise gained in implementing this in the P4 environment is significant. In future work, we will continue to investigate the performance bottlenecks and identify coding changes to improve the overall delay. These experiments can also be extended to multiple UEs in future work.

Using the above testbed experiments, we have demonstrated the feasibility of implementation of SMARTHO in a P4-based programmable dataplane switch.

## VII. CONCLUSIONS

In this report, we have presented the use P4-based dataplane switches to improve handover efficiency, in a wireless network. The proposed approach has been studied using a Mininet implementation. The experimental results show that the proposed SMARTHO approach does have benefits over the traditional handover process. The handover mechanism was implemented on a Xilinx NetFPGA based P4 switch and the system's working was demonstrated.

As part of future work, the Tag-based approach can be considered for supporting network slicing and virtualization techniques. Further detailed experiments with multiple UEs and varying loads can also be conducted.

*Acknowledgments:* We thank Mr. Karthik Karra, Dr. Manikantan Srinivasan and Dr. C.S. Ganesh (IIT Madras) for sharing their insights and feedback. This work was supported by an IIT Madras IRDA-2017 award and by a DST-FIST grant (SR/FST/ETI-423/2016) from Government of India (2017–2022).



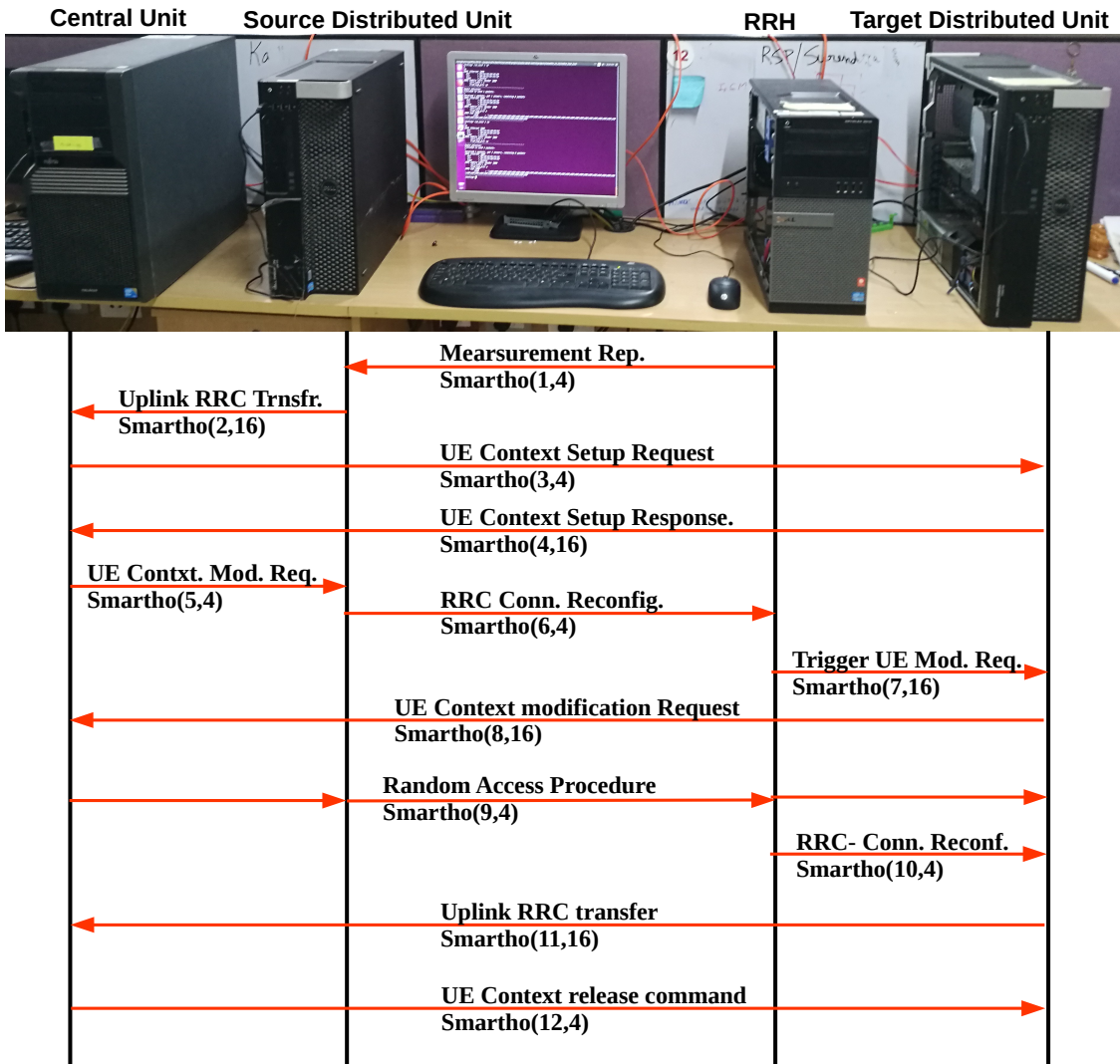

Figure 16: Control message simulating Traditional HO approach on testbed.







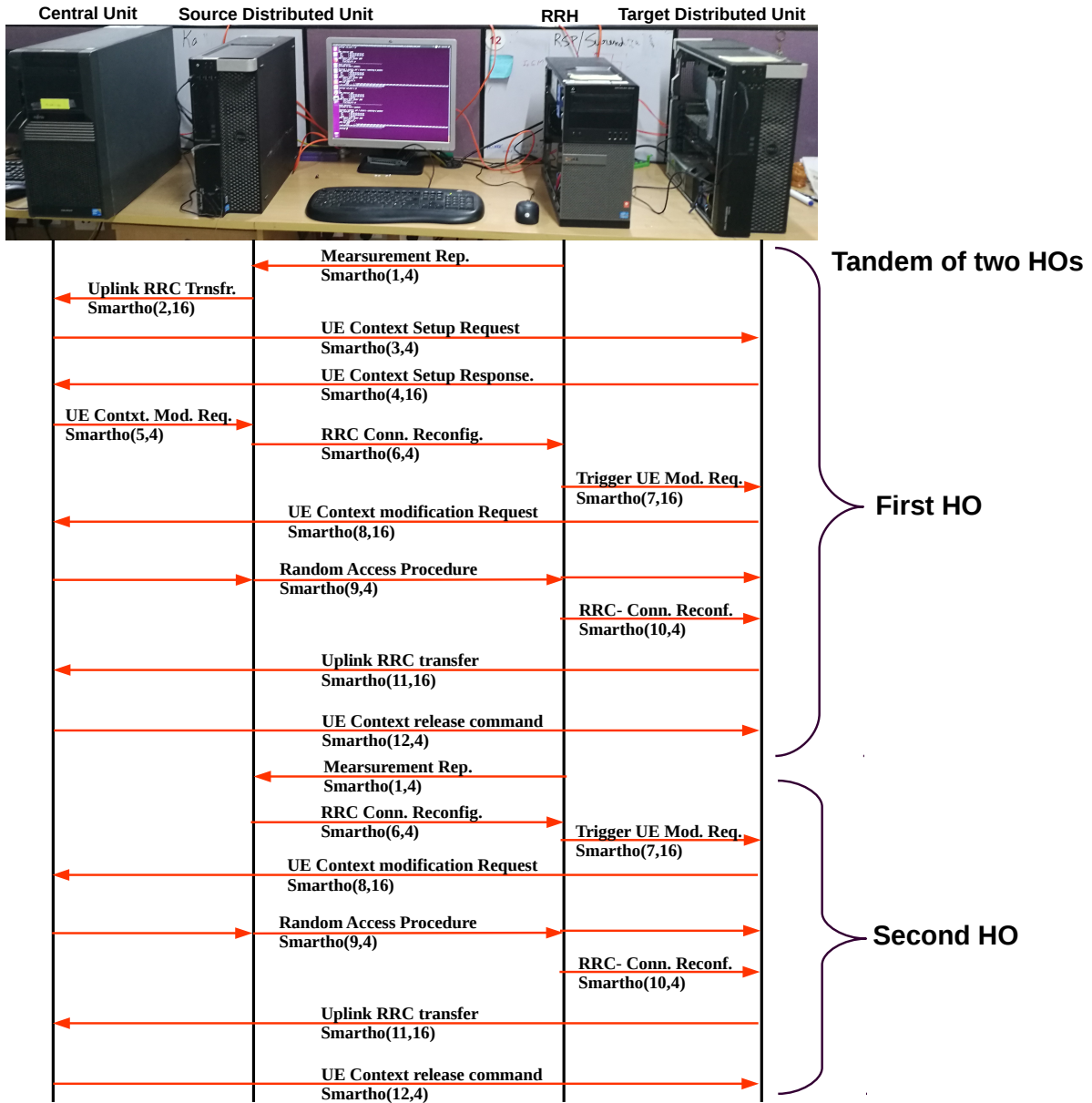
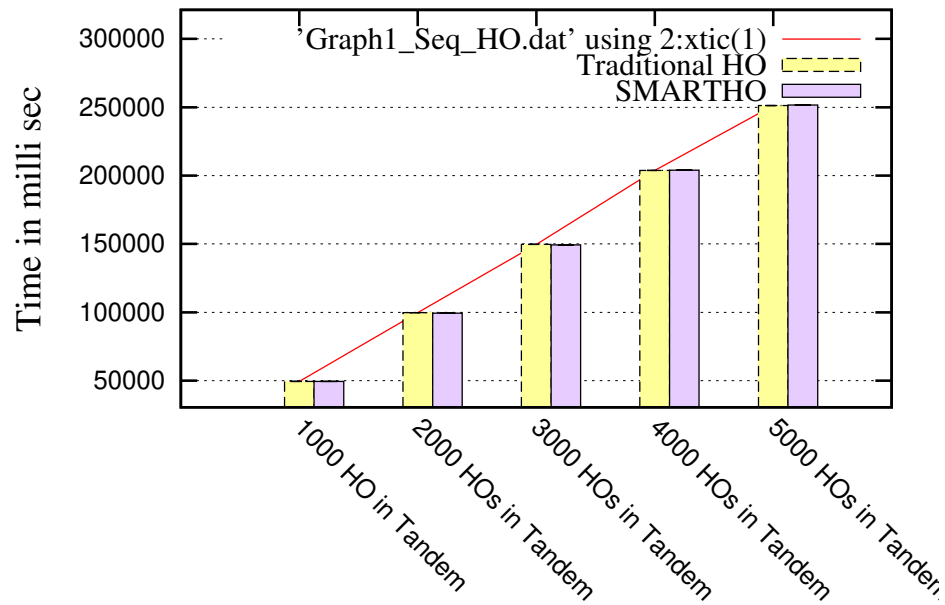

Figure 19: Control message simulating SMARTHO HO behaviour on testbed.







(a) Performance of HO in SMARTHO and Traditional approach.

Number of HOs in Tandem	Total HO Time (ms)		Time per HO (ms)	
	Traditional Approach	SMARTHO	Traditional Approach	SMARTHO
1,000	49,556	49,393	49.556	49.393
2,000	99,824	99,356	49.912	49.678
3,000	149,693	149,305	49.897	49.768
4,000	213,782	203,911	53.445	50.977
5,000	251,660	251,264	50.332	50.252

(b) Performance results varying the total number of handovers, executed in tandem.

Figure 22: Performance results from the prototype implementation.

## REFERENCES

- [1] P. Palagummi and K. M. Sivalingam, "SMARTHO: A network initiated handover in NG-RAN using p4-based switches," in *Proc. of International Conference on Network and Service Management (CNSM)*, Rome, Italy, Nov. 2018, pp. 338–342.
- [2] P. Palagummi, "Network-Initiated Handover Mechanism for 5G Networks using P4-based Programmable Data Plane Switches," Master's thesis, Indian Institute of Technology, Madras, 2019.
- [3] 3GPP, "NG-RAN;Architecture description," 3rd Generation Partnership Project (3GPP), Technical Specification (TS) 38.401, 06 2018, version 15.1.0.
- [4] I. Giannoulakis, E. Kafetzakis, G. Xylouris, G. Gardikis, and A. Kourtis, "On the applications of efficient NFV management towards 5G networking," in *Proc. of Intl. Conf. on 5G for Ubiquitous Connectivity (5GU)*, 2014, pp. 1–5.
- [5] H. Hawilo, A. Shami, M. Mirahmadi, and R. Asal, "NFV: state of the art, challenges, and implementation in next generation mobile networks (vEPC)," *IEEE Network*, vol. 28, no. 6, pp. 18–26, 2014.
- [6] S. Abdelwahab, B. Hamdaoui, M. Guizani, and T. Znati, "Network Function Virtualization in 5G," *IEEE Communications Magazine*, vol. 54, no. 4, pp. 84–91, 2016.
- [7] J. Costa-Requena, J. L. Santos, V. F. Guasch, K. Ahokas, G. Premsankar, S. Luukkainen, O. L. Pérez, M. U. Itzazelaia, I. Ahmad, M. Liyanage *et al.*, "SDN and NFV integration in generalized mobile network architecture," in *Proc. European Conference on Networks and Communications (EuCNC)*, 2015, pp. 154–158.
- [8] P. Bosshart, D. Daly, G. Gibb, M. Izzard, N. McKeown, J. Rexford, C. Schlesinger, D. Talayco, A. Vahdat, G. Varghese *et al.*, "P4: Programming protocol-independent packet processors," *ACM SIGCOMM Computer Communication Review*, vol. 44, no. 3, pp. 87–95, 2014.
- [9] "P4 to NetFPGA workflow," <https://github.com/NetFPGA/P4-NetFPGA-public/wiki/Workflow-Overview>, Nov. 2019.
- [10] "P4 Language Consortium," <https://p4.org>, Jul. 2020.
- [11] 3GPP, "Feasibility Study on New Services and Markets Technology Enablers," 3rd Generation Partnership Project (3GPP), Technical Specification (TS) 22.891, 09 2016, version 14.2.0.
- [12] A. Checko, H. L. Christiansen, Y. Yan, L. Scolari, G. Kardaras, M. S. Berger, and L. Dittmann, "Cloud RAN for mobile networks: A technology overview," *IEEE Communications Surveys & Tutorials*, vol. 17, no. 1, pp. 405–426, 2015.
- [13] K. Sundaresan, M. Y. Arslan, S. Singh, S. Rangarajan, and S. V. Krishnamurthy, "Fluidnet: A flexible cloud-based radio access network for small cells," *IEEE/ACM Transactions on Networking*, vol. 24, no. 2, pp. 915–928, 2016.
- [14] A. S. Thyagaturu, Z. Alharbi, and M. Reisslein, "R-FFT: Function split at IFFT/FFT in unified LTE CRAN and cable access network," *IEEE Transactions on Broadcasting*, 2018.
- [15] X. Wang, A. Alabbasi, and C. Cavdar, "Interplay of energy and bandwidth consumption in CRAN with optimal function split," in *Proc. of IEEE ICC*, 2017, pp. 1–6.
- [16] 3GPP, "Study on New Radio Access Technology; Radio Access Architecture and Interfaces," 3rd Generation Partnership Project (3GPP), Technical Report (TR) 38.801, 03 2017, version 14.0.0.
- [17] —, "Summary of RAN3 status on CU-DU split Option 2 and Option 3, and questions/issues for RAN2," 3rd Generation Partnership Project (3GPP), Technical document (Tdoc) R2-1700637, 01 2017, r2-1700637.
- [18] L. Tian, J. Li, Y. Huang, J. Shi, and J. Zhou, "Seamless dual-link handover scheme in broadband wireless communication systems for high-speed rail," *IEEE Journal on Selected Areas in Communications*, vol. 30, no. 4, pp. 708–718, 2012.
- [19] T. Shuo, K. Zhao, and H. Wu, "Wireless communication for heavy haul railway tunnels based on distributed antenna systems," in *Proc. IEEE VTC (Spring)*, 2016, pp. 1–5.
- [20] J.-T. Park and S.-M. Chun, "Fast local mobility management with multiple tunnel support in heterogeneous wireless networks," in *Proc. ACM international workshop on Mobility management and wireless access*, 2010, pp. 45–51.
- [21] H. Li and D. Hu, "Mobility prediction based seamless RAN-cache handover in HetNet," in *Proc. IEEE WCNC*, 2016, pp. 1–7.
- [22] A. A. Mansour, N. Enneya, and M. Ouadou, "A Seamless Handover Based MIH-Assisted PMIPv6 in Heterogeneous Network (LTE-WIFI)," in *Proc. Intl. Conf. on Big Data, Cloud and Applications*, 2017, p. 67.
- [23] H. Mzoughi, F. Zarai, M. S. Obaidat, and L. Kamoun, "3GPP LTE-advanced congestion control based on MIH protocol," *IEEE Systems Journal*, 2015.
- [24] R. Merz, D. Wenger, D. Scanferla, and S. Mauron, "Performance of LTE in a high-velocity environment: A measurement study," in *Proc. Workshop on All things cellular: operations, applications, & challenges*, 2014, pp. 47–52.
- [25] M. Mehta, N. Akhtar, and A. Karandikar, "Impact of handover parameters on mobility performance in LTE HetNets," in *Proc. NCC*, 2015, pp. 1–6.
- [26] K. Kitagawa, T. Komine, T. Yamamoto, and S. Konishi, "A handover optimization algorithm with mobility robustness for LTE systems," in *Personal Indoor and Mobile Radio Communications (PIMRC)*. IEEE, 2011.

- [27] W. Luo, X. Fang, M. Cheng, and X. Zhou, "An optimized handover trigger scheme in LTE systems for high-speed railway," in *Proc. Intl. Workshop on Signal Design and its Applications in Communications (IWSDA)*, 2011, pp. 193–196.
- [28] N. Zheng and J. Wigard, "On the performance of integrator handover algorithm in LTE networks," in *Proc. IEEE VTC (Fall)*, 2008, pp. 1–5.
- [29] M. Anas, F. D. Calabrese, P. E. Mogensen, C. Rosa, and K. I. Pedersen, "Performance evaluation of received signal strength based hard handover for UTRAN LTE," in *Proc. IEEE VTC*, 2007, pp. 1046–1050.
- [30] C. Martinez, R. Ferro, and W. Ruiz, "Next Generation Networks under the SDN and OpenFlow protocol architecture," in *Proc. of Workshop on Engineering Applications-International Congress on Engineering (WEA)*, 2015, pp. 1–7.
- [31] B. Pfaff, J. Pettit, T. Koponen, E. J. Jackson, A. Zhou, J. Rajahalme, J. Gross, A. Wang, J. Stringer, and P. Shelar, "The Design and Implementation of Open vSwitch," in *NSDI*, 2015, pp. 117–130.
- [32] S. Hommes, P. Valtchev, K. Blaiech, S. Hamadi, O. Cherkaoui *et al.*, "Optimising packet forwarding in multi-tenant networks using rule compilation," in *Proc. IEEE Intl. Symposium on Network Computing and Applications (NCA)*, 2017, pp. 1–9.
- [33] R. MacDavid, R. Birkner, O. Rottenstreich, A. Gupta, N. Feamster, and J. Rexford, "Concise encoding of flow attributes in SDN switches," in *Proc. ACM SOSR*, 2017, pp. 48–60.
- [34] S. Chourasia and K. M. Sivalingam, "SDN based Evolved Packet Core architecture for efficient user mobility support," in *Proc. IEEE NetSoft*, 2015, pp. 1–5.
- [35] P. Benáček, V. Puš, J. Kořenek, and M. Kekely, "Line rate programmable packet processing in 100Gb networks," in *Proc. Intl. Conf. on Field Programmable Logic and Applications (FPL)*, 2017, pp. 1–1.
- [36] P4 language Consortium, "P4 behaviour model," <https://github.com/p4lang/behavioral-model>, 2013.
- [37] M. Shahbaz, S. Choi, B. Pfaff, C. Kim, N. Feamster, N. McKeown, and J. Rexford, "Pisces: A programmable, protocol-independent software switch," in *Proceedings of the ACM SIGCOMM Conference*, 2016, pp. 525–538.
- [38] *P4 16 Portable Switch Architecture (PSA)*, The P4 Language Consortium, 3 2018, ver. 1.0.0.
- [39] *P4 16 Language Specification*, The P4 Language Consortium, 5 2017, ver. 1.0.0.
- [40] K. G. Ralf Kreher, *LTE SIGNALING, TROUBLESHOOTING AND PERFORMANCE MEASUREMENT*. John Wiley & Sons, 2016, ch. 2.3, pp. 166–169.
- [41] M. Team, "Mininet," [mininet.org](http://mininet.org), 2020.
- [42] SCAPY, "SCAPY - A Python packet crafting tool," <https://github.com/secdev/scapy>, 2020.
- [43] S. K. Fayazbakhsh, L. Chiang, V. Sekar, M. Yu, and J. C. Mogul, "Enforcing network-wide policies in the presence of dynamic middlebox actions using flowtags," in *NSDI*, vol. 14, 2014, pp. 533–546.
- [44] N. Zilberman, Y. Audzevich, G. A. Covington, and A. W. Moore, "NetFPGA SUME: Toward 100 Gbps as research commodity," *IEEE Micro*, vol. 34, no. 5, pp. 32–41, 2014.

PLACE  
PHOTO  
HERE

**Phanindra Palagummi** is currently with Microsoft, Hyderabad, India. He received the M.S. (by Research) degree in Computer Science and Engineering from Indian Institute of Technology Madras, Chennai, INDIA in 2019; and the B.Tech. degree in Computer Science and Engineering from Nova College of Engineering and Technology, affiliated to JNTU, in 2010. His research interests include computer networking.



PLACE  
PHOTO  
HERE

**Krishna M. Sivalingam** is an Institute Chair Professor in the Department of CSE, IIT Madras, Chennai, INDIA, where he was also Head of the Department from 2016 till 2019. Previously, he was a Professor in the Dept. of CSEE at University of Maryland, Baltimore County, Maryland, USA from 2002 until 2007; with the School of EECS at Washington State University, Pullman, USA from 1997 until 2002; and with the University of North Carolina Greensboro, USA from 1994 until 1997. He has also conducted research at Lucent Technologies' Bell Labs in Murray Hill, NJ, and at AT&T Labs in Whippany, NJ. He received his Ph.D. and M.S. degrees in Computer Science from State University of New York at Buffalo in 1994 and 1990 respectively; and his B.E. degree in Computer Science and Engineering in 1988 from Anna University's College of Engineering Guindy,

Chennai (Madras), India. While at SUNY Buffalo, he was a Presidential Fellow from 1988 to 1991.

His research interests include wireless networks, optical wavelength division multiplexed networks, and performance evaluation. His work has been supported by several sources including AFOSR, DST India, DOT India, IBM, NSF, Cisco, Intel, Tata Power Company and Laboratory for Telecommunication Sciences. He holds three patents in wireless networks and has published several research articles including more than seventy journal publications. He has co-edited a book on Next Generation Internet Technologies in 2010; on Wireless Sensor Networks in 2004; on optical WDM networks in 2000 and 2004. He is serving or has served as a member of the Editorial Board for journals including IEEE Networking Letters, ACM Wireless Networks Journal, IEEE Transactions on Mobile Computing, and Elsevier Optical Switching and Networking Journal. He has served as Editor-in-Chief of Springer Photonic Network Communications Journal and EAI Endorsed Transactions on Future Internet.

He is a Fellow of IEEE, a Fellow of INAE and an ACM Distinguished Scientist.