

Logical Separability of Labeled Data Examples under Ontologies

Jean Christoph Jung^a, Carsten Lutz^b, Hadrien Pulcini^c, Frank Wolter^c

^a*Institute of Computer Science, University of Hildesheim, Germany*

^b*Institute for Computer Science, Leipzig University, Germany*

^c*Department of Computer Science, University of Liverpool, UK*

Abstract

Finding a logical formula that separates positive and negative examples given in the form of labeled data items is fundamental in applications such as concept learning, reverse engineering of database queries, generating referring expressions, and entity comparison in knowledge graphs. In this paper, we investigate the existence of a separating formula for data in the presence of an ontology. Both for the ontology language and the separation language, we concentrate on first-order logic and the following important fragments thereof: the description logic \mathcal{ALCI} , the guarded fragment, the two-variable fragment, and the guarded negation fragment. For separation, we also consider (unions of) conjunctive queries. We consider several forms of separability that differ in the treatment of negative examples and in whether or not they admit the use of additional helper symbols to achieve separation. Our main results are model-theoretic characterizations of (all variants of) separability, the comparison of the separating power of different languages, and the investigation of the computational complexity of deciding separability.

Keywords: Logical Separability, Decidable Fragments of First-Order Logic, Description Logic, Learning from Examples, Complexity, Ontologies

1. Introduction

There are many scenarios in which the aim is to find some kind of logical expression that separates positive from negative examples given in the form of labeled data items within a data set. For instance, in *entity comparison* the positive and negative examples are single entities within a knowledge graph and one aims to explore the relationship between them by searching for relevant logical features that distinguish them from each other. In another application scenario, the positive and negative examples have been derived using a classifier whose behaviour one aims to understand and explain by means of a logical expression that applies to the positive examples, but not to the negative ones. Even more ambitiously, one might be in a supervised learning scenario and aim at a logical expression that generalizes the positive examples but does not apply to any negative example and that can potentially serve as a classifier for future prediction tasks. Indeed, in *concept learning in description logic*, the aim is to automatically construct a concept description from examples that can then be used for various purposes including classifier explanation, prediction, and as a building block in ontology engineering. In yet another application area called *reverse engineering of database queries* or *query by example*, the examples are answers and non-answers to a query that a user who is not familiar with the underpinning query language aims to construct. While the user is unable to construct the query, they may be able to provide such examples, and a separating query is then a reconstruction, or at least approximation, of the original query. Finally, in *generating referring expressions* in computational linguistics and data management, the aim is to find a meaningful logical description of a real world object whose name is meaningless to the typical user. In this case the positive examples consist of a single individual and the negative examples of all remaining individuals in the domain. In all these settings it is often the case that, in addition to the data set, some background knowledge in the

Email addresses: jungj@uni-hildesheim.de (Jean Christoph Jung), clu@informatik.uni-leipzig.de (Carsten Lutz), h.pulcini@liverpool.ac.uk (Hadrien Pulcini), wolter@liverpool.ac.uk (Frank Wolter)

form of an ontology is given. We return to these application scenarios and research areas below, discuss them in more detail, and also provide links to related work.

In this article, we investigate the separation of positive and negative examples in the presence of an ontology. As usual when data and ontologies are combined, we assume that the data is incomplete and adopt an open world semantics. More precisely, we assume that a labeled knowledge base (KB) (\mathcal{K}, P, N) is given with $\mathcal{K} = (O, \mathcal{D})$, where O is an ontology defined in a fragment of first-order logic (FO) or a description logic, \mathcal{D} is a set of facts, P is a set of positive examples, and N is a set of negative examples. All examples are tuples of constants from \mathcal{D} of the same length. As usual, we write $\mathcal{K} \models \varphi(\vec{a})$ for a tuple \vec{a} in \mathcal{D} and FO formula φ in case that $\varphi(\vec{a})$ is true in every model of $O \cup \mathcal{D}$.

Due to the open world semantics, different choices are possible regarding the definition of a formula φ that separates (\mathcal{K}, P, N) . While it is uncontroversial to demand that $\mathcal{K} \models \varphi(\vec{a})$ for all $\vec{a} \in P$, for negative examples $\vec{b} \in N$ it makes sense to demand that $\mathcal{K} \not\models \varphi(\vec{b})$, but also that $\mathcal{K} \models \neg\varphi(\vec{b})$. When φ is formulated in logic \mathcal{L}_S , we refer to the former as *weak \mathcal{L}_S -separability* and to the latter because *strong \mathcal{L}_S -separability*. The following example illustrates the difference between the two choices.

Example 1. Consider the KB $\mathcal{K} = (O, \mathcal{D})$ with O empty and \mathcal{D} stating that c_1, c_2 are football clubs competing in the Bundesliga and that c_3, c_4 compete in the Premier League:

$$\mathcal{D} = \{\text{compete_in}(c_1, b), \text{compete_in}(c_2, b), \text{compete_in}(c_3, p), \text{compete_in}(c_4, p), \\ \text{Bundesliga}(b), \text{PremierLeague}(p), \text{Footballclub}(c_1), \text{Footballclub}(c_2)\}$$

Let $P = \{c_1, c_2\}$ and $N = \{c_3, c_4\}$. Then $\text{Footballclub}(x)$ weakly separates P from N but it does not strongly separate P from N . Indeed, as we adopt an open world semantics, no formula in FO strongly separates P from N as \mathcal{K} does not contain any negative information. In this example, $\text{Footballclub}(x)$ is a rather misleading separator because clubs that compete in the PremierLeague are also football clubs and so it only weakly separates because the KB is incomplete. To exclude $\text{Footballclub}(x)$ as a weak separator, we add this information to the ontology, obtaining

$$O' = \{\forall x(\exists y(\text{compete_in}(x, y) \wedge \text{PremierLeague}(y)) \rightarrow \text{Footballclub}(x))\},$$

and consider the KB $\mathcal{K}' = (O', \mathcal{D})$. Then $\text{Footballclub}(x)$ no longer weakly separates P and N . In fact, weak separability is now only witnessed by more meaningful separators such as

$$\varphi(x) = \exists y(\text{compete_in}(x, y) \wedge \text{Bundesliga}(y)).$$

As \mathcal{K}' still lacks negative information, P and N are still not strongly separable in FO. They become strongly separable by $\varphi(x)$ after adding the disjointness axiom

$$\forall x((\exists y \text{compete_in}(x, y) \wedge \text{Bundesliga}(y)) \rightarrow \neg \exists y(\text{compete_in}(x, y) \wedge \text{Premierleague}(y)))$$

to O' . We next consider separability in FO of the singleton $P_1 = \{c_1\}$ from the remaining constants $N_1 = \{c_2, c_3, c_4, b, p\}$. As we know already how to separate c_1 from c_3 and c_4 , we can focus on b, p and c_2 . Weak separation from b and p is straightforward by taking $\exists y \text{compete_in}(x, y)$. To obtain strong separation one might add the disjointness axioms $\text{Bundesliga}(x) \rightarrow \neg \exists y \text{compete_in}(x, y)$ and $\text{Premierleague}(x) \rightarrow \neg \exists y \text{compete_in}(x, y)$. The constants c_1 and c_2 , however, are neither weakly nor strongly separable in any fragment of FO as one can easily see that swapping c_1 and c_2 does not change the KB (except for the naming of c_1 and c_2). Hence P_1 and N_1 are not weakly nor strongly separable in FO either. \blacktriangle

In this article we study both weak and strong separability in labeled KBs. Both notions depend on the languages used for separation and to formulate the ontology. Hence, we aim to investigate the role of ontologies and the impact of the ontology language, to compare the separating power of different separation languages and, finally, to determine the decidability and complexity of separability as a decision problem. Our main tool are model-theoretic characterizations of separability tailored towards the considered ontology and separation languages. Given two logical languages \mathcal{L} and \mathcal{L}_S , with $(\mathcal{L}, \mathcal{L}_S)$ -separability we mean \mathcal{L}_S -separability of labeled \mathcal{L} -knowledge bases.

FO is the most powerful language for formulating ontologies and separating examples that we consider in this article. This choice reflects the fact that the large majority of ontologies deployed in the real world are formulated

in (fragments of) FO and that fragments of FO also cover many natural languages for separation. While one cannot expect decidability results for full FO as the ontology language, it turns out that one can obtain very powerful characterization results for labeled KBs with unrestricted FO-ontologies that are useful also for many fragments of FO. In practice, most ontologies are formulated in description logics and the second main ontology and separation language that we consider is the expressive description logic \mathcal{ALCI} , a rather representative and frequently used description logic. Separation using \mathcal{ALCI} -concepts is of direct practical interest for concept learning in description logic, entity comparison, and generating referring expressions. We also discuss the behavior of a few other description logics and comment on interesting description logics left for future investigation. We further investigate in full detail two extensions of \mathcal{ALCI} : the guarded fragment, GF, and the two-variable fragment, FO^2 , of FO. Both languages are generally regarded as fundamental decidable fragments of FO that still enjoy many of the desirable properties of description logics, and their investigation has led to a better understanding of the reasons for their good computational behavior. We consider them here to gain a better understanding of the computational and semantic properties of separability in general, depending on the expressive power of the separation language. As separating formulas, we further consider conjunctive queries, CQs, defined as FO-formulas constructed from atoms using conjunction and existential quantification, and unions of conjunctive queries, UCQs, defined as disjunctions of CQs. Separation using CQs and UCQs is of direct interest for query by example, but also enables us to characterize separation in the languages discussed above. Finally, we formulate a few results about the guarded negation fragment of FO, GNFO, which is a more recent decidable fragment of FO containing both GF and UCQ that still enjoys many of the desirable properties of GF.

In connection with the application scenarios discussed at the beginning of the introduction, we define the following special cases of $(\mathcal{L}, \mathcal{L}_S)$ -separability:

- $(\mathcal{L}, \mathcal{L}_S)$ -*definability* is $(\mathcal{L}, \mathcal{L}_S)$ -separability for labeled KBs where P and N partition the example space; that is, inputs are labeled \mathcal{L} -KBs (\mathcal{K}, P, N) such that N is defined as the set of n -tuples in \mathcal{D} that are not in P , with n the length of example tuples.
- $(\mathcal{L}, \mathcal{L}_S)$ -*referring expression existence* is $(\mathcal{L}, \mathcal{L}_S)$ -definability for labeled KBs where P is a singleton set.
- $(\mathcal{L}, \mathcal{L}_S)$ -*entity distinguishability* is $(\mathcal{L}, \mathcal{L}_S)$ -separability for labeled KBs where P and N are both singleton sets.

We show that, with only very few exceptions, the special cases behave in exactly the same way as general separability and therefore mostly focus on separability in the remainder of the introduction. We start the discussion of our results with weak separability. Our first main result provides a characterization of weak (FO, FO) -separability in terms of homomorphisms. It implies that

(wA) weak $(\text{FO}, \mathcal{L}_S)$ -separability coincides for all FO-fragments \mathcal{L}_S situated between UCQ and FO.

Thus, somewhat surprisingly, UCQ, GNFO, and FO all have the same separating power. This result shows that separability under the open world semantics adopted in this article is significantly more cautious than separability under the closed world semantics, which is typically adopted in the database literature. Under the latter semantics, every database can be described in FO up to isomorphisms, hence separability using FO-formulas corresponds to “being non-isomorphic” and is clearly much more powerful than separability using UCQs. Our characterization also implies a close link between separability and the evaluation of rooted UCQs (unions of CQs in which every variable is reachable from an answer variable) on FO-KBs. In fact, we show that

(wB) there are mutual polynomial time Turing reductions between weak $(\mathcal{L}, \mathcal{L}_S)$ -separability and the complement of rooted UCQ-evaluation on \mathcal{L} -KBs for all FO-fragments \mathcal{L}_S between UCQ and FO and all FO-fragments \mathcal{L} .

For the special cases of referring expression existence and entity distinguishability in which P is a singleton set, UCQ can be replaced by CQ. In particular, in the mutual reductions, rooted UCQ-evaluation can be replaced by rooted CQ-evaluation. As a first application of (wB), it follows from the fact that rooted UCQ-evaluation on GNFO-KBs is 2ExpTime -complete that $(\text{GNFO}, \text{GNFO})$ -separability and, equivalently, $(\text{GNFO}, \text{UCQ})$ -separability, are decidable and 2ExpTime -complete in combined complexity, where the KB $\mathcal{K} = (\mathcal{O}, \mathcal{D})$ and the sets P and N of examples are regarded as the input.

We then proceed to study weak $(\mathcal{L}, \mathcal{L})$ -separability for the fragments $\mathcal{L} \in \{\mathcal{ALCI}, \text{GF}, \text{FO}^2\}$. Note that these fragments do not contain UCQ nor CQ and thus the above results do not apply. For these fragments the following

distinction turns out to be of fundamental importance when defining weak separability: one might or might not admit the use of *helper symbols*, that is, symbols that do not occur in the KB, in the separating formula.

Example 2. Consider the KB $\mathcal{K} = (\mathcal{O}, \mathcal{D})$ with $\mathcal{O} = \{\forall x(\exists y \text{ shaves}(x, y) \wedge \exists y \text{ shaves}(y, x))\}$ stating that everybody shaves somebody and is shaved by somebody and $\mathcal{D} = \{\text{shaves}(p, p), \text{shaves}(n, n')\}$. Let $P = \{p\}$ and $N = \{n\}$. Then $\text{shaves}(x, x)$ weakly separates P from N in FO but there is no \mathcal{ALCI} -concept using only the symbol shaves that weakly separates P from N as under \mathcal{K} every such concept is either valid or unsatisfiable. However, by admitting a fresh unary relation symbol, say Barber , we obtain the formula $\varphi(x) = \text{Barber}(x) \rightarrow \exists y(\text{shaves}(x, y) \wedge \text{Barber}(y))$ which weakly separates P and N and is equivalent to an \mathcal{ALCI} -concept. Observe that indeed $\mathcal{K} \models \varphi(p)$ since if p is a barber, then, by $\text{shaves}(p, p)$, p shaves a barber. \blacktriangle

Motivated by Example 2 we distinguish between *projective* (with helper symbols) and *non-projective* (without helper symbols) versions of separability. While we show that projective and non-projective weak (FO, \mathcal{L}_S)-separability coincide for all FO-fragments \mathcal{L}_S situated between UCQ and FO, and therefore for the cases considered in (wA) and (wB), Example 2 shows that the projective and non-projective version do not coincide for \mathcal{ALCI} , and similar examples will be given for GF and FO². We then start the investigation with \mathcal{ALCI} and show the rather unexpected result that

(wC) projective weak (\mathcal{ALCI} , \mathcal{ALCI})-separability is the same as (both projective and non-projective) weak (\mathcal{ALCI} , UCQ)-separability and thus, by (wA), also as (projective and non-projective) weak (\mathcal{ALCI} , FO)-separability.

It then follows from (wB) and the known result that rooted UCQ-evaluation on \mathcal{ALCI} -KBs is $\text{coNEXP}_{\text{TIME}}$ -complete in combined complexity that projective weak (\mathcal{ALCI} , \mathcal{ALCI})-separability is $\text{NEXP}_{\text{TIME}}$ -complete in combined complexity.

By Example 2 the equivalence stated in (wC) depends on admitting helper symbols in separating \mathcal{ALCI} -concepts and its proof relies on a characterization of projective weak (\mathcal{ALCI} , \mathcal{ALCI})-inseparability using functional bisimulations. We next turn to the technically rather intricate case of non-projective weak (\mathcal{ALCI} , \mathcal{ALCI})-separability and characterize it using a mix of homomorphisms, bisimulations, and types. Intuitively, one has to understand when a helper symbol in a separating concept can be equivalently replaced by a (possibly compound) concept in the language of the KB. The characterization allows us to show that non-projective weak (\mathcal{ALCI} , \mathcal{ALCI})-separability is also $\text{NEXP}_{\text{TIME}}$ -complete in combined complexity.

For projective and non-projective weak (GF, GF)-separability, we establish characterizations that parallel those for \mathcal{ALCI} except that bisimulations are replaced with guarded bisimulations. As in the \mathcal{ALCI} -case, projective (GF, GF)-separability coincides with (projective and non-projective) (GF, UCQ)-separability, and thus also with (GF, FO)-separability. For referring expression existence and entity distinguishability, UCQ can be replaced by CQ. We additionally observe that projective and non-projective (GF, GF)-separability also coincide with projective and, respectively, non-projective, (GF, openGF)-separability, where openGF is a ‘local’ version of GF that only speaks about the neighbourhoods of the positive examples. While openGF has the same separating power as GF and enforces arguably more natural separating expressions than GF, we also show that separating expressions are sometimes less succinct. Finally, our main complexity result concerning GF is that

(wD) projective and non-projective weak (GF, GF)-separability are both $2\text{Exp}_{\text{TIME}}$ -complete in combined complexity.

The proofs use the same approach as those given for \mathcal{ALCI} and the complexity result relies on the fact that UCQ-evaluation of rooted UCQs on GF-KBs is $2\text{Exp}_{\text{TIME}}$ -complete. The proofs are technically more challenging, however, as one has to work with guarded bisimulations rather than bisimulations for \mathcal{ALCI} . We next show that, in contrast,

(wE) projective and non-projective weak (FO², FO²)-separability and (FO², FO)-separability are both undecidable.

Moreover, they coincide neither in the projective nor in the non-projective case. The latter result is proved, under mild conditions, for all fragments \mathcal{L} of FO that enjoy the finite model property (every satisfiable ontology is satisfied in a finite model) but are not finitely controllable for rooted UCQs (evaluating rooted UCQs on finite models does not coincide with evaluating them on arbitrary models).

As ontologies are typically small compared with databases, we also consider the data complexity of deciding separability where only the database and the sets of positive and negative examples are regarded as the input, but

the ontology is fixed. Some care is needed when using the aforementioned link with rooted UCQ-evaluation to analyze the data complexity of separability since, in the mutual reductions, the input database of the separability problem is used to construct the query of the evaluation problem, and vice versa. We show that, under mild conditions on the FO-fragment \mathcal{L} , one can construct for any \mathcal{L} -ontology \mathcal{O} an \mathcal{L} -ontology \mathcal{O}' such that one obtains a mutual polynomial time Turing reduction between rooted UCQ-evaluation on KBs with ontology \mathcal{O} and the complement of UCQ-separability of labeled KBs with ontology \mathcal{O}' , and vice versa. We then construct an \mathcal{ALCI} -ontology \mathcal{O} such that rooted UCQ-evaluation on KBs with ontology \mathcal{O} is coNEXP TIME -complete. Hence,

(wF) projective weak (\mathcal{ALCI} , \mathcal{ALCI})-separability is NEXP TIME -complete in data complexity.

Thus, remarkably, in this case data and combined complexity coincide. This lower bound applies to (GNFO, GNFO) and (GF, GF)-separability, but we conjecture that the latter problems are actually 2EXP TIME -hard in data complexity so that also in these cases data and combined complexity coincide. While the combined complexity of special cases such as referring expression existence coincides with that of separability for the languages considered, this remains open for data complexity.

We then switch to strong separability, first observing that in marked contrast to the weak case, projective strong $(\mathcal{L}, \mathcal{L}_S)$ -separability coincides with non-projective strong $(\mathcal{L}, \mathcal{L}_S)$ -separability for all choices of \mathcal{L} and \mathcal{L}_S relevant to this paper. We establish a characterization of strong (FO, FO)-separability in terms of KB unsatisfiability and show that

(sA) strong (FO, FO)-separability coincides with strong (FO, UCQ)-separability and consequently also with strong (FO, \mathcal{L}_S)-separability for all \mathcal{L}_S situated between UCQ and FO.

For strong referring expression existence and entity distinguishability UCQs can be replaced by CQs. We next consider the same FO-fragments \mathcal{ALCI} , GF, FO^2 as before and show that for each of these fragments \mathcal{L} , strong $(\mathcal{L}, \mathcal{L})$ -separability coincides with strong (\mathcal{L}, FO) -separability and thus the connection to KB unsatisfiability applies. This allows us to derive tight complexity bounds for strong $(\mathcal{L}, \mathcal{L})$ -separability:

(sB) for \mathcal{ALCI} , GF, and FO^2 strong separability is EXP TIME , 2EXP TIME , and, respectively, NEXP TIME -complete in combined complexity. It is coNP -complete in data complexity in all three cases.

Note that strong $(\text{FO}^2, \text{FO}^2)$ -separability thus turns out to be decidable, in contrast to the weak case. On the other hand, we show that the relationship between GF and openGF is the same as in the weak case: strong (GF, GF)-separability coincides with strong (GF, openGF)-separability but separating expressions can be more succinct. Finally, we show that in contrast to weak separability one can bound the size of strongly separating expressions independently from the size of the underlying database in terms of the size of the ontology, for \mathcal{ALCI} , GF, and FO^2 .

The following table gives an overview of our most important results, focussing on weak projective $(\mathcal{L}, \mathcal{L})$ -separability and strong $(\mathcal{L}, \mathcal{L})$ -separability, for $\mathcal{L} \in \{\mathcal{ALCI}, \text{GF}, \text{FO}^2\}$. For both weak and strong separability, we list (in columns 2 and 4) settings with the same separating power and (in columns 3 and 5) the combined complexity of deciding the respective version of separability. All complexity results are completeness results.

KB language \mathcal{L}	Weak Separability		Strong Separability	
	same separating power	complexity	same separating power	complexity
\mathcal{ALCI}	proj \mathcal{ALCI} , UCQ, FO	NEXP TIME	\mathcal{ALCI} , UCQ, FO	EXP TIME
GF	proj GF, proj openGF , UCQ, FO	2EXP TIME	GF, openGF , UCQ, FO	2EXP TIME
FO^2	proj FO^2	undecidable	FO^2 , UCQ, FO	coNEXP TIME

Our results rely on three important assumptions: we assume that different constants can denote the same element and so we do not make the unique name assumption, we do not admit constants (nor function symbols) in ontologies and separating formulas, and we do not admit any restrictions on the relations symbols from the KB that can be used in separating formulas. In all three cases it is of interest to explore what happens if one drops or relaxes the assumption. In the final section of this article we provide some results in this direction.

Structure of the Paper. We discuss related work in Section 2. In Section 3, we introduce the basic notions that are used in the rest of the paper. In Section 4, we introduce weak separability and make fundamental observations in the context of full first-order logic (as ontology and separating language). We then investigate in Section 5 weak separability for decidable fragments of first-order logic. In Sections 6 and 7, we study strong separability starting again with fundamental results. Finally, in Section 8, we discuss some variations and extensions of the problems investigated in this article and conclude with possible future work. Some proofs are deferred to an appendix.

2. Related Work and Applications

This article extends the conference paper [1]. It also generalizes, corrects, and puts into context some results first presented in [2]. For example, after establishing the link between projective weak (\mathcal{ALCI} , \mathcal{ALCI})-separability and rooted UCQ-evaluation on \mathcal{ALCI} -KBs, it is proved in [2] already that projective weak (\mathcal{ALCI} , \mathcal{ALCI})-separability is NEXPTIME -complete in combined complexity. It is also claimed to be Π_2^P -complete in data complexity. In this article (and [1] already) this error is fixed. As mentioned above, in this article (and [1]), we adopt the standard semantics of first-order logic and description logic and hence do not make the unique name assumption (UNA), but it is made in [2]. If \mathcal{ALCI} or a fragment is used as the ontology and separation language, the UNA does not affect weak separability nor strong separability, but for FO and extensions of \mathcal{ALCI} with number restrictions such as \mathcal{ALCQI} it does. We refer the reader to Section 8 for a detailed discussion of the role of the UNA in the context of separability. We also note that in [2] only the projective case of weak separability is considered (without using the term projective). The results obtained in [2] and also the recent [3] (which considers a more flexible version of separability in which the symbols that are used in separating expressions can be restricted) are also discussed in more detail in Section 8.

We next discuss related work and applications of our results in concept learning in DL, query by example, generating referring expressions, and entity comparison. We start with concept learning in DL as first proposed in [4]. Inspired by inductive logic programming, refinement operators are used to construct a concept that generalizes positive examples while not encompassing any negative ones. An ontology may or may not be present. There has been significant interest in this approach, both for weak separation [5, 6, 7, 8] and strong separation [9, 10, 11]. Prominent systems include the DL LEARNER [12, 13], DL-FOIL [14] and its extension DL-FOCL [15], SPaCEL [16], YIN YANG [17], and pFOIL-DL [18]. A method for generating strongly separating concepts based on bisimulations has been developed in [19, 20, 21] and an approach based on answer set programming was proposed in [22]. Algorithms for DL concept learning typically aim to be complete, that is, to find a separating concept whenever there is one. Complexity lower bounds for separability as studied in this paper then point to an inherent complexity that no such algorithm can avoid. Undecidability even means that there can be no learning algorithm that is both terminating and complete. We note that computing least common subsumers (LCS) and most specific concepts (MSC) can be viewed as DL concept learning in the case that only positive, but no negative example are available [23, 24, 25, 26]. A recent study of LCS and MSC from a separability angle is in [27].

Query by example is an active topic in database research for many years, see e.g. [28, 29, 30, 31, 32, 33] and [34] for a recent survey. In this context, separability has also received attention [35, 36, 37, 38]. A crucial difference to the present paper is that QBE in classical databases uses a closed world semantics under which there is a unique natural way to treat negative examples: simply demand that the separating formula evaluates to false there. Thus, the distinction between weak and strong separability, and also between projective and non-projective separability does not arise. QBE for ontology-mediated querying [39, 40, 41] and for SPARQL queries [42], in contrast, use an open world semantics. The former is captured by the framework studied in the current article. In fact, our results imply that the existence of a separating UCQ is decidable for ontology languages such as \mathcal{ALCI} and the guarded fragment. The corresponding problem for CQs is undecidable even when the ontology is formulated in the inexpressive description logic \mathcal{ELI} [2, 27], we refer the reader to Section 8 for further discussion.

Generating referring expressions (GRE) has originated from linguistics [43] and has also become an important challenge in data management. In fact, very often in applications the individual names in ontologies, knowledge graphs, or data sets are insufficient “to allow humans to figure out what real objects they refer to” [44]. In logic-based approaches to GRE, a referring expression for an individual is a formula that distinguishes that individual from all other relevant individuals. GRE fits into the framework used in this paper since a formula that separates a single data item from all other items in a KB can serve as a referring expression for the former. Both weak and strong separability are conceivable: weak separability means that the positive data item is the only one that we are certain to satisfy the

separating formula and strong separability means that in addition we are certain that the other data items do not satisfy the formula. Approaches to GRE such as the ones in [45, 46] aim for stronger guarantees, for instance by demanding that $\mathcal{K} \models \forall x ((a = x) \leftrightarrow \varphi(x))$ for any referring expression φ for a under \mathcal{K} . We note that in a closed world context description logic concepts have also been proposed for singling out a domain element in an interpretation [47]. The computation of referring expressions has recently also received interest in the context of ontology-mediated querying [45, 48].

In *entity comparison*, one aims to compare two selected data items, highlighting both their similarities and their differences. An approach to entity comparison in RDF graphs is presented in [49, 50]. There, SPARQL queries are used to describe both similarities and differences, under an open world semantics. The ‘computing similarities’ part of this approach is closely related to the LCS and MSC mentioned above. The ‘computing differences’ is closely related to QBE and fits into the framework studied in this paper. In fact, it corresponds to entity distinguishability with an empty ontology.

3. Preliminaries

Let Σ_{full} be a set of *relation symbols* that contains countably many symbols of every arity $n \geq 1$ and let Const be a countably infinite set of *constants*. A *signature* is a set of relation symbols $\Sigma \subseteq \Sigma_{\text{full}}$. We write \vec{a} for a tuple $(a_1, \dots, a_n) \in \text{Const}^n$ and set $[\vec{a}] = \{a_1, \dots, a_n\}$. A *database* \mathcal{D} is a finite set of *ground atoms* $R(\vec{a})$, where $R \in \Sigma_{\text{full}}$ and $\vec{a} \in \text{Const}^n$ with n the arity of R . We use $\text{cons}(\mathcal{D})$ to denote the set of constant symbols in \mathcal{D} .

Denote by FO the set of first-order (FO) formulas constructed from constant-free atomic formulas $x = y$ and $R(\vec{x})$, $R \in \Sigma_{\text{full}}$, using conjunction, disjunction, negation, and existential and universal quantification. As usual, we write $\varphi(\vec{x})$ to indicate that the free variables in the FO-formula φ are all from \vec{x} and call a formula *open* if it has at least one free variable and a *sentence* otherwise. Note that we do not admit constants in FO-formulas. While many results presented in this paper should lift to the case with constants, dealing with constants introduces significant technical issues that are outside the scope of this article. We refer the reader to Section 8 for a discussion of separability for languages with constants.

We consider fragments of FO that are closed under conjunction in the sense that if φ_1 and φ_2 are in the fragment, then a formula logically equivalent to $\varphi_1 \wedge \varphi_2$ is in the fragment. We consider various such fragments. A *conjunctive query* (CQ) takes the form $q(\vec{x}) = \exists \vec{y} \varphi$ where φ is a conjunction of atomic formulas $x = y$ and $R(\vec{y})$. We assume w.l.o.g. that if a CQ contains an equality $x = y$, then x and y are free variables. A *union of conjunctive queries* (UCQ) is a disjunction of CQs that all have the same free variables. In the context of CQs and UCQs, we speak of *answer variables* rather than of free variables. Observe that UCQ is closed under conjunction. A *unary UCQ* is a UCQ with a single answer variable. CQs and UCQs play an important role in database theory [51].

In the *guarded fragment* (GF) of FO [52, 53], formulas are built from atomic formulas $R(\vec{x})$ and $x = y$ by applying the Boolean connectives and *guarded quantifiers* of the form

$$\forall \vec{y} (\alpha(\vec{x}, \vec{y}) \rightarrow \varphi(\vec{x}, \vec{y})) \text{ and } \exists \vec{y} (\alpha(\vec{x}, \vec{y}) \wedge \varphi(\vec{x}, \vec{y}))$$

where $\varphi(\vec{x}, \vec{y})$ is a guarded formula and $\alpha(\vec{x}, \vec{y})$ is an atomic formula or an equality $x = y$ that contains all variables in $[\vec{x}] \cup [\vec{y}]$. The formula α is called the *guard of the quantifier*. GF generalizes many of the fundamental properties of modal logic and of description logics, such as decidability, the finite model property, and the tree-model property [54]. An even more expressive extension of GF with those properties is the *guarded negation fragment* GNFO of FO which contains both GF and UCQ. GNFO is obtained by imposing a guardedness condition on negation instead of on quantifiers, details can be found in [55]. Another fragment of FO that generalizes modal and description logic is the *two-variable fragment* FO² of FO that contains every formula in FO that uses only two fixed variables, say x and y [56]. We assume that FO²-formulas use unary and binary relation symbols only. FO² is also decidable and enjoys the finite model property, but it is generally regarded as a less robust generalization than the guarded fragment as it does not enjoy a natural generalization of the tree-model property [54]. We show in this article that this has significant repercussions also for separability.

For \mathcal{L} an FO-fragment, an \mathcal{L} -ontology is a finite set of \mathcal{L} -sentences. An \mathcal{L} -knowledge base (KB) is a pair $(\mathcal{O}, \mathcal{D})$, where \mathcal{O} is an \mathcal{L} -ontology and \mathcal{D} a database. For any syntactic object O such as a formula, an ontology, and a KB, we

use $\text{sig}(O)$ to denote the set of relation symbols that occur in O and $\|O\|$ to denote the *size* of O , that is, the number of symbols needed to write it with names of relations, variables, and constants counting as a single symbol.

As usual, KBs $\mathcal{K} = (O, \mathcal{D})$ are interpreted in *structures* $\mathfrak{A} = (\text{dom}(\mathfrak{A}), (R^{\mathfrak{A}})_{R \in \Sigma_{\text{full}}}, (c^{\mathfrak{A}})_{c \in \text{Const}})$ where $\text{dom}(\mathfrak{A})$ is the non-empty *domain* of \mathfrak{A} , each $R^{\mathfrak{A}}$ is a relation over $\text{dom}(\mathfrak{A})$ whose arity matches that of R , and $c^{\mathfrak{A}} \in \text{dom}(\mathfrak{A})$ for all $c \in \text{Const}$. Note that we do not make the *unique name assumption (UNA)*, that is $c_1^{\mathfrak{A}} = c_2^{\mathfrak{A}}$ might hold even when $c_1 \neq c_2$. This assumption is essential for several of our results and we discuss its role in detail in Section 8. For a structure \mathfrak{A} , FO formula $\varphi(\vec{x})$, and tuple $\vec{a} \in \text{dom}(\mathfrak{A})^{|\vec{x}|}$ we write $\mathfrak{A} \models \varphi(\vec{a})$ if $\varphi(\vec{x})$ is satisfied in \mathfrak{A} under the assignment $\vec{x} \mapsto \vec{a}$. A structure \mathfrak{A} is a *model of a KB* $\mathcal{K} = (O, \mathcal{D})$ if it satisfies all sentences in O and all ground atoms in \mathcal{D} . A KB \mathcal{K} is *satisfiable* if there exists a model of \mathcal{K} . For a KB $\mathcal{K} = (O, \mathcal{D})$, formula $\varphi(\vec{x})$, and tuple $\vec{a} \in \text{cons}(\mathcal{D})^{|\vec{x}|}$, we say that $\varphi(\vec{a})$ is *entailed by* \mathcal{K} , in symbols $\mathcal{K} \models \varphi(\vec{a})$, if $\mathfrak{A} \models \varphi(\vec{a}^{\mathfrak{A}})$ for every model \mathfrak{A} of \mathcal{K} , where $\vec{a}^{\mathfrak{A}}$ stands for $(a_1^{\mathfrak{A}}, \dots, a_n^{\mathfrak{A}})$ if $\vec{a} = (a_1, \dots, a_n)$.

We next introduce notation for query evaluation on KBs. Let \mathcal{Q} (the query language) and \mathcal{L} (the ontology language) be fragments of FO. For example, \mathcal{Q} could be the set of UCQs and \mathcal{L} could be GF. Then *Q-evaluation on L-KBs* is the problem to decide, given a formula (also called query) $q(\vec{x}) \in \mathcal{Q}$, an \mathcal{L} -KB $\mathcal{K} = (O, \mathcal{D})$, and a tuple $\vec{a} \in \text{cons}(\mathcal{D})^{|\vec{x}|}$, whether $\mathcal{K} \models q(\vec{a})$. The complexity of \mathcal{Q} -evaluation on \mathcal{L} -KBs has been investigated extensively, for various query language \mathcal{Q} and ontology languages \mathcal{L} .

Description logics are fragments of FO that only support relation symbols of arities one and two, called concept names and role names. DLs come with their own syntax, which we introduce next [57, 58]. A *role* is a role name or an *inverse role* R^- with R a role name. For uniformity, we set $(R^-)^- = R$. *ALCI-concepts* are defined by the grammar

$$C, D ::= \perp \mid A \mid \neg C \mid C \sqcap D \mid \exists R.C$$

where A ranges over concept names and R over roles. As usual, we write \top for $\neg\perp$, $C \sqcup D$ for $\neg(\neg C \sqcap \neg D)$, $C \rightarrow D$ for $\neg C \sqcup D$, and $\forall R.C$ for $\neg\exists R.\neg C$. An *ALCI-concept inclusion (CI)* takes the form $C \sqsubseteq D$ where C and D are *ALCI-concepts*. An *ALCI-ontology* is a finite set of *ALCI-CIs*. An *ALCI-KB* $\mathcal{K} = (O, \mathcal{D})$ consists of an *ALCI-ontology* O and a database \mathcal{D} that uses only unary and binary relation symbols. We sometimes also mention the fragment *ALC* of *ALCI* in which inverse roles are not available.

If Σ is a signature of concept and role names, then an *ALCI(Σ)-concept* is an *ALCI-concept* using only symbols in Σ . A Σ -*role* is a role that is either a role name in Σ or of the form $R = S^-$ with $S \in \Sigma$.

To obtain a semantics, every *ALCI-concept* C can be translated into a GF-formula C^\dagger with one free variable x : see [58].

$$\begin{aligned} \perp^\dagger &= \neg(x = x) \\ A^\dagger &= A(x) \\ (\neg\varphi)^\dagger &= \neg\varphi^\dagger \\ (C \sqcap D)^\dagger &= C^\dagger \wedge D^\dagger \\ (\exists R.C)^\dagger &= \exists y (R(x, y) \wedge C^\dagger[y/x]) \\ (\exists R^-.C)^\dagger &= \exists y (R(y, x) \wedge C^\dagger[y/x]). \end{aligned}$$

A CI $C \sqsubseteq D$ translates into the GF-sentence $\forall x (C^\dagger(x) \rightarrow D^\dagger(x))$. By reusing variables, we can even obtain formulas and ontologies from $\text{GF} \cap \text{FO}^2$. It follows that every *ALCI-concept*, *CI*, and *ontology* can be viewed as a $\text{GF} \cap \text{FO}^2$ -formula, sentence, and ontology, respectively. The *extension* $C^{\mathfrak{A}}$ of a concept C in a structure \mathfrak{A} is defined as $C^{\mathfrak{A}} = \{a \in \text{dom}(\mathfrak{A}) \mid \mathfrak{A} \models C^\dagger(a)\}$. We write $O \models C \sqsubseteq D$ if $C^{\mathfrak{A}} \subseteq D^{\mathfrak{A}}$ holds in every model \mathfrak{A} of O . Concepts C and D are *equivalent* w.r.t. an ontology O if $O \models C \sqsubseteq D$ and $O \models D \sqsubseteq C$. Let $\mathcal{K} = (O, \mathcal{D})$ be an *ALCI-KB*, C an *ALCI-concept*, and $a \in \text{cons}(\mathcal{D})$. Then $C(a)$ is *entailed by* \mathcal{K} , in symbols $\mathcal{K} \models C(a)$, if $a^{\mathfrak{A}} \in C^{\mathfrak{A}}$ for all models \mathfrak{A} of \mathcal{K} . Note that *ALCI* enjoys the finite model property in the sense that $\mathcal{K} \models C(a)$ iff $a^{\mathfrak{A}} \in C^{\mathfrak{A}}$ for all finite models \mathfrak{A} of \mathcal{K} [58].

A summary of the inclusion relationships between the languages introduced above is given in Figure 3. The figure also contains a few description logics that have not yet been introduced but which are part of the discussion of related and future work. We refer the reader to [58] for a detailed introduction.

We next introduce the Gaifman graph of a structure [59] and notation for homomorphisms. Both play a prominent role throughout the paper. Let \mathfrak{A} be a structure. The *Gaifman graph* $G_{\mathfrak{A}}$ of \mathfrak{A} has the set of vertices $\text{dom}(\mathfrak{A})$ and an edge $\{d, e\}$ whenever there exists $\vec{a} \in R^{\mathfrak{A}}$ containing d, e for some relation R . We often apply graph-theoretic terminology to structures, in the obvious way. For example, a node b is *reachable* from a node a in \mathfrak{A} if there is a path from a to b in the Gaifman graph of \mathfrak{A} . The *distance* $\text{dist}_{\mathfrak{A}}(a, b)$ between a and b is the length of the shortest path from a to

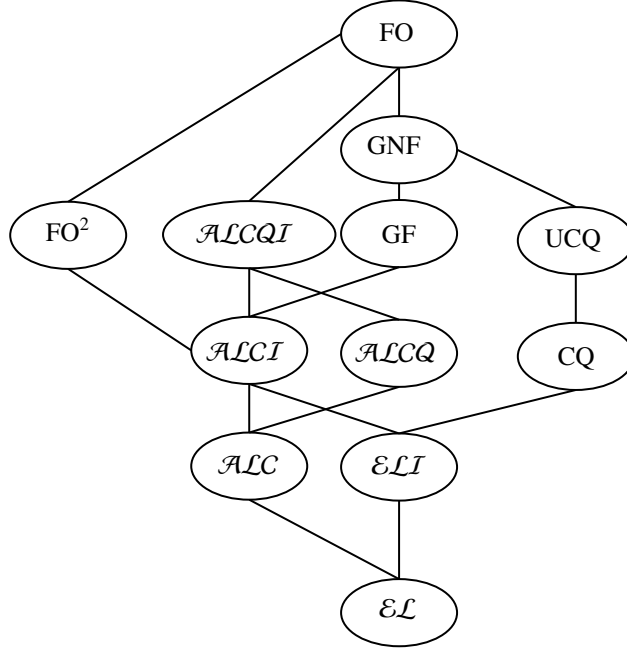

Figure 1: Relationship between languages.

b , if there exists one. The *outdegree* of \mathfrak{A} is defined as the degree of its Gaifman graph. A *homomorphism* h from a structure \mathfrak{A} to a structure \mathfrak{B} is a function $h : \text{dom}(\mathfrak{A}) \rightarrow \text{dom}(\mathfrak{B})$ such that $\vec{a} \in R^{\mathfrak{A}}$ implies $h(\vec{a}) \in R^{\mathfrak{B}}$ for all relation symbols R and tuples $\vec{a} \in \text{dom}(\mathfrak{A})^n$ with n the arity of \vec{a} and $h(\vec{a})$ being defined component-wise in the expected way. Note that homomorphisms need not preserve constant symbols. Every database \mathcal{D} gives rise to the finite structure $\mathfrak{A}_{\mathcal{D}}$ with $\text{dom}(\mathfrak{A}_{\mathcal{D}}) = \text{cons}(\mathcal{D})$ and $\vec{a} \in R^{\mathfrak{A}_{\mathcal{D}}}$ iff $R(\vec{a}) \in \mathcal{D}$. A homomorphism from database \mathcal{D} to structure \mathfrak{A} is a homomorphism from $\mathfrak{A}_{\mathcal{D}}$ to \mathfrak{A} . A *pointed structure* takes the form \mathfrak{A}, \vec{a} with \mathfrak{A} a structure and \vec{a} a tuple of elements of $\text{dom}(\mathfrak{A})$. A homomorphism from \mathfrak{A}, \vec{a} to pointed structure \mathfrak{B}, \vec{b} is a homomorphism h from \mathfrak{A} to \mathfrak{B} with $h(\vec{a}) = \vec{b}$. We write $\mathfrak{A}, \vec{a} \rightarrow \mathfrak{B}, \vec{b}$ if such a homomorphism exists. We use the same notation for databases. For example, a *pointed database* is a pair \mathcal{D}, \vec{a} with \vec{a} a tuple in \mathcal{D} and a homomorphism from \mathcal{D}, \vec{a} to pointed structure \mathfrak{A}, \vec{b} is a homomorphism from $\mathfrak{A}_{\mathcal{D}}, \vec{a}$ to \mathfrak{A}, \vec{b} . We write $\mathcal{D}, \vec{a} \rightarrow \mathfrak{A}, \vec{b}$ if no such homomorphism exists.

We introduce a few fundamental properties of logics. A fragment \mathcal{L} of FO enjoys the *relativization property* [60] if for every \mathcal{L} -sentence φ and unary relation symbol $A \notin \text{sig}(\varphi)$, there exists a sentence φ' such that for every structure \mathfrak{A} with $A^{\mathfrak{A}} \neq \emptyset$, $\mathfrak{A} \models \varphi'$ iff $\mathfrak{A}|_A \models \varphi$, where $\mathfrak{A}|_A$ is the restriction of \mathfrak{A} to domain $A^{\mathfrak{A}}$. To illustrate, given an \mathcal{ALCI} -CI $C \sqsubseteq D$, then $C|_A \sqsubseteq D|_A$ is as required, where $C|_A$ is defined inductively by setting $\perp|_A = \perp$, $B|_A = B \sqcap A$, $(\neg C)|_A = A \sqcap \neg C|_A$, $(C \sqcap D)|_A = C|_A \sqcap D|_A$, and $(\exists R.C)|_A = A \sqcap \exists R.C|_A$. All languages depicted in Figure 3 enjoy the relativization property.

A fragment \mathcal{L} of FO enjoys the *finite model property* if for every \mathcal{L} -KB \mathcal{K} , \mathcal{L} -formula $\varphi(\vec{x})$, and tuple $\vec{a} \in \text{cons}(\mathcal{D})^{|\vec{x}|}$, $\mathcal{K} \models \varphi(\vec{a})$ iff $\mathfrak{A} \models \varphi(\vec{a}^{\mathfrak{A}})$ for every finite model \mathfrak{A} of \mathcal{K} . All logics in Figure 3 with the exception of \mathcal{ALCQI} and FO enjoy the finite model property [56, 53, 61, 62].

Finally, we also require a version of the finite model property for query evaluation. Let \mathcal{L} be a fragment of FO. Evaluating queries from a query language Q contained in FO is *finitely controllable* on \mathcal{L} -KBs if for every \mathcal{L} -ontology \mathcal{O} , database \mathcal{D} , formula $\varphi(\vec{x})$ in Q , tuple of constants $\vec{a} \in \text{cons}(\mathcal{D})^{|\vec{x}|}$, if $(\mathcal{O}, \mathcal{D}) \not\models \varphi(\vec{a})$, then there is a finite model \mathfrak{A} of \mathcal{K} such that $\mathfrak{A} \not\models \varphi(\vec{a}^{\mathfrak{A}})$ [63, 64]. Note that \mathcal{L} has the finite model property if evaluating queries from \mathcal{L} is finitely controllable on \mathcal{L} -KBs. Evaluating CQs and UCQs is finitely controllable on \mathcal{L} -KBs for all \mathcal{L} depicted in Figure 3 with the exception of \mathcal{ALCQI} , FO^2 , and FO [58, 65, 64]. It follows that FO^2 is the only example of a language in Figure 3 that enjoys the finite model property but for which evaluating CQs and UCQs is not finitely controllable.

4. Fundamental Results for Weak Separability

We introduce the problem of (weak) separability in its projective and non-projective version. We also discuss special cases of separability such as definability, referring expression existence, and entity distinguishability. We then give a fundamental characterization of (FO, FO)-separability which has the consequence that UCQs have the same separating power as FO. This allows us to settle the complexity of deciding separability in GNFO.

Definition 3. Let \mathcal{L} be a fragment of FO. A labeled \mathcal{L} -KB takes the form (\mathcal{K}, P, N) with $\mathcal{K} = (O, \mathcal{D})$ an \mathcal{L} -KB and $P, N \subseteq \text{cons}(\mathcal{D})^n$ non-empty sets of positive and negative examples, all of them tuples of the same length n .

An FO-formula $\varphi(\vec{x})$ with n free variables (weakly) separates (\mathcal{K}, P, N) if

1. $\mathcal{K} \models \varphi(\vec{d})$ for all $\vec{d} \in P$ and
2. $\mathcal{K} \not\models \varphi(\vec{d})$ for all $\vec{d} \in N$.

Let \mathcal{L}_S be a fragment of FO. We say that (\mathcal{K}, P, N) is projectively \mathcal{L}_S -separable if there is an \mathcal{L}_S -formula $\varphi(\vec{x})$ that separates (\mathcal{K}, P, N) and (non-projectively) \mathcal{L}_S -separable if there is such a $\varphi(\vec{x})$ with $\text{sig}(\varphi) \subseteq \text{sig}(\mathcal{K})$.

The following example illustrates the definition.

Example 4. Let $\mathcal{K}_1 = (\emptyset, \mathcal{D}_1)$ where

$$\mathcal{D}_1 = \{\text{born_in}(a, c), \text{citizen_of}(a, c), \text{born_in}(b, c_1), \text{citizen_of}(b, c_2), \text{Person}(a)\}.$$

Then $\text{Person}(x)$ separates $(\mathcal{K}_1, \{a\}, \{b\})$. As any citizen is a person, however, this separating formula is not natural and it only separates because of incomplete information about b . This may change with knowledge from the ontology. Let

$$\mathcal{O}_2 = \{\forall x(\forall y(\text{citizen_of}(x, y) \rightarrow \text{Person}(x)))\}$$

and $\mathcal{K}_2 = (\mathcal{O}_2, \mathcal{D}_1)$. (It will later be useful to note that the ontology \mathcal{O}_2 can also be regarded as an \mathcal{ALCI} -ontology since $\forall x(\forall y(\text{citizen_of}(x, y) \rightarrow \text{Person}(x)))$ is equivalent to the CI $\exists \text{citizen_of}.\top \sqsubseteq \text{Person}$.) We have $\mathcal{K}_2 \models \text{Person}(b)$ and so $\text{Person}(x)$ no longer separates. However, the more natural formula

$$\varphi(x) = \exists y(\text{born_in}(x, y) \wedge \text{citizen_of}(x, y)),$$

separates $(\mathcal{K}_2, \{a\}, \{b\})$. Thus $(\mathcal{K}_2, \{a\}, \{b\})$ is non-projectively \mathcal{L} -separable for $\mathcal{L} \in \{\text{CQ}, \text{GF}, \text{FO}^2\}$.

In contrast, it will follow from the model-theoretic characterization given below (Example 11) that the labeled KB $(\mathcal{K}_2, \{b\}, \{a\})$ in which b is the positive example and a the negative example is not FO-separable. Note that this observation rests on admitting models \mathfrak{A} of \mathcal{K}_2 with $c_1^{\mathfrak{A}} = c_2^{\mathfrak{A}}$ (no UNA) because otherwise

$$\exists y_1 \exists y_2 (y_1 \neq y_2 \wedge \text{born_in}(x, y_1) \wedge \text{citizen_of}(x, y_2))$$

would be a separating formula. ▲

In the projective case, one admits symbols that are not from $\text{sig}(\mathcal{K})$ as helper symbols in separating formulas. Their availability sometimes makes inseparable KBs separable, for some separation languages. The following example illustrates the role of helper symbols. Note that in [2], helper symbols are generally admitted and the results depend on this assumption.

Example 5. The separating formula $\varphi(x)$ in Example 4 cannot be expressed as an \mathcal{ALCI} -concept. Using a helper concept name A , however, we obtain the separating concept

$$C = \forall \text{born_in}.A \rightarrow \exists \text{citizen_of}.A.$$

and thus $(\mathcal{K}_2, \{a\}, \{b\})$ is projectively \mathcal{ALCI} -separable. Note that $\mathcal{K}_2 \models C(a)$ because whenever $a^{\mathfrak{A}} \in (\forall \text{born_in}.A)^{\mathfrak{A}}$ for a model \mathfrak{A} of \mathcal{K}_2 , then $c_1^{\mathfrak{A}} \in A^{\mathfrak{A}}$ and so $a^{\mathfrak{A}} \in (\exists \text{citizen_of}.A)^{\mathfrak{A}}$. On the other hand, $\mathcal{K}_2 \not\models C(b)$ because the structure \mathfrak{A} obtained by adding $\text{Person}(b)$ and $A(c_1)$ to \mathcal{D}_1 is a model of \mathcal{K}_2 with $b^{\mathfrak{A}} \notin C^{\mathfrak{A}}$. For separation, it is

thus important that A is not constrained by O_2 . For a natural interpretation of the separating concept C one should view A as a universally quantified second-order variable. Then $\mathcal{K}_2 \models C(a)$ can be understood as: ‘for any class A , it follows from \mathcal{K}_2 that $C(a)$ ’. Finally note that **Person** is a concept name that, despite being in $\text{sig}(\mathcal{K}_2)$, is also sufficiently unconstrained by O_2 to act as a helper symbol: by replacing A by **Person** in C , one obtains a (rather unnatural) concept that witnesses also non-projective \mathcal{ALCI} -separability of $(\mathcal{K}_2, \{a\}, \{b\})$. An example of a labeled KB that is projectively \mathcal{ALCI} -separable but not non-projectively \mathcal{ALCI} -separable was given in Example 2 and will be discussed further in Example 21 below. \blacktriangle

Each choice of an ontology language \mathcal{L} and a separation language \mathcal{L}_S give rise to a separability problem and a projective separability problem, defined as follows.

PROBLEM : (Projective) $(\mathcal{L}, \mathcal{L}_S)$ -separability
INPUT : A labeled \mathcal{L} -KB (\mathcal{K}, P, N)
QUESTION : Is (\mathcal{K}, P, N) (projectively) \mathcal{L}_S -separable?

We study both the *combined complexity* and the *data complexity* of separability. In the former, the full labeled KB (\mathcal{K}, P, N) with $\mathcal{K} = (\mathcal{O}, \mathcal{D})$ is taken as the input. In the latter, only \mathcal{D} and the examples P, N are regarded as the input while \mathcal{O} is assumed to be fixed. We next introduce important special cases of $(\mathcal{L}, \mathcal{L}_S)$ -separability:

- $(\mathcal{L}, \mathcal{L}_S)$ -*definability* is $(\mathcal{L}, \mathcal{L}_S)$ -separability for labeled KBs where P and N partition the example space, that is, inputs are labeled \mathcal{L} -KBs (\mathcal{K}, P, N) such that $N = \text{cons}(\mathcal{D})^n \setminus P$, n the length of example tuples.
- $(\mathcal{L}, \mathcal{L}_S)$ -*referring expression existence (RE-existence)* is $(\mathcal{L}, \mathcal{L}_S)$ -definability for labeled KBs where P is a singleton set.
- $(\mathcal{L}, \mathcal{L}_S)$ -*entity distinguishability* is $(\mathcal{L}, \mathcal{L}_S)$ -separability for labeled KBs where P and N are both singleton sets.

Note that for definability and referring expression existence we could remove the set N of negative examples from the input as it is uniquely determined by \mathcal{D} and P . As the length of example tuples in P is not bounded (and so the size of $\text{cons}(\mathcal{D})^n \setminus P$ is not polynomial in the size of $\text{cons}(\mathcal{D})$ and P) this could affect the complexity of deciding definability and/or referring expression existence. In our proofs below we make sure that we show the complexity bounds independently from the representation.

Note also that as we only study FO-fragments \mathcal{L}_S that are closed under conjunction, a labeled KB (\mathcal{K}, P, N) is (projectively) \mathcal{L}_S -separable if and only if all $(\mathcal{K}, P, \{\vec{b}\})$, $\vec{b} \in N$, are (projectively) \mathcal{L}_S -separable. In fact, a formula that separates (\mathcal{K}, P, N) can be obtained by taking the conjunction of formulas that separate $(\mathcal{K}, P, \{\vec{b}\})$, $\vec{b} \in N$. When formulating semantic characterizations we thus often consider labeled KBs with single negative examples only. In terms of computational complexity, we have the following reduction.

Observation 6. *Let \mathcal{L} and \mathcal{L}_S be fragments of FO with \mathcal{L}_S closed under conjunction. Then there is a polynomial time Turing reduction of (projective) $(\mathcal{L}, \mathcal{L}_S)$ -separability to (projective) $(\mathcal{L}, \mathcal{L}_S)$ -separability with a single negative example.*

Our first result provides a characterization of (FO, FO)-separability in terms of homomorphisms, linking it to UCQ-separability and in fact to UCQ-evaluation on KBs. We first give some preliminaries. With every pointed database \mathcal{D}, \vec{a} , where $\vec{a} = (a_1, \dots, a_n)$, we associate a CQ $\varphi_{\mathcal{D}, \vec{a}}(\vec{x})$ with free variables $\vec{x} = (x_1, \dots, x_n)$ that is obtained from \mathcal{D}, \vec{a} as follows: view each $R(c_1, \dots, c_m) \in \mathcal{D}$ as an atom $R(x_{c_1}, \dots, x_{c_m})$, existentially quantify all variables x_c with $c \in \text{cons}(\mathcal{D}) \setminus [\vec{a}]$, replace every variable x_c such that $a_i = c$ for some i with the variable x_i such that i is minimal with $a_i = c$, and finally add $x_i = x_j$ whenever $a_i = a_j$. Then $\varphi_{\mathcal{D}, \vec{a}}(\vec{x})$ is the logically strongest CQ such that $\mathcal{D} \models \varphi_{\mathcal{D}, \vec{a}}(\vec{a})$. This link between conjunctive queries and pointed databases is well known [66]. For a pointed database \mathcal{D}, \vec{a} , we write $\mathcal{D}_{\text{con}(\vec{a})}$ to denote the restriction of \mathcal{D} to those constants that are reachable from some constant in \vec{a} in the Gaifman graph of \mathcal{D} . Equivalently, $R(\vec{b}) \in \mathcal{D}_{\text{con}(\vec{a})}$ iff $R(\vec{b}) \in \mathcal{D}$ and there exists $a \in [\vec{a}]$ such that there exists a path from a to some $b \in [\vec{b}]$ in \mathcal{D} .

Example 7. Consider the database \mathcal{D}_1 introduced in Example 4. Then

$$\varphi_{\mathcal{D}_1, \text{con}(a), a}(x) = \exists y(\text{born_in}(x, y) \wedge \text{citizen_of}(x, y) \wedge \text{Person}(x))$$

extends the formula we identified as a separating formula for $(\mathcal{K}_2, \{a\}, \{b\})$ in the example with the atom $\text{Person}(x)$.

Note that $\varphi_{\mathcal{D}_1, \text{con}(b), b}(x) = \exists y_1 \exists y_2(\text{born_in}(x, y_1) \wedge \text{citizen_of}(x, y_2))$. \blacktriangle

We are now in a position to formulate our first result.

Theorem 8. Let $(\mathcal{K}, P, \{\vec{b}\})$ be a labeled FO-KB, $\mathcal{K} = (\mathcal{O}, \mathcal{D})$. Then the following conditions are equivalent:

1. $(\mathcal{K}, P, \{\vec{b}\})$ is projectively UCQ-separable;
2. $(\mathcal{K}, P, \{\vec{b}\})$ is projectively FO-separable;
3. there exists a model \mathfrak{A} of \mathcal{K} such that for all $\vec{a} \in P$: $\mathcal{D}_{\text{con}(\vec{a})}, \vec{a} \dashv\vdash \mathfrak{A}, \vec{b}^{\mathfrak{A}}$;
4. the UCQ $\bigvee_{\vec{a} \in P} \varphi_{\mathcal{D}_{\text{con}(\vec{a})}, \vec{a}}$ separates $(\mathcal{K}, P, \{\vec{b}\})$.

Proof. “1. \Rightarrow 2.” and “4. \Rightarrow 1.” are trivial and “3. \Rightarrow 4.” is straightforward. We thus concentrate on “2. \Rightarrow 3.” Assume that $(\mathcal{K}, P, \{\vec{b}\})$ is separated by an FO-formula $\varphi(\vec{x})$. Then there is a model \mathfrak{A} of \mathcal{K} such that $\mathfrak{A} \not\models \varphi(\vec{b}^{\mathfrak{A}})$. Let $\vec{a} \in P$. Since $\mathcal{K} \models \varphi(\vec{a})$, there is no model \mathfrak{B} of \mathcal{K} and such that $\mathfrak{B}, \vec{a}^{\mathfrak{B}}$ and $\mathfrak{A}, \vec{b}^{\mathfrak{A}}$ are isomorphic, meaning that there is an isomorphism τ from \mathfrak{B} to \mathfrak{A} with $\tau(\vec{a}^{\mathfrak{B}}) = \vec{b}^{\mathfrak{A}}$. We show that \mathfrak{A} satisfies Condition 3. Assume to the contrary that there is a homomorphism h from $\mathcal{D}_{\text{con}(\vec{a})}, \vec{a}$ to $\mathfrak{A}, \vec{b}^{\mathfrak{A}}$ for some $\vec{a} \in P$. Let the structure \mathfrak{B} be obtained from \mathfrak{A} by setting $c^{\mathfrak{B}} = h(c)$ for all $c \in \text{cons}(\mathcal{D}_{\text{con}(\vec{a})})$ and $c^{\mathfrak{B}} = c^{\mathfrak{A}}$ for all remaining constants c . This construction relies on not making the UNA. \mathfrak{B} is a model of \mathcal{K} since \mathcal{O} does not contain constants. It is easy to verify that $\mathfrak{B}, \vec{a}^{\mathfrak{B}}$ and $\mathfrak{A}, \vec{b}^{\mathfrak{A}}$ are isomorphic and thus we have obtained a contradiction. \square

Note that the UCQ in Point 4 of Theorem 8 is a concrete separating formula. It is only of size polynomial in the size of the KB, but often not very illuminating. It also contains no helper symbols (in fact, it even contains only relation symbols that occur in \mathcal{D} while symbols that only occur in \mathcal{O} are not used) and thus we obtain the following.

Corollary 9. (FO, FO)-separability, (FO, \mathcal{L}_S)-separability, and projective (FO, \mathcal{L}_S)-separability coincide for all FO-fragments $\mathcal{L}_S \supseteq \text{UCQ}$. The same is true for definability.

The UCQ in Point 4 of Theorem 8 is a CQ if P contains a single example. Thus we obtain the following result for referring expression existence and entity distinguishability.

Corollary 10. (FO, FO)-entity distinguishability, (FO, \mathcal{L}_S)-entity distinguishability, and projective (FO, \mathcal{L}_S)-entity distinguishability coincide for all FO-fragments $\mathcal{L}_S \supseteq \text{CQ}$. The same is true for RE-existence.

The following example applies the characterization given in Theorem 8 to Examples 4 and 7.

Example 11. Consider the labeled KB $(\mathcal{K}_2, \{a\}, \{b\})$ introduced in Example 4. Point 4 of Theorem 8 shows that in Example 4 we have chosen the canonical UCQ $\varphi_{\mathcal{D}_1, \text{con}(a), a}(x)$ (which is actually a CQ since we have only one positive example) that separates $(\mathcal{K}_2, \{a\}, \{b\})$ if there is an FO-formula at all that separates $(\mathcal{K}_2, \{a\}, \{b\})$.

It follows from Point 3 of Theorem 8 that the labeled KB $(\mathcal{K}_2, \{b\}, \{a\})$ introduced in Example 4 is not FO-separable: for any model \mathfrak{A} of \mathcal{K}_2 there is a homomorphism h from $\mathcal{D}_{1, \text{con}(b)}$ to \mathfrak{A} mapping b to $a^{\mathfrak{A}}$ as one can always set $h(c_1) = h(c_2) = c^{\mathfrak{A}}$. \blacktriangle

We next observe a general result about the impact of strengthening the ontology on the separability of labeled KBs. Say that $(\mathcal{L}, \mathcal{L}_S)$ -separability is *anti-monotone in the ontology* if for all labeled \mathcal{L} -KBs (\mathcal{K}_i, P, N) with $\mathcal{K}_i = (\mathcal{O}_i, \mathcal{D})$ for $i = 1, 2$, if $\mathcal{O}_1 \subseteq \mathcal{O}_2$ and (\mathcal{K}_2, P, N) is \mathcal{L}_S -separable, then (\mathcal{K}_1, P, N) is \mathcal{L}_S -separable. Then the following result follows from Point 3 of Theorem 8.

Corollary 12. Projective and non-projective (FO, \mathcal{L}_S)-separability are anti-monotone in the ontology, for all FO-fragments $\mathcal{L}_S \supseteq \text{UCQ}$.

Note that Corollary 12 *never* holds in the non-projective case if that case differs from the projective case. The argument is straightforward. If (\mathcal{K}, P, N) is \mathcal{L}_S -separable using helper symbols but not without helper symbols, then by adding tautologies using the helper symbols used in the separating formula to the ontology of \mathcal{K} makes (\mathcal{K}, P, N) \mathcal{L}_S -separable. Note also that Corollary 12 has no counterpart for the database of the labeled KB as adding ground atoms to the database can clearly both make non-separable labeled KBs separable but also separable labeled KBs non-separable.

Theorem 8 shows that there is a very close link between separability and query evaluation on KBs. In particular, it implies that for all $(\mathcal{L}, \mathcal{L}_S)$ with \mathcal{L} and \mathcal{L}_S fragments of FO such that $\mathcal{L}_S \supseteq \text{UCQ}$, $(\mathcal{L}, \mathcal{L}_S)$ -separability can be polynomially reduced to the complement of UCQ-evaluation on \mathcal{L} -KBs. We can actually do better than this: call a CQ *rooted* if every variable is reachable from an answer variable. A UCQ is called *rooted* if all its CQs are rooted. Then the CQs $\varphi_{\mathcal{D}_{\text{con}(\vec{a}), \vec{a}}}$ are rooted and so are the UCQs $\bigvee_{\vec{a} \in P} \varphi_{\mathcal{D}_{\text{con}(\vec{a}), \vec{a}}}$. Theorem 8 now implies the reductions from left to right of the following corollary. For the converse direction, we require that the fragment \mathcal{L} enjoys the relativization property introduced above.

Corollary 13. *Let \mathcal{L} be a fragment of FO enjoying the relativization property.*

1. *For all fragments $\mathcal{L}_S \supseteq \text{UCQ}$ of FO, $(\mathcal{L}, \mathcal{L}_S)$ -separability for labeled KBs with a single negative example can be mutually polynomial time reduced with the complement of rooted UCQ-evaluation on \mathcal{L} -KBs.*
2. *For all fragments $\mathcal{L}_S \supseteq \text{CQ}$ of FO, $(\mathcal{L}, \mathcal{L}_S)$ -entity distinguishability can be mutually polynomial time reduced with the complement of rooted CQ-evaluation on \mathcal{L} -KBs.*

For the reduction from left to right the relativization property can be dropped.

Proof. We show for Point 1 the reduction from rooted UCQ-evaluation to separability. The reduction from rooted CQ-evaluation to entity distinguishability in Point 2 follows directly from the proof. Assume an \mathcal{L} -KB $\mathcal{K} = (\mathcal{O}, \mathcal{D})$, a rooted UCQ $q(\vec{x}) = \bigvee_{i \in I} q_i(\vec{x})$, $\vec{x} = (x_1, \dots, x_n)$, and a tuple \vec{a} in \mathcal{D} are given. Consider the relativization $\mathcal{O}_{|A}$ of the sentences of \mathcal{O} to A and $\mathcal{D}^{+A} = \mathcal{D} \cup \{A(c) \mid c \in \text{cons}(\mathcal{D})\}$, for a fresh unary relation A . Regard each CQ $q_i(x_1, \dots, x_n)$ as a pointed database $\mathcal{D}_i, ([x_1], \dots, [x_n])$ as follows. Let \sim be the smallest (in terms of containment) equivalence relation that contains (x, y) for every conjunct $(x = y)$ of q_i . Then regard the equivalence classes $[x]$ as constants and set $R([y_1], \dots, [y_m]) \in \mathcal{D}_i$ iff there are $y'_1 \in [y_1], \dots, y'_m \in [y_m]$ such that $R(y'_1, \dots, y'_m)$ is a conjunct of q_i . We assume the pointed databases $\mathcal{D}_i, ([x_1], \dots, [x_n]), i \in I$, are mutually disjoint and also disjoint from \mathcal{D} . The copy of $([x_1], \dots, [x_n])$ in \mathcal{D}_i is denoted $([x_1]^i, \dots, [x_n]^i)$. Let $\mathcal{D}' = \mathcal{D}^{+A} \cup \bigcup_{i \in I} \mathcal{D}_i$ and set

$$P = \{([x_1]^i, \dots, [x_n]^i) \mid i \in I\}, \quad N = \{\vec{a}\}.$$

Consider the labeled KB (\mathcal{K}', P, N) for $\mathcal{K}' = (\mathcal{O}_{|A}, \mathcal{D}')$. (Intuitively, the reason for replacing \mathcal{O} by $\mathcal{O}_{|A}$ is that we do not want the new database assertions in $\bigcup_{i \in I} \mathcal{D}_i$ to interfere with what is entailed at \vec{a} . For example, $(\mathcal{O}, \mathcal{D}')$ could be unsatisfiable.) We show that (\mathcal{K}', P, N) is UCQ-separable iff $\mathcal{K} \not\models q(\vec{a})$. By Theorem 8, (\mathcal{K}', P, N) is UCQ-separable iff $\mathcal{K}' \not\models q(\vec{a})$. Hence we have to show that $\mathcal{K} \models q(\vec{a})$ iff $\mathcal{K}' \models q(\vec{a})$. The direction from left to right follows from the condition that $\mathcal{O}_{|A}$ is a relativization of \mathcal{O} . Conversely, assume that $\mathcal{K} \not\models q(\vec{a})$. Take a model \mathfrak{A} of \mathcal{K} with $\mathfrak{A} \not\models q(\vec{a})$. We may assume that $A^{\mathfrak{A}} = \text{dom}(\mathfrak{A})$. We expand \mathfrak{A} to a model \mathfrak{A}' of \mathcal{K}' by taking the disjoint union of \mathfrak{A} with \mathcal{D}' (regarded as a structure). Using the condition that q is rooted it now follows directly that $\mathfrak{A}' \not\models q(\vec{a})$. Hence $\mathcal{K}' \not\models q(\vec{a})$. \square

Since rooted UCQ-evaluation on FO-KBs is undecidable, so is (FO, FO)-separability. However, for GNFO we obtain the following result from GNFO \supseteq UCQ.

Corollary 14. *For all FO-fragments $\mathcal{L}_S \supseteq \text{UCQ}$:*

1. *(GNFO, GNFO)-separability, (GNFO, \mathcal{L}_S)-separability, and projective (GNFO, \mathcal{L}_S)-separability coincide. The same is true for definability.*
2. *(GNFO, \mathcal{L}_S)-separability and (GNFO, \mathcal{L}_S)-definability are 2EXPTIME-complete in combined complexity.*

Points 1 and 2 also hold for RE-existence and entity distinguishability, for all FO-fragments $\mathcal{L}_S \supseteq \text{CQ}$.

Proof. It is known that UCQ-evaluation on GNFO-KBs is decidable in 2ExpTime in combined complexity [55]. This implies the 2ExpTime upper bound in combined complexity. 2ExpTime -hardness in combined complexity can be shown by a polynomial time reduction of satisfiability (in a model \mathfrak{A} with $|\text{dom}(\mathfrak{A})| \geq 2$) of GNFO-sentences which is also 2ExpTime -hard [55]. To show the reduction observe that a GNFO-sentence φ is satisfiable in a model \mathfrak{A} with $|\text{dom}(\mathfrak{A})| \geq 2$ iff the labeled KB $(\mathcal{K}, \{a\}, \{b\})$ is (projectively and, equivalently, non-projectively) separable in any FO-fragment $\mathcal{L}_S \supseteq \text{CQ}$, where $\mathcal{K} = (\mathcal{O}, \mathcal{D})$, $\mathcal{O} = \{\varphi\}$ and $\mathcal{D} = \{P(a), N(b)\}$ with P, N fresh unary relation symbols. Observe that the labeled KB $(\mathcal{K}, \{a\}, \{b\})$ can be used to also prove the lower bound for definability, RE-existence, and entity distinguishability. \square

It follows from Theorems 19 and 20 below that $(\mathcal{ALCI}, \mathcal{L}_S)$ -separability is NExpTime -complete in data complexity, for all FO-fragments $\mathcal{L}_S \supseteq \text{UCQ}$. Hence, $(\text{GNFO}, \mathcal{L}_S)$ -separability is NExpTime -hard in data complexity, for all such \mathcal{L}_S . We conjecture that it is even 2ExpTime -hard in data complexity, see Appendix A for further discussion. The data complexity of RE-existence and entity distinguishability remains open.

We briefly discuss the case of FO-separability of labeled KBs in which the ontology is empty. From the connection to rooted UCQ-evaluation, it is immediate that this problem is in coNP since evaluating CQs on databases is NP-complete [51].

Theorem 15. *(FO, FO)-separability on labeled KBs with empty ontology is coNP -complete. This is also true for definability, RE-existence, and entity distinguishability.*

Proof. It remains to prove the lower bounds. For separability and entity distinguishability the lower bound follows directly from Corollary 13 and the fact that rooted CQ-evaluation on databases is NP-hard [51]. It remains to prove the coNP -lower bound for RE-existence (the lower bound for definability follows). The proof is by a polynomial time reduction of the problem whether there does not exist a homomorphism from a connected database \mathcal{D}_1 to a connected database \mathcal{D}_2 (in symbols, $\mathcal{D}_1 \not\rightarrow \mathcal{D}_2$) which is coNP -hard. Assume \mathcal{D}_1 and \mathcal{D}_2 are given. We may assume that $\text{cons}(\mathcal{D}_1) \cap \text{cons}(\mathcal{D}_2) = \emptyset$. Take a constant a in \mathcal{D}_1 and a constant b in \mathcal{D}_2 and let $\mathcal{D}'_1 = \mathcal{D}_1 \cup \{A(a)\}$ and $\mathcal{D}'_2 = \mathcal{D}_2 \cup \{A(c) \mid c \in \text{cons}(\mathcal{D}_2)\}$ for a fresh unary relation A . Then $\mathcal{D}_1 \not\rightarrow \mathcal{D}_2$ iff $\mathcal{D}'_1, a \not\rightarrow \mathcal{D}'_1 \cup \mathcal{D}'_2, b$ for any $b \in N := \text{cons}(\mathcal{D}_1 \cup \mathcal{D}_2) \setminus \{a\}$. Let $\mathcal{K} = (\emptyset, \mathcal{D}'_1 \cup \mathcal{D}'_2)$. Then the latter problem is equivalent to FO-separability of $(\mathcal{K}, \{a\}, N)$, by Theorem 8. \square

This result is in contrast to GI-completeness of the FO-definability problem on closed world structures in which one asks for a finite structure \mathfrak{A} and set P of tuples in $\text{dom}(\mathfrak{A})^n$ whether there exists an FO-formula $\varphi(\vec{x})$ that defines P in the sense that $P = \{\vec{a} \in \text{dom}(\mathfrak{A})^n \mid \mathfrak{A} \models \varphi(\vec{a})\}$ [35].

5. Weak Separability for Decidable Fragments of FO

We study $(\mathcal{L}, \mathcal{L})$ -separability for $\mathcal{L} \in \{\mathcal{ALCI}, \text{GF}, \text{FO}^2\}$. None of these fragments \mathcal{L} contains UCQ (or even CQ), and thus we cannot use Theorem 8 in the same way as for GNFO above. We also investigate the special cases of definability, referring expression existence, and entity distinguishability.

5.1. Separability of Labeled \mathcal{ALCI} -KBs

We are interested in separating labeled \mathcal{ALCI} -KBs (\mathcal{K}, P, N) in terms of \mathcal{ALCI} -concepts which is relevant for concept learning, for generating referring expressions, and for entity comparison. Note that since \mathcal{ALCI} -concepts are FO-formulas with one free variable, positive and negative examples are single constants rather than proper tuples.

We start by considering projective $(\mathcal{ALCI}, \mathcal{ALCI})$ -separability and show that Point 3 of Theorem 8 also characterizes projective \mathcal{ALCI} -separability of labeled \mathcal{ALCI} -KBs. This has profound consequences. For example, it follows that $(\mathcal{ALCI}, \text{FO})$ -separability coincides with projective $(\mathcal{ALCI}, \mathcal{ALCI})$ -separability and that projective $(\mathcal{ALCI}, \mathcal{ALCI})$ -separability can be decided using rooted UCQ-evaluation on \mathcal{ALCI} -KBs. To prove the characterization we require an intermediate step in which we characterize projective $(\mathcal{ALCI}, \mathcal{ALCI})$ -separability using a suitable version of functional bisimulations. We start by introducing bisimulations for \mathcal{ALCI} [67, 68]. Let \mathfrak{A} and \mathfrak{B} be structures and Σ a signature of concept and role names. A relation $S \subseteq \text{dom}(\mathfrak{A}) \times \text{dom}(\mathfrak{B})$ is an $\mathcal{ALCI}(\Sigma)$ -bisimulation between \mathfrak{A} and \mathfrak{B} if the following conditions hold:

1. if $(d, e) \in S$ and $A \in \Sigma$, then $d \in A^{\mathfrak{A}}$ iff $e \in A^{\mathfrak{B}}$;

2. if $(d, e) \in S$, R is a Σ -role, and $(d, d') \in R^{\mathfrak{A}}$, then there is an e' with $(e, e') \in R^{\mathfrak{B}}$ and $(d', e') \in S$;
3. if $(d, e) \in S$, R is a Σ -role, and $(e, e') \in R^{\mathfrak{B}}$, then there is a d' with $(d, d') \in R^{\mathfrak{A}}$ and $(d', e') \in S$.

We write $\mathfrak{A}, d \sim_{\mathcal{ALCI}(\Sigma)} \mathfrak{B}, e$ and call pointed structures \mathfrak{A}, d and \mathfrak{B}, e $\mathcal{ALCI}(\Sigma)$ -bisimilar if there exists an $\mathcal{ALCI}(\Sigma)$ -bisimulation S between \mathfrak{A} and \mathfrak{B} such that $(d, e) \in S$. We say that \mathfrak{A}, d and \mathfrak{B}, e are $\mathcal{ALCI}(\Sigma)$ -equivalent, in symbols $\mathfrak{A}, d \equiv_{\mathcal{ALCI}(\Sigma)} \mathfrak{B}, e$, if $d \in C^{\mathfrak{A}}$ iff $e \in C^{\mathfrak{B}}$ for all $\mathcal{ALCI}(\Sigma)$ -concepts C . $\mathcal{ALCI}(\Sigma)$ -bisimilarity implies $\mathcal{ALCI}(\Sigma)$ -equivalence. The converse direction does not always hold, but it holds if at least one structure has finite outdegree [67]. We apply the following lemma mainly to finite structures (which trivially have finite outdegree).

Lemma 16. *Let \mathfrak{A}, d and \mathfrak{B}, e be pointed structures, assume that \mathfrak{A} has finite outdegree, and let Σ be a signature. Then*

$$\mathfrak{A}, d \equiv_{\mathcal{ALCI}(\Sigma)} \mathfrak{B}, e \quad \text{iff} \quad \mathfrak{A}, d \sim_{\mathcal{ALCI}(\Sigma)} \mathfrak{B}, e.$$

For the “if” direction, the condition “ \mathfrak{A} has finite outdegree” can be dropped.

To characterize projective separability we require a functional version of $\mathcal{ALCI}(\Sigma)$ -bisimilarity. In detail, we write $\mathfrak{A}, d \sim_{\mathcal{ALCI}(\Sigma)}^f \mathfrak{B}, e$ if there exists an $\mathcal{ALCI}(\Sigma)$ -bisimulation S between \mathfrak{A} and \mathfrak{B} that contains (d, e) and is *functional*, that is, $(a, b_1), (a, b_2) \in S$ implies $b_1 = b_2$ for all $a \in \text{dom}(\mathfrak{A})$ and $b_1, b_2 \in \text{dom}(\mathfrak{B})$. Note that $\mathfrak{A}, d \sim_{\mathcal{ALCI}(\Sigma)}^f \mathfrak{B}, e$ implies that there is a homomorphism from $\mathfrak{A}_{\text{con}(d)}, d$ to \mathfrak{B}, e , where $\mathfrak{A}_{\text{con}(d)}$ is the restriction of \mathfrak{A} to all nodes reachable from d (here we assume that $X^{\mathfrak{A}} = \emptyset$ for all concept and role names $X \notin \Sigma$ because otherwise one might reach nodes from d in \mathfrak{A} that are not relevant to $\mathcal{ALCI}(\Sigma)$ -bisimilarity of d and e).

Theorem 17. *Assume that $(\mathcal{K}, P, \{b\})$ is a labeled \mathcal{ALCI} -KB with $\mathcal{K} = (\mathcal{O}, \mathcal{D})$ and $\Sigma = \text{sig}(\mathcal{K})$. Then the following conditions are equivalent:*

1. $(\mathcal{K}, P, \{b\})$ is projectively \mathcal{ALCI} -separable;
2. there exists a finite model \mathfrak{A} of \mathcal{K} and a finite set Σ_{help} of concept names disjoint from $\text{sig}(\mathcal{K})$ such that for all models \mathfrak{B} of \mathcal{K} and all $a \in P$: $\mathfrak{B}, a^{\mathfrak{B}} \sim_{\mathcal{ALCI}(\Sigma \cup \Sigma_{\text{help}})} \mathfrak{A}, b^{\mathfrak{A}}$;
3. there exists a finite model \mathfrak{A} of \mathcal{K} such that for all models \mathfrak{B} of \mathcal{K} and all $a \in P$: $\mathfrak{B}, a^{\mathfrak{B}} \sim_{\mathcal{ALCI}(\Sigma)}^f \mathfrak{A}, b^{\mathfrak{A}}$;
4. there exists a finite model \mathfrak{A} of \mathcal{K} such that for all $a \in P$: $\mathcal{D}_{\text{con}(a)}, a \not\rightarrow \mathfrak{A}, b^{\mathfrak{A}}$;
5. there exists a model \mathfrak{A} of \mathcal{K} such that for all $a \in P$: $\mathcal{D}_{\text{con}(a)}, a \not\rightarrow \mathfrak{A}, b^{\mathfrak{A}}$.

Proof. “1. \Rightarrow 5.” If $(\mathcal{K}, P, \{b\})$ is projectively \mathcal{ALCI} -separable, then it is projectively FO-separable. It follows that Condition 3 of Theorem 8 holds which is identical to Condition 5.

“2. \Rightarrow 1.” Assume Condition 2 holds for \mathfrak{A} and Σ_{help} . Let $t_{\mathfrak{A}}(b) = \{C \in \mathcal{ALCI}(\Sigma \cup \Sigma_{\text{help}}) \mid b^{\mathfrak{A}} \in C^{\mathfrak{A}}\}$. It follows from Lemma 16 that $\mathcal{K} \cup \{C(a) \mid C \in t_{\mathfrak{A}}(b)\}$ is not satisfiable, for any $a \in P$. (This can be seen as follows: assume there exists $a \in P$ and a model \mathfrak{B} of \mathcal{K} such that $a^{\mathfrak{B}} \in C^{\mathfrak{B}}$ for all $C \in t_{\mathfrak{A}}(b)$. Then $\mathfrak{B}, a^{\mathfrak{B}} \equiv_{\mathcal{ALCI}(\Sigma \cup \Sigma_{\text{help}})} \mathfrak{A}, b^{\mathfrak{A}}$. By Lemma 16, $\mathfrak{B}, a^{\mathfrak{B}} \sim_{\mathcal{ALCI}(\Sigma \cup \Sigma_{\text{help}})} \mathfrak{A}, b^{\mathfrak{A}}$ which contradicts Condition 2.) By compactness (and closure under conjunction of $t_{\mathfrak{A}}(b)$) we find for every $a \in P$ a concept $C_a \in t_{\mathfrak{A}}(b)$ such that $\mathcal{K} \models \neg C_a(a)$. Thus, the concept $\neg(\bigwedge_{a \in P} C_a)$ separates $(\mathcal{K}, P, \{b\})$, as required.

“3. \Rightarrow 2.” Take a model \mathfrak{A} of \mathcal{K} such that Condition 3 holds. We may assume that \mathfrak{A} only interprets the symbols in $\text{sig}(\mathcal{K})$. Define \mathfrak{A}' by expanding \mathfrak{A} as follows. Take for any $d \in \text{dom}(\mathfrak{A})$ a fresh concept name A_d and set $A_d^{\mathfrak{A}'} = \{d\}$. Then Condition 2 holds for \mathfrak{A}' and $\Sigma_{\text{help}} = \{A_d \mid d \in \text{dom}(\mathfrak{A}')\}$.

“4. \Rightarrow 3.” Take a model \mathfrak{A} of \mathcal{K} such that Condition 4 holds. As every functional bisimulation between any model \mathfrak{B} of \mathcal{K} and \mathfrak{A} witnessing $\mathfrak{B}, a^{\mathfrak{B}} \sim_{\mathcal{ALCI}(\Sigma)}^f \mathfrak{A}, b^{\mathfrak{A}}$ induces a homomorphism from $\mathcal{D}_{\text{con}(a)}$ to \mathfrak{A} mapping a to $b^{\mathfrak{A}}$, it follows that \mathfrak{A} satisfies Condition 3.

“5. \Rightarrow 4.” This follows from the fact that rooted UCQ-evaluation on \mathcal{ALCI} -KBs is finitely controllable. \square

The following example illustrates the characterization given in Theorem 17 by applying it to Examples 4 and 5.

Example 18. Consider the KB $\mathcal{K}_2 = (\mathcal{O}_2, \mathcal{D}_1)$ introduced in Examples 4 and 5. We know already that $(\mathcal{K}_2, \{a\}, \{b\})$ is \mathcal{ALCI} -separable. The structure \mathfrak{A} of Condition 2 in Theorem 17 can be used to construct a separating concept following the proof of “2. \Rightarrow 1.”. For example, obtain a model \mathfrak{A} of \mathcal{K}_2 from \mathcal{D}_1 by adding $\text{Person}(b)$. Then there does not exist a model \mathfrak{B} of \mathcal{K}_2 such that $\mathfrak{B}, a^{\mathfrak{B}} \sim_{\mathcal{ALCI}, \text{sig}(\mathcal{K}_2)} \mathfrak{A}, b^{\mathfrak{A}}$. Thus we have found a structure witnessing Condition 2 with $\Sigma_{\text{help}} = \emptyset$. Now $t_{\mathfrak{A}}(b)$ contains a concept C such that $\neg C$ separates $(\mathcal{K}_2, \{a\}, \{b\})$. An example of such a concept in $t_{\mathfrak{A}}(b)$ is $C = \forall \text{born.in.} \neg \exists \text{citizen.of.} \top$. Then $\neg C$ separates $(\mathcal{K}_2, \{a\}, \{b\})$ since $\mathcal{K}_2 \models \neg C(a)$. \blacktriangle

It follows from Theorem 17 that Point 3 of Theorem 8 also characterizes projective $(\mathcal{ALCI}, \mathcal{ALCI})$ -separability. This leads to the following result.

Theorem 19. *For any FO-fragment $\mathcal{L}_S \supseteq \text{UCQ}$:*

1. *projective $(\mathcal{ALCI}, \mathcal{ALCI})$ -separability coincides with $(\mathcal{ALCI}, \mathcal{L}_S)$ -separability, and the same is true for definability;*
2. *projective $(\mathcal{ALCI}, \mathcal{ALCI})$ -separability and projective $(\mathcal{ALCI}, \mathcal{ALCI})$ -definability are NExpTime -complete.*

This holds also for RE-existence and entity distinguishability, for all FO-fragments $\mathcal{L}_S \supseteq \text{CQ}$.

Proof. It remains to prove the complexity result. The NExpTime upper bound follows from the fact that rooted UCQ-evaluation on \mathcal{ALCI} -KBs is in coNExpTime [69, 70]. For the lower bound we first consider entity distinguishability. It is shown in [69, 70] that unary rooted CQ-evaluation on \mathcal{ALCI} -KBs with a single constant is coNExpTime -hard in combined complexity. Then the proof of Corollary 13 shows that projective $(\mathcal{ALCI}, \mathcal{ALCI})$ -entity distinguishability is NExpTime -hard. It remains to prove NExpTime -hardness of projective $(\mathcal{ALCI}, \mathcal{ALCI})$ -RE existence, as then hardness of projective $(\mathcal{ALCI}, \mathcal{ALCI})$ -definability follows. We show this by a polynomial time reduction of projective $(\mathcal{ALCI}, \mathcal{ALCI})$ -entity distinguishability. Assume a labeled KB $(\mathcal{K}, \{a\}, \{b\})$ with $\mathcal{K} = (\mathcal{O}, \mathcal{D})$ is given. We may assume that $\text{cons}(\mathcal{D}_{\text{con}(a)}) \cap \text{cons}(\mathcal{D}_{\text{con}(b)}) = \emptyset$. (To show this, let \mathcal{D}' be a copy of \mathcal{D} using a set of constants disjoint from $\text{cons}(\mathcal{D})$. We show that $(\mathcal{O}, \mathcal{D}) \models C(a)$ iff $(\mathcal{O}, \mathcal{D} \cup \mathcal{D}') \models C(a)$, for every \mathcal{ALCI} -concept C . The implication from left to right follows from $\mathcal{D} \subseteq \mathcal{D} \cup \mathcal{D}'$ and the converse implication can be proved by extending any model \mathfrak{A} of \mathcal{K} to a model of $(\mathcal{O}, \mathcal{D} \cup \mathcal{D}')$ by setting $c'^{\mathfrak{A}} = c^{\mathfrak{A}}$ for the copy c' of $c \in \text{cons}(\mathcal{D})$ in \mathcal{D}' . Now the claim follows by replacing \mathcal{D} by $\mathcal{D} \cup \mathcal{D}'$, with b and b' swapped.) Let $\mathcal{D}' = \mathcal{D} \cup \{A(a), A(b)\}$ for a fresh concept name A and let $N = \text{cons}(\mathcal{D}) \setminus \{a\}$. Then $(\mathcal{K}, \{a\}, \{b\})$ is projectively $(\mathcal{ALCI}, \mathcal{ALCI})$ -separable iff $(\mathcal{K}, \{a\}, \{b\})$ is UCQ-separable iff $((\mathcal{O}, \mathcal{D}'), \{a\}, N)$ is UCQ-separable iff $((\mathcal{O}, \mathcal{D}'), \{a\}, N)$ is projectively $(\mathcal{ALCI}, \mathcal{ALCI})$ -separable, as required for the reduction. \square

We next determine the data complexity of projective $(\mathcal{ALCI}, \mathcal{ALCI})$ -separability and projective $(\mathcal{ALCI}, \mathcal{ALCI})$ -definability. Quite remarkably, it turns out to be identical to the combined complexity, namely NExpTime -complete.

Theorem 20. *Projective $(\mathcal{ALCI}, \mathcal{ALCI})$ -separability and projective $(\mathcal{ALCI}, \mathcal{ALCI})$ -definability are NExpTime -complete in data complexity.*

Proof. The upper bound follows from the NExpTime upper bound for the same problems in combined complexity. For the lower bound for separability, it follows from the proof of Corollary 13 that it suffices to construct an \mathcal{ALCI} -ontology \mathcal{O} such that it is coNExpTime -hard to decide unary rooted UCQ-evaluation on KBs with ontology \mathcal{O} . The construction of such an ontology \mathcal{O} and in particular of the rooted UCQs that demonstrate coNExpTime -hardness is quite tedious, we present details in the appendix. To show the lower bound for definability, we show that for a fixed \mathcal{ALCI} -ontology \mathcal{O} , projective \mathcal{ALCI} -separability of labeled KBs with ontology \mathcal{O} can be reduced in polynomial time to projective \mathcal{ALCI} -definability for KBs with ontology \mathcal{O} . We use the same technique as in the reduction of entity distinguishability in the proof of Theorem 19 above. Assume a labeled \mathcal{ALCI} -KB (\mathcal{K}, P, N) with $\mathcal{K} = (\mathcal{O}, \mathcal{D})$ is given. We may assume that $\text{cons}(\mathcal{D}_{\text{con}(a)}) \cap \text{cons}(\mathcal{D}_{\text{con}(b)}) = \emptyset$, for any distinct $a, b \in P \cup N$ (see the proof of Theorem 19). Let $\mathcal{D}' = \mathcal{D} \cup \{A(a) \mid a \in P \cup N\}$ for a fresh concept name A and let $N' = \text{cons}(\mathcal{D}) \setminus P$. Then (\mathcal{K}, P, N) is projectively $(\mathcal{ALCI}, \mathcal{ALCI})$ -separable iff (\mathcal{K}, P, N) is UCQ-separable iff $((\mathcal{O}, \mathcal{D}'), P, N')$ is UCQ-separable iff $((\mathcal{O}, \mathcal{D}'), P, N')$ is projectively $(\mathcal{ALCI}, \mathcal{ALCI})$ -separable, as required for the reduction. \square

It remains open whether the NEXPTIME lower bound of Theorem 20 also holds for RE-existence and entity distinguishability.

We now turn to non-projective separability. We first observe that projective and non-projective separability are indeed different. We use a simplified variant of Example 2 we are going to revisit throughout this article.

Example 21. Let $\mathcal{K}_3 = (\mathcal{O}_3, \mathcal{D}_3)$ be the \mathcal{ALCI} -KB where $\mathcal{O}_3 = \{\top \sqsubseteq \exists R. \top \sqcap \exists R^- . \top\}$ and $\mathcal{D}_3 = \{R(a, a), R(b, c), R(c, b)\}$. Further let $P = \{a\}$ and $N = \{b\}$. Then the \mathcal{ALCI} -concept $A \rightarrow \exists R.A$ separates (\mathcal{K}_3, P, N) using the concept name A as a helper symbol. Thus (\mathcal{K}_3, P, N) is projectively \mathcal{ALCI} -separable. Projective \mathcal{ALCI} -separability can also be shown using Theorem 17 by observing that the structure \mathfrak{A} corresponding to \mathcal{D}_3 is a model of \mathcal{O}_3 and that $\mathcal{D}_{3_{\text{con}(a)}, a \mapsto \mathfrak{A}, b^{\mathfrak{A}}}$ as $(b, b) \notin R^{\mathfrak{A}}$.

In contrast, (\mathcal{K}_3, P, N) is not non-projectively \mathcal{ALCI} -separable. In fact, every \mathcal{ALCI} -concept C with $\text{sig}(C) = \{R\}$ is equivalent to \top or to \perp w.r.t. \mathcal{O} . Thus if $\mathcal{K}_3 \models C(a)$, then $\mathcal{O}_3 \models C \equiv \top$, and so $\mathcal{K}_3 \models C(b)$.

It is also instructive to consider an ontology that is weaker than \mathcal{O}_3 . For example, let $\mathcal{K}_4 = (\emptyset, \mathcal{D}_3)$. Then (\mathcal{K}_4, P, N) is non-projectively \mathcal{ALCI} -separable. This is witnessed, for example, by the concept $C = \exists R. \forall R. \perp \rightarrow \exists R. \exists R. \forall R. \perp$ (which is obtained from $A \rightarrow \exists R.A$ by replacing A by $\exists R. \forall R. \perp$) since $\mathcal{K}_4 \models C(a)$ but $\mathcal{K}_4 \not\models C(b)$. \blacktriangle

Of course, Example 21 implies that an analogue of Point 1 of Theorem 19 fails for non-projective separability. In fact, the labeled \mathcal{ALCI} -KB (\mathcal{K}_3, P, N) in Example 21 is not non-projectively \mathcal{ALCI} -separable but is separated by the CQ $R(x, x)$.

We next aim to characterize non-projective ($\mathcal{ALCI}, \mathcal{ALCI}$)-separability in the style of Point 3 of Theorem 8. We start with noting that the ontology \mathcal{O}_3 used in Example 21 is very strong and enforces that all elements of all models of \mathcal{O}_3 are $\mathcal{ALCI}(\text{sig}(\mathcal{K}_3))$ -equivalent to each other. For ontologies that make such strong statements, symbols from outside of $\text{sig}(\mathcal{K})$ might be required to construct a separating concept. It turns out that this is in fact the only effect that distinguishes non-projective from projective separability. We next make this precise.

For a KB \mathcal{K} , we use $\text{cl}(\mathcal{K})$ to denote the set of concepts in \mathcal{K} and the concepts $\exists R. \top$ and $\exists R^- . \top$ for all role names $R \in \text{sig}(\mathcal{K})$, closed under subconcepts and single negation. A \mathcal{K} -type is a set $t \subseteq \text{cl}(\mathcal{K})$ such that there exists a model \mathfrak{A} of \mathcal{K} and an $a \in \text{dom}(\mathfrak{A})$ with $\text{tp}_{\mathcal{K}}(\mathfrak{A}, a) = t$ where

$$\text{tp}_{\mathcal{K}}(\mathfrak{A}, a) = \{C \in \text{cl}(\mathcal{K}) \mid a \in C^{\mathfrak{A}}\}$$

is the \mathcal{K} -type of a in \mathfrak{A} . Conversely, a \mathcal{K} -type t is *realizable in \mathcal{K}* , b , where $\mathcal{K} = (\mathcal{O}, \mathcal{D})$ and $b \in \text{cons}(\mathcal{D})$, if there exists a model \mathfrak{A} of \mathcal{K} such that $\text{tp}_{\mathcal{K}}(\mathfrak{A}, b^{\mathfrak{A}}) = t$. We often identify a \mathcal{K} -type with the conjunction over all its concepts and thus write, for example, $\exists R.t$ for the concept $\exists R. (\bigwedge_{C \in t} C)$.

Finally, we need the notion of *complete* types which is similar in spirit to the notion of a complete theory in classical logic [60].

Definition 22. A \mathcal{K} -type t is \mathcal{ALCI} -complete for \mathcal{K} if for any two pointed models \mathfrak{A}_1, b_1 and \mathfrak{A}_2, b_2 of \mathcal{K} , $t = \text{tp}_{\mathcal{K}}(\mathfrak{A}_1, b_1) = \text{tp}_{\mathcal{K}}(\mathfrak{A}_2, b_2)$ implies $\mathfrak{A}_1, b_1 \equiv_{\mathcal{ALCI}, \text{sig}(\mathcal{K})} \mathfrak{A}_2, b_2$.

We next illustrate the basic notions.

Example 23. (1) In the KB \mathcal{K}_3 from Example 21, there is only a single \mathcal{K}_3 -type, $t_0 = \{\top, \exists R. \top, \exists R^- . \top, \exists R. \top \sqcap \exists R^- . \top\}$, and this type is \mathcal{ALCI} -complete for \mathcal{K}_3 .

(2) In the KB \mathcal{K}_4 from Example 21, there are four different \mathcal{K}_4 -types, determined by any combination of (negated) $\exists R. \top$ and $\exists R^- . \top$. The type $t_1 = \{\top, \neg \exists R. \top, \neg \exists R^- . \top, \neg(\exists R. \top \sqcap \exists R^- . \top)\}$ is the only type that is \mathcal{ALCI} -complete for \mathcal{K}_4 .

(3) Let \mathcal{K} be any KB not using any role names. Then every \mathcal{K} -type is \mathcal{ALCI} -complete for \mathcal{K} .

(4) Let \mathcal{D} be a database and $\Sigma = \text{sig}(\mathcal{D})$. Let $\mathcal{O}_{\mathcal{D}}$ be the ontology that contains all $\mathcal{ALCI}(\Sigma)$ -CIs that are true in the structure $\mathfrak{A}_{\mathcal{D}}$ defined by \mathcal{D} . This ontology is infinite, but easily seen to be logically equivalent to a finite ontology: define an equivalence relation \sim on $\text{cons}(\mathcal{D})$ by setting $a \sim b$ if $\mathfrak{A}_{\mathcal{D}}, a \sim_{\mathcal{ALCI}, \Sigma} \mathfrak{A}_{\mathcal{D}}, b$, and denote by $[a]$ the equivalence class of a . Then we find \mathcal{ALCI} -concepts $C_{[a]}, a \in \text{cons}(\mathfrak{A})$, such that $a \in C_{[a]}^{\mathfrak{A}_{\mathcal{D}}}$ but $b \notin C_{[a]}^{\mathfrak{A}_{\mathcal{D}}}$ for any $b \sim a$. We may assume that A or its negation are a conjunct of $C_{[a]}$, for any concept name $A \in \Sigma$. Then $\mathcal{O}_{\mathcal{D}}$ is axiomatized by taking the CI $\top \sqsubseteq \bigsqcup_{a \in \text{cons}(\mathcal{D})} C_{[a]}$, every CI $C_{[a]} \sqsubseteq \exists R. C_{[b]}$ with $b \in R[a]$, and every CI $C_{[a]} \sqsubseteq \forall R. \bigsqcup_{b \in R[a]} C_{[b]}$, where $R[a]$

is the set of b such that $R(c, b) \in \mathcal{D}$ for some $c \in [a]$. Let $\mathcal{K}_{\mathcal{D}} = (\mathcal{O}_{\mathcal{D}}, \mathcal{D})$. Then every $\mathcal{K}_{\mathcal{D}}$ -type is \mathcal{ALCI} -complete for $\mathcal{K}_{\mathcal{D}}$. Intuitively, if we assume that the database \mathcal{D} is complete in the sense that any ground atom $R(\vec{a})$ with $R \in \Sigma$ that is not in \mathcal{D} is false then $\mathcal{O}_{\mathcal{D}}$ is the logically strongest \mathcal{ALCI} -ontology representing this assumption. \blacktriangle

Observe that the types under Points (2) and (3) are \mathcal{ALCI} -complete simply because nodes that satisfy them cannot be connected to any other node via roles in $\text{sig}(\mathcal{K})$ in any model of the respective KBs. We say that a \mathcal{K} -type t is *disconnected* if $\neg\exists R.\top \in t$ for all $\text{sig}(\mathcal{K})$ -roles R and *connected* otherwise. The \mathcal{K} -types under Points (2) and (3) are disconnected. We are now in a position to formulate the characterization of non-projective (\mathcal{ALCI} , \mathcal{ALCI})-separability.

Theorem 24. *Assume that $(\mathcal{K}, P, \{b\})$ is a labeled \mathcal{ALCI} -KB with $\mathcal{K} = (\mathcal{O}, \mathcal{D})$ and $\Sigma = \text{sig}(\mathcal{K})$. Then the following conditions are equivalent:*

1. $(\mathcal{K}, P, \{b\})$ is non-projectively \mathcal{ALCI} -separable;
2. there exists a finite model \mathfrak{A} of \mathcal{K} of such that for all models \mathfrak{B} of \mathcal{K} and all $a \in P$: $\mathfrak{B}, a^{\mathfrak{B}} \sim_{\mathcal{ALCI}, \Sigma} \mathfrak{A}, b^{\mathfrak{A}}$;
3. there exists a finite model \mathfrak{A} of \mathcal{K} such that for all $a \in P$:
 - (a) $\mathcal{D}_{\text{con}(a)}, a \not\rightarrow \mathfrak{A}, b^{\mathfrak{A}}$ and
 - (b) if $\text{tp}_{\mathcal{K}}(\mathfrak{A}, b^{\mathfrak{A}})$ is connected and \mathcal{ALCI} -complete for \mathcal{K} , then $\text{tp}_{\mathcal{K}}(\mathfrak{A}, b^{\mathfrak{A}})$ is not realizable in \mathcal{K}, a .

Before proving Theorem 24 we make a few observations and illustrate the result by examples. Note that Point 2 of Theorem 24 coincides with Point 2 of Theorem 17 characterizing projective (\mathcal{ALCI} , \mathcal{ALCI})-separability except that $\Sigma_{\text{help}} = \emptyset$. This should be intuitively clear and the proof of “1. \Leftrightarrow 2.” here is essentially the same as the proof in Theorem 17. Point 3 (a) of Theorem 24 coincides with Point 4 of Theorem 17. It follows that Point 3 strengthens Point 4 of Theorem 17 by (b). The following example illustrates Point 3 (b).

Example 25. Consider the KB \mathcal{K}_3 from Example 21. We know that $(\mathcal{K}_3, \{a\}, \{b\})$ is not \mathcal{ALCI} -separable and aim to confirm this using Point 3 of Theorem 24. Let \mathfrak{A} be any finite model of \mathcal{K}_3 and assume that $\mathcal{D}_{3, \text{con}(a)}, a \not\rightarrow \mathfrak{A}, b^{\mathfrak{A}}$. As $t_0 = \{\top, \exists R.\top, \exists R^{\neg}.\top, \exists R.\top \sqcap \exists R^{\neg}.\top\}$ is the only \mathcal{K}_3 -type we have that $\text{tp}_{\mathcal{K}_3}(\mathfrak{A}, b^{\mathfrak{A}}) = t_0$. Thus, $\text{tp}_{\mathcal{K}_3}(\mathfrak{A}, b^{\mathfrak{A}})$ is connected and \mathcal{ALCI} -complete for \mathcal{K}_3 . But then $\text{tp}_{\mathcal{K}_3}(\mathfrak{A}, b^{\mathfrak{A}})$ is also realizable in \mathcal{K}, a , and so (b) is refuted for \mathfrak{A} .

Consider the KB \mathcal{K}_4 from Example 21. We know that $(\mathcal{K}_4, \{a\}, \{b\})$ is \mathcal{ALCI} -separable and confirm this using Point 3 of Theorem 24. Let \mathfrak{A} be the structure defined by \mathcal{D}_3 . Then (a) holds since $\mathcal{D}_{3, \text{con}(a)}, a \not\rightarrow \mathfrak{A}, b^{\mathfrak{A}}$ which follows from $\mathfrak{A} \not\models R(b, b)$. Condition (b) also holds since $\text{tp}_{\mathcal{K}_4}(\mathfrak{A}, b^{\mathfrak{A}}) = t_0$ is not \mathcal{ALCI} -complete for \mathcal{K}_4 . \blacktriangle

Proof of Theorem 24. “1. \Rightarrow 2.” Let C be an $\mathcal{ALCI}(\Sigma)$ -concept such that $\mathcal{K} \models C(a)$ for all $a \in P$ but $\mathcal{K} \not\models C(b)$. By the finite model property of \mathcal{ALCI} (Section 3) there exists a finite model \mathfrak{A} of \mathcal{K} such that $b^{\mathfrak{A}} \notin C^{\mathfrak{A}}$. Then for all models \mathfrak{B} of \mathcal{K} and all $a \in P$: $\mathfrak{B}, a^{\mathfrak{B}} \not\equiv_{\mathcal{ALCI}, \Sigma} \mathfrak{A}, b^{\mathfrak{A}}$ since otherwise $\mathcal{K} \models C(a)$ for some $a \in P$. But then, by Lemma 16, $\mathfrak{B}, a^{\mathfrak{B}} \sim_{\mathcal{ALCI}, \Sigma} \mathfrak{A}, b^{\mathfrak{A}}$ for all $a \in P$, as required.

“2. \Rightarrow 1.” This is a special case of the proof of “2. \Rightarrow 1.” for Theorem 17.

“2. \Rightarrow 3.” Assume that \mathfrak{A} is a finite model of \mathcal{K} such that for all models \mathfrak{B} of \mathcal{K} and all $a \in P$: $\mathfrak{B}, a^{\mathfrak{B}} \sim_{\mathcal{ALCI}, \Sigma} \mathfrak{A}, b^{\mathfrak{A}}$. We know already from the proof of Theorem 17 that $\mathcal{D}_{\text{con}(a)}, a \not\rightarrow \mathfrak{A}, b^{\mathfrak{A}}$ for all $a \in P$. We show that (b) holds as well. Assume for a proof by contradiction that there is $a \in P$ such that $\text{tp}_{\mathcal{K}}(\mathfrak{A}, b^{\mathfrak{A}})$ is connected, \mathcal{ALCI} -complete for \mathcal{K} , and realizable in \mathcal{K}, a . Then take a model \mathfrak{B} of \mathcal{K} such that $\text{tp}_{\mathcal{K}}(\mathfrak{B}, a^{\mathfrak{B}}) = \text{tp}_{\mathcal{K}}(\mathfrak{A}, b^{\mathfrak{A}})$. Then $\mathfrak{B}, a^{\mathfrak{B}} \equiv_{\mathcal{ALCI}, \Sigma} \mathfrak{A}, b^{\mathfrak{A}}$ since $\text{tp}_{\mathcal{K}}(\mathfrak{A}, b^{\mathfrak{A}})$ is \mathcal{ALCI} -complete for \mathcal{K} . But then $\mathfrak{B}, a^{\mathfrak{B}} \sim_{\mathcal{ALCI}, \Sigma} \mathfrak{A}, b^{\mathfrak{A}}$, by Lemma 16, and we have derived a contradiction.

“3. \Rightarrow 2.” Assume that Condition 3 holds for \mathfrak{A} . If $\text{tp}_{\mathcal{K}}(\mathfrak{A}, b^{\mathfrak{A}})$ is connected and \mathcal{ALCI} -complete for \mathcal{K} , then by (b) $\text{tp}_{\mathcal{K}}(\mathfrak{A}, b^{\mathfrak{A}})$ is not realizable in \mathcal{K}, a for any $a \in P$. Thus, there is no model \mathfrak{B} of \mathcal{K} with $\mathfrak{B}, a^{\mathfrak{B}} \equiv_{\mathcal{ALCI}, \Sigma} \mathfrak{A}, b^{\mathfrak{A}}$, for any $a \in P$. By Lemma 16, there is no model \mathfrak{B} of \mathcal{K} such that $\mathfrak{B}, a^{\mathfrak{B}} \sim_{\mathcal{ALCI}, \Sigma} \mathfrak{A}, b^{\mathfrak{A}}$, for any $a \in P$, as required. Note that $\neg\text{tp}_{\mathcal{K}}(\mathfrak{A}, b^{\mathfrak{A}})$ separates $(\mathcal{K}, P, \{b\})$ in this case.

If $\text{tp}_{\mathcal{K}}(\mathfrak{A}, b^{\mathfrak{A}})$ is disconnected, then it follows from $\mathcal{D}_{\text{con}(a)}, a \not\rightarrow \mathfrak{A}, b^{\mathfrak{A}}$ that either there exists A with $A(a) \in \mathcal{D}$ and $b^{\mathfrak{A}} \notin A^{\mathfrak{A}}$ or there exists R with $R(a, c) \in \mathcal{D}$ for some c . In both cases $\text{tp}_{\mathcal{K}}(\mathfrak{A}, b^{\mathfrak{A}})$ is not realizable in \mathcal{K}, a , and the proof continues as above.

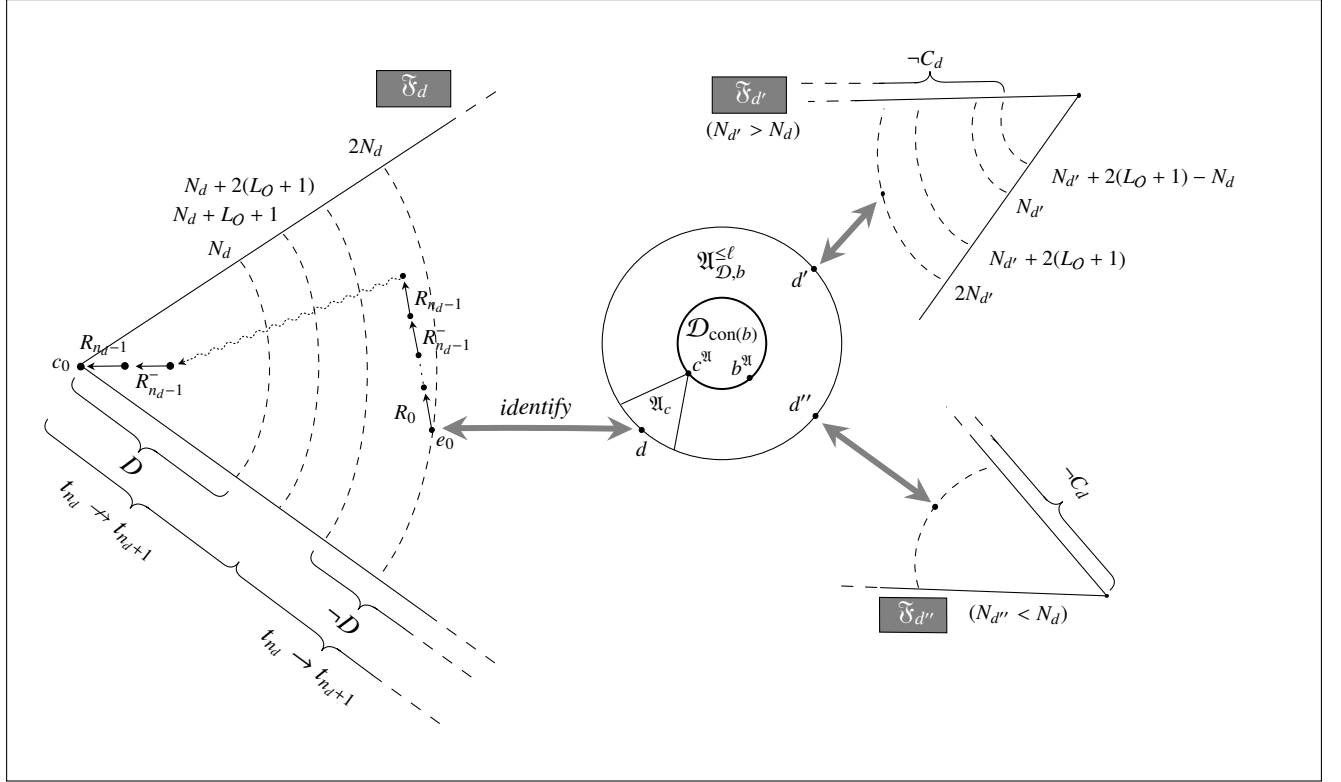

Figure 2: Construction of \mathfrak{C} .

Assume now that $\text{tp}_{\mathcal{K}}(\mathfrak{A}, b^{\mathfrak{A}})$ is connected and not \mathcal{ALCI} -complete for \mathcal{K} . For a model \mathfrak{C} of \mathcal{K} and $\ell \geq 0$ we denote by $\mathfrak{C}_{\mathcal{D},b}^{\leq \ell}$ the substructure of \mathfrak{C} induced by all nodes reachable from some $c^{\mathfrak{C}}$, $c \in \text{cons}(\mathcal{D}_{\text{con}(b)})$, in at most ℓ steps. We construct for any $\ell \geq 0$ a finite model \mathfrak{C} of \mathcal{K} such that

- (i) $\mathfrak{C}_{\mathcal{D},b}^{\leq \ell}, b^{\mathfrak{C}} \rightarrow \mathfrak{A}, b^{\mathfrak{A}}$;
- (ii) for any two distinct $d_1, d_2 \in \text{dom}(\mathfrak{C}_{\mathcal{D},b}^{\leq \ell})$: $\mathfrak{C}, d_1 \sim_{\mathcal{ALCI}, \Sigma} \mathfrak{C}, d_2$.

We first show that the implication “3. \Rightarrow 2.” is proved if such a \mathfrak{C} can be constructed.

Claim 1. If (i) and (ii) hold for some $\ell \geq |\mathcal{D}|$ for \mathfrak{C} and $\mathcal{D}_{\text{con}(a)}, a \rightarrow \mathfrak{A}, b^{\mathfrak{A}}$ for all $a \in P$, then Condition 2 holds for \mathfrak{C} .

Proof of Claim 1. The proof of Claim 1 is indirect. Assume that Condition 2 does not hold for \mathfrak{C} , that (i) holds for some $\ell \geq |\mathcal{D}|$, and $\mathcal{D}_{\text{con}(a)}, a \rightarrow \mathfrak{A}, b^{\mathfrak{A}}$ for all $a \in P$. We show that (ii) does not hold for ℓ and \mathfrak{C} . As we assume that Condition 2 does not hold for \mathfrak{C} , there exists $a \in P$ and a model \mathfrak{B} of \mathcal{K} and a bisimulation S witnessing $\mathfrak{B}, a^{\mathfrak{B}} \sim_{\mathcal{ALCI}, \Sigma} \mathfrak{C}, b^{\mathfrak{C}}$. As there is no homomorphism from $\mathcal{D}_{\text{con}(a)}$ to \mathfrak{A} mapping a to $b^{\mathfrak{A}}$, by Condition (i) there is no homomorphism from $\mathcal{D}_{\text{con}(a)}$ to $\mathfrak{C}_{\mathcal{D},b}^{\leq \ell}$ mapping a to $b^{\mathfrak{C}}$ (since the composition of homomorphisms is a homomorphism). As the bisimulation S induces a relation between $\text{cons}(\mathcal{D}_{\text{con}(a)})$ and $\text{dom}(\mathfrak{C}_{\mathcal{D},b}^{\leq \ell})$ with domain $\text{cons}(\mathcal{D}_{\text{con}(a)})$ that is a homomorphism if it is functional, there exist $e \in \text{cons}(\mathcal{D}_{\text{con}(a)})$ and $d_1, d_2 \in \text{dom}(\mathfrak{C}_{\mathcal{D},b}^{\leq \ell})$ with $d_1 \neq d_2$ and $(e, d_1), (e, d_2) \in S$. Then $\mathfrak{C}, d_1 \sim_{\mathcal{ALCI}, \Sigma} \mathfrak{C}, d_2$ (since the composition of bisimulations is a bisimulation). Hence Condition (ii) does not hold, as required. This finishes the proof of Claim 1.

We come to the construction of the model \mathfrak{C} of \mathcal{K} satisfying (i) and (ii). It is illustrated in Figure 2. To construct \mathfrak{C} we first provide a more constructive characterization of when a \mathcal{K} -type t is not \mathcal{ALCI} -complete for \mathcal{K} . By definition, this means that there are non- $\mathcal{ALCI}(\Sigma)$ -bisimilar pointed models of \mathcal{K} realizing t . We equivalently rephrase this in

terms of the existence of certain paths realizing types. Let R be a role. We say that \mathcal{K} -types t_1 and t_2 are R -coherent if there exists a model \mathfrak{A} of \mathcal{K} and nodes d_1 and d_2 realizing t_1 and t_2 , respectively, such that $(d_1, d_2) \in R^{\mathfrak{A}}$. We write $t_1 \rightsquigarrow_R t_2$ in this case. A sequence

$$\sigma = t_0 R_0 \dots R_n t_{n+1}$$

of \mathcal{K} -types t_0, \dots, t_{n+1} and Σ -roles R_0, \dots, R_n witnesses \mathcal{ALCI} -incompleteness of a \mathcal{K} -type t if $t = t_0$, $n \geq 1$, and

- $t_i \rightsquigarrow_{R_i} t_{i+1}$ for $i \leq n$;
- there exists a model \mathfrak{A} of \mathcal{K} and nodes $d_{n-1}, d_n \in \text{dom}(\mathfrak{A})$ with $(d_{n-1}, d_n) \in R_{n-1}^{\mathfrak{A}}$ such that d_{n-1} and d_n realize t_{n-1} and t_n in \mathfrak{A} , respectively, and there does not exist d_{n+1} in \mathfrak{A} realizing t_{n+1} with $(d_n, d_{n+1}) \in R_n^{\mathfrak{A}}$.

Claim 2. The following conditions are equivalent, for any \mathcal{K} -type t :

1. t is not \mathcal{ALCI} -complete for \mathcal{K} ;
2. there is a sequence of length not exceeding $2^{\|\mathcal{O}\|} + 2$ witnessing \mathcal{ALCI} -incompleteness of t .

It is in ExpTime to decide whether a \mathcal{K} -type t is \mathcal{ALCI} -complete for \mathcal{K} .

Claim 2 is proved in the appendix. The intuition behind its proof is as follows. One can define a ‘maximal model’ of \mathcal{K} realizing t by taking a node ‘realizing’ t and then, inductively, for every role R and \mathcal{K} -type t' with $t \rightsquigarrow_R t'$ an R -successor ‘realizing’ t' . Then one continues with those R -successors in the same way, and so on. This model is maximal in the sense that for every node realizing a \mathcal{K} -type every \mathcal{K} -type for which this is logically possible is realized in an R -successor. As not every model of \mathcal{K} realizing t is bisimilar to the maximal one just constructed, one obtains a sequence witnessing \mathcal{ALCI} -incompleteness of t for \mathcal{K} . A pumping argument bounds its length.

We return to the construction of \mathfrak{C} . By Claim 2 we can take a sequence $\sigma = t_0^\sigma R_0^\sigma \dots R_{m_\sigma}^\sigma t_{m_\sigma+1}^\sigma$ that witnesses \mathcal{ALCI} -incompleteness of $t_0^\sigma := \text{tp}_{\mathcal{K}}(\mathfrak{A}, b^{\mathfrak{A}})$ for \mathcal{K} , where $1 \leq m_\sigma \leq L_O := 2^{\|\mathcal{O}\|} + 1$. Note that there exists $d \in \text{dom}(\mathfrak{A})$ such that $(b^{\mathfrak{A}}, d) \in (R_0^\sigma)^{\mathfrak{A}}$, since $\exists R_0^\sigma. \top \in t_0^\sigma$.

We unfold \mathfrak{A} to a model $\mathfrak{A}_{\mathcal{D}, b}^{\leq \ell}$ as follows: the domain of $\mathfrak{A}_{\mathcal{D}, b}^{\leq \ell}$ is the set of sequences $c^{\mathfrak{A}} R_1 d_1 \dots R_n d_n$, $0 \leq n \leq \ell$, with $c \in \text{cons}(\mathcal{D}_{\text{con}(b)})$, $(c^{\mathfrak{A}}, d_1) \in R_1^{\mathfrak{A}}$ and $(d_i, d_{i+1}) \in R_{i+1}^{\mathfrak{A}}$ for all $i < n$, together with a disjoint copy \mathfrak{B} of \mathfrak{A} satisfying $(\mathcal{O}, \mathcal{D} \setminus \mathcal{D}_{\text{con}(b)})$. On that disjoint copy all symbols except the constants in $\mathcal{D}_{\text{con}(b)}$ are defined as before. This part of $\mathfrak{A}_{\mathcal{D}, b}^{\leq \ell}$ is not relevant at all in what follows; it is only needed to obtain a model of $(\mathcal{O}, \mathcal{D} \setminus \mathcal{D}_{\text{con}(b)})$. Next we set $wd \in A^{\mathfrak{A}_{\mathcal{D}, b}^{\leq \ell}}$ if $d \in A^{\mathfrak{A}}$ for all $wd \in \text{dom}(\mathfrak{A}_{\mathcal{D}, b}^{\leq \ell})$, $(w, wRd) \in R^{\mathfrak{A}_{\mathcal{D}, b}^{\leq \ell}}$ for all $wRd \in \text{dom}(\mathfrak{A}_{\mathcal{D}, b}^{\leq \ell})$, $(c_1^{\mathfrak{A}}, c_2^{\mathfrak{A}}) \in R^{\mathfrak{A}}$ if $(c_1^{\mathfrak{A}}, c_2^{\mathfrak{A}}) \in R^{\mathfrak{A}}$ for all $c_1, c_2 \in \text{cons}(\mathcal{D}_{\text{con}(b)})$, and $c^{\mathfrak{A}_{\mathcal{D}, b}^{\leq \ell}} = c^{\mathfrak{A}}$ for all $c \in \text{cons}(\mathcal{D}_{\text{con}(b)})$. Note that in the tree-shaped models \mathfrak{A}_c hooked to $c^{\mathfrak{A}}$, $c \in \text{cons}(\mathcal{D}_{\text{con}(b)})$, all nodes of any depth $k < \ell$ have an R -successor in \mathfrak{A}_c of depth $k + 1$, for some $R \in \text{sig}(\mathcal{K})$. In Figure 2, $\mathfrak{A}_{\mathcal{D}, b}^{\leq \ell}$ is represented by the circle in the middle. Denote by L the set of all leaf nodes in $\mathfrak{A}_{\mathcal{D}, b}^{\leq \ell}$, that is to say, all nodes that have depth exactly ℓ in some \mathfrak{A}_c , $c \in \text{cons}(\mathcal{D}_{\text{con}(b)})$. In Figure 2, these are d, d', d'' .

We obtain \mathfrak{C} by attaching to every $d \in L$ a tree-shaped model \mathfrak{F}_d such that in the resulting model no node in L is $\mathcal{ALCI}(\Sigma)$ -bisimilar to any other node in $\mathfrak{A}_{\mathcal{D}, b}^{\leq \ell}$. It then directly follows that \mathfrak{C} satisfies Conditions (i) and (ii).

Take for any $d \in L$ a number $N_d > |\mathcal{D}| + 2\ell + 2(L_O + 1)$ such that $|N_d - N_{d'}| > 2(L_O + 1)$ for $d \neq d'$. Now fix $d \in L$ and let $t_0 = \text{tp}_{\mathcal{K}}(\mathfrak{A}, d)$. By first walking from d to $b^{\mathfrak{A}}$ in $\mathfrak{A}_{\mathcal{D}, b}^{\leq \ell}$ and then using that $\text{tp}_{\mathcal{K}}(\mathfrak{A}, b^{\mathfrak{A}})$ is not \mathcal{ALCI} -complete for \mathcal{K} we find a sequence

$$t_0 R_0 \dots R_{n_d} t_{n_d+1}$$

that witnesses \mathcal{ALCI} -incompleteness of t_0 for \mathcal{K} and ends with the tail $t_{m_\sigma-1}^\sigma R_{m_\sigma-1}^\sigma t_{m_\sigma}^\sigma R_{m_\sigma}^\sigma t_{m_\sigma+1}^\sigma$ of the sequence σ witnessing \mathcal{ALCI} -incompleteness of $\text{tp}_{\mathcal{K}}(\mathfrak{A}, b^{\mathfrak{A}})$ for \mathcal{K} . Using a straightforward pumping argument as in the proof of Claim 2 we may assume that $n_d \leq L_O$. We define the tree-shaped model \mathfrak{F}_d in such a way that we have a node $c_0 \in \text{dom}(\mathfrak{F}_d)$ such that in the model \mathfrak{C} we have

$$c_0 \in (\forall \Sigma^{N_d}. D)^{\mathfrak{C}} \subseteq \text{dom}(\mathfrak{F}_d), \quad D = \exists \Sigma^{L_O}. (t_{n_d} \sqcap \neg \exists R_{n_d}. t_{n_d+1})$$

where $\exists \Sigma^k.C$ stands for the disjunction of all $\exists \rho.C$ with ρ a path $R_1 \dots R_m$ of Σ -roles R_1, \dots, R_m and $m \leq k$, and $\forall \Sigma^k.C = \neg \exists \Sigma^k. \neg C$. Thus, we aim to achieve that D holds in the N_d -neighbourhood of c_0 , and that this does not hold

for any other node in \mathfrak{C} outside \mathfrak{F}_d . Clearly then we are done as Condition (ii) now follows from the fact that there exists a path from d to a node satisfying $\forall \Sigma^{N_d}.D$ that is shorter than any such path in \mathfrak{C} from any other node in $\mathfrak{A}_{\mathcal{D},b}^{\leq \ell}$. Observe that $(t_{n_d} \sqcap \neg \exists R_{n_d}.t_{n_d+1})$ is satisfiable in a model of \mathcal{K} because $t_{n_d}R_{n_d}t_{n_d+1}$ is the tail of a sequence witnessing \mathcal{ALCI} -incompleteness for \mathcal{K} .

To construct \mathfrak{F}_d consider the ‘almost maximal’ model (introduced in the argument for Claim 2) \mathfrak{U}_{c_0} of \mathcal{O} whose root c_0 realizes t_{n_d} such that if a node $e \in \text{dom}(\mathfrak{U}_{c_0})$ realizes any \mathcal{K} -type t and is of depth $k \geq 0$, then for every \mathcal{K} -type t' with $t \rightsquigarrow_R t'$ for some Σ -role R there exists e' realizing t' of depth $k+1$ with $(e, e') \in R^{\mathfrak{U}_{c_0}}$, *except if* $k \leq N_d + L_O + 1$, $t = t_{n_d}$, $R = R_{n_d+1}$, and $t' = t_{n_d+1}$. \mathfrak{U}_{c_0} with root c_0 is depicted on the left hand side of Figure 2. Observe that \mathfrak{U}_{c_0} is a model of \mathcal{K} because $t_{n_d}R_{n_d}t_{n_d+1}$ is the tail of a sequence witnessing \mathcal{ALCI} -incompleteness for \mathcal{K} . Also observe that D is true in the N_d -neighbourhood of c_0 and false outside the $N_d + 2(L_O + 1)$ -neighbourhood of c_0 , formally:

- $e \in D^{\mathfrak{U}_{c_0}}$ for all e with $\text{dist}_{\mathfrak{U}_{c_0}}(c_0, e) \leq N_d$;
- $e \notin D^{\mathfrak{U}_{c_0}}$ for all e with $\text{dist}_{\mathfrak{U}_{c_0}}(c_0, e) > N_d + 2(L_O + 1)$.

We next need to attach \mathfrak{U}_{c_0} to $\mathfrak{A}_{\mathcal{D},b}^{\leq \ell}$ at d (and rename it to \mathfrak{F}_d). For this again the sequence $t_0R_0 \cdots R_{n_d}t_{n_d+1}$ is crucial. Now, however, we are not interested in its tail but in the initial part $t_0R_0 \cdots t_{n_d-1}R_{n_d-1}t_{n_d}$. Starting from t_{n_d} realized in c_0 in \mathfrak{U}_{c_0} we can follow $R_{n_d-1}^-$ to t_{n_d-1} , then follow R_{n_d-1} to t_{n_d} , and then follow again $R_{n_d-1}^-$ to t_{n_d-1} , and so on. In this way, we can go back and forth N_d times between t_{n_d} and t_{n_d-1} and then follow the inverse of the sequence $t_0R_0 \cdots t_{n_d-1}R_{n_d-1}t_{n_d}$ after $2N_d$ steps. In other words, \mathfrak{U}_{c_0} contains a path $e_0, \dots, e_{n_d} \dots, e_{n_d+2N_d} = c_0$ (see Figure 2) such that t_0 is realized in e_0 and

- $(e_i, e_{i+1}) \in R_i^{\mathfrak{U}_{c_0}}$ for all $i < n_d$, and $(e_{n_d+2k+1}, e_{n_d+2k}), (e_{n_d+2k+1}, e_{n_d+2k+2}) \in R_{n_d-1}^{\mathfrak{U}_{c_0}}$ for $0 \leq k < N_d$;
- $e_{n_d+2k} \in t_{n_d}^{\mathfrak{U}_{c_0}}$, for all $k \leq N_d$, and $e_{n_d+2k+1} \in t_{n_d-1}^{\mathfrak{U}_{c_0}}$, for all $k < N_d$.

Now \mathfrak{F}_d is obtained from \mathfrak{U}_{c_0} by renaming e_0 to d . Finally \mathfrak{C} is obtained from $\mathfrak{A}_{\mathcal{D},b}^{\leq \ell}$ by hooking \mathfrak{F}_d at d to $\mathfrak{A}_{\mathcal{D},b}^{\leq \ell}$ for all $d \in L$, see Figure 2. \mathfrak{C} is a model of \mathcal{K} since t_0 is realized in e_0 in \mathfrak{U}_{c_0} and in d in $\mathfrak{A}_{\mathcal{D},b}^{\leq \ell}$. Moreover, clearly \mathfrak{C} satisfies Condition (i). For Condition (ii) assume $d \in L$ is as above. Let $C_d = \forall \Sigma^{N_d}.D$. Then $e_{n_d+2N_d} \in C_d^{\mathfrak{C}}$ and by construction $C_d^{\mathfrak{C}} \subseteq \text{dom}(\mathfrak{F}_d)$. This finishes the construction of the structure \mathfrak{C} satisfying (i) and (ii) except that \mathfrak{C} fails to be finite since the structures \mathfrak{F}_d are not finite. This is straightforward to repair, however: instead of constructing the \mathfrak{F}_d as tree-shaped almost maximal structures in which for every \mathcal{K} -type t realized in a node e of depth $k > N_d + L_O + 1$ and \mathcal{K} -type t' with $t \rightsquigarrow_R t'$ there exists an R -successor of e of depth $k+1$ realizing t' we do the following for a sufficiently large k (for instance, $k = 2(N_d + L_O + 1)$). We take a node e' realizing t' with depth between $N_d + L_O + 1$ and $2(N_d + L_O + 1)$ and connect e and e' with R . The resulting structures \mathfrak{F}_d are finite, and so \mathfrak{C} is finite and behaves in exactly the same way as the original structure \mathfrak{C} . This finishes the proof of Theorem 24. \square

In practice, one would expect that KBs \mathcal{K} are such that no connected \mathcal{K} -type is \mathcal{ALCI} -complete for \mathcal{K} (while every disconnected \mathcal{K} -type is necessarily \mathcal{ALCI} -complete for \mathcal{K}). It thus makes sense to consider the following special case. A labeled \mathcal{ALCI} -KB (\mathcal{K}, P, N) is *strongly incomplete* if no connected \mathcal{K} -type that is realizable in some \mathcal{K}, b , with $b \in N$, is \mathcal{ALCI} -complete. For \mathcal{ALCI} -KBs that are strongly incomplete, we can drop Point 3 (b) from Theorem 24 and obtain the following from Theorem 8.

Corollary 26. *For labeled \mathcal{ALCI} -KBs that are strongly incomplete, non-projective \mathcal{ALCI} -separability coincides with non-projective and projective \mathcal{L}_S -separability for all FO-fragments $\mathcal{L}_S \supseteq \text{UCQ}$.*

It follows from Theorem 24 that there is a polynomial time reduction of projective $(\mathcal{ALCI}, \mathcal{ALCI})$ -separability to non-projective $(\mathcal{ALCI}, \mathcal{ALCI})$ -separability. Let $(\mathcal{K}, P, \{b\})$, $\mathcal{K} = (\mathcal{O}, \mathcal{D})$, be a labeled \mathcal{ALCI} -KB. Then \mathcal{K} is projectively \mathcal{ALCI} -separable if and only if $(\mathcal{K}', P, \{b\})$ is non-projectively \mathcal{ALCI} -separable where $\mathcal{K}' = (\mathcal{O}', \mathcal{D})$ and $\mathcal{O}' = \mathcal{O} \cup \{A \sqsubseteq A\}$, A a fresh concept name. In fact, \mathcal{K} is clearly projectively \mathcal{ALCI} -separable iff \mathcal{K}' is, and \mathcal{K}' is projectively \mathcal{ALCI} -separable iff it is non-projectively \mathcal{ALCI} -separable because no connected \mathcal{K}' -type is \mathcal{ALCI} -complete and thus Point 3 (b) of Theorem 24 is vacuously true for \mathcal{K}' . This also implies that whenever a labeled \mathcal{ALCI} -KB is projectively separable, then a single fresh concept name suffices for separation.

We now also have everything in place to clarify the complexity of non-projective $(\mathcal{ALCI}, \mathcal{ALCI})$ -separability.

Theorem 27. *Non-projective (\mathcal{ALCI} , \mathcal{ALCI})-separability is NEXPTIME-complete in combined complexity. This also holds for definability, RE-existence, and entity distinguishability. For separability and definability the NEXPTIME-lower bound holds already in data complexity.*

Proof. The lower bounds are a consequence of Theorem 19, Theorem 20, and the mentioned reduction of projective separability to non-projective separability. For the upper bound, we first observe that according to Claim 2 in the proof of Theorem 24 it is in EXPTIME to decide whether a given \mathcal{K} -type t is \mathcal{ALCI} -complete. Let $(\mathcal{K}, P, \{b\})$ be a labeled \mathcal{ALCI} -KB. For any \mathcal{K} -type t , let $\mathcal{K}_t = (O_t, \mathcal{D}_t)$ where $O_t = O \sqcup \{A \sqsubseteq \bigwedge_{C \in t} C\}$ and $\mathcal{D}_t = \mathcal{D} \cup \{A(b)\}$ for a fresh concept name A . By Theorem 24, $(\mathcal{K}, P, \{b\})$ is non-projectively \mathcal{ALCI} -separable iff there exists a \mathcal{K} -type t that is realizable in \mathcal{K}, b such that (i) $\mathcal{K}_t \not\models \bigvee_{a \in P} \varphi_{\mathcal{D}_{\text{con}(a), a}}(b)$ and (ii) if t is connected and \mathcal{ALCI} -complete for \mathcal{K} , then t is not realizable in \mathcal{K}, a for any $a \in P$. The NEXPTIME upper bound now follows from the fact that rooted UCQ-evaluation on \mathcal{ALCI} -KBs is in conEXPTIME and that \mathcal{ALCI} -completeness of t and realizability of t in \mathcal{K}, a can be checked in EXPTIME. \square

When the ontology in \mathcal{K} is empty, then no connected \mathcal{K} -type is \mathcal{ALCI} -complete and thus Point 3 (b) of Theorem 24 is vacuously true. It follows that non-projective and projective \mathcal{ALCI} -separability of KBs (\emptyset, \mathcal{D}) coincides with FO-separability and is conNP-complete (Theorem 15). The same is true for definability, RE-existence, and entity distinguishability.

5.2. Separability of Labeled GF-KBs

We study projective and non-projective (GF, GF)-separability which turns out to behave similarly to the \mathcal{ALCI} case in many ways. The non-projective case is, however, significantly more difficult to analyse. A new aspect we consider for GF is a comparison with separability in the fragment openGF of GF in which one can only speak locally about neighbourhoods of tuples and not about disconnected parts. It turns out that separability is not affected by this restriction, but the length of separating formulas is.

We start with an example which shows that projective and non-projective (GF, GF)-separability do not coincide. Note that Example 21 does not serve this purpose since the labeled KB given there is separable by the GF-formula $R(x, x)$. We use the more succinct \mathcal{ALCI} -syntax for GF-formulas and ontologies whenever possible.

Example 28. Define $\mathcal{K} = (O, \mathcal{D})$ where

$$O = \{\top \sqsubseteq \exists R. \top \sqcap \exists R^- . \top, \forall x \forall y (R(x, y) \rightarrow \neg R(y, x))\}$$

and $\mathcal{D} = \{R(a, c), R(c, d), R(d, a), R(b, e)\}$ is depicted below:

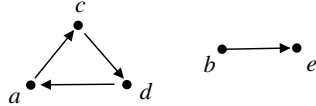

The labeled GF-KB $(\mathcal{K}, \{a\}, \{b\})$ is separated by the \mathcal{ALCI} -concept $C = A \rightarrow \exists R. \exists R. \exists R. A$ that uses the concept name A as a helper symbol. In contrast, the KB is not non-projectively GF-separable since every GF-formula $\varphi(x)$ with $\text{sig}(\varphi) = \{R\}$ is either valid (equivalent to $x = x$) or unsatisfiable (equivalent to $\neg(x = x)$) w.r.t. O . It follows that if $\mathcal{K} \models \varphi(a)$, then φ is valid w.r.t. O and so $\mathcal{K} \models \varphi(b)$.

To illustrate the role of the second sentence in O , let O^- be O without that sentence. Then $\mathcal{K}^- = (O^-, \mathcal{D})$ is separated by the GF-formula obtained from the separating \mathcal{ALCI} -concept C above by replacing each occurrence of $A(x)$ in C^\dagger by the formula $\chi(x) = \exists y (R(x, y) \wedge R(y, y))$ (the resulting formula is equivalent to $\chi(x) \rightarrow \exists y (R^3(x, z) \wedge \chi(z))$) and we therefore have non-projective GF-separability. \blacktriangle

Let *openGF* be the fragment of GF that consists of all open formulas in GF whose subformulas are all open and in which equality is not used as a guard. For example, $A(x) \wedge \exists x B(x)$ is in GF but not in openGF because it contains a closed subformula. OpenGF was first considered in [71] where it is also observed that an open GF formula $\varphi(\vec{x})$ is equivalent to a formula in openGF if and only if for all structures \mathfrak{A} and $\vec{a} \in \text{dom}(\mathfrak{A})^{|\vec{x}|}$ $\mathfrak{A} \models \varphi(\vec{a})$ iff $\mathfrak{A}_{\text{con}(\vec{a})} \models \varphi(\vec{a})$, where $\mathfrak{A}_{\text{con}(\vec{a})}$ is the restriction of \mathfrak{A} to all $b \in \text{dom}(\mathfrak{A})$ that are reachable from some $a \in [\vec{a}]$ in the Gaifman graph of \mathfrak{A} . Thus, openGF can only speak about the neighbourhood of \vec{a} and its truth does not depend on any disconnected parts of \mathfrak{A} . Informally, openGF relates to GF in the same way as \mathcal{ALCI} relates to the extension of \mathcal{ALCI} with the universal role [58]. We start our investigation with observing the following.

Theorem 29. *(GF, GF)-separability coincides with (GF, openGF)-separability, both in the projective and in the non-projective case.*

Theorem 29 will follow from model-theoretic characterizations of separability provided below. Arguably, openGF formulas are more natural for separation purposes than unrestricted GF formulas as they speak only about the neighbourhood of the examples. The next example shows that this is at the expense of larger separating formulas (a slightly modified example shows the same behaviour for \mathcal{ALCI} and its extension with the universal role).

Example 30. Let

$$O = \{A \sqsubseteq \forall R.A, \forall xy(R(x, y) \rightarrow \neg R(y, x))\}$$

and let \mathcal{D}_n contain two R -paths of length n , $a_0 R a_1 R \dots R a_n$ and $b_0 R b_1 R \dots R b_n$ with a_n labeled with E :

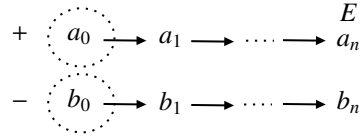

Consider the labeled GF-KB $(\mathcal{K}_n, \{a_0\}, \{b_0\})$ with $\mathcal{K}_n = (O, \mathcal{D}_n)$. Then the GF-formula $A(x) \rightarrow \exists y(A(y) \wedge E(y))$ separates $(\mathcal{K}_n, \{a_0\}, \{b_0\})$. An openGF formula separating $(\mathcal{K}_n, \{a_0\}, \{b_0\})$ is given by the \mathcal{ALCI} -concept $A \rightarrow \exists R^n.(A \sqcap E)$ and we show in Proposition 32 below that the shortest separating openGF-formula has length at least n (even if it uses helper symbols). \blacktriangle

To characterize separability in GF and openGF we define guarded bisimulations, a standard tool for proving that two structures satisfy the same guarded formulas [72, 71]. Guarded bisimulations generalize \mathcal{ALCI} -bisimulations. Let \mathfrak{A} be structure. A set $G \subseteq \text{dom}(\mathfrak{A})$ is *guarded* in \mathfrak{A} if G is a singleton or there exists R with $\mathfrak{A} \models R(\vec{d})$ such that $G = [\vec{d}]$. A tuple \vec{d} in $\text{dom}(\mathfrak{A})$ is *guarded* in \mathfrak{A} if $[\vec{d}]$ is a subset of some guarded set in \mathfrak{A} .

Let Σ be a signature. The restriction of a structure \mathfrak{A} to a nonempty subset A of $\text{dom}(\mathfrak{A})$ is denoted $\mathfrak{A}|_A$. The Σ -*reduct* of \mathfrak{A} coincides with \mathfrak{A} except that all symbols not in Σ are interpreted by the empty set. For tuples $\vec{a} = (a_1, \dots, a_n)$ in \mathfrak{A} and $\vec{b} = (b_1, \dots, b_n)$ in \mathfrak{B} we call a mapping p from $[\vec{a}]$ to $[\vec{b}]$ with $p(a_i) = b_i$ for $1 \leq i \leq n$ (written $p : \vec{a} \mapsto \vec{b}$) a *partial Σ -homomorphism* if p is a homomorphism from the Σ -reduct of $\mathfrak{A}|_{[\vec{a}]}$ to $\mathfrak{B}|_{[\vec{b}]}$. We call p a *partial Σ -isomorphism* if, in addition, the inverse of p is a partial Σ -homomorphism from $\mathfrak{B}|_{[\vec{b}]}$ to $\mathfrak{A}|_{[\vec{a}]}$.

A set I of partial Σ -isomorphisms $p : \vec{a} \mapsto \vec{b}$ from guarded tuples \vec{a} in \mathfrak{A} to guarded tuples \vec{b} in \mathfrak{B} is called a *connected guarded Σ -bisimulation* if the following hold for all $p : \vec{a} \mapsto \vec{b} \in I$:

- (i) for every guarded tuple \vec{a}' in \mathfrak{A} with $[\vec{a}] \cap [\vec{a}'] \neq \emptyset$ there exists a guarded tuple \vec{b}' in \mathfrak{B} and $p' : \vec{a}' \mapsto \vec{b}' \in I$ such that p' and p coincide on $[\vec{a}] \cap [\vec{a}']$.
- (ii) for every guarded tuple \vec{b}' in \mathfrak{B} with $[\vec{b}] \cap [\vec{b}'] \neq \emptyset$ there exists a guarded tuple \vec{a}' in \mathfrak{A} and $p' : \vec{a}' \mapsto \vec{b}' \in I$ such that p'^{-1} and p^{-1} coincide on $[\vec{b}] \cap [\vec{b}']$.

Assume that \vec{a} and \vec{b} are (possibly not guarded) tuples in \mathfrak{A} and \mathfrak{B} . Then we say that \mathfrak{A}, \vec{a} and \mathfrak{B}, \vec{b} are *connected guarded Σ -bisimilar*, in symbols $\mathfrak{A}, \vec{a} \sim_{\text{openGF}, \Sigma} \mathfrak{B}, \vec{b}$, if there exists a partial Σ -isomorphism $p : \vec{a} \mapsto \vec{b}$ and a connected guarded Σ -bisimulation I such that Conditions (i) and (ii) hold for p [71].

Connected guarded Σ -bisimulations differ from the standard guarded Σ -bisimulations [72] in requiring $[\vec{a}] \cap [\vec{a}'] \neq \emptyset$ in Condition (i) and $[\vec{b}] \cap [\vec{b}'] \neq \emptyset$ in Condition (ii). If we drop these conditions then we talk about *guarded Σ -bisimulations* and *guarded Σ -bisimilarity*, in symbols $\mathfrak{A}, \vec{a} \sim_{\text{GF}, \Sigma} \mathfrak{B}, \vec{b}$.

We also use finitary versions of guarded bisimulations. In these versions of (connected) guarded bisimulations the Conditions (i) and (ii) are required to hold a finite number $\ell \geq 0$ of rounds only. Thus, one considers sets I_ℓ, \dots, I_0 of partial Σ -isomorphisms such that I_ℓ contains the partial Σ -isomorphism $p : \vec{a} \mapsto \vec{b}$ and for any $p \in I_i$ there exist $p' \in I_{i-1}$ such that (i) and, respectively, (ii) hold, for $0 < i \leq \ell$. If such sets exist then we say that \mathfrak{A}, \vec{a} and \mathfrak{B}, \vec{b} are *(connected) guarded Σ ℓ -bisimilar* and write $\mathfrak{A}, \vec{a} \sim_{\text{openGF}, \Sigma}^\ell \mathfrak{B}, \vec{b}$ and $\mathfrak{A}, \vec{a} \sim_{\text{GF}, \Sigma}^\ell \mathfrak{B}, \vec{b}$, respectively.

We say that \mathfrak{A}, \vec{a} and \mathfrak{B}, \vec{b} are *GF(Σ)-equivalent*, in symbols $\mathfrak{A}, \vec{a} \equiv_{\text{GF}, \Sigma} \mathfrak{B}, \vec{b}$, if $\mathfrak{A} \models \varphi(\vec{a})$ iff $\mathfrak{B} \models \varphi(\vec{b})$ for all formulas $\varphi(\vec{x})$ in GF(Σ). The *guarded quantifier rank* $\text{gr}(\varphi)$ of a formula φ in GF is the number of nestings of

guarded quantifiers in it. We say that \mathfrak{A}, \vec{a} and \mathfrak{B}, \vec{b} are $GF^\ell(\Sigma)$ -equivalent, in symbols $\mathfrak{A}, \vec{a} \equiv_{GF, \Sigma}^\ell \mathfrak{B}, \vec{b}$, if $\mathfrak{A} \models \varphi(\vec{a})$ iff $\mathfrak{B} \models \varphi(\vec{b})$ for all formulas $\varphi(\vec{x})$ in $GF(\Sigma)$ of guarded quantifier rank at most ℓ . The same notation is applied for openGF. For example, we say that \mathfrak{A}, \vec{a} and \mathfrak{B}, \vec{b} are $openGF(\Sigma)$ -equivalent, in symbols $\mathfrak{A}, \vec{a} \equiv_{openGF, \Sigma} \mathfrak{B}, \vec{b}$, if $\mathfrak{A} \models \varphi(\vec{a})$ iff $\mathfrak{B} \models \varphi(\vec{b})$ for all formulas $\varphi(\vec{x})$ in $openGF(\Sigma)$. We say that \mathfrak{A}, \vec{a} and \mathfrak{B}, \vec{b} are $openGF^\ell(\Sigma)$ -equivalent, in symbols $\mathfrak{A}, \vec{a} \equiv_{openGF, \Sigma}^\ell \mathfrak{B}, \vec{b}$, if $\mathfrak{A} \models \varphi(\vec{a})$ iff $\mathfrak{B} \models \varphi(\vec{b})$ for all formulas $\varphi(\vec{x})$ in $openGF(\Sigma)$ of guarded quantifier rank at most ℓ . The following is shown in [52, 72, 71] and the notion of ω -saturated structures is discussed, for example, in [60].

Lemma 31. *Let \mathfrak{A}, \vec{a} and \mathfrak{B}, \vec{b} be pointed structures and Σ a signature. Then for $\mathcal{L} \in \{GF, openGF\}$ and all $\ell \geq 0$:*

$$\mathfrak{A}, \vec{a} \equiv_{\mathcal{L}, \Sigma}^\ell \mathfrak{B}, \vec{b} \quad \text{iff} \quad \mathfrak{A}, \vec{a} \sim_{\mathcal{L}, \Sigma}^\ell \mathfrak{B}, \vec{b}.$$

Moreover,

$$\mathfrak{A}, \vec{a} \sim_{\mathcal{L}, \Sigma} \mathfrak{B}, \vec{b} \quad \text{implies} \quad \mathfrak{A}, \vec{a} \equiv_{\mathcal{L}, \Sigma} \mathfrak{B}, \vec{b}$$

and, conversely, if either \mathfrak{A} is finite or both \mathfrak{A} and \mathfrak{B} are ω -saturated, then

$$\mathfrak{A}, \vec{a} \equiv_{\mathcal{L}, \Sigma} \mathfrak{B}, \vec{b} \quad \text{implies} \quad \mathfrak{A}, \vec{a} \sim_{\mathcal{L}, \Sigma} \mathfrak{B}, \vec{b}$$

We illustrate connected guarded bisimulations by using them to prove the claim made in Example 30 above.

Proposition 32. *Let $(\mathcal{K}_n, \{a_0\}, \{b_0\})$ be as in Example 30. Then any openGF-formula separating $(\mathcal{K}_n, \{a_0\}, \{b_0\})$ has guarded quantifier rank at least n (and so length at least n).*

Proof. Let $\Sigma = \{A, E, R\} = \text{sig}(\mathcal{K}_n)$. To prove that no openGF-formula of guarded quantifier rank $m < n$ separates $(\mathcal{K}_n, \{a_0\}, \{b_0\})$, it is sufficient to prove that for all models \mathfrak{A} of \mathcal{K}_n and signatures Σ_{help} of helper symbols there exists a model \mathfrak{B} of \mathcal{K}_n such that $\mathfrak{A}, b_0^{\mathfrak{A}} \sim_{openGF, \Sigma \cup \Sigma_{\text{help}}}^m \mathfrak{B}, a_0^{\mathfrak{B}}$. (To see this assume that there exists a formula $\varphi(x)$ in openGF of guarded quantifier rank $m < n$ using symbols in $\Sigma \cup \Sigma_{\text{help}}$ such that $\mathcal{K}_n \models \varphi(a_0)$ and $\mathcal{K}_n \not\models \varphi(b_0)$. Take any model \mathfrak{A} of \mathcal{K}_n such that $\mathfrak{A} \not\models \varphi(b_0)$. By Lemma 31, $\mathfrak{A} \not\models \varphi(a_0)$, and we have derived a contradiction.) Now let \mathfrak{A} be a model of \mathcal{K}_n . Observe that $b_i^{\mathfrak{A}} \neq b_{i+1}^{\mathfrak{A}}$ since $\forall xy(R(x, y) \rightarrow \neg R(y, x)) \in \mathcal{O}$. We can unfold \mathfrak{A} into a guarded tree-decomposable model \mathfrak{A}^* of \mathcal{O} (see the appendix and [71]) such that there is a sequence $d_0, \dots, d_n \in \text{dom}(\mathfrak{A}^*)$ with

- $\mathfrak{A}, b_0^{\mathfrak{A}} \sim_{openGF, \Sigma \cup \Sigma_{\text{help}}} \mathfrak{A}^*, d_0$;
- $\mathfrak{A}, (b_i^{\mathfrak{A}}, b_{i+1}^{\mathfrak{A}}) \sim_{openGF, \Sigma \cup \Sigma_{\text{help}}} \mathfrak{A}^*, (d_i, d_{i+1})$, for all $i < n$;
- d_0 and d_i have distance exactly i in \mathfrak{A}^* , for all $i \leq n$.

Define a structure \mathfrak{B}' as follows: the domain of \mathfrak{B}' and the interpretation of symbols in $\Sigma \cup \Sigma_{\text{help}}$ is given by taking the disjoint union of \mathfrak{A}^* and \mathfrak{A} . For the interpretation of the constants a_0, \dots, a_n take the path $d_0, \dots, d_n \in \text{dom}(\mathfrak{A}^*)$ and set $a_i^{\mathfrak{B}'} := d_i$ for $i \leq n$. The constants b_0, \dots, b_n are interpreted by setting $b_i^{\mathfrak{B}'} := b_i^{\mathfrak{A}}$ for $i \leq n$. Note that $\mathfrak{A}, b_0^{\mathfrak{A}} \sim_{openGF, \Sigma \cup \Sigma_{\text{help}}} \mathfrak{B}', a_0^{\mathfrak{B}'}$ follows from $\mathfrak{A}, b_0^{\mathfrak{A}} \sim_{openGF, \Sigma \cup \Sigma_{\text{help}}} \mathfrak{A}^*, d_0$. However, \mathfrak{B}' might not yet be a model of \mathcal{D}_n since $d_n \in E^{\mathfrak{B}'}$ is not guaranteed. We therefore add d_n to the interpretation of E and denote the resulting structure by \mathfrak{B} . Then \mathfrak{B} is a model of \mathcal{K}_n and, as d_0 and d_n have distance exactly n in \mathfrak{A}^* the addition of E only becomes relevant after $n - 1$ steps of the connected guarded bisimulation witnessing $\mathfrak{A}, b_0^{\mathfrak{A}} \sim_{openGF, \Sigma \cup \Sigma_{\text{help}}} \mathfrak{B}', a_0^{\mathfrak{B}'}$. We thus have that $\mathfrak{A}, b_0^{\mathfrak{A}} \sim_{openGF, \Sigma \cup \Sigma_{\text{help}}}^{n-1} \mathfrak{B}, a_0^{\mathfrak{B}}$, as required. \square

We next extend the notion of a functional $\mathcal{ALCI}(\Sigma)$ -bisimulation to the guarded case. We write $\mathfrak{A}, \vec{a} \sim_{openGF, \Sigma}^f \mathfrak{B}, \vec{b}$ if there exists a set I of partial Σ -isomorphisms witnessing that $\mathfrak{A}, \vec{a} \sim_{openGF, \Sigma} \mathfrak{B}, \vec{b}$ such that $p(a) = p'(a)$ for all $p, p' \in I$ and $a \in \text{dom}(\mathfrak{A})$ such that a is in the domain of both p and p' . Then I is called a *connected functional guarded Σ -bisimulation*. We are now in a position to formulate a counterpart of Theorem 17 for (GF, openGF)-separability.

Theorem 33. *Assume that $(\mathcal{K}, P, \{\vec{b}\})$ is a labeled GF-KB with $\mathcal{K} = (\mathcal{O}, \mathcal{D})$ and $\Sigma = \text{sig}(\mathcal{K})$. Then the following conditions are equivalent:*

1. $(\mathcal{K}, P, \{\vec{b}\})$ is projectively openGF-separable;

2. there exists a finite model \mathfrak{A} of \mathcal{K} and a finite set Σ_{help} of unary relation symbols disjoint from $\text{sig}(\mathcal{K})$ such that for all models \mathfrak{B} of \mathcal{K} and all $\vec{d} \in P$: $\mathfrak{B}, \vec{d}^{\mathfrak{B}} \approx_{\text{openGF}, \Sigma \cup \Sigma_{\text{help}}} \mathfrak{A}, \vec{b}^{\mathfrak{A}}$;
3. there exists a finite model \mathfrak{A} of \mathcal{K} such that for all models \mathfrak{B} of \mathcal{K} and all $\vec{d} \in P$: $\mathfrak{B}, \vec{d}^{\mathfrak{B}} \approx_{\text{openGF}, \Sigma}^f \mathfrak{A}, \vec{b}^{\mathfrak{A}}$;
4. there exists a finite model \mathfrak{A} of \mathcal{K} such that for all $\vec{d} \in P$: $\mathcal{D}_{\text{con}(\vec{d})}, \vec{d} \dashv \rightarrow \mathfrak{A}, \vec{b}^{\mathfrak{A}}$;
5. there exists a model \mathfrak{A} of \mathcal{K} such that for all $\vec{d} \in P$: $\mathcal{D}_{\text{con}(\vec{d})}, \vec{d} \dashv \rightarrow \mathfrak{A}, \vec{b}^{\mathfrak{A}}$.

Proof. The proof is essentially the same as the proof of Theorem 17 with (functional) $\mathcal{ALCI}(\Sigma)$ -bisimulations replaced by (functional) connected guarded bisimulations. For the implication “2. \Rightarrow 1.” one uses Lemma 31 instead of Lemma 16. For “4. \Rightarrow 3.” consider a model \mathfrak{A} of \mathcal{K} such that Condition 4 holds but assume there exists a model \mathfrak{B} of \mathcal{K} and a connected functional guarded bisimulation I refuting Condition 3 for some $\vec{d} \in P$ for \mathfrak{A} . Then $f = \bigcup_{p \in I} p$ is a function and thus, as every $p \in I$ is a Σ -isomorphism, it is a Σ -homomorphism from $\mathfrak{B}_{\text{con}(\vec{d}^{\mathfrak{B}})}, \vec{d}^{\mathfrak{B}}$ to $\mathfrak{A}, \vec{b}^{\mathfrak{A}}$. Let h be the mapping from $\text{cons}(\mathcal{D}_{\text{con}(\vec{d})})$ to $\text{dom}(\mathfrak{B})$ defined by setting $h(c) = c^{\mathfrak{B}}$. Then h is a homomorphism from $\mathcal{D}_{\text{con}(\vec{d})}$ to \mathfrak{B} and so the composition $f \circ h$ is a homomorphism witnessing $\mathcal{D}_{\text{con}(\vec{d})}, \vec{d} \dashv \rightarrow \mathfrak{A}, \vec{b}^{\mathfrak{A}}$. We have derived a contradiction. For “5. \Rightarrow 4.” observe that UCQ-evaluation on GF-KBs is finitely controllable [65]. \square

Observe that the projective case of Theorem 29 follows directly from Theorem 33 since even projective (GF,openGF)-separability and (GF,FO)-separability coincide by Point 4 and $\text{openGF} \subseteq \text{GF} \subseteq \text{FO}$.

UCQ-evaluation is decidable in 2ExpTime on GF-KBs [65] and satisfiability of GF-sentences is 2ExpTime -hard [53]. We therefore obtain the following result in the same way as Corollary 14.

Theorem 34. For any FO-fragment $\mathcal{L}_S \supseteq \text{UCQ}$:

1. projective (GF, GF)-separability, projective (GF, openGF)-separability, and (GF, \mathcal{L}_S)-separability coincide, and the same is true for definability;
2. projective (GF, GF)-separability and projective (GF, GF)-definability are 2ExpTime -complete in combined complexity.

This holds also for RE-existence and entity distinguishability, for all FO-fragments $\mathcal{L}_S \supseteq \text{CQ}$.

Regarding data complexity, it follows from the NExpTime -hardness of projective (\mathcal{ALCI} , \mathcal{ALCI})-separability that projective (GF, GF)-separability is also NExpTime -hard in data complexity. We conjecture that it is actually 2ExpTime -hard in data complexity. Some justification for this conjecture is provide in Appendix A, following the proof of NExpTime -hardness of projective (\mathcal{ALCI} , \mathcal{ALCI})-separability.

We now consider non-projective separability. Let $\mathcal{K} = (\mathcal{O}, \mathcal{D})$ be a GF-KB. The main result characterizing non-projective separability is very similar to non-projective \mathcal{ALCI} : again, in addition to UCQ-evaluation one has to understand complete types that distinguish the non-projective from the projective case. For each $n \geq 1$, fix a tuple of distinct variables \vec{x}_n of length n . We use $\text{cl}(\mathcal{K})$ to denote the smallest set of GF-formulas that is closed under subformulas and single negation and contains: all formulas from \mathcal{O} ; $x = y$ for distinct variables x, y ; for all $R \in \text{sig}(\mathcal{K})$ of arity $n \geq 2$ and all distinct $x, y \in [\vec{x}_n]$, the formulas $R(\vec{x}_n), \exists \vec{y}_1 (R(\vec{x}_n) \wedge x \neq y)$ where \vec{y}_1 is \vec{x}_n without x , and $\exists \vec{y}_2 R(\vec{x}_n)$ for all \vec{y}_2 with $[\vec{y}_2] \subseteq [\vec{x}_n] \setminus \{x, y\}$ (for $n \geq 3$). Let \mathfrak{A} be a model of \mathcal{K} and \vec{d} a tuple in \mathfrak{A} . The \mathcal{K} -type of \vec{d} in \mathfrak{A} is defined as

$$\text{tp}_{\mathcal{K}}(\mathfrak{A}, \vec{d}) = \{\varphi \mid \mathfrak{A} \models \varphi(\vec{d}), \varphi \in \text{cl}(\mathcal{K})[\vec{x}]\},$$

where $\text{cl}(\mathcal{K})[\vec{x}]$ is obtained from $\text{cl}(\mathcal{K})$ by substituting in any formula $\varphi \in \text{cl}(\mathcal{K})$ the free variables of φ by variables in \vec{x} in all possible ways, \vec{x} a tuple of distinct variables of the same length as \vec{d} . Any such \mathcal{K} -type of some \vec{d} in a model \mathfrak{A} of \mathcal{K} is called a \mathcal{K} -type and denoted $\Phi(\vec{x})$. $\Phi(\vec{x})$ is *realizable in a pair* \mathcal{K}, \vec{b} with \vec{b} a tuple in $\text{cons}(\mathcal{D})$ if there exists a model \mathfrak{A} of \mathcal{K} with $\text{tp}_{\mathcal{K}}(\mathfrak{A}, \vec{b}^{\mathfrak{A}}) = \Phi(\vec{x})$. Recall that in \mathcal{ALCI} , a type is *connected* if it contains a concept of the form $\exists R.T$. We generalize this notion to GF by demanding that the type $\Phi(\vec{x})$ contains a formula of the form $\exists \vec{y}_1 (R(\vec{x}_n) \wedge x \neq y)$ from above, for some relation R of arity $n \geq 2$ and with x replaced by some x_i from \vec{x} . Otherwise $\Phi(\vec{x})$ is called *disconnected*. The definition of a complete type is the same as for \mathcal{ALCI} .

Definition 35. Let \mathcal{K} be a GF-KB. A \mathcal{K} -type $\Phi(\vec{x})$ is openGF-complete for \mathcal{K} if for any two pointed models $\mathfrak{A}_1, \vec{b}_1$ and $\mathfrak{A}_2, \vec{b}_2$ of \mathcal{K} , $\Phi(\vec{x}) = tp_{\mathcal{K}}(\mathfrak{A}_1, \vec{b}_1) = tp_{\mathcal{K}}(\mathfrak{A}_2, \vec{b}_2)$ implies $\mathfrak{A}_1, \vec{b}_1 \equiv_{openGF, \Sigma} \mathfrak{A}_2, \vec{b}_2$.

Observe that every disconnected \mathcal{K} -type is openGF-complete. The following example illustrates the notion of \mathcal{K} -types in GF.

Example 36. Consider the KB $\mathcal{K}^- = (\mathcal{O}^-, \mathcal{D})$ from Example 28. In contrast to \mathcal{ALCI} (where there exists only a single \mathcal{K}^- -type $\{\top, \exists R.\top, \exists R^-\top, \exists R.\top \cap \exists R^-\top\}$ which is connected and \mathcal{ALCI} -complete for \mathcal{K}^-), in GF there are multiple \mathcal{K}^- -types with a single free variable x :

- there exists a uniquely determined such \mathcal{K}^- -type containing $\{R(x, x), \neg\exists y(R(x, y) \wedge x \neq y), \neg\exists y(R(y, x) \wedge x \neq y)\}$. This type is disconnected (and therefore openGF-complete for \mathcal{K}^-).
- There exists a uniquely determined such \mathcal{K}^- -type containing $\forall xy(R(x, y) \rightarrow \neg R(y, x))$. This type is connected (as it contains $\exists y(R(x, y) \wedge x \neq y)$) and openGF-complete for \mathcal{K}^- .
- There are multiple connected and not openGF-complete such \mathcal{K}^- -types. For example, there exist such types containing $\{R(x, x), \exists y(R(x, y) \wedge x \neq y)\}$, $\{R(x, x), \neg\exists y(R(x, y) \wedge x \neq y)\}$, or $\{\neg R(x, x), \exists y(R(x, y) \wedge x \neq y)\}$.

It follows from Point 2 above that for the KB $\mathcal{K} = (\mathcal{O}, \mathcal{D})$ from Example 28 there is only a single \mathcal{K} -type $\Phi(x)$. This type is connected and openGF-complete for \mathcal{K} . There are, up to variable renaming, two \mathcal{K} -types $\Phi(x, y)$ containing $x \neq y$: the \mathcal{K} -type containing $R(x, y), \neg R(y, x)$ and the \mathcal{K} -type containing $\neg R(x, y), \neg R(y, x)$. Both are openGF-complete for \mathcal{K} and connected. \blacktriangle

We could now characterize non-projective (GF, GF)-separability in a way that is completely analogous to Theorem 24, replacing \mathcal{ALCI} -completeness of types with openGF-completeness. However, this works only for labeled KBs $(\mathcal{K}, P, \{\vec{b}\})$, $\mathcal{K} = (\mathcal{O}, \mathcal{D})$, such that all constants in $[\vec{b}]$ can reach one another in the Gaifman graph of \mathcal{D} . To formulate a condition for the general case, for a tuple $\vec{a} = (a_1, \dots, a_n)$ and $I \subseteq \{1, \dots, n\}$ let $\vec{a}_I = (a_i \mid i \in I)$.

Theorem 37. Assume that $(\mathcal{K}, P, \{\vec{b}\})$ is a labeled GF-KB with $\mathcal{K} = (\mathcal{O}, \mathcal{D})$, $\Sigma = sig(\mathcal{K})$, and $\vec{b} = (b_1, \dots, b_n)$. Then the following conditions are equivalent:

1. $(\mathcal{K}, P, \{\vec{b}\})$ is non-projectively GF-separable;
2. $(\mathcal{K}, P, \{\vec{b}\})$ is non-projectively openGF-separable;
3. there exists a finite model \mathfrak{A} of \mathcal{K} such that for all models \mathfrak{B} of \mathcal{K} and all $\vec{a} \in P$: $\mathfrak{B}, \vec{a}^{\mathfrak{B}} \sim_{GF, \Sigma} \mathfrak{A}, \vec{b}^{\mathfrak{A}}$;
4. there exists a finite model \mathfrak{A} of \mathcal{K} such that for all models \mathfrak{B} of \mathcal{K} and all $\vec{a} \in P$: $\mathfrak{B}, \vec{a}^{\mathfrak{B}} \sim_{openGF, \Sigma} \mathfrak{A}, \vec{b}^{\mathfrak{A}}$;
5. there exists a model \mathfrak{A} of \mathcal{K} such that for all $\vec{a} \in P$:
 - (a) $\mathcal{D}_{con(\vec{a})}, \vec{a} \not\rightarrow \mathfrak{A}, \vec{b}^{\mathfrak{A}}$ and
 - (b) if the set I of all i such that $tp_{\mathcal{K}}(\mathfrak{A}, b_i^{\mathfrak{A}})$ is connected and openGF-complete is not empty, then
 - i. $J = \{1, \dots, n\} \setminus I \neq \emptyset$ and $\mathcal{D}_{con(\vec{a}_J)}, \vec{a}_J \not\rightarrow \mathfrak{A}, \vec{b}_J^{\mathfrak{A}}$ or
 - ii. $tp_{\mathcal{K}}(\mathfrak{A}, \vec{b}^{\mathfrak{A}})$ is not realizable in \mathcal{K}, \vec{a} .

Proof. (sketch) The equivalence of Points 1 and 3 and of Points 2 and 4 can be proved using Lemma 31 and the finite model property of GF (see Section 3). These proofs are exactly the same as the proofs we have given for \mathcal{ALCI} already and therefore omitted. The implication “2. \Rightarrow 1.” holds since openGF is contained in GF. We next show “3. \Rightarrow 4.” Assume that there exists a model \mathfrak{A} such that Point 3 holds. We show that Point 4 also holds for \mathfrak{A} . For a proof by contradiction, assume that there exist a model \mathfrak{B} of \mathcal{K} and $\vec{a} \in P$ such that $\mathfrak{B}, \vec{a}^{\mathfrak{B}} \sim_{openGF, \Sigma} \mathfrak{A}, \vec{b}^{\mathfrak{A}}$. Let $\mathfrak{A}_{\vec{b}}$ and $\mathfrak{B}_{\vec{a}}$ be the restrictions of \mathfrak{A} and \mathfrak{B} to all nodes reachable from $\vec{b}^{\mathfrak{A}}$ in \mathfrak{A} and from $\vec{a}^{\mathfrak{B}}$ in \mathfrak{B} , respectively. We interpret all constants from $\mathcal{D}_{con(\vec{a})}$ in $\mathfrak{B}_{\vec{a}}$ as before. Note that $\mathfrak{B}_{\vec{a}}, \vec{a}^{\mathfrak{B}} \sim_{GF, \Sigma} \mathfrak{A}_{\vec{b}}, \vec{b}^{\mathfrak{A}}$. Let \mathfrak{B}' be an isomorphic copy of \mathfrak{A} disjoint from $\mathfrak{B}_{\vec{a}}$. Interpret the constants in $\mathcal{D} \setminus \mathcal{D}_{con(\vec{a})}$ in \mathfrak{B}' by the copies of their interpretations in \mathfrak{A} . We have $\mathfrak{B}_{\vec{a}} \cup \mathfrak{B}', \vec{a}^{\mathfrak{B}} \sim_{GF, \Sigma} \mathfrak{A}, \vec{b}^{\mathfrak{A}}$

since we can extend the guarded bisimulation witnessing $\mathfrak{B}_{\vec{a}}, \vec{a}^{\mathfrak{B}} \sim_{\text{GF}, \Sigma} \mathfrak{A}_{\vec{b}}, \vec{b}^{\mathfrak{A}}$ by the identity mappings between \mathfrak{B}' and \mathfrak{A} . Then $\mathfrak{B}_{\vec{a}} \cup \mathfrak{B}'$ is a model of \mathcal{O} since \mathfrak{A} is a model of \mathcal{O} and $\mathfrak{B}_{\vec{a}} \cup \mathfrak{B}', \vec{a}^{\mathfrak{B}} \sim_{\text{GF}, \Sigma} \mathfrak{A}, \vec{b}^{\mathfrak{A}}$. Moreover, $\mathfrak{B}_{\vec{a}} \cup \mathfrak{B}'$ is a model of \mathcal{D} by definition. Hence, $\mathfrak{B}_{\vec{a}} \cup \mathfrak{B}'$ is a model \mathcal{K} and we have derived a contradiction.

We have shown that Points 1 to 4 are equivalent. The proof of the equivalence of Point 5 and Points 1 to 4 is based on the same ideas as its counterpart for \mathcal{ALCI} but has to deal with a few additional problems. (1) We admit proper tuples and not only singletons as examples. This leads to various case distinctions and technical issues. For example, we require a lemma that states that a type $\Phi(\vec{x})$ is openGF-complete iff all its restrictions to a single variable are openGF-complete. (2) The unfolding from \mathfrak{A} into $\mathfrak{A}_{\mathcal{D}, b}^{\leq \ell}$ cannot be replicated by an unfolding into a guarded tree-decomposable structures, as one might have hoped. The issue is that the leafs L of the unfolding $\mathfrak{A}_{\mathcal{D}, b}^{\leq \ell}$ should have distance ℓ from the interpretation of the database \mathcal{D} . This is not the case for unfoldings into guarded tree-decomposable structures. Instead, a rather different unfolding is required that takes copies of the whole input structure. (3) Finally, in contrast to \mathcal{ALCI} the structure \mathfrak{C} one constructs can be of infinite outdegree and cannot be easily transformed into a finite model (or model of finite outdegree). To nevertheless use the machinery of guarded bisimulations, we work with bounded guarded bisimulations instead of infinitary ones. A detailed proof dealing with these issues is given in the appendix of this article. \square

Replicating the case of \mathcal{ALCI} , we could now define a notion of strongly incomplete GF-KBs and observe a counterpart of Corollary 26. We refrain from giving the details. Also as for \mathcal{ALCI} , we can reduce projective (GF, GF)-separability to non-projective (GF, GF)-separability in polynomial time and show that a single unary helper symbol always suffices to separate a labeled GF-KB that is projectively GF-separable. We obtain the following in a similar way as Theorem 27.

Theorem 38. *Non-projective (GF, GF)-separability is 2EXPTIME-complete in combined complexity. The same is true for definability, RE-existence, and entity indistinguishability.*

In the special case where the ontology is empty, Point 5(b) of Theorem 37 is vacuously true and thus projective and non-projective GF-separability coincide with FO-separability. This also follows from the observation in the previous section that already non-projective \mathcal{ALCI} -separability coincides with FO-separability if the ontology is empty and the fact that \mathcal{ALCI} is contained in GF.

5.3. Separability of Labeled FO^2 -KBs

We show that $(\text{FO}^2, \text{FO}^2)$ - and (FO^2, FO) -separability are undecidable both in the projective and in the non-projective case. We also show that these separation problems do not coincide even in the projective case, in contrast to our results for \mathcal{ALCI} and GF in the previous sections. The latter result is a consequence of a general theorem that states that for all fragments \mathcal{L} of FO enjoying the relativization property and the finite model property but for which rooted UCQ-evaluation is not finitely controllable, projective $(\mathcal{L}, \mathcal{L})$ -separability does not coincide with projective (\mathcal{L}, FO) -separability. In the context of FO^2 , we generally assume that examples are tuples of length one or two and that only unary and binary relation symbols are used.

UCQ-evaluation on FO^2 -KBs is undecidable [73] and the proof easily adapts to rooted UCQs. Together with Theorem 8, we obtain undecidability of (FO^2, FO) -separability both in the projective and non-projective case (which coincide, due to that theorem). We adapt the mentioned undecidability proof to show that projective and non-projective $(\text{FO}^2, \mathcal{L}_S)$ -separability is undecidable for every FO-fragment \mathcal{L}_S that contains FO^2 . The same is true for definability, RE-existence, and entity distinguishability.

Theorem 39. *For all FO-fragments $\mathcal{L}_S \supseteq \text{FO}^2$, projective and non-projective $(\text{FO}^2, \mathcal{L}_S)$ -separability are undecidable. This is also true for definability, RE-existence, and entity distinguishability.*

The proof of Theorem 39 is by reduction from tiling problems which we introduce next. A *tiling system* is a triple (T, H, V) with T a finite set and $H, V \subseteq T \times T$. A *solution* to (T, H, V) is a function $\tau : \mathbb{N} \times \mathbb{N}$ such that, for all $i, j \geq 0$:

- (i) $(\tau(i, j), \tau(i + 1, j)) \in H$, and
- (ii) $(\tau(i, j), \tau(i, j + 1)) \in V$.

A solution is *periodic* if there are periods $h, v \geq 1$ such that $\tau(i, j) = \tau(i + h, j) = \tau(i, j + v)$, for all $i, j \geq 0$. Note that a periodic solution can be thought of as a torus, labeled with elements from T consistent with H and V . We say that a tiling system *admits a (periodic) solution*, if there is a (periodic) solution to it. It is well-known that the problem of deciding whether a given tiling system admits a (resp., periodic) solution is undecidable [74]. However, we are going to exploit a stronger undecidability result due to Gurevich and Koryakov [75]; see also [76, Theorem 3.1.7] for a new proof. Recall that two sets A, B are *recursively inseparable* if there is no recursive (that is, decidable) set that contains A and is disjoint from B .

Theorem 40 ([75, 76]). *The set of tiling systems that admit no solution is recursively inseparable from the set of tiling systems that admit a periodic solution.*

Hence, one can show undecidability of a language $L \subseteq \Sigma^*$ by giving a computable function f from tiling systems to Σ^* such that: (i) tiling systems which admit a periodic solution are mapped to L , and (ii) tiling systems without a solution are mapped to $\Sigma^* \setminus L$. We employ this strategy in the following proof of Theorem 39.

Proof. By Observation 6, it suffices to show undecidability for RE-existence and undecidability of separability, definability, and entity distinguishability follow.

Given a tiling system (T, H, V) , we construct a labeled FO^2 -KB $(\mathcal{K}, \{a\}, N)$ with $\mathcal{K} = (\mathcal{O}, \mathcal{D})$ as follows:

$$\mathcal{O} = \{ B \sqsubseteq \exists R_h. B \sqcap \exists R_v. B \tag{1}$$

$$\forall xy (B(x) \wedge B(y) \rightarrow U(x, y)), \tag{2}$$

$$\forall xy (\neg R_v(x, y) \rightarrow \overline{R}_v(x, y)), \tag{3}$$

$$B \sqsubseteq \bigsqcup_{t \in T} (A_t \sqcap \prod_{t' \in T \setminus \{t\}} \neg A_{t'}), \tag{4}$$

$$A_t \sqsubseteq \forall R_v. \bigsqcup_{(t, t') \in V} A_{t'}, \tag{5} \quad \text{for all } t \in T$$

$$A_t \sqsubseteq \forall R_h. \bigsqcup_{(t, t') \in H} A_{t'}, \tag{6} \quad \text{for all } t \in T$$

}

$$\mathcal{D} = \{ U(a, a_1), R_v(a_1, a_2), R_h(a_2, a_3), R_h(a_1, a_4), \overline{R}_v(a_4, a_3), B(b) \}$$

$$N = \{ a_1, a_2, a_3, a_4, b \}$$

The database $\mathcal{D}_{\text{con}(a)}$ can be depicted as follows:

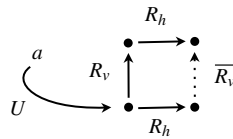

By (the comment after) Theorem 40, it suffices to show the following Claim.

Claim. Let \mathcal{L}_S be an FO-fragment with $\mathcal{L}_S \supseteq \text{FO}^2$. Then, we have:

1. If $(\mathcal{K}, \{a\}, N)$ is projectively or non-projectively \mathcal{L}_S -separable, then (T, H, V) admits a solution.
2. If (T, H, V) admits a periodic solution, then $(\mathcal{K}, \{a\}, N)$ is non-projectively \mathcal{L}_S -separable.

Proof of the Claim. For Point 1, suppose that $(\mathcal{K}, \{a\}, N)$ is projectively or non-projectively \mathcal{L}_S -separable. Thus, $(\mathcal{K}, \{a\}, \{b\})$ is FO-separable. By Theorem 8 and Corollary 10, $\varphi_{\mathcal{D}_{\text{con}(a)}, a}(x)$ separates $(\mathcal{K}, \{a\}, \{b\})$. Let \mathfrak{A} be a structure witnessing $\mathcal{K} \not\models \varphi_{\mathcal{D}_{\text{con}(a)}, a}(b)$. Since \mathfrak{A} is a model of (1)–(3) and $\mathfrak{A} \not\models \varphi_{\mathcal{D}_{\text{con}(a)}, a}(b)$, it contains an infinite grid formed by relations R_v and R_h . Since \mathfrak{A} is a model of (4) every element in the grid is labeled with A_t for a unique element $t \in T$. Finally, since \mathfrak{A} is a model of (5) and (6), the relations H and V are respected along R_h and R_v , respectively.

For Point 2, suppose that (T, H, V) admits a periodic solution τ with periods $h, v \geq 1$. We show that $(\mathcal{K}, \{a\}, N)$ is non-projectively FO^2 -separable under the assumption that \mathcal{K} mentions a binary relation symbol S . This is without loss of generality, as we can include $\forall xy S(x, y) \rightarrow S(x, y)$ in \mathcal{O} .

Let π be a bijection from $[h] \times [v]$ to $[hv]$ and let C_{ij} be the \mathcal{ALCI} -concept (corresponding to an FO^2 -formula) expressing that there is an S -path of length $\pi(i, j)$. We construct the following FO^2 -formula $\varphi_{hv}(x)$, written as an \mathcal{ALCI} -concept:

$$\exists U. \prod_{i \in [h]} \prod_{j \in [v]} (\forall R_v. \forall R_h. C_{ij} \rightarrow \exists R_h. \exists \bar{R}_v. C_{ij}). \quad (7)$$

It should be clear that $\mathcal{K} \models \varphi_{hv}(a)$ since already $\varphi_{\mathcal{D}_{\text{con}(a)}, a}(x) \models \varphi_{hv}(x)$. To see that $\mathcal{K} \not\models \varphi_{hv}(d)$, for all $d \in N$, we construct a (finite) model \mathfrak{A} witnessing that. Informally, \mathfrak{A} consists of two disconnected parts. One part is \mathcal{D} viewed as a structure; the other is an $h \times v$ -torus over binary symbols R_v, R_h in which each element has an outgoing S -path. More precisely, the torus has domain $[h] \times [v]$ and each element (i, j) is labeled with the unary symbol $A_{\tau(i, j)}$ and has an outgoing S -path of length $\pi(i, j)$. Formally, we have:

$$\begin{aligned} B^{\mathfrak{A}} &= [h] \times [v] \\ R_v^{\mathfrak{A}} &= \{(a_1, a_2)\} \cup \{(i, j), (i, j \oplus_v 1) \mid i \in [h], j \in [v]\} \\ R_h^{\mathfrak{A}} &= \{(a_2, a_3), (a_1, a_4)\} \cup \{(i, j), (i \oplus_h 1, j) \mid i \in [h], j \in [v]\} \\ A_t^{\mathfrak{A}} &= \{(i, j) \in [h] \times [v] \mid \tau(i, j) = t\} && \text{for all } t \in T \\ U^{\mathfrak{A}} &= \{(a, a_1)\} \cup ([h] \times [v]) \times ([h] \times [v]) \\ a^{\mathfrak{A}} &= a \quad a_i^{\mathfrak{A}} = a_i, \text{ for } i \in \{1, 2, 3, 4\} \quad b^{\mathfrak{A}} = (0, 0) \end{aligned}$$

and $S^{\mathfrak{A}}$ is as described above and $\bar{R}_v^{\mathfrak{A}}$ is the complement of $R_v^{\mathfrak{A}}$.

It is readily checked that \mathfrak{A} is a model of \mathcal{K} . Moreover, we have $\mathfrak{A} \not\models \varphi_{hv}(a_i)$, for $i \in \{1, \dots, 4\}$, since the a_i do not have U -successors in \mathfrak{A} . Suppose finally that $\mathfrak{A} \models \varphi_{hv}(b)$, let (i_0, j_0) be the U -successor of $b^{\mathfrak{A}}$ that witnesses the big conjunction in (7), and let $i = i_0 \oplus_h 1$ and $j = j_0 \oplus_v 1$. By construction of \mathfrak{A} , we have $\mathfrak{A} \models \forall R_v. \forall R_h. C_{ij}(i_0, j_0)$, but $\mathfrak{A} \not\models \exists R_h. \exists \bar{R}_v. C_{ij}(i_0, j_0)$, in contradiction to the implication in (7). Hence, $\mathfrak{A} \not\models \varphi_{hv}(b)$. This finishes the proof of the Claim and in fact of the Theorem. \square

We next discuss the relationship between FO-separability and FO^2 -separability in labeled FO^2 -KBs. Example 28 shows that (FO^2, FO) -separability and $(\text{FO}^2, \text{FO}^2)$ -separability do not coincide in the non-projective case, since every FO^2 -formula $\varphi(x)$ with $\text{sig}(\varphi) = \{R\}$ is equivalent to $x = x$ or to $\neg(x = x)$ w.r.t. the ontology \mathcal{O} used there. The example also yields that projective and non-projective $(\text{FO}^2, \text{FO}^2)$ -separability do not coincide. We next observe that (FO^2, FO) -separability and $(\text{FO}^2, \text{FO}^2)$ -separability do not coincide also in the projective case, in a more general setting. Note that FO^2 has the finite model property and the relativization property [62]. The following example shows that evaluating rooted CQs on FO^2 -KBs is not finitely controllable using the ontology constructed in the proof of Theorem 39.

Example 41. Let \mathcal{O} be the ontology constructed in the proof of Theorem 39 for a tiling system that admits a solution but does not admit any periodic solution. Let \mathcal{D} be the database used in that proof, $\mathcal{D}' = \{B(b)\}$, $\mathcal{K}' = (\mathcal{O}, \mathcal{D}')$, and consider the rooted CQ $\varphi_{\mathcal{D}_{\text{con}(a)}, a}(x)$. Then $\mathcal{K}' \not\models \varphi_{\mathcal{D}_{\text{con}(a)}, a}(b)$ but $\mathfrak{A} \models \varphi_{\mathcal{D}_{\text{con}(a)}, a}(b)$ for every finite model \mathfrak{A} of \mathcal{K}' . \blacktriangle

Theorem 42. Let \mathcal{L} be a fragment of FO that has the relativization property and the finite model property. Then the following holds:

- If projective (\mathcal{L}, FO) -separability coincides with projective $(\mathcal{L}, \mathcal{L})$ -separability for labeled KBs with a single negative example tuple of length n , then evaluating rooted UCQs of arity n on \mathcal{L} -KBs is finitely controllable;
- if projective (\mathcal{L}, FO) -entity distinguishability coincides with projective $(\mathcal{L}, \mathcal{L})$ -entity distinguishability for example tuples of length n , then evaluating rooted CQs of arity n on \mathcal{L} -KBs is finitely controllable.

Proof. We prove Point 1. Point 2 is a direct consequence of the proof. Assume that evaluating rooted UCQs on \mathcal{L} -KBs is not finitely controllable, that is, there is an \mathcal{L} -KB $\mathcal{K} = (\mathcal{O}, \mathcal{D})$, a rooted UCQ $q(\vec{x}) = \bigvee_{i \in I} q_i(\vec{x})$, $\vec{x} = (x_1, \dots, x_n)$, and a tuple \vec{a} in \mathcal{D} such that $\mathcal{K} \not\models q(\vec{a})$, but $\mathfrak{B} \models q(\vec{a})$ for all finite models \mathfrak{B} of $(\mathcal{O}, \mathcal{D})$. The proof is now very similar to the proof of Corollary 13. Consider the relativization \mathcal{O}_A of the sentences of \mathcal{O} to A and $\mathcal{D}^{+A} = \mathcal{D} \cup \{A(a) \mid a \in \text{cons}(\mathcal{D})\}$, for a fresh unary relation symbol A . Define the labeled KB (\mathcal{K}', P, N) as in the proof of Corollary 13. Then the UCQ $q(\vec{x})$ separates (\mathcal{K}', P, N) but we show that (\mathcal{K}', P, N) is not \mathcal{L} -separable. Suppose there is an \mathcal{L} -formula $\varphi(\vec{x})$ that separates (\mathcal{K}', P, N) . Since \mathcal{L} has the finite model property, there exists a finite model \mathfrak{A}_f of \mathcal{K}' such that $\mathfrak{A}_f \models \neg\varphi(\vec{a})$. As $\mathfrak{B} \models q(\vec{a})$ for all finite models \mathfrak{B} of $(\mathcal{O}, \mathcal{D})$, there exists $i \in I$ with $\mathfrak{A}_f \models q_i(\vec{a})$. Then there is a homomorphism h from $\mathcal{D}_i, ([x_1]^i, \dots, [x_n]^i)$ to \mathfrak{A}_f, \vec{a} witnessing this. We modify \mathfrak{A}_f to obtain a new structure \mathfrak{A}'_f which coincides with \mathfrak{A}_f except that the constants c in \mathcal{D}_i are interpreted as $h(c)$. Then \mathfrak{A}'_f is a model of \mathcal{K}' with $\mathfrak{A}'_f \models \neg\varphi([x_1]^i, \dots, [x_n]^i)$ which contradicts the assumption that $\varphi(\vec{x})$ separates (\mathcal{K}', P, N) . \square

It follows from Example 41 and Theorem 42 that projective (FO^2, FO) -entity distinguishability does not coincide with projective $(\text{FO}^2, \text{FO}^2)$ -entity distinguishability for examples consisting of single constants.

The main idea behind the proof Theorem 42 can also often be applied to FO-fragments \mathcal{L} without the relativization property. We illustrate this for the description logic \mathcal{S} extending \mathcal{ALC} with transitive roles. \mathcal{S} does not enjoy the relativization property since one cannot express that the restriction of a relation R to a concept name is transitive.

Example 43. \mathcal{S} enjoys the finite model property but evaluating rooted CQs is not finitely controllable [77]. To see the latter claim, let $\mathcal{O} = \{A \sqsubseteq \exists R.A\}$ with R a transitive role, $\mathcal{D} = \{A(b)\}$, and $q(x) = \exists y(R(x, y) \wedge R(y, y))$. Let $\mathcal{K} = (\mathcal{O}, \mathcal{D})$. Then $\mathcal{K} \not\models q(b)$ is witnessed by the model \mathfrak{A} of \mathcal{K} consisting of an infinite R -chain with root b and nodes labeled with A . But $q(b)$ is satisfied in every finite model of \mathcal{K} . This example can be used to show that projective $(\mathcal{S}, \mathcal{S})$ -separability does not coincide with (\mathcal{S}, FO) -separability by taking $\mathcal{K}' = (\mathcal{O}, \mathcal{D}')$ with $\mathcal{D}' = \{R(a, c), R(c, c), A(b)\}$ and observing that q separates $(\mathcal{K}', \{a\}, \{b\})$ but that no \mathcal{ALCI} -concept separates $(\mathcal{K}', \{a\}, \{b\})$ (use that \mathcal{S} enjoys the finite model property). \blacktriangle

We note that if the ontology is empty, projective and non-projective FO^2 -separability coincide with FO-separability. This follows from the earlier observation that projective and non-projective \mathcal{ALCI} -separability coincide with FO-separability for empty ontologies and the fact that \mathcal{ALCI} is contained in FO^2 .

6. Fundamental Results on Strong Separability

We introduce strong separability and the special cases of strong definability, referring expression existence, and entity distinguishability. We observe that, in contrast to weak separability, strong projective separability and strong non-projective separability coincide in all relevant cases. We then give a characterization of strong (FO, FO) -separability that has the consequence that also in the context of strong separability UCQs have the same separating power as FO. In contrast to Theorem 8 for weak separability, however, it establishes a link to KB satisfiability rather than to the evaluation of rooted UCQs. We also settle the complexity of deciding strong separability in GNFO.

Definition 44. An FO-formula $\varphi(\vec{x})$ strongly separates a labeled FO-KB (\mathcal{K}, P, N) if

1. $\mathcal{K} \models \varphi(\vec{a})$ for all $\vec{a} \in P$ and
2. $\mathcal{K} \models \neg\varphi(\vec{a})$ for all $\vec{a} \in N$.

Let \mathcal{L}_S be a fragment of FO. We say that (\mathcal{K}, P, N) is strongly projectively \mathcal{L}_S -separable if there is an \mathcal{L}_S -formula $\varphi(\vec{x})$ that strongly separates (\mathcal{K}, P, N) and strongly (non-projectively) \mathcal{L}_S -separable if there is such a $\varphi(\vec{x})$ with $\text{sig}(\varphi) \subseteq \text{sig}(\mathcal{K})$.

By definition, (projective) strong separability implies (projective) weak separability, but the converse is false.

Example 45. Let $\mathcal{K}_1 = (\emptyset, \mathcal{D})$ with

$$\mathcal{D} = \{\text{votes}(a, c_1), \text{votes}(b, c_2), \text{Left}(c_1), \text{Right}(c_2)\}.$$

Then $(\mathcal{K}_1, \{a\}, \{b\})$ is weakly separated by the \mathcal{ALCI} -concept $\exists\text{votes.Left}$, but it is not strongly FO-separable.

Now let $\mathcal{K}_2 = (O, \mathcal{D})$ with

$$O = \{\exists\text{votes.Left} \sqsubseteq \neg\exists\text{votes.Right}\}.$$

Then $\exists\text{votes.Left}$ strongly separates $(\mathcal{K}_2, \{a\}, \{b\})$. ▲

As illustrated by Example 45, ‘negative information’ introduced by the ontology is crucial for strong separability because of the open world semantics and since the database cannot contain negative information. In fact, labeled KBs with an empty ontology are never strongly separable. In a sense, weak separability tends to be too credulous if the data is incomplete regarding positive information, see Example 4, while strong separability tends to be too sceptical if the data is incomplete regarding negative information as shown by Example 45. Note also that while weak (FO, FO)-separability is anti-monotone in the ontology, strong separability is always trivially monotone in the ontology (and also the database) in the sense that for all labeled KBs (\mathcal{K}_i, P, N) with $\mathcal{K}_i = (O_i, \mathcal{D}_i)$ for $i = 1, 2$, if $O_1 \subseteq O_2$, $\mathcal{D}_1 \subseteq \mathcal{D}_2$, and (\mathcal{K}_1, P, N) is \mathcal{L}_S -separable, then (\mathcal{K}_2, P, N) is \mathcal{L}_S -separable.

In contrast to weak separability, projective and non-projective strong separability coincide in all cases that are relevant to this paper. From now on, we thus omit these qualifications.

Proposition 46. *Let (\mathcal{K}, P, N) be an FO-KB and let $\mathcal{L}_S \in \{\text{CQ}, \text{UCQ}, \mathcal{ALCI}, \text{GF}, \text{openGF}, \text{GNFO}, \text{FO}^2, \text{FO}\}$. Then (\mathcal{K}, P, N) is strongly projectively \mathcal{L}_S -separable iff it is strongly non-projectively \mathcal{L}_S -separable.*

Proof. Assume $\varphi(\vec{x})$ strongly separates (\mathcal{K}, P, N) and $R \in \text{sig}(\varphi) \setminus \text{sig}(\mathcal{K})$. Intuitively, we can replace every occurrence of any formula of the form $R(\vec{y})$ in $\varphi(\vec{x})$ by a tautology (or an unsatisfiable formula) formulated in $\text{sig}(\mathcal{K})$ without affecting separation as the KB does not state anything about such R . If \mathcal{L}_S is FO, then we can simply replace $R(\vec{y})$ by the conjunction of all $y = y$ with y in \vec{y} . In other choices of \mathcal{L}_S , a bit more care is needed: for example, the formula obtained in this way is not guarded if R occurs as a guard in φ . In this case we replace every subformula of the form $\exists\vec{y}(R(\vec{z}, \vec{y}) \wedge \psi)$ in $\varphi(\vec{x})$ by (the unsatisfiable formula) $\neg(x = x)$ for some x in \vec{x} and every occurrence of $R(\vec{y})$ in $\varphi(\vec{x})$ in a non-guard position by $\neg(y = y)$ for some y in \vec{y} . For \mathcal{ALCI} , assume that the concept C strongly separates (\mathcal{K}, P, N) and $X \in \text{sig}(C) \setminus \text{sig}(\mathcal{K})$. If X is a concept name, then replace every occurrence of X in C by \perp and if X is a role name, then replace every subconcept of the form $\exists X.D$ or $\exists X^-.D$ in C by \perp . The other cases can be dealt with similarly. □

Each choice of an ontology language \mathcal{L} and a separation language \mathcal{L}_S thus gives rise to a (single) strong separability problem that we refer to as *strong $(\mathcal{L}, \mathcal{L}_S)$ -separability*, defined in the expected way. We consider again the following special cases of $(\mathcal{L}, \mathcal{L}_S)$ -separability: *strong $(\mathcal{L}, \mathcal{L}_S)$ -definability*, *strong $(\mathcal{L}, \mathcal{L}_S)$ -referring expression existence (RE-existence)*, and *strong $(\mathcal{L}, \mathcal{L}_S)$ -entity distinguishability*, all defined in the obvious way. Our main complexity results for strong separability also hold for strong definability, referring expression existence, and entity distinguishability. In fact, for FO-fragments \mathcal{L}_S closed under conjunction and disjunction, a labeled KB (\mathcal{K}, P, N) is strongly \mathcal{L}_S -separable iff every KB $(\mathcal{K}, \{\vec{a}\}, \{\vec{b}\})$ with $\vec{a} \in P$ and $\vec{b} \in N$ is strongly \mathcal{L}_S -separable. To show this, observe that if $\varphi_{\vec{a}, \vec{b}}$ strongly separates $(\mathcal{K}, \{a\}, \{b\})$ for all $\vec{a} \in P$ and $\vec{b} \in N$, then $\bigvee_{\vec{a} \in P} \bigwedge_{\vec{b} \in N} \varphi_{\vec{a}, \vec{b}}$ strongly separates (\mathcal{K}, P, N) . The converse direction is trivial: if φ strongly separates (\mathcal{K}, P, N) , then it strongly separates all $(\mathcal{K}, \{\vec{a}\}, \{\vec{b}\})$ with $\vec{a} \in P$ and $\vec{b} \in N$.

Observation 47. *Let \mathcal{L} and \mathcal{L}_S be fragments of FO such that \mathcal{L}_S is closed under conjunction and disjunction. Then there is a polynomial time Turing reduction of strong $(\mathcal{L}, \mathcal{L}_S)$ -separability to strong $(\mathcal{L}, \mathcal{L}_S)$ -entity distinguishability.*

We will thus mostly consider entity distinguishability when proving complexity upper bounds and RE-existence when proving complexity lower bounds. We next characterize strong (FO, FO)-separability in terms of KB unsatisfiability and show that strong (FO, FO)-separability coincides with strong (FO, UCQ)-separability. Let \mathcal{D} be a database and let $\vec{a} = (a_1, \dots, a_n)$ and $\vec{b} = (b_1, \dots, b_n)$ be tuples of constants in \mathcal{D} . We write $\mathcal{D}_{\vec{a}=\vec{b}}$ to denote the database obtained by taking $\mathcal{D} \cup \mathcal{D}'$, \mathcal{D}' a copy of \mathcal{D} with fresh constants c' for $c \in \text{cons}(\mathcal{D})$, and then identifying a_i and the copy b'_i of b_i for $1 \leq i \leq n$. For example, for $\mathcal{D} = \{R(a, b), S(b, c), A(a), B(b)\}$ we have $\mathcal{D}_{a=b} = \{R(a, b), S(b, c), A(a), B(b), R(a', a), S(a, c'), A(a'), B(a)\}$, where $a', c' \in \text{Const}$ are ‘copies’ of a and c respectively and we identify the copy b' of b with a .

Theorem 48. *Let (\mathcal{K}, P, N) be a labeled FO-KB, $\mathcal{K} = (O, \mathcal{D})$. Then the following conditions are equivalent:*

1. (\mathcal{K}, P, N) is strongly UCQ-separable;
2. (\mathcal{K}, P, N) is strongly FO-separable;
3. for all $\vec{a} \in P$ and $\vec{b} \in N$, the KB $(\mathcal{O}, \mathcal{D}_{\vec{a}=\vec{b}})$ is unsatisfiable;
4. the UCQ $\bigvee_{\vec{a} \in P} \varphi_{\mathcal{D}_{\text{con}(\vec{a}), \vec{a}}}$ strongly separates (\mathcal{K}, P, N) .

Proof. “1. \Rightarrow 2.” is trivial. “2. \Rightarrow 3.” Assume that $\varphi(\vec{x})$ strongly separates (\mathcal{K}, P, N) but that there are $\vec{a} \in P$ and $\vec{b} \in N$ such that $(\mathcal{O}, \mathcal{D}_{\vec{a}=\vec{b}})$ is satisfiable. Take a model \mathfrak{A} of $(\mathcal{O}, \mathcal{D}_{\vec{a}=\vec{b}})$. Then \mathfrak{A} is a model of \mathcal{K} and so $\mathfrak{A} \models \varphi(\vec{a})$. Hence $\mathfrak{A} \models \varphi(\vec{b}')$ since $\vec{a} = \vec{b}'$. Then \mathfrak{A} gives rise to another model of \mathcal{K} with $\mathfrak{A} \models \varphi(\vec{b})$ by reinterpreting the constants in \mathcal{D} by setting $c^{\mathfrak{A}} = c'^{\mathfrak{A}}$ for all $c \in \text{cons}(\mathcal{D})$. This contradicts the assumption that $\mathcal{K} \models \neg\varphi(\vec{b})$.

“3. \Rightarrow 4.” Assume that $\bigvee_{\vec{a} \in P} \varphi_{\mathcal{D}_{\text{con}(\vec{a}), \vec{a}}}$ does not strongly separate (\mathcal{K}, P, N) . Then there are $\vec{a} \in P$, $\vec{b} \in N$, and a model \mathfrak{A} of \mathcal{K} such that $\mathfrak{A} \models \varphi_{\mathcal{D}_{\text{con}(\vec{a}), \vec{a}}}(\vec{b})$. One can now interpret the constants of $\mathcal{D}_{\vec{a}=\vec{b}}$ in such a way that \mathfrak{A} becomes a model of $\mathcal{D}_{\vec{a}=\vec{b}}$: assume that ν is a variable assignment witnessing $\mathfrak{A} \models \varphi_{\mathcal{D}_{\text{con}(\vec{a}), \vec{a}}}(\vec{b})$. Then set $c'^{\mathfrak{A}} = c^{\mathfrak{A}}$ for $c \in \text{cons}(\mathcal{D})$ and reinterpret the constants from $\text{cons}(\mathcal{D}_{\text{con}(\vec{a})})$ in \mathfrak{A} by setting $c^{\mathfrak{A}} = \nu(x_c)$ for $c \in \text{cons}(\mathcal{D}_{\text{con}(\vec{a})})$, with x_c the variable corresponding to c . Then \mathfrak{A} is a model of $(\mathcal{O}, \mathcal{D}_{\vec{a}=\vec{b}})$ and so the KB $(\mathcal{O}, \mathcal{D}_{\vec{a}=\vec{b}})$ is satisfiable.

“4. \Rightarrow 1.” is trivial. \square

Note that the UCQ in Point 4 of Theorem 48 is a concrete separating formula of polynomial size, and that it is identical to the UCQ in Point 4 of Theorem 8. Point 3 provides the announced link to KB unsatisfiability. We also obtain the following counterpart of Corollary 9 and 10.

Corollary 49. *Strong (FO, FO)-separability coincides with strong (FO, \mathcal{L}_S)-separability for all FO-fragments $\mathcal{L}_S \supseteq \text{UCQ}$. This also holds for strong RE-existence and strong entity distinguishability for all FO-fragments $\mathcal{L}_S \supseteq \text{CQ}$.*

Recall that GNFO contains UCQ and that satisfiability of GNFO-KBs is 2ExpTime-complete in combined complexity and NP-complete in data complexity [55, 78]. This directly implies the following complexity upper bounds for strong separability on GNFO-KBs.

Corollary 50. *For all FO-fragments $\mathcal{L}_S \supseteq \text{UCQ}$,*

1. *strong (GNFO, GNFO)-separability coincides with strong (GNFO, \mathcal{L}_S)-separability, and the same is true for definability;*
2. *strong (GNFO, \mathcal{L}_S)-separability and (GNFO, \mathcal{L}_S)-definability are 2ExpTime-complete in combined complexity and coNP-complete in data complexity.*

This holds also for strong RE-existence and strong entity distinguishability, for all FO-fragments $\mathcal{L}_S \supseteq \text{CQ}$.

Proof. It remains to prove the lower bounds. For the coNP lower bound in data complexity, we give a reduction of the complement of 3-colorability to entity distinguishability and to RE-existence. coNP-hardness of separability and definability follow trivially. Let \mathcal{O} contain the \mathcal{ALCI} -CIs

$$\top \sqsubseteq L_1 \sqcup L_2 \sqcup L_3, \quad L_i \sqcap \exists R.L_i \sqsubseteq E, \quad \exists R.E \sqsubseteq E, \quad E \sqcap A \sqcap B \sqsubseteq \perp$$

for all $i \in \{1, 2, 3\}$. For the polynomial time reduction, consider any connected undirected graph G and let \mathcal{D} be defined as the set of all $R(c, d), R(d, c)$ with $\{c, d\}$ an edge in G . We may assume that G contains at least two nodes. For the reduction to strong (GNFO, GNFO)-entity distinguishability take two constants $a, b \in \text{cons}(\mathcal{D})$ and obtain \mathcal{D}' by adding $A(a)$ and $B(b)$ to \mathcal{D} . Let $\mathcal{K} = (\mathcal{O}, \mathcal{D}')$. Then G is not 3-colorable iff $(\mathcal{O}, \mathcal{D}) \models E(c)$ for all $c \in \text{cons}(\mathcal{D})$ iff $(\mathcal{O}, \mathcal{D}'_{a=b})$ is not satisfiable iff $(\mathcal{K}, \{a\}, \{b\})$ is strongly (GNFO, GNFO)-separable. For the reduction to strong (GNFO, GNFO)-referring expression existence take a constant $a \in \text{cons}(\mathcal{D})$ and obtain \mathcal{D}' by adding $A(a)$ and $B(c)$, $c \in N := \text{cons}(\mathcal{D}) \setminus \{a\}$ to \mathcal{D} . Let $\mathcal{K} = (\mathcal{O}, \mathcal{D}')$. Then G is not 3-colorable iff $(\mathcal{O}, \mathcal{D}) \models E(c)$ for all $c \in \text{cons}(\mathcal{D})$ iff $(\mathcal{O}, \mathcal{D}'_{a=c})$ is not satisfiable for any $c \in N$ iff $(\mathcal{K}, \{a\}, N)$ is strongly (GNFO, GNFO)-separable.

For the 2ExpTime lower bound in combined complexity, it follows from [55, 78] that it is 2ExpTime-hard to decide for a GNFO-ontology \mathcal{O} and a unary relational symbol E whether $\mathcal{O} \models \forall x E(x)$. Assume now that a GNFO-ontology \mathcal{O} and E are given. Let $\mathcal{K} = (\mathcal{O}', \mathcal{D})$, where $\mathcal{O}' = \mathcal{O} \cup \{A \sqcap B \sqcap E \sqsubseteq \perp\}$ and $\mathcal{D} = \{A(a), B(b)\}$ with A

and B fresh unary relation symbols. Then $O \models \forall x E(x)$ iff $(O', \mathcal{D}_{a=b})$ is not satisfiable iff $(\mathcal{K}, \{a\}, \{b\})$ is strongly (GNFO, GNFO)-separable. The labeled KB $(\mathcal{K}, \{a\}, \{b\})$ also shows 2ExpTime-hardness of definability, RE-existence and entity distinguishability. \square

7. Strong Separability for Decidable Fragments of FO

We study strong $(\mathcal{L}, \mathcal{L})$ -separability for $\mathcal{L} \in \{\mathcal{ALCI}, \text{GF}, \text{FO}^2\}$. We show that for all these cases, strong $(\mathcal{L}, \mathcal{L})$ -separability coincides with strong (\mathcal{L}, FO) -separability and thus we can use the link to KB unsatisfiability provided by Theorem 48 to obtain decidability and tight complexity bounds.

7.1. Strong Separability of Labeled \mathcal{ALCI} -KBs

We show that strong $(\mathcal{ALCI}, \mathcal{ALCI})$ -separability coincides with strong $(\mathcal{ALCI}, \text{FO})$ -separability and also prove that strong $(\mathcal{ALCI}, \mathcal{ALCI})$ -separability is ExpTime-complete in combined complexity and coNP-complete in data complexity. With \mathcal{K} -types, we mean the types introduced for \mathcal{ALCI} in Section 5.1. We identify a type with the conjunction of concepts in it.

Theorem 51. *For every labeled \mathcal{ALCI} -KB (\mathcal{K}, P, N) , the following conditions are equivalent:*

1. (\mathcal{K}, P, N) is strongly \mathcal{ALCI} -separable;
2. (\mathcal{K}, P, N) is strongly FO-separable;
3. for all $a \in P$ and $b \in N$, there do not exist models \mathfrak{A} and \mathfrak{B} of \mathcal{K} such that $a^{\mathfrak{A}}$ and $b^{\mathfrak{B}}$ realize the same \mathcal{K} -type;
4. the \mathcal{ALCI} -concept $t_1 \sqcap \dots \sqcap t_n$ strongly separates (\mathcal{K}, P, N) , t_1, \dots, t_n the \mathcal{K} -types realizable in \mathcal{K} , a for some $a \in P$.

Proof. “1. \Rightarrow 2.”, “3. \Rightarrow 4.”, and “4. \Rightarrow 1.” are straightforward. For “2. \Rightarrow 3.”, let $\mathcal{K} = (O, \mathcal{D})$ and assume that Point 3 does not hold, that is, there exist models \mathfrak{A} and \mathfrak{B} of \mathcal{K} and $a \in P$, $b \in N$ such that $\text{tp}_{\mathcal{K}}(\mathfrak{A}, a^{\mathfrak{A}}) = \text{tp}_{\mathcal{K}}(\mathfrak{B}, b^{\mathfrak{B}})$. We prove that $(O, \mathcal{D}_{a=b})$ is satisfiable. This implies that (\mathcal{K}, P, N) is not strongly FO-separable by Theorem 48.

By reinterpreting constants, we can achieve that \mathfrak{B} is a model of the database \mathcal{D}' from the definition of $\mathcal{D}_{a=b}$. Let $\mathfrak{A} \uplus \mathfrak{B}$ be the disjoint union of \mathfrak{A} and \mathfrak{B} . Define the structure \mathfrak{C} as $\mathfrak{A} \uplus \mathfrak{B}$ in which $a^{\mathfrak{A}}$ and $b^{\mathfrak{B}}$ are identified. There is an obvious surjection $f : \text{dom}(\mathfrak{A} \uplus \mathfrak{B}) \rightarrow \text{dom}(\mathfrak{C})$ that maps every individual to itself except that $f(a^{\mathfrak{A}}) = f(b^{\mathfrak{B}}) = a^{\mathfrak{C}}$. Using the fact that $\text{tp}_{\mathcal{K}}(\mathfrak{A}, a^{\mathfrak{A}}) = \text{tp}_{\mathcal{K}}(\mathfrak{B}, b^{\mathfrak{B}})$ and a simple induction on the structure of concepts C , we can show that for all $C \in \text{cl}(\mathcal{K})$ and $d \in \text{dom}(\mathfrak{A} \uplus \mathfrak{B})$, $d \in C^{\mathfrak{A} \uplus \mathfrak{B}}$ iff $f(d) \in C^{\mathfrak{C}}$. Since \mathfrak{A} and \mathfrak{B} are models of O , it follows that \mathfrak{C} is a model of O . By construction, it is also a model of $\mathcal{D}_{a=b}$. \square

Note that Point 4 of Theorem 51 provides concrete separating concepts. These are not illuminating, but of size at most $2^{p(|O|)}$, p a polynomial. In contrast to the case of weak separability, the length of separating concepts is thus independent of \mathcal{D} . Satisfiability of \mathcal{ALCI} -KBs is ExpTime-complete [58] in combined complexity and NP-complete in data complexity. Hence, strong $(\mathcal{ALCI}, \mathcal{ALCI})$ -separability is in ExpTime in combined complexity and in coNP in data complexity.

Corollary 52. *For any FO-fragment $\mathcal{L}_S \supseteq \text{UCQ}$:*

1. strong $(\mathcal{ALCI}, \mathcal{ALCI})$ -separability coincides with strong $(\mathcal{ALCI}, \mathcal{L}_S)$ -separability, the same is true for definability;
2. strong $(\mathcal{ALCI}, \mathcal{ALCI})$ -separability and strong $(\mathcal{ALCI}, \mathcal{ALCI})$ -definability are ExpTime-complete in combined complexity and coNP-complete in data complexity.

This also holds for strong RE-existence and entity distinguishability, for all FO-fragments $\mathcal{L}_S \supseteq \text{CQ}$.

Proof. It remains to consider the lower bounds. The ontology O used in the proof of coNP-hardness in data complexity for GNFO in Corollary 50 is an \mathcal{ALCI} -ontology. The lower bounds in data complexity therefore follow directly from that proof. The ExpTime lower bound in combined complexity can also be proved in the same way as the 2ExpTime-lower bound in Corollary 50 using the fact that it is ExpTime-hard to decide whether $O \models \top \sqsubseteq A$ for \mathcal{ALCI} -ontologies O [58]. \square

7.2. Strong Separability of Labeled GF-KBs

We show that strong (GF, GF)-separability and strong (GF, openGF) coincide with strong (GF, FO)-separability and that both are 2EXPTIME-complete in combined complexity and coNP-complete in data complexity. We also show that the length of strongly separating GF-formulas is independent from the database \mathcal{D} but that this is not the case for strongly separating openGF-formulas. With \mathcal{K} -types, we mean the types introduced for GF in Section 5.2. We identify a type with the conjunction of its formulas. We begin by formulating a counterpart of Theorem 51 for GF.

Theorem 53. *For every labeled GF-KB (\mathcal{K}, P, N) , the following conditions are equivalent:*

1. (\mathcal{K}, P, N) is strongly GF-separable;
2. (\mathcal{K}, P, N) is strongly FO-separable;
3. for all $\vec{a} \in P$ and $\vec{b} \in N$, there do not exist models \mathfrak{A} and \mathfrak{B} of \mathcal{K} such that $\vec{a}^{\mathfrak{A}}$ and $\vec{b}^{\mathfrak{B}}$ realize the same \mathcal{K} -type;
4. the GF-formula $\Phi_1(\vec{x}) \vee \dots \vee \Phi_n(\vec{x})$ strongly separates (\mathcal{K}, P, N) , $\Phi_1(\vec{x}), \dots, \Phi_n(\vec{x})$ the \mathcal{K} -types realizable in \mathcal{K}, \vec{a} for some $\vec{a} \in P$.

Proof. The proof is similar to the proof of Theorem 51. The implication “2. \Rightarrow 3.” relies on the fact that one can merge models \mathfrak{A} and \mathfrak{B} of a GF-KB \mathcal{K} which realize the same \mathcal{K} -type $\Phi(\vec{x})$ at tuples \vec{a} and \vec{b} , respectively, by identifying the interpretation of the tuples and obtain a model of \mathcal{K} realizing $\Phi(\vec{x})$. \square

It follows that the size of strongly separating GF-formulas is at most $2^{2^{p(|\mathcal{O}|)}}$, p a polynomial, and thus does not depend on the database. Interestingly, we can use a variation of Example 30 to show that this is not the case for separating openGF-formulas. It follows also that GF and openGF differ in terms of the size of strongly separating formula.

Example 54. Define a GF-ontology \mathcal{O} as follows:

$$\mathcal{O} = \{A_1 \sqsubseteq \forall S.A_1, \quad A_2 \sqsubseteq \forall R.A_2, \quad E_2 \sqcap A_1 \sqsubseteq \exists u.B, \quad E_1 \sqcap A_2 \sqsubseteq \neg \exists u.B\}.$$

Here, u denotes the universal role as discussed earlier. For example, $E_2 \sqcap A_1 \sqsubseteq \exists u.B$ is logically equivalent to $\forall x(E_2(x) \wedge A_1(x) \rightarrow \exists yB(y))$. Note that the first two CIs propagate A_1 and A_2 along the role names S and R , respectively, and that according to the remaining CIs $E_2 \sqcap A_1$ and $E_1 \sqcap A_2$ enforce that B is non-empty and empty, respectively. It follows, in particular, that $E_2 \sqcap A_1$ and $E_1 \sqcap A_2$ cannot both be satisfied in a model of \mathcal{O} . Let

$$\mathcal{D}_n = \{A_1(a_0), E_1(c_n), R(a_0, c_1), \dots, R(c_{n-1}, c_n)\} \cup \{A_2(b_0), E_2(d_n), S(b_0, d_1), \dots, S(d_{n-1}, d_n)\}.$$

Thus, we have an R -chain starting at $A_1(a_0)$ and an S -chain starting at $A_2(b_0)$. Let $\mathcal{K}_n = (\mathcal{O}, \mathcal{D}_n)$ and let $P = \{a_0\}$ and $N = \{b_0\}$. In GF (in fact in \mathcal{ALC} with the universal role) the following formula strongly separates (\mathcal{K}_n, P, N) :

$$(A_1 \sqcap A_2 \sqcap \neg \exists u.B) \sqcup (A_1 \sqcap \neg A_2).$$

In contrast, any strongly separating formula in openGF has guarded quantifier rank at least n . To show this consider the models \mathfrak{A} and \mathfrak{B} defined in Figure 3 with the constants c_i and d_i interpreted so that they are both models of \mathcal{K}_n . We have $\mathfrak{A}, a_0^{\mathfrak{A}} \sim_{\text{openGF, sig}(\mathcal{K}_n)}^{n-1} \mathfrak{B}, b_0^{\mathfrak{B}}$ and so $\mathfrak{A}, a_0^{\mathfrak{A}}$ and $\mathfrak{B}, b_0^{\mathfrak{B}}$ cannot be distinguished by any openGF-formula of guarded quantifier rank $\leq n - 1$. \blacktriangle

We next show a counterpart of Theorem 29.

Theorem 55. *Strong (GF, GF)-separability coincides with strong (GF, openGF)-separability.*

Proof. The proof uses guarded bisimulations. It suffices to consider labeled KBs with singleton sets of positive and negative examples. Let $(\mathcal{K}, \{\vec{a}\}, \{\vec{b}\})$ be a labeled GF-KB and $\Sigma = \text{sig}(\mathcal{K})$. We show that the following conditions are equivalent:

1. $(\mathcal{K}, \{\vec{a}\}, \{\vec{b}\})$ is strongly openGF-separable;

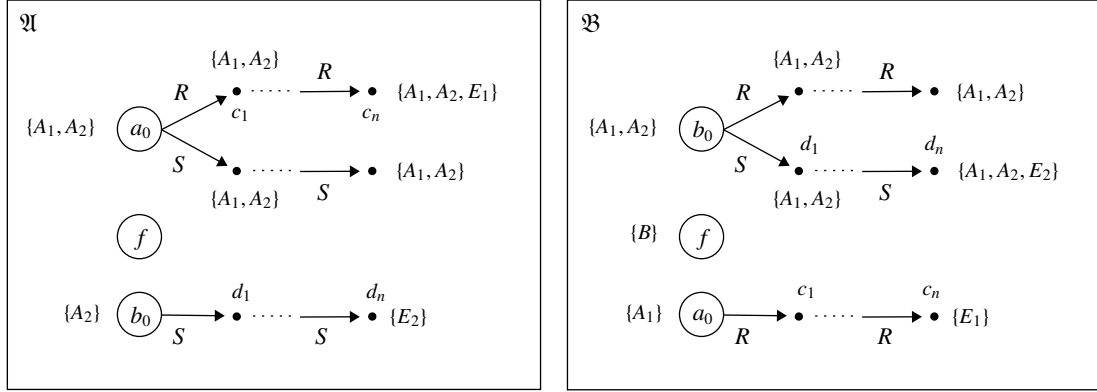

Figure 3: Models \mathfrak{A} and \mathfrak{B} in Example 54.

2. for all models \mathfrak{A} and \mathfrak{B} of \mathcal{K} : $\mathfrak{A}, \vec{a}^{\mathfrak{A}} \sim_{\text{openGF}, \Sigma} \mathfrak{B}, \vec{b}^{\mathfrak{B}}$;
3. for all models \mathfrak{A} and \mathfrak{B} of \mathcal{K} : $\mathfrak{A}, \vec{a}^{\mathfrak{A}} \sim_{\text{GF}, \Sigma} \mathfrak{B}, \vec{b}^{\mathfrak{B}}$;
4. $(\mathcal{K}, \{\vec{a}\}, \vec{b})$ is strongly GF-separable.

The implication “1. \Rightarrow 4.” is trivial and “4. \Rightarrow 3.” follows directly from Lemma 31.

“3. \Rightarrow 2.” Suppose there are models \mathfrak{A} and \mathfrak{B} of \mathcal{K} such that $\mathfrak{A}, \vec{a}^{\mathfrak{A}} \sim_{\text{openGF}, \Sigma} \mathfrak{B}, \vec{b}^{\mathfrak{B}}$. Then one can construct a model \mathfrak{B}' of \mathcal{K} such that $\mathfrak{A}, \vec{a}^{\mathfrak{A}} \sim_{\text{GF}, \Sigma} \mathfrak{B}', \vec{b}^{\mathfrak{B}'}$ in exactly the same way as in the proof of the implication “3. \Rightarrow 4.” of Theorem 37.

“2. \Rightarrow 1.” Suppose $(\mathcal{K}, \{\vec{a}\}, \vec{b})$ is not strongly openGF-separable. Let \vec{x} be a sequence of different variables of the same length as \vec{a} . Let

$$\Gamma_{\vec{a}} = \{\varphi(\vec{x}) \in \text{openGF}(\Sigma) \mid \mathcal{K} \models \varphi(\vec{a})\}, \quad \Gamma_{\vec{b}} = \{\varphi(\vec{x}) \in \text{openGF}(\Sigma) \mid \mathcal{K} \models \varphi(\vec{b})\}$$

Note that $\Gamma_{\vec{a}}$ and $\Gamma_{\vec{b}}$ are both closed under conjunction. Say that a set Γ of formulas in GF of the form $\varphi(\vec{x})$ is *satisfiable in \mathcal{K}, \vec{a}* if the set of first-order formulas $\mathcal{O} \cup \mathcal{D} \cup \{\varphi(\vec{a}) \mid \varphi(\vec{x}) \in \Gamma\}$ is satisfiable. We show that $\Gamma_{\vec{a}} \cup \Gamma_{\vec{b}}$ is satisfiable in \mathcal{K}, \vec{a} and in \mathcal{K}, \vec{b} . Assume that this is not the case for \mathcal{K}, \vec{a} (the case \mathcal{K}, \vec{b} is considered in the same way). Then it follows that $\Gamma_{\vec{b}}$ is not satisfiable in \mathcal{K}, \vec{a} . By compactness and closure under conjunction, there exists $\varphi(\vec{x}) \in \Gamma_{\vec{b}}$ such that $\mathcal{K} \models \neg\varphi(\vec{a})$. As $\mathcal{K} \models \varphi(\vec{b})$ this contradicts the assumption that $(\mathcal{K}, \{\vec{a}\}, \{\vec{b}\})$ is not strongly openGF-separable.

Now, let $\Gamma_0 = \Gamma_{\vec{a}} \cup \Gamma_{\vec{b}}$ and consider an enumeration $\varphi_1, \varphi_2, \dots$ of the remaining $\text{openGF}(\Sigma)$ -formulas of the form $\varphi(\vec{x})$. Then we set inductively $\Gamma_{i+1} = \Gamma_i \cup \{\varphi_{i+1}\}$ if $\Gamma_i \cup \{\varphi_{i+1}\}$ is satisfiable in both \mathcal{K}, \vec{a} and \mathcal{K}, \vec{b} and set $\Gamma_{i+1} = \Gamma_i \cup \{\neg\varphi_{i+1}\}$ otherwise. Let $\Gamma = \bigcup_{i \geq 0} \Gamma_i$. One can now easily show that Γ is satisfiable in both \mathcal{K}, \vec{a} and \mathcal{K}, \vec{b} . Hence there exist models \mathfrak{A} and \mathfrak{B} of \mathcal{K} such that $\mathfrak{A} \models \varphi(\vec{a})$ and $\mathfrak{B} \models \varphi(\vec{b})$ for all $\varphi \in \Gamma$. Thus, by definition, $\mathfrak{A}, \vec{a}^{\mathfrak{A}} \equiv_{\text{openGF}, \Sigma} \mathfrak{B}, \vec{b}^{\mathfrak{B}}$. Any structure \mathfrak{C} is a substructure of an ω -saturated structure \mathfrak{C}' satisfying the same FO-formulas $\varphi(\vec{c})$ with \vec{c} tuples in $\text{dom}(\mathfrak{C})$ regarded as constants [60]. Hence we may assume that \mathfrak{A} and \mathfrak{B} are ω -saturated. By Lemma 31, we obtain $\mathfrak{A}, \vec{a}^{\mathfrak{A}} \sim_{\text{openGF}, \Sigma} \mathfrak{B}, \vec{b}^{\mathfrak{B}}$, as required. \square

Satisfiability of GF-KBs is 2EXPTIME-complete in combined complexity and NP-complete in data complexity [53]. We obtain the following.

Corollary 56. *For any FO-fragment $\mathcal{L}_S \supseteq \text{UCQ}$:*

1. *strong (GF, GF)-separability, strong (GF, openGF), and strong (GF, \mathcal{L}_S)-separability coincide, the same is true for definability;*
2. *strong (GF, GF)-separability and strong (GF, GF)-definability are 2EXPTIME-complete in combined complexity and coNP-complete in data complexity.*

This also holds for RE-existence and entity distinguishability, for all FO-fragments $\mathcal{L}_S \supseteq CQ$.

Proof. It remains to prove the lower bounds. As \mathcal{ALCI} is a fragment of GF, the ontology \mathcal{O} used in the proof of coNP-hardness in data complexity in Corollary 50 is a GF-ontology. The coNP lower bounds in data complexity follow directly from that proof. The 2ExpTIME lower bound in combined complexity can also be proved in the same way as the 2ExpTIME-lower bound in Corollary 50 by using the fact that it is 2ExpTIME-hard to decide whether $\mathcal{O} \models \forall x A(x)$ for GF-ontologies \mathcal{O} [53]. \square

7.3. Strong Separability of Labeled FO^2 -KBs

We show that in contrast to weak separability, strong (FO^2, FO^2) -separability is decidable and coincides with strong (FO^2, FO) -separability. The proof strategy is the same as for \mathcal{ALCI} and GF and thus we first need a suitable notion of type for FO^2 -KBs. Existing such notions, such as the types defined in [56], are not strong enough for our purposes, and so we define and work with a more powerful notion of type. We can then once more establish a theorem that parallels Theorem 51 and show that strong separability has the same complexity as non-satisfiability of KBs, both in combined complexity (coNExpTIME-complete) and in data complexity (coNP-complete).

We start by introducing appropriate types for FO^2 -KBs. Recall that we assume that FO^2 uses unary and binary relation symbols only and that positive and negative examples are either constants or pairs of constants. Assume that $\mathcal{K} = (\mathcal{O}, \mathcal{D})$ is an FO^2 -KB. Let $cl(\mathcal{K})$ denote the closure under single negation and swapping the variables x, y of the set of subformulas of formulas in \mathcal{O} and $\{R(x, x), R(x, y), A(x) \mid R, A \in \text{sig}(\mathcal{K})\}$. The *1-type for \mathcal{K}* of a pointed structure \mathfrak{A}, a , denoted $\text{tp}_{\mathcal{K}}(\mathfrak{A}, a)$, is the set of all formulas $\psi(x) \in cl(\mathcal{K})$ such that $\mathfrak{A} \models \psi(a)$. We denote by $T_x(\mathcal{K})$ the set of all 1-types for \mathcal{K} . We say that $t(x) \in T_x(\mathcal{K})$ is *realized* in \mathfrak{A}, a if $t(x) = \text{tp}_{\mathcal{K}}(\mathfrak{A}, a)$. Denote by $t(x)[y/x]$ the set of formulas obtained from $t(x)$ by swapping y and x .

The *2-type for \mathcal{K}* of a pointed structure \mathfrak{A}, a, b , denoted $\text{tp}_{\mathcal{K}}(\mathfrak{A}, a, b)$, is the set of all $R(x, y)$ with $\mathfrak{A} \models R(a, b)$, $R(y, x)$ with $\mathfrak{A} \models R(b, a)$, $\neg R(x, y)$ with $\mathfrak{A} \not\models R(a, b)$, and $\neg R(y, x)$ with $\mathfrak{A} \not\models R(b, a)$, where R is a binary relation in \mathcal{K} . In addition, $x = y \in \text{tp}_{\mathcal{K}}(\mathfrak{A}, a, b)$ if $a = b$ and $\neg(x = y) \in \text{tp}_{\mathcal{K}}(\mathfrak{A}, a, b)$ if $a \neq b$. We denote by $T_{x,y}(\mathcal{K})$ the set of all 2-types for \mathcal{K} . We say that $t(x, y) \in T_{x,y}(\mathcal{K})$ is *realized* in \mathfrak{A}, a, b if $t(x, y) = \text{tp}_{\mathcal{K}}(\mathfrak{A}, a, b)$.

Types as defined above are not yet sufficiently powerful to ensure that models of \mathcal{K} can be merged at nodes satisfying the same type. To achieve this we introduce extended types. For $t \in T_x(\mathcal{K})$, let

$$\text{king}(t) = \forall y(t[y/x] \rightarrow (x = y)),$$

where here and in what follows we identify a type t or set $t[y/x]$ with the conjunction of the formulas they contain. Thus $\text{king}(t)$ states that t is realized at most once. Now, an extended type states not only which formulas in $cl(\mathcal{K})$ are satisfied but also, for example, which types are kings and which binary relations hold between realized kings. In detail, the *extended 2-type for \mathcal{K}* of a pointed structure \mathfrak{A}, a, b , denoted $\text{tp}_{\mathcal{K}}^*(\mathfrak{A}, a, b)$, is the conjunction of

1. $\text{tp}_{\mathcal{K}}(\mathfrak{A}, a, b) \wedge \text{tp}_{\mathcal{K}}(\mathfrak{A}, a) \wedge \text{tp}_{\mathcal{K}}(\mathfrak{A}, b)[y/x]$ (stating which 1-types are realized in a and b and which relations hold between a and b);
2. $\exists y(\text{tp}_{\mathcal{K}}(\mathfrak{A}, a, c) \wedge \text{tp}_{\mathcal{K}}(\mathfrak{A}, c)[y/x])$ for any $c \in \text{dom}(\mathfrak{A}) \setminus \{a, b\}$ such that $\text{tp}_{\mathcal{K}}(\mathfrak{A}, c)$ is realized exactly once in \mathfrak{A} (stating which binary relations hold between a and king types);
3. $\exists x(\text{tp}_{\mathcal{K}}(\mathfrak{A}, c, b) \wedge \text{tp}_{\mathcal{K}}(\mathfrak{A}, c)[x/y])$ for any $c \in \text{dom}(\mathfrak{A}) \setminus \{a, b\}$ such that $\text{tp}_{\mathcal{K}}(\mathfrak{A}, c)$ is realized exactly once in \mathfrak{A} (stating which binary relations hold between b and king types);
4. $\neg \exists x t$, for any $t \in T_x(\mathcal{K})$ not realized in \mathfrak{A} (stating which types are not realized);
5. $\exists x(t \wedge \text{king}(t))$ if $t \in T_x(\mathcal{K})$ is realized exactly once in \mathfrak{A} (stating which types are king types);
6. $\exists x(t \wedge \neg \text{king}(t))$ if $t(x) \in T_x(\mathcal{K})$ is realized at least twice in \mathfrak{A} (stating which types are realized at least twice);
7. $\exists xy \text{tp}_{\mathcal{K}}(\mathfrak{A}, c, d) \wedge \text{tp}_{\mathcal{K}}(\mathfrak{A}, c) \wedge \text{tp}_{\mathcal{K}}(\mathfrak{A}, d)[y/x]$ for any $c \neq d$ such that $\text{tp}_{\mathcal{K}}(\mathfrak{A}, c)$ and $\text{tp}_{\mathcal{K}}(\mathfrak{A}, d)$ are realized exactly once in \mathfrak{A} (stating which relations hold between king types).

We denote by $T_{x,y}^*(\mathcal{K})$ the set of all extended 2-types for \mathcal{K} . We say that $t(x,y) \in T_{x,y}^*(\mathcal{K})$ is *realized* in \mathfrak{A}, a, b if $t(x,y) = \text{tp}_{\mathcal{K}}^*(\mathfrak{A}, a, b)$. The *extended 1-type* for \mathcal{K} of a pointed structure \mathfrak{A}, a is defined in the same way with $\text{tp}_{\mathcal{K}}(\mathfrak{A}, a, b), \text{tp}_{\mathcal{K}}(\mathfrak{A}, b)[y/x]$ removed in Point 1 and with Point 3 completely removed. We also define the realization of such types by pointed structures as expected.

Theorem 57. *For every labeled FO²-KB such that the tuples in $P \cup N$ have length $i \in \{1, 2\}$, the following are equivalent:*

1. (\mathcal{K}, P, N) is strongly FO²-separable;
2. (\mathcal{K}, P, N) is strongly FO-separable;
3. for all $\vec{a} \in P$ and $\vec{b} \in N$, there do not exist models \mathfrak{A} and \mathfrak{B} of \mathcal{K} such that $\vec{a}^{\mathfrak{A}}$ and $\vec{b}^{\mathfrak{B}}$ realize the same extended i -type for \mathcal{K} ;
4. the FO²-formula $t_1 \vee \dots \vee t_n$ strongly separates (\mathcal{K}, P, N) , t_1, \dots, t_n the extended i -types for \mathcal{K} realizable in \mathcal{K}, \vec{a} for some $\vec{a} \in P$.

Proof. Assume w.l.o.g. that the tuples in P and N have length two. Only “2. \Rightarrow 3.” is non-trivial. Assume that Condition 3 does not hold. Thus, there are $\vec{a} = (a_1, a_2) \in P$ and $\vec{b} = (b_1, b_2) \in N$ and models \mathfrak{A} and \mathfrak{B} of \mathcal{K} such that the extended 2-types of \mathfrak{A}, \vec{a} and \mathfrak{B}, \vec{b} coincide. We show that there exists a model \mathfrak{C} of $(\mathcal{O}, \mathcal{D}_{\vec{a}=\vec{b}})$. Then, by Theorem 48, (\mathcal{K}, P, N) is not FO-separable. We construct \mathfrak{C} from \mathfrak{A} and \mathfrak{B} as follows: assume that $a_1^{\mathfrak{A}} \neq a_2^{\mathfrak{A}}$. The case $a_1^{\mathfrak{A}} = a_2^{\mathfrak{A}}$ can be proved similarly. Then, by Point 1 of the definition of extended types and since 2-types contain equality assertions, $b_1^{\mathfrak{B}} \neq b_2^{\mathfrak{B}}$. By Points 5 and 6, \mathfrak{A} and \mathfrak{B} realize exactly the same 1-types once. Let K denote this set of 1-types. By identifying $a_i^{\mathfrak{A}}$ and $b_i^{\mathfrak{B}}$, $i = 1, 2$, and the nodes $c_i \in \text{dom}(\mathfrak{A})$ and $d_i \in \text{dom}(\mathfrak{B})$ realizing the same 1-type t in K we obtain a structure \mathfrak{C} whose substructure induced by $\text{dom}(\mathfrak{A})$ coincides with \mathfrak{A} and whose substructure induced by $\text{dom}(\mathfrak{B})$ coincides with \mathfrak{B} . This is well defined by Points 1, 2, 3, and 7 of the definition of extended types. Set $c^{\mathfrak{C}} = c^{\mathfrak{A}}$ for all constants c in \mathcal{D} and $c'^{\mathfrak{C}} = c'^{\mathfrak{B}}$ for all constants c' in \mathcal{D}' (from the definition of $\mathcal{D}_{\vec{a}=\vec{b}}$). It remains to define the 2-type realized by (c, d) in \mathfrak{C} for $c \in \text{dom}(\mathfrak{C}) \setminus \text{dom}(\mathfrak{B})$ and $d \in \text{dom}(\mathfrak{C}) \setminus \text{dom}(\mathfrak{A})$. Assume such a (c, d) is given (the situation is depicted below). Then the type $\text{tp}_{\mathcal{K}}(\mathfrak{B}, d)$ is realized in \mathfrak{A} , by Points 4 and 6 of the definition of extended types. Take $d' \in \text{dom}(\mathfrak{A})$ such that $\text{tp}_{\mathcal{K}}(\mathfrak{A}, d') = \text{tp}_{\mathcal{K}}(\mathfrak{B}, d)$.

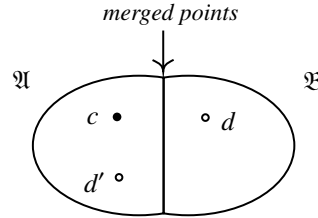

We may assume that $d' \neq c$ as $\text{tp}_{\mathcal{K}}(\mathfrak{B}, d)$ is realized at least twice in both \mathfrak{A} and in \mathfrak{B} . Now interpret the relations $R \in \text{sig}(\mathcal{K})$ in \mathfrak{C} in such a way that $\text{tp}_{\mathcal{K}}(\mathfrak{C}, d, c) = \text{tp}_{\mathcal{K}}(\mathfrak{A}, d', c)$. One can then show by induction over the construction of formulas in $\text{cl}(\mathcal{K})$ that \mathfrak{C} is a model of $(\mathcal{O}, \mathcal{D}_{\vec{a}=\vec{b}})$, as required. \square

As in the GF case, strongly separating formulas are of size at most $2^{2^{p(|\mathcal{O}|)}}$, p a polynomial. As satisfiability of FO²-KBs is NEXPTIME-complete in combined complexity and NP-complete in data complexity [79] we obtain the following result.

Corollary 58. *For any FO-fragment $\mathcal{L}_S \supseteq \text{UCQ}$:*

1. strong $(\text{FO}^2, \text{FO}^2)$ -separability and strong $(\text{FO}^2, \mathcal{L}_S)$ -separability coincide, the same is true for definability;
2. strong $(\text{FO}^2, \text{FO}^2)$ -separability and strong $(\text{FO}^2, \text{FO}^2)$ -definability are coNEXPTIME-complete in combined complexity and coNP-complete in data complexity.

This also holds for RE-existence and entity distinguishability, for all FO-fragments $\mathcal{L}_S \supseteq \text{CQ}$.

Proof. It remains to consider the lower bounds. As \mathcal{ALCI} is a fragment of FO^2 we can again use the proof of Corollary 50 for the lower bound in data complexity. As it is coNEXPTime -hard to check whether $O \models \forall x A(x)$ for an FO^2 -ontology O , we can also use the proof of Corollary 50 for the lower bound in combined complexity. \square

8. Discussion and Future Work

In this article and in [2], we have started an investigation of the separability problem for labeled KBs, that is, finding logical formulas that separate positive and negative examples in knowledge bases which consist of incomplete data and an ontology. We have established fundamental results for several ontology and separating languages ranging from full first-order logic to decidable fragments thereof, e.g., expressive description logics. In the remainder of the section, we discuss variations and extensions of the separability problem that are not covered in this paper. In passing, we mention several interesting directions for future work.

Separability under the Unique Name Assumption. Recall that we do not adopt the unique name assumption (UNA) which is essential for some of our results. Here we briefly discuss what happens if one adopts it and open problems that arise. We first note that if \mathcal{L} and \mathcal{L}_S are fragments of FO without equality, then the UNA does not influence the \mathcal{L}_S -consequences of \mathcal{L} -KBs in the sense that $\mathcal{K} \models \varphi(\vec{a})$ under UNA iff $\mathcal{K} \models \varphi(\vec{a})$ without UNA, for any \mathcal{L} -KB $\mathcal{K} = (O, \mathcal{D})$, \mathcal{L}_S -formula $\varphi(\vec{x})$, and $\vec{a} \in \text{cons}(\mathcal{D})^{|\vec{x}|}$ [80]. Clearly, in this case our results are not affected by adopting the UNA. This applies, for example, to (strong) $(\mathcal{ALCI}, \mathcal{ALCI})$ -separability and $(\mathcal{ALCI}, \text{UCQ})$ -separability.

We next consider the consequences of adopting the UNA on weak separability for languages with equality. As noted in Example 4 already, the fundamental characterization of weak (FO, FO)-separability given in Theorem 8 does not hold under the UNA. It is, however, straightforward to obtain a characterization of (FO, FO)-separability under UNA by adjusting the conditions given in Theorem 8 as follows. Let UCQ^\neq denote the class of unions of conjunctive queries that also admit atoms of the form $x \neq y$ and let $\varphi_{\mathcal{D}_{\text{con}(\vec{a}), \vec{a}}}^\neq$ denote the CQ $\varphi_{\mathcal{D}_{\text{con}(\vec{a}), \vec{a}}}$ extended by $x_c \neq x_d$ for any constants $c \neq d$ in $\mathcal{D}_{\text{con}(\vec{a})}$. Let $\mathcal{D}, \vec{a} \not\rightarrow \mathfrak{A}, \vec{b}$ denote that there is no injective homomorphism from \mathcal{D} to \mathfrak{A} mapping \vec{a} to \vec{b} . Then we obtain the following characterization using almost the same proof as before.

Theorem 59. *Let $(\mathcal{K}, P, \{\vec{b}\})$ be a labeled FO-KB, $\mathcal{K} = (O, \mathcal{D})$. Then under the UNA the following conditions are equivalent:*

1. $(\mathcal{K}, P, \{\vec{b}\})$ is projectively UCQ^\neq -separable;
2. $(\mathcal{K}, P, \{\vec{b}\})$ is projectively FO-separable;
3. there exists a model \mathfrak{A} of \mathcal{K} such that for all $\vec{a} \in P$: $\mathcal{D}_{\text{con}(\vec{a}), \vec{a}} \not\rightarrow \mathfrak{A}, \vec{b}^{\mathfrak{A}}$;
4. the $\text{UCQ} \bigvee_{\vec{a} \in P} \varphi_{\mathcal{D}_{\text{con}(\vec{a}), \vec{a}}}^\neq$ separates $(\mathcal{K}, P, \{\vec{b}\})$.

This characterization of (FO, FO)-separability under the UNA provides a very close link between rooted UCQ^\neq -evaluation on FO-KBs and FO-separability. It is known that without the restriction to rooted queries, UCQ^\neq -evaluation on \mathcal{ALCI} -KBS is undecidable [81, 73]. We obtain the following undecidability result by strengthening this result to rooted queries in a straightforward way. The proof is given in the appendix.

Theorem 60. *$(\mathcal{ALCI}, \text{FO})$ -separability is undecidable, under the UNA.*

Thus, in sharp contrast to separability without the UNA, $(\mathcal{ALCI}, \text{FO})$ -separability behaves very differently from $(\mathcal{ALCI}, \mathcal{ALCI})$ -separability under the UNA, both from a semantic and algorithmic viewpoint. We conjecture, however, that the complexity of projective and non-projective $(\mathcal{L}, \mathcal{L})$ -separability is not affected and still 2ExpTime -complete in combined complexity for $\mathcal{L} \in \{\text{GF}, \text{GNFO}\}$.

The UNA is also relevant for strong separability, if the ontology or query language uses equality. To illustrate this, extend the ontology O_2 defined in Example 4 by stating that the binary relations `citizen_of` and `born_in` are both partial functions, that is, $\forall x \forall y_1 \forall y_2 (R(x, y_1) \wedge R(x, y_2) \rightarrow y_1 = y_2)$ for $R \in \{\text{citizen_of}, \text{born_in}\}$. Denote the resulting ontology by O'_2 and consider the KB $\mathcal{K}'_2 = (O'_2, \mathcal{D}_1)$ with \mathcal{D}_1 introduced in Example 4. Then under the UNA the labeled KB

$(\mathcal{K}'_2, \{a\}, \{b\})$ is strongly separated by $\exists y(\text{born_in}(x, y) \wedge \text{citizen_of}(x, y))$ but it is not strongly FO-separable without the UNA.

While Theorem 48 does not hold under the UNA, one can adjust it in a similar way as Theorem 8 by replacing UCQ by UCQ^\neq and the CQs $\varphi_{\mathcal{D}_{\text{con}(\vec{a}), \vec{a}}}$ by $\varphi_{\mathcal{D}_{\text{con}(\vec{a}), \vec{a}}}^\neq$. Recall that the database $\mathcal{D}_{\vec{a}=\vec{b}}$ was constructed from \mathcal{D} and a disjoint copy \mathcal{D}' thereof, c.f. its definition before Theorem 48. Denote for any partial injection $S \subseteq (\text{cons}(\mathcal{D}) \setminus [\vec{a}]) \times (\text{cons}(\mathcal{D}') \setminus [\vec{b}])$ by $\mathcal{D}_{\vec{a}=\vec{b}}^S$ the database obtained from $\mathcal{D}_{\vec{a}=\vec{b}}$ by identifying all c_1, c_2 with $(c_1, c_2) \in S$. Then one can prove the following characterization by adapting the proof of Theorem 48.

Theorem 61. *Let $(\mathcal{K}, P, \{\vec{b}\})$ be a labeled FO-KB, $\mathcal{K} = (\mathcal{O}, \mathcal{D})$. Then under the UNA the following conditions are equivalent:*

1. $(\mathcal{K}, P, \{\vec{b}\})$ is strongly UCQ^\neq -separable;
2. $(\mathcal{K}, P, \{\vec{b}\})$ is strongly FO-separable;
3. for all $\vec{a} \in P$, $\vec{b} \in N$, and all partial injections $S \subseteq (\text{cons}(\mathcal{D}) \setminus [\vec{a}]) \times (\text{cons}(\mathcal{D}') \setminus [\vec{b}])$, the KB $(\mathcal{O}, \mathcal{D}_{\vec{a}=\vec{b}}^S)$ is unsatisfiable (under UNA);
4. the $\text{UCQ} \bigvee_{\vec{a} \in P} \varphi_{\mathcal{D}_{\text{con}(\vec{a}), \vec{a}}}^\neq$ strongly separates $(\mathcal{K}, P, \{\vec{b}\})$.

Recall that for \mathcal{ALCI} -ontologies \mathcal{O} any KB $(\mathcal{O}, \mathcal{D})$ is satisfiable under the UNA iff it is satisfiable without UNA. Hence, in sharp contrast to weak separability, by Point 3 of Theorems 48 and 61, strong $(\mathcal{ALCI}, \text{FO})$ -separability does not depend on the UNA and coincides with strong $(\mathcal{ALCI}, \mathcal{ALCI})$ -separability with and without the UNA.

On the other hand, if $\mathcal{L} \in \{\text{GNFO}, \text{GF}, \text{FO}^2\}$, then strong (\mathcal{L}, FO) -separability depends on the UNA. Consider, for instance,

$$\mathcal{O} = \{\forall x \forall y (R(x, y) \rightarrow (R(x, x) \rightarrow (x = y)))\}$$

and $\mathcal{D} = \{R(a, c), R(b, b)\}$. Then $((\mathcal{O}, \mathcal{D}), \{a\}, \{b\})$ is strongly FO-separable under the UNA but not without the UNA (check Condition 3 of the characterizations). It remains an interesting open problem to determine the relationship between strong (\mathcal{L}, FO) -separability and strong $(\mathcal{L}, \mathcal{L})$ -separability under the UNA and their complexity for $\mathcal{L} \in \{\text{GNFO}, \text{GF}, \text{FO}^2\}$.

Separability for Expressive Description Logics. Projective weak separability has been studied also for \mathcal{ALC} , \mathcal{ALCQ} , and \mathcal{ALCQI} , with some surprising results. As we have seen in this article, projective weak separability in \mathcal{ALCI} is NEXP TIME -complete in combined complexity, by mutual polynomial time reduction with the complement of rooted UCQ-evaluation. In \mathcal{ALC} , \mathcal{ALCQ} and \mathcal{ALCQI} , projective weak separability can be mutually polynomial time reduced with the complement of natural variants of rooted UCQ-evaluation in the respective DLs [2]. Adopting the UNA, it is shown that projective $(\mathcal{ALC}, \mathcal{ALC})$ and $(\mathcal{ALCQ}, \mathcal{ALCQ})$ -separability are also NEXP TIME -complete but that projective $(\mathcal{ALCQI}, \mathcal{ALCQI})$ -separability is EXP TIME -complete. Strong separability has also been studied for \mathcal{ALC} and turns out to be EXP TIME -complete [2]. As discussed above, in \mathcal{ALC} and \mathcal{ALCI} neither weak nor strong separability depend on the UNA, but for \mathcal{ALCQ} and \mathcal{ALCQI} they do. In fact, it would be of interest to investigate whether the complexity results for \mathcal{ALCQ} and \mathcal{ALCQI} still hold if one does not adopt the UNA. More generally, it is a challenging open problem to systematically investigate the semantic and algorithmic properties of separability in the context of expressive DLs and consider description logics with further constructors such as functional roles or number restrictions, role hierarchies, transitive roles, expressive role inclusions, and nominals. DLs of interest include \mathcal{ALCO} , \mathcal{ALCFIO} , \mathcal{S} (see Example 43), \mathcal{SHIQ} , \mathcal{SHOIQ} , and \mathcal{SROIQ} [57, 58]. Note that \mathcal{ALCO} is also discussed below when we consider in more detail the role of constants in the separability problem.

Separability with Signature Restrictions. In this article, we have investigated separability under the assumption that all relation symbols from the labeled KB can occur in the separating expression. It is also of interest to consider a signature Σ of relation symbols (and possibly constants) that is given as an additional input and require separating expressions to be formulated in Σ . This makes it possible to ‘direct’ separation towards expressions based on desired features and accordingly to exclude features that are not supposed to be used for separation. In [3], we have

started investigating separability under signature restrictions. Many results comparing the expressive power of different separation languages obtained in this article do not hold under signature restrictions and new separation languages combining UCQs and DLs are introduced to understand the power of projective separability under signature restrictions. Also decision problems becomes much harder. The following table gives an overview of the complexity of separability for expressive fragments of FO with signature restrictions. For the results on \mathcal{ALCO} we have admitted nominals in separating concepts but no constants are admitted in separating expressions for the remaining languages in the table. In the weak separability case only projective separability has been investigated (with unary relation symbols as helper symbols), non-projective weak separability appears to be very challenging and has not yet been considered. We note that while projective separability without signature restrictions is closely linked to UCQ-evaluation, projective separability with signature restrictions is closely linked to conservative extensions [82, 83] and that while strong separability without signature restrictions is closely linked to KB satisfiability, strong satisfiability with signature restrictions is closely linked to Craig interpolant existence [84, 85].

\mathcal{L}	Weak Separability projective restricted signature	Strong Separability restricted signature
\mathcal{ALC}	2ExpTime	2ExpTime
\mathcal{ALCI}	2ExpTime	2ExpTime
\mathcal{ALCO}	3ExpTime	2ExpTime
GF	Undecidable	3ExpTime
FO ²	Undecidable	[2Exp, coN2Exp]

Many challenging problems are open for separability under signature restrictions. For example, the complexity of deciding weak and strong separability for most of the expressive DLs mentioned in the previous paragraph and a better understanding of the separating power of expressive DLs remain to be investigated.

Separability with Constants. In this article we do not admit constants in ontologies nor in separating expressions. Even without constants in separating expressions, the admission of constants in ontologies makes a significant difference. For example, in FO and fragments such as the extension \mathcal{ALCO} of \mathcal{ALC} with nominals one can then state that $a \neq b$ for different constants a, b in the database. Thus, one can implicitly cover the UNA with the consequences discussed above. The existence of useful model-theoretic characterization results and the complexity of separability remain to be investigated. If one admits constants in separating formulas, the situation changes even more drastically. Note that it does not make sense to admit all constants in the underpinning database of the separability problem in separating formulas as in this case the formula $x = a$ would weakly separate the labeled KB $(\mathcal{K}, \{a\}, \{b\})$ whenever $a \neq b$. Thus, the set of constants that can occur in separating formulas has to be restricted by excluding at least some constants from the database. The general set-up in which one can restrict both the relation symbols and the constants that can occur in separating formulas has been studied in [3] and is discussed above. We note, however, that the case in which one only restricts the use of constants but not the use of relation symbols in separating formulas has not yet been studied. We conjecture that many of the complexity results we obtained in this article still hold.

Separation with CQs, \mathcal{ELI} -Concepts, and \mathcal{EL} -Concepts. If one aims at finding separating expressions that generalize from the positive examples, it is important to avoid overfitting. From a logical viewpoint this can be achieved by disallowing disjunction in separating formulas and admit as separating expressions only CQs (in the context of query by example) or concepts in the lightweight description logics \mathcal{EL} or \mathcal{ELI} (in the context of DL concept learning). Note that \mathcal{ELI} -concepts can be regarded as rooted tree-shaped CQs and \mathcal{EL} -concepts as rooted tree-shaped CQs in which children are reached by role names [58]. We have seen in this article that for labeled KBs with a single positive example only, CQs often have the same separating power as UCQs. For labeled KBs with many positive example this is clearly not the case. In fact, separability often becomes undecidable: in [2], it is shown by a reduction of the undecidable CQ query inseparability problem for \mathcal{ALC} -KBs [86] that weak $(\mathcal{ALC}, \text{CQ})$, $(\mathcal{ALC}, \mathcal{ELI})$ and $(\mathcal{ALC}, \mathcal{EL})$ -separability are undecidable. Note that in this case the use of helper symbols does not make a difference. Even if one considers ontologies given in Horn DLs, weak separability is computationally surprisingly hard: weak $(\mathcal{EL}, \mathcal{EL})$ -separability is ExpTime-complete in both combined and data complexity and weak $(\mathcal{ELI}, \mathcal{ELI})$ -separability is undecidable, even on labeled KBs with only two positive examples [2]. Further results for weak separability on

KBs given in Horn-DLs are presented in [39, 40, 27]. It is an exciting and challenging problem to find suitable subsets of the set of \mathcal{EL} or \mathcal{ELI} concepts for which separability becomes decidable.

References

- [1] J. C. Jung, C. Lutz, H. Pulcini, F. Wolter, Logical separability of incomplete data under ontologies, in: Proc. of KR, 2020.
- [2] M. Funk, J. C. Jung, C. Lutz, H. Pulcini, F. Wolter, Learning description logic concepts: When can positive and negative examples be separated?, in: Proc. of IJCAI, 2019, pp. 1682–1688.
- [3] J. C. Jung, C. Lutz, H. Pulcini, F. Wolter, Separating data examples by description logic concepts with restricted signatures, in: Proc. of KR, 2021.
- [4] L. Badea, S. Nienhuys-Cheng, A refinement operator for description logics, in: Proc. of ILP, 2000, pp. 40–59.
- [5] J. Lehmann, C. Haase, Ideal downward refinement in the \mathcal{EL} description logic, in: Proc. of ILP, 2009, pp. 73–87.
- [6] J. Lehmann, P. Hitzler, Concept learning in description logics using refinement operators, *Machine Learning* 78 (2010) 203–250.
- [7] F. A. Lisi, U. Straccia, Learning in description logics with fuzzy concrete domains, *Fundamenta Informaticae* 140 (3-4) (2015) 373–391.
- [8] M. K. Sarker, P. Hitzler, Efficient concept induction for description logics, in: Proc. of AAAI, 2019, pp. 3036–3043.
- [9] N. Fanizzi, C. d’Amato, F. Esposito, DL-FOIL concept learning in description logics, in: Proc. of ILP, 2008, pp. 107–121.
- [10] F. A. Lisi, A formal characterization of concept learning in description logics, in: Proc. of DL, 2012.
- [11] G. Rizzo, N. Fanizzi, C. d’Amato, Class expression induction as concept space exploration: From dl-foil to dl-focl, *Future Gener. Comput. Syst.* 108 (2020) 256–272.
- [12] L. Bühmann, J. Lehmann, P. Westphal, S. Bin, DL-learner - structured machine learning on semantic web data, in: Proc. of WWW, 2018, pp. 467–471.
- [13] L. Bühmann, J. Lehmann, P. Westphal, DL-learner - A framework for inductive learning on the semantic web, *J. Web Sem.* 39 (2016) 15–24.
- [14] N. Fanizzi, G. Rizzo, C. d’Amato, F. Esposito, DLFOIL: Class expression learning revisited, in: Proc. of EKAW, 2018, pp. 98–113.
- [15] G. Rizzo, N. Fanizzi, C. d’Amato, F. Esposito, A framework for tackling myopia in concept learning on the web of data, in: Proc. of EKAW, Springer, 2018, pp. 338–354.
- [16] A. C. Tran, J. Dietrich, H. W. Guesgen, S. Marsland, Parallel symmetric class expression learning, *J. Mach. Learn. Res.* 18 (2017) 64:1–64:34.
- [17] L. Iannone, I. Palmisano, N. Fanizzi, An algorithm based on counterfactuals for concept learning in the semantic web, *Appl. Intell.* 26 (2) (2007) 139–159.
- [18] U. Straccia, M. Mucci, pFOIL-DL: Learning (fuzzy) \mathcal{EL} concept descriptions from crisp OWL data using a probabilistic ensemble estimation, in: Proc. of SAC, 2015, pp. 345–352.
- [19] Q. Ha, T. Hoang, L. A. Nguyen, H. S. Nguyen, A. Szalas, T. Tran, A bisimulation-based method of concept learning for knowledge bases in description logics, in: Proc. of SoICT, 2012, pp. 241–249.
- [20] T. Tran, L. A. Nguyen, T. Hoang, Bisimulation-based concept learning for information systems in description logics, *Vietnam J. Computer Science* 2 (3) (2015) 149–167.
- [21] A. R. Divroodi, Q. Ha, L. A. Nguyen, H. S. Nguyen, On the possibility of correct concept learning in description logics, *Vietnam J. Computer Science* 5 (1) (2018) 3–14.
- [22] F. A. Lisi, A model+solver approach to concept learning, in: Proc. of AI*IA 2016, 2016, pp. 266–279.
- [23] W. W. Cohen, A. Borgida, H. Hirsh, Computing least common subsumers in description logics, in: Proc. of AAAI, 1992, pp. 754–760.
- [24] B. Nebel, Reasoning and Revision in Hybrid Representation Systems, Springer, 1990.
- [25] F. Baader, R. Küsters, R. Molitor, Computing least common subsumers in description logics with existential restrictions, in: Proc. of IJCAI, 1999, pp. 96–103.
- [26] B. Zariwā, A. Turhan, Most specific generalizations w.r.t. general \mathcal{EL} -TBoxes, in: Proc. of IJCAI, 2013, pp. 1191–1197.
- [27] J. C. Jung, C. Lutz, F. Wolter, Least general generalizations in description logic: Verification and existence, in: Proc. of AAAI, 2020, pp. 2854–2861.
- [28] Q. T. Tran, C. Chan, S. Parthasarathy, Query by output, in: Proc. of PODS, 2009, pp. 535–548.
- [29] M. Zhang, H. Elmeleegy, C. M. Procopiuc, D. Srivastava, Reverse engineering complex join queries, in: Proc. of SIGMOD, 2013, pp. 809–820.
- [30] Y. Y. Weiss, S. Cohen, Reverse engineering spj-queries from examples, in: Proc. of PODS, 2017, pp. 151–166.
- [31] D. V. Kalashnikov, L. V. Lakshmanan, D. Srivastava, Fastqre: Fast query reverse engineering, in: Proc. of SIGMOD, 2018, pp. 337–350.
- [32] D. Deutch, A. Gilad, Reverse-engineering conjunctive queries from provenance examples., in: Proc. of EDBT, 2019, pp. 277–288.
- [33] S. Staworko, P. Wiecek, Learning twig and path queries, in: Proc. of ICDT, 2012, pp. 140–154.
- [34] D. M. L. Martins, Reverse engineering database queries from examples: State-of-the-art, challenges, and research opportunities, *Inf. Syst.* 83 (2019) 89–100.
- [35] M. Arenas, G. I. Diaz, The exact complexity of the first-order logic definability problem, *ACM Trans. Database Syst.* 41 (2) (2016) 13:1–13:14.
- [36] P. Barceló, M. Romero, The complexity of reverse engineering problems for conjunctive queries, in: Proc. of ICDT, 2017, pp. 7:1–7:17.
- [37] B. Kimelfeld, C. Ré, A relational framework for classifier engineering, *ACM Trans. Database Syst.* 43 (3) (2018) 11:1–11:36.
- [38] B. ten Cate, V. Dalmau, Conjunctive queries: Unique characterizations and exact learnability, in: Proc. of ICDT, 2021, pp. 9:1–9:24.
- [39] V. Gutiérrez-Basulto, J. C. Jung, L. Sabellek, Reverse engineering queries in ontology-enriched systems: The case of expressive Horn description logic ontologies, in: Proc. of IJCAI-ECAI, 2018.
- [40] M. Ortiz, Ontology-mediated queries from examples: a glimpse at the DL-Lite case, in: Proc. of GCAI, 2019, pp. 1–14.
- [41] G. Cima, F. Croce, M. Lenzerini, QDEF and its approximations in OBDM, *CoRR* abs/2108.10021 (2021).
- [42] M. Arenas, G. I. Diaz, E. V. Kostylev, Reverse engineering SPARQL queries, in: Proc. of WWW, 2016, pp. 239–249.
- [43] E. Krahmer, K. van Deemter, Computational generation of referring expressions: A survey, *Computational Linguistics* 38 (1) (2012) 173–218.

- [44] A. Borgida, D. Toman, G. E. Weddell, Concerning referring expressions in query answers, in: C. Sierra (Ed.), Proceedings of the Twenty-Sixth International Joint Conference on Artificial Intelligence, IJCAI 2017, Melbourne, Australia, August 19-25, 2017, ijcai.org, 2017, pp. 4791–4795. doi:10.24963/ijcai.2017/668.
URL <https://doi.org/10.24963/ijcai.2017/668>
- [45] A. Borgida, D. Toman, G. E. Weddell, On referring expressions in query answering over first order knowledge bases, in: Proc. of KR, 2016, pp. 319–328.
- [46] A. Artale, A. Mazzullo, A. Ozaki, F. Wolter, On free description logics with definite descriptions, in: Proc. of KR, 2021.
- [47] C. Areces, A. Koller, K. Striegnitz, Referring expressions as formulas of description logic, in: Proc. of INLG, The Association for Computer Linguistics, 2008.
- [48] D. Toman, G. E. Weddell, Finding ALL answers to OBDA queries using referring expressions, in: Proc. of AI, 2019, pp. 117–129.
- [49] A. Petrova, E. Sherkhonov, B. C. Grau, I. Horrocks, Entity comparison in RDF graphs, in: Proc. of ISWC, 2017, pp. 526–541.
- [50] A. Petrova, E. V. Kostylev, B. C. Grau, I. Horrocks, Query-based entity comparison in knowledge graphs revisited, in: Proc. of ISWC, 2019, pp. 558–575.
- [51] S. Abiteboul, R. Hull, V. Vianu, Foundations of Databases, Addison-Wesley, 1995.
- [52] H. Andréka, I. Németi, J. van Benthem, Modal languages and bounded fragments of predicate logic, *J. Philosophical Logic* 27 (3) (1998) 217–274.
- [53] E. Grädel, On the restraining power of guards, *J. Symb. Log.* 64 (4) (1999) 1719–1742.
- [54] E. Grädel, Why are modal logics so robustly decidable?, *Bull. EATCS* 68 (1999) 90–103.
- [55] V. Bárány, B. ten Cate, L. Segoufin, Guarded negation, *J. ACM* 62 (3) (2015) 22:1–22:26.
- [56] E. Grädel, P. G. Kolaitis, M. Y. Vardi, On the decision problem for two-variable first-order logic, *Bulletin of Symbolic Logic* 3 (1) (1997) 53–69.
- [57] F. Baader, Deborah, D. Calvanese, D. L. McGuinness, D. Nardi, P. F. Patel-Schneider (Eds.), *The Description Logic Handbook*, Cambridge University Press, 2003.
- [58] F. Baader, I. Horrocks, C. Lutz, U. Sattler, *An Introduction to Description Logics*, Cambridge University Press, 2017.
- [59] L. Libkin, *Elements of Finite Model Theory*, Springer, 2004.
- [60] C. Chang, H. J. Keisler, *Model Theory*, Elsevier, 1998.
- [61] V. Bárány, M. Benedikt, B. ten Cate, Some model theory of guarded negation, *J. Symb. Log.* 83 (4) (2018) 1307–1344.
- [62] M. Mortimer, On languages with two variables, *Math. Log. Q.* 21 (1) (1975) 135–140.
- [63] D. S. Johnson, A. C. Klug, Testing containment of conjunctive queries under functional and inclusion dependencies, *J. Comput. Syst. Sci.* 28 (1) (1984) 167–189.
- [64] R. Rosati, On the finite controllability of conjunctive query answering in databases under open-world assumption, *J. Comput. Syst. Sci.* 77 (3) (2011) 572–594.
- [65] V. Bárány, G. Gottlob, M. Otto, Querying the guarded fragment, *Logical Methods in Computer Science* 10 (2) (2014).
- [66] A. K. Chandra, P. M. Merlin, Optimal implementation of conjunctive queries in relational data bases, in: Proc. of STOC, 1977, pp. 77–90.
- [67] C. Lutz, R. Piro, F. Wolter, Description logic TBoxes: Model-theoretic characterizations and rewritability, in: Proc. of IJCAI, IJCAI/AAAI, 2011.
- [68] V. Goranko, M. Otto, Model theory of modal logic, in: *Handbook of Modal Logic*, Elsevier, 2007, pp. 249–329.
- [69] C. Lutz, Inverse roles make conjunctive queries hard, in: Proc. of DL, 2007.
- [70] C. Lutz, The complexity of conjunctive query answering in expressive description logics, in: Proc. of IJCAR, 2008, pp. 179–193.
- [71] A. Hermich, C. Lutz, F. Papacchini, F. Wolter, Dichotomies in ontology-mediated querying with the guarded fragment, *ACM Trans. Comput. Log.* 21 (3) (2020) 1–47.
- [72] E. Grädel, M. Otto, The freedoms of (guarded) bisimulation, in: *Johan van Benthem on Logic and Information Dynamics*, Springer International Publishing, 2014, pp. 3–31.
- [73] R. Rosati, The limits of querying ontologies, in: Proc. of ICDT, 2007, pp. 164–178.
- [74] R. Berger, The undecidability of the domino problem, *Memoirs of the American Mathematical Society* 66 (1966).
- [75] Y. Gurevich, I. Koryakov, Remarks on berger’s paper on the domino problem, *Siberian Math Journal* 13 (1972) 319–321.
- [76] E. Börger, E. Grädel, Y. Gurevich, *The Classical Decision Problem*, Perspectives in Mathematical Logic, Springer, 1997.
- [77] V. Gutiérrez-Basulto, Y. Ibáñez-García, J. C. Jung, Answering regular path queries over \mathcal{SQ} ontologies, in: Proc. of AAAI, 2018.
- [78] V. Bárány, B. ten Cate, M. Otto, Queries with guarded negation, *PVLDB* 5 (11) (2012) 1328–1339.
- [79] I. Pratt-Hartmann, Data-complexity of the two-variable fragment with counting quantifiers, *Inf. Comput.* 207 (8) (2009) 867–888.
- [80] M. Bienvenu, B. ten Cate, C. Lutz, F. Wolter, Ontology-based data access: A study through disjunctive datalog, CSP, and MMSNP, *ACM Trans. Database Syst.* 39 (4) (2014) 33:1–33:44.
- [81] D. Calvanese, G. De Giacomo, M. Lenzerini, On the decidability of query containment under constraints, in: Proc. of PODS, 1998, pp. 149–158.
- [82] S. Ghilardi, C. Lutz, F. Wolter, Did I damage my ontology? A case for conservative extensions in description logics, in: Proc. of KR, AAAI Press, 2006, pp. 187–197.
- [83] J. C. Jung, C. Lutz, M. Martel, T. Schneider, F. Wolter, Conservative extensions in guarded and two-variable fragments, in: Proc. of ICALP, 2017, pp. 108:1–108:14.
- [84] A. Artale, J. C. Jung, A. Mazzullo, A. Ozaki, F. Wolter, Living without Beth and Craig: Definitions and interpolants in description logics with nominals and role inclusions, in: Proc. of AAAI, 2021, pp. 6193–6201.
- [85] J. C. Jung, F. Wolter, Living without Beth and Craig: Definitions and interpolants in the guarded and two-variable fragments, in: Proc. of LICS, 2021, pp. 1–14.
- [86] E. Botoeva, R. Kontchakov, C. Lutz, V. Ryzhikov, F. Wolter, M. Zakharyashev, Query inseparability for ALC ontologies, *Artif. Intell.* 272 (2019) 1–51.
- [87] P. van Emde Boas, The convenience of tilings, in: *Complexity, Logic, and Recursion Theory*, 1997, pp. 331–363.

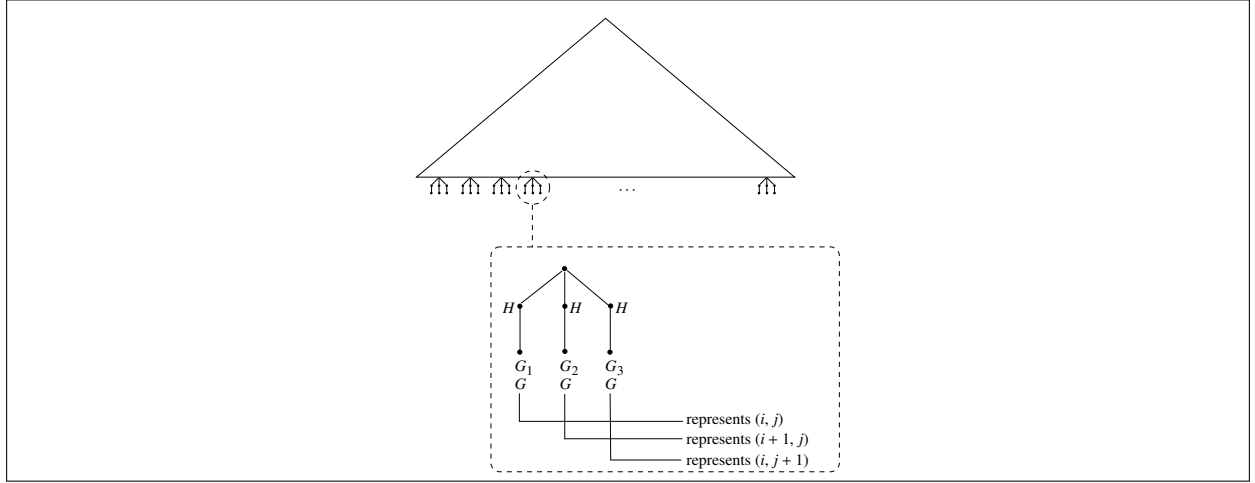

Figure A.4: The structure encoding the $2^n \times 2^n$ -grid.

Appendix A. Proofs for Section 5.1

To prove Theorem 20, it remains to show NEXP TIME -hardness in data complexity of projective $(\mathcal{ALCI}, \mathcal{ALCI})$ -separability. This follows from the following result.

Theorem 62. *There exists an \mathcal{ALCI} -ontology \mathcal{O} such that unary rooted UCQ-evaluation on KBs with ontology \mathcal{O} is coNEXP TIME -hard.*

To prove this result, we adapt a coNEXP TIME -hardness proof from [69, 70]. It works by reducing a tiling problem that asks to tile a $2^n \times 2^n$ -torus.

A tiling system \mathfrak{T} is a triple (T, H, V) , where $T = \{0, 1, \dots, k-1\}$, $k \geq 0$, is a finite set of tile types and $H, V \subseteq T \times T$ represent the horizontal and vertical matching conditions. Let \mathfrak{T} be a tiling system and $c = c_0 \cdots c_{n-1}$ an initial condition, i.e. an n -tuple of tile types. A mapping $\tau : \{0, \dots, 2^n - 1\} \times \{0, \dots, 2^n - 1\} \rightarrow T$ is a solution for \mathfrak{T} and c if for all $x, y < 2^n$, the following holds where \oplus_i denotes addition modulo i :

1. if $\tau(x, y) = t$ and $\tau(x \oplus_{2^n} 1, y) = t'$, then $(t, t') \in H$;
2. if $\tau(x, y) = t$ and $\tau(x, y \oplus_{2^n} 1) = t'$, then $(t, t') \in V$;
3. $\tau(i, 0) = c_i$ for $i < n$.

It is well-known that there is a tiling system \mathfrak{T} such that it is NEXP TIME -hard to decide, given an initial condition c , whether there is a solution for \mathfrak{T} and c . In fact, this can be easily proved using the methods in [87]. For what follows, fix such a system \mathfrak{T} . To build up intuition for the reduction, we first describe a representation of solutions for \mathfrak{T} and c in terms of certain torus trees, shown in Figure A.4. Let τ be such a solution. Then the corresponding torus tree has the following structure:

- The main part of the tree, shown as a large triangle in Figure A.4, consists of a full binary tree of depth $2n$. Thus, there is exactly one leaf in the main part for every position in the $2^n \times 2^n$ -torus.
- Every leaf in the main part has an attached gadget, which is itself a tree of depth two, so that the overall depth of the torus tree is $2n + 2$;
- The root of the gadget has three successors that we call H -nodes; each H -node has a single successor; we call these successors of H -nodes G -nodes and, from left to right, G_1 -node, G_2 -node, and G_3 -node.

- Each gadget represents a position in the $2^n \times 2^n$ -torus together with the neighboring positions above and to the right. More precisely, the G_1 -node represents the position (i, j) focussed on by the gadget, the G_2 -node represents the position $(i + 1, j)$ to the right, and the G_3 -node represents the position $(i, j + 1)$ above (all modulo 2^n). We store at these G -nodes the tile types $\tau(i, j)$, $\tau(i + 1, j)$, and $\tau(i, j + 1)$, respectively (not shown in the figure).

Note that in a torus tree, every tile type assigned to a position of the $2^n \times 2^n$ -torus is stored in three different gadgets, once as a G_1 -node, once as a G_2 -node, and once as a G_3 -node. In principle, a torus tree may store *different* tile types at these places, but is then of course not guaranteed to correspond to a solution of \mathfrak{T} and c . Such *copying defects* will play an important role in the reduction below.

In what follows, our aim is to identify a knowledge base $\mathcal{K} = (\mathcal{O}, \mathcal{D})$ with selected individual name a_0 such that given an initial condition $c = c_0 \cdots c_{n-1}$, we can construct in polynomial time a unary rooted UCQ q_c such that $\mathcal{K} \not\models q_c(a_0)$ iff there is a solution for \mathfrak{T} and c . In fact, $\mathcal{K} \not\models q_c(a_0)$ implies that there is a model \mathcal{I} of \mathcal{K} such that $\mathcal{I} \not\models q_c(a_0)$ and we will build \mathcal{K} and q_c such that such a model \mathcal{I} contains a (representation of a) torus tree without copying defects. In fact, \mathcal{D} will be of the very simple form $\{A_0(a_0)\}$ and we will construct q_c to be of the form $q_c^1 \vee q_c^2$, where q_c^1 and q_c^2 are both rooted UCQs, such that $\mathcal{I} \not\models q_c^1(a_0)$ implies the presence of a torus tree in \mathcal{I} , potentially with copying defects, while $\mathcal{I} \not\models q_c^2(a_0)$ guarantees that no copying defects are actually present. To achieve the latter, we actually need to enforce the presence of a second torus tree in \mathcal{I} , as explained below.

We first construct the ontology \mathcal{O} . Note that \mathcal{O} must be independent of the choice of c , and thus also independent of the size of the torus. This is not the case in the mentioned reduction in [69, 70] where \mathcal{O} simply enforces that models of \mathcal{K} contain a torus tree, possibly with copying defects. We clearly cannot do this here. What we do instead is building \mathcal{O} so that it generates an *infinite* tree in models of \mathcal{K} that should be thought of as providing a ‘template’ for torus trees of any possible depths. In this template, the concept names H, G, G_1, G_2, G_3 that we use to identify the eponymous nodes are *not* enforced to be true anywhere. We will use q_c^1 to make them true at the right depths for the initial condition c given, in this way imposing a torus tree of the desired depth onto the template. We next describe the representation of torus trees in models of \mathcal{K} in some more detail:

- We use a role name R_0 such that each successor in the torus tree, both in the main part of the tree and in the gadgets, is reached via a role path of the form $R_0; R_0^-; R_0; R_0^-; R_0; R_0^-$; no branching occurs for nodes on this path.
- We use concept names B_1, B_2, B_3 and make sure that the nodes in the torus tree are labeled with B_1 while on each ‘successor path’ $R_0; R_0^-; R_0; R_0^-; R_0; R_0^-$, the node reached via the $R_0; R_0^-$ prefix satisfies B_2 and the node reached via the $R_0; R_0^-; R_0; R_0^-$ prefix satisfies B_3 .
- What this achieves is that successors can be reached both by the role composition $R_0; R_0^-; R_0; R_0^-; R_0; R_0^-$, which should be thought of as a reflexive and symmetric role, and by $B_1?; R_0; R_0^-; B_2?; R_0; R_0^-; B_3?; R_0; R_0^-; B_1?$, which is directed rather than symmetric and where each $B_i?$ denotes a test that the node reached at this point satisfies concept name B_i .
- We also use a role name R_1 to represent the torus positions represented by G -nodes. This representation is in binary, that is, we encode the numbers $0, \dots, 2^{2^n} - 1$ in binary, assuming that the first n bits describe the horizontal position and the second n bits the vertical position. Bit i has value one at a domain element d if $d \in (\exists R_1^{i+1}.T)^{\mathcal{I}}$ and zero if $d \in (\exists R_1^{i+1}.F)^{\mathcal{I}}$ where bit 0 is the least significant bit and where $\exists R_1^{i+1}$ denotes the $i + 1$ -fold nesting $\exists R_1 \cdots \exists R_1$.

Let us now formally define the ontology \mathcal{O} . To represent tiles, we introduce a concept name D_i for each $i \in T$. We write $\exists R.C$ as shorthand for

$$B_1 \sqcap \exists R_0. \exists R_0^- . (B_2 \sqcap \exists R_0. \exists R_0^- . (B_3 \sqcap \exists R_0. \exists R_0^- . (B_1 \sqcap C))) .$$

Now \mathcal{O} contains the following:

$$\begin{aligned}
A_0 &\sqsubseteq A \\
A &\sqsubseteq \exists R.(A \sqcap T) \sqcap \exists R.(A \sqcap F) \\
A &\sqsubseteq \prod_{1 \leq i \leq 3} \exists R.(H' \sqcap M_1 \sqcap \exists R.(G' \sqcap G'_i \sqcap M_1)) \\
\neg X_H \sqcap H' &\sqsubseteq H \\
\neg X_G \sqcap G' &\sqsubseteq G \\
\neg X_G \sqcap G'_i &\sqsubseteq G_i \text{ for } 1 \leq i \leq 3 \\
G &\sqsubseteq \bigsqcup_{i \in T} (D_i \sqcap \prod_{j \in T \setminus \{i\}} \neg D_j) \\
H &\sqsubseteq \bigsqcup_{i \in T} (\neg D_i \sqcap \prod_{j \in T \setminus \{i\}} D_j) \\
T &\equiv \neg F \\
\top &\sqsubseteq \exists R_1. \top
\end{aligned}$$

Intuitively, the first CI generates the template for the main part of the torus tree and the second CI generates the template for the gadgets. Note that we attach a gadget template to *every* node of the main tree, independently of its depth. As explained before, though, these gadgets are not activated: they only satisfy the concept names H', G', G'_1, G'_2, G'_3 while what we are really interested in are H, G, G_1, G_2, G_3 . The next three CIs provide a way to activate these concept names by making the concept names X_H and X_G false. The next two lines select tile types whenever G and H have been activated. In the case of G , exactly one tile type is made true while in the case of H , exactly one tile type is made false. This is explained later on, we speak of G -nodes and H -nodes being labeled complementarily regarding tile types. \mathcal{O} also makes sure that the concept names T and F , which distinguish left successors and right successors in the template for the main part of the torus tree, are complements of each other. Moreover, we generate infinite R_1 -paths to provide templates for representing torus positions. Again, these are not yet ‘activated’ as the concept names T and F are not set anywhere on these paths. Note that all H -nodes and G -nodes are labeled with M_1 .

We have already mentioned above that avoiding copying defects requires us to use a second torus tree.¹ This tree is attached via an extra R -edge from the root of the first tree. In contrast to the first tree, there is no branching in the gadgets, that is, every leaf of the torus tree proper has only a single H -node successor, which has a single G -node successor, and the concept names G_1, G_2, G_3 are not used. All H - and G -nodes in the second tree are labeled with M_2 . We include the following in \mathcal{O} :

$$\begin{aligned}
A_0 &\sqsubseteq \exists R.A' \\
A' &\sqsubseteq \exists R.(A' \sqcap T) \sqcap \exists R.(A' \sqcap F) \\
A' &\sqsubseteq \exists R.(H' \sqcap M_2 \sqcap \exists R.(G' \sqcap M_2))
\end{aligned}$$

Let $c = c_0 \cdots c_{n-1}$ be a given initial condition for \mathfrak{A} . We construct the rooted UCQs q_c^1 and q_c^2 , starting with q_c^1 . Recall that we want to achieve that for models \mathcal{I} of \mathcal{K} , $\mathcal{I} \not\models q_c^1(a_0)$ implies that \mathcal{I} contains (a homomorphic image of) a representation of a torus tree, possibly with copying defects, as well as a second torus tree as described above, and that \mathcal{O} provides an infinite template for both torus trees in \mathcal{I} . The aim is thus to construct q_c^1 so that the non-existence of a homomorphism from q_c^1 to \mathcal{I} ‘activates’ in the template the two torus trees of appropriate depth. We write $R(x, y)$ as shorthand for

$$B_1(x), R_0(x, y_1), R_0(z_1, y_1), B_2(z_1), R_0(z_1, y_2), R_0(z_2, y_2), B_3(z_2), R_0(z_2, y_3), R_0(y, y_3), B_1(y),$$

with y_1, y_2, y_3, z_1, z_2 fresh variables, expressing that y is a successor of x in the torus tree. We further use $R^i(x, y)$, for $i \geq 1$, as a shorthand for $R(z_1, z_2), \dots, R(z_{i-1}, z_i)$ where $z_1 = x, z_i = y$, and z_2, \dots, z_{i-1} are fresh variables. In what follows, x_0 will be the (only) answer variable in each of the constructed CQs.

¹The second tree is actually not used in the reduction in [69, 70]. That reduction contains a (somewhat minor) glitch that we fix by using the second tree.

Our first aim is to activate H -nodes on level $2n + 1$ of the template as well as G -nodes on level $2n + 2$, both in the first tree, using the two CQs

$$R^{2n+1}(x_0, x_1), M_1(x_1), X_H(x_1) \quad \text{and} \quad R^{2n+2}(x_0, x_1), M_1(x_1), X_G(x_1).$$

We can do the same for the second tree using

$$R^{2n+2}(x_0, x_1), M_2(x_1), X_H(x_1) \quad \text{and} \quad R^{2n+3}(x_0, x_1), M_2(x_1), X_G(x_1).$$

We next achieve the correct representation of torus positions at G_1 -nodes in the first tree, and at G -nodes in the second tree. We only treat the first tree explicitly and leave to the reader the easy task to adapt the given CQs to the second tree. By construction of the template, this position is already represented by the T and F concept names used on the path of the tree that leads to the G_1 -node in question. We still need to ‘push this representation down’ to R_1 -paths to achieve the representation described above. For $1 \leq i, j \leq 2n$ with $i + j = 2n$, include the CQs

$$R^i(x_0, x_1), T(x_1), R^{j+2}(x_1, x_2), G_1(x_2), M_1(x_2)R_1^i(x_2, x_3), F(x_3)$$

and

$$R^i(x_0, x_1), F(x_1), R^{j+2}(x_1, x_2), G_1(x_2), M_1(x_2), R_1^i(x_2, x_3), T(x_3).$$

Note that this relies on the concept names T and F to be complements of each other. For example, take a homomorphism h from the upper CQ without the last atom $F(x_3)$ into a model \mathcal{I} of \mathcal{K} with $\mathcal{I} \not\models q_c^1$. Then $h(x_3)$ cannot make F true. But since T and F are complementary, it must make T true.

To make the counter value unique, we should also ensure that $\exists r^i.T$ and $\exists r^i.F$ are not both true, for any i with $1 \leq i \leq 2n$. We need this for all G -nodes, not only for G_1 -nodes. From now on, we use $(x \text{ bit } i = V)$, $0 \leq i < 2n$ and $V \in \{T, F\}$, to abbreviate $R_1^{i+1}(x, y)$, $V(y)$ for a fresh variable y . For $0 \leq i < 2n$, add the CQ

$$R^{2n+2}(x_0, x_1), G(x_1), M_1(x_1), (x_1 \text{ bit } i = T), (x_1 \text{ bit } i = F).$$

We further want (only for the main torus tree) that, relative to its G_1 -sibling, each G_2 -node represents the horizontal neighbor position in the grid and each G_3 -node represents the vertical neighbor position. This can be achieved by a couple of additional CQs that are slightly tedious. We only give CQs which express that if a G_1 -node represents (i, j) , then its G_2 -sibling represents $(i \oplus_{2^n} 1, j')$ for some j' . For $0 \leq i < n$, add the CQs

$$R^{2n}(x_0, x_1), R^2(x_1, y_1), G_1(y_1), \bigwedge_{0 \leq j \leq i} (y_1 \text{ bit } j = T), R^2(x_1, y_2), G_2(y_2), (y_2 \text{ bit } i = F)$$

and

$$R^{2n}(x_0, x_1), R^2(x_1, y_1), G_1(y_1), \bigwedge_{0 \leq j < i} (y_1 \text{ bit } j = T), (y_1 \text{ bit } i = F), R^2(x_1, y_2), G_2(y_2), (y_2 \text{ bit } i = T)$$

and for $0 \leq j < i < n$, add

$$R^{2n}(x_0, x_1), R^2(x_1, y_1), G_1(y_1), (y_1 \text{ bit } j = F), (y_1 \text{ bit } i = F), R^2(x_1, y_2), G_2(y_2), (y_2 \text{ bit } i = T)$$

and

$$R^{2n}(x_0, x_1), R^2(x_1, y_1), G_1(y_1), (y_1 \text{ bit } j = F), (y_1 \text{ bit } i = T), R^2(x_1, y_2), G_2(y_2), (y_2 \text{ bit } i = F).$$

It is not difficult to construct similar CQs which express that if a G_1 -node represents (i, j) , then its G_2 -sibling represents (i', j) for some i' and if a G_1 -node represents (i, j) , then its G_3 -sibling represents $(i, j \oplus_{2^n} 1)$.

Due to Line 6 of \mathcal{O} , every G -node is labeled with D_i for a unique tile type $i \in \mathfrak{T}$. The initial condition is now easily guaranteed. For $0 \leq i < n$, and each $j \in \mathfrak{T} \setminus \{c_i\}$, add the CQ

$$R^{2n+2}(x_0, x_1), G(x_1), M_1(x_1), D_j(x_1), (y_1 \text{ bit } 0 = V_0), \dots, (y_1 \text{ bit } n - 1 = V_{n-1})$$

where V_i is T if the i -th bit in the binary representation of i is 1 and F otherwise. We next enforce (in the first torus tree) that the horizontal and vertical matching conditions are satisfied locally in each gadget. For all $(i, j) \notin H$, put

$$R^{2n}(x_0, x_1), R^2(x_1, y_1), G_1(y_1), D_i(y_1), R^2(x_1, y_2), G_2(y_2), D_j(y_2)$$

and likewise for all $(i, j) \notin V$ and G_3 in place of G_2 . To prepare for the construction of the UCQ q_c^2 , we also want to achieve (in both torus trees) that G -nodes and their H -node predecessors are complementary regarding the bits of the counter: if d is an H -node and e its G -node successor, then d satisfies $\exists s^i.T$ iff e satisfies $\exists s^i.F$, for $1 \leq i \leq 2n$. We can enforce this using for $0 \leq i < 2n$ the CQs

$$R^{m+1}(x_0, x_1), H(x_1), (x_1 \text{ bit } i = T), R(x_1, x_2), G(x_2), M_1(x_2), (x_2 \text{ bit } i = T)$$

and

$$R^{m+1}(x_0, x_1), H(x_1), M_1(x_1), (x_1 \text{ bit } i = F), R(x_1, x_2), G(x_2), M_1(x_2)(x_2 \text{ bit } i = F).$$

To ensure the uniqueness of bit values also at H -nodes, we further add, for $0 \leq i < 2n$, the CQ

$$R^{2n+1}(x_0, x_1), H(x_1), (x_1 \text{ bit } i = T), (x_1 \text{ bit } i = F).$$

This finishes the construction of our first UCQ q_c^1 .

As explained above, the purpose of the second UCQ q_c^2 is to make sure that the (first and main) torus tree in models \mathcal{I} of \mathcal{K} with $\mathcal{I} \not\models q_c$ has no copying defects. To achieve this, it suffices to guarantee the following:

- (*) if a G -node in the first tree represents the same grid position as a G -node in the second tree, then their tile types coincide.

In (*), a G -node in the first tree can be any of a G_1 -, G_2 -, or G_3 -node. The UCQ q_c^2 is less straightforward to construct than those in q_c^1 and the ideas that we rely on were first used in [69, 70]. Actually, using the constructions from [69, 70], we could achieve that q_c^2 is a CQ rather than a UCQs. But since this makes the constructions more complex and the overall query q_c will be a UCQ anyway, we confine ourselves to q_c^2 being a UCQ. Enforcing (*) via q_c^2 relies on the second torus tree and on the complementary labeling of H - and G -nodes.

We want to construct q_c^2 so that it has a homomorphism into the torus trees iff (*) is violated, that is, iff there is a G -node in the first torus tree and one in the second tree that agree on the grid position but are labeled with different tile types. The UCQ q_c^2 contains one CQ $q_{j,\ell}$ for each choice of distinct tile types $j, \ell \in T$. We construct $q_{j,\ell}$ from component queries q_0, \dots, q_{2n-1} , which all take the form of the query displayed on the left-hand side of Figure A.5. All edges shown there represent subqueries of the form $S(x, y)$, which is an abbreviation for

$$R_0(x, y_1), R_0(z_1, y_1), R_0(z_1, y_2), R_0(z_2, y_2), R_0(z_2, y_3), R_0(y, y_3)$$

with y_1, y_2, y_3, z_1, z_2 fresh variables. Note that this differs from the edges $R(x, y)$ used in q_c^1 in that the concept names B_1, B_2, B_3 are not present, that is, here we use the edges in the torus tree as *symmetric* edges. Moreover, by construction every node in the torus tree has a reflexive S -loop, with S the above role sequence. With $q_i^V(y)$, $V \in \{T, F\}$, we abbreviate the CQ $(y \text{ bit } i = V)$ whose edges are not shown. The only difference between the component queries q_0, \dots, q_{2n-1} is that in query q_i , we use subqueries q_i^T and q_i^F .

We assemble q_0, \dots, q_{2n-1} into the desired CQ $q_{j,\ell}$ by taking variable disjoint copies of q_0, \dots, q_{2n-1} and then identifying (i) the variable y of all components, (ii) the variable z of all components, and (iii) the variable x_0 of all components, which is the answer variable. To see why q_c^2 achieves (*), first note that any homomorphism from a CQ $q_{j,\ell}$ in q_c^2 into the torus trees must map the variable x to a leaf of the first tree and z to a leaf of the second tree because of their M_1 - and M_2 -label. Call these leaves a and a' , respectively. Since y_0 and z_0 are connected to x in the query, both must then be mapped either to a or to its predecessor H -node; likewise, y_{4n+4} and z_{4n+4} must be mapped either to a' or to its predecessor. Since G -nodes and H -nodes are complementary regarding the bits of the counter, we are actually even more constrained: exactly one of y_0 and z_0 must be mapped to a , and exactly one of y_{4n+4} and z_{4n+4} to a' . Moreover, if y_0 is mapped to a , then z_{4n+4} must be mapped to a' and if z_0 is mapped to a , then y_{4n+4} must be mapped to a' . This is because q contains a path of length $4n + 4$ between y_0 and y_{4n+4} , as well as between z_0 and z_{4n+4} , while the shortest path between a and a' has $2n + 5$ edges. This shows that any homomorphism h from $q_{j,\ell}$ into the torus trees gives rise to one of the two variable identifications in each query q_i shown in Figure A.5. Note that the first case implies that $h(x)$ and $h(z)$ are both labeled with q_i^T while they are both labeled with q_i^F in the second case. In summary, $h(x)$ and $h(z)$ must thus agree on all bit values of the counter and, moreover, $h(x)$ is labeled with T_j while $h(z)$ is labeled with T_ℓ . As intended, h thus identifies a G -node $h(x)$ in the first torus tree and a G -node $h(z)$ in the second tree that agree on the grid position but are labeled with different tile types.

Using the arguments provided above, one can now prove the following, which finishes the proof of Theorem 62.

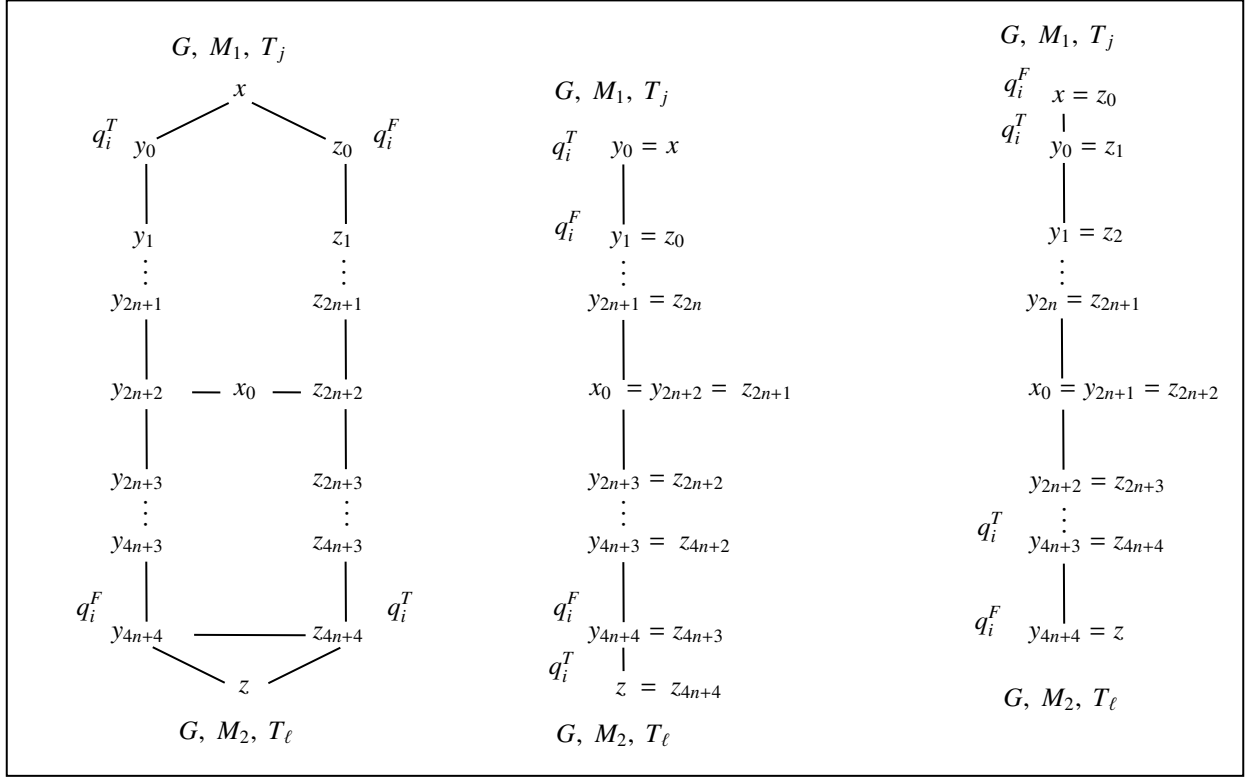

Figure A.5: The query q_i (left) and two collapsings.

Lemma 63. $\mathcal{K} \not\equiv q_c(a_0)$ iff there is a solution for \mathfrak{T} and c .

We now discuss a bit further our conjecture that projective separability in (GF, UCQ) and (projective or non-projective) separability in (GNFO, UCQ) are 2ExpTime -hard in data complexity, see the remarks after Theorem 14 and 34. For this, it suffices to show that there is a GF ontology \mathcal{O} such that unary rooted UCQ-evaluation on KBs with ontology \mathcal{O} is 2ExpTime -hard. Recall that we have proved Theorem 20 by adapting a reduction from [69, 70] that was used there to show that evaluating unary rooted CQs on \mathcal{ALCI} -KBs is coNExpTime -hard. The main challenge of the adaptation was to deal with the fact that the ontology \mathcal{O} has to be fixed in our case while it may depend on the initial condition c for the tiling problem in [69, 70], which also required us to replace the CQ from the original reduction with a UCQ. In [69, 70], it is also shown that evaluating Boolean CQs on \mathcal{ALCI} -KBs is 2ExpTime -hard. The reduction is from the word problem of a fixed exponentially space bounded alternating Turing machine (ATM) rather than from a tiling problem. In the same way in which we have adapted the coNExpTime -hard proof to use a fixed ontology, it seems very well possible to also adapt the 2ExpTime -hardness proof from [69, 70] in the same way, again at the expense of replacing the CQ used in the original reduction with a UCQ. We only refrain from doing so because the 2ExpTime -hardness proof in [69, 70] is considerably more technical than the coNExpTime -hardness proof from that paper, and as we have seen above even adapting the latter to the case of a fixed ontology has introduced rather significant additional technicalities.

It then remains to lift this 2ExpTime -hardness to GF. In fact, it seems straightforward to reduce the evaluation of Boolean UCQs on \mathcal{ALCI} -KBs to rooted UCQ-evaluation on GF-KBs in polynomial time, on databases that use only a single individual a_0 . This is the case in all the mentioned reductions and would thus clearly yield the conjectured result. The idea of such a reduction would be to increase the arity of all involved relation symbols by one, introducing one extra position in each symbol. One would then rewrite the \mathcal{ALCI} -ontology \mathcal{O} into a GF-ontology \mathcal{O}' so that when the ontology generates new facts, the single individual a_0 used in an input database \mathcal{D} is ‘passed on’ to all these facts in the extra position. The original Boolean UCQ q would be modified by introducing a fresh answer variable x_0 and

using it in the extra position of each atom. Clearly, the resulting UCQ q' is unary and rooted. Moreover, $(O, \mathcal{D}) \models q$ iff $(O', \mathcal{D}) \models q'(a_0)$.

We also briefly comment on obtaining lower bounds for the data complexity of RE-existence and entity distinguishability. Here, we would have to improve the above proof of Theorem 20 by replacing the UCQ used there with a CQ. However, when transitioning from the constructions in [69, 70] to the constructions used here (that is, from a non-fixed ontology to a fixed ontology), many ‘responsibilities’ formerly taken by the ontology had to be shifted into the query. In fact, it is this shifting that forced us to replace the CQ from the original reduction by a UCQ. It is rather unclear to us how and whether all the ‘responsibilities’ taken by the query in the reduction presented above can be encoded into a CQ in place of a UCQ.

We next prove Claim 2 from the proof of Theorem 24. Let $\mathcal{K} = (O, \mathcal{D})$ be an \mathcal{ALCI} -KB. Recall that a sequence $\sigma = t_0 R_0 \dots R_n t_{n+1}$ of \mathcal{K} -types t_0, \dots, t_{n+1} and Σ -roles R_0, \dots, R_n witnesses \mathcal{ALCI} -incompleteness of a \mathcal{K} -type t for \mathcal{K} if $t = t_0$, $n \geq 1$, and

- $t_i \rightsquigarrow_{R_i} t_{i+1}$ for $i \leq n$;
- there exists a model \mathfrak{A} of \mathcal{K} and nodes $d_{n-1}, d_n \in \text{dom}(\mathfrak{A})$ with $(d_{n-1}, d_n) \in R_{n-1}^{\mathfrak{A}}$ such that d_{n-1} and d_n realize t_{n-1} and t_n in \mathfrak{A} , respectively, and there does not exist d_{n+1} in \mathfrak{A} realizing t_{n+1} with $(d_n, d_{n+1}) \in R_n^{\mathfrak{A}}$.

Lemma 64. *The following conditions are equivalent, for any \mathcal{K} -type t :*

1. t is not \mathcal{ALCI} -complete for \mathcal{K} ;
2. there is a sequence witnessing \mathcal{ALCI} -incompleteness of t for \mathcal{K} ;
3. there is a sequence of length not exceeding $2^{\|\mathcal{O}\|} + 2$ witnessing \mathcal{ALCI} -incompleteness of t for \mathcal{K} .

It is decidable in ExpTime whether a \mathcal{K} -type t is \mathcal{ALCI} -complete for \mathcal{K} .

Proof. “1. \Rightarrow 2.” Let $\Sigma = \text{sig}(\mathcal{K})$. Consider the tree-shaped ‘maximal’ model \mathfrak{A}_t of O whose root c realizes t such that if a node $e \in \text{dom}(\mathfrak{A}_t)$ realizes any \mathcal{K} -type t_1 and is of depth $k \geq 0$, then for every \mathcal{K} -type t_2 with $t_1 \rightsquigarrow_R t_2$ for some Σ -role R there exists e' realizing t_2 of depth $k+1$ with $(e, e') \in R^{\mathfrak{A}_t}$. (The construction of \mathfrak{A}_t is straightforward: its domain is the set of all sequence $t_0 R_0 \dots R_n t_n$ with $n \geq 0$ such that $t_0 = t$, all t_i are \mathcal{K} -types, all R_i are Σ -roles, and $t_i \rightsquigarrow_{R_i} t_{i+1}$ for all $i < n$. We set $t_0 R_0 \dots R_n t_n \in A^{\mathfrak{A}_t}$ if $A \in t_n$ and $(w, wRt') \in R^{\mathfrak{A}_t}$ if $wRt' \in \text{dom}(\mathfrak{A}_t)$.) If t is not \mathcal{ALCI} -complete for \mathcal{K} , then there exists a model \mathfrak{B}_t of O realizing t in its root c such that $\mathfrak{A}_t, c \not\equiv_{\mathcal{ALCI}, \Sigma} \mathfrak{B}_t, c$. But then there exists a sequence $\sigma = t_0 R_0 \dots R_n t_{n+1}$ with $n \geq 0$, $t = t_0$, $t_i \rightsquigarrow_{R_i} t_{i+1}$ for $i \leq n$, and such that a sequence $c = d_0, \dots, d_n$ of nodes in \mathfrak{B}_t realizes $t_0 R_0 \dots R_n t_n$ in \mathfrak{B}_t and there does not exist d_{n+1} realizing t_{n+1} with $(d_n, d_{n+1}) \in R_n^{\mathfrak{B}_t}$. Then σ witnesses \mathcal{ALCI} -incompleteness of t for \mathcal{K} if $n > 0$. If $n = 0$, then it follows from $\exists R_0. \top \in t$ that there exists d' realizing a \mathcal{K} -type t'' in \mathfrak{B}_t such that $(c, d') \in R_0^{\mathfrak{B}_t}$. Then the sequence $tR_0 t'' R_0 t_{n+1}$ is as required.

“2 \Rightarrow 3”. This implication can be proved by a straightforward pumping argument. If $t_0 R_0 \dots R_n t_{n+1}$ witnesses \mathcal{ALCI} -incompleteness of t for \mathcal{K} and $n \geq 2^{\|\mathcal{O}\|} + 2$, then there are $0 \leq i < j < n$ such that $t_i = t_j$. Then take the sequence $t_0 R_0 \dots t_i R_j t_{j+1} \dots R_n t_{n+1}$ instead.

“3 \Rightarrow 1” holds by definition.

To show that it is in ExpTime to decide whether a \mathcal{K} -type t is \mathcal{ALCI} -complete for \mathcal{K} , observe that one can construct a structure \mathfrak{A} whose domain consists of all \mathcal{K} -types t and such that $t \in A^{\mathfrak{A}}$ if $A \in t$ and $(t_1, t_2) \in R^{\mathfrak{A}}$ if $t_1 \rightsquigarrow_R t_2$. Then t is not \mathcal{ALCI} -complete for \mathcal{K} iff there exists a path starting at t in \mathfrak{A} that ends with $R_{n-1}^{\mathfrak{A}} t_n R_n^{\mathfrak{A}} t_{n+1}$ such that the second condition for sequences witnessing \mathcal{ALCI} -incompleteness holds. The existence of such a path can be decided in exponential time. \square

Appendix B. Proofs for Section 5.2

The aim of this Section is to prove the equivalence of Points 1 to 4 and Point 5 of Theorem 37. We introduce a few important notions required for the proof. A *guarded tree decomposition* [72, 71] of a structure \mathfrak{A} is a triple (T, E, bag) with (T, E) an undirected tree and bag a function that assigns to every $t \in T$ a guarded set $\text{bag}(t)$ in \mathfrak{A} such that

1. $\mathfrak{A} = \bigcup_{t \in T} \mathfrak{A}_{|\text{bag}(t)}$;
2. $\{t \in T \mid a \in \text{bag}(t)\}$ is connected in (T, E) , for every $a \in \text{dom}(\mathfrak{A})$.

When convenient, we assume that (T, E) has a designated root r which allows us to view (T, E) as a directed tree. Also, it will be useful to allow $\text{bag}(r)$ with r the designated root of T not to be guarded. The difference between a classical tree decomposition and a guarded one is that in the latter the elements in each bag, except the bag of the root, must be a guarded set. While there is a classical tree decomposition of every structure, albeit of potentially high width (that is, maximum bag size), this is not the case for guarded tree decompositions. We say that \mathfrak{A} is *guarded tree decomposable* if there exists a guarded tree decomposition of \mathfrak{A} . Observe that for every GF-ontology \mathcal{O} and GF-formula $\varphi(\vec{x})$ such that $\mathcal{O} \not\models \varphi$ there exists a guarded tree decomposable model \mathfrak{A} of \mathcal{O} such that $\mathfrak{A} \models \neg\varphi(\vec{a})$ for a tuple \vec{a} with $[\vec{a}] = \text{bag}(r)$, r the designated root of the underlying tree [72, 71].

We next provide a characterization of openGF-complete \mathcal{K} -types in the same style as in Claim 2 of the proof of Theorem 24 for \mathcal{ALCI} . To this end we need some notation for paths in a structure and a way to transform paths into strict paths without interfering with the realized openGF-types along the path. A *path* of length n from a to b in a structure \mathfrak{A} is a sequence $R_1(\vec{b}_1), \dots, R_n(\vec{b}_n)$ with

- $\mathfrak{A} \models R_i(\vec{b}_i)$ and $|\vec{b}_i| \geq 2$ for all $i \leq n$;
- $a \in [\vec{b}_1], b \in [\vec{b}_n]$;
- $[\vec{b}_i] \cap [\vec{b}_{i+1}] \neq \emptyset$, for all $i < n$.

Note that there is a path from a to b in \mathfrak{A} if there is a path from a to b in the Gaifman graph of \mathfrak{A} . We call a path *strict* if all $[\vec{b}_i] \cap [\vec{b}_{i+1}]$ are singletons containing distinct points c_i and there are sets $A_1, \dots, A_n \subseteq \text{dom}(\mathfrak{A})$ covering $\text{dom}(\mathfrak{A})$ such that $[\vec{b}_i] \subseteq A_i$, $A_i \cap A_{i+1} = \{c_i\}$ and such that if $i < j$, then any path in the Gaifman graph of \mathfrak{A} from an element of A_i to an element of A_j contains c_k for all $k \in \{i, \dots, j-1\}$. We next introduce a transformation of paths into strict paths. The *partial unfolding* $\mathfrak{A}_{\vec{a}}$ of a structure \mathfrak{A} along a tuple $\vec{a} = (a_1, \dots, a_n)$ in $\text{dom}(\mathfrak{A})$ such that $\text{dist}_{\mathfrak{A}}(a_i, a_{i+1}) = 1$ for all $i < n$ is defined as the following union of $n+1$ copies of \mathfrak{A} . Denote the copies by $\mathfrak{A}_1, \mathfrak{A}_2, \dots, \mathfrak{A}_{n+1}$. The copies are mutually disjoint except that \mathfrak{A}_i and \mathfrak{A}_{i+1} share a copy of a_i . Formally, the domain of \mathfrak{A}_i is $\mathfrak{A} \times \{i\}$ except that (a_{i-1}, i) is replaced by $(a_{i-1}, i-1)$, for all $i > 1$. The constants are interpreted in \mathfrak{A}_i as before and we often denote the elements (a, i) of \mathfrak{A}_1 simply by a . We following figure illustrates this construction for a path $R_1(\vec{a}_1), \dots, R_n(\vec{a}_n)$ with $a_i \in [\vec{a}_i] \cap [\vec{a}_{i+1}]$ for $i \leq n$.

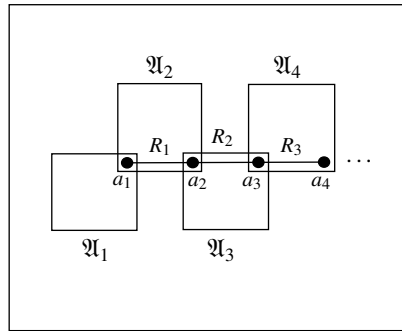

We use the following properties of $\mathfrak{A}_{\vec{a}}$:

Lemma 65. 1. *If $i < j$, then any path in $\mathfrak{A}_{\vec{a}}$ from an element of $\text{dom}(\mathfrak{A}_i)$ to an element of $\text{dom}(\mathfrak{A}_j)$ contains (a_k, k) for all $k \in \{i, \dots, j-1\}$;*

2. Let I contain for all i with $1 \leq i \leq n+1$ and all guarded (b_1, \dots, b_k) in \mathfrak{A} the mappings $p : (b_1, \dots, b_k) \mapsto (c_1, \dots, c_k)$, where $c_j = (b_j, i)$ if $b_j \neq a_{i-1}$ and $c_j = (b_j, i-1)$ if $b_j = a_{i-1}$. Then I is a guarded bisimulation between \mathfrak{A} and $\mathfrak{A}_{\vec{a}}$.
3. If \mathfrak{A} is a model of \mathcal{K} , then $\mathfrak{A}_{\vec{a}}$ is a model of \mathcal{K} .
4. The mapping h from $\mathfrak{A}_{\vec{a}}$ to \mathfrak{A} defined by setting $h(b, i) = b$ is a homomorphism from $\mathfrak{A}_{\vec{a}}$ to \mathfrak{A} .

Assume that $R_0(\vec{a}_0), \dots, R_n(\vec{a}_n)$ is a path in \mathfrak{A} with $a_{i+1} \in [\vec{a}_i] \cap [\vec{a}_{i+1}]$ for $i \leq n$. Let $\vec{a}_i = (a_i^1, \dots, a_i^{n_i})$ and assume $a_i^1 = a_{i+1}$. Then $R_0(\vec{a}_0, 1), \dots, R_n(\vec{a}_n, n+1)$ is a strict path in $\mathfrak{A}_{\vec{a}}$ realizing the same \mathcal{K} -types as the original path, where

$$\begin{aligned} (\vec{a}_0, 1) &:= ((a_0^1, 1), \dots, (a_0^{n_0}, 1)) \\ (\vec{a}_i, i+1) &:= ((a_i^1, i), (a_i^2, i+1), \dots, (a_i^{n_i}, i+1)) \end{aligned}$$

Let $\mathcal{K} = (\mathcal{O}, \mathcal{D})$ be a GF-KB and $\Sigma = \text{sig}(\mathcal{K})$. We give a syntactic description of when a \mathcal{K} -type $\Phi(x)$ is openGF-complete. A *guarded \mathcal{K} -type* $\Phi(\vec{x})$ is a \mathcal{K} -type that contains an atom $R(\vec{x})$. Call \mathcal{K} -types $\Phi_1(\vec{x}_1)$ and $\Phi_2(\vec{x}_2)$ *coherent* if there exists a model \mathfrak{A} of \mathcal{K} satisfying $\Phi_1 \cup \Phi_2$ under an assignment μ for the variables in $[\vec{x}_1] \cup [\vec{x}_2]$. For a \mathcal{K} -type $\Phi(\vec{x})$ and a subsequence \vec{x}_I of \vec{x} we denote by $\Phi_{|\vec{x}_I}$ the subset of Φ containing all formulas in Φ with free variables from \vec{x}_I . $\Phi_{|\vec{x}_I}$ is called *the restriction of Φ of \vec{x}_I* . Observe that \mathcal{K} -types $\Phi_1(\vec{x}_1)$ and $\Phi_2(\vec{x}_2)$ are coherent iff their restrictions to $[\vec{x}_1] \cap [\vec{x}_2]$ are logically equivalent. Assume a \mathcal{K} -type $\Phi(x)$ is given. A sequence

$$\sigma = \Phi_0(\vec{x}_0), \dots, \Phi_n(\vec{x}_n), \Phi_{n+1}(\vec{x}_{n+1})$$

witnesses *openGF-incompleteness* of Φ if Φ is the restriction of Φ_0 to x , $n \geq 0$, and all Φ_i , $0 \leq i \leq n+1$, are guarded \mathcal{K} -types each containing the formula $\neg(x = y)$ for some variables x, y (we say that the Φ_i are *non-unary*) such that $[\vec{x}_i] \cap [\vec{x}_{i+1}] \neq \emptyset$, all Φ_i, Φ_{i+1} are coherent, and there exists a model \mathfrak{A} of \mathcal{K} and a tuple \vec{a}_n in \mathfrak{A} such that $\mathfrak{A} \models (\Phi_n \wedge \neg \exists \vec{x}_{n+1} \Phi_{n+1})(\vec{a}_n)$, where \vec{x}_{n+1} is the sequence \vec{x}_{n+1} without $[\vec{x}_n] \cap [\vec{x}_{n+1}]$.

Lemma 66. *The following conditions are equivalent, for any \mathcal{K} -type $\Phi(x)$:*

1. $\Phi(x)$ is not openGF-complete;
2. there is a sequence witnessing openGF-incompleteness of $\Phi(x)$;
3. there is a sequence of length not exceeding $2^{2^{|\text{cl}(\mathcal{K})|}} + 2$ witnessing openGF incompleteness of $\Phi(x)$.

It is decidable in 2EXPTIME whether a \mathcal{K} -type $\Phi(x)$ is openGF complete.

Proof. The proof is an extension of the proof of Lemma 64 above. Let $\Sigma = \text{sig}(\mathcal{K})$. It is straightforward to construct a guarded tree decomposable model \mathfrak{A} of \mathcal{O} with tree decomposition (T, E, bag) and root r such that $\Phi(x)$ is realized in $\text{bag}(r)$ by a and for every \mathcal{K} -type $\Psi_1(\vec{x})$ realized in some $\text{bag}(t)$ by \vec{a} and every \mathcal{K} -type $\Psi_2(\vec{y})$ coherent with $\Psi_1(\vec{x})$ there exists a successor t' of t in T such that $\Psi_1(\vec{x}) \cup \Psi_2(\vec{y})$ is realized in $\text{bag}(t) \cup \text{bag}(t')$ in \mathfrak{A} under an assignment μ of the variables $[\vec{x}] \cup [\vec{y}]$ such that $\mu(\vec{x}) = \vec{a}$. Thus, \mathfrak{A} satisfies $\forall \vec{x} (\Psi_1 \rightarrow \exists \vec{y} \Psi_2)$ for any coherent pair $\Psi_1(\vec{x}), \Psi_2(\vec{y})$, where \vec{y} is \vec{y} without $[\vec{x}] \cap [\vec{y}]$.

“1 \Rightarrow 2”. If $\Phi(x)$ is not openGF-complete, then there exists a guarded tree decomposable model \mathfrak{A}' of \mathcal{K} with root r which realizes $\Phi(x)$ in $\text{bag}(r)$ at a' such that $\mathfrak{A}, a \approx_{\text{openGF}, \Sigma} \mathfrak{A}', a'$. But then \mathfrak{A}, a realizes a sequence σ that witnesses openGF-incompleteness of $\Phi(x)$, except that possibly there exists already a guarded non-unary \mathcal{K} -type $\Phi_0(\vec{x}_0)$ which is realized in some \vec{a}_0 in \mathfrak{A} with $a \in [\vec{a}_0]$ but there is no \vec{a}'_0 in \mathfrak{A}' containing a' and realizing $\Phi_0(\vec{x}_0)$. Let $R_0(\vec{x}_0) \in \Phi_0$. Then, because we included the formulas $\exists \vec{y}_1 (R_0(\vec{x}_n) \wedge x \neq y)$ with n the arity of R_0 , x, y distinct variable in \vec{x}_n , and \vec{y}_1 defined as \vec{y}_n without x , in $\text{cl}(\mathcal{K})$, there exists a non-unary guarded \mathcal{K} -type $\Phi'(\vec{x}'_0)$ containing $R_0(\vec{x}'_0)$ such that there exists a tuple \vec{a}'_0 in \mathfrak{A}' containing a' realizing Φ' . We obtain a sequence σ of any length by first taking $\Phi'(\vec{x}'_0)$ an arbitrary number of times and then appending Φ_0 .

“2 \Rightarrow 3”. This can be proved by a straightforward pumping argument. This is particularly straightforward if one works with a sequence σ realized by a strict path. Consider a sequence

$$\sigma = \Phi_0(\vec{x}_0), \dots, \Phi_n(\vec{x}_n), \Phi_{n+1}(\vec{x}_{n+1})$$

that witnesses openGF-incompleteness of $\Phi(x)$ and a model \mathfrak{A} of \mathcal{K} satisfying $\mathfrak{A} \models (\Phi_n \wedge \neg \exists \vec{x}_{n+1} \Phi_{n+1})(\vec{a}_n)$. We may assume (by possibly repeating Φ_n once in the sequence) that there is a model \mathfrak{A} of \mathcal{K} with a path $R_0(\vec{a}_0), \dots, R_n(\vec{a}_n)$ such that \vec{a}_i realizes Φ_i and $\mathfrak{A} \models (\Phi_n \wedge \neg \exists \vec{x}_{n+1} \Phi_{n+1})(\vec{a}_n)$. We now modify \mathfrak{A} in such a way that we obtain a sequence witnessing openGF-incompleteness of $\Phi(x)$ which is realized by a strict path. Choose a sequence $\vec{a} = (a_1, \dots, a_m)$ such that $a_1 = a$ for the node a in \vec{a}_0 realizing $\Phi(x)$, $a_i \neq a_{i+1}$ and $a_i, a_{i+1} \in [\vec{a}_j]$ for some $j \leq n$, for all $i < m$, and $a_m \in \vec{a}_n$. Clearly one can find such a sequence for some $m \leq 2n$. Then take the partial unfolding $\mathfrak{A}_{\vec{a}}$ of \mathfrak{A} along \vec{a} . In $\mathfrak{A}_{\vec{a}}$ we find the required strict path (Lemma 65). Pumping on this path is straightforward.

“ $3 \Rightarrow 1$ ”. Straightforward.

The 2EXPTIME upper bound for deciding whether a \mathcal{K} -type is openGF-complete can now be proved similarly to the EXPTIME upper bound for deciding whether a type defined by an \mathcal{ALCI} -KB is \mathcal{ALCI} -complete. \square

Lemma 67. *A \mathcal{K} -type $\Phi(\vec{x})$ is openGF-complete iff all restrictions $\Phi(x)$ of Φ to some variable x in \vec{x} are openGF-complete.*

Proof. The direction from left to right is straightforward. Conversely, assume that $\Phi(\vec{x})$ is not openGF-complete. One can show similarly to the proof of Lemma 66 that (i) or (ii) holds:

(i) there exists a guarded \mathcal{K} -tuple $\Phi_0(\vec{x}_0)$ sharing with \vec{x} the variables \vec{x}_I for some nonempty $I \subseteq \{1, \dots, n\}$ such that for \vec{x}_0 the variables in \vec{x}_0 without \vec{x}_I the following hold: there exists a model \mathfrak{A} of \mathcal{K} realizing Φ in a tuple \vec{a} such that (a) $\mathfrak{A} \models (\exists \vec{x}_0 \Phi_0)(\vec{a}_I)$ and there also exists a model \mathfrak{B} of \mathcal{K} realizing Φ in a tuple \vec{b} such that (b) $\mathfrak{B} \not\models (\exists \vec{x}_0 \Phi_0)(\vec{a}_I)$.

(ii) there exists a guarded \mathcal{K} -tuple $\Phi_0(\vec{x}_0)$ sharing with \vec{x} the variables \vec{x}_I for some nonempty $I \subseteq \{1, \dots, n\}$ and a sequence of guarded \mathcal{K} -tuples $\Phi_1(\vec{x}_1), \dots, \Phi_n(\vec{x}_n), \Phi_{n+1}(x_{n+1})$ with $n \geq 1$ such that $\Phi(\vec{x}) \cup \Phi_0(\vec{x}_0)$ is satisfiable in a model of \mathcal{K} and $\Phi_0(\vec{x}_0), \Phi_1(\vec{x}_1), \dots, \Phi_n(\vec{x}_n), \Phi_{n+1}(x_{n+1})$ satisfy the conditions of a sequence witnessing non openGF-completeness, except that no type $\Phi(x)$ of which it witnesses non openGF-completeness is given.

If (ii), then we are done by taking any variable x in x_I and the restriction Φ_x of Φ to x . Then Φ_x is not openGF-complete. Now assume that (i) holds. We are again done if I contains at most one element (we can simply take the type of $\text{tp}_{\mathcal{K}}(\mathfrak{A}, a_I)$ then). Otherwise consider a relation R_0 with $R_0(\vec{x}_0) \in \Phi_0$. By the closure condition on \mathcal{K} -types, we have for the model \mathfrak{B} of \mathcal{K} satisfying (b) that $\mathfrak{B} \models \exists \vec{x}_0 R_0(\vec{x}_0)(\vec{a}_I)$. Take an extension \vec{a}_1 of \vec{a}_I such that $\mathfrak{B} \models R_0(\vec{a}_1)$. Take any $a \in \vec{a}_1$, the unary \mathcal{K} -type $\Phi(x) = \text{tp}_{\mathcal{K}}(\mathfrak{B}, a)$, and the \mathcal{K} -type $\Phi_1(\vec{x}_1) := \text{tp}_{\mathcal{K}}(\mathfrak{B}, \vec{a}_1)$. Then the sequence Φ_1, Φ_0 shows that $\Phi(x)$ is not openGF-complete. \square

We next introduce *guarded embeddings* as an intermediate step between homomorphisms witnessing $\mathcal{D}_{\text{con}(\vec{a}, \vec{a})} \rightarrow \mathfrak{A}, \vec{b}^{\mathfrak{A}}$ and the existence of models \mathfrak{B} of \mathcal{K} such that there exists a bounded guarded bisimulation between some $\mathfrak{B}, \vec{a}^{\mathfrak{B}}$ and $\mathfrak{A}, \vec{b}^{\mathfrak{A}}$. Let \mathcal{D}, \vec{a} be a pointed database, \mathfrak{A}, \vec{b} a pointed structure, $\ell \geq 0$, and $\Sigma \supseteq \text{sig}(\mathcal{D})$ a signature. A *partial embedding* is an injective partial homomorphism. A pair (e, H) is a *guarded Σ ℓ -embedding between \mathcal{D}, \vec{a} and \mathfrak{A}, \vec{b}* if e is a homomorphism from \mathcal{D} onto a database \mathcal{D}' and H is a set of partial embeddings from \mathcal{D}' to \mathfrak{A} containing $h_0 : e(\vec{a}) \mapsto \vec{b}$ and a partial embedding h from any guarded set in \mathcal{D}' to \mathfrak{A} such that the following condition hold:

- if $h_i : \vec{a}_i \mapsto \vec{b}_i \in H$ for $i = 1, 2$, then there exists a partial isomorphism $p : h_1([\vec{a}_1] \cap [\vec{a}_2]) \mapsto h_2([\vec{a}_1] \cap [\vec{a}_2])$ such that $p \circ h_1$ and h_2 coincide on $[\vec{a}_1] \cap [\vec{a}_2]$ and for any \vec{c} with $[\vec{c}] = h_1([\vec{a}_1] \cap [\vec{a}_2]), \mathfrak{A}, \vec{c} \sim_{\text{openGF}, \Sigma}^{\ell} \mathfrak{A}, p(\vec{c})$.

We write $\mathcal{D}, \vec{a} \leq_{\text{openGF}, \Sigma}^{\ell} \mathfrak{A}, \vec{b}^{\mathfrak{A}}$ if there exists a guarded Σ ℓ -embedding H between \mathcal{D}, \vec{a} and \mathfrak{A}, \vec{b} .

The following lemma shows that guarded Σ ℓ -embeddings determine a sequence H_{ℓ}, \dots, H_0 of partial embeddings satisfying the (forth) condition of guarded Σ ℓ -bisimulations.

Lemma 68. *Let (\mathcal{D}, \vec{a}) be a pointed database and $(\mathfrak{A}, \vec{b}^{\mathfrak{A}})$ be a pointed model such that $(\mathcal{D}, \vec{a}) \leq_{\text{openGF}, \Sigma}^{\ell} (\mathfrak{A}, \vec{b}^{\mathfrak{A}})$. Then there exist a surjective homomorphism $e : \mathcal{D} \rightarrow \mathcal{D}'$ for some database \mathcal{D}' and sets H_{ℓ}, \dots, H_0 of partial embeddings $\mathcal{D}' \rightarrow \mathfrak{A}$ such that*

1. for all $k \leq \ell$, all $h \in H_k$ and all guarded sets \vec{c} in \mathcal{D}' such that $[\vec{c}] \cap \text{dom}(h) \neq \emptyset$, there exists $h' \in H_{k-1}$ with $\text{domain}[\vec{c}]$ such that h' coincides with h on $[\vec{c}] \cap \text{dom}(h)$.
2. for all $k_1, k_2 \leq \ell$, all $h_1 \in H_{k_1}, h_2 \in H_{k_2}$, and all tuples \vec{c}_1, \vec{c}_2 in \mathcal{D}' such that $[\vec{c}_1] = \text{dom}(h_1)$, we have $h_1(\vec{c}) \sim_{\text{openGF}, \Sigma}^{\min(k_1, k_2)} h_2(\vec{c})$ for all \vec{c} such that $[\vec{c}] = [\vec{c}_1] \cap [\vec{c}_2]$.

Proof. Let H be the set of partial embeddings witnessing $(\mathcal{D}, \vec{d}) \leq_{\text{openGF}, \Sigma}^{\ell} (\mathfrak{A}, \vec{b}^{\text{st}})$. Define $H_{\ell} := H$. We define H_k for $k < \ell$ by induction. Suppose H_k has been defined. We define H_{k-1} . We assume that for all $h_1 \in H_k, h_2 \in H_{\ell}$ having intersecting domains $[\vec{c}_1], [\vec{c}_2]$, with \vec{c}_2 being guarded the following condition holds:

- (*) for any tuple \vec{c} in \mathcal{D}' such that $[\vec{c}] = [\vec{c}_1] \cap [\vec{c}_2]$, there is a partial isomorphism $p : h_1(\vec{c}) \mapsto h_2(\vec{c})$ witnessing $h_1(\vec{c}) \sim_{\text{openGF}, \Sigma}^k h_2(\vec{c})$. The following figure illustrates our claim.

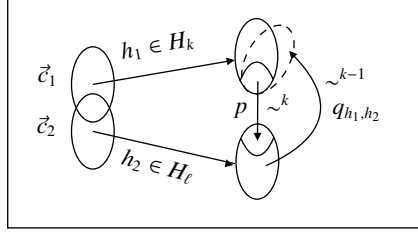

Now assume that h_1, h_2 satisfying the conditions above are given. As $[h_2(\vec{c}_2)]$ is guarded (by \vec{c}_2 being guarded and h a partial homomorphism) and intersects $h_2[[\vec{c}_1] \cap [\vec{c}_2]]$, and as p witnesses a $\text{openGF } \Sigma$ k -bisimulation, there exists a partial isomorphism q_{h_1, h_2} with domain $[h_2(\vec{c}_2)]$ witnessing $h_2(\vec{c}_2) \sim_{\text{openGF}, \Sigma}^{k-1} q_{h_1, h_2}(h_2(\vec{c}_2))$ and that coincides with p^{-1} on $h_2[[\vec{c}_1] \cap [\vec{c}_2]]$. We then include $q_{h_1, h_2} \circ h_2$ in H_{k-1} .

This is well-defined, as the assumption (*) holds for all $k \leq \ell$:

- If $k = \ell$, then (*) is stated in the definition of Σ ℓ -guarded embeddings.
- If $0 < k < \ell$ and (*) holds for k , let $h_1 \in H_{k-1}, h_2 \in H_{\ell}$ with intersecting domains $[\vec{c}_1], [\vec{c}_2]$ and \vec{c}_2 guarded be given. Then $h_1 = q_{\eta_1, \eta_2} \circ \eta_2$ for some $\eta_1 \in H_k, \eta_2 \in H_{\ell}$, by definition of H_{k-1} . By definition of Σ ℓ -guarded embeddings, as η_2 and h_2 are both in H_{ℓ} and have intersecting domains $[\vec{c}_1]$ and $[\vec{c}_2]$, there exists a partial isomorphism p' witnessing $\eta_2(\vec{c}) \sim_{\text{openGF}, \Sigma}^{\ell} h_2(\vec{c})$ for any \vec{c} such that $[\vec{c}] = [\vec{c}_1] \cap [\vec{c}_2]$. Then, by composition of bisimulations, $p := p'_{|\eta_2[\vec{c}]} \circ (q_{\eta_1, \eta_2}^{-1})_{|h_1[\vec{c}]}$ is a partial isomorphism witnessing $h_1(\vec{c}) \sim_{\text{openGF}, \Sigma}^{k-1} h_2(\vec{c})$ i.e. (*) holds for $k - 1$. The situation is illustrated by the following figure.

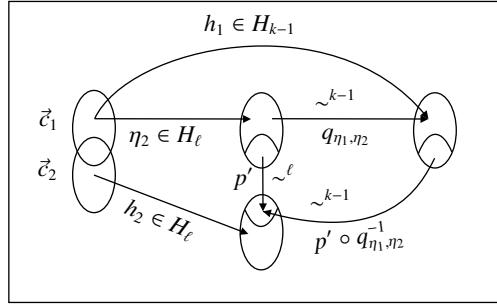

Elements of H_{k-1} are partial embeddings, as compositions of partial isomorphisms with partial embeddings. We thus have a homomorphism $e : \mathcal{D} \rightarrow \mathcal{D}'$ and sets H_{ℓ}, \dots, H_0 of partial embeddings $\mathcal{D}' \rightarrow \mathfrak{A}$. We now prove that Conditions 1 and 2 hold.

1. Let $0 \leq k \leq \ell$ and $h_1 \in H_k$ with domain $[\vec{c}_1]$. Let \vec{c}_2 be guarded in \mathcal{D}' such that $[\vec{c}_1] \cap [\vec{c}_2] \neq \emptyset$. By definition of ℓ -guarded embeddings, every guarded tuple is the domain of some embedding in $H = H_{\ell}$. In particular there exists $h_2 \in H_{\ell}$ with domain $[\vec{c}_2]$. Then Condition (*) holds, with matching notation. Consider q_{h_1, h_2} and p as defined above. A witnessing partial homomorphism h' can be defined as $h' := q_{h_1, h_2} \circ h_2 \in H_{k-1}$. Since $p^{-1} \circ h_2$ coincides with h_1 on $[\vec{c}_1] \cap [\vec{c}_2]$, and q_{h_1, h_2} coincides with p^{-1} on $h_2[[\vec{c}_1] \cap [\vec{c}_2]]$, it follows that h' coincides with h_1 on $[\vec{c}_1] \cap [\vec{c}_2]$.
2. Let $h_1 \in H_{k_1}, h_2 \in H_{k_2}$ with intersecting domains $[\vec{c}_1], [\vec{c}_2]$. By definition of ℓ -guarded embeddings, there exists h'_2 in $H = H_{\ell}$ with domain $[\vec{c}_2]$. By (*), for every \vec{c} in \mathcal{D}' such that $[\vec{c}] = [\vec{c}_1] \cap [\vec{c}_2]$ we have $h_1(\vec{c}) \sim_{\text{openGF}, \Sigma}^{k_1} h'_2(\vec{c})$ and $h_2(\vec{c}) \sim_{\text{openGF}, \Sigma}^{k_2} h'_2(\vec{c})$, thus $h_1(\vec{c}) \sim_{\text{openGF}, \Sigma}^{\min(k_1, k_2)} h_2(\vec{c})$ by composition of bisimulations.

□

Observe that if H_ℓ, \dots, H_0 satisfying the conditions of Lemma 68 exist, then $H_\ell \subseteq \dots \subseteq H_0$: let $k \leq \ell$ and $\vec{c} \mapsto \vec{d} \in H_k$. By condition (1), since $[\vec{c}] \cap [\vec{c}] \neq \emptyset$ there exists $\vec{c}' \mapsto \vec{d}' \in H_{k-1}$ that coincides with $\vec{c} \mapsto \vec{d}$ on $[\vec{c}]$, i.e. $\vec{c}' \mapsto \vec{d}' \in H_{k-1}$.

We are now in a position to show the first main lemma linking characterizations of separability using bounded guarded bisimulations, bounded guarded embeddings, and bounded connected guarded bisimulations.

Lemma 69. *Let $(\mathcal{K}, P, \{\vec{b}\})$ be a labeled GF-KB and $\Sigma = \text{sig}(\mathcal{K})$. Then the following conditions are equivalent:*

1. $(\mathcal{K}, P, \{\vec{b}\})$ is openGF-separable.
2. $(\mathcal{K}, P, \{\vec{b}\})$ is GF-separable.
3. there exists a (finite) model \mathfrak{A} of \mathcal{K} and $\ell \geq 0$ such that for all models \mathfrak{B} of \mathcal{K} and $\vec{a} \in P$: $\mathfrak{B}, \vec{a}^{\mathfrak{B}} \sim_{GF, \Sigma}^\ell \mathfrak{A}, \vec{b}^{\mathfrak{A}}$.
4. there exists a (finite) model \mathfrak{A} of \mathcal{K} and $\ell \geq 0$ such that for all $\vec{a} \in P$: $\mathcal{D}_{\text{con}(\vec{a})}, \vec{a} \not\sim_{\text{openGF}, \Sigma}^\ell \mathfrak{A}, \vec{b}^{\mathfrak{A}}$.
5. there exists a (finite) model \mathfrak{A} of \mathcal{K} and $\ell \geq 0$ such that for all models \mathfrak{B} of \mathcal{K} and all $\vec{a} \in P$: $\mathfrak{B}, \vec{a}^{\mathfrak{B}} \sim_{\text{openGF}, \Sigma}^\ell \mathfrak{A}, \vec{b}^{\mathfrak{A}}$.

Proof. The implications “1. \Rightarrow 2.”, “2. \Rightarrow 3.”, and “5. \Rightarrow 1.” are straightforward. We prove “3. \Rightarrow 4.” and “4. \Rightarrow 5.”.

“3. \Rightarrow 4.” Take a model \mathfrak{A} of \mathcal{K} and $\ell \geq 0$ witnessing Condition 3. We may assume that ℓ exceeds the maximum guarded quantifier rank of formulas in \mathcal{K} . We show that Condition 4 holds for \mathfrak{A} and ℓ . Assume for a proof by contradiction that there exists $\vec{a}_0 \in P$ such that there exists a guarded Σ ℓ -embedding (e, H) from $\mathcal{D}_{\text{con}(\vec{a}_0)}, \vec{a}_0$ to $\mathfrak{A}, \vec{b}^{\mathfrak{A}}$. Assume $e : \mathcal{D}_{\text{con}(\vec{a}_0)} \mapsto \mathcal{D}'$ and that $e(\vec{a}_0) = \vec{a}'_0$. We construct a model \mathfrak{B} as follows: first take a copy \mathfrak{B}' of \mathfrak{A} . For the constants $c \in \text{cons}(\mathcal{D}) \setminus \text{cons}(\mathcal{D}_{\text{con}(\vec{a}_0)})$, we define $c^{\mathfrak{B}'}$ as the copy of $c^{\mathfrak{A}}$ in \mathfrak{B}' . The interpretation of the constants in $\mathcal{D}_{\text{con}(\vec{a}_0)}$ will be defined later. We define \mathfrak{B} as the disjoint union of \mathfrak{B}' and \mathfrak{B}'' , where \mathfrak{B}'' is defined next. We denote by H' the set obtained from H with $\vec{a}'_0 \mapsto \vec{b}^{\mathfrak{A}}$ removed if \vec{a}_0 is not guarded. Now let

$$\text{dom}(\mathfrak{B}'') = (H' \times \text{dom}(\mathfrak{A}))/\sim,$$

where \sim identifies all $(h, d), (h', d')$ such that $(h, d) = (h', d')$ or there exists $c \in \text{dom}(h) \cap \text{dom}(h')$ such that $h(c) = d$ and $h'(c) = d'$. Denote the equivalence class of (h, d) w.r.t. \sim by $[h, d]$. For any constant c in $\mathcal{D}_{\text{con}(\vec{a}_0)}$, we set $c^{\mathfrak{B}''} = [h, h(e(c))]$, where $h \in H'$ is such that $e(c) \in \text{dom}(h)$. Observe that this is well defined as $(h', h'(e(c))) \sim (h, h(e(c)))$ for any $h' \in H'$ with $e(c) \in \text{dom}(h')$. We define the interpretation $R^{\mathfrak{B}''}$ of the relation symbol R by setting for $e_1, \dots, e_n \in \text{dom}(\mathfrak{B}'')$, $\mathfrak{B}'' \models R(e_1, \dots, e_n)$ if there exists $h \in H'$ and $c_1, \dots, c_n \in \text{dom}(\mathfrak{A})$ such that $e_i = [h, c_i]$ and $\mathfrak{A} \models R(c_1, \dots, c_n)$. Then, the map

$$\begin{aligned} f_h : \text{dom}(\mathfrak{A}) &\rightarrow (H' \times \text{dom}(\mathfrak{A}))/\sim \\ c &\mapsto [h, c] \end{aligned}$$

is an embedding from \mathfrak{A} to \mathfrak{B}'' , by definition.

We show that $\mathfrak{B}, \vec{a}_0^{\mathfrak{B}} \sim_{GF, \Sigma}^\ell \mathfrak{A}, \vec{b}^{\mathfrak{A}}$. By construction and the assumption that ℓ exceeds the guarded quantifier rank of \mathcal{K} it also follows that \mathfrak{B} is a model of \mathcal{K} . It thus follows that we have derived a contradiction to the assumption that \mathfrak{A} and ℓ witness Condition 3.

To define a guarded Σ ℓ -bisimulation $\hat{H}_\ell, \dots, \hat{H}_0$, let S_i be the set of $p : \vec{c} \mapsto \vec{d}$ witnessing that $\mathfrak{A}, \vec{c} \sim_{\text{openGF}, \Sigma}^i \mathfrak{A}, \vec{d}$, where \vec{c} is guarded. Then include in \hat{H}_i

- all $\vec{c}' \mapsto \vec{c}$, where \vec{c}' is the copy in \mathfrak{B}' of the guarded tuple \vec{c} in \mathfrak{A} ;
- all compositions $p \circ (f_h^{-1})_{\parallel \vec{d}}$ for any guarded tuple \vec{d} in the range of f_h and $p \in S_i$;

In addition, include in $\vec{d}_0^{\mathfrak{B}} \mapsto \vec{b}^{\mathfrak{A}}$ in all \hat{H}_i , $0 \leq i \leq \ell$. We show that $\hat{H}_\ell, \dots, \hat{H}_0$ is a guarded Σ ℓ -bisimulation.

For any $i \leq \ell$ any $g \in \hat{H}_i$ is clearly a partial Σ -isomorphism, either trivially if $\text{dom}(g) \subseteq \mathfrak{B}'$ or by composition of partial Σ -isomorphisms if $\text{dom}(g) \subseteq \mathfrak{B}''$. By definition, \hat{H}_ℓ contains $\vec{d}_0^{\mathfrak{B}} \mapsto \vec{b}^{\mathfrak{A}}$. We thus only need to check the ‘‘Forth’’ and ‘‘Back’’ conditions for guarded ℓ -bisimulations. Let $g \in \hat{H}_k$ for some k with $1 \leq k \leq \ell$. By definition of \hat{H}_k , we have either $\text{dom}(g) \subseteq \mathfrak{B}'$ or $\text{dom}(g) \subseteq \mathfrak{B}''$. In each case, we show that for any guarded \vec{c} in \mathfrak{B} and guarded \vec{d} in \mathfrak{A} , there exists $g'_0 \in \hat{H}_{k-1}$ with domain $[\vec{c}]$ that coincides with g on $[\vec{c}] \cap \text{dom}(g)$ (Forth) and there exists $g'_1 \in \hat{H}_{k-1}$ such that $\text{dom}((g'_1)^{-1}) = [\vec{d}]$ and $(g'_1)^{-1}$ coincides with g^{-1} on $[\vec{d}] \cap \text{im}(g)$ (Back).

First assume that $[\vec{c}] \cap \text{dom}(g) = \emptyset$. Then, as \vec{c} is guarded in \mathfrak{B} , it is either included in \mathfrak{B}' or included in \mathfrak{B}'' . If \vec{c} is included in \mathfrak{B}' , then the partial isomorphism mapping \vec{c} to its copy in \mathfrak{A} is in \hat{H}_{k-1} , as required. If \vec{c} is in \mathfrak{B}'' , then \vec{c} can be written $([h, c_1], \dots, [h, c_n])$ for some $h \in H'$ and $c_1, \dots, c_n \in \text{dom}(\mathfrak{A})$ as it is guarded. But then $(f_h)^{-1}_{|[\vec{c}]} \in \hat{H}_{k-1}$ is as required.

The case $[\vec{d}] \cap \text{im}(g) = \emptyset$ is similar. Assume $\vec{d} = (d_1, \dots, d_n)$ and let $[h, \vec{d}] := ([h, d_1], \dots, [h, d_n]) \in \mathfrak{B}''$ for any $h \in H'$. Then $(f_h)^{-1}_{|[h, \vec{d}]} \in \hat{H}_{k-1}$ is as required, for any $h \in H'$. We now focus on proving (Forth) and (Back) assuming intersections are not empty.

(1) Suppose $\text{dom}(g) \subseteq \mathfrak{B}'$.

(Forth) Let \vec{c} be guarded in \mathfrak{B} such that $[\vec{c}] \cap \text{dom}(g) \neq \emptyset$. We show there exists $g' \in \hat{H}_{k-1}$ that coincides with g on $\text{dom}(g) \cap \text{dom}(g')$, such that $[\vec{c}] = \text{dom}(g')$. By construction of \mathfrak{B} , $[\vec{c}] \cap \text{dom}(g) \neq \emptyset$ and $\text{dom}(g) \subseteq \mathfrak{B}'$ imply $[\vec{c}] \subseteq \mathfrak{B}'$. By definition of \hat{H}_k , $\text{dom}(g)$ is the copy of $\text{im}(g)$ in \mathfrak{B}' . Therefore simply take g' to be the partial isomorphism $\vec{c} \mapsto \vec{d}$ such that \vec{c} is the copy in \mathfrak{B}' of \vec{d} ; it clearly coincides with g on the intersection of their domains, and is in \hat{H}_{k-1} which contains every ‘‘copying’’ function, by definition.

(Back) Let \vec{d} be guarded in \mathfrak{A} such that $[\vec{d}] \cap \text{im}(g) \neq \emptyset$. Take \vec{c} to be the copy in \mathfrak{B}' of \vec{d} . Then, the partial isomorphism $g' := \vec{c} \mapsto \vec{d}$ is in \hat{H}_{k-1} by definition, and is such that $(g')^{-1}$ coincides with g^{-1} on $\text{im}(g) \cap \text{im}(g')$.

(2) Suppose $\text{dom}(g) \subseteq \mathfrak{B}''$.

(Forth) Write $\text{dom}(g)$ as $([h_1, c_1], \dots, [h_n, c_n])$ with $h_1, \dots, h_n \in H'$ and $(c_1, \dots, c_n) =: \vec{c}$ a tuple in \mathfrak{A} . We want to prove that for any $([h'_1, c'_1], \dots, [h'_m, c'_m])$ guarded in \mathfrak{B} that intersects $\text{dom}(g)$ there exists $g' \in \hat{H}_{k-1}$ with domain $([h'_1, c'_1], \dots, [h'_m, c'_m])$ that coincides with g on $\text{dom}(g) \cap \text{dom}(g')$. As $([h'_1, c'_1], \dots, [h'_m, c'_m])$ is guarded in \mathfrak{B} and intersects $\text{dom}(g)$ which is in \mathfrak{B}'' , it also has to be contained in \mathfrak{B}'' , by construction of \mathfrak{B} . The fact it is guarded implies we can write it as $([h', c'_1], \dots, [h', c'_m])$ for some $h' \in H'$, with (c'_1, \dots, c'_m) being guarded in \mathfrak{A} , again by construction of \mathfrak{B} . As for $([h_1, c_1], \dots, [h_n, c_n])$, we can write it as $([h, c_1], \dots, [h, c_n])$ for some $h \in H'$, either because it is guarded or because it is equal to $\vec{d}^{\mathfrak{B}}$, i.e. $([h, h(a_1)], \dots, [h, h(a_n)])$ for some $h \in H'$. By definition of \hat{H}_k , we can write g as $p \circ (f_h^{-1})_{|\text{dom}(g)}$ for some $p \in S_k$, and we know g' has to be in the form $p' \circ (f_{h'}^{-1})_{|\text{dom}(g')}$ for some $p' \in S_{k-1}$. For notation purposes, we write $[h, \vec{c}] = ([h, c_1], \dots, [h, c_n])$ and $[h', \vec{c}'] = ([h', c'_1], \dots, [h', c'_m])$.

Case 1. $h = h'$. Then $[h, \vec{c}] \cap [h, \vec{c}'] \neq \emptyset$ implies $[\vec{c}] \cap [\vec{c}'] \neq \emptyset$. Then, since $p \in S_k$ and $\text{dom}(p) = [\vec{c}]$, by definition of guarded k -bisimulations there exists $p' \in S_{k-1}$ with domain $[\vec{c}']$ that coincides with p on $[\vec{c}] \cap [\vec{c}']$. Then $g' := p' \circ (f_h^{-1})_{|[h, \vec{c}']} \in \hat{H}_{k-1}$ is as required.

Case 2. $h \neq h'$. Figure B.6 illustrates the following construction. For all $[h, c_i] \in [[h, \vec{c}]] \cap [[h', \vec{c}']]$ we have that $c_i = h(d_i)$ and $c'_i = h'(d_i)$ for some $d_i \in \text{dom}(h) \cap \text{dom}(h')$. For any tuple \vec{d} in \mathcal{D} such that $[\vec{d}] = \text{dom}(h) \cap \text{dom}(h')$, we have $\mathfrak{A}, h'(\vec{d}) \sim_{\text{GF}, \Sigma}^{\ell} \mathfrak{A}, h(\vec{d})$, witnessed by some partial isomorphism $q : [h'(\vec{d})] \rightarrow [h(\vec{d})]$. Also, via p , we have $\mathfrak{A}, \vec{d}' \sim_{\text{GF}, \Sigma}^k \mathfrak{A}, p(\vec{d}')$ for any \vec{d}' such that $[\vec{d}'] = [h(\vec{d})] \cap [\vec{c}]$. By composition, for any \vec{d}'' such that $[\vec{d}'] = [h'(\vec{d})] \cap [\vec{c}']$ we have $\mathfrak{A}, \vec{d}'' \sim_{\text{GF}, \Sigma}^k \mathfrak{A}, p(q(\vec{d}''))$. Because $p \circ q$ is in S_k (by definition of S_k) and because $[\vec{c}']$ trivially intersects $[h'(\vec{d})] \cap [\vec{c}']$, there exists, by definition of guarded k -bisimulations, a partial isomorphism $p' \in S_{k-1}$ of domain $[\vec{c}']$ that coincides with $p \circ q$ on $[h'(\vec{d})] \cap [\vec{c}']$. Then, $g' := p' \circ (f_{h'}^{-1})_{|[h', \vec{c}']} \in \hat{H}_{k-1}$ is the desired partial isomorphism in \hat{H}_{k-1} .

(Back) The construction is illustrated in Figure B.7. Let \vec{d} be guarded in \mathfrak{A} such that $[\vec{d}] \cap \text{im}(g)$. We show there exists $g' \in \hat{H}_{k-1}$ with image $[\vec{d}']$ such that $(g')^{-1}$ coincides with g^{-1} on $[\vec{d}] \cap \text{im}(g)$. By definition of \hat{H}_k we can write $g = p \circ (f_h^{-1})_{|\text{dom}(g)}$ for some $h \in H'$ and $p \in S_k$, and we know g' has to be of the form $p' \circ (f_{h'}^{-1})_{|[h', \vec{d}']}$ for some $h' \in H'$. By definition of guarded k -bisimulations there exists $p' \in S_{k-1}$ such that $\text{im}(p') = [\vec{d}']$ and p'^{-1}

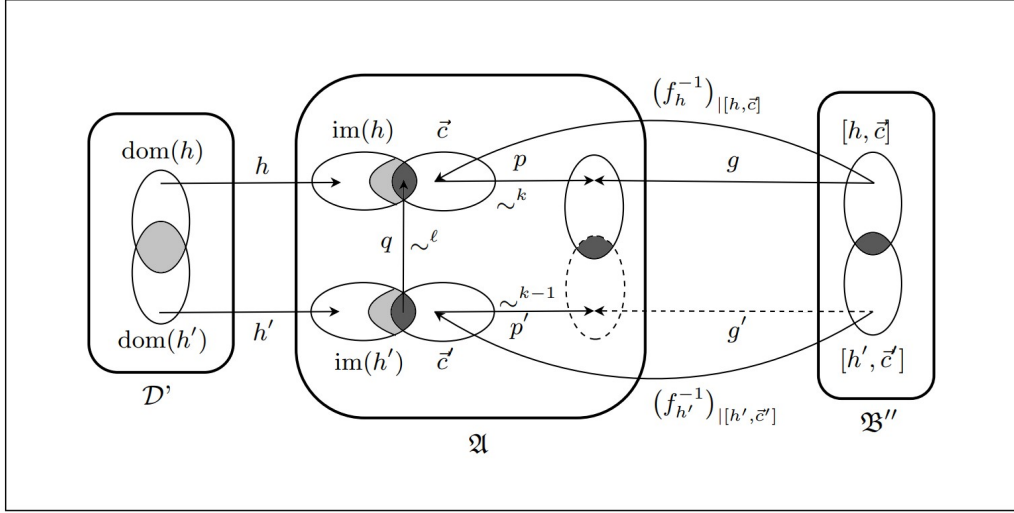

Figure B.6: Illustration of proof of (Forth) condition for $\hat{H}_\ell, \dots, \hat{H}_0$.

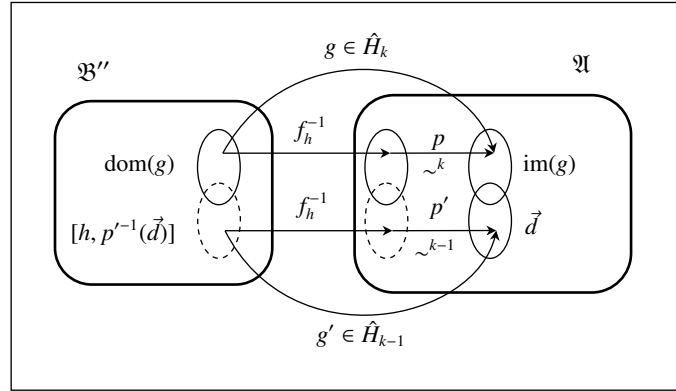

Figure B.7: Illustration of proof of (Back) condition for $\hat{H}_\ell, \dots, \hat{H}_0$.

coincides with p^{-1} on $\text{im}(p) \cap \text{im}(p')$. Given that $\text{im}(g) = \text{im}(p)$, if we write $\vec{d} = (d_1, \dots, d_n)$ and $[h, p'^{-1}(\vec{d})] := ([h, p'^{-1}(d_1)], \dots, [h, p'^{-1}(d_n)]) \in \mathfrak{B}''$, then $g' = p' \circ (f_h^{-1})_{|[h, p'^{-1}(\vec{d})]} \in \hat{H}_{k-1}$ is as required.

“4. \Rightarrow 5.” For an indirect proof, suppose $I_{2\ell}, \dots, I_0$ is a guarded Σ 2ℓ -bisimulation between $\mathfrak{B}, \vec{a}^{\mathfrak{B}}$ and $\mathfrak{A}, \vec{b}^{\mathfrak{A}}$ for a model \mathfrak{B} of \mathcal{K} , where $\ell \geq |\mathcal{D}|$. We may assume that $I_{i+1} \subseteq I_i$ for $i < 2\ell$. Let \mathcal{D}' be the restriction of \mathfrak{B} to $\{c^{\mathfrak{B}} \mid c \in \text{cons}(\mathcal{D}_{\text{con}(\vec{a})})\}$, where we regard the elements $c^{\mathfrak{B}}$ as constants. Define $e : \mathcal{D}_{\text{con}(\vec{a})} \rightarrow \mathcal{D}'$ by setting $e(c) = c^{\mathfrak{B}}$. Let H contain $h_0 : \vec{a}^{\mathfrak{B}} \mapsto \vec{b}^{\mathfrak{A}}$ and, for every guarded tuple \vec{d} in \mathcal{D}' any $h : \vec{d} \mapsto \vec{c} \in I_\ell$. It is easy to show that (e, H) is a guarded Σ ℓ -embedding: assume that $h_i : \vec{c}_i \mapsto \vec{d}_i \in H$ for $i = 1, 2$. Let X_1, X_2 be the images of $[\vec{c}_1] \cap [\vec{c}_2]$ under h_i and \vec{d} such that $[\vec{d}] = X_1$. Then we have $h_i : \vec{c}_i \mapsto \vec{d}_i \in I_\ell$, for $i = 1, 2$. Let p be the restriction of $h_2 \circ h_1^{-1}$ to X_1 . By definition p is a partial isomorphism from X_1 to X_2 . It is as required as

$$\mathfrak{A}, \vec{d} \sim_{\text{openGF}, \Sigma}^{\ell} \mathfrak{B}, h_1^{-1}(\vec{d}) \sim_{\text{openGF}, \Sigma}^{\ell} \mathfrak{A}, h_2(h_1^{-1}(\vec{d})).$$

□

We finally observe the following link between bounded guarded embeddings and homomorphisms.

Lemma 70. *Let \mathcal{D}, \vec{a} be a pointed database, \mathfrak{A}, \vec{b} be a pointed structure, and $\ell \geq |\mathcal{D}|$. If $\mathcal{D}_{\text{con}(\vec{a})}, \vec{a} \leq_{\text{openGF}, \Sigma}^{\ell} \mathfrak{A}, \vec{b}$ and $\mathcal{D}_{\text{con}(\vec{a})}, \vec{a} \dashv \mathfrak{A}, \vec{b}$, then there exist d, d' with $d \neq d'$ in $\mathfrak{A}_b^{\leq |\mathcal{D}|}$ such that $\mathfrak{A}, d \sim_{\text{openGF}, \Sigma}^{\ell - |\mathcal{D}|} \mathfrak{A}, d'$.*

Proof. Let e, H_ℓ, \dots, H_0 witness $\mathcal{D}_{\text{con}(\vec{a})}, \vec{a} \leq_{\text{openGF}, \Sigma}^{\ell} \mathfrak{A}, \vec{b}$ as in Lemma 68. We define a sequence of mappings S_0, \dots, S_ℓ with $S_k \subseteq H_{\ell-k}$ for $k \leq \ell$ as follows. Define $S_0 = \{e(\vec{a}) \mapsto \vec{b}\}$ and assume that S_k has been defined for some $k < \ell$. To define S_{k+1} , choose for every $h \in S_k$ and all guarded \vec{c} intersecting $\text{dom}(h)$ an $h' \in H_{\ell-k-1}$ with domain $[\vec{c}]$ that coincides with h on $[\vec{c}] \cap \text{dom}(h)$ (this is possible by Condition 1 of Lemma 68) and add it to S_{k+1} . Define $\bar{h} = \bigcup (\bigcup_{k \leq |\mathcal{D}|} S_k)$. We can see \bar{h} as a set of pairs from

$$\text{dom}(\mathcal{D}'_{\text{con}(e(\vec{a}))}) \times \text{dom}(\mathfrak{A}),$$

which may or may not be functional. We know h is not a homomorphism from $\mathcal{D}'_{\text{con}(e(\vec{a}))}, e(\vec{a})$ to $\mathfrak{A}, \vec{b}^{\mathfrak{A}}$ because otherwise $h \circ e$ would witness $\mathcal{D}_{\text{con}(\vec{a})}, \vec{a} \rightarrow \mathfrak{A}, \vec{b}^{\mathfrak{A}}$. However,

- * $\mathcal{D}' \models R(c_1, \dots, c_n)$ implies $\mathfrak{A} \models R(d_1, \dots, d_n)$ for every $(c_1, d_1), \dots, (c_n, d_n) \in \bar{h}$ and every n -ary $R \in \Sigma$, since \bar{h} is a union of partial homomorphisms.
- * for every $c \in \mathcal{D}'_{\text{con}(e(\vec{a}))}$ there exists $h \in \bigcup_{k \leq \text{dist}_{\mathcal{D}'}(c, e(\vec{a}))} S_k$ such that $c \in \text{dom}(h)$, so \bar{h} is defined on the entire underlying set of $\mathcal{D}'_{\text{con}(e(\vec{a}))}$, as $\text{dist}_{\mathcal{D}'}(c, e(\vec{a})) \leq |\mathcal{D}'|$ trivially and $|\mathcal{D}'| \leq |\mathcal{D}|$ as e is surjective.
- * $e(\vec{a}) \mapsto \vec{b}$ is included in \bar{h} .

Therefore the only possible reason as to why \bar{h} is not a homomorphism witnessing $\mathcal{D}_{\text{con}(\vec{a})}, \vec{a} \rightarrow \mathfrak{A}, \vec{b}$ is that \bar{h} is not functional, i.e. there exist $c \in \text{dom}(\mathcal{D}'_{\text{con}(e(\vec{a}))})$ and $d, d' \in \text{dom}(\mathfrak{A})$ such that $d \neq d'$ and $(c, d), (c, d') \in \bar{h}$. As every h included in \bar{h} is functional, that implies there exist $h, h' \in \bigcup_{k \leq |\mathcal{D}|} S_k$ such that $h(c) = d$ and $h'(c) = d'$. There exist $k_1, k_2 \geq \ell - |\mathcal{D}|$ such that $h \in H_{k_1}$ and $h' \in H_{k_2}$. By condition (2) of Lemma 68 we get $\mathfrak{A}, d \sim_{\text{openGF}, \Sigma}^{\min(k_1, k_2)} \mathfrak{A}, d'$, hence $\mathfrak{A}, d \sim_{\text{openGF}, \Sigma}^{\ell - |\mathcal{D}|} \mathfrak{A}, d'$. Finally, $d, d' \in \mathfrak{A}_b^{\leq |\mathcal{D}|}$ follows from the fact that $\text{dist}_{\mathfrak{A}}(h(c), \vec{b}) \leq k$ for any $c \in \text{dom}(h)$ such that $h \in S_k$. This can be proved by induction on k . \square

We are in a position now to prove the equivalence of Points 1 to 4 and Point 5 of Theorem 37. In fact, the equivalence follows from the following lemma since Point 1 of Lemma 71 is equivalent to Point 1 of Theorem 37 (by Lemma 69) and Point 2 of Lemma 71 coincides with Point 5 of Theorem 37.

Lemma 71. *Assume that $(\mathcal{K}, P, \{\vec{b}\})$ is a labeled GF-KB with $\mathcal{K} = (\mathcal{O}, \mathcal{D})$, $\Sigma = \text{sig}(\mathcal{K})$, and $\vec{b} = (b_1, \dots, b_n)$. Then the following conditions are equivalent:*

1. *there exists a model \mathfrak{A} of \mathcal{K} and $\ell \geq 0$ such for all $\vec{a} \in P$: $\mathcal{D}_{\text{con}(\vec{a})}, \vec{a} \not\leq_{\text{openGF}, \Sigma}^{\ell} \mathfrak{A}, \vec{b}^{\mathfrak{A}}$;*
2. *there exists a model \mathfrak{A} of \mathcal{K} such that for all $\vec{a} \in P$:*
 - (a) $\mathcal{D}_{\text{con}(\vec{a})}, \vec{a} \dashv \mathfrak{A}, \vec{b}^{\mathfrak{A}}$ and
 - (b) *if the set I of all i such that $\text{tp}_{\mathcal{K}}(\mathfrak{A}, b_i^{\mathfrak{A}})$ is connected and openGF-complete is not empty, then*
 - i. $J = \{1, \dots, n\} \setminus I \neq \emptyset$ and $\mathcal{D}_{\text{con}(\vec{a}_J)}, \vec{a}_J \dashv \mathfrak{A}, \vec{b}_J^{\mathfrak{A}}$ or
 - ii. $\text{tp}_{\mathcal{K}}(\mathfrak{A}, \vec{b}^{\mathfrak{A}})$ is not realizable in \mathcal{K}, \vec{a} .

Proof. “1. \Rightarrow 2.” Assume that Point 1 holds for \mathfrak{A} and $\ell_0 \geq 0$. Assume $\vec{a} \in P$ is given. As $\mathcal{D}_{\text{con}(\vec{a})}, \vec{a} \rightarrow \mathfrak{A}, \vec{b}^{\mathfrak{A}}$ implies $\mathcal{D}_{\text{con}(\vec{a})}, \vec{a} \leq_{\text{openGF}, \Sigma}^{\ell} \mathfrak{A}, \vec{b}^{\mathfrak{A}}$ for all $\ell \geq 0$, we obtain that (a) holds. To show that (b) holds for \mathfrak{A} and \vec{a} , assume that I as defined in the lemma is not empty and that $\text{tp}_{\mathcal{K}}(\mathfrak{A}, \vec{b}_I^{\mathfrak{A}})$ is realizable in \mathcal{K}, \vec{a} . Take a model \mathfrak{B} witnessing this. Consider the maximal sets $I_1, \dots, I_k \subseteq \{1, \dots, n\}$ such that $\vec{b}_{I_j}^{\mathfrak{B}}$ is in a connected component \mathfrak{B}_j of \mathfrak{B} . Then there exists at least one j such that $\text{tp}_{\mathcal{K}}(\mathfrak{A}, \vec{b}_{I_j}^{\mathfrak{A}})$ is not openGF-complete: otherwise $\mathfrak{B}, \vec{a}_{I_j}^{\mathfrak{B}} \sim_{\text{openGF}, \Sigma} \mathfrak{A}, \vec{b}_{I_j}^{\mathfrak{A}}$ for all j and so $\mathcal{D}_{\text{con}(\vec{a}_{I_j})}, \vec{a}_{I_j} \leq_{\text{openGF}, \Sigma}^{\ell} \mathfrak{A}, \vec{b}_{I_j}^{\mathfrak{A}}$ for all $\ell \geq 0$, thus $\mathcal{D}_{\text{con}(\vec{a})}, \vec{a} \leq_{\text{openGF}, \Sigma}^{\ell} \mathfrak{A}, \vec{b}^{\mathfrak{A}}$, for all $\ell \geq 0$, a contradiction.

For any j such that $\text{tp}_{\mathcal{K}}(\mathfrak{A}, \vec{b}_j^{\mathfrak{A}})$ is not openGF-complete we have by Lemma 67 that $\text{tp}_{\mathcal{K}}(\mathfrak{A}, \vec{b}_j^{\mathfrak{A}})$ is not openGF-complete for some $i \in I_j$. Therefore $J \neq \emptyset$. Assume now for a proof by contradiction that $\mathcal{D}_{\text{con}(\vec{a}_J)}, \vec{a}_J \rightarrow \mathfrak{A}, \vec{b}_J^{\mathfrak{A}}$. Then $\mathcal{D}_{\text{con}(\vec{a}_J)}, \vec{a}_J \leq_{\text{openGF}, \Sigma}^{\ell} \mathfrak{A}, \vec{b}_J^{\mathfrak{A}}$, for any $\ell \geq 0$. By Lemma 67, $\text{tp}_{\mathcal{K}}(\mathfrak{A}, \vec{b}_J^{\mathfrak{A}})$ is openGF-complete and so $\mathfrak{B}, \vec{a}_J^{\mathfrak{B}} \sim_{\text{openGF}, \Sigma} \mathfrak{A}, \vec{b}_J^{\mathfrak{A}}$, and therefore $\mathcal{D}_{\text{con}(\vec{a}_I)}, \vec{a}_I \leq_{\text{openGF}, \Sigma}^{\ell} \mathfrak{A}, \vec{b}_I^{\mathfrak{A}}$, for every $\ell \geq 0$. As $\mathcal{D}_{\text{con}(\vec{a}_I)}$ and $\mathcal{D}_{\text{con}(\vec{a}_J)}$ must be disjoint, it follows that $\mathcal{D}_{\text{con}(\vec{a})}, \vec{a} \leq_{\text{openGF}, \Sigma}^{\ell} \mathfrak{A}, \vec{b}^{\mathfrak{A}}$ for any $\ell \geq 0$, and we have derived a contradiction.

“2. \Rightarrow 1.” Assume Conditions (a) and (b) hold for some model \mathfrak{A} of \mathcal{K} for all $\vec{a} \in P$. As GF is finitely controllable there exists a finite such model \mathfrak{A} . Assume that the set I defined in the lemma is empty. The case $I \neq \emptyset$ is considered in exactly the same way and therefore omitted. Our aim is to show that $\mathcal{D}_{\text{con}(\vec{a})}, \vec{a} \not\leq_{\text{openGF}, \Sigma}^{\ell} \mathfrak{C}, \vec{b}^{\mathfrak{A}}$ for a variant \mathfrak{C} of \mathfrak{A} and for sufficiently large ℓ , where $\Sigma = \text{sig}(\mathcal{K})$.

Let X be the set of $i \leq n$ such that $\Phi_i(x) = \text{tp}_{\mathcal{K}}(\mathfrak{A}, b_i^{\mathfrak{A}})$ is disconnected. If $X = \{1, \dots, n\}$, then $\neg \bigwedge_{i \in X} \Phi_i(x_i)$ separates $(\mathcal{K}, P, \vec{b})$ and we are done. Otherwise, let $\mathfrak{A}_i, i \in X$, be the maximal connected components of \mathfrak{A} containing the singleton $b_i^{\mathfrak{A}}$. Since $\text{tp}_{\mathcal{K}}(\mathfrak{A}, b_i^{\mathfrak{A}})$ is disconnected we have $\text{dom}(\mathfrak{A}_i) = \{b_i^{\mathfrak{A}}\}$, for all $i \in X$. We partition the remaining part of \mathfrak{A} without $\mathfrak{A}_i, i \in X$, into components as follows. Define a binary relation E on the class of \mathcal{K} -types $\Phi(x)$ with one free variable x such that $(\Phi(x), \Psi(x)) \in E$ iff there exists a model \mathfrak{A} of \mathcal{K} and nodes a, b in $\text{dom}(\mathfrak{A})$ such that a, b are in the same connected component in \mathfrak{A} and a and b realize Φ and Ψ , respectively. It is easy to see that E is an equivalence relation. Let \mathfrak{A}' and $\{\mathfrak{C} \mid \mathfrak{C} \in K\}$ be the maximal components of \mathfrak{A} without $\{b_i^{\mathfrak{A}} \mid i \in X\}$ such that:

- all nodes in any \mathfrak{C} are connected to a node in $\{c^{\mathfrak{A}} \mid c \in \text{cons}(\mathcal{D})\}$ and all \mathcal{K} -types $\Phi(x)$ realized in \mathfrak{C} are E -equivalent;
- no node in \mathfrak{A}' is connected to a node in $\{c^{\mathfrak{A}} \mid c \in \text{cons}(\mathcal{D})\}$.

Observe that \mathfrak{A} is the disjoint union of $\mathfrak{A}_i, i \in X, \mathfrak{A}'$, and the structures in K . Let $\mathfrak{C} \in K$ and let \mathcal{D}' be the restriction of \mathcal{D} to the constants $c \in \text{cons}(\mathcal{D})$ such that $c^{\mathfrak{C}} \in \text{dom}(\mathfrak{C})$. Let I_0 be the set of i with $b_i^{\mathfrak{A}} \in \text{dom}(\mathfrak{C})$. We aim to construct a model \mathfrak{C} of $(\mathcal{O}, \mathcal{D}')$ such that

(*) if $\mathcal{D}_{\text{con}(\vec{a}_{I_0})}, \vec{a}_{I_0} \not\rightarrow \mathfrak{A}, \vec{b}_{I_0}^{\mathfrak{A}}$, then there exists $\ell \geq 0$ such that $\mathcal{D}_{\text{con}(\vec{a}_{I_0})}, \vec{a}_{I_0} \not\leq_{\text{openGF}, \Sigma}^{\ell} \mathfrak{C}, \vec{b}_{I_0}^{\mathfrak{A}}$.

For any model \mathfrak{C} of \mathcal{D}' and $d \in \text{dom}(\mathfrak{C})$ we let the distance $\text{dist}_{\mathfrak{C}}(\mathcal{D}', d) = \ell$ iff ℓ is minimal such $\text{dist}(c^{\mathfrak{C}}, d) \leq \ell$ for at least one $c \in \text{cons}(\mathcal{D}')$. We denote by $\mathfrak{C}_{\mathcal{D}'}^{\leq \ell}$ the substructure of \mathfrak{C} induced by the set of nodes d in \mathfrak{C} with $\text{dist}_{\mathfrak{C}}(\mathcal{D}', d) \leq \ell$. We construct for any $\ell \geq 0$ a model \mathfrak{C} of \mathcal{O} that coincides with \mathfrak{C} on $\{c^{\mathfrak{C}} \mid c \in \text{cons}(\mathcal{D}')\}$ such that $\mathfrak{C}_{\mathcal{D}'}^{\leq \ell}$ is finite and there exists $\ell' \geq \ell$ with

- (a) $\mathfrak{C}_{\mathcal{D}'}^{\leq \ell}, \vec{b}_{I_0}^{\mathfrak{A}} \rightarrow \mathfrak{A}, \vec{b}_{I_0}^{\mathfrak{A}}$;
- (b) for any two distinct $d_1, d_2 \in \text{dom}(\mathfrak{C}_{\mathcal{D}'}^{\leq \ell}), \mathfrak{C}, d_1 \approx_{\text{openGF}, \Sigma}^{\ell'} \mathfrak{C}, d_2$.

We first show that (*) follows. Assume ℓ' is such that (b) holds. Let $\ell'' = \ell' + |\mathcal{D}|$ and $\ell \geq |\mathcal{D}|$. Assume that $\mathcal{D}_{\text{con}(\vec{a}_{I_0})}, \vec{a}_{I_0} \leq_{\text{openGF}, \Sigma}^{\ell''} \mathfrak{C}, \vec{b}_{I_0}^{\mathfrak{A}}$ but $\mathcal{D}_{\text{con}(\vec{a}_{I_0})}, \vec{a}_{I_0} \not\rightarrow \mathfrak{A}, \vec{b}_{I_0}^{\mathfrak{A}}$. By Condition (a),

$$\mathcal{D}_{\text{con}(\vec{a}_{I_0})}, \vec{a}_{I_0} \not\rightarrow \mathfrak{C}_{\mathcal{D}'}^{\leq \ell''}, \vec{b}_{I_0}^{\mathfrak{A}}$$

By Lemma 70, there exist d, d' with $d \neq d'$ in $\mathfrak{C}_{\mathcal{D}'}^{\leq \ell''}$ such that $\mathfrak{C}, d \sim_{\text{openGF}, \Sigma}^{\ell'} \mathfrak{C}, d'$ and we have derived a contradiction to Condition (b).

We come to the construction of \mathfrak{C} . It is helpful to consider in parallel the simpler construction of \mathfrak{C} in the proof of Theorem 24. Note that the tasks are almost the same as Condition (a) corresponds to Condition (i) in Theorem 24 and Condition (b) is a bounded version of Condition (ii) in Theorem 24. Assume $\ell \geq 0$ is given. To construct \mathfrak{C} , let $T_{\mathfrak{C}}$ be the set of \mathcal{K} -types $\Phi(x)$ that are E -equivalent to some \mathcal{K} -type realized in \mathfrak{C} with $\mathfrak{C} \in K$. Observe that $T_{\mathfrak{C}}$ is an equivalence class for the relation E , by construction of \mathfrak{C} . No \mathcal{K} -type in $T_{\mathfrak{C}}$ is openGF-complete and, by construction, we find a sequence

$$\sigma = \Phi_0^{\sigma}, \Phi_1^{\sigma}, \Phi_2^{\sigma}$$

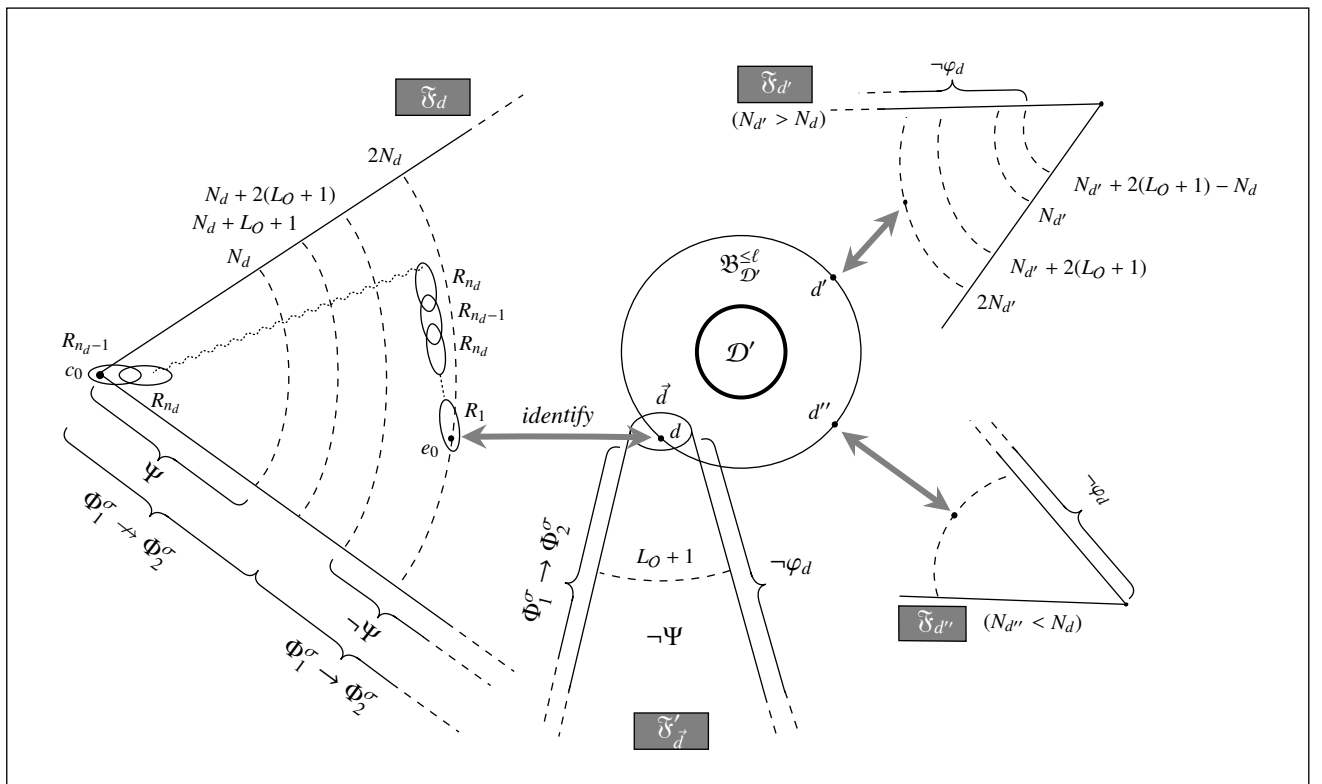

Figure B.8: Construction of \mathbb{C} .

such that for any \mathcal{K} -type $\Phi(x) \in T_{\mathfrak{C}}$ we find a sequence witnessing openGF-incompleteness of $\Phi(x)$ that ends with σ . As a first step of the construction of \mathfrak{C} , we define a model \mathfrak{B} of \mathcal{K} by repeatedly forming the partial unfolding of \mathfrak{C} so that

(path) from any $f_0 \in \mathfrak{B}_{\mathcal{D}}^{\leq \ell}$ there exists a strict path $R_1^{f_0}(\vec{d}_1), \dots, R_k^{f_0}(\vec{d}_k)$ from f_0 to some f_1 such that $\text{dist}_{\mathfrak{B}}(\mathcal{D}', f_1) = \ell$.

For the inductive construction of \mathfrak{B} , let $\mathfrak{B}_0 = \mathfrak{A}$ and include all $d \in \text{dom}(\mathfrak{A}_{\mathcal{D}}^{\leq \ell})$ into the frontier F_0 . Assume \mathfrak{B}_i and frontier F_i have been constructed. If F_i is empty, we are done and set $\mathfrak{B} = \mathfrak{B}_i$. Otherwise take $d \in F_i$ and let $d' \neq d$ be any element contained in a joint guarded set with d in \mathfrak{B}_i . Assume $k = \text{dist}_{\mathfrak{B}_i}(\mathcal{D}', d)$. Then let \mathfrak{B}_{i+1} be the partial unfolding $(\mathfrak{B}_i)_{\vec{d}}$ of \mathfrak{B}_i for the tuple $\vec{d} = (d, d', d, d', \dots)$ of length $\ell - k$, and obtain F_{i+1} by removing d from F_i and adding all new nodes in $\text{dom}((\mathfrak{B}_{i+1})_{\mathcal{D}}^{\leq \ell})$. Clearly this construction terminates after finitely many steps and (path) holds, see Lemma 65.

Let L denote the set of all d in \mathfrak{B} with $\text{dist}_{\mathfrak{B}}(\mathcal{D}', d) = \ell$ and let L' denote the set of all \vec{d} of arity ≥ 2 in \mathfrak{B} such that there exist R with $\mathfrak{B} \models R(\vec{d})$ and $d \in [\vec{d}]$ with $\text{dist}_{\mathfrak{B}}(\mathcal{D}', d) = \ell$. We obtain \mathfrak{C} by keeping $\mathfrak{B}_{\mathcal{D}}^{\leq \ell}$ and the guarded sets that intersect with it and attaching to every $d \in L$ and $\vec{d} \in L'$ guarded tree decomposable \mathfrak{F}_d and $\mathfrak{F}'_{\vec{d}}$ such that in the resulting model no d in L is guarded Σ ℓ' -bisimilar to any other d' in $\mathfrak{B}_{\mathcal{D}}^{\leq \ell}$ for a sufficiently large ℓ' . It then directly follows that \mathfrak{C} satisfies Conditions (a) and (b).

The construction of $\mathfrak{F}'_{\vec{d}}$ is straightforward. Fix $\vec{d} \in L'$. Let $\Phi'_0 := \text{tp}_{\mathcal{K}}(\mathfrak{B}, \vec{d})$. Then $\mathfrak{F}'_{\vec{d}}$ is defined as the tree decomposable model \mathfrak{A}'_r of \mathcal{O} with tree decomposition (T', E', bag') and root r such that $\mathfrak{A}'_r \models \Phi'_0(\vec{d})$ and $\text{bag}(r) = [\vec{d}]$ and for every \mathcal{K} -type $\Psi_1(\vec{x}_1)$ realized by some \vec{c} with $[\vec{c}] = \text{bag}(t)$ and \mathcal{K} -type $\Psi_2(\vec{x}_2)$ coherent with $\Psi_1(\vec{x}_1)$ there exists a successor t' of t in T such that $\Psi_1(\vec{x}_1) \cup \Psi_2(\vec{x}_2)$ is realized in $\text{bag}(t) \cup \text{bag}(t')$ under an assignment μ of the variables $[\vec{x}_1] \cup [\vec{x}_2]$ such that $\mu(\vec{x}_1) = \vec{c}_1$. The only property of $\mathfrak{F}'_{\vec{d}}$ we need is that

$$\mathfrak{F}'_{\vec{d}} \models \forall \vec{x}_1 (\Phi_1^\sigma \rightarrow \exists \vec{x} \Phi_2^\sigma)$$

where here and in what follows \vec{x}_1 are the variables in Φ_1^σ and \vec{x} are the variables in Φ_2^σ that are not in Φ_1^σ .

The construction of \mathfrak{F}_d is more involved, but follows closely the construction of \mathfrak{F}_d in the proof of Theorem 24. Let $L_O = 2^{2^{|\mathcal{O}|}} + 1$ and take for any $d \in L$ a number

$$N_d > |\mathfrak{B}_{\mathcal{D}}^{\leq \ell+1}| + 2(L_O + 1)$$

such that $|N_d - N_{d'}| > 2(L_O + 1)$ for $d \neq d'$. Fix $d \in L$ and let $\Phi_0(x) = \text{tp}_{\mathcal{K}}(\mathfrak{A}, d)$. Then $\Phi_0(x) \in T_{\mathfrak{C}}$ and we find a sequence $\Phi_0(\vec{x}_0), \dots, \Phi_{n_d}(\vec{x}_{n_d}), \Phi_{n_d+1}(\vec{x}_{n_d+1})$ that witnesses openGF incompleteness of $\Phi_0(x)$ and ends with $\Phi_0^\sigma \Phi_1^\sigma \Phi_2^\sigma$. By Lemma 64 we may assume that $1 \leq n_d \leq L_O + 1$. Let

$$\Psi(x) = \exists \Sigma^{L_O+1} . (\Phi_1^\sigma \wedge \neg \exists \vec{x} \Phi_2^\sigma),$$

where $\exists \Sigma^k \chi$ stands for the disjunction of all openGF formulas stating that there exists a path from x along relations in Σ of length at most k to a tuple where χ holds. To construct \mathfrak{F}_d consider the guarded tree decomposable model \mathfrak{A}_r of \mathcal{O} with guarded tree decomposition (T, E, bag) and root r such that $\mathfrak{A}_r \models \Phi_0(c_0)$ for some constant c_0 with $\text{bag}(r) = \{c_0\}$ and for every \mathcal{K} -type $\Psi_1(\vec{x}_1)$ realized by some \vec{c} with $[\vec{c}] = \text{bag}(t)$ and \mathcal{K} type $\Psi_2(\vec{x}_2)$ coherent with $\Psi_1(\vec{x}_1)$ there exists a successor t' of t in T such that $\Psi_1(\vec{x}_1) \cup \Psi_2(\vec{x}_2)$ is realized in $\text{bag}(t) \cup \text{bag}(t')$ under an assignment μ of the variables $[\vec{x}_1] \cup [\vec{x}_2]$ such that $\mu(\vec{x}_1) = \vec{c}_1$, except if $\Psi_1 \wedge \neg \exists \vec{x} \Psi_2$ (with \vec{x} the sequence of variables in \vec{x}_2 which are not in \vec{x}_1) is equivalent to $\Phi_1^\sigma \wedge \neg \exists \vec{x} \Phi_2^\sigma$ and $\text{dist}_{\mathfrak{A}_r}(\text{bag}(t), \text{bag}(r)) \leq N_d + L_O + 1$. Observe that

- $\mathfrak{A}_r \models \Psi(e)$ for all e with $\text{dist}_{\mathfrak{A}_r}(c_0, e) \leq N_d$;
- $\mathfrak{A}_r \models \neg \Psi(e)$ for all e with $\text{dist}_{\mathfrak{A}_r}(c_0, e) > N_d + 2(L_O + 1)$.

Moreover, \mathfrak{A}_r contains a strict path

$$R_1(\vec{e}_1), \dots, R_{n_d}(\vec{e}_{n_d}), \dots, R_{n_d}(\vec{e}_{n_d+2N_d})$$

from $e_0 \in [\vec{e}_1]$ to $c_0 \in [\vec{e}_{n_d+2N_d}]$ such that $\Phi_0(x)$ is realized in e_0 . Then \mathfrak{F}_d is obtained from \mathfrak{A}_r by renaming e_0 to d . Finally \mathfrak{C} is obtained by hooking \mathfrak{F}_d at d to $\mathfrak{B}_{\mathcal{D}}^{\leq \ell}$ for all $d \in L$. \mathfrak{C} is a model of \mathcal{K} since $\Phi_0(x)$ is realized in e_0 and d . Moreover, it clearly satisfies Condition (a). For Condition (b) assume $d \in L$ is as above. Let

$$\varphi_d(x) = \forall \Sigma^{N_d}. \Psi$$

where $\forall \Sigma^k. \chi$ stands for $\neg \exists \Sigma^k. \neg \chi$. Then $\mathfrak{C} \models \varphi_d(c_0)$ and by construction no node that is not in $\text{dom}(\mathfrak{F}_d)$ satisfies φ_d . Condition (b) now follows from the fact that there exists a path from d to a node satisfying φ_d that is shorter than any such path in \mathfrak{C} from any other node in $\mathfrak{B}_{\mathcal{D}}^{\leq \ell}$ to a node satisfying φ_d .

We have proved (*). We now aim to extend (*) and show that $\mathcal{D}_{\text{con}(\vec{a})}, \vec{a} \not\stackrel{\ell}{\prec}_{\text{openGF}, \Sigma} \mathfrak{C}, \vec{b}^{\mathfrak{A}}$, for appropriately defined \mathfrak{C} , all $\vec{a} \in P$, and for sufficiently large ℓ . Let $\vec{a} \in P$ be fixed. If $\mathcal{D}_{\text{con}(\vec{a}_{I_0}), \vec{a}_{I_0}} \rightarrow \mathfrak{A}, \vec{b}_{I_0}^{\mathfrak{A}}$ for some I_0 associated to some $\mathfrak{C} \in K$, then, by (*), $\mathcal{D}_{\text{con}(\vec{a}_{I_0}), \vec{a}_{I_0}} \not\stackrel{\ell}{\prec}_{\text{openGF}, \Sigma} \mathfrak{C}, \vec{b}_{I_0}^{\mathfrak{C}}$, for some ℓ , and therefore $\mathcal{D}_{\text{con}(\vec{a}), \vec{a}} \not\stackrel{\ell}{\prec}_{\text{openGF}, \Sigma} \mathfrak{C}, \vec{b}^{\mathfrak{A}}$, for some ℓ , and we are done. Now assume that $\mathcal{D}_{\text{con}(\vec{a}_{I_0}), \vec{a}_{I_0}} \rightarrow \mathfrak{A}, \vec{b}_{I_0}^{\mathfrak{A}}$ for all I_0 associated with any $\mathfrak{C} \in K$. We know that $\mathcal{D}_{\text{con}(\vec{a}), \vec{a}} \rightarrow \mathfrak{A}, \vec{b}^{\mathfrak{A}}$. But then either (i) $\mathcal{D}_{\text{con}(a_i), a_i} \not\stackrel{\ell}{\prec}_{\text{openGF}, \Sigma} \mathfrak{C}, b_i^{\mathfrak{C}}$ for some $i \in X$ (and we are done) or (ii) some a_i, a_j with $i \neq j$ and $i, j \in X$ are connected in \mathcal{D} , or (iii) some $a_i, i \in X$ and $a \in [\vec{a}_{I_0}]$ with I_0 linked to some $\mathfrak{C} \in K$ are connected in \mathcal{D} or (iv) some $a \in [\vec{a}_{I_0}]$ and $a' \in [\vec{a}_{I'_0}]$ with I_0 and I'_0 linked to distinct $\mathfrak{C} \in K$ are connected in \mathcal{D} . In all these cases it follows that $\mathcal{D}_{\text{con}(\vec{a}), \vec{a}} \not\stackrel{\ell}{\prec}_{\text{openGF}, \Sigma} \mathfrak{C}, \vec{b}^{\mathfrak{A}}$, for sufficiently large ℓ . \square

Appendix C. Proofs for Section 8

Theorem 60. (\mathcal{ALCI}, FO)-separability is undecidable, under the UNA.

Proof. The proof is by reduction from the infinite tiling problem. Recall the definition of a tiling system (T, H, V) and a solution to (T, H, V) from the proof of Theorem 39. Given a tiling system (T, H, V) , we construct a labeled \mathcal{ALCI} -KB $(\mathcal{K}, P, \{b\})$ with $\mathcal{K} = (\mathcal{O}, \mathcal{D})$ as follows:

$$\mathcal{O} = \{B \sqsubseteq \exists U. P_0, \tag{C.1}$$

$$P_0 \sqsubseteq \exists U^-. \top \sqcap \exists R_h. P_1 \sqcap \exists R_v. P_2, \tag{C.2}$$

$$P_1 \sqsubseteq \exists U^-. \top \sqcap \exists R_h. P_0 \sqcap \exists R_v. P_3, \tag{C.3}$$

$$P_2 \sqsubseteq \exists U^-. \top \sqcap \exists R_h. P_3 \sqcap \exists R_v. P_0, \tag{C.4}$$

$$P_3 \sqsubseteq \exists U^-. \top \sqcap \exists R_h. P_2 \sqcap \exists R_v. P_1, \tag{C.5}$$

$$P_i \sqcap P_j \sqsubseteq \perp, \tag{C.6}$$

$$\text{for } 0 \leq i < j \leq 3$$

$$B \sqcap P_i \sqsubseteq \perp, \tag{C.7}$$

$$\text{for } 0 \leq i \leq 3$$

$$P_0 \sqcup P_1 \sqcup P_2 \sqcup P_3 \sqsubseteq \bigsqcup_{t \in T} (A_t \sqcap \prod_{r' \in T \setminus \{t\}} \neg A_{r'}), \tag{C.8}$$

$$A_t \sqsubseteq \forall R_v. \bigsqcup_{(t, t') \in V} A_{t'}, \tag{C.9}$$

$$\text{for all } t \in T$$

$$A_t \sqsubseteq \forall R_h. \bigsqcup_{(t, t') \in H} A_{t'} \tag{C.10}$$

$$\text{for all } t \in T$$

}

Let $\mathcal{D} = \mathcal{D}_{a_0} \cup \mathcal{D}_{a_1} \cup \mathcal{D}_{a_2} \cup \mathcal{D}_b$, where

$$\mathcal{D}_{a_0} = \{U(a_0, c_1), R_h(c_1, c_2), R_v(c_1, c_3), R_v(c_2, c_4), R_h(c_3, c_5)\}$$

$$\mathcal{D}_{a_1} = \{U(a_1, d_1), R_h(d_1, d_2), U(d_3, d_2)\}$$

$$\mathcal{D}_{a_2} = \{U(a_2, e_1), R_v(e_1, e_2), U(e_3, e_2)\}$$

$$\mathcal{D}_b = \{B(b)\}$$

and let $P = \{a_0, a_1, a_2\}$. The connected components of the positive examples P can be depicted as follows:

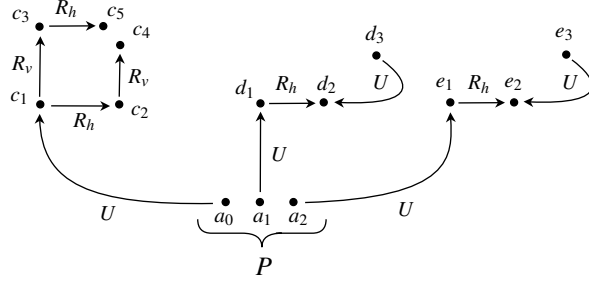

We aim to show that (T, H, V) admits a solution iff \mathcal{K} is FO-separable. By Point 3 of Theorem 59 it suffices to show the following.

Claim. (T, H, V) admits a solution iff there exists a model \mathfrak{A} of \mathcal{K} such that $\mathcal{D}_{\text{con}(a)}, a \not\vdash \mathfrak{A}, b^{\mathfrak{A}}$, for all $a \in P$.

Proof of the Claim. For (\Rightarrow) , assume there exists a solution τ to (T, H, V) . Then define a model \mathfrak{A} of \mathcal{K} by taking \mathcal{D} viewed as a structure and connecting b via U to all pairs in $\mathbb{N} \times \mathbb{N}$. On $\mathbb{N} \times \mathbb{N}$ we replicate the solution τ and make sure that the concept names P_i are interpreted in a suitable way. In detail, let

$$\begin{aligned}
B^{\mathfrak{A}} &= \{b\} \\
R_v^{\mathfrak{A}} &= \{(c, c') \mid R_v(c, c') \in \mathcal{D}\} \cup \{(i, j), (i, j+1) \mid i, j \in \mathbb{N}\} \\
R_h^{\mathfrak{A}} &= \{(c, c') \mid R_h(c, c') \in \mathcal{D}\} \cup \{(i, j), (i+1, j) \mid i, j \in \mathbb{N}\} \\
A_t^{\mathfrak{A}} &= \{(i, j) \in \mathbb{N} \times \mathbb{N} \mid \tau(i, j) = t\} && \text{for all } t \in T \\
U^{\mathfrak{A}} &= \{(c, c') \mid U(c, c') \in \mathcal{D}\} \cup \{(b, (i, j)) \mid i, j \in \mathbb{N}\} \\
P_0^{\mathfrak{A}} &= \{(2i, 2j) \mid i, j \in \mathbb{N}\} \\
P_1^{\mathfrak{A}} &= \{(2i+1, 2j) \mid i, j \in \mathbb{N}\} \\
P_2^{\mathfrak{A}} &= \{(2i, 2j+1) \mid i, j \in \mathbb{N}\} \\
P_3^{\mathfrak{A}} &= \{(2i+1, 2j+1) \mid i, j \in \mathbb{N}\}
\end{aligned}$$

and interpret all constants in \mathcal{D} by themselves. It is easy to see that \mathfrak{A} is a model of \mathcal{K} and $\mathcal{D}_{\text{con}(a)}, a \not\vdash \mathfrak{A}, b^{\mathfrak{A}}$, for all $a \in P$.

For (\Leftarrow) , assume that \mathfrak{A} is a model of \mathcal{K} such that $\mathcal{D}_{\text{con}(a)}, a \not\vdash \mathfrak{A}, b^{\mathfrak{A}}$, for all $a \in P$. We can then inductively show that \mathfrak{A} contains an infinite grid by using the CIs (C.1) to (C.7). In more detail, by (C.1), there is a U -successor b_0 of b that satisfies P_0 . Moreover, by (C.2)-(C.5), there are elements b_1, b_2, b_3, b'_3 such that

- b_i satisfies P_i , for each $i \in \{1, 2, 3\}$ and b'_3 satisfies P_3 ;
- b_1 is an R_h -successor of b_0 and b_2 is an R_v -successor of b_0 ;
- b_3 is an R_h -successor of b_2 and b'_3 is an R_v -successor of b_1 .

Moreover, by (C.6) and (C.7), b, b_0, b_1, b_2 are pairwise distinct and also different from b_3, b'_3 . Note that all elements b_0, b_1, b_2, b_3, b'_3 have an U -predecessor, by (C.2)-(C.5). Due to $\mathcal{D}_{\text{con}(a)}, a_i \not\vdash \mathfrak{A}, b^{\mathfrak{A}}$, for $i \in \{1, 2\}$, each such U -predecessor is in fact b . Moreover, $\mathcal{D}_{\text{con}(a)}, a_0 \not\vdash \mathfrak{A}, b^{\mathfrak{A}}$ entails that $b_3 = b'_3$, closing the grid cell. We can continue the argument in this way to obtain the full infinite grid. The remaining CIs of \mathcal{O} ensure that the grid is labeled with a solution to (T, H, V) . This finishes the proof of the Claim. \square