

## Detectability of labeled weighted automata over monoids

Kuize Zhang

Received: date / Accepted: date

**Abstract** In this paper, by developing appropriate methods, we for the first time obtain characterization of four fundamental notions of detectability for general labeled weighted automata over monoids (denoted by  $\mathcal{A}^{\mathfrak{M}}$  for short), where the four notions are strong (periodic) detectability (SD and SPD) and weak (periodic) detectability (WD and WPD). The contributions of the current paper are as follows. Firstly, we formulate the notions of concurrent composition, observer, and detector for  $\mathcal{A}^{\mathfrak{M}}$ . Secondly, we use the concurrent composition to give an equivalent condition for SD, use the detector to give an equivalent condition for SPD, and use the observer to give equivalent conditions for WD and WPD, all for general  $\mathcal{A}^{\mathfrak{M}}$  without any assumption. Thirdly, we prove that for a labeled weighted automaton over monoid  $(\mathbb{Q}^k, +)$  (denoted by  $\mathcal{A}^{\mathbb{Q}^k}$ ), its concurrent composition, observer, and detector can be computed in NP, 2-EXPTIME, and 2-EXPTIME, respectively, by developing novel connections between  $\mathcal{A}^{\mathbb{Q}^k}$  and the NP-complete exact path length problem (proved by [Nykänen and Ukkonen, 2002]) and a subclass of Presburger arithmetic. As a result, we prove that for  $\mathcal{A}^{\mathbb{Q}^k}$ , SD can be verified in coNP, while SPD, WD, and WPD can be verified in 2-EXPTIME. Particularly, for  $\mathcal{A}^{\mathbb{Q}^k}$  in which from every state, a distinct state can be reached through some unobservable, instantaneous path, detector  $\mathcal{A}_{det}^{\mathbb{Q}^k}$  can be computed in NP, and SPD can be verified in coNP. Finally, we prove that the problems of verifying SD and SPD of deterministic, deadlock-free, and divergence-free  $\mathcal{A}^{\mathbb{N}}$  over monoid  $(\mathbb{N}, +)$  are both coNP-hard.

The original methods developed in this paper will provide foundations for characterizing other fundamental properties (e.g., diagnosability and opacity) in labeled weighted automata over monoids.

In addition, in order to differentiate labeled weighted automata over monoids from labeled timed automata, we also initially explore detectability in labeled timed

---

K. Zhang  
Control Systems Group, Technical University of Berlin, 10587 Berlin, Germany  
E-mail: kuize.zhang@campus.tu-berlin.de

automata, and prove that the SD verification problem is PSPACE-complete, while WD and WPD are undecidable.

**Keywords** labeled weighted automaton · monoid · semiring · detectability · concurrent composition · observer · detector · complexity · labeled timed automaton

## 1 Introduction

### 1.1 Background and motivation

The state detection problem of partially-observed (aka labeled) dynamical systems has been a fundamental problem in both computer science [1] and control science [2] since the 1950s and the 1960s, respectively. *Detectability* is a basic property of labeled dynamical systems: when it holds one can use an observed label/output sequence generated by a system to reconstruct its *current* state [3,4,5,6]. This property plays a fundamental role in many related control problems such as observer design and controller synthesis. Hence in different application scenarios, it is meaningful to characterize different notions of detectability. On the other hand, detectability is strongly related to another fundamental property of diagnosability where the latter describes whether one can use an observed output sequence to determine whether some special events (called faulty events) have occurred [7,8]. Recently, a decentralized setting of strong detectability and diagnosability (together with another property called predictability) were unified into one mathematical framework in labeled finite-state automata [9]. Moreover, detectability is also related to several cyber-security properties, e.g., the property of opacity that was originally proposed to describe information flow security in computer science in the early 2000s [10] can be seen as the absence of detectability.

*Discrete-event systems* (DESs) are usually composed of transitions between discrete states caused by spontaneous occurrences of labeled events [11,12]. For DESs modeled by *labeled finite-state automata* and *labeled Petri nets*, the detectability problem has been widely studied, see related results on labeled finite-state automata [4,13,14,15,16], and also see related results on labeled Petri nets [17,18,19], and on labeled bounded Petri nets [20]. Detectability has also been studied for probabilistic finite-state automata [21,22].

The above models, either logic systems (labeled finite-state automata and labeled Petri nets), or probabilistic finite-state automata, are untimed. In such models, the time consumption for a transition's execution is not specified. In spite of this, one can infer from the above literature that all unobservable transitions' executions are assumed to consume no time by default, and the executions of every pair of observable transitions with the same label are assumed to consume the same time. In order to make these models more realistic, measures to time consumptions for transitions' executions have been added, so that timed models have been studied, e.g., *labeled timed*

automata<sup>1</sup> [23,24], special classes of labeled weighted automata over semirings [27,28], etc.

In this paper, we study *labeled weighted automata over monoids* [29], denoted by  $\mathcal{A}^{\mathfrak{M}}$ . Such systems have various features. When monoid  $\mathfrak{M}$  is specified as  $(\mathbb{Q}_{\geq 0}, +)$ , where  $\mathbb{Q}_{\geq 0}$  denotes the set of nonnegative rational numbers,  $\mathcal{A}^{\mathfrak{M}}$  becomes a one-clock labeled timed automaton in which the clock is reset along with every occurrence of every event and all clock constraints are singletons (details are shown in Section 4) (such automata are exactly the automata studied in [25]), and hence can represent timed DESs; when  $\mathfrak{M}$  is specified as  $(\mathbb{Q}^k, +)$ , the weights can represent deviations of positions of a moving object in some region; when  $\mathfrak{M}$  is specified as  $A^* \times B^*$  over alphabets  $A, B$ , where  $A^*$  and  $B^*$  are free monoids,  $\mathcal{A}^{\mathfrak{M}}$  becomes a (finite-state) transducer [30]. We will characterize detectability for general  $\mathcal{A}^{\mathfrak{M}}$  and will also prove that the results obtained in  $\mathcal{A}^{\mathbb{Q}^k}$  can be implemented algorithmically. Consider the motivating example as follows.

*Example 1* Consider a finite region shown in Fig. 1, in which  $P_1, P_2, P_3, P_4$  denote 4 positions. Assume a robot  $A$  walking between these positions to finish a prescribed task. Assume the energy levels of  $A$  are quantized into  $0, 1, \dots, 10$ . When  $A$  is in position  $P_1$  and moves to  $P_2$ , it sends signal  $a$  and its target position  $P_2$  along with its energy level decreasing by 1. The other movements can be described analogously, where signal  $a$  corresponds to energy level decreasing by 1, signal  $u$  corresponds to energy level decreasing by 0 or 1,  $b$  corresponds to energy level increasing by 1.  $A$  sends  $a$  and  $b$ , but never sends  $u$ . When  $A$  sends a signal, it meanwhile sends the corresponding target position. Particularly when the energy level of  $A$  is 10 it never increases, i.e., when  $A$  is in energy level 10 and moves from  $P_i$  to  $P_{i-1}$ ,  $i = 4, 3, 2$ , the energy level of  $A$  remains to be 10. Particularly when the energy level of  $A$  is 0 it never decreases, i.e., in this case  $A$  never moves from  $P_i$  to  $P_{i+1}$ ,  $i = 1, 2, 3$ . All these information is known to a person  $B$ . Assume that whenever  $A$  sends  $a$  or  $b$ ,  $B$  receives/observes the symbols and the corresponding target positions. Then as time advances,  $B$  cannot use these observations to determine what the energy level  $A$  will be in unless  $A$  never visits  $P_3$ . For example, assume initially  $A$  is in energy level 5 and in position  $P_1$ , and assume  $B$  knows the initial energy level. When  $A$  moves to  $P_2$ ,  $B$  observes  $a/P_2$ , and knows that  $A$  is in energy level 4. And then  $A$  moves to  $P_3$ ,  $A$  could be in energy level 4 or 3 but  $B$  does not know  $A$  is in  $P_3$ . From now on,  $B$  will never know what exact energy level  $A$  will be in. For example,  $A$  moves back to  $P_2$  and could be in energy level 5 or 4,  $B$  observes  $b/P_2$ ; and then  $A$  moves to  $P_3$  again,  $A$  could be in energy level 5, 4, or 3; and then  $A$  moves back to  $P_2$  again,  $A$  could be in energy level 6, 5, or 4,  $B$  observes  $b/P_2$  (see Table 1). Later in Example 5, we will show this model can be represented by a labeled weighted automaton over some monoid, but cannot be described by a labeled timed automaton.  $\square$

<sup>1</sup> In the current paper, we call the timed automata studied in [23,24,25] labeled timed automata, because the events therein are endowed with labels/outputs, while in the standard timed automata proposed in [26], events are unlabeled.

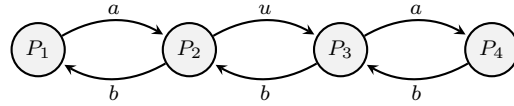

**Fig. 1** The finite region in the motivating Example 1.

position deviation	$P_1$	$\rightarrow P_2$	$\rightarrow P_3$	$\rightarrow P_2$	$\rightarrow P_3$	$\rightarrow P_2$	$\rightarrow P_3$	$\dots$
energy level estimation	5	4	4, 3	5, 4	5, 4, 3	6, 5, 4	6, 5, 4, 3	$\dots$
observation		$a/P_2$	$\epsilon$	$b/P_2$	$\epsilon$	$b/P_2$	$\epsilon$	$\dots$

**Table 1** Energy level estimation in the motivating Example 1.

## 1.2 Literature review

Two fundamental definitions are *strong detectability* and *weak detectability* [4]. The former implies that there exists a positive integer  $k$  such that for *every* infinite-length trajectory, each prefix of its label/output sequence of length no less than  $k$  allows reconstructing the current state. The latter relaxes the former by changing “*every*” to “*some*”. In order to adapt to different application scenarios, variants of strong detectability and weak detectability are also considered, which are called *strong periodic detectability* (a variant of strong detectability, requiring to determine states periodically along all output sequences) and *weak periodic detectability* (a variant of weak detectability, requiring to determine states periodically along some output sequence) [4]. Other essentially different variants of detectability such as *eventual strong detectability* and *weak approximate detectability* can be found in [19].

Most results on detectability of labeled finite-state automata are based on two fundamental assumptions of *deadlock-freeness* (which implies that a system can always run) and *divergence-freeness*, i.e., having no unobservable cycles (which implies that the running of a system will always be eventually observed). For labeled finite-state automata, under the two assumptions, an *observer* method (actually the powerset construction used for determinizing nondeterministic finite automata with  $\epsilon$ -transitions [31]) was proposed to verify weak (periodic) detectability in exponential time [4], later a *detector* method (a reduced version of the observer, obtained by splitting the states of an observer into subsets of cardinality 2, previously used in [32, 33]) was proposed to verify strong (periodic) detectability in polynomial time [13]. Also under the two assumptions, verifying weak (periodic) detectability was proven to be PSPACE-complete [14], verifying strong (periodic) detectability was proven to be NL-complete [16]. Recently, by developing a *concurrent-composition* method in [15, 19] (similar to but technically different from the structures used in [34, 23]), strong detectability was verified in polynomial time without any assumption, removing the two assumptions used for years.

For labeled Petri nets with inhibitor arcs, weak detectability was proven to be undecidable in [17] by reducing the undecidable language equivalence problem of labeled Petri nets (see [35]) to negation of weak detectability. For labeled Petri nets, strong detectability was proven to be decidable under the two previously mentioned

fundamental assumptions reformulated in labeled Petri nets, it was also proven that it is EXPSPACE-hard to verify strong detectability, but weak detectability is undecidable [18], which strengthens the related undecidability result proven in [17]. In [18], the undecidable language inclusion problem (but not the language equivalence problem) of labeled Petri nets (also see [35]) was reduced to negation of weak detectability, so that the same idea in the reduction constructed in [17], i.e., clearing all tokens of the first of the two basic labeled Petri nets, was also implemented. Later, the decidability result for strong detectability was strengthened to hold under only the divergence-freeness assumption [36] by developing a new tool called extended concurrent composition. All decidable results on labeled Petri nets proven in [18,36] were obtained by reducing negation of strong detectability to satisfiability of some Yen's path formulae [37,38].

The notion of observer has been recently extended to a subclass of labeled timed automata in which the automata are deterministic, there is a single clock that is reset along with every occurrence of every event and all clock constraints in all transitions are singletons [25]. This class of labeled timed automata are exactly labeled weighted automata over the monoid  $(\mathbb{Q}_{\geq 0}, +)$ , denoted by  $\mathcal{A}^{\mathbb{Q}_{\geq 0}}$ , which are a strict subclass of the automata studied in the current paper. The observer defined in [25] was computed in 2-EXPTIME, and computed in EXPTIME when the considered automata are divergence-free. The method of computing an observer is via unfolding every state  $q$  to a finite number  $n$  of new states and then compute the observer of the newly obtained labeled finite-state automaton as in [4], where  $n$  is the maximum among the weights of all outgoing transitions of  $q$ . Hence the method does not apply to labeled weighted automata with weights being negative rational numbers. In addition, the authors also give an example to show that if some weights are irrational numbers, the observer may have infinitely many states and infinitely many transitions. In Remark 7, we will also use an example in the current paper to illustrate how to compute the observer defined in [25].

The notion of observer has also been extended to subclasses of labeled max-plus automata over the semiring  $\underline{\mathbb{Q}} := (\mathbb{Q} \cup \{-\infty\}, \max, +, -\infty, 0)$ , denoted by  $\mathcal{A}^{\underline{\mathbb{Q}}}$ . In [27], the observer was computed for a divergence-free  $\mathcal{A}^{unam, \underline{\mathbb{Q}}}$  ( $\mathcal{A}^{unam, \underline{\mathbb{Q}}}$  is short for an unambiguous  $\mathcal{A}^{\underline{\mathbb{Q}}}$ ) in EXPTIME, and in [28] the observer was computed for a divergence-free, polynomially ambiguous  $\mathcal{A}^{\underline{\mathbb{Q}}}$  with the clones property but no upper bound for time complexity was given. In [27], the above mentioned four notions of detectability of divergence-free  $\mathcal{A}^{unam, \underline{\mathbb{Q}}}$  were verified in EXPTIME by using the observer. In [27,28], the authors adopted the max-plus manner to define detectability but not the real-time manner adopted in [25] and the current paper. The detectability results in untimed models mentioned above (e.g., [4,14,16,18,19]) are all in the real-time manner. Consider a sequence  $q_0 \xrightarrow{e_1} \dots \xrightarrow{e_n} q_n$  of transitions (called a path), where  $q_i$ ,  $0 \leq i \leq n$ , are states,  $e_j$ ,  $1 \leq j \leq n$ , are events; in the real-time manner, the timed word of the path is  $(e_1, t_1) \dots (e_n, t_n)$ , where  $t_j$  is the instant when  $e_j$  occurs in the path; while in the max-plus manner, the timed sequence of the path is  $(e_1, t'_1) \dots (e_n, t'_n)$ ,  $t'_j$  is the maximal time for  $e_1, \dots, e_j$  to occur among all different paths having  $e_1 \dots e_j$  as their event sequence and having  $q_j$  as the final state, so  $t'_j \geq t_j$ . A detailed comparison will be given in Remark 8. The overlaps between the

results in [28] and the results in the current paper are the results of [27], because in  $\mathcal{A}^{unam, \mathbb{Q}}$ , under every event sequence, there exists at most one path from the initial states to any given state, resulting in that the max-plus manner coincides with the real-time manner. The overlaps between the results in [28] and the results in [25] are a strict subset of the results in [27], i.e., the observer of a divergence-free  $\mathcal{A}^{unam, \mathbb{Q}_{\geq 0}}$  ( $\mathcal{A}^{unam, \mathbb{Q}_{\geq 0}}$  is short for a labeled unambiguous weighted automaton over the semiring  $\mathbb{Q}_{\geq 0} := (\mathbb{Q}_{\geq 0} \cup \{-\infty\}, \max, +, -\infty, 0)$ ). The relations of the results in [27, 28, 25] and the current paper are shown in Fig. 2.

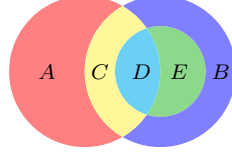

**Fig. 2** Relations of the results in [27, 28, 25] and the current paper, where [27] =  $C \cup D$  (i.e., the results in [27] are represented by  $C \cup D$ , the following equalities have similar meanings), [28] =  $A \cup C \cup D$ , [25] =  $D \cup E$ , the current paper =  $B \cup C \cup D \cup E$ . The automata considered in  $A \cup C \cup D$  are divergence-free, the automata considered in  $E \cup B$  are not divergence-free.

The results in [27] generally do not apply to an automaton  $\mathcal{A}^{unam, \mathbb{Q}}$  that is not divergence-free (see Remark 9). Although the observer is computed for a general automaton  $\mathcal{A}^{\mathbb{Q}_{>0}}$  in [25], the observer cannot always be used for verifying detectability for an automaton  $\mathcal{A}^{\mathbb{Q}_{>0}}$  that is not divergence-free; this is even true in labeled finite-state automata [19, Remark 2]. **Detectability of general  $\mathcal{A}^{unam, \mathbb{Q}}$  and general  $\mathcal{A}^{\mathbb{Q}_{>0}}$  can be verified by using the methods developed in the current paper, for the first time.** Apart from the above advantages of the current paper compared with [25, 27], we also show that  $\mathcal{A}^{unam, \mathbb{N}}$  and  $\mathcal{A}^{unam, \mathbb{N}}$  are already fundamentally more complicated than a labeled finite-state automaton  $\mathcal{A}$  by showing in Theorem 14 that, the problems of verifying strong (periodic) detectability of deterministic, deadlock-free, and divergence-free  $\mathcal{A}^{unam, \mathbb{N}}$  and  $\mathcal{A}^{unam, \mathbb{N}}$  are coNP-hard, where  $\mathcal{A}^{unam, \mathbb{N}}$  denotes a labeled unambiguous weighted automaton over the max-plus semiring  $\mathbb{N} := (\mathbb{N} \cup \{-\infty\}, \max, +, -\infty, 0)$ ,  $\mathcal{A}^{unam, \mathbb{N}}$  denotes a labeled unambiguous weighted automaton over monoid  $(\mathbb{N}, +, 0)$ , because as previously mentioned, strong (periodic) detectability of automaton  $\mathcal{A}$  can be verified in polynomial time [13, 15].

Probabilistic finite-state automata were also widely studied models in DESs (e.g., in [21, 22]). They are actually weighted automata over the semiring  $(\mathbb{R}, +, \cdot, 0, 1) =: \mathbb{R}$ , but the weights are only chosen from  $[0, 1]$ . Because only probabilities are computed, no computation produces a value outside  $[0, 1]$ . In such automata, the reliability of an event sequence is defined as the sum of the reliabilities of its successful paths, where the reliability of a successful path is the product of the probabilities (i.e., weights) of all its transitions. Hence the detectability notions studied in [21, 22] are defined in a totally different way compared with those in [27, 25] and the current paper. On the other hand, in this paper we will give equivalent conditions for four

fundamental notions of detectability of labeled weighted automata over any monoids, which include the results on labeled weighted automata over the monoid  $(\mathbb{R}, \cdot, 1)$  as a special class.

### 1.3 Contributions of the paper

The first contribution is on a general labeled weighted automaton over a monoid, denoted by  $\mathcal{A}^{\mathfrak{M}}$ .

1. We for the first time formulate the notions of concurrent composition, observer, and detector for  $\mathcal{A}^{\mathfrak{M}}$ , which are natural but nontrivial extensions of those for labeled finite-state automata. We use the notion of concurrent composition to give an equivalent condition for strong detectability, use the notion of observer to give equivalent conditions for weak detectability and weak periodic detectability, and use the notion of detector to give an equivalent condition for strong periodic detectability, all for general  $\mathcal{A}^{\mathfrak{M}}$  without any assumption.

The second contribution of the paper is on labeled weighted automata over the monoid  $(\mathbb{Q}^k, +, 0_k)$  (denoted by  $\mathcal{A}^{\mathbb{Q}^k}$ ), where  $0_k \in \mathbb{Q}^k$  denotes the  $k$ -length zero vector, in which the special results on unambiguous  $\mathcal{A}^{\mathbb{Q}}$  also hold for labeled unambiguous weighted automata over semiring  $\underline{\mathbb{Q}}$  (denoted by  $\mathcal{A}^{unam, \underline{\mathbb{Q}}}$ ), because the four notions of detectability of  $\mathcal{A}^{unam, \underline{\mathbb{Q}}}$  in [27] coincide with the four notions of detectability of  $\mathcal{A}^{unam, \mathbb{Q}}$  in the current paper correspondingly (except for minor and neglectable differences, see Remark 8).

2. We find novel connections between  $\mathcal{A}^{\mathbb{Q}^k}$  and the exact path length problem [39] and a subclass of Presburger arithmetic [40] so that detectability of  $\mathcal{A}^{\mathbb{Q}^k}$  can be verified.
3. For  $\mathcal{A}^{\mathbb{Q}^k}$ , we prove that its observer and detector can be computed in 2-EXPTIME, its self-composition can be computed in NP, all in the size of  $\mathcal{A}^{\mathbb{Q}^k}$ .
4. We prove that strong detectability of  $\mathcal{A}^{\mathbb{Q}^k}$  can be verified in coNP, while strong periodic detectability, weak detectability, and weak periodic detectability of  $\mathcal{A}^{\mathbb{Q}^k}$  can be verified in 2-EXPTIME, all in the size of  $\mathcal{A}^{\mathbb{Q}^k}$ . Particularly for  $\mathcal{A}^{\mathbb{Q}^k}$  in which from every state, a distinct state can be reached through some unobservable, instantaneous path, its detector can be computed in NP, and its strong periodic detectability can be verified in coNP. We also prove that the problems of verifying strong detectability and strong periodic detectability of deterministic, deadlock-free, and divergence-free  $\mathcal{A}^{\mathbb{N}}$  are both coNP-hard. See Table 2 and Table 3 as collections of related results.

Finally, in order to differentiate labeled weighted automata over monoids from labeled timed automata, we also initially explore detectability in labeled timed automata.

5. We prove that in labeled timed automata, the strong detectability verification problem is PSPACE-complete, while weak (periodic) detectability is undecidable.

	SD	SPD	WD, WPD
$\mathcal{A}$	PTIME [15] NL [9]	PTIME (Cor. 7)	PSPACE [19]
d.d. $\mathcal{A}$	PTIME [13] NL-c. [16]	PTIME [13] NL-c. [16]	EXPTIME [4] PSPACE-c. [14]
$\mathcal{A}^{\mathbb{Q}^k}$	coNP-c. (Thms. 7, 14)	2-EXPTIME (Thm. 12) coNP-h. (Thm. 14)	2-EXPTIME (Thms. 9, 10)
d.d. $\mathcal{A}^{\mathbb{Q}^k}$	coNP-c. (Thms. 7, 14)	EXPTIME (Thm. 13) coNP-h. (Thms. 14)	EXPTIME (Cor. 3)
$\mathcal{A}^{u., \mathbb{Q}^k}$ $\mathcal{A}^{u., \mathbb{Q}}$	coNP-c. (Cor. 8)	2-EXPTIME (Thm. 12) coNP-h. (Thm. 14)	2-EXPTIME (Thms. 9, 10)
d.d. $\mathcal{A}^{u., \mathbb{Q}^k}$ d.d. $\mathcal{A}^{u., \mathbb{Q}}$	EXPTIME [27] coNP-c. (Cor. 8)	EXPTIME [27] (Thm. 13) coNP-h. (Thm. 14)	EXPTIME [27] (Cor. 3)
d.d.d. $\mathcal{A}^{\mathbb{N}}$ d.d.d. $\mathcal{A}^{\mathbb{N}}$	coNP (Cor. 8) coNP-h. (Thm. 14)	EXPTIME (Thm. 13) coNP-h. (Thm. 14)	EXPTIME [27] (Cor. 3)

**Table 2** Results on complexity of verifying four notions of detectability of automata, where SD, SPD, WD, and WPD are short for strong detectability, strong periodic detectability, weak detectability, and weak periodic detectability, respectively;  $\mathcal{A}$  denotes a labeled finite-state automaton,  $\mathcal{A}^{\mathbb{Q}^k}$  (resp.,  $\mathcal{A}^{\mathbb{Q}}$ ,  $\mathcal{A}^{\mathbb{N}}$ ,  $\mathcal{A}^{\mathbb{N}}$ ) denotes a labeled weighted automaton over monoid  $(\mathbb{Q}^k, +, 0_k)$  (resp., max-plus semiring  $(\mathbb{Q} \cup \{-\infty\}, \max, +, -\infty, 0)$ , max-plus semiring  $(\mathbb{N} \cup \{-\infty\}, \max, +, -\infty, 0)$ ), monoid  $(\mathbb{N}, +, 0)$ ), “u.” is short for “unambiguous”, “d.d.” is short for “deadlock-free, divergence-free”, “d.d.d.” is short for “deterministic, deadlock-free, divergence-free”, “c.” denotes “complete”, “h.” denotes “hard”.

	observer	detector	self-composition
$\mathcal{A}$	EXPTIME [4]	PTIME [13]	PTIME [15, 19]
$\mathcal{A}^{\mathbb{Q}^k}$	2-EXPTIME (Thm. 8)	2-EXPTIME (Thm. 11)	NP (Thm. 6)
$\mathcal{A}^{\mathbb{Q}_{\geq 0}}$	2-EXPTIME [25] (Thm. 8)	2-EXPTIME (Thm. 11)	NP (Thm. 6)
d. $\mathcal{A}^{\mathbb{Q}^k}$	EXPTIME (Cor. 2)	EXPTIME (Cor. 5)	NP (Thm. 6)
d. $\mathcal{A}^{\mathbb{Q}_{\geq 0}}$	EXPTIME [25] (Cor. 2)	EXPTIME (Cor. 5)	NP (Thm. 6)
d. $\mathcal{A}^{u., \mathbb{Q}^k}$ d. $\mathcal{A}^{u., \mathbb{Q}}$	EXPTIME [27] (Cor. 2)	EXPTIME (Cor. 5)	NP (Thm. 6)

**Table 3** Results on complexity of computing observers, detectors, and self-compositions of automata, where  $\mathcal{A}$ ,  $\mathcal{A}^{\mathbb{Q}^k}$ ,  $\mathcal{A}^{\mathbb{Q}}$ ,  $u.$  are the same as those in Table 2,  $\mathcal{A}^{\mathbb{Q}_{\geq 0}}$  denotes a labeled weighted automaton over the monoid  $(\mathbb{Q}_{\geq 0}, +, 0)$ , “d.” is short for “divergence-free”.



## 2 Preliminaries

### 2.1 Notation

Symbols  $\mathbb{N}$ ,  $\mathbb{Z}$ ,  $\mathbb{Z}_+$ ,  $\mathbb{Q}$ ,  $\mathbb{Q}_{\geq 0}$ ,  $\mathbb{R}$ , and  $\mathbb{R}_{\geq 0}$  denote the sets of nonnegative integers, integers, positive integers, rational numbers, nonnegative rational numbers, real numbers, and nonnegative real numbers, respectively. Symbol  $0_k$  denotes the  $k$ -length zero vector. For a finite alphabet  $\Sigma$ ,  $\Sigma^*$  and  $\Sigma^\omega$  are used to denote the set of *words* (i.e., finite-length sequences of elements of  $\Sigma$ ) over  $\Sigma$  including the empty word  $\epsilon$  and the set of *configurations* (i.e., infinite-length sequences of elements of  $\Sigma$ ) over  $\Sigma$ , respectively.  $\Sigma^+ := \Sigma^* \setminus \{\epsilon\}$ . For a word  $s \in \Sigma^*$ ,  $|s|$  stands for its length, and we set  $|s'| = +\infty$  for all  $s' \in \Sigma^\omega$ . For  $s \in \Sigma^+$  and  $k \in \mathbb{N}$ ,  $s^k$  and  $s^\omega$  denote the concatenations of  $k$  copies of  $s$  and infinitely many copies of  $s$ , respectively. Analogously,  $L_1 L_2 := \{e_1 e_2 \mid e_1 \in L_1, e_2 \in L_2\}$ , where  $L_1, L_2 \subset \Sigma^*$ . For a word (configuration)  $s \in \Sigma^*(\Sigma^\omega)$ , a word  $s' \in \Sigma^*$  is called a *prefix* of  $s$ , denoted as  $s' \sqsubset s$ , if there exists another word (configuration)  $s'' \in \Sigma^*(\Sigma^\omega)$  such that  $s = s' s''$ . For two nonnegative integers  $i \leq j$ ,  $\llbracket i, j \rrbracket$  denotes the set of all integers no less than  $i$  and no greater than  $j$ ; and for a set  $S$ ,  $|S|$  denotes its cardinality and  $2^S$  its power set. Symbols  $\subset$  and  $\subsetneq$  denote the subset and strict subset relations, respectively.

We will use the *exact path length* (EPL) problem, the *subset sum* problem, and a subclass of *Presburger arithmetic* in the literature to prove the main results.

### 2.2 The exact path length problem

Consider a  $k$ -dimensional weighted directed graph  $G = (\mathbb{Q}^k, V, A)$ , where  $k \in \mathbb{Z}_+$ ,  $\mathbb{Q}^k = \underbrace{\mathbb{Q} \times \cdots \times \mathbb{Q}}_k$ ,  $V$  is a finite set of vertices,  $A \subset V \times \mathbb{Q}^k \times V$  a finite set of

weighted edges (arcs) with weights in  $\mathbb{Q}^k$ . For a path  $v_1 \xrightarrow{z_1} \cdots \xrightarrow{z_{n-1}} v_n$ , its weight is defined by  $\sum_{i=1}^{n-1} z_i$ . For an edge  $a = (v_1, z, v_2) \in A$ , also denoted by  $v_1 \xrightarrow{z} v_2$ , we call  $v_1$  and  $v_2$  the *tail* (denoted by  $\text{tail}(a)$ ) and the *head* (denoted by  $\text{head}(a)$ ) of  $a$ , respectively. The EPL problem [39] is stated as follows.

**Problem 1 (EPL)** Given a positive integer  $k$ , a  $k$ -dimensional weighted directed graph  $G = (\mathbb{Q}^k, V, A)$ , two vertices  $v_1, v_2 \in V$ , and a vector  $z \in \mathbb{Q}^k$ , determine whether there exists a path from  $v_1$  to  $v_2$  with weight  $z$ .

We set as usual that for a positive integer  $n$ , the size  $\text{size}(n)$  of  $n$  to be the length of its binary representation, i.e.,  $\text{size}(n) = \lceil \log_2(n+1) \rceil$  ( $\lceil \cdot \rceil$  is the ceiling function),  $\text{size}(-n) = 1 + \text{size}(n)$ ;  $\text{size}(0) = 1$ ; for a rational number  $m/n$ , where  $m, n$  are relatively prime integers,  $\text{size}(m/n) = \text{size}(m) + \text{size}(n)$ ; then for a vector  $z \in \mathbb{Q}^k$ , its size is the sum of the sizes of its entries. The size of an instance  $(k, G, v_1, v_2, z)$  of the EPL problem is defined by  $\text{size}(k) + \text{size}(G) + 2 + \text{size}(z)$ , where  $\text{size}(G) = |V| + \text{size}(A)$ ,  $\text{size}(A) = \sum_{(v_1, z', v_2) \in A} (2 + \text{size}(z'))$ .

**Lemma 1** ([39]) *The EPL problem belongs to NP.<sup>2</sup> The EPL problem is NP-hard already for graph  $(\mathbb{N}, V, A)$ .*

### 2.3 The subset sum problem

The subset sum problem [41, p. 223] is as follows.

**Problem 2 (subset sum)** Given positive integers  $n_1, \dots, n_m$ , and  $N$ , determine whether  $N = \sum_{i \in I} n_i$  for some  $I \subset [1, m]$ .

**Lemma 2** ([41]) *The subset sum problem is NP-complete.*

### 2.4 Presburger arithmetic

We will use a subclass of Presburger arithmetic. A Presburger formula/sentence of this subclass is as follows:

$$(Q_1 x_1 \in \mathbb{N}) \dots (Q_s x_s \in \mathbb{N}) [\Phi(x_1, \dots, x_s)], \quad (1)$$

where  $Q_1, \dots, Q_s$  are any *quantifier prefix* ( $Q_i = \exists$  (*existential quantifier*) or  $\forall$  (*universal quantifier*)),  $x_1, \dots, x_s$  are variables,  $\Phi(x_1, \dots, x_s)$  is a formula consisting of a Boolean combination of linear inequalities of the form

$$a_1 x_1 + \dots + a_s x_s \leq b \quad (2)$$

with  $a_1, \dots, a_s, b$  constant integers.

For example,  $(x_1 = 1) = (x_1 \geq 1) \wedge (x_1 \leq 1) = \neg(x_1 < 1) \wedge (x_1 \leq 1) = \neg(x_1 \leq 0) \wedge (x_1 \leq 1)$  and  $(x_1 = 1) \implies (x_2 > 2) = \neg(x_1 = 1) \vee \neg(x_2 \leq 2)$  are such quantifier-free formulae.

**Lemma 3** ([40]) *Consider a Presburger sentence as in (1) of length  $r$  with  $m$  quantifier alternations (i.e., with  $m$  blocks of adjacent quantifiers of the same kind). Then the sentence is satisfied if and only if*

$$(Q_1 x_1 \leq w) \dots (Q_s x_s \leq w) [\Phi(x_1, \dots, x_s)]$$

*is satisfied, where  $w = 2^{cr^{(s+3)^{m+1}}}$ ,  $c$  is a constant.*

---

<sup>2</sup> Note that the original EPL problem studied in [39] is on graph  $(\mathbb{Z}^k, V, A)$ . However, the proof (a polynomial-time reduction from EPL to integer linear programming) in [39] also applies to the more general case for graph  $(\mathbb{Q}^k, V, A)$ , resulting in Lemma 1.

This yields a decision procedure: one can first compute  $w$  from  $r, m, s$ , and then check all  $s$ -tuples of nonnegative integers  $x_1, \dots, x_s$  with  $x_i \leq w$ , whether  $\Phi(x_1, \dots, x_s)$  is true.

In (1), if  $s \in \mathbb{Z}_+$  is also regarded as input,  $Q_1 = \dots = Q_s = \exists$ , and  $\Phi(x_1, \dots, x_s)$  is conjunctions of linear equations of the form  $a_1x_1 + \dots + a_sx_s = b$  with  $a_1, \dots, a_s, b$  constant rational numbers, then (1) becomes the NP-complete integer linear programming [42,43].

## 2.5 Labeled weighted automata over monoids

A *monoid* is a triple  $\mathfrak{M} = (T, \otimes, \mathbf{1})$ , where for all  $a, b, c \in T$ ,

- $a \otimes b \in T$ ,
- (associativity)  $(a \otimes b) \otimes c = a \otimes (b \otimes c)$ ,
- $a \otimes \mathbf{1} = \mathbf{1} \otimes a = a$  ( $\mathbf{1} \in T$  is called *identity* of  $\mathfrak{M}$ ).

Particularly, if there exists an element  $\mathbf{0} \in T$  such that  $\mathbf{0} \otimes a = a \otimes \mathbf{0} = \mathbf{0}$  for all  $a \in T$ , then we call  $\mathbf{0}$  *zero* of  $\mathfrak{M}$ . Any monoid has exactly one *identity* and at most one *zero*.

A *labeled weighted automaton over monoid*  $\mathfrak{M} = (T, \otimes, \mathbf{1})$  is a tuple

$$\mathcal{A}^{\mathfrak{M}} = (\mathfrak{M}, Q, E, Q_0, \Delta, \alpha, \mu, \Sigma, \ell), \quad (3)$$

where  $Q$  is a finite set of *states*,  $E$  a finite *alphabet* (elements of  $E$  are called *events*),  $Q_0 \subset Q$  a set of *initial states*,  $\Delta \subset Q \times E \times Q$  a *transition relation* (elements of  $\Delta$  are called *transitions*, a transition  $(q, e, q') \in \Delta$  is interpreted as when  $\mathcal{A}^{\mathfrak{M}}$  is in state  $q$  and event  $e$  occurs,  $\mathcal{A}^{\mathfrak{M}}$  transitions to state  $q'$ ),  $\alpha$  assigns to each initial state  $q_0 \in Q_0$  a nonzero *weight*  $\alpha(q_0) \in T$ ,  $\mu$  assigns to each transition  $(q, e, q') \in \Delta$  (or rewritten as  $q \xrightarrow{e} q'$ ) a nonzero *weight*  $\mu(e)_{qq'} \in T$ , where the transition is also denoted by  $q \xrightarrow{e/\mu(e)_{qq'}} q'$ ,  $\Sigma$  is a finite set of *outputs/labels*, and  $\ell : E \rightarrow \Sigma \cup \{\epsilon\}$  is a *labeling function*.

Particularly,  $\mathcal{A}^{\mathbb{Q}^k}$ ,  $\mathcal{A}^{\mathbb{Q}_{\geq 0}}$ ,  $\mathcal{A}^{\mathbb{N}}$  denote  $\mathcal{A}^{\mathfrak{M}}$  in which  $\mathfrak{M}$  is specified as  $(\mathbb{Q}^k, +, 0_k)$ ,  $(\mathbb{Q}_{\geq 0}, +, 0)$ ,  $(\mathbb{N}, +, 0)$ , where  $\mathcal{A}^{\mathbb{Q}_{\geq 0}}$  and  $\mathcal{A}^{\mathbb{N}}$  can represent timed DESs. The size  $\text{size}(\mathcal{A}^{\mathbb{Q}^k})$  of a given  $\mathcal{A}^{\mathbb{Q}^k}$  is defined by  $|Q| + |\Delta| + \text{size}(\alpha) + \text{size}(\mu) + \text{size}(\ell)$ , where the size of a rational vector has already been defined before,  $\text{size}(\alpha) = |Q_0| + \sum_{q \in Q_0} \text{size}(\alpha(q))$ ,  $\text{size}(\mu) = \sum_{(q,e,q') \in \Delta} \text{size}(\mu(e)_{qq'})$ ,  $\text{size}(\ell) = |\{(e, \ell(e)) | e \in E\}|$ . The size of a given  $\mathcal{A}^{\mathbb{Q}_{\geq 0}}$  (resp.,  $\mathcal{A}^{\mathbb{N}}$ ) can be defined analogously.

*Remark 1* A *labeled finite-state automaton* (studied in [4, 13, 16, 14], etc.) can be regarded as automaton  $\mathcal{A}^{\mathbb{N}}$  such that all unobservable transitions are instantaneous and every two observable transitions with the same label have the same weight in  $\mathbb{N}$ . The observer of such  $\mathcal{A}^{\mathbb{N}}$  can be computed in exponential time [4]. In the sequel, we use  $\mathcal{A}$  to denote a labeled finite-state automaton (without weights).  $\square$

Events in  $E_{uo} = \{e \in E | \ell(e) = \epsilon\}$  are called *unobservable*, events in  $E_o = \{e \in E | \ell(e) \neq \epsilon\}$  are called *observable*. When an observable event  $e \in E_o$  occurs,  $\ell(e)$  is observed; but when an unobservable event  $e \in E_{uo}$  occurs, nothing is observed. For every  $q \in Q$ , we also regard  $q \xrightarrow{\epsilon/\mathbf{1}} q$  as a transition. A transition  $q \xrightarrow{e/\mu(e)_{qq'}} q'$  is called *instantaneous* if  $\mu(e)_{qq'} = \mathbf{1}$ , and called *noninstantaneous* otherwise. A transition  $q \xrightarrow{e/\mu(e)_{qq'}} q'$  is called *observable (resp., unobservable)* if  $e$  is observable (resp., unobservable). We denote by  $\Delta_o = \{(q, e, q') \in \Delta | \ell(e) \neq \epsilon\}$  and  $\Delta_{uo} = \{(q, e, q') \in \Delta | \ell(e) = \epsilon, e \neq \epsilon\}$  the sets of observable transitions and unobservable transitions, respectively. Particularly, we denote  $E_a = \{e \in E_o | \ell(e) = a\}$ ,  $\Delta_a = \{(q, e, q') \in \Delta | \ell(e) = a\}$ , where  $a \in \Sigma$ . Automaton  $\mathcal{A}^{\mathfrak{M}}$  is called *deterministic* if (1)  $|Q_0| = 1$  and (2) for all states  $q, q', q'' \in Q$  and events  $e \in E$ , if  $(q, e, q') \in \Delta$  and  $(q, e, q'') \in \Delta$  then  $q' = q''$  (hence one also has  $\mu(e)_{qq'} = \mu(e)_{qq''}$ ).

From now on, without loss of generality, we assume for each initial state  $q_0 \in Q_0$ ,  $\alpha(q_0) = \mathbf{1}$ , because otherwise we add a new initial state  $q'_0 \notin Q$  and set  $\alpha(q'_0) = \mathbf{1}$ ; and then for each initial state  $q_0 \in Q_0$  such that  $\alpha(q_0) \neq \mathbf{1}$ , we let  $q_0$  not be initial any more, and add a transition  $q'_0 \xrightarrow{\epsilon/\alpha(q_0)} q_0$ , where  $\epsilon$  is a new event not in  $E$  and unobservable. The case for  $\mathcal{A}^{\mathbb{Q}_{>0}}$  is interpreted as follows: if an automaton was initially in state  $q_0$ , then before instant  $\alpha(q_0)$ , no event occurred, hence nothing could be observed. So it makes sense to set  $\epsilon$  to be unobservable.

Particularly for  $\mathcal{A}^{\mathbb{Q}_{>0}}$ , for initial state  $q \in Q_0$ ,  $\alpha(q)$  denotes its initial time delay, and in a transition  $q \xrightarrow{e/\mu(e)_{qq'}} q'$ ,  $\mu(e)_{qq'}$  denotes its time delay (i.e., the time consumption of its execution). Hence the execution of an instantaneous transition has time delay 0, i.e., does not cost time, while the execution of a noninstantaneous transition has time delay a positive rational number  $\mu(e)_{qq'}$ , i.e., costs time  $\mu(e)_{qq'}$ . As pointed out before, without loss of generality, we assume  $\alpha(q_0) = 0$  for all  $q_0 \in Q_0$ .

For  $q_0, \dots, q_n \in Q$  and  $e_1, \dots, e_n \in E$ ,  $n \in \mathbb{Z}_+$ , we call a sequence

$$\pi := q_0 \xrightarrow{e_1} q_1 \xrightarrow{e_2} \dots \xrightarrow{e_n} q_n \quad (4)$$

of transitions a (*finite*) *path*. A state  $q$  is called *reachable* if it is initial or there exists a path from some initial state to  $q$ . A path  $\pi$  is called *simple* if  $q_0, \dots, q_n$  are pairwise different. A path  $\pi$  is called a *cycle* if  $q_0 = q_n$ , and a *simple cycle* is such that  $q_0, \dots, q_{n-1}$  are pairwise different. A path  $\pi$  is called *unobservable* if  $\ell(e_1 \dots e_n) = \epsilon$ , and called *observable* otherwise. The set of paths starting at  $q_0 \in Q$  and ending at  $q \in Q$  is denoted by  $q_0 \rightsquigarrow q$ . Particularly, for  $e_1, \dots, e_n \in E$ ,  $q_0 \overset{e_1 \dots e_n}{\rightsquigarrow} q$  denotes the set of all paths under  $e_1 \dots e_n$ , i.e., the paths  $q_0 \xrightarrow{e_1} q_1 \xrightarrow{e_2} \dots \xrightarrow{e_{n-1}} q_{n-1} \xrightarrow{e_n} q$ , where  $q_1, \dots, q_{n-1} \in Q$ . Automaton  $\mathcal{A}^{\mathfrak{M}}$  is called *unambiguous* if under every event sequence, there exists at most one path from the initial states to any given state, i.e., for all  $s \in E^+$  and  $q \in Q$ , one has  $\left| \bigcup_{q_0 \in Q_0} (q_0 \overset{s}{\rightsquigarrow} q) \right| \leq 1$ . If  $\mathcal{A}^{\mathfrak{M}}$  is deterministic then it is unambiguous.

The *weighted word* of path  $\pi$  is defined by

$$\tau(\pi) := (e_1, t_1)(e_2, t_2) \dots (e_n, t_n), \quad (5)$$

where for all  $i \in \llbracket 1, n \rrbracket$ ,  $t_i = \bigotimes_{j=1}^i \mu(e_j)_{q_{j-1}q_j}$ . The *weight* of path  $\pi$  is defined by  $t_n =: \text{WT}_\pi$ . A path  $\pi$  is called *instantaneous* if  $t_1 = \dots = t_n = \mathbf{1}$ , and called *noninstantaneous* otherwise.

Particularly for  $\mathcal{A}^{\mathbb{Q}_{\geq 0}}$ , one has  $t_i = \sum_{j=1}^i \mu(e_j)_{q_{j-1}q_j}$ , hence the  $t_i$  in  $\tau(\pi)$  can be used to denote the total time consumptions for the first  $i$  transitions in path  $\pi$ ,  $i \in \llbracket 1, n \rrbracket$ . Hence we also call a weighted word of automaton  $\mathcal{A}^{\mathbb{Q}_{\geq 0}}$  *timed word*. If  $\mathcal{A}^{\mathbb{Q}_{\geq 0}}$  generates a path  $\pi$  as in (4), consider its timed word  $\tau(\pi)$  as in (5), then at instant  $t_i$ , one observes  $\ell(e_i)$  if  $\ell(e_i) \neq \epsilon$ ; and observes nothing otherwise, where  $i \in \llbracket 1, n \rrbracket$ . We simply say one observes  $\ell(\tau(\pi))$ . With this intuitive observation, we will define the notion of current-state estimate in the next section.

We use  $L(\mathcal{A}^{\mathfrak{M}})$  to denote the set of weighted words of all paths of  $\mathcal{A}^{\mathfrak{M}}$  starting from initial states.

For  $q_0, q_1, \dots \in Q$  and  $e_1, e_2, \dots \in E$ , we call

$$\pi := q_0 \xrightarrow{e_1} q_1 \xrightarrow{e_2} \dots \quad (6)$$

an *infinite path*. The  $\omega$ -*weighted word* of infinite path  $\pi$  is defined by

$$\tau(\pi) := (e_1, t_1)(e_2, t_2) \dots, \quad (7)$$

where for all  $i \in \mathbb{Z}_+$ ,  $t_i = \bigotimes_{j=1}^i \mu(e_j)_{q_{j-1}q_j}$ .

We use  $L^\omega(\mathcal{A}^{\mathfrak{M}})$  by to denote the set of  $\omega$ -weighted words of all infinite paths of  $\mathcal{A}^{\mathfrak{M}}$  starting from initial states. Particularly, we also call an  $\omega$ -weighted word of automaton  $\mathcal{A}^{\mathbb{Q}_{\geq 0}}$   $\omega$ -*timed word*.

Labeling function  $\ell$  is recursively extended to  $E^* \cup E^\omega \rightarrow \Sigma^* \cup \Sigma^\omega$  as  $\ell(e_1 e_2 \dots) = \ell(e_1)\ell(e_2) \dots$ . We also extend  $\ell$  as follows: for all  $(e, t) \in E \times T$ ,  $\ell((e, t)) = (\ell(e), t)$  if  $\ell(e) \neq \epsilon$ , and  $\ell((e, t)) = \epsilon$  otherwise. Hence  $\ell$  is also recursively extended to  $(E \times T)^* \cup (E \times T)^\omega \rightarrow (\Sigma \times T)^* \cup (\Sigma \times T)^\omega$ . For a weighted word  $\tau(\pi)$ , where  $\pi$  is a path of  $\mathcal{A}^{\mathfrak{M}}$ ,  $\ell(\tau(\pi))$  is called the *weighted label/output sequence* of both  $\pi$  and  $\tau(\pi)$ . We also extend the previously defined function  $\tau$  as follows: for all  $\gamma = (\sigma_1, t_1) \dots (\sigma_n, t_n) \in (\Sigma \times T)^*$ ,

$$\tau(\gamma) = (\sigma_1, t'_1) \dots (\sigma_n, t'_n), \quad (8)$$

where  $t'_j = \bigotimes_{i=1}^j t_i$  for all  $j \in \llbracket 1, n \rrbracket$ . Moreover,  $\tau$  is also extended to  $(\Sigma \times T)^\omega$  recursively.

The *weighted language*  $\mathcal{L}(\mathcal{A}^{\mathfrak{M}})$  and  $\omega$ -*weighted language*  $\mathcal{L}^\omega(\mathcal{A}^{\mathfrak{M}})$  generated by  $\mathcal{A}^{\mathfrak{M}}$  are defined by

$$\mathcal{L}(\mathcal{A}^{\mathfrak{M}}) := \{\gamma \in (\Sigma \times T)^* \mid (\exists w \in L(\mathcal{A}^{\mathfrak{M}}))[\ell(w) = \gamma]\} \quad (9)$$

and

$$\mathcal{L}^\omega(\mathcal{A}^{\mathfrak{M}}) := \{\gamma \in (\Sigma \times T)^\omega \mid (\exists w \in L^\omega(\mathcal{A}^{\mathfrak{M}}))[\ell(w) = \gamma]\}, \quad (10)$$

respectively. Particularly, we also call  $\mathcal{L}(\mathcal{A}^{\mathbb{Q}_{\geq 0}})$  and  $\mathcal{L}^\omega(\mathcal{A}^{\mathbb{Q}_{\geq 0}})$  *timed language* and  $\omega$ -*timed language*, respectively.

*Example 2* A labeled unambiguous weighted automaton  $\mathcal{A}_0^{\mathbb{N}}$  over semiring  $\mathbb{N}$  is shown in Fig. 3. Because  $\mathcal{A}_0^{\mathbb{N}}$  is unambiguous, it is the same as the labeled weighted automaton  $\mathcal{A}_0^{\mathbb{N}}$  over monoid  $(\mathbb{N}, +)$ ,  $\square$

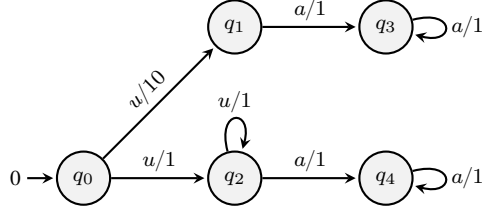

**Fig. 3** Labeled unambiguous weighted automaton  $\mathcal{A}_0^{\mathbb{N}}$  ( $\mathcal{A}_0^{\mathbb{N}}$ ) that is not divergence-free, where event  $u$  is unobservable (we denote  $\ell(u) = \epsilon$ ), event  $a$  is observable (we denote  $\ell(a) = a$ ).

*Example 3* Consider labeled weighted automaton  $\mathcal{A}_1^{\mathbb{N}}$  shown in Fig. 4, where only  $q_0$  is initial, event  $u$  is unobservable, events  $a$  and  $b$  are observable,  $\ell(a) = \ell(b) = \rho$ . Automaton  $\mathcal{A}_1^{\mathbb{N}}$  is ambiguous, because  $q_3$  can be reached from  $q_0$  through two paths  $q_0 \xrightarrow{a} q_1 \xrightarrow{b} q_3$  and  $q_0 \xrightarrow{a} q_2 \xrightarrow{b} q_3$  under the same event sequence  $ab$ .

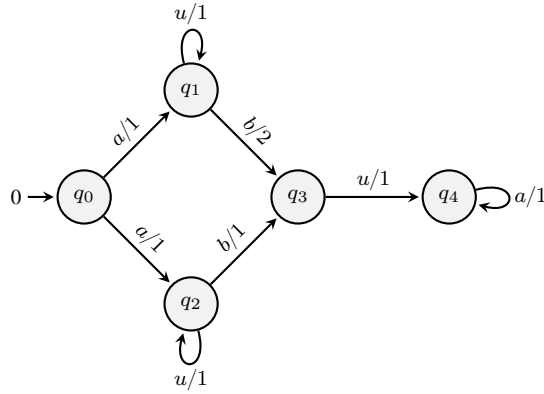

**Fig. 4** Labeled ambiguous weighted automaton  $\mathcal{A}_1^{\mathbb{N}}$ , where  $\ell(u) = \epsilon$ ,  $\ell(a) = \ell(b) = \rho$ .

Consider paths

$$\pi_1 = q_0 \xrightarrow{a} q_1 \xrightarrow{b} q_3, \quad \pi_2 = q_0 \xrightarrow{a} q_2 \xrightarrow{b} q_3, \quad (11a)$$

$$\pi_3 = q_0 \xrightarrow{a} q_1 \xrightarrow{u} q_1 \xrightarrow{b} q_3, \quad \pi_4 = q_0 \xrightarrow{a} q_2 \xrightarrow{u} q_2 \xrightarrow{b} q_3, \quad (11b)$$

$$\pi_5 = q_0 \xrightarrow{a} q_2 \xrightarrow{b} q_3 \xrightarrow{u} q_4, \quad (11c)$$

one then has

$$\tau(\pi_1) = (a, 1)(b, 3), \quad \ell(\tau(\pi_1)) = (\rho, 1)(\rho, 3), \quad (12a)$$

$$\tau(\pi_2) = (a, 1)(b, 2), \quad \ell(\tau(\pi_2)) = (\rho, 1)(\rho, 2), \quad (12b)$$

$$\tau(\pi_3) = (a, 1)(u, 2)(b, 4), \quad \ell(\tau(\pi_3)) = (\rho, 1)(\rho, 4), \quad (12c)$$

$$\tau(\pi_4) = (a, 1)(u, 2)(b, 3), \quad \ell(\tau(\pi_4)) = (\rho, 1)(\rho, 3), \quad (12d)$$

$$\tau(\pi_5) = (a, 1)(b, 2)(u, 3), \quad \ell(\tau(\pi_5)) = (\rho, 1)(\rho, 2). \quad (12e)$$

Path  $\pi_1$  has the following meaning:  $\mathcal{A}_1^{\mathbb{N}}$  starts at initial state  $q_0$ ; when event  $a$  occurs after time segment 1,  $\mathcal{A}_1^{\mathbb{N}}$  transitions to state  $q_1$ , we observe  $\rho$  at time instant 1; when event  $b$  occurs after time segment 2 since the occurrence of the previous event  $a$ ,  $\mathcal{A}_1^{\mathbb{N}}$  transitions to state  $q_3$ , and we observe  $\rho$  at time instant 3. The other paths have similar interpretations.  $\square$

### 3 Main results

#### 3.1 The definition of current-state estimate

For automaton  $\mathcal{A}^{\mathfrak{M}}$ , for  $\epsilon$ , we define the *instantaneous initial-state estimate* by

$$\mathcal{M}(\mathcal{A}^{\mathfrak{M}}, \epsilon) := Q_0 \cup \{q \in Q \mid (\exists q_0 \in Q_0)(\exists s \in (E_{uo})^+)(\exists \pi \in q_0 \xrightarrow{s} q) \\ [\tau(\pi) \in (E_{uo} \times \{\mathbf{1}\})^+]\}. \quad (13)$$

Analogously, for a subset  $x \subset Q$ , we define its *instantaneous-state estimate* by

$$\mathcal{M}(\mathcal{A}^{\mathfrak{M}}, \epsilon \mid x) := x \cup \{q \in Q \mid (\exists q' \in x)(\exists s \in (E_{uo})^+)(\exists \pi \in q' \xrightarrow{s} q) \\ [\tau(\pi) \in (E_{uo} \times \{\mathbf{1}\})^+]\}. \quad (14)$$

$\mathcal{M}(\mathcal{A}^{\mathfrak{M}}, \epsilon)$  denotes the set of states  $\mathcal{A}^{\mathfrak{M}}$  can be in at the initial time before any possible observable event occurs (note that an observable event may occur at the initial time when the event is in some instantaneous transition starting from some initial state), so we only consider unobservable, instantaneous paths, which is represented by  $\tau(\pi) \in (E_{uo} \times \{\mathbf{1}\})^+$ .

More generally, for  $\mathcal{A}^{\mathfrak{M}}$ , for weighted label/output sequence  $\gamma \in (\Sigma \times T)^+$ , we define the *current-state estimate* as

$$\mathcal{M}(\mathcal{A}^{\mathfrak{M}}, \gamma) := \{q \in Q \mid (\exists \text{ a path } q_0 \xrightarrow{s'} q' \xrightarrow{s} q) [ \\ (q_0 \in Q_0) \wedge (s' \in E^* E_o) \wedge (s \in (E_{uo})^*) \wedge \\ (\ell(\tau(q_0 \xrightarrow{s'} q')) = \gamma) \wedge (\tau(q' \xrightarrow{s} q) \in (E_{uo} \times \{\mathbf{1}\})^*)]\}. \quad (15)$$

Intuitively, for  $\gamma = (\sigma_1, t_1) \dots (\sigma_n, t_n) \in (\Sigma \times T)^+$ ,  $\mathcal{M}(\mathcal{A}^{\mathfrak{M}}, \gamma)$  denotes the set of states  $\mathcal{A}^{\mathfrak{M}}$  can be in when  $\gamma$  has just been generated by  $\mathcal{A}^{\mathfrak{M}}$ . Particularly for  $\mathcal{A}^{\mathbb{Q}_{\geq 0}}$ ,  $\mathcal{M}(\mathcal{A}^{\mathbb{Q}_{\geq 0}}, \gamma)$  denotes the set of states  $\mathcal{A}^{\mathbb{Q}_{\geq 0}}$  can be in when we just observe  $\gamma \in (\Sigma \times \mathbb{Q}_{\geq 0})^*$ . In order to fit the setting of current-state estimate, after the occurrence

of the last observable event (denoted by  $e_o$ ) in  $s'$  (i.e.,  $e_o$  occurs at the current time), we only allow unobservable, instantaneous paths, which is represented by  $\tau(q' \xrightarrow{s} q) \in (E_{uo} \times \{\mathbf{1}\})^*$ .

Analogously, for a subset  $x \subset Q$ , for a weighted label sequence  $\gamma \in (\Sigma \times T)^+$ , we define the current-state estimate when automaton  $\mathcal{A}^{\text{wt}}$  starts from some state of  $x$  by

$$\begin{aligned} \mathcal{M}(\mathcal{A}^{\text{wt}}, \gamma|x) := & \{q \in Q | (\exists \text{ a path } q_0 \xrightarrow{s'} q' \xrightarrow{s} q) [ \\ & (q_0 \in x) \wedge (s' \in E^* E_o) \wedge (s \in (E_{uo})^*) \wedge \\ & (\ell(\tau(q_0 \xrightarrow{s'} q')) = \gamma) \wedge (\tau(q' \xrightarrow{s} q) \in (E_{uo} \times \{\mathbf{1}\})^*)] \}. \end{aligned} \quad (16)$$

Then one directly sees that  $\mathcal{M}(\mathcal{A}^{\text{wt}}, \gamma) = \mathcal{M}(\mathcal{A}^{\text{wt}}, \gamma|Q_0)$  for all  $\gamma \in (\Sigma \times T)^*$ .

*Example 4* Reconsider automaton  $\mathcal{A}_1^{\mathbb{N}}$  in Fig. 4. By considering paths  $\pi_1, \dots, \pi_5$  in (11) and their timed words and timed label sequences in (12), we have

$$\mathcal{M}(\mathcal{A}_1^{\mathbb{N}}, (\rho, 1)(\rho, 2)) = \{q_3\}, \quad (17a)$$

$$\mathcal{M}(\mathcal{A}_1^{\mathbb{N}}, (\rho, 1)(\rho, 3)) = \{q_3\}. \quad (17b)$$

(17a) holds, because  $\pi_2, \pi_5$  are all the paths such that their timed label sequences are  $(\rho, 1)(\rho, 2)$ ; in  $\pi_2$ , once the last observable event  $b$  occurs,  $q_3$  is reached, so  $q_3$  in  $\pi_2$  is consistent with timed label sequence (i.e., observation)  $(\rho, 1)(\rho, 2)$ ; in  $\pi_5$ ,  $q_3$  is consistent with  $(\rho, 1)(\rho, 2)$  for the same reason, however,  $q_4$  is not consistent with  $(\rho, 1)(\rho, 2)$  because  $q_4$  is reached once  $u$  occurs, i.e., at instant 3. Nevertheless, if at instant 3 we observe nothing, we know that event  $u$  occurs and  $\mathcal{A}_1^{\mathbb{N}}$  transitions to state  $q_4$ . Similarly, (17b) holds.  $q_4$  is not consistent with  $(\rho, 1)(\rho, 3)$  because at instant 3,  $q_4$  can only be reached through path  $\pi_5$ , but at instant 3 one observes nothing.  $\square$

### 3.2 The definitions of detectability

In this subsection, we formulate the four fundamental notions of detectability.

**Definition 1 (SD)** A labeled weighted automaton  $\mathcal{A}^{\text{wt}}$  (3) is called *strongly detectable* if there is  $t \in \mathbb{Z}_+$ , for every  $\omega$ -weighted word  $w \in L^\omega(\mathcal{A}^{\text{wt}})$ , for each prefix  $\gamma$  of  $\ell(w)$ , if  $|\gamma| \geq t$ , then  $|\mathcal{M}(\mathcal{A}^{\text{wt}}, \gamma)| = 1$ .

**Definition 2 (SPD)** A labeled weighted automaton  $\mathcal{A}^{\text{wt}}$  (3) is called *strongly periodically detectable* if there is  $t \in \mathbb{Z}_+$ , for every  $\omega$ -weighted word  $w \in L^\omega(\mathcal{A}^{\text{wt}})$ , for every prefix  $w' \sqsubset w$ , there is  $w'' \in (E \times T)^*$  such that  $|\ell(w'w'')| < t$ ,  $w'w'' \sqsubset w$ , and  $|\mathcal{M}(\mathcal{A}^{\text{wt}}, \ell(w'w''))| = 1$ .

**Definition 3 (WD)** A labeled weighted automaton  $\mathcal{A}^{\text{wt}}$  (3) is called *weakly detectable* if  $L^\omega(\mathcal{A}^{\text{wt}}) \neq \emptyset$  implies that there is  $t \in \mathbb{Z}_+$ , for some  $\omega$ -weighted word  $w \in L^\omega(\mathcal{A}^{\text{wt}})$ , for each prefix  $\gamma$  of  $\ell(w)$ , if  $|\gamma| \geq t$ , then  $|\mathcal{M}(\mathcal{A}^{\text{wt}}, \gamma)| = 1$ .



**Definition 4 (WPD)** A labeled weighted automaton  $\mathcal{A}^{\text{m}}$  (3) is called *weakly periodically detectable* if  $L^\omega(\mathcal{A}^{\text{m}}) \neq \emptyset$  implies that there is  $t \in \mathbb{Z}_+$ , for some  $\omega$ -weighted word  $w \in L^\omega(\mathcal{A}^{\text{m}})$ , for each prefix  $w' \sqsubset w$ , there is  $w'' \in (E \times T)^*$  such that  $|\ell(w'')| < t$ ,  $w'w'' \sqsubset w$ , and  $|\mathcal{M}(\mathcal{A}^{\text{m}}, \ell(w'w''))| = 1$ .

Particularly, if  $\mathcal{A}^{\mathbb{Q}_{\geq 0}}$  is strongly (resp., weakly) detectable, then there exists  $t \in \mathbb{N}$ , along every (resp., some)  $\omega$ -timed word  $w \in L^\omega(\mathcal{A}^{\mathbb{Q}_{\geq 0}})$ , if we observe at least  $t$  outputs, we can determine the corresponding current state. If  $\mathcal{A}^{\mathbb{Q}_{\geq 0}}$  is strongly (resp., weakly) periodically detectable, then there exists  $t \in \mathbb{N}$ , along every (resp., some)  $\omega$ -timed word  $w \in L^\omega(\mathcal{A}^{\mathbb{Q}_{\geq 0}})$ , no matter how many outputs we have observed, we can determine the corresponding state after observing at most  $t$  outputs.

Strong detectability and strong periodic detectability are incomparable. Consider a labeled finite-state automaton  $\mathcal{A}_1$  that contains two states  $q_0$  and  $q_1$  which are both initial, and two transitions  $q_0 \xrightarrow{u} q_0$  and  $q_1 \xrightarrow{u} q_1$  with  $u$  unobservable.  $\mathcal{A}_1$  is strongly detectable vacuously, but not strongly periodically detectable by definition. Consider another labeled finite-state automaton  $\mathcal{A}_2$  that contains three states  $q_0, q_1, q_2$  such that only  $q_0$  is initial, the transitions of  $\mathcal{A}_2$  are  $q_0 \xrightarrow{a} q_1, q_0 \xrightarrow{a} q_2, q_1 \xrightarrow{b} q_0, q_2 \xrightarrow{b} q_0$ , where  $a$  and  $b$  are observable.  $\mathcal{A}_2$  is not strongly detectable but strongly periodically detectable also by definition. Particularly, if an automaton  $\mathcal{A}^{\text{m}}$  is deadlock-free (i.e., for each reachable state  $q$ , there exists a transition starting at  $q$ ) and divergence-free (i.e., there exists no reachable unobservable cycle)<sup>3</sup>, then strong detectability is stronger than strong periodic detectability. Weak detectability and weak periodic detectability also have similar relations.

Particularly for  $\mathcal{A}^{\mathbb{N}}$ , if we assume that every observable transition  $q \xrightarrow{e/\mu(e)_{qq'}} q'$  satisfies  $\mu(e)_{qq'} > 0$  (i.e.,  $\mu(e)_{qq'} \geq 1$ ), then there will be no two observable events occurring at the same time in one path. In this case, in Definition 1 and Definition 3,  $|\gamma| \geq k$  implies that the total time consumption is no less than  $k$  when  $\gamma$  has just been generated.

*Example 5* Reconsider the model in Example 1. In this model, if the pairs of energy levels and positions are considered as the states, signals  $a, u, b$  are considered as the events, where  $a, b$  are observable and  $u$  is unobservable, and the position deviations are considered as the weights of transitions, then the model can be regarded as a labeled weighted automaton over a monoid. In detail, the states are  $(i, P_j)$ ,  $i \in \llbracket 0, 10 \rrbracket$ ,  $j \in \llbracket 1, 4 \rrbracket$ , particularly if state  $(i, P_j)$  is initial, then it has an input arrow with weight  $P_j$ . The transitions are  $(i, P_k) \xrightarrow{a/P_{k+1}-P_k} (i-1, P_{k+1}), (i, P_2) \xrightarrow{u/P_3-P_2} (i-1, P_3), (i, P_2) \xrightarrow{u/P_3-P_2} (i, P_3), i \in \llbracket 1, 10 \rrbracket, k = 1, 3, (j, P_l) \xrightarrow{a/P_{l-1}-P_l} (j+1, P_{l-1}), (10, P_l) \xrightarrow{a/P_{l-1}-P_l} (10, P_{l-1}), j \in \llbracket 0, 9 \rrbracket, l \in \llbracket 2, 4 \rrbracket$ . The monoid is generated by  $\{P_1, \dots, P_4, P_{i+1} - P_i, P_i - P_{i+1} | i = 1, 2, 3\}$  under  $+$ , where  $P_1, \dots, P_4$  are considered as monomials. Assume  $(5, P_1)$  is the initial state, then the model becomes a labeled weighted automaton over the monoid which is weakly detectable (by, for

<sup>3</sup> The two conditions imply that at each reachable state, there exists an infinitely long path whose label sequence is also of infinite length.

example, infinite path  $(5, P_1) \xrightarrow{a/P_2 - P_1} (4, P_2) \xrightarrow{b/P_1 - P_2} (5, P_1)^\omega$  that produces  $\omega$ -weighted label sequence  $((a, P_2)(b, P_1)^\omega)$  but not strongly detectable (as shown in Table 1). Apparently, the model cannot be represented by a labeled timed automaton.  $\square$

### 3.3 The definition of concurrent composition

In order to give an equivalent condition for strong detectability, we define a notion of *concurrent composition* for a labeled weighted automaton  $\mathcal{A}^{\mathfrak{M}}$  and itself (i.e., the self-composition of  $\mathcal{A}^{\mathfrak{M}}$ ). This notion can be regarded as an extension of the notion of self-composition  $CC_A(\mathcal{A})$  of a labeled finite-state automaton  $\mathcal{A}$  proposed in [19, 15]. In [15],  $CC_A(\mathcal{A})$  is proposed to give a polynomial-time algorithm for verifying strong versions of detectability of  $\mathcal{A}$  without any assumption, removing two standard assumptions of deadlock-freeness and divergence-freeness used in [4, 13], etc. In [19],  $CC_A(\mathcal{A})$  and another tool called *bifurcation automaton* is used to verify a different variant of detectability called eventual strong detectability, which is strictly weaker than strong detectability even for labeled deterministic finite-state automata. In  $CC_A(\mathcal{A})$ , observable transitions of  $\mathcal{A}$  are synchronized and unobservable transitions of  $\mathcal{A}$  interleave. Differently, in order to define  $CC_A(\mathcal{A}^{\mathfrak{M}})$ , we need to consider both how to synchronize paths and how to synchronize weights of paths, where the difficulty lies in the latter.  $CC_A(\mathcal{A})$  can be computed in time polynomial in the size of  $\mathcal{A}$  (see Table 3). However, the case for  $\mathcal{A}^{\mathfrak{M}}$  is much more complicated. The computability of  $CC_A(\mathcal{A}^{\mathfrak{M}})$  heavily depends on  $\mathfrak{M}$ . For example, generally  $CC_A(\mathcal{A}^{\mathbb{R}})$  is uncomputable. Particularly, we will show that  $CC_A(\mathcal{A}^{\mathbb{Q}^k})$  is computable in time nondeterministically polynomial in the size of  $\mathcal{A}^{\mathbb{Q}^k}$  (in Section 3.7.1), by connecting  $\mathcal{A}^{\mathbb{Q}^k}$  with the EPL problem (Problem 1), and generally it is unlikely that the time consumption can be reduced, although the size of  $CC_A(\mathcal{A}^{\mathbb{Q}^k})$  is polynomial in the size of  $\mathcal{A}^{\mathbb{Q}^k}$ .

**Definition 5** Consider a labeled weighted automaton  $\mathcal{A}^{\mathfrak{M}}$  (3). We define its *self-composition* by a labeled finite-state automaton

$$CC_A(\mathcal{A}^{\mathfrak{M}}) = (Q', E', Q'_0, \delta', \Sigma, \ell'), \quad (18)$$

where  $Q' = Q \times Q$ ;  $E' = \{(e_1, e_2) \in E_o \times E_o \mid \ell(e_1) = \ell(e_2)\}$ ;  $Q'_0 = Q_0 \times Q_0$ ;  $\delta' \subset Q' \times E' \times Q'$  is the transition relation, for all states  $(q_1, q_2), (q_3, q_4) \in Q'$  and events  $(e_1, e_2) \in E'$ ,  $((q_1, q_2), (e_1, e_2), (q_3, q_4)) \in \delta'$  if and only if in  $\mathcal{A}^{\mathfrak{M}}$ , there exist states  $q_5, q_6, q_7, q_8 \in Q$ , event sequences  $s_1, s_2, s_3, s_4 \in (E_{uo})^*$ , and paths

$$\begin{aligned} \pi_1 &:= q_1 \xrightarrow{s_1} q_5 \xrightarrow{e_1} q_7 \xrightarrow{s_3} q_3, \\ \pi_2 &:= q_2 \xrightarrow{s_2} q_6 \xrightarrow{e_2} q_8 \xrightarrow{s_4} q_4, \end{aligned} \quad (19)$$

such that  $\tau(q_1 \xrightarrow{s_1} q_5 \xrightarrow{e_1} q_7) = w_1(e_1, t_1)$ ,  $\tau(q_2 \xrightarrow{s_2} q_6 \xrightarrow{e_2} q_8) = w_2(e_2, t_2)$ ,  $w_1, w_2 \in (E_{uo} \times T)^*$ ,  $t_1 = t_2 \in T$ ,  $q_7 \xrightarrow{s_3} q_3$  and  $q_8 \xrightarrow{s_4} q_4$  are instantaneous; for all

$(e_1, e_2) \in E'$ ,  $\ell'((e_1, e_2)) = \ell(e_1)$ , and  $\ell'$  is recursively extended to  $(E')^* \cup (E')^\omega \rightarrow \Sigma^* \cup \Sigma^\omega$ . For a state  $q'$  of  $CC_A(\mathcal{A}^{\mathfrak{M}})$ , we write  $q' = (q'(L), q'(R))$ , where “ $L$ ” and “ $R$ ” denote “left” and “right”, respectively.

Intuitively, there is a transition  $(q_1, q_2) \xrightarrow{(e_1, e_2)} (q_3, q_4)$  in  $CC_A(\mathcal{A}^{\mathbb{Q}_{\geq 0}})$  if and only if in  $\mathcal{A}^{\mathbb{Q}_{\geq 0}}$ , starting from  $q_1$  and  $q_2$  at the same time, after some common time delay,  $e_1$  and  $e_2$  occur as the unique observable events, state  $q_1$  and  $q_2$  can transition to  $q_3$  and  $q_4$ , respectively. Since we consider an observation at exactly the instant when the observable events  $e_1, e_2$  occur, we only consider unobservable, instantaneous paths after the occurrences of  $e_1, e_2$  (see (19)). See the following example. Whenever we draw  $CC_A(\mathcal{A}^{\mathbb{Q}^k})$  for some given  $\mathcal{A}^{\mathbb{Q}^k}$ , we only draw reachable states and transitions.

*Example 6* Reconsider labeled weighted automaton  $\mathcal{A}_1^{\mathbb{N}}$  in Fig. 4. Its self-composition  $CC_A(\mathcal{A}_1^{\mathbb{N}})$  is depicted in Fig. 5.  $(q_1, q_2) \xrightarrow{(b, b)} (q_3, q_3)$  is a transition of  $CC_A(\mathcal{A}_1^{\mathbb{N}})$  because we have two paths  $q_1 \xrightarrow{b} q_3 = \pi_1$  and  $q_2 \xrightarrow{u} q_2 \xrightarrow{b} q_3 = \pi_2$  such that  $\tau(\pi_1) = (b, 2) = \tau(\pi_2)$ .

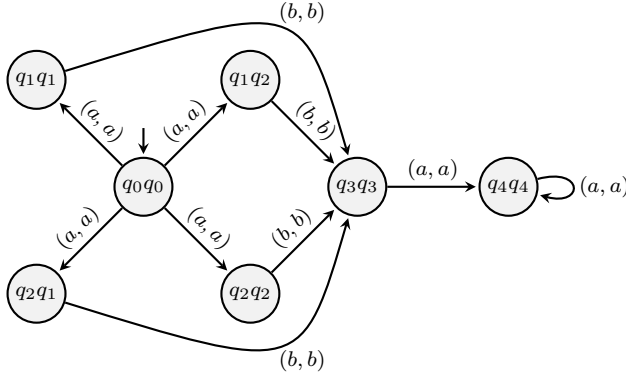

Fig. 5 Self-composition  $CC_A(\mathcal{A}_1^{\mathbb{N}})$  of automaton  $\mathcal{A}_1^{\mathbb{N}}$  in Fig. 4.

□

### 3.4 The definition of observer

We next define a notion of *observer* to concatenate current-state estimates along weighted label sequences. Later, we will use the notion of observer to give equivalent conditions for weak detectability and weak periodic detectability of labeled weighted automaton  $\mathcal{A}^{\mathfrak{M}}$ . An observer  $\mathcal{A}_{obs}^{\mathfrak{M}}$  of  $\mathcal{A}^{\mathfrak{M}}$  is a natural but nontrivial extension of the observer  $\mathcal{A}_{obs}$  of labeled finite-state automaton  $\mathcal{A}$  proposed in [4]. Since in automaton  $\mathcal{A}$ , no weights need be considered, its observer  $\mathcal{A}_{obs}$  can be computed

by directly concatenating the current-state estimates along label sequences, so  $\mathcal{A}_{obs}$  can be computed in exponential time. However,  $\mathcal{A}_{obs}^{\mathfrak{M}}$  is much more complicated, because when we concatenate current-state estimates along weighted label sequences, we must additionally consider how to synchronize weights. In order to define observer  $\mathcal{A}_{obs}^{\mathfrak{M}}$  that is a finite automaton, we need to define a more general notion of *pre-observer*  ${}^{pre}\mathcal{A}_{obs}^{\mathfrak{M}}$  that can be regarded a deterministic automaton, in which there may exist infinitely mainly events, because the events of  ${}^{pre}\mathcal{A}_{obs}^{\mathfrak{M}}$  are pairs of events of  $\mathcal{A}^{\mathfrak{M}}$  and weights chosen from  $\mathfrak{M}$ , and  $\mathfrak{M}$  may be of infinite cardinality.  $\mathcal{A}_{obs}^{\mathfrak{M}}$  is a reduced version of  ${}^{pre}\mathcal{A}_{obs}^{\mathfrak{M}}$ . The computability of  $\mathcal{A}_{obs}^{\mathfrak{M}}$  depends on  $\mathfrak{M}$ . Generally,  $\mathcal{A}_{obs}^{\mathbb{R}}$  is uncomputable. Despite of this difficulty, particularly for automaton  $\mathcal{A}^{\mathbb{Q}^k}$ , we will prove that  $\mathcal{A}_{obs}^{\mathbb{Q}^k}$  can be computed in 2-EXPTIME in the size of  $\mathcal{A}^{\mathbb{Q}^k}$  (Section 3.7.2), which shows an essential difference between labeled finite-state automata and labeled weighted automata over monoids.

**Definition 6** For labeled weighted automaton  $\mathcal{A}^{\mathfrak{M}}$ , we define its *pre-observer* as a deterministic automaton

$${}^{pre}\mathcal{A}_{obs}^{\mathfrak{M}} = (X, \Sigma \times T, x_0, \bar{\delta}_{obs}), \quad (20)$$

where  $X \subset 2^Q \setminus \{\emptyset\}$  is the state set,  $\Sigma \times T$  the alphabet,  $x_0 = \mathcal{M}(\mathcal{A}^{\mathfrak{M}}, \epsilon) \in X$  the unique initial state,  $\bar{\delta}_{obs} \subset X \times (\Sigma \times T) \times X$  the transition relation. Note that  $\Sigma \times T$  may be infinite. For all  $x \subset Q$  different from  $x_0$ ,  $x \in X$  if and only if there is  $\gamma \in (\Sigma \times T)^+$  such that  $x = \mathcal{M}(\mathcal{A}^{\mathfrak{M}}, \gamma)$ . For all  $x, x' \in X$  and  $(\sigma, t) \in \Sigma \times T$ ,  $(x, (\sigma, t), x') \in \bar{\delta}_{obs}$  if and only if  $x' = \mathcal{M}(\mathcal{A}^{\mathfrak{M}}, (\sigma, t)|x)$  (defined in (16)).

In Definition 6, after  $\bar{\delta}_{obs}$  is recursively extended to  $\bar{\delta}_{obs} \subset X \times (\Sigma \times T)^* \times X$  as usual, one has for all  $x \in X$  and  $(\sigma_1, t_1) \dots (\sigma_n, t_n) =: \gamma \in (\Sigma \times T)^+$ ,  $(x_0, \gamma, x) \in \bar{\delta}_{obs}$  if and only if  $\mathcal{M}(\mathcal{A}^{\mathfrak{M}}, \tau(\gamma)) = x$ , where  $\tau(\gamma)$  is defined in (8).

On the other hand, the alphabet  $\Sigma \times T$  may not be finite, so generally we cannot compute the whole  ${}^{pre}\mathcal{A}_{obs}^{\mathfrak{M}}$ . However, in order to study weak detectability and weak periodic detectability, it is enough to consider a subautomaton of  ${}^{pre}\mathcal{A}_{obs}^{\mathfrak{M}}$  with finitely many events.

**Definition 7** For labeled weighted automaton  $\mathcal{A}^{\mathfrak{M}}$ , we define its *observers* as deterministic finite automata

$$\mathcal{A}_{obs}^{\mathfrak{M}} = (X, \Sigma_{obs}^T, x_0, \delta_{obs}), \quad (21)$$

which are subautomata of its pre-observer  ${}^{pre}\mathcal{A}_{obs}^{\mathfrak{M}}$ , where  $\Sigma_{obs}^T$  is a finite subset of  $\Sigma \times T$ ,  $\delta_{obs} \subset X \times \Sigma_{obs}^T \times X$  is such that if there is a transition from  $x \in X$  to  $x' \in X$  in  $\bar{\delta}_{obs}$  then at least one transition from  $x$  to  $x'$  in  $\bar{\delta}_{obs}$  belongs to  $\delta_{obs}$ .

Note that a given automaton  $\mathcal{A}^{\mathfrak{M}}$  may have more than one observer.

*Example 7* Reconsider automaton  $\mathcal{A}_1^{\mathbb{N}}$  in Fig. 4. Its pre-observer  ${}^{pre}\mathcal{A}_{1obs}^{\mathbb{N}}$  is shown in Fig. 6. From the pre-observer, one sees that for all  $n \in \mathbb{Z}_+$ ,  $(\{q_1, q_2\}, (\rho, n), \{q_3\})$  are

transitions. Hence there exist infinitely many transitions. However, there exist finitely many states. In order to obtain one of its observers, one only need replace  $(\rho, \mathbb{Z}_+)$  by  $(\rho, 1)$ .

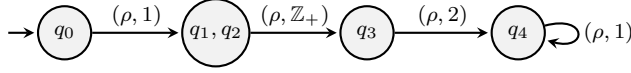

**Fig. 6** Pre-observer  ${}^{pre}\mathcal{A}_{1obs}^{\mathbb{N}}$  of automaton  $\mathcal{A}_1^{\mathbb{N}}$  in Fig. 4, where  $(\rho, \mathbb{Z}_+)$  means that the events can be  $(\rho, n)$  for any  $n \in \mathbb{Z}_+$ .

□

### 3.5 The definition of detector

In order to give an equivalent condition for strong periodic detectability, we define a notion of *detector*  $\mathcal{A}_{det}^{\mathfrak{M}}$  (a nondeterministic finite automaton) for labeled weighted automaton  $\mathcal{A}^{\mathfrak{M}}$ , which can be regarded as a simplified version of observer  $\mathcal{A}_{obs}^{\mathfrak{M}}$  (21). Detector  $\mathcal{A}_{det}^{\mathfrak{M}}$  can be regarded as a nontrivial extension of the detector  $\mathcal{A}_{det}$  of labeled finite-state automaton  $\mathcal{A}$  proposed in [13]. In order to define  $\mathcal{A}_{det}^{\mathfrak{M}}$ , we must additionally consider how to synchronize weights of paths. Moreover, we also need to define a more general notion of *pre-detector*  ${}^{pre}\mathcal{A}_{det}^{\mathfrak{M}}$  (similar to pre-observer  ${}^{pre}\mathcal{A}_{obs}^{\mathfrak{M}}$ ), in which there may exist infinitely many events. The detector  $\mathcal{A}_{det}$  of  $\mathcal{A}$  can be computed in time polynomial in the size of  $\mathcal{A}$ . However, the computability of detector  $\mathcal{A}_{det}^{\mathfrak{M}}$  still depends on  $\mathfrak{M}$ . Particularly we will prove that  $\mathcal{A}_{det}^{\mathbb{Q}^k}$  can be computed in 2-EXPTIME in the size of  $\mathcal{A}^{\mathbb{Q}^k}$  (Section 3.7.3), although the size of  $\mathcal{A}_{det}^{\mathbb{Q}^k}$  is polynomial in the size of  $\mathcal{A}^{\mathbb{Q}^k}$ , and for  $\mathcal{A}^{\mathbb{Q}^k}$  in which from each state, a distinct state can be reached through some unobservable, instantaneous path, detector  $\mathcal{A}_{det}^{\mathbb{Q}^k}$  can be computed in NP.

**Definition 8** For labeled weighted automaton  $\mathcal{A}^{\mathfrak{M}}$ , we define its *pre-detector* as an automaton

$${}^{pre}\mathcal{A}_{det}^{\mathfrak{M}} = (X, \Sigma \times T, x_0, \bar{\delta}_{det}), \quad (22)$$

where  $X = \{x_0\} \cup \{x \subset Q \mid 1 \leq |x| \leq 2\}$  is the state set,  $\Sigma \times T$  the alphabet,  $x_0 = \mathcal{M}(\mathcal{A}^{\mathfrak{M}}, \epsilon)$  the unique initial state,  $\bar{\delta}_{det} \subset X \times (\Sigma \times T) \times X$  the transition relation. For all  $x \in X$  and  $(\sigma, t) \in \Sigma \times T$ ,  $(x, (\sigma, t), \mathcal{M}(\mathcal{A}^{\mathfrak{M}}, (\sigma, t)|x)) \in \bar{\delta}_{det}$  if  $|\mathcal{M}(\mathcal{A}^{\mathfrak{M}}, (\sigma, t)|x)| = 1$ ;  $(x, (\sigma, t), x') \in \bar{\delta}_{det}$  for all  $x' \subset \mathcal{M}(\mathcal{A}^{\mathfrak{M}}, (\sigma, t)|x)$  satisfying  $|x'| = 2$  if  $|\mathcal{M}(\mathcal{A}^{\mathfrak{M}}, (\sigma, t)|x)| \geq 2$ , where  $\mathcal{M}(\mathcal{A}^{\mathfrak{M}}, (\sigma, t)|x)$  is the current-state estimate when  $\mathcal{A}^{\mathfrak{M}}$  starts from some state of  $x$  (defined in (16)).

Similarly to verifying weak (periodic) detectability, in order to verify strong periodic detectability, it is enough to consider a finite subautomaton of pre-detector  ${}^{pre}\mathcal{A}_{det}^{\mathfrak{M}}$  with finitely many events.

**Definition 9** For labeled weighted automaton  $\mathcal{A}^{\mathfrak{M}}$ , we define its *detectors* as non-deterministic finite automata

$$\mathcal{A}_{det}^{\mathfrak{M}} = (X, \Sigma_{det}^T, x_0, \delta_{det}), \quad (23)$$

which are subautomata of its pre-detector  ${}^{pre}\mathcal{A}_{det}^{\mathfrak{M}}$ , where  $\Sigma_{det}^T$  is a finite subset of  $\Sigma \times T$ ,  $\delta_{det} \subset X \times \Sigma_{det}^T \times X$  is such that if there exists a transition from  $x \in X$  to  $x' \in X$  in  $\bar{\delta}_{det}$  then at least one transition from  $x$  to  $x'$  in  $\bar{\delta}_{det}$  belongs to  $\delta_{det}$ .

*Example 8* Reconsider automaton  $\mathcal{A}_1^{\mathbb{N}}$  in Fig. 4. Its pre-detector  ${}^{pre}\mathcal{A}_{1det}^{\mathbb{N}}$  is also shown in Fig. 6. That is, its pre-observer is the same as its pre-detector. In order to obtain one of its detectors, one also only need replace  $(b, \mathbb{Z}_+)$  by  $(b, 1)$ .  $\square$

For the relationship between observer  $\mathcal{A}_{obs}^{\mathfrak{M}}$  and detector  $\mathcal{A}_{det}^{\mathfrak{M}}$ , we have the following lemma.

**Lemma 4** Consider a labeled weighted automaton  $\mathcal{A}^{\mathfrak{M}}$ , any observer  $\mathcal{A}_{obs}^{\mathfrak{M}}$  (21), and any detector  $\mathcal{A}_{det}^{\mathfrak{M}}$  (23), such that  $\mathcal{A}_{obs}^{\mathfrak{M}}$  and  $\mathcal{A}_{det}^{\mathfrak{M}}$  have the same event set. For every transition  $(x, (\sigma, t), x') \in \delta_{obs}$ , for every  $\bar{x}' \subset x'$  satisfying  $|\bar{x}'| = 2$  if  $|x'| \geq 2$  and  $|\bar{x}'| = 1$  otherwise, there is  $\bar{x} \subset x$  such that (1)  $|\bar{x}| = 2$  and  $(\bar{x}, (\sigma, t), \bar{x}') \in \delta_{det}$  if  $|x| > 1$  and (2)  $|\bar{x}| = 1$  and  $(\bar{x}, (\sigma, t), \bar{x}') \in \delta_{det}$  if  $|x| = 1$ .

**Proof** We only need to prove the case  $|x| \geq 2$  and  $|x'| \geq 2$ , the other cases hold similarly. Arbitrarily choose  $\{q_1, q_2\} = \bar{x}' \subset x'$  such that  $q_1 \neq q_2$ . By definition, there exist  $q_3, q'_3, q_4, q_5 \in Q$ ,  $e_1, e_2 \in E_o$ ,  $s_1, s_2, s_3, s_4 \in (E_{uo})^*$ , and paths

$$\begin{aligned} q_3 &\xrightarrow{s_1 e_1} q_4 \xrightarrow{s_3} q_1, \\ q'_3 &\xrightarrow{s_2 e_2} q_5 \xrightarrow{s_4} q_2 \end{aligned}$$

such that  $\ell(e_1) = \ell(e_2) = \sigma$ , the weights of paths  $q_3 \xrightarrow{s_1 e_1} q_4$  and  $q'_3 \xrightarrow{s_2 e_2} q_5$  are both equal to  $t$ , and paths  $q_4 \xrightarrow{s_3} q_1$  and  $q_5 \xrightarrow{s_4} q_2$  are unobservable and instantaneous. If  $q_3 = q'_3$ , we choose  $\bar{x} = \{q_3, q_6\}$ , where  $q_6 \in x \setminus \{q_3\}$ ; otherwise, we choose  $\bar{x} = \{q_3, q'_3\}$ . Then by definition, one has  $(\bar{x}, (\sigma, t), \bar{x}') \in \delta_{det}$ .  $\square$

### 3.6 Equivalent conditions for detectability of labeled weighted automata over monoids

In this subsection, we give equivalent conditions for the four notions of detectability of labeled weighted automata over monoids by using the notions of self-composition, observer, and detector.

### 3.6.1 For strong detectability:

We use the notion of self-composition to give an equivalent condition for strong detectability of labeled weighted automata over monoids.

**Theorem 1** *A labeled weighted automaton  $\mathcal{A}^{\text{m}}$  (3) is not strongly detectable if and only if in its self-composition  $\text{CC}_A(\mathcal{A}^{\text{m}})$  (18),*

(i) *there exists a transition sequence*

$$q'_0 \xrightarrow{s'_1} q'_1 \xrightarrow{s'_2} q'_1 \xrightarrow{s'_3} q'_2 \quad (24)$$

*satisfying*

$$q'_0 \in Q'_0; q'_1, q'_2 \in Q'; s'_1, s'_2, s'_3 \in (E')^+; q'_2(L) \neq q'_2(R); \quad (25)$$

(ii) *and in  $\mathcal{A}^{\text{m}}$ , there exists a cycle reachable from  $q'_2(L)$ .*

**Proof** By Definition 1,  $\mathcal{A}^{\text{m}}$  is not strongly detectable if and only if for all  $k \in \mathbb{Z}_+$ , there exist  $w_k \in L^\omega(\mathcal{A}^{\text{m}})$  and  $\gamma \sqsubset \ell(w_k)$ , such that  $|\gamma| \geq k$  and  $|\mathcal{M}(\mathcal{A}^{\text{m}}, \gamma)| > 1$ .

“if”: Arbitrarily given  $k \in \mathbb{Z}_+$ , consider  $q'_0 \xrightarrow{s'_1} q'_1 \xrightarrow{(s'_2)^k} q'_1 \xrightarrow{s'_3} q'_2$ , then by (25), in  $\mathcal{A}^{\text{m}}$  there exists a path  $q'_0(L) \xrightarrow{\bar{s}_1} q'_1(L) \xrightarrow{\bar{s}_2} q'_1(L) \xrightarrow{\bar{s}_3} q'_2(L) =: \pi_L$  such that  $\ell(\bar{s}_1) = \ell'(s'_1)$ ,  $\ell(\bar{s}_2) = \ell'((s'_2)^k)$ ,  $\ell(\bar{s}_3) = \ell'(s'_3)$ , and  $\mathcal{M}(\mathcal{A}^{\text{m}}, \gamma) \supset \{q'_2(L), q'_2(R)\}$ , where  $\gamma = \ell(\tau(\pi_L))$ ; by (ii), there also exists a path  $q'_2(L) \xrightarrow{\bar{s}_4} q_3 \xrightarrow{\bar{s}_5} q_3$ , where  $\bar{s}_5 \in E^+$ . Note that  $q_3 \xrightarrow{\bar{s}_5} q_3$  can be repeated for infinitely many times. Choose

$$w_k = \tau \left( q'_0(L) \xrightarrow{\bar{s}_1} q'_1(L) \xrightarrow{\bar{s}_2} q'_1(L) \xrightarrow{\bar{s}_3} q'_2(L) \xrightarrow{\bar{s}_4} q_3 \left( \xrightarrow{\bar{s}_5} q_3 \right)^\omega \right),$$

one has  $w_k \in L^\omega(\mathcal{A}^{\text{m}})$ ,  $\gamma \sqsubset \ell(w_k)$  satisfies  $|\gamma| \geq k + 2$ , and  $|\mathcal{M}(\mathcal{A}^{\text{m}}, \gamma)| > 1$ . That is,  $\mathcal{A}^{\text{m}}$  is not strongly detectable.

“only if”: Assume that  $\mathcal{A}^{\text{m}}$  is not strongly detectable. Choose  $k > |Q|^2$ ,  $w_k \in L^\omega(\mathcal{A}^{\text{m}})$ , and  $\gamma \sqsubset \ell(w_k)$  such that  $|\gamma| \geq k$  and  $|\mathcal{M}(\mathcal{A}^{\text{m}}, \gamma)| > 1$ . Then there exist two different paths  $\pi_1$  and  $\pi_2$  starting at initial states and ending at different states such that  $\tau(\pi_1) = \tau(\pi_2) \sqsubset w_k$ , and after the last observable events of  $\pi_1$  and  $\pi_2$ , all transitions are unobservable and instantaneous. By definition of  $\text{CC}_A(\mathcal{A}^{\text{m}})$ , from  $\pi_1$  and  $\pi_2$  one can construct a transition sequence of  $\text{CC}_A(\mathcal{A}^{\text{m}})$  as in (24) by the Pigeonhole Principle, because  $\text{CC}_A(\mathcal{A}^{\text{m}})$  has at most  $|Q|^2$  states. On the other hand, because  $\mathcal{A}^{\text{m}}$  has finitely many states, (ii) holds.  $\square$

### 3.6.2 For strong periodic detectability:

We first use the notion of observer to give an equivalent condition for strong periodic detectability of labeled weighted automata, and furthermore represent the equivalent condition in terms of the notion of detector.

**Theorem 2** A labeled weighted automaton  $\mathcal{A}^{\text{m}}$  (3) is not strongly periodically detectable if and only if in any observer  $\mathcal{A}_{\text{obs}}^{\text{m}}$  (21), at least one of the two following conditions holds.

- (i) There is a reachable state  $x \in X$  such that  $|x| > 1$  and there exists a path  $q \xrightarrow{s_1} q' \xrightarrow{s_2} q'$  in  $\mathcal{A}^{\text{m}}$ , where  $q \in x$ ,  $s_1 \in (E_{uo})^*$ ,  $s_2 \in (E_{uo})^+$ ,  $q' \in Q$ .
- (ii) There is a reachable cycle in  $\mathcal{A}_{\text{obs}}^{\text{m}}$  such that no state in the cycle is a singleton.

**Proof** By Definition 2,  $\mathcal{A}^{\text{m}}$  is not strongly periodically detectable if and only for all  $k \in \mathbb{Z}_+$ , there is an  $\omega$ -weighted word  $w_k \in L^\omega(\mathcal{A}^{\text{m}})$  and a prefix  $w' \sqsubset w_k$  such that for all  $w'' \in (E \times T)^*$  satisfying  $|\ell(w'w'')| < k$  and  $w'w'' \sqsubset w_k$ , one has  $|\mathcal{M}(\mathcal{A}^{\text{m}}, \ell(w'w''))| > 1$ .

“if”: Assume (i) holds. Then there exists a path  $q_0 \xrightarrow{s_\gamma} q \xrightarrow{s_1} q' \xrightarrow{s_2} q'$  in  $\mathcal{A}^{\text{m}}$  such that  $q_0 \in Q_0$  and  $\mathcal{M}(\mathcal{A}^{\text{m}}, \ell(\tau(q_0 \xrightarrow{s_\gamma} q))) = x$ . Denote  $\tau(q_0 \xrightarrow{s_\gamma} q) =: w_1 \in L(\mathcal{A}^{\text{m}})$  and  $\tau(q_0 \xrightarrow{s_\gamma} q \xrightarrow{s_1} q' \xrightarrow{s_2} q')^\omega =: w_1w_2 \in L^\omega(\mathcal{A}^{\text{m}})$ , then for every  $w \sqsubset w_2$ , one has  $\ell(w) = \epsilon$  and  $|\mathcal{M}(\mathcal{A}^{\text{m}}, \ell(w_1w))| = |\mathcal{M}(\mathcal{A}^{\text{m}}, \ell(w_1))| > 1$ , which violates strong periodic detectability by definition.

Assume (ii) holds. That is, there exist  $\alpha \in (\Sigma \times T)^*$ ,  $\beta \in (\Sigma \times T)^+$  such that  $(x_0, \alpha, x), (x, \beta, x) \in \delta_{\text{obs}}$  for some  $x \in X$  satisfying  $|x| > 1$ ,  $\mathcal{M}(\mathcal{A}^{\text{m}}, \tau(\alpha)) = \mathcal{M}(\mathcal{A}^{\text{m}}, \tau(\alpha\beta)) = x$ , and for all  $\beta' \sqsubset \beta$ ,  $|\mathcal{M}(\mathcal{A}^{\text{m}}, \tau(\alpha\beta'))| > 1$ . Then  $\tau(\alpha\beta^\omega) \in \mathcal{L}^\omega(\mathcal{A}^{\text{m}})$ . Choose  $w_\alpha w_\beta \in L^\omega(\mathcal{A}^{\text{m}})$  such that  $\ell(w_\alpha) = \tau(\alpha)$  and  $\ell(w_\alpha w_\beta) = \tau(\alpha\beta^\omega)$ , then for every  $w'_\beta \sqsubset w_\beta$ , one has  $|\mathcal{M}(\mathcal{A}^{\text{m}}, \ell(w_\alpha w'_\beta))| > 1$ , which also violates strong periodic detectability.

“only if”: Assume  $\mathcal{A}^{\text{m}}$  is not strongly periodically detectable and (ii) does not hold, next we prove (i) holds.

Since  $\mathcal{A}^{\text{m}}$  is not strongly periodically detectable, by definition, choose integer  $k > |2^Q|$ ,  $w_k \in L^\omega(\mathcal{A}^{\text{m}})$ , and prefix  $w' \sqsubset w_k$  such that for all  $w'' \in (\Sigma \times T)^*$ ,  $w'w'' \sqsubset w_k$  and  $|\ell(w'w'')| < k$  imply  $|\mathcal{M}(\mathcal{A}^{\text{m}}, \ell(w'w''))| > 1$ . Since (ii) does not hold, one has  $\ell(w_k) \in (\Sigma \times T)^*$  and  $|\ell(w_k)| < k + |\ell(w')|$ . Otherwise if  $|\ell(w_k)| \geq k + |\ell(w')|$  or  $\ell(w_k) \in (\Sigma \times T)^\omega$ , we can choose  $\bar{w}''$  such that  $w'\bar{w}'' \sqsubset w_k$  and  $|\ell(\bar{w}'')| = k$ , then by the Pigeonhole Principle, there exist  $\bar{w}''_1, \bar{w}''_2 \sqsubset \bar{w}''$  such that  $|\ell(\bar{w}''_1)| < |\ell(\bar{w}''_2)|$  and  $\mathcal{M}(\mathcal{A}^{\text{m}}, \ell(w'\bar{w}''_1)) = \mathcal{M}(\mathcal{A}^{\text{m}}, \ell(w'\bar{w}''_2))$ , that is, there is a reachable cycle in pre-observer  ${}^{\text{pre}}\mathcal{A}_{\text{obs}}^{\text{m}}$  such that no state in the cycle is a singleton, then by definition, (ii) holds. Then  $w_k = w'\hat{w}''_1\hat{w}''_2$ , where  $\hat{w}''_1 \in (E \times T)^*$ ,  $\hat{w}''_2 \in (E_{uo} \times T)^\omega$ . Moreover, one has  $|\mathcal{M}(\mathcal{A}^{\text{m}}, \ell(w'\hat{w}''_1))| > 1$ , and also by the Pigeonhole Principle there exists a path  $q_0 \xrightarrow{w'\hat{w}''_1} q \xrightarrow{\hat{w}''_1} q' \xrightarrow{\hat{w}''_2} q'$  for some  $q_0 \in Q_0$ ,  $q, q' \in Q$ ,  $\hat{w}''_1 \in (E_{uo})^*$ , and  $\hat{w}''_2 \in (E_{uo})^+$ , i.e.,  $\mathcal{M}(\mathcal{A}^{\text{m}}, \ell(w'\hat{w}''_1))$  is a reachable state of pre-observer  ${}^{\text{pre}}\mathcal{A}_{\text{obs}}^{\text{m}}$  such that  $|\mathcal{M}(\mathcal{A}^{\text{m}}, \ell(w'\hat{w}''_1))| > 1$  and  $q \in \mathcal{M}(\mathcal{A}^{\text{m}}, \ell(w'\hat{w}''_1))$ . By definition,  $\mathcal{M}(\mathcal{A}^{\text{m}}, \ell(w'\hat{w}''_1))$  is also a reachable state of observer  $\mathcal{A}_{\text{obs}}^{\text{m}}$ , then (i) holds.  $\square$

**Theorem 3** A labeled weighted automaton  $\mathcal{A}^{\text{m}}$  (3) is not strongly periodically detectable if and only if in any detector  $\mathcal{A}_{\text{det}}^{\text{m}}$  (23), at least one of the two following conditions holds.



- (1) There is a reachable state  $x' \in X$  such that  $|x'| > 1$  and there exists a path  $q \xrightarrow{s_1} q' \xrightarrow{s_2} q'$  in  $\mathcal{A}_{det}^{\mathfrak{M}}$ , where  $q \in x'$ ,  $s_1 \in (E_{uo})^*$ ,  $s_2 \in (E_{uo})^+$ ,  $q' \in Q$ .
- (2) There is a reachable cycle in  $\mathcal{A}_{det}^{\mathfrak{M}}$  such that all states in the cycle have cardinality 2.

**Proof** We use Theorem 2 to prove this result.

We firstly prove (1) of this theorem is equivalent to (i) of Theorem 2.

“(1) $\Rightarrow$ (i)”: Assume (1) holds. In  $\mathcal{A}_{det}^{\mathfrak{M}}$ , choose a transition sequence  $x_0 \xrightarrow{\alpha} x'$ . Then one has  $x' \subset x$ , where  $(x_0, \alpha, x) \in \delta_{obs}$ , hence (i) of Theorem 2 holds.

“(1) $\Leftarrow$ (i)”: Assume (i) holds. In  $\mathcal{A}_{obs}^{\mathfrak{M}}$ , choose a transition sequence  $x_0 \xrightarrow{\alpha} x$ . By Lemma 4, moving backward on  $x_0 \xrightarrow{\alpha} x$  from  $x$  to  $x_0$ , we can obtain a transition sequence  $x_0 \xrightarrow{\alpha} x'$  of  $\mathcal{A}_{det}^{\mathfrak{M}}$  such that  $q \in x' \subset x$ , hence (1) of this theorem holds.

We secondly prove (2) of this theorem is equivalent to (ii) of Theorem 2.

“(2) $\Rightarrow$ (ii)”: Assume (2) holds. In  $\mathcal{A}_{det}^{\mathfrak{M}}$ , choose a transition sequence  $x_0 \xrightarrow{\alpha} x \xrightarrow{\beta} x$  such that in  $x \xrightarrow{\beta} x$  all states are of cardinality 2 and  $|\beta| > 0$ . Without loss of generality, we assume  $|\beta| > |2^Q|$ , because otherwise we can repeat  $x \xrightarrow{\beta} x$  for  $|2^Q| + 1$  times. By definition, one has for all  $\beta' \sqsubset \beta$ , for the  $x_{\beta'}$  satisfying  $(x_0, \alpha\beta', x_{\beta'}) \in \delta_{obs}$ ,  $|x_{\beta'}| > 1$ . Then by the Pigeonhole Principle, there exist  $\beta_1, \beta_2 \sqsubset \beta$  such that  $|\beta_1| < |\beta_2|$  and  $x_{\beta_1} = x_{\beta_2}$ , where  $(x_0, \alpha\beta_1, x_{\beta_1}), (x_0, \alpha\beta_2, x_{\beta_2}) \in \delta_{obs}$ . Thus, (ii) of Theorem 2 holds.

“(2) $\Leftarrow$ (ii)”: Assume (ii) holds. In  $\mathcal{A}_{obs}^{\mathfrak{M}}$ , choose a transition sequence  $x_0 \xrightarrow{\alpha} x_1 \xrightarrow{\beta_1} \dots \xrightarrow{\beta_n} x_{n+1}$  such that  $n \geq |Q|^2$ ,  $x_1 = x_{n+1}$ ,  $|x_1|, \dots, |x_{n+1}| > 1$ , and  $\beta_1, \dots, \beta_n \in \Sigma \times T$ . By using Lemma 4 from  $n + 1$  to 2, we obtain  $x'_i \subset x_i$  for all  $i \in \llbracket 1, n + 1 \rrbracket$  such that  $|x'_1| = \dots = |x'_{n+1}| = 2$  and a transition sequence  $x'_1 \xrightarrow{\beta_1} \dots \xrightarrow{\beta_n} x'_{n+1}$  of  $\mathcal{A}_{det}^{\mathfrak{M}}$ . Moreover, also by Lemma 4, we obtain a transition sequence  $x_0 \xrightarrow{\alpha} x'_1$  of  $\mathcal{A}_{det}^{\mathfrak{M}}$ . By the Pigeonhole Principle, (2) of this theorem holds.  $\square$

### 3.6.3 For weak detectability and weak periodic detectability:

We use the notion of observer to give equivalent conditions for weak detectability and weak periodic detectability of labeled weighted automata.

**Theorem 4** A labeled weighted automaton  $\mathcal{A}^{\mathfrak{M}}$  (3) is weakly detectable if and only if either one of the following three conditions holds.

- (i)  $L^\omega(\mathcal{A}^{\mathfrak{M}}) = \emptyset$ .
- (ii)  $L^\omega(\mathcal{A}^{\mathfrak{M}}) \neq \emptyset$  and there exists  $w \in L^\omega(\mathcal{A}^{\mathfrak{M}})$  such that  $\ell(w) \in (\Sigma \times T)^*$ .
- (iii)  $L^\omega(\mathcal{A}^{\mathfrak{M}}) \neq \emptyset$  and in any one of its observers, there is a reachable cycle in which all states are singletons.

**Proof** “if”: (i) implies that  $\mathcal{A}^{\mathfrak{M}}$  is weakly detectable vacuously.

Assume (ii) holds. Choose integer  $k > |\ell(w)|$ , then one has  $\mathcal{A}^{\mathfrak{M}}$  is weakly detectable vacuously.

Assume (iii) holds. Then in any observer  $\mathcal{A}_{obs}^{\mathfrak{M}}$ , there is a transition sequence  $x_0 \xrightarrow{\gamma_1} x_1 \xrightarrow{\gamma_2} x_1$  such that  $\gamma_1 \in (\Sigma_{obs}^T)^*$ ,  $\gamma_2 \in (\Sigma_{obs}^T)^+$ , and in  $x_1 \xrightarrow{\gamma_2} x_1$ , all states are singletons. Hence in  $\mathcal{A}^{\mathfrak{M}}$ , there exists an infinite path  $q_0 \xrightarrow{s_1} q_1 \xrightarrow{s_2} q_1 \xrightarrow{s_2} q_1 \xrightarrow{s_2} \dots$   $q_1)^\omega =: \pi$  such that  $\tau(\pi) \in L^\omega(\mathcal{A}^{\mathfrak{M}})$ ,  $q_0 \in x_0$ ,  $\{q_1\} = x_1$ ,  $\ell(\tau(q_0 \xrightarrow{s_1} q_1)) = \tau(\gamma_1)$ ,  $\ell(\tau(q_0 \xrightarrow{s_1} q_1 \xrightarrow{s_2} q_1)) = \tau(\gamma_1\gamma_2)$ , and  $\ell(\tau(\pi)) = \tau(\gamma_1(\gamma_2)^\omega)$ . For all prefixes  $\gamma \sqsubset \gamma_1(\gamma_2)^\omega$  such that  $|\gamma| \geq |\gamma_1|$ , one has  $|\mathcal{M}(\mathcal{A}^{\mathfrak{M}}, \tau(\gamma))| = 1$ . Then  $\mathcal{A}^{\mathfrak{M}}$  is weakly detectable.

“only if”: Assume  $\mathcal{A}^{\mathfrak{M}}$  is weakly detectable and neither (i) nor (ii) holds. Then by the finiteness of the number of states of  $\mathcal{A}^{\mathfrak{M}}$  and the Pigeonhole Principle, in pre-observer  $^{pre}\mathcal{A}_{obs}^{\mathfrak{M}}$ , there is a reachable cycle in which all states are singletons, then by definition, (iii) holds.  $\square$

**Theorem 5** *A labeled weighted automaton  $\mathcal{A}^{\mathfrak{M}}$  (3) is weakly periodically detectable if and only if either one of the following three conditions holds.*

- (i)  $L^\omega(\mathcal{A}^{\mathfrak{M}}) = \emptyset$ .
- (ii)  $L^\omega(\mathcal{A}^{\mathfrak{M}}) \neq \emptyset$ , there exists  $w \in L^\omega(\mathcal{A}^{\mathfrak{M}})$  such that  $\ell(w) \in (\Sigma \times T)^*$  and  $|\mathcal{M}(\mathcal{A}^{\mathfrak{M}}, \ell(w))| = 1$ .
- (iii)  $L^\omega(\mathcal{A}^{\mathfrak{M}}) \neq \emptyset$  and in any one of its observers, there is a reachable cycle in which at least one state is a singleton.

We omit the proof of Theorem 5 that is similar to the proof of Theorem 4.

We have given equivalent conditions for the four notions of detectability of a labeled weighted automaton  $\mathcal{A}^{\mathfrak{M}}$ , where these conditions are represented by its self-composition  $CC_A(\mathcal{A}^{\mathfrak{M}})$ , any of its observers  $\mathcal{A}_{obs}^{\mathfrak{M}}$ , and any of its detectors  $\mathcal{A}_{det}^{\mathfrak{M}}$ . Hence the decidability of these notions directly depends on whether the corresponding  $CC_A(\mathcal{A}^{\mathfrak{M}})$ ,  $\mathcal{A}_{obs}^{\mathfrak{M}}$ , and  $\mathcal{A}_{det}^{\mathfrak{M}}$  are computable, which directly depends on  $\mathfrak{M}$ . In the following Section 3.7, we consider monoid  $(\mathbb{Q}^k, +, 0_k)$ , and show that  $CC_A(\mathcal{A}^{\mathbb{Q}^k})$ ,  $\mathcal{A}_{obs}^{\mathbb{Q}^k}$ , and  $\mathcal{A}_{det}^{\mathbb{Q}^k}$  are all computable with complexity upper bounds.

### 3.7 Verification of notions of detectability for labeled weighted automata over the monoid $(\mathbb{Q}^k, +, 0_k)$

In this subsection, we show for labeled weighted automaton  $\mathcal{A}^{\mathbb{Q}^k}$ , its self-composition  $CC_A(\mathcal{A}^{\mathbb{Q}^k})$  (18), observers  $\mathcal{A}_{obs}^{\mathbb{Q}^k}$  (21), and detectors  $\mathcal{A}_{det}^{\mathbb{Q}^k}$  (23) are computable in NP, 2-EXPTIME, and 2-EXPTIME, by using the EPL problem (Lemma 1) and a subclass of Presburger arithmetic (Lemma 3). As a result, the problem of verifying strong detectability of  $\mathcal{A}^{\mathbb{Q}^k}$  is proven to belong to coNP, and the problems of verifying strong periodic detectability, weak detectability, and weak periodic detectability of  $\mathcal{A}^{\mathbb{Q}^k}$  are proven to belong to 2-EXPTIME. Particularly, for  $\mathcal{A}^{\mathbb{Q}^k}$  in which from every

state, a distinct state can be reached through some unobservable, instantaneous path, detectors  $\mathcal{A}_{det}^{\mathbb{Q}^k}$  can be computed in NP, and SPD can be verified in coNP. In addition, we also prove that the problems of verifying strong detectability and strong periodic detectability of deterministic, deadlock-free, and divergence-free  $\mathcal{A}^{\mathbb{N}}$  are both coNP-hard by constructing polynomial-time reductions from the NP-complete subset sum problem (Lemma 2).

*Remark 2* We point out that in order to characterize detectability for automaton  $\mathcal{A}^{\mathbb{Q}^k}$ , one can consider automaton  $\mathcal{A}^{\mathbb{Z}^k}$  without loss of generality. Given an automaton  $\mathcal{A}^{\mathbb{Q}^k}$ , enumerate the entries of the weights of all its transitions by  $m_1/n_1, \dots, m_l/n_l$ , where  $m_i$  and  $n_i$  are relatively prime integers,  $i \in \llbracket 1, l \rrbracket$ , then after multiplying the entries by a large positive integer  $M$ , the newly obtained automaton  $\bar{\mathcal{A}}^{\mathbb{Q}^k}$  have the weights of all its transitions in  $\mathbb{Z}^k$ , where  $M$  is the least common multiple of  $n_1, \dots, n_l$ . One has  $\mathcal{A}^{\mathbb{Q}^k}$  is detectable if and only if  $\bar{\mathcal{A}}^{\mathbb{Q}^k}$  is detectable with respect to all the four definitions of detectability, because for every two paths  $\pi_1$  and  $\pi_2$  in  $\mathcal{A}^{\mathbb{Q}^k}$ , they have the same weight in  $\mathcal{A}^{\mathbb{Q}^k}$  if and only if they have the same weight in  $\bar{\mathcal{A}}^{\mathbb{Q}^k}$ . In addition, such a modification does not change complexity class membership when verifying detectability of  $\mathcal{A}^{\mathbb{Q}^k}$  and  $\bar{\mathcal{A}}^{\mathbb{Q}^k}$ . Later, we will show in order to verify detectability of  $\mathcal{A}^{\mathbb{Z}^k}$ , one can consider  $\mathcal{A}^{\mathbb{Z}}$  without loss of generality.

However, it is not known whether verification of detectability of  $\mathcal{A}^{\mathbb{Z}^k}$  can be transformed to verification of detectability of  $\mathcal{A}^{\mathbb{N}^k}$  without loss of generality. One can try to find a function  $f : \mathbb{Z}^k \rightarrow \mathbb{N}^k$  that maps the weights of all transitions of  $\mathcal{A}^{\mathbb{Z}^k}$  to elements in  $\mathbb{N}^k$  (the newly obtained automaton is denoted by  $f(\mathcal{A}^{\mathbb{Z}^k})$ ) and meanwhile preserves detectability, but it is not known whether such an  $f$  exists. For simplicity, we try to find an  $f$  such that

$$\left( \forall x_1, \dots, x_m, y_1, \dots, y_n \in \mathbb{Z}^k \right) \left[ \sum_{i=1}^m x_i = \sum_{i=1}^n y_i \iff \sum_{i=1}^m f(x_i) = \sum_{i=1}^n f(y_i) \right],$$

because such an  $f$  preserves detectability between  $\mathcal{A}^{\mathbb{Z}^k}$  and  $f(\mathcal{A}^{\mathbb{Z}^k})$  ( $f$  guarantees that for every two paths  $\pi_1$  and  $\pi_2$  in  $\mathcal{A}^{\mathbb{Z}^k}$ , they have the same weight in  $\mathcal{A}^{\mathbb{Z}^k}$  if and only if they have the same weight in  $f(\mathcal{A}^{\mathbb{Z}^k})$ ). However, it is easy to see that such an  $f$  does not exist.  $\square$

### 3.7.1 Computation of self-composition $CC_A(\mathcal{A}^{\mathbb{Q}^k})$ and verification of strong detectability

As shown in Remark 2, without loss of generality we compute  $CC_A(\mathcal{A}^{\mathbb{Z}^k})$ . Moreover, because we will reduce computation of  $CC_A(\mathcal{A}^{\mathbb{Z}^k})$  to the multidimensional EPL problem which belongs to NP, and the 1-dimensional EPL problem is already NP-hard (Lemma 1), we compute  $CC_A(\mathcal{A}^{\mathbb{Z}})$  without loss of generality. Next we compute  $CC_A(\mathcal{A}^{\mathbb{Z}})$  (18). Given states  $(q_1, q_2), (q_3, q_4) \in Q'$  and event  $(e_1, e_2) \in E'$ ,

we verify whether there is a transition

$$((q_1, q_2), (e_1, e_2), (q_3, q_4)) \in \delta'$$

as follows:

- (i) Guess states  $q_5, q_6, q_7, q_8 \in Q$  such that there exist transitions  $q_5 \xrightarrow{e_1} q_7, q_6 \xrightarrow{e_2} q_8$  and unobservable, instantaneous paths  $q_7 \xrightarrow{s_3} q_3, q_8 \xrightarrow{s_4} q_4$ , where  $s_3, s_4 \in (E_{uo})^*$ .
- (ii) Check whether there exist unobservable paths  $q_1 \xrightarrow{s_1} q_5, q_2 \xrightarrow{s_2} q_6$ , where  $s_1, s_2 \in (E_{uo})^*$ , such that the weights of paths  $q_1 \xrightarrow{s_1} q_5 \xrightarrow{e_1} q_7, q_2 \xrightarrow{s_2} q_6 \xrightarrow{e_2} q_8$  are the same. If such paths  $q_1 \xrightarrow{s_1} q_5, q_2 \xrightarrow{s_2} q_6$  exist, then one has  $((q_1, q_2), (e_1, e_2), (q_3, q_4)) \in \delta'$ .

Next we check the above (ii). Firstly, compute subautomata  $\mathcal{A}_{q_1}^{\mathbb{Z}}$  (resp.,  $\mathcal{A}_{q_2}^{\mathbb{Z}}$ ) of  $\mathcal{A}^{\mathbb{Z}}$  starting at  $q_1$  (resp.,  $q_2$ ) and passing through exactly all possible unobservable transitions. Secondly, compute asynchronous product  $\mathcal{A}_{q_1}^{\mathbb{Z}} \otimes \mathcal{A}_{q_2}^{\mathbb{Z}}$  of  $\mathcal{A}_{q_1}^{\mathbb{Z}}$  and  $\mathcal{A}_{q_2}^{\mathbb{Z}}$ , where the states of the product are exactly pairs  $(p_1, p_2)$  with  $p_1$  and  $p_2$  being states of  $\mathcal{A}_{q_1}^{\mathbb{Z}}$  and  $\mathcal{A}_{q_2}^{\mathbb{Z}}$ , respectively; transitions are of the form

$$(p_1, p_2) \xrightarrow{(e, \epsilon) / -\mu(e)_{p_2 p_3}} (p_1, p_3), \quad (26)$$

where  $p_2 \xrightarrow{e / \mu(e)_{p_2 p_3}} p_3$  is a transition of  $\mathcal{A}_{q_2}^{\mathbb{Z}}$ , or of the form

$$(p_1, p_2) \xrightarrow{(e, \epsilon) / \mu(e)_{p_1 p_3}} (p_3, p_2), \quad (27)$$

where  $p_1 \xrightarrow{e / \mu(e)_{p_1 p_3}} p_3$  is a transition of  $\mathcal{A}_{q_1}^{\mathbb{Z}}$ . Regard  $\mathcal{A}_{q_1}^{\mathbb{Z}} \otimes \mathcal{A}_{q_2}^{\mathbb{Z}}$  as a weighted directed graph, and the above  $-\mu(e)_{p_2 p_3}$  and  $\mu(e)_{p_1 p_3}$  as the weights of transitions (26) and (27). Finally, check in  $\mathcal{A}_{q_1}^{\mathbb{Z}} \otimes \mathcal{A}_{q_2}^{\mathbb{Z}}$ , whether there is a path from  $(q_1, q_2)$  to  $(q_5, q_6)$  whose weight is equal to  $\mu(e_2)_{q_6 q_8} - \mu(e_1)_{q_5 q_7}$ , which is actually a 1-dimensional EPL problem (Problem 1). Then since the EPL problem belongs to NP (Lemma 1), the following result holds.

**Theorem 6** *The self-composition  $CC_A(\mathcal{A}^{\mathbb{Q}^k})$  of labeled weighted automaton  $\mathcal{A}^{\mathbb{Q}^k}$  can be computed in NP in the size of  $\mathcal{A}^{\mathbb{Q}^k}$ .*

*Example 9* We use automaton  $\mathcal{A}_1^{\mathbb{N}}$  in Fig. 4 to illustrate how to compute  $CC_A(\mathcal{A}_1^{\mathbb{N}})$ . Recall its self-composition  $CC_A(\mathcal{A}_1^{\mathbb{N}})$  shown in Fig. 5. We check whether there exists a transition  $((q_1, q_2), (b, b), (q_3, q_3))$  in  $CC_A(\mathcal{A}_1^{\mathbb{N}})$  as follows: (1) Guess transitions  $q_1 \xrightarrow{b/2} q_3$  and  $q_2 \xrightarrow{b/1} q_3$  of  $\mathcal{A}_1^{\mathbb{N}}$ . Because the two transitions have different weights, now we do not know whether there exists a transition  $((q_1, q_2), (b, b), (q_3, q_3))$  in  $CC_A(\mathcal{A}_1^{\mathbb{N}})$ . (2) Compute subautomata  $\mathcal{A}_{1q_1}^{\mathbb{N}}$  and  $\mathcal{A}_{1q_2}^{\mathbb{N}}$  and their asynchronous product  $\mathcal{A}_{1q_1}^{\mathbb{N}} \otimes \mathcal{A}_{1q_2}^{\mathbb{N}}$  as in Fig. 7. The rest is to check whether there exists a path from  $(q_1, q_2)$  to  $(q_1, q_2)$  in  $\mathcal{A}_{1q_1}^{\mathbb{N}} \otimes \mathcal{A}_{1q_2}^{\mathbb{N}}$  with weight  $\mu(b)_{q_2 q_3} - \mu(b)_{q_1 q_3} = 1 - 2 = -1$ . The answer is YES:  $(q_1, q_2) \xrightarrow{(\epsilon, u)} (q_1, q_2)$  is such a path. By these transitions and paths

we find two paths  $q_1 \xrightarrow{b} q_3 =: \pi_1$  and  $q_2 \xrightarrow{u} q_2 \xrightarrow{b} q_3 =: \pi_2$  such that they have the same weight. Note that  $\pi_1$  and  $\pi_2$  are exactly the  $\pi_1$  and  $\pi_2$  in Example 6. Then we conclude that there exists a transition  $((q_1, q_2), (b, b), (q_3, q_3))$  in  $\text{CC}_A(\mathcal{A}_1^{\mathbb{N}})$ . The other transitions of  $\text{CC}_A(\mathcal{A}_1^{\mathbb{N}})$  can be computed similarly.  $\square$



**Fig. 7** Subautomaton  $\mathcal{A}_{1q_1}^{\mathbb{N}}$  (left) and subautomaton  $\mathcal{A}_{1q_2}^{\mathbb{N}}$  (middle) of labeled weighted automaton  $\mathcal{A}_1^{\mathbb{N}}$  in Fig. 4, and their asynchronous product  $\mathcal{A}_{1q_1}^{\mathbb{N}} \otimes \mathcal{A}_{1q_2}^{\mathbb{N}}$  (right).

One can see that the condition in Theorem 1 can be verified in time linear in the size of  $\text{CC}_A(\mathcal{A}^{\mathbb{Q}^k})$  by computing its strongly connected components (a similar check is referred to [19, Theorem 3]), then the following result holds.

**Theorem 7** *The problem of verifying strong detectability of labeled weighted automaton  $\mathcal{A}^{\mathbb{Q}^k}$  belongs to coNP.*

Particularly, one directly sees from the process of computing  $\text{CC}_A(\mathcal{A}^{\mathbb{Z}})$  that, if all transitions of  $\mathcal{A}^{\mathbb{Z}}$  are observable, then its self-composition  $\text{CC}_A(\mathcal{A}^{\mathbb{Z}})$  can be computed in polynomial time. Hence we have the following direct corollary.

**Corollary 1** *Consider a labeled weighted automaton  $\mathcal{A}^{\mathbb{Q}^k}$  all of whose transitions are observable. Its self-composition  $\text{CC}_A(\mathcal{A}^{\mathbb{Q}^k})$  can be computed in polynomial time, and its strong detectability can be verified also in polynomial time.*

### 3.7.2 Computation of observer $\mathcal{A}_{obs}^{\mathbb{Q}^k}$ and verification of weak detectability and weak periodic detectability

Also as shown in Remark 2, without loss of generality we compute observer  $\mathcal{A}_{obs}^{\mathbb{Z}^k}$  (21) of automaton  $\mathcal{A}^{\mathbb{Z}^k}$ . To this end, we will repetitively use the EPL problem (Lemma 1) and the subcalss of Presburger arithmetic in Lemma 3 with at most 2 quantifier alternations. The final result in this part is that  $\mathcal{A}_{obs}^{\mathbb{Z}^k}$  can be computed in 2-EXPTIME in the size of  $\mathcal{A}^{\mathbb{Z}^k}$ . Since as a special case,  $\mathcal{A}_{obs}^{\mathbb{Z}}$  is computed in 2-EXPTIME in the size of  $\mathcal{A}^{\mathbb{Z}}$ , to simplify the notation in the following statement, we consider  $\mathcal{A}^{\mathbb{Z}}$ . The initial state  $x_0 = \mathcal{M}(\mathcal{A}^{\mathbb{Z}}, \epsilon)$  can be directly computed by starting at an initial state of  $\mathcal{A}^{\mathbb{Z}}$  and passing through all possible unobservable, instantaneous paths. We then start from  $x_0$ , find all reachable states step by step together with the corresponding transitions.

- (i) Choose a state  $x_1 \in X$  that we have just computed. Choose  $\sigma \in \Sigma$ . For each  $q \in x_1$ , compute subautomaton  $\mathcal{A}_q^{\mathbb{Z}}$  that consists of all paths of the form

$$q \xrightarrow{s} q^1 \xrightarrow{\epsilon} q^2 \quad (28)$$

of  $\mathcal{A}^{\mathbb{Z}}$  such that  $s \in (E_{uo})^*$ ,  $e \in E_{\sigma}$  (i.e.,  $e$  is observable and  $\ell(e) = \sigma$ ). Denote the set of all such  $q^2$  by  $x_2$ . Note that one may have  $x_2 = \emptyset$ ,  $|x_2| > |x_1|$ ,  $|x_2| = |x_1|$ , or  $|x_2| < |x_1|$ .

- (ii) Choose an arbitrary  $\bar{x}_2 = \{\bar{q}_1^2, \dots, \bar{q}_n^2\} \subset x_2$ , where  $|\bar{x}_2| = n$ . For every  $\bar{q}_i^2$ ,  $i \in \llbracket 1, n \rrbracket$ , **nondeterministically** choose a path

$$\bar{q}_i \xrightarrow{\bar{s}_i} \bar{q}_i^1 \xrightarrow{\bar{e}_i} \bar{q}_i^2 \quad (29)$$

as in (28), where  $\bar{q}_i \in x_1$ .

- (iii) Compute asynchronous product (which will be regarded as a weighted automaton and a weighted directed graph)

$$\mathcal{A}_{\bar{q}_1}^{\mathbb{Z}} \otimes \dots \otimes \mathcal{A}_{\bar{q}_n}^{\mathbb{Z}}, \quad (30)$$

where the states of the asynchronous product/automaton are  $(\hat{q}_1, \dots, \hat{q}_n)$ , where  $\hat{q}_i$  are states of  $\mathcal{A}_{\bar{q}_i}^{\mathbb{Z}}$ ,  $i \in \llbracket 1, n \rrbracket$ ; there is a transition

$$(\hat{q}_1, \dots, \hat{q}_n) \xrightarrow{(\hat{e}_1, \dots, \hat{e}_n) / (\mu(\hat{e}_1)_{\hat{q}_1 \hat{q}'_1}, \dots, \mu(\hat{e}_n)_{\hat{q}_n \hat{q}'_n})} (\hat{q}'_1, \dots, \hat{q}'_n) \quad (31)$$

in automaton (30) if and only if one of the following two conditions holds.

- (a) For some  $i \in \llbracket 1, n \rrbracket$ ,  $\hat{q}_i \xrightarrow{\hat{e}_i} \hat{q}'_i$  is an unobservable transition of  $\mathcal{A}_{\bar{q}_i}^{\mathbb{Z}}$ , for all other  $j \in \llbracket 1, n \rrbracket$ ,  $\hat{e}_j = \epsilon$  and  $\hat{q}_j = \hat{q}'_j$ . In this case, (31) is called *unobservable*.
- (b) For every  $i \in \llbracket 1, n \rrbracket$ ,  $\hat{q}_i \xrightarrow{\hat{e}_i} \hat{q}'_i$  is an observable transition of  $\mathcal{A}_{\bar{q}_i}^{\mathbb{Z}}$ ,  $\hat{q}_i = \bar{q}_i^1$ ,  $\hat{e}_i = \bar{e}_i$ , and  $\hat{q}'_i = \bar{q}_i^2$ . In this case, (31) is called *observable*.

Automaton (30) has at most  $|Q|^n$  states, at most  $n|\Delta_{uo}||Q|^{n-1}$  unobservable transitions (recall  $\Delta_{uo} = \{(q, e, q') \in \Delta \mid \ell(e) = \epsilon, e \neq \epsilon\}$ ), and exactly 1 observable transition.

If in automaton (30),

there exists a path  $\pi$  from the initial state  $(\bar{q}_1, \dots, \bar{q}_n)$  to the state  $(\bar{q}_1^2, \dots, \bar{q}_n^2)$  such that only the last transition is observable and all components of the path have the same weight, which is denoted by  $t \in \mathbb{Z}$ , (A)

then  $\mathcal{M}(\mathcal{A}^{\mathbb{Z}}, \epsilon | \bar{x}_2) \subset \mathcal{M}(\mathcal{A}^{\mathbb{Z}}, (\sigma, t) | x_1)$  (defined in (14) and (16)). We say a subset  $\bar{x}_2 \subset x_2$  is a *pre-successor* of  $x_1$  if for every  $\bar{q}_i^2 \in \bar{x}_2$ , there exists a path  $\bar{q}_i \xrightarrow{\bar{s}_i} \bar{q}_i^1 \xrightarrow{\bar{e}_i} \bar{q}_i^2$  as in (29) such that the corresponding automaton (30) satisfies condition (A). Then by definition, if  $\bar{x}_2$  is a pre-successor of  $x_1$  and no other  $\tilde{x}_2$  satisfying  $\bar{x}_2 \subsetneq \tilde{x}_2 \subset x_2$  is a pre-successor of  $x_1$ , then in  $\mathcal{A}_{obs}^{\mathbb{Z}}$ , there is a transition  $x_1 \xrightarrow{(\sigma, t)} \mathcal{M}(\mathcal{A}^{\mathbb{Z}}, \epsilon | \bar{x}_2)$ , and there is no transition from  $x_1$  to  $\mathcal{M}(\mathcal{A}^{\mathbb{Z}}, \epsilon | \tilde{x}_2)$  for any of such  $\tilde{x}_2$  in case  $\mathcal{M}(\mathcal{A}^{\mathbb{Z}}, \epsilon | \tilde{x}_2) \subsetneq \mathcal{M}(\mathcal{A}^{\mathbb{Z}}, \epsilon | \bar{x}_2)$ , where  $t$  is the weight of any components of a path  $\pi$  as in (A). Such special pre-successors  $\bar{x}_2$  are called *successors* of  $x_1$ .

In order to find all successors of  $x_1$ , we first check whether  $x_2$  is a pre-successor of  $x_1$ . If the answer is YES, then  $x_2$  is a successor of  $x_1$  and we obtain a transition of  $\mathcal{A}_{obs}^{\mathbb{Z}}$  from  $x_1$  to  $\mathcal{M}(\mathcal{A}^{\mathbb{Z}}, \epsilon | x_2)$ , we also know no strict subset of  $x_2$  will

be a successor of  $x_1$ ; otherwise, we check whether subsets of  $x_2$  are successors of  $x_1$  in a decreasing order of cardinality. Once we find a successor of  $x_1$ , we do not need to check the strict subsets of the successor because its strict subsets will not be successors of  $x_1$ .

A decision procedure for checking condition (A) is given in (iv).

- (iv) In (30), we delete the observable transition, and replace the weight

$$(\mu(\hat{e}_1)_{\hat{q}_1 \hat{q}'_1}, \dots, \mu(\hat{e}_n)_{\hat{q}_n \hat{q}'_n})$$

(see (31)) of each transition by

$$(\mu(\hat{e}_2)_{\hat{q}_2 \hat{q}'_2} - \mu(\hat{e}_1)_{\hat{q}_1 \hat{q}'_1}, \dots, \mu(\hat{e}_n)_{\hat{q}_n \hat{q}'_n} - \mu(\hat{e}_1)_{\hat{q}_1 \hat{q}'_1}),$$

then we obtain a new automaton

$$\overline{\mathcal{A}_{q_1}^{\mathbb{Z}} \otimes \dots \otimes \mathcal{A}_{q_n}^{\mathbb{Z}}}. \quad (32)$$

Then we check whether

$$\text{there is a path } \bar{\pi} \text{ from } (\bar{q}_1, \dots, \bar{q}_n) \text{ to } (\bar{q}_1^1, \dots, \bar{q}_n^1) \text{ in (32) with weight} \quad (\text{B}) \\ (\mu(\bar{e}_1)_{\bar{q}_1^1 \bar{q}_1^2} - \mu(\bar{e}_2)_{\bar{q}_2^1 \bar{q}_2^2}, \dots, \mu(\bar{e}_1)_{\bar{q}_1^1 \bar{q}_1^2} - \mu(\bar{e}_n)_{\bar{q}_n^1 \bar{q}_n^2}).$$

If the answer is YES, then  $\bar{\pi} \xrightarrow{(\bar{e}_1, \dots, \bar{e}_n)} (\bar{q}_1^2, \dots, \bar{q}_n^2)$  is a path of (30) as shown in (A), i.e., the weight  $(w_1, \dots, w_n)$  of  $\bar{\pi}$  in (30) satisfies

$$(w_1, \dots, w_n) + (\mu(\bar{e}_1)_{\bar{q}_1^1 \bar{q}_1^2}, \dots, \mu(\bar{e}_n)_{\bar{q}_n^1 \bar{q}_n^2})$$

has equal components, and  $\mathcal{M}(\mathcal{A}^{\mathbb{Z}}, \epsilon | \bar{x}_2) \subset \mathcal{M}(\mathcal{A}^{\mathbb{Z}}, (\sigma, w_1 + \mu(\bar{e}_1)_{\bar{q}_1^1 \bar{q}_1^2}) | x_1)$ . That is,  $\bar{x}_2$  is a pre-successor of  $x_1$ . If additionally  $\bar{x}_2$  is a successor of  $x_1$ , then

$$x_1 \xrightarrow{(\sigma, w_1 + \mu(\bar{e}_1)_{\bar{q}_1^1 \bar{q}_1^2})} \mathcal{M}(\mathcal{A}^{\mathbb{Z}}, \epsilon | \bar{x}_2) \quad (33)$$

is a transition of  $\mathcal{A}_{obs}^{\mathbb{Z}}$ .

(B) is an EPL problem of weighted directed graph (32), and hence can be checked in NP in the size of (32) by Lemma 1.

- (v) In the following, we check for every successor  $\bar{x}_2$  of  $x_1$ , for every  $\emptyset \neq \hat{x}_2 \subsetneq \bar{x}_2$  satisfying  $\mathcal{M}(\mathcal{A}^{\mathbb{Z}}, \epsilon | \hat{x}_2) \subsetneq \mathcal{M}(\mathcal{A}^{\mathbb{Z}}, \epsilon | \bar{x}_2)$ , whether

$$\text{there is a transition from } x_1 \text{ to } \mathcal{M}(\mathcal{A}^{\mathbb{Z}}, \epsilon | \hat{x}_2) \text{ in } \mathcal{A}_{obs}^{\mathbb{Z}}, \quad (\text{C})$$

which is equivalent to whether

$$\text{there exists } t \in \mathbb{Z} \text{ such that for every } \hat{q}_i^2 \in \hat{x}_2, \text{ there exists a path} \quad (\text{D}) \\ \hat{q}_i \xrightarrow{\hat{s}_i} \hat{q}_i^1 \xrightarrow{\hat{e}_i} \hat{q}_i^2 \text{ as in (29) with weight } t, \text{ and for any } q \in x_1 \text{ and any} \\ q^2 \in x_2 \setminus \hat{x}_2, \text{ there exists no path } q \xrightarrow{s} q^1 \xrightarrow{e} q^2 \text{ as in (28) with weight} \\ t.$$

We will use the subclass of Presburger arithmetic as in Lemma 3 to check (D).

Denote  $\hat{x}_2 = \{\hat{q}_1^2, \dots, \hat{q}_m^2\}$ , where  $|\hat{x}_2| = m$ . For every  $i \in \llbracket 1, m \rrbracket$ , **nondeterministically** choose a path  $\hat{q}_i \xrightarrow{\hat{s}_i} \hat{q}_i^1 \xrightarrow{\hat{e}_i} \hat{q}_i^2$  as in (29), then  $\hat{q}_i \in x_1$ ; consider a copy of  $\mathcal{A}_{\hat{q}_i}^{\mathbb{Z}}$  as in (i), and use  $\mathcal{A}_{\mathfrak{B}_i}^{\mathbb{Z}}$  to denote the subautomaton of  $\mathcal{A}_{\hat{q}_i}^{\mathbb{Z}}$  obtained by deleting all observable transitions and all states that do not belong to any unobservable path from  $\hat{q}_i$  to  $\hat{q}_i^1$ , hence  $\mathcal{A}_{\mathfrak{B}_i}^{\mathbb{Z}}$  consists of all unobservable paths from  $\hat{q}_i$  to  $\hat{q}_i^1$  in  $\mathcal{A}_{\hat{q}_i}^{\mathbb{Z}}$ . We call  $\hat{q}_i$  the *source* and  $\hat{q}_i^1$  the *sink*. Denote

$$\mathfrak{E} =: \{(q, q^1, e, q^2) \mid q \in x_1, e \in E_\sigma, q^2 \in x_2 \setminus \hat{x}_2, \text{ there exists a path } q \xrightarrow{s} q^1 \xrightarrow{e} q^2 \text{ as in (28)}\}. \quad (34)$$

Then  $|\mathfrak{E}| \leq |x_1| |\Delta_\sigma| (|x_2| - |\hat{x}_2|)$ , where recall  $\Delta_\sigma = \{(q, e, q') \in \Delta \mid \ell(e) = \sigma\}$ . Rewrite  $\mathfrak{E}$  as  $\{(q_j, q_j^1, e_j, q_j^2) \mid j \in \llbracket 1, |\mathfrak{E}| \rrbracket\}$  and denote  $(q_j, q_j^1, e_j, q_j^2) =: \mathfrak{E}_j$ , compute subautomaton  $\mathcal{A}_{\mathfrak{E}_j}^{\mathbb{Z}}$  from  $\mathcal{A}_{q_j}^{\mathbb{Z}}$  by deleting all observable transitions and all states that do not belong to any unobservable path from  $q_j$  to  $q_j^1$ , hence  $\mathcal{A}_{\mathfrak{E}_j}^{\mathbb{Z}}$  consists of all unobservable paths from  $q_j$  to  $q_j^1$  in  $\mathcal{A}_{q_j}^{\mathbb{Z}}$ . We call  $q_j$  the *source* and  $q_j^1$  the *sink*.

Then (D) is satisfied if and only if the following (E) is satisfied.

$$\begin{aligned} &\text{There exists } t \in \mathbb{Z} \text{ such that in } \mathcal{A}_{\mathfrak{B}_i}^{\mathbb{Z}}, i \in \llbracket 1, m \rrbracket, \text{ there exists a path} \\ &\text{from } \hat{q}_i \text{ to } \hat{q}_i^1 \text{ with weight } t - \mu(\hat{e}_i)_{\hat{q}_i^1 \hat{q}_i^2}; \text{ and in } \mathcal{A}_{\mathfrak{E}_j}^{\mathbb{Z}}, j \in \llbracket 1, |\mathfrak{E}| \rrbracket, \quad (\text{E}) \\ &\text{there exists no path from } q_j \text{ to } q_j^1 \text{ with weight } t - \mu(e_j)_{q_j^1 q_j^2}. \end{aligned}$$

If (E) is satisfied, then there is a transition  $x_1 \xrightarrow{(\sigma, t)} \mathcal{M}(\mathcal{A}^{\mathbb{Z}}, \epsilon \mid \hat{x}_2)$  in  $\mathcal{A}_{obs}^{\mathbb{Z}}$ .

We will equivalently transform (E) to a Presburger formula as in Lemma 3 and check satisfiability of the formula. Rewrite  $\mathcal{A}_{\mathfrak{B}_i}^{\mathbb{Z}}$  as a weighted directed graph  $G_{\mathfrak{B}_i} = (\mathbb{Z}, V_{\mathfrak{B}_i}, A_{\mathfrak{B}_i})$ ,  $i \in \llbracket 1, m \rrbracket$ ; also rewrite  $\mathcal{A}_{\mathfrak{E}_j}^{\mathbb{Z}}$  as a weighted directed graph  $G_{\mathfrak{E}_j} = (\mathbb{Z}, V_{\mathfrak{E}_j}, A_{\mathfrak{E}_j})$ ,  $j \in \llbracket 1, |\mathfrak{E}| \rrbracket$ . Then (E) is equivalent to the following (F).

$$\begin{aligned} &\text{There exists } t \in \mathbb{Z} \text{ such that in graph } G_{\mathfrak{B}_i}, i \in \llbracket 1, m \rrbracket, \text{ there exists a} \\ &\text{path } \hat{\pi}_i \text{ from } \hat{q}_i \text{ to } \hat{q}_i^1 \text{ with weight } t - \mu(\hat{e}_i)_{\hat{q}_i^1 \hat{q}_i^2}; \text{ and in graph } G_{\mathfrak{E}_j}, j \in \llbracket 1, |\mathfrak{E}| \rrbracket, \quad (\text{F}) \\ &\text{there exists no path from } q_j \text{ to } q_j^1 \text{ with weight } t - \mu(e_j)_{q_j^1 q_j^2}. \end{aligned}$$

In graph  $G_{\mathfrak{B}_i}$ ,  $i \in \llbracket 1, m \rrbracket$ , for each edge  $a_i \in A_{\mathfrak{B}_i}$ , denote its weight by  $w_{a_i}$  and define a variable  $y_{a_i} \in \mathbb{N}$  which indicates how many times  $a_i$  is included in a path. In graph  $G_{\mathfrak{E}_j}$ ,  $j \in \llbracket 1, |\mathfrak{E}| \rrbracket$ , for each edge  $a_j \in A_{\mathfrak{E}_j}$ , also denote its weight by  $w_{a_j}$  and define a variable  $y_{a_j} \in \mathbb{N}$  as above. In these graphs, an edge  $a$  such that  $y_a > 0$  is called *realizable*, a path is called *realizable* if all its edges are realizable. We furthermore have (F) is satisfied if and only if

$$(\exists_{a_1 \in A_{\mathfrak{B}_1}} y_{a_1} \in \mathbb{N}) \dots (\exists_{a_m \in A_{\mathfrak{B}_m}} y_{a_m} \in \mathbb{N}) \quad (35a)$$

$$(\forall_{a_1 \in A_{\mathfrak{E}_1}} y_{a_1} \in \mathbb{N}) \dots (\forall_{a_{|\mathfrak{E}|} \in A_{\mathfrak{E}_{|\mathfrak{E}|}}} y_{a_{|\mathfrak{E}|}} \in \mathbb{N}) \quad (35b)$$



$$\left[ \bigwedge_{i \in [1, m]} \bigwedge_{v_i \in V_{\mathfrak{B}_i} \setminus \{\hat{q}_i, \hat{q}_i^1\}} \left( \sum_{\substack{a_i \in A_{\mathfrak{B}_i} \\ \text{tail}(a_i) = v_i}} y_{a_i} = \sum_{\substack{a_i \in A_{\mathfrak{B}_i} \\ \text{head}(a_i) = v_i}} y_{a_i} \right) \wedge \right. \quad (35c)$$

$$\bigwedge_{i \in [1, m]} \left( \sum_{\substack{a_i \in A_{\mathfrak{B}_i} \\ \text{tail}(a_i) = \hat{q}_i}} y_{a_i} = \sum_{\substack{a_i \in A_{\mathfrak{B}_i} \\ \text{head}(a_i) = \hat{q}_i}} y_{a_i} + 1 \right) \wedge \quad (35d)$$

$$\bigwedge_{i \in [1, m]} \left( \sum_{\substack{a_i \in A_{\mathfrak{B}_i} \\ \text{tail}(a_i) = \hat{q}_i^1}} y_{a_i} + 1 = \sum_{\substack{a_i \in A_{\mathfrak{B}_i} \\ \text{head}(a_i) = \hat{q}_i^1}} y_{a_i} \right) \wedge \quad (35e)$$

$$\bigwedge_{i \in [1, m]} \bigwedge_{a_i \in A_{\mathfrak{B}_i}} \left( y_{a_i} > 0 \wedge \text{head}(a_i) \neq \hat{q}_i^1 \implies \exists \text{ a realizable path from head}(a_i) \text{ to } \hat{q}_i^1 \right) \wedge \quad (35f)$$

$$\bigwedge_{i \in [2, m]} \left( \sum_{a_1 \in A_{\mathfrak{B}_1}} w_{a_1} y_{a_1} + \mu(\hat{e}_1)_{\hat{q}_1^1 \hat{q}_1^2} = \sum_{a_i \in A_{\mathfrak{B}_i}} w_{a_i} y_{a_i} + \mu(\hat{e}_i)_{\hat{q}_i^1 \hat{q}_i^2} \right) \wedge \quad (35g)$$

$$\bigwedge_{j \in [1, |\mathfrak{E}|]} \left( \bigwedge_{v_j \in V_{\mathfrak{E}_j} \setminus \{q_j, q_j^1\}} \left( \sum_{\substack{a_j \in A_{\mathfrak{E}_j} \\ \text{tail}(a_j) = v_j}} y_{a_j} = \sum_{\substack{a_j \in A_{\mathfrak{E}_j} \\ \text{head}(a_j) = v_j}} y_{a_j} \right) \wedge \right. \quad (35h)$$

$$\left( \sum_{\substack{a_j \in A_{\mathfrak{E}_j} \\ \text{tail}(a_j) = q_j}} y_{a_j} = \sum_{\substack{a_j \in A_{\mathfrak{E}_j} \\ \text{head}(a_j) = q_j}} y_{a_j} + 1 \right) \wedge \quad (35i)$$

$$\left( \sum_{\substack{a_j \in A_{\mathfrak{E}_j} \\ \text{tail}(a_j) = q_j^1}} y_{a_j} + 1 = \sum_{\substack{a_j \in A_{\mathfrak{E}_j} \\ \text{head}(a_j) = q_j^1}} y_{a_j} \right) \wedge \quad (35j)$$

$$\bigwedge_{a_j \in A_{\mathfrak{E}_j}} \left( y_{a_j} > 0 \wedge \text{head}(a_j) \neq q_j^1 \implies \exists \text{ a realizable path from head}(a_j) \text{ to } q_j^1 \right) \quad (35k)$$

$$\implies \left. \sum_{a_1 \in A_{\mathfrak{B}_1}} w_{a_1} y_{a_1} + \mu(\hat{e}_1)_{\hat{q}_1^1 \hat{q}_1^2} \neq \sum_{a_j \in A_{\mathfrak{E}_j}} w_{a_j} y_{a_j} + \mu(e_j)_{q_j^1 q_j^2} \right] \quad (35l)$$

is satisfied. In (35a),  $(\exists_{a_1 \in A_{\mathfrak{B}_1}} y_{a_1} \in \mathbb{N})$  is short for  $(\exists y_{a_1^1} \in \mathbb{N}) \dots (\exists y_{a_1^\alpha} \in \mathbb{N})$ , where  $a_1^1, \dots, a_1^\alpha$  is an arbitrary arrangement of the edges of  $A_{\mathfrak{B}_1}$ . The other expressions in (35a) and the expressions in (35b) have analogous meanings. Hence (35a) contains  $\sum_{i=1}^m |A_{\mathfrak{B}_i}|$  existential quantifiers and (35b) con-

tains  $\sum_{j=1}^{|\mathcal{E}|} |A_{\mathcal{E}_j}|$  universal quantifiers. One can see (35c), (35d), and (35e) are all satisfied if and only if in every graph  $G_{\mathfrak{B}_i}$ ,  $i \in \llbracket 1, m \rrbracket$ , all edges  $a$  satisfying  $y_a > 0$  form one path from  $\hat{q}_i$  to  $\hat{q}_i^1$  and possibly several disjoint cycles, where these cycles do not intersect with the path. Then (35c), (35d), (35e), and (35f) are all satisfied if and only if in every graph  $G_{\mathfrak{B}_i}$ ,  $i \in \llbracket 1, m \rrbracket$ , all edges  $a$  satisfying  $y_a > 0$  form exactly one path  $\hat{\pi}_i$  from  $\hat{q}_i$  to  $\hat{q}_i^1$ ; then together with (35g), these paths additionally satisfy  $\text{WT}_{\hat{\pi}_k} + \mu(\hat{e}_k)_{\hat{q}_k^1 \hat{q}_k^2} = \text{WT}_{\hat{\pi}_l} + \mu(\hat{e}_l)_{\hat{q}_l^1 \hat{q}_l^2} =: t$  for all different  $k, l \in \llbracket 1, m \rrbracket$  (note that in (35g),  $\sum_{a_i \in A_{\mathfrak{B}_i}} w_{a_i} y_{a_i}$  is the weight  $\text{WT}_{\hat{\pi}_i}$  of path  $\hat{\pi}_i$ ,  $i \in \llbracket 1, m \rrbracket$ ). Analogously, (35h), (35i), (35j), (35k), and (35l) are all satisfied if and only if in every graph  $G_{\mathcal{E}_j}$ ,  $j \in \llbracket 1, |\mathcal{E}| \rrbracket$ , if all edges  $a$  satisfying  $y_a > 0$  form exactly one path  $\pi_j$  from  $q_j$  to  $q_j^1$  then  $\text{WT}_{\pi_j} + \mu(e_j)_{q_j^1 q_j^2}$  is not equal to  $t$ . Hence

the whole (35) is satisfied only if there exists a transition  $x_1 \xrightarrow{(\sigma, t)}$   
 $\mathcal{M}(\mathcal{A}^{\mathbb{Z}}, \epsilon | \hat{x}_2)$  in  $\mathcal{A}_{obs}^{\mathbb{Z}}$ .

- (vi) Now we specify (35f) and (35k) to make the whole (35) become a Presburger formula.

Consider an arbitrary  $i \in \llbracket 1, m \rrbracket$  and an arbitrary edge  $a_i \in A_{\mathfrak{B}_i}$  such that  $\text{head}(a_i) \neq \hat{q}_i^1$ . Compute a subgraph  $G_{\mathfrak{B}_i}^{a_i} = (\mathbb{Z}, V_{\mathfrak{B}_i}^{a_i}, A_{\mathfrak{B}_i}^{a_i})$  of graph  $G_{\mathfrak{B}_i}$  that consists of  $a_i$  and all paths from  $\text{head}(a_i)$  to  $\hat{q}_i^1$  in time polynomial in the size of  $G_{\mathfrak{B}_i}$ . We next show that (35f) can be equivalently specified as

$$\bigwedge_{i \in \llbracket 1, m \rrbracket} \bigwedge_{a_i \in A_{\mathfrak{B}_i}} \left( \begin{array}{c} y_{a_i} > 0 \wedge \\ \text{head}(a_i) \neq \hat{q}_i^1 \end{array} \implies \sum_{\substack{a \in A_{\mathfrak{B}_i}^{a_i} \\ \text{tail}(a) = \text{head}(a_i)}} y_a > 0 \right) \wedge. \quad (36)$$

For every  $l \in \llbracket 1, m \rrbracket$ , if  $G_{\mathfrak{B}_l}$  satisfies (35c), (35d), and (35e) (after  $\bigwedge_{i \in \llbracket 1, m \rrbracket}$  was deleted), then for every  $a_l \in A_{\mathfrak{B}_l}$ , subgraph  $G_{\mathfrak{B}_l}^{a_l}$  also satisfies (35c), (35d), and (35e) if  $\text{tail}(a_l)$  and  $\hat{q}_l^1$  are regarded as the source and the sink, respectively. Before proceeding, we give an illustrative example.

*Example 10* Consider the directed graph in Fig. 8 showing a graph  $G_{\mathfrak{B}_i}$  for some  $i \in \llbracket 1, m \rrbracket$ . Note that the graph contains a cycle  $1 \rightarrow 2 \rightarrow 5 \rightarrow 6 \rightarrow 1$ . One easily has  $G_{\mathfrak{B}_i}^{b_0} = G_{\mathfrak{B}_i}$ . In subgraph  $G_{\mathfrak{B}_i}^{b_0}$ , one has

$$\sum_{\substack{a \in A_{\mathfrak{B}_i}^{b_0} \\ \text{tail}(a) = \text{head}(b_0)}} y_a = y_{b_1} + y_{b_3} + y_{b_4} + y_{b_2} = 5 > 0.$$

Subgraph  $G_{\mathfrak{B}_i}^{b_1}$  can be obtained from  $G_{\mathfrak{B}_i}$  by only deleting  $b_0$ . One also has

$$\sum_{\substack{a \in A_{\mathfrak{B}_i}^{b_1} \\ \text{tail}(a) = \text{head}(b_1)}} y_a = y_{b_5} = 1 > 0.$$

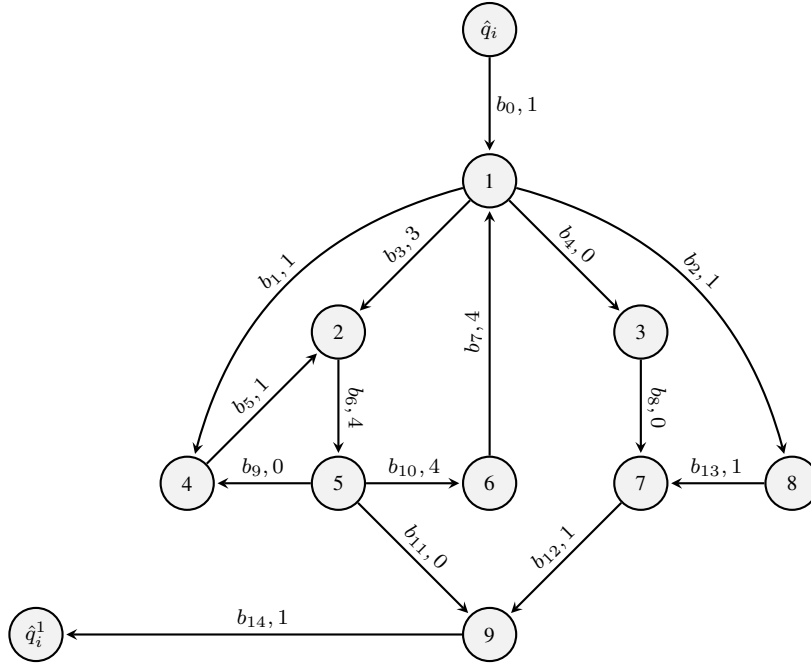

**Fig. 8** A directed graph illustrating a graph  $G_{\mathfrak{B}_i}$ , where  $b_k, 0 \leq k \leq 14$ , denote the corresponding edges, the number after each  $b_k$  denotes the valuation of  $y_{b_k}$ .

After checking all other  $b_k$  such that  $y_{b_k} > 0$  ( $k = 2, 3, 5, 6, 7, 10, 12, 13, 14$ ), we have graph  $G_{\mathfrak{B}_i}$  satisfies formula (36) (after  $\bigwedge_{i \in \llbracket 1, m \rrbracket}$  was deleted). In addition, graph  $G_{\mathfrak{B}_i}$  satisfies (35c), (35d), and (35e) (after  $\bigwedge_{i \in \llbracket 1, m \rrbracket}$  was deleted). Moreover, for each  $k, 1 \leq k \leq 14$ , subgraph  $G_{\mathfrak{B}_i}^{b_k}$  satisfies (35c), (35d), and (35e) if  $\text{tail}(b_k)$  and  $\hat{q}_i^1$  are regarded as the source and the sink, respectively.  $\square$

Now we come back to the poof of the property that (35f) can be equivalently specified by (36). Equivalently, we need to prove that (35c), (35d), (35e), and (35f) are all satisfied if and only if (35c), (35d), (35e), and (36) are all satisfied. The “only if” part trivially holds. To prove the “if” part, we need to, for every  $i \in \llbracket 1, m \rrbracket$ , for every edge  $a_i \in A_{\mathfrak{B}_i}$  such that  $y_{a_i} > 0$  and  $\text{head}(a_i) \neq \hat{q}_i^1$ , find a realizable path  $\hat{\pi}_i$  from  $\text{head}(a_i)$  to  $\hat{q}_i^1$ . We **claim** that for a graph  $G_{\mathfrak{B}_i}$  satisfying (35c), (35d), (35e), and (36) (after  $\bigwedge_{i \in \llbracket 1, m \rrbracket}$  was deleted),  $i \in \llbracket 1, m \rrbracket$ , in every realizable cycle, if we subtract  $y_a$  for each edge  $a$  in the cycle by 1, then the rest of  $G_{\mathfrak{B}_i}$  (denoted by  $G'_{\mathfrak{B}_i}$ ) still satisfies (35c), (35d), (35e), and (36). One directly sees that if  $G_{\mathfrak{B}_i}$  satisfies (35c), (35d), (35e), then after doing such a subtraction,  $G'_{\mathfrak{B}_i}$  still satisfies (35c), (35d), (35e). As one can see, for every realizable cycle in  $G_{\mathfrak{B}_i}$ , for every edge  $a_i \in A_{\mathfrak{B}_i}$ , either the cycle is contained in subgraph  $G_{\mathfrak{B}_i}^{a_i}$  or it does not intersect with  $G_{\mathfrak{B}_i}^{a_i}$ .

Fix a graph  $G_{\mathfrak{B}_i}$ , where  $i \in \llbracket 1, m \rrbracket$ , that satisfies (35c), (35d), (35e), and (36) (after  $\bigwedge_{i \in \llbracket 1, m \rrbracket}$  was deleted). Fix a realizable simple cycle  $C$  and an edge  $a_i \in A_{\mathfrak{B}_i}^{a_i}$  such that  $y_{a_i} > 0$  and  $\text{head}(a_i) \neq \hat{q}_i^1$ . Without loss of generality, assume  $C$  is contained in  $G_{\mathfrak{B}_i}^{a_i}$ . Note that  $\text{tail}(a_i)$  is the source of subgraph  $G_{\mathfrak{B}_i}^{a_i}$ , so it satisfies

$$\sum_{\substack{a \in A_{\mathfrak{B}_i}^{a_i} \\ \text{head}(a) = \text{tail}(a_i)}} y_a + 1 = \sum_{\substack{a \in A_{\mathfrak{B}_i}^{a_i} \\ \text{tail}(a) = \text{tail}(a_i)}} y_a. \quad (37)$$

- If  $a_i$  does not intersect with  $C$ , then after doing the subtraction (on  $C$ ),  $a_i$  trivially satisfies (36).
- If  $a_i$  intersects with  $C$  at  $\text{head}(a_i)$  but  $a_i$  is not contained in  $C$ , then after doing the subtraction,  $a_i$  still satisfies (36), because  $\text{head}(a_i)$  satisfies (35c).
- If  $a_i$  is contained in  $C$  and  $a_i$  is a self-loop, then  $C$  coincides with  $a_i$ . After doing the subtraction we may have  $y_{a_i} > 0$  or  $y_{a_i} = 0$ . In the former case,  $a_i$  naturally satisfies (36), in the latter case,  $a_i$  satisfies (36) vacuously, and on the other hand, because  $\text{head}(a_i)$  is the source (satisfying (37)), there is  $a \in A_{\mathfrak{B}_i}^{a_i}$  such that  $\text{tail}(a) = \text{head}(a_i)$  and  $y_a > 0$ .
- If  $a_i$  is contained in  $C$  and  $a_i$  is not a self-loop, after doing the subtraction, if  $y_{a_i} > 0$  then  $a_i$  still satisfies (36) because  $\text{head}(a_i)$  satisfies (35c), if  $y_{a_i} = 0$ , then  $a_i$  satisfies (36) vacuously, and there is  $a \in A_{\mathfrak{B}_i}^{a_i}$  such that  $\text{tail}(a) = \text{tail}(a_i)$  and  $y_a > 0$ , because  $\text{tail}(a_i)$  is the source (satisfying (37)).

We have proved the above **claim**. We next repetitively trim  $G_{\mathfrak{B}_i}^{a_i}$  by doing the above subtractions on realizable, simple cycles until we finally obtain a subgraph  $\text{trim}(G_{\mathfrak{B}_i}^{a_i})$  in which there is no realized cycle. By the claim, we still have  $\text{trim}(G_{\mathfrak{B}_i}^{a_i})$  satisfies (35c), (35d), (35e), and (36). In addition, we have either (1) there is an edge  $b_1$  in  $\text{trim}(G_{\mathfrak{B}_i}^{a_i})$  such that  $\text{tail}(b_1) = \text{head}(a_i)$  and  $y_{b_1} > 0$ , or, (2) there is an edge  $b_2$  in  $\text{trim}(G_{\mathfrak{B}_i}^{a_i})$  such that  $\text{tail}(b_2) = \text{tail}(a_i)$ ,  $y_{b_2} > 0$ , and in the original graph  $G_{\mathfrak{B}_i}^{a_i}$  there is a realizable path from  $\text{head}(a_i)$  to  $\text{tail}(a_i)$  (hence there is a realizable path from  $\text{head}(a_i)$  to  $\text{head}(b_2)$ ). Since in  $\text{trim}(G_{\mathfrak{B}_i}^{a_i})$  there is no realizable cycle and  $\text{trim}(G_{\mathfrak{B}_i}^{a_i})$  satisfies (36), if we start from  $\text{head}(b_1)$  or  $\text{head}(b_2)$  and traverse realizable edges one by one, finally we will reach  $\hat{q}_i^1$ , thus we find a realizable path from  $\text{head}(a_i)$  to  $\hat{q}_i^1$  in  $G_{\mathfrak{B}_i}^{a_i}$ . The proof of the “if” part has been finished.

*Example 11* Reconsider the subgraph  $G_{\mathfrak{B}_i}^{b_0}$  of graph  $G_{\mathfrak{B}_i}$  shown in Fig. 8. After doing the above subtractions on its realizable cycles, we finally obtain  $\text{trim}(G_{\mathfrak{B}_i}^{b_0})$  in Fig. 9.

We find two realizable paths from 1 (i.e.,  $\text{head}(b_0)$ ) to  $\hat{q}_i^1$ . They are

$$\begin{aligned} & b_1 b_5 b_6 b_{10} b_7 b_2 b_{13} b_{12} b_{14}, \\ & b_2 b_{13} b_{12} b_{14}. \end{aligned}$$

It is easy to see that  $\text{trim}(G_{\mathfrak{B}_i}^{b_0})$  satisfies (35c), (35d), (35e), and (36) (after  $\bigwedge_{i \in \llbracket 1, m \rrbracket}$  was deleted).  $\square$

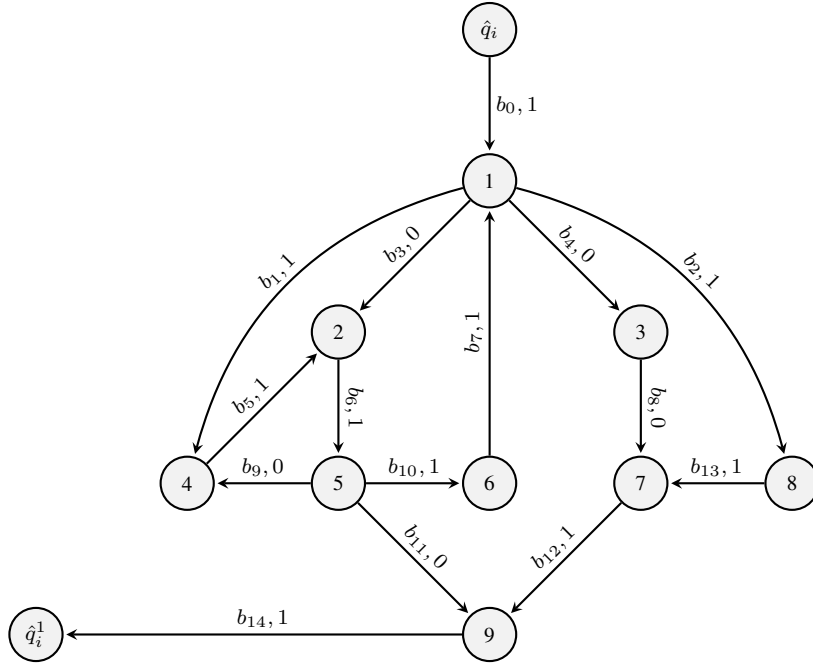

Fig. 9  $\text{trim}(G_{\mathfrak{B}_i}^{b_0})$ .

Now consider an arbitrary  $j \in \llbracket 1, |\mathfrak{E} \rrbracket$  and an arbitrary edge  $a_j \in A_{\mathfrak{E}_j}$  such that  $y_{a_j} > 0$  and  $\text{head}(a_j) \neq q_j^1$ . Compute a subgraph  $G_{\mathfrak{E}_j}^{a_j}$  of graph  $G_{\mathfrak{E}_j}$  that consists of  $a_j$  and all paths from  $\text{head}(a_j)$  to  $q_j^1$  in time polynomial in the size of  $G_{\mathfrak{E}_j}$ . Analogously, we have (35h), (35i), (35j), and (35k) (after  $\bigwedge_{j \in \llbracket 1, |\mathfrak{E} \rrbracket}$  was deleted) are all satisfied if and only if (35h), (35i), (35j), and

$$\bigwedge_{a_j \in A_{\mathfrak{E}_j}} \left( \begin{array}{l} y_{a_j} > 0 \wedge \\ \text{head}(a_j) \neq q_j^1 \end{array} \implies \sum_{\substack{a \in A_{\mathfrak{E}_j}^{a_j} \\ \text{tail}(a) = \text{head}(a_j)}} y_a > 0 \right) \quad (38)$$

are all satisfied.

- (vii) Now we have obtained a Presburger formula (35) (after (35f) and (35k) were replaced by (36) and (38), respectively) in the form of (1). Next we show the formula has length polynomial in the size of  $\mathcal{A}^{\mathbb{Z}}$ . By (35a) and (35b), the formula has at most 2 quantifier alternations. It has 2 quantifier alternations if and only if  $\sum_{i=1}^m |A_{\mathfrak{B}_i}| > 0$  and  $\sum_{j=1}^{|\mathfrak{E}|} |A_{\mathfrak{E}_j}| > 0$ . In (35c), (35d), and (35e), the number of equations is bounded from above by  $\sum_{i=1}^m |V_{\mathfrak{B}_i}| \leq |\hat{x}_2| |Q| \leq |Q|^2$  (see (v)); in (35h), (35i), and (35j), the number of equations has an upper bound  $\sum_{i=1}^{|\mathfrak{E}|} |V_{\mathfrak{E}_j}| \leq |\mathfrak{E}| |Q| \leq |x_1| |\Delta_\sigma| (|x_2| - |\hat{x}_2|) |Q| \leq |Q|^3 |\Delta|$  (also see (v)); in (35g), the number of equations is bounded from above by

$m - 1 \leq |Q|$ ; in (35i), the number of inequalities is bounded from above by  $|\mathfrak{E}| \leq |x_1| |\Delta_\sigma| (|x_2| - |\hat{x}_2|) \leq |Q|^2 |\Delta|$ ; in (36), the number of inequalities is no greater than  $2 \sum_{i=1}^m |A_{\mathfrak{B}_i}| \leq 2m |\Delta| \leq 2|Q| |\Delta|$ ; in (38), the number of inequalities is no greater than  $2 \sum_{j=1}^{|\mathfrak{E}|} |A_{\mathfrak{E}_j}| \leq 2|\mathfrak{E}| |\Delta| \leq 2|x_1| |\Delta_\sigma| (|x_2| - |\hat{x}_2|) |\Delta| \leq 2|Q|^2 |\Delta|^2$ . All these equations and inequalities have length polynomial in the size of  $\mathcal{A}^{\mathbb{Z}}$ . Hence (35) has length polynomial in the size of  $\mathcal{A}^{\mathbb{Z}}$ .

- When (35) has 2 quantifier alternations, by Lemma 3, in the worst case we need to check all  $\sum_{i=1}^m |A_{\mathfrak{B}_i}| + \sum_{j=1}^{|\mathfrak{E}|} |A_{\mathfrak{E}_j}|$  variables between 0 and  $w = 2^{cr(s+3)^3}$  to make sure whether (35) is satisfied, where  $c$  is a constant,  $r$  is the length of (35),  $s = \sum_{i=1}^m |A_{\mathfrak{B}_i}| + \sum_{j=1}^{|\mathfrak{E}|} |A_{\mathfrak{E}_j}|$  is the number of quantifiers. The logarithm of  $w$  is exponential in the size of  $\mathcal{A}^{\mathbb{Z}}$ , and each check can be done in EXPTIME, hence the satisfiability of (35) can be checked in 2-EXPTIME in the size of  $\mathcal{A}^{\mathbb{Z}}$ .
- When (35) has 1 quantifier alternation (in this case exactly one of  $\sum_{i=1}^m |A_{\mathfrak{B}_i}|$  and  $\sum_{j=1}^{|\mathfrak{E}|} |A_{\mathfrak{E}_j}|$  is equal to 0), one has  $w = 2^{cr(s+3)^2}$ . Hence the satisfiability of (35) can be checked also in 2-EXPTIME.
- When (35) has 0 quantifier alternation, i.e., all graphs  $G_{\mathfrak{B}_i}$ ,  $i \in \llbracket 1, m \rrbracket$ ,  $G_{\mathfrak{E}_j}$ ,  $j \in \llbracket 1, |\mathfrak{E}| \rrbracket$ , are singletons, the satisfiability of (35) can be checked in polynomial time.

*Remark 3* In (vi), the specifications of (35f) and (35k) to (36) and (38) are crucial steps. If we did not do this but directly specify (35f) and (35k) as they are, then (35) would have length exponential in the size of  $\mathcal{A}^{\mathbb{Z}}$ , and then the satisfiability of (35) would be checked in 3-EXPTIME in the size of  $\mathcal{A}^{\mathbb{Z}}$  by using Lemma 3.

Taking graph  $G_{\mathfrak{B}_i}^{a_i}$  for some  $i \in \llbracket 1, m \rrbracket$  for example, in order to directly specify (35f), we need to enumerate all  $\alpha$  distinct (at most exponentially many) simple paths from  $\text{head}(a_i)$  to  $\hat{q}_i^1$  as

$$\begin{aligned} & a_i^{1,1} \dots a_i^{1,1\alpha}, \\ & \vdots \\ & a_i^{\alpha,1} \dots a_i^{\alpha,\alpha\alpha}, \end{aligned}$$

where  $\text{tail}(a_i^{l,1}) = \text{head}(a_i)$ ,  $\text{head}(a_i^{l,l\alpha}) = \hat{q}_i^1$ ,  $\text{head}(a_i^{l,k_l}) = \text{tail}(a_i^{l,k_l+1})$ ,  $1 \leq l \leq \alpha$ ,  $1 \leq l_\alpha \leq |V_{\mathfrak{B}_i}^{a_i}| - 1$ ,  $1 \leq k_l \leq l_\alpha - 1$ . (35f) is directly specified as

$$\bigvee_{l=1}^{\alpha} \left( \bigwedge_{k_l=1}^{l_\alpha} (y_{a_i^{l,k_l}} > 0) \right),$$

which has length exponential in the size of  $\mathcal{A}^{\mathbb{Z}}$ .  $\square$

*Remark 4* Using the above procedure of computing observer  $\mathcal{A}_{obs}^{\mathbb{Q}^k}$  as in Items (i) through (vii), one can do state estimation based on a given weighted label sequence  $\gamma = (\sigma_1, t_1) \dots (\sigma_n, t_n)$ , where  $\sigma_i \in \Sigma$ ,  $t_i \in \mathbb{Q}^k$ ,  $i \in \llbracket 1, n \rrbracket$ : first, compute all

states  $q_1$  that are reachable from some state of  $Q_0$  through some unobservable path followed by some observable transition with an event  $e_1$  in  $E_{\sigma_1}$ , where the entire path has weight  $t$ , in nondeterministic polynomial time by Lemma 1, denote the set of all such  $q_1$  by  $x_1$ , and call  $x_1$  the  $(\sigma_1, t_1)$ -successor of  $Q_0$ ; second, compute the  $(\sigma_2, t_2 - t_1)$ -successor  $x_2$  of  $x_1$ ;  $\dots$ ; finally compute the  $(\sigma_n, t_n - t_{n-1})$ -successor  $x_n$  of  $x_{n-1}$ , then one has  $\mathcal{M}(\mathcal{A}^{\mathbb{Q}^k}, \epsilon | x_n) = \mathcal{M}(\mathcal{A}^{\mathbb{Q}^k}, \gamma)$ .  $\square$

Now we analyze the complexity of computing  $\mathcal{A}_{obs}^{\mathbb{Z}}$ . For every  $x_1 \subset Q$  (see (i)), we compute the corresponding  $x_2$  in polynomial time. For every  $\bar{x}_2 \subset x_2$  (see (ii)), we check whether  $\bar{x}_2$  is a successor of  $x_1$  and compute the corresponding transitions starting from  $x_1$  in  $\mathcal{A}_{obs}^{\mathbb{Z}}$  as follows: we compute automaton (30) for at most  $(|x_1| |\Delta_\sigma|)^{|\bar{x}_2|}$  times (see (ii) and (iii)). Then in each automaton (32) (trivially obtained from (30)) (see (iv)), we check the existence of path  $\bar{\pi}$  (see (B)) and compute transitions of  $\mathcal{A}_{obs}^{\mathbb{Z}}$  starting at  $x_1$  in NP in the size of (32) by Lemma 1, where the size of (32) is exponential in the size of  $\mathcal{A}^{\mathbb{Z}}$ . Totally we check the existence of  $\bar{\pi}$  in (32) for at most exponentially many times. Hence this part can be finished in NEXPTIME in the size of  $\mathcal{A}^{\mathbb{Z}}$ .

Consider the above  $x_1$  and  $x_2$ , for every successor  $\bar{x}_2 \subset x_2$  of  $x_1$  computed as above, for every subset  $\hat{x}_2 \subsetneq \bar{x}_2$ , we check whether there is a transition from  $x_1$  to  $\mathcal{M}(\mathcal{A}^{\mathbb{Z}}, \epsilon | \hat{x}_2)$  as in (v), (vi), (vii). When  $x_1, x_2, \hat{x}_2$  are given,  $\mathfrak{E}$  (see (34)) is also given, we need to check the satisfiability of Presburger formula (35) by Lemma 3 for at most  $(|x_1| |\Delta_\sigma|)^{|\hat{x}_2|}$  times. Totally we do the check for at most exponentially many times. Hence this part can be finished in 2-EXPTIME in the size of  $\mathcal{A}^{\mathbb{Z}}$ .

**Theorem 8** *An observer  $\mathcal{A}_{obs}^{\mathbb{Q}^k}$  (21) of a labeled weighted automaton  $\mathcal{A}^{\mathbb{Q}^k}$  can be computed in 2-EXPTIME in the size of  $\mathcal{A}^{\mathbb{Q}^k}$ .*

Particularly, for deadlock-free and divergence-free automaton  $\mathcal{A}^{\mathbb{Q}^k}$ , in which there exists no unobservable cycle, from the above procedure of computing  $\mathcal{A}_{obs}^{\mathbb{Q}^k}$ , one directly sees that the EPL problem and Presburger arithmetic are not needed, but one only needs to enumerate all (exponentially many) unobservable paths. Hence the next direct corollary follows.

**Corollary 2** *The observer  $\mathcal{A}_{obs}^{\mathbb{Q}^k}$  (21) of a divergence-free  $\mathcal{A}^{\mathbb{Q}^k}$  can be computed in EXPTIME in the size of  $\mathcal{A}^{\mathbb{Q}^k}$ .*

In Theorem 4, conditions (i) and (ii) can be verified in time linear in the size of  $\mathcal{A}^{\mathbb{Q}^k}$  by computing its strongly connected components, and condition (iii) can be verified in time linear in the size of any observer  $\mathcal{A}_{obs}^{\mathbb{Q}^k}$ . Then the following result holds.

**Theorem 9** *The weak detectability of a labeled weighted automaton  $\mathcal{A}^{\mathbb{Q}^k}$  can be verified in 2-EXPTIME in the size of  $\mathcal{A}^{\mathbb{Q}^k}$ .*

Similarly, by Theorem 5 and Theorem 8, the following result holds.

**Theorem 10** *The weak periodic detectability of a labeled weighted automaton  $\mathcal{A}^{\mathbb{Q}^k}$  can be verified in 2-EXPTIME in the size of  $\mathcal{A}^{\mathbb{Q}^k}$ .*

By Theorems 4 and 5, and Corollary 2, the following result holds.

**Corollary 3** *The weak detectability and weak periodic detectability of a labeled deadlock-free, divergence-free weighted automaton  $\mathcal{A}^{\mathbb{Q}^k}$  can be verified in EXPTIME in the size of  $\mathcal{A}^{\mathbb{Q}^k}$ . The upper bounds also apply to deadlock-free and divergence-free unambiguous weighted automata over semiring  $\underline{\mathbb{Q}}$ .*

When all transitions of  $\mathcal{A}^{\mathbb{Q}^k}$  are observable, we have the following direct corollary.

**Corollary 4** *Consider a labeled weighted automaton  $\mathcal{A}^{\mathbb{Q}^k}$  all of whose transitions are observable. Its observer  $\mathcal{A}_{obs}^{\mathbb{Q}^k}$  can be computed in EXPTIME, and its weak detectability and weak periodic detectability can be verified also in EXPTIME.*

### 3.7.3 Computation of detector $\mathcal{A}_{det}^{\mathbb{Q}^k}$ and verification of strong periodic detectability

One sees detector  $\mathcal{A}_{det}^{\mathbb{Q}^k}$  (23) is a simplified version of observer  $\mathcal{A}_{obs}^{\mathbb{Q}^k}$  (21), hence  $\mathcal{A}_{det}^{\mathbb{Q}^k}$  can be computed similarly by starting from the initial state  $x_0 = \mathcal{M}(\mathcal{A}^{\mathbb{Q}^k}, \epsilon)$ , and find all reachable states and transitions step by step, where the states (except for  $x_0$ ) are of cardinality  $\leq 2$ . Similarly to (i) in Section 3.7.2, choose a state  $x_1 \in X$  of  $\mathcal{A}_{det}^{\mathbb{Q}^k}$  that we have just computed (here  $1 \leq |x_1| \leq 2$  if  $x_1 \neq x_0$ ), choose  $\sigma \in \Sigma$ , for each  $q \in x_1$ , compute subautomaton  $\mathcal{A}_q^{\mathbb{Q}^k}$  that consists of all paths of the form

$$q \xrightarrow{s} q^1 \xrightarrow{e} q^2 \quad (39)$$

of  $\mathcal{A}^{\mathbb{Q}^k}$  such that  $s \in (E_{uo})^*$ ,  $e \in E_\sigma$ . Denote the set of all such  $q^2$  by  $x_2$ . Note that one may have  $|x_2| > 2$ .

- (1) If  $|\mathcal{M}(\mathcal{A}^{\mathbb{Q}^k}, \epsilon|x_2)| = 1$  (i.e.,  $\mathcal{M}(\mathcal{A}^{\mathbb{Q}^k}, \epsilon|x_2) = x_2$  and  $x_2$  is a singleton), then we find a transition  $x_1 \xrightarrow{(\sigma, t)} x_2$  of  $\mathcal{A}_{det}^{\mathbb{Q}^k}$ , where  $t$  can be the weight of any path from any  $q$  in  $x_1$  to the unique  $q^2$  in  $x_2$  as in (39).
- (2) If  $|\mathcal{M}(\mathcal{A}^{\mathbb{Q}^k}, \epsilon|x_2)| > 1$ , for every  $\bar{x}_2 \subset x_2$  with  $|\bar{x}_2| = 2$ , we check whether there exists two paths

$$q_i \xrightarrow{s_i} q_i^1 \xrightarrow{e_i} q_i^2, \quad i = 1, 2,$$

as in (39), such that  $q_i \in x_1$ ,  $\{q_1^2, q_2^2\} = \bar{x}_2$ , and the two paths have the same weight  $t \in \mathbb{Q}^k$ . If the answer is YES, then we find transitions  $x_1 \xrightarrow{(\sigma, t)} \bar{x}_2'$  for any  $\bar{x}_2' \subset \mathcal{M}(\mathcal{A}^{\mathbb{Q}^k}, \epsilon|\bar{x}_2)$  with  $|\bar{x}_2'| = 2$ . In each of these checks, we need to compute the synchronous product (see (30)) of two subautomata of  $\mathcal{A}^{\mathbb{Q}^k}$  (in polynomial time), and solve a 1-dimensional EPL problem in the product (by Lemma 1, in NP).



- (3) If  $|\mathcal{M}(\mathcal{A}^{\mathbb{Q}^k}, \epsilon|x_2)| > 1$ , for every  $\bar{x}_2 \subset x_2$  with  $|\bar{x}_2| = 1$  and  $|\mathcal{M}(\mathcal{A}^{\mathbb{Q}^k}, \epsilon|\bar{x}_2)| > 1$ , we find transitions  $x_1 \xrightarrow{(\sigma,t)} \bar{x}'_2$  for any  $\bar{x}'_2 \subset \mathcal{M}(\mathcal{A}^{\mathbb{Q}^k}, \epsilon|\bar{x}_2)$  with  $|\bar{x}'_2| = 2$ , where  $t$  can be the weight of any path from any  $q$  in  $x_1$  to the unique  $q^2$  in  $\bar{x}_2$  as in (39).
- (4) If  $|\mathcal{M}(\mathcal{A}^{\mathbb{Q}^k}, \epsilon|x_2)| > 1$ , for every  $\bar{x}_2 \subset x_2$  with  $|\mathcal{M}(\mathcal{A}^{\mathbb{Q}^k}, \epsilon|\bar{x}_2)| = 1$ , we check whether

there exists a path

$$\hat{q} \xrightarrow{\hat{s}} \hat{q}^1 \xrightarrow{\hat{e}} \hat{q}^2$$

as in (39), such that  $\hat{q} \in x_1$ ,  $\{\hat{q}^2\} = \bar{x}_2$ , the weight of the path is denoted by  $t \in \mathbb{Q}^k$ ; and for any  $\bar{q} \in x_1$ , for any  $q^2 \in x_2 \setminus \bar{x}_2$ , there is no path (G)

$$q \xrightarrow{s} q^1 \xrightarrow{e} q^2$$

as in (39) with weight  $t$ .

If the answer is YES, then we find a transition  $x_1 \xrightarrow{(\sigma,t)} \bar{x}_2$  of  $\mathcal{A}_{det}^{\mathbb{Q}^k}$ . We need to transform the satisfiability of (G) to satisfiability of some Presburger formula as in (v), (vi), (vii). By Lemma 3, such checks can be done in 2-EXPTIME.

**Theorem 11** Consider a labeled weighted automaton  $\mathcal{A}^{\mathbb{Q}^k}$ . An detector  $\mathcal{A}_{det}^{\mathbb{Q}^k}$  can be computed in 2-EXPTIME (in the size of  $\mathcal{A}^{\mathbb{Q}^k}$ ); particularly if for each state  $q$  of  $\mathcal{A}^{\mathbb{Q}^k}$ ,  $|\mathcal{M}(\mathcal{A}^{\mathbb{Q}^k}, \epsilon|\{q\})| > 1$  (in this case, one need not check the satisfiability of (G)), then  $\mathcal{A}_{det}^{\mathbb{Q}^k}$  can be computed in NP.

By Theorem 3, the following result holds.

**Theorem 12** Consider a labeled weighted automaton  $\mathcal{A}^{\mathbb{Q}^k}$ . Its strong periodic detectability can be verified in 2-EXPTIME. Particularly, if for each state  $q$  of  $\mathcal{A}^{\mathbb{Q}^k}$ ,  $|\mathcal{M}(\mathcal{A}^{\mathbb{Q}^k}, \epsilon|\{q\})| > 1$ , then its strong periodic detectability can be checked in NP.

By Theorem 2 and Corollary 2, the following two results hold.

**Theorem 13** The problem of verifying strong periodic detectability of a deadlock-free and divergence-free  $\mathcal{A}^{\mathbb{Q}^k}$  belongs to EXPTIME.

**Corollary 5** The detector  $\mathcal{A}_{det}^{\mathbb{Q}^k}$  (23) of a divergence-free  $\mathcal{A}^{\mathbb{Q}^k}$  can be computed in EXPTIME in the size of  $\mathcal{A}^{\mathbb{Q}^k}$ .

Similarly to the case of  $\text{CC}_A(\mathcal{A}^{\mathbb{Q}^k})$ , we have the following direct corollary.

**Corollary 6** Consider a labeled weighted automaton  $\mathcal{A}^{\mathbb{Q}^k}$  all of whose transitions are observable. Its detector  $\mathcal{A}_{det}^{\mathbb{Q}^k}$  can be computed in polynomial time, and its strong periodic detectability can be verified also in polynomial time.

For a labeled finite-state automaton  $\mathcal{A}$ , one directly sees from the above procedure of computing  $\mathcal{A}_{det}^{\mathbb{Q}^k}$  that detector  $\mathcal{A}_{det}$  can be computed in polynomial time, because all unobservable transitions of  $\mathcal{A}$  have weight 0 as shown in Remark 1. Then the following corollary holds.

**Corollary 7** *The strong periodic detectability of a labeled finite-state automaton  $\mathcal{A}$  can be verified in polynomial time.*

### 3.7.4 The complexity lower bounds on verifying strong (periodic) detectability of labeled weighted automaton $\mathcal{A}^{\mathbb{N}}$ and $\mathcal{A}^{\mathbb{N}}$

In this subsection, we prove coNP lower bounds on verifying strong detectability and strong periodic detectability of labeled deterministic weighted automata over monoid  $(\mathbb{N}, +, 0)$ . These complexity lower bounds also apply to strong detectability and strong periodic detectability of labeled deterministic weighted automata over semiring  $\mathbb{N}$ , because deterministic automata are unambiguous, and the definitions of detectability for unambiguous  $\mathcal{A}^{\mathbb{Q}}$  in [27] coincide with those for unambiguous  $\mathcal{A}^{\mathbb{Q}}$  in the current paper (except for minor and neglectable differences, see Remark 8). As a result, deterministic  $\mathcal{A}^{\mathbb{N}}$  and  $\mathcal{A}^{\mathbb{N}}$  are fundamentally more complicated than labeled finite-state automata, because it is known that strong (periodic) detectability of labeled finite-state automata can be verified in polynomial time [13, 15].

**Theorem 14** *The problems of verifying strong detectability and strong periodic detectability of labeled deterministic, deadlock-free, and divergence-free weighted automaton  $\mathcal{A}^{\mathbb{N}}$  and  $\mathcal{A}^{\mathbb{N}}$  are both coNP-hard.*

**Proof** We reduce the NP-complete subset sum problem (Problem 2) to negation of strong detectability and strong periodic detectability of labeled deterministic weighted automata over  $\mathbb{N}$  (hence also over  $\mathbb{N}$ ).

Given positive integers  $n_1, \dots, n_m$ , and  $N$ , next we construct in polynomial time a labeled deterministic weighted automaton  $\mathcal{A}_2^{\mathbb{N}}$  as illustrated in Fig. 10. Apparently,  $\mathcal{A}_2^{\mathbb{N}}$  is deadlock-free and divergence-free.  $q_0$  is the unique initial state and has initial time delay 0. Events  $u_1, u_2$  are unobservable. Event  $e$  is observable and  $\ell(e) = e$ . For all  $i \in \llbracket 0, m-1 \rrbracket$ , there exist two unobservable transitions  $q_i \xrightarrow{u_1/n_{i+1}} q_{i+1}$  and  $q_i \xrightarrow{u_2/0} q_{i+1}$ . The observable transitions are  $q_m \xrightarrow{e/1} q_{m+1}^1$ ,  $q_0 \xrightarrow{e/N+1} q_{m+1}^2$ , and two self-loops  $q_{m+1}^1 \xrightarrow{e/1} q_{m+1}^1$  and  $q_{m+1}^2 \xrightarrow{e/1} q_{m+1}^2$ .

Suppose there exists  $I \subset \llbracket 1, m \rrbracket$  such that  $N = \sum_{i \in I} n_i$ . Then there is an unobservable path  $\pi \in q_0 \rightsquigarrow q_m$  whose weight is equal to  $N$ . Then we have

$$\ell(\tau(\pi \xrightarrow{e} q_{m+1}^1)) = (e, N+1), \quad (40)$$

$$\mathcal{M}(\mathcal{A}_2^{\mathbb{N}}, (e, N+1) \dots (e, N+k)) = \{q_{m+1}^1, q_{m+1}^2\} \quad (41)$$

for all  $k \in \mathbb{Z}_+$ .

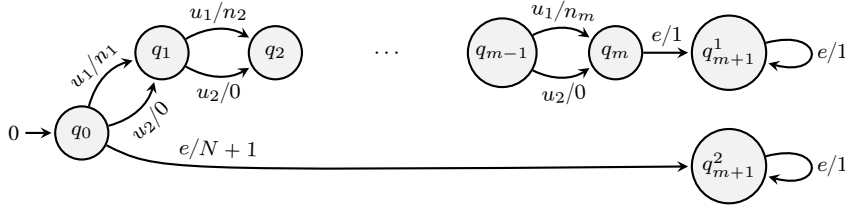

Fig. 10 Sketch of the reduction in the proof of Theorem 14.

Choose

$$w = \tau(\pi \xrightarrow{e} q_{m+1}^1 \xrightarrow{e} q_{m+1}^1)^\omega \in L^\omega(\mathcal{A}_2^{\mathbb{N}}).$$

Then

$$\ell(w) = (e, N+1)(e, N+2) \dots$$

Choose prefix  $\gamma_k = (e, N+1) \dots (e, N+k) \sqsubset \ell(w)$ . Then we have  $|\gamma_k| \geq k$  and  $|\mathcal{M}(\mathcal{A}_2^{\mathbb{N}}, \gamma_k)| > 1$  by (41). Hence  $\mathcal{A}_2^{\mathbb{N}}$  is not strongly detectable.

For all  $k \in \mathbb{N}$ , choose the above  $w$ , choose  $w' = \tau(\pi \xrightarrow{e} q_{m+1}^1) \sqsubset w$ , for all  $w''$  such that  $w'w'' \sqsubset w$  and  $|\ell(w'w'')| < k$ , we have  $|\mathcal{M}(\mathcal{A}_2^{\mathbb{N}}, \ell(w'w''))| > 1$  by (41). Hence  $\mathcal{A}_2^{\mathbb{N}}$  is not strongly periodically detectable.

Suppose for all  $I \subset \llbracket 1, m \rrbracket$ ,  $N \neq \sum_{i \in I} n_i$ . Then for all  $\pi' \in q_0 \rightsquigarrow q_m$ , one has

$$\begin{aligned} \ell(\tau(\pi' \xrightarrow{e} q_{m+1}^1)) &= (e, N' + 1) \text{ for some } N' \neq N, \\ \mathcal{M}(\mathcal{A}_2^{\mathbb{N}}, \ell(\tau(\pi' \xrightarrow{e} q_{m+1}^1))) &= \{q_{m+1}^1\}, \\ \mathcal{M}(\mathcal{A}_2^{\mathbb{N}}, (e, N' + 1) \dots (e, N' + k)) &= \{q_{m+1}^1\}, \\ \mathcal{M}(\mathcal{A}_2^{\mathbb{N}}, (e, N + 1) \dots (e, N + k)) &= \{q_{m+1}^2\} \end{aligned}$$

for all  $k \in \mathbb{Z}_+$ . Hence  $\mathcal{A}_2^{\mathbb{N}}$  is strongly detectable and strongly periodically detectable.  $\square$

The next corollary directly follows from Theorem 7 and Theorem 14.

**Corollary 8** *The problems of verifying strong detectability of labeled unambiguous weighted automaton  $\mathcal{A}^{\mathbb{Q}^k}$  and  $\mathcal{A}^{\mathbb{Q}}$  are both coNP-complete.*

### 3.8 Illustrative examples

In this subsection, we illustrate how to use Theorem 1, Theorem 3, Theorem 4, and Theorem 5 to verify strong (periodic) detectability and weak (periodic) detectability of labeled weighted automata over monoid  $(\mathbb{N}, +, 0)$  and labeled unambiguous weighted automata over semiring  $\mathbb{N}$ .

*Example 12* Reconsider labeled unambiguous weighted automaton  $\mathcal{A}_0^{\mathbb{N}}$  (the same as  $\mathcal{A}_0^{\mathbb{N}}$ ) in Fig. 3. Its detectability cannot be verified by using the method developed in [27] (see Remark 9). Next we show how to verify its detectability by using the methods proposed in the current paper.

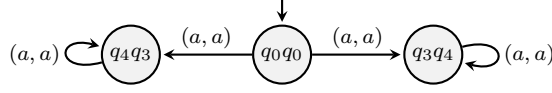

**Fig. 11** Self-composition  $CC_A(\mathcal{A}_0^{\mathbb{N}})$  of the automaton  $\mathcal{A}_0^{\mathbb{N}}$  in Fig. 3.

Its self-composition  $CC_A(\mathcal{A}_0^{\mathbb{N}})$  is shown in Fig. 11. The self-loops on  $(q_3, q_4)$  and on  $(q_4, q_3)$  are easy to find. We use the method developed in Section 3.7.1 to check whether there exists a transition  $((q_0, q_0), (a, a), (q_3, q_4))$ : (1) Guess transitions  $q_1 \xrightarrow{a/1} q_3$  and  $q_2 \xrightarrow{a/1} q_4$  of  $\mathcal{A}_0^{\mathbb{N}}$ . (2) Compute subautomaton  $\mathcal{A}_{q_0}^{\mathbb{N}}$  as in Fig. 12 and asynchronous product  $\mathcal{A}_{q_0}^{\mathbb{N}} \otimes \mathcal{A}_{q_0}^{\mathbb{N}}$  as in Fig. 13 and check in weighted directed graph  $\mathcal{A}_{q_0}^{\mathbb{N}} \otimes \mathcal{A}_{q_0}^{\mathbb{N}}$ , whether there exists a path from  $(q_0, q_0)$  to  $(q_1, q_2)$  with weight 0. By using the solution to the 1-dimensional EPL problem given in [39], we can find several such paths, e.g.,  $(q_0, q_0) \xrightarrow{-1} (q_0, q_2) \xrightarrow{9} (q_1, q_2)$ .

In  $CC_A(\mathcal{A}_0^{\mathbb{N}})$ , there exists a self-loop on the reachable state  $(q_3, q_4)$ , then a transition sequence as in (24) exists. In addition, in  $\mathcal{A}_0^{\mathbb{N}}$ , there exists a self-loop on  $q_3$ , then (ii) of Theorem 1 holds. By Theorem 1,  $\mathcal{A}_0^{\mathbb{N}}$  is not strongly detectable. By definition, we choose infinite path  $q_0 \xrightarrow{u} q_1 \left( \xrightarrow{a} q_3 \right)^\omega$ , and choose path  $\pi_n = q_0 \xrightarrow{u} q_1 \left( \xrightarrow{a} q_3 \right)^n$ , then we have  $\ell(\tau(\pi_n)) = (a, 11) \dots (a, 10+n)$ , and  $\mathcal{M}(\mathcal{A}_0^{\mathbb{N}}, \ell(\tau(\pi_n))) = \{q_3, q_4\}$ , hence we also have  $\mathcal{A}_0^{\mathbb{N}}$  is not strongly detectable.

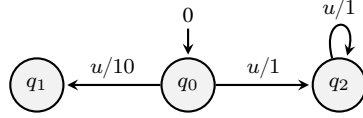

**Fig. 12** Subautomaton  $\mathcal{A}_{q_0}^{\mathbb{N}}$  of the automaton  $\mathcal{A}_0^{\mathbb{N}}$  in Fig. 3.

One observer  $\mathcal{A}_{0obs}^{\mathbb{N}}$  (also detector  $\mathcal{A}_{0det}^{\mathbb{N}}$ ) is shown in Fig. 14. We use the method developed in Section 3.7.2 to check whether  $\{q_0\} \xrightarrow{(a,11)} \{q_3, q_4\}$  and  $\{q_0\} \xrightarrow{(a,2)} \{q_4\}$  are transitions of  $\mathcal{A}_{0obs}^{\mathbb{N}}$ . For the former, by the path  $(q_0, q_0) \xrightarrow{-1} (q_0, q_2) \xrightarrow{9} (q_1, q_2)$  with weight 0 in Fig. 13 and transitions  $q_1 \xrightarrow{a/1} q_3$  and  $q_2 \xrightarrow{a/1} q_4$ , we know that  $\{q_3, q_4\}$  is a successor of  $\{q_0\}$  (see (iii) in Section 3.7.2), and then obtain the transition  $\{q_0\} \xrightarrow{(a,11)} \mathcal{M}(\mathcal{A}_0^{\mathbb{N}}, \epsilon|\{q_3, q_4\})$ , where  $\mathcal{M}(\mathcal{A}_0^{\mathbb{N}}, \epsilon|\{q_3, q_4\}) = \{q_3, q_4\}$ ; for the latter, one sees a transition sequence  $q_0 \xrightarrow{u/1} q_2 \xrightarrow{a/1} q_4$  with weight 2, but the

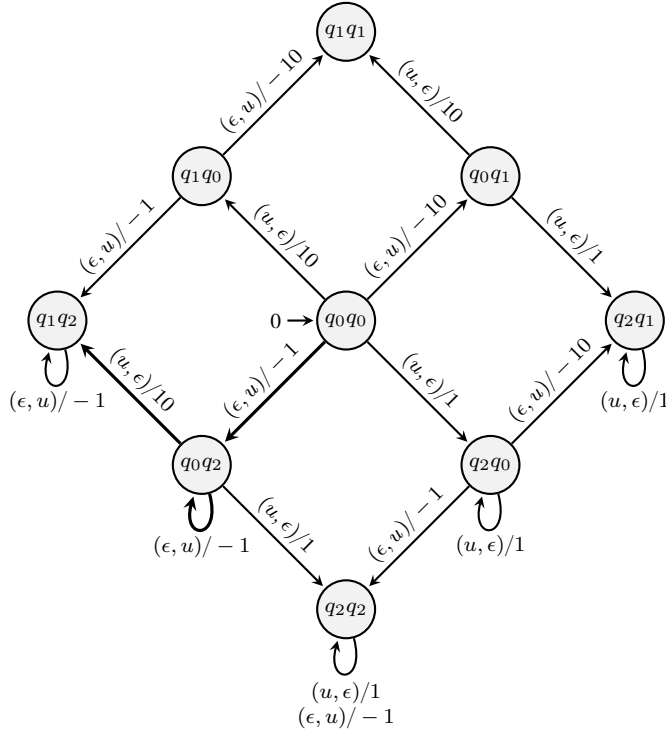

**Fig. 13** Asynchronous product  $\mathcal{A}_{q_0}^{\mathbb{N}} \otimes \mathcal{A}_{q_0}^{\mathbb{N}}$  of subautomaton  $\mathcal{A}_{q_0}^{\mathbb{N}}$  (in Fig. 12) of the automaton  $\mathcal{A}_0^{\mathbb{N}}$  in Fig. 3.

unique transition sequence from  $q_0$  to  $q_3$  is  $q_0 \xrightarrow{u/10} q_1 \xrightarrow{a/1} q_3$  having weight 11 that is not equal to 2, so  $\{q_0\} \xrightarrow{(a,2)} \{q_4\}$  is also a transition. On the other hand, since there is a transition sequence  $q_0 \left( \xrightarrow{u/1} q_2 \right)^{10} \xrightarrow{a/1} q_4$  having the same weight as  $q_0 \xrightarrow{u/10} q_1 \xrightarrow{a/1} q_3$ , there is no transition from  $\{q_0\}$  to  $\mathcal{M}(\mathcal{A}_0^{\mathbb{N}}, \epsilon | \{q_3\}) = \{q_3\}$ . In observer  $\mathcal{A}_{0obs}^{\mathbb{N}}$  (also detector  $\mathcal{A}_{0det}^{\mathbb{N}}$ ), there is a self-loop on a reachable state  $\{q_3, q_4\}$  of cardinality 2, then (2) of Theorem 3 holds, hence  $\mathcal{A}_0^{\mathbb{N}}$  is not strongly periodically detectable. Consider infinite path  $\pi = q_0 \left( \xrightarrow{u} q_2 \right)^{\omega}$ , one has  $\tau(\pi) = (u, 1)(u, 2) \dots$ , and  $\ell(\tau(\pi)) = \epsilon \in (\{a\} \times \mathbb{N})^*$ , then (ii) of Theorem 4 holds, and  $\mathcal{A}_0^{\mathbb{N}}$  is weakly detectable. Moreover, one has  $\mathcal{M}(\mathcal{A}_0^{\mathbb{N}}, \epsilon) = \{q_0\}$ , then (ii) of Theorem 5 holds, and  $\mathcal{A}_0^{\mathbb{N}}$  is weakly periodically detectable.

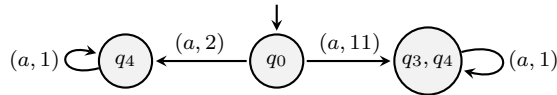

**Fig. 14** One observer  $\mathcal{A}_{0obs}^{\mathbb{N}}$  (also detector  $\mathcal{A}_{0det}^{\mathbb{N}}$ ) of the automaton  $\mathcal{A}_0^{\mathbb{N}}$  in Fig. 3.

□

*Example 13* Reconsider automaton  $\mathcal{A}_1^{\mathbb{N}}$  shown in Fig. 4.

In its self-composition shown in Fig. 5, there exists a unique cycle, i.e., a self-loop on state  $(q_4, q_4)$ ; there exists no state of the form  $(q, q')$  satisfying  $q \neq q'$  reachable from the unique cycle. Then there exists no transition sequence shown in (24). By Theorem 1,  $\mathcal{A}_1^{\mathbb{N}}$  is strongly detectable. By definition,  $\mathcal{A}_1^{\mathbb{N}}$  is strongly detectable by choosing  $k = 2$ .

In one of its detectors obtained from Fig. 6 by changing  $\mathbb{Z}_+$  to 1, there exists a reachable state  $\{q_1, q_2\}$  satisfying  $|\{q_1, q_2\}| > 1$ , and in  $\mathcal{A}_1^{\mathbb{N}}$ , there exists an unobservable self-loop on  $q_1$ . Then (1) in Theorem 3 is satisfied, so  $\mathcal{A}_1^{\mathbb{N}}$  is not strongly periodically detectable. By definition, for all  $k \in \mathbb{N}$ , choose  $w_k = \tau \left( q_0 \xrightarrow{a} q_1 \left( \xrightarrow{u} q_1 \right)^{\omega} \right) = (a, 1)(u, 2)(u, 3) \dots$ ,  $w' = (a, 1) \sqsubset w_k$ ; for all  $w'' = (u, 2) \dots (u, i) \sqsubset (u, 2)(u, 3) \dots$ , one has  $w'w'' \sqsubset w_k$ ,  $\ell(w'') = \epsilon$ , and  $\mathcal{M}(\mathcal{A}_1^{\mathbb{N}}, \ell(w'w'')) = \mathcal{M}(\mathcal{A}_1^{\mathbb{N}}, (a, 1)) = \{q_1, q_2\}$ , so  $\mathcal{A}_1^{\mathbb{N}}$  is not strongly periodically detectable.

In one of its observers also obtained from Fig. 6 by changing  $\mathbb{Z}_+$  to 1, one sees that (iii) in Theorem 4 is satisfied, so  $\mathcal{A}_1^{\mathbb{N}}$  is weakly detectable. On the other hand, we have  $(a, 1)(u, 2)(u, 3) \dots \in L^{\omega}(\mathcal{A}_1^{\mathbb{N}})$  such that  $\ell((a, 1)(u, 2)(u, 3) \dots) = (a, 1) \in (\Sigma \times \mathbb{N})^+$ , (ii) of Theorem 4 is also satisfied, one then also has  $\mathcal{A}_1^{\mathbb{N}}$  is weakly detectable. Similarly, (iii) in Theorem 5 is satisfied, so  $\mathcal{A}_1^{\mathbb{N}}$  is weakly periodically detectable. □

*Example 14* Reconsider automaton  $\mathcal{A}_2^{\mathbb{N}}$  in the proof of Theorem 14 (in Fig. 10).

Assume that the subset sum problem has a solution, that is, there exists  $I \subset \llbracket 1, m \rrbracket$  such that  $N = \sum_{i \in I} n_i$ . We consider  $m > 1$ .

The self-composition of  $\mathcal{A}_2^{\mathbb{N}}$  is shown in Fig. 15. The initial state  $(q_0, q_0)$  transitions to a self-loop on  $(q_{m+1}^1, q_{m+1}^2)$  and then also to the state  $(q_{m+1}^1, q_{m+1}^2)$  such that  $q_{m+1}^1 \neq q_{m+1}^2$ . In  $\mathcal{A}_2^{\mathbb{N}}$ , there is a self-loop on  $q_{m+1}^1$ . Then by Theorem 1,  $\mathcal{A}_2^{\mathbb{N}}$  is not strongly detectable.

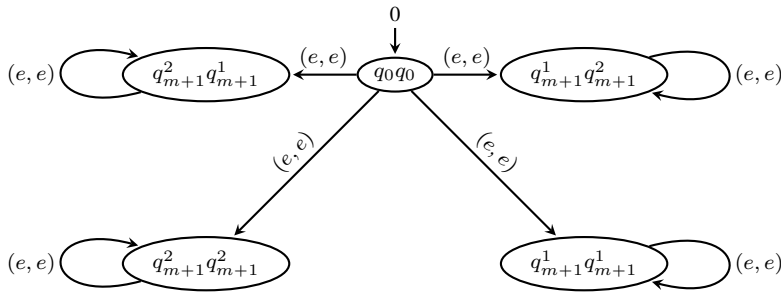

**Fig. 15** Self-composition of  $\mathcal{A}_2^{\mathbb{N}}$  in Fig. 10 when the subset sum problem has a solution.

The observers (also the detectors) of  $\mathcal{A}_2^{\mathbb{N}}$  are shown in Fig. 16. The initial state  $x_0$  transitions to a self-loop on  $\{q_{m+1}^1, q_{m+1}^2\}$ , where  $\{q_{m+1}^1, q_{m+1}^2\}$  is of cardinality 2, then (ii) of Theorem 2 and (2) of Theorem 3 are satisfied. By Theorem 2 or Theorem 3,  $\mathcal{A}_2^{\mathbb{N}}$  is not strongly periodically detectable. On the other hand,  $x_0$  transitions to a self-loop on  $\{q_{m+1}^1\}$ , where  $\{q_{m+1}^1\}$  is of cardinality 1, then (iii) of Theorem 4 is satisfied. By Theorem 4,  $\mathcal{A}_2^{\mathbb{N}}$  is weakly detectable. In addition, (iii) of Theorem 5 is satisfied. By Theorem 5,  $\mathcal{A}_2^{\mathbb{N}}$  is weakly periodically detectable.

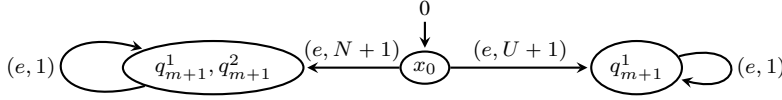

**Fig. 16** Observers (also detectors) of  $\mathcal{A}_2^{\mathbb{N}}$  in Fig. 10 when the subset sum problem has a solution, where  $x_0 = \mathcal{M}(\mathcal{A}_2^{\mathbb{N}}, \epsilon) = \{q_0, \dots, q_m\}$ ,  $U$  can be the sum of elements of any subset of  $\{n_1, \dots, n_m\}$  different from  $N$ .

Assume that the subset sum problem has no solution, that is, for all  $I \subset \llbracket 1, m \rrbracket$ ,  $N \neq \sum_{i \in I} n_i$ .

The self-composition of  $\mathcal{A}_2^{\mathbb{N}}$  is shown in Fig. 17, in which there is no reachable state of the form  $(q, q')$  such that  $q \neq q'$ . Then by Theorem 1,  $\mathcal{A}_2^{\mathbb{N}}$  is strongly detectable.

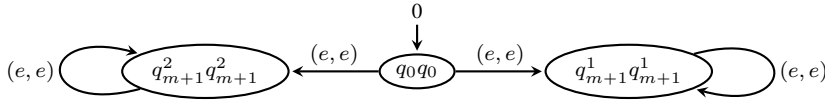

**Fig. 17** Self-composition of  $\mathcal{A}_2^{\mathbb{N}}$  in Fig. 10 when the subset sum problem has no solution.

The observers (also the detectors) of  $\mathcal{A}_2^{\mathbb{N}}$  are shown in Fig. 18. The initial state  $x_0$  satisfies that  $|x_0| > 1$ , but there is no unobservable cycle in  $\mathcal{A}_2^{\mathbb{N}}$ , that is, (1) of Theorem 3 is not satisfied. Apparently, (2) of Theorem 3 is not satisfied either. Hence  $\mathcal{A}_2^{\mathbb{N}}$  is strongly periodically detectable. Here  $x_0$  also transitions to a self-loop in which the state is of cardinality 1 (e.g.,  $\{q_{m+1}^1\}$ ), then by Theorem 4 and Theorem 5,  $\mathcal{A}_2^{\mathbb{N}}$  is weakly detectable and weakly periodically detectable.

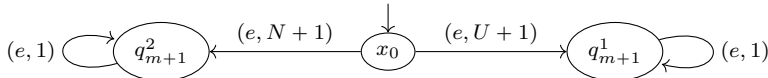

**Fig. 18** Observers (also detectors) of  $\mathcal{A}_2^{\mathbb{N}}$  in Fig. 10 when the subset sum problem has no solution, where  $x_0 = \mathcal{M}(\mathcal{A}_2^{\mathbb{N}}, \epsilon) = \{q_0, \dots, q_m\}$ ,  $U$  can be the sum of elements of any subset of  $\{n_1, \dots, n_m\}$ .

□

## 4 Initial exploration of detectability in labeled timed automata

As mentioned in the last paragraph of Section 1.1, a labeled weighted automaton  $\mathcal{A}^{\mathbb{Q}_{\geq 0}}$  is actually a one-clock labeled timed automaton in which the clock is reset along with every occurrence of every event and all clock constraints are singletons. In this section, we initially explore detectability in general labeled timed automata, and show some relations between a labeled weighted automaton  $\mathcal{A}^{\mathbb{R}}$  and a labeled timed automaton  $\mathcal{A}^{\bar{x}}$ .

### 4.1 Notation

Let  $\Sigma$  be an alphabet, a *timed word* over  $\Sigma$  is a finite sequence  $(a_1, t_1) \dots (a_n, t_n)$ , where  $n \in \mathbb{N}$ ,  $a_1, \dots, a_n \in \Sigma$ ,  $t_1, \dots, t_n \in \mathbb{R}_{\geq 0}$ ,  $t_1 \leq \dots \leq t_n$ . The set of timed words over  $\Sigma$  is denoted by  $\text{TW}^*(\Sigma)$ . An  *$\omega$ -timed word* over  $\Sigma$  is an infinite sequence  $(a_1, t_1)(a_2, t_2) \dots$ , where  $a_i \in \Sigma$ ,  $t_i \in \mathbb{R}_{\geq 0}$ ,  $t_i \leq t_{i+1}$ ,  $i \in \mathbb{Z}_+$ . The set of  $\omega$ -timed words over  $\Sigma$  is denoted by  $\text{TW}^\omega(\Sigma)$ .

A labeled timed automaton<sup>4</sup> [23, 44] is formulated as

$$\mathcal{A}^{\bar{x}} = (Q, E, Q_0, C, \Delta, \Sigma, \ell), \quad (42)$$

where  $Q$  is a finite set of *states*,  $E$  a finite *alphabet* (elements of  $E$  are called *events*),  $Q_0 \subset Q$  a set of *initial states*,  $C$  a finite set of *clocks* (i.e., real variables),  $\Delta \subset Q \times E \times Q \times 2^C \times \Phi(C)$  the set of *edges*,  $\ell : E \rightarrow \Sigma \cup \{\epsilon\}$  a labeling function. The observable event set  $E_o$  and unobservable event set  $E_{uo}$  are defined in the same way as those for  $\mathcal{A}^{\mathbb{R}}$  (3). Labeling function  $\ell$  is also recursively extended to  $E^* \cup E^\omega \rightarrow \Sigma^* \cup \Sigma^\omega$ . A timed automaton is actually an  $\mathcal{A}^{\bar{x}}$  in which  $\ell$  is the identity mapping. In the sequel, by “a timed automaton  $\bar{\mathcal{A}}^{\bar{x}}$ ” we mean the automaton obtained from  $\mathcal{A}^{\bar{x}}$  by removing all its labels, including  $\epsilon$ . In this case, one directly observes every occurrence of every event.

An edge  $(q, e, q', \lambda, \zeta)$  represents a transition from state  $q$  to state  $q'$  when event  $e$  occurs and the current *clock interpretation* satisfies the *clock constraint*  $\zeta$  with the clocks in the *reset subset*  $\lambda \subset C$  reset (to 0). A clock interpretation is a mapping  $v : C \rightarrow \mathbb{R}_{\geq 0}$  which assigns to each clock a nonnegative real number. A clock constraint  $\zeta$  over  $C$  is defined inductively by

$$\zeta := x \leq c \mid c \leq x \mid \neg \zeta \mid \zeta_1 \wedge \zeta_2,$$

<sup>4</sup> In order to study detectability, the model (42) is obtained by adding a labeling function to the original model of timed automata proposed in [26], and in addition, the final states in the original model are omitted. Adding a labeling function brings in essential difficulties. For example, event-recording automata are a special class of timed automata which are determinizable, so the deterministic timed automaton obtained by determinizing an event-recording automaton can be regarded as the observer of the latter and hence can be used to verify current-state opacity of the latter, where current-state opacity means that for a generated event sequence, if its last state is secret, then there is another generated event sequence whose last state is not secret such that the two event sequences generate the same label sequence. However, current-state opacity (called L-opacity in [44]) is undecidable in deterministic labeled event-recording automata [44].



where  $x$  is a clock in  $C$  and  $c$  is a nonnegative rational constant. A clock interpretation  $\lambda$  satisfies a clock constraint  $\zeta$  if and only if  $\zeta$  evaluates to true using the values given by  $v$ . For a clock interpretation  $v$ , a constant  $t \in \mathbb{R}_{\geq 0}$ , and a reset set  $\lambda \subset C$ ,  $v + t$  denotes the clock interpretation that assigns to each clock  $x$  the value  $v(x) + t$ ,  $[\lambda \mapsto t]v$  denotes the clock interpretation that assigns  $t$  to each clock in  $\lambda$  and agrees with  $v$  over the rest of the clocks.

A pair  $(q, v)$  is called a *configuration*, where  $q \in Q$ ,  $v \in (\mathbb{R}_{\geq 0})^C$  (i.e.,  $v$  is a clock interpretation). An *infinite run* of  $\mathcal{A}^{\mathfrak{X}}$  is defined as an alternating sequence

$$\begin{aligned} \pi := & (q_0, v_0) \xrightarrow{t_1} (q_0, v_0 + t_1) \xrightarrow[\lambda_1, \zeta_1]{e_1} (q_1, v_1) \cdots \\ & (q_i, v_i) \xrightarrow{t_{i+1}} (q_i, v_i + t_{i+1}) \xrightarrow[\lambda_{i+1}, \zeta_{i+1}]{e_{i+1}} (q_{i+1}, v_{i+1}) \cdots, \end{aligned} \quad (43)$$

or briefly as

$$\pi := (q_0, v_0) \xrightarrow[\lambda_1, \zeta_1]{t_1, e_1} (q_1, v_1) \cdots (q_i, v_i) \xrightarrow[\lambda_{i+1}, \zeta_{i+1}]{t_{i+1}, e_{i+1}} (q_{i+1}, v_{i+1}) \cdots, \quad (44)$$

where  $q_0 \in Q_0$ ,  $v_0(x) = 0$  for all  $x \in C$ , for all  $i \in \mathbb{N}$ , one has  $t_i \geq 0$ ,  $v_i + t_{i+1}$  satisfies  $\zeta_{i+1}$ ,  $v_{i+1} = [\lambda_{i+1} \mapsto 0](v_i + t_{i+1})$ ,  $(q_i, e_{i+1}, q_{i+1}, \lambda_{i+1}, \zeta_{i+1}) \in \Delta$ .

When  $\mathcal{A}^{\mathfrak{X}}$  was in a state  $q$  at time instant a nonnegative real number  $\tau$  with clock interpretation  $v$ , as time elapsed,  $v$  might become  $v + t$  with  $t$  a nonnegative real number. If there was a transition  $(q, e, q', \lambda, \zeta)$  in  $\Delta$  and  $v + t$  satisfies  $\zeta$ , then the automaton could transition to state  $q'$  at time instant  $\tau + t$  with the occurrence of  $e$ , and meanwhile  $v + t$  was changed to  $[\lambda \mapsto 0](v + t)$ , i.e., all clocks in  $\lambda$  were reset and all clocks outside  $\lambda$  remained invariant.

For an infinite run  $\pi$  as in (43), the sequence  $(e_1, t_1) \dots (e_i, \sum_{j=1}^i t_j) \dots$  is called its  $\omega$ -*timed word* and denoted by  $\tau(\pi)$ . We use  $L^\omega(\mathcal{A}^{\mathfrak{X}})$  to denote the set of the  $\omega$ -timed words of infinite runs of  $\mathcal{A}^{\mathfrak{X}}$ . Similarly, a *finite run* is defined as a prefix of an infinite run  $\pi$  (43) ending with some  $(q_i, v_i + t_{i+1}) \xrightarrow[\lambda_{i+1}, \zeta_{i+1}]{e_{i+1}} (q_{i+1}, v_{i+1})$ , then its *timed word* is defined by  $(e_1, t_1) \dots (e_{i+1}, \sum_{j=1}^{i+1} t_j)$  and its *time*, denoted by  $\text{time}(\pi)$ , is defined by  $\sum_{j=1}^{i+1} t_j$ . We use  $L(\mathcal{A}^{\mathfrak{X}})$  to denote the set of the timed words of finite runs of  $\mathcal{A}^{\mathfrak{X}}$ .

A labeled timed automaton  $\mathcal{A}^{\mathfrak{X}}$  is *deterministic* if

- $|Q_0| = 1$ ,
- for every two different edges of the form  $(q, e, -, -, \zeta_1)$  and  $(q, e, -, -, \zeta_2)$ ,  $\zeta_1 \wedge \zeta_2$  is unsatisfiable.

In a deterministic  $\mathcal{A}^{\mathfrak{X}}$ , for an edge  $(q, e, q', \lambda, \zeta)$ , once  $q, e, \zeta$  are fixed,  $q'$  and  $\lambda$  are uniquely determined. And for an edge of the form  $(q, e, -, -, \zeta)$  and a clock interpretation  $v$ , once  $q, e, v$  are fixed, there is at most one  $\zeta$  such that  $v$  satisfies  $\zeta$ . Hence for an edge  $(q, e, q', \lambda, \zeta)$  and a clock interpretation  $v$ , one has  $q, e, v$  uniquely determine  $q', \lambda, \zeta$ . Consequently, for a deterministic  $\mathcal{A}^{\mathfrak{X}}$ , consider an infinite run  $\pi$  (43), if  $q_0, v_0$  and its  $\omega$ -timed word are fixed, then the whole run is uniquely determined.

Labeling function  $\ell$  is also extended to  $E \times \mathbb{R}_{\geq 0}$  and recursively extended to  $(E \times \mathbb{R}_{\geq 0})^* \cup (E \times \mathbb{R}_{\geq 0})^\omega$  in the same way as those for  $\mathcal{A}^{\text{mt}}$  (3). The *observation* to a (finite or infinite) run  $\pi$  is defined by timed label sequence  $\ell(\tau(\pi))$  based on a conventional setting in which there is a clock outside  $\mathcal{A}^{\text{t}}$  that is never reset and can record global time instants of the occurrences of all events, where the setting has been widely used in the studies of fault diagnosis of  $\mathcal{A}^{\text{t}}$  [23] and opacity of  $\mathcal{A}^{\text{t}}$  [44]. For a timed label sequence  $\gamma \in (\Sigma \times \mathbb{R}_{\geq 0})^*$ , the *current-state estimate*  $\mathcal{M}(\mathcal{A}^{\text{t}}, \gamma)$ <sup>5</sup> is defined by the set of states in  $Q$  that are reachable from  $Q_0$  via some finite run the observation to which is  $\gamma$ , where after the last observable event in the run, no time elapses. Formally,

$$\mathcal{M}(\mathcal{A}^{\text{t}}, \epsilon) = Q_0 \cup \{q \in Q | (\exists \text{run } (q_0, v_0) \xrightarrow[\lambda_1, \zeta_1]{0, e_1} \dots \xrightarrow[\lambda_{i+1}, \zeta_{i+1}]{0, e_{i+1}} (q_{i+1}, v_{i+1})) \quad (45)$$

$$[(e_1, \dots, e_{i+1} \in E_{uo}) \wedge (i \in \mathbb{N})]\},$$

for all  $\gamma \in (\Sigma \times \mathbb{R}_{\geq 0})^+$ ,

$$\mathcal{M}(\mathcal{A}^{\text{t}}, \gamma) = \{(\exists \text{run } (q_0, v_0) \xrightarrow[\lambda_1, \zeta_1]{t_1, e_1} \dots \xrightarrow[\lambda_{i+1}, \zeta_{i+1}]{t_{i+1}, e_{i+1}} (q_{i+1}, v_{i+1})$$

$$\xrightarrow[\lambda_{i+2}, \zeta_{i+2}]{t_{i+2}, e_{i+2}} \dots \xrightarrow[\lambda_{i+j+1}, \zeta_{i+j+1}]{t_{i+j+1}, e_{i+j+1}} (q_{i+j+1}, v_{i+j+1})) \quad (46)$$

$$[(e_{i+1} \in E_o) \wedge (e_{i+2}, \dots, e_{i+j+1} \in E_{uo}) \wedge (i, j \in \mathbb{N}) \wedge$$

$$\ell(\tau((q_0, v_0) \xrightarrow[\lambda_1, \zeta_1]{t_1, e_1} \dots \xrightarrow[\lambda_{i+1}, \zeta_{i+1}]{t_{i+1}, e_{i+1}} (q_{i+1}, v_{i+1})) = \gamma)]\}.$$

#### 4.2 Relation between $\mathcal{A}^{\mathbb{Q}_{\geq 0}}$ and $\mathcal{A}^{\text{t}}$

Consider labeled weighted automaton  $\mathcal{A}^{\mathbb{Q}_{\geq 0}}$  (3), if we remove the weights on the initial states, and replace each transition  $q \xrightarrow[\mu(e)_{qq'}]{e} q'$  by an edge  $(q, e, q', \{x\}, x = \mu(e)_{qq'})$ , then  $\mathcal{A}^{\mathbb{Q}_{\geq 0}}$  becomes an equivalent labeled timed automaton with a single clock  $x$ , where  $x$  is reset along with every occurrence of every event. The paths (starting from initial states) of the former correspond to the runs of the latter, and the timed words of the paths coincide with the timed words of the runs. Hence by definition, a deterministic  $\mathcal{A}^{\mathbb{Q}_{\geq 0}}$  is a deterministic labeled timed automaton, but not vice versa.

*Example 15* Reconsider the labeled weighted automaton  $\mathcal{A}_1^{\mathbb{N}}$  in Fig. 4.

Automaton  $\mathcal{A}_1^{\mathbb{N}}$  can be equivalently represented as the labeled timed automaton  $\mathcal{A}_1^{\text{t}}$  shown in Fig. 19. Consider the finite run

$$\pi_1 = (q_0, 0) \xrightarrow{1} (q_0, 1) \xrightarrow[\{x\}, x=1]{a} (q_1, 0) \xrightarrow{2} (q_1, 2) \xrightarrow[\{x\}, x=2]{b} (q_3, 0), \quad (47)$$

its timed word and timed label sequence are

$$\tau(\pi_1) = (a, 1)(b, 3) \text{ and} \quad (48a)$$

<sup>5</sup> corresponding to  $\mathcal{M}(\mathcal{A}^{\text{mt}}, \gamma)$  (15)

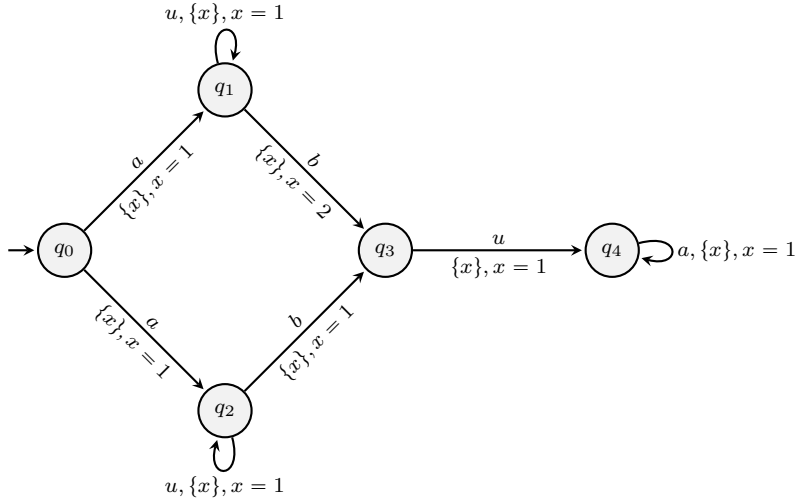

**Fig. 19** Labeled timed automaton  $\mathcal{A}_1^{\mathbb{Z}}$  that is equivalent to the labeled weighted automaton  $\mathcal{A}_1^{\mathbb{N}}$  in Fig. 4, where  $x$  is the unique clock and reset whenever an event occurs,  $\ell(u) = \epsilon$ ,  $\ell(a) = \ell(b) = \rho$ .

$$\ell(\tau(\pi_1)) = (\rho, 1)(\rho, 3), \text{ respectively.} \quad (48b)$$

Note that the run  $\pi_1$  in (47) is consistent with the path  $\pi_1$  in (11a), the timed word  $\tau(\pi_1)$  and timed label sequence  $\ell(\tau(\pi_1))$  in (48) are the same as those in (12a).  $\square$

### 4.3 The definitions of detectability

We reformulate the four definitions of detectability for labeled timed automata.

**Definition 10 (SD)** A labeled timed automaton  $\mathcal{A}^{\mathbb{Z}}$  (42) is called *strongly detectable* if there is  $t \in \mathbb{Z}_+$ , for every  $\omega$ -timed word  $w \in L^\omega(\mathcal{A}^{\mathbb{Z}})$ , for each prefix  $\gamma$  of  $\ell(w)$ , if  $|\gamma| \geq t$ , then  $|\mathcal{M}(\mathcal{A}^{\mathbb{Z}}, \gamma)| = 1$ .

**Definition 11 (SPD)** A labeled timed automaton  $\mathcal{A}^{\mathbb{Z}}$  (42) is called *strongly periodically detectable* if there is  $t \in \mathbb{Z}_+$ , for every  $\omega$ -timed word  $w \in L^\omega(\mathcal{A}^{\mathbb{Z}})$ , for every prefix  $w' \sqsubset w$ , there is  $w'' \in (E \times \mathbb{R}_{\geq 0})^*$  such that  $|\ell(w'')| < t$ ,  $w'w'' \sqsubset w$ , and  $|\mathcal{M}(\mathcal{A}^{\mathbb{Z}}, \ell(w'w''))| = 1$ .

**Definition 12 (WD)** A labeled timed automaton  $\mathcal{A}^{\mathbb{Z}}$  (42) is called *weakly detectable* if  $L^\omega(\mathcal{A}^{\mathbb{Z}}) \neq \emptyset$  implies that there is  $t \in \mathbb{Z}_+$ , for some  $\omega$ -timed word  $w \in L^\omega(\mathcal{A}^{\mathbb{Z}})$ , for each prefix  $\gamma$  of  $\ell(w)$ , if  $|\gamma| \geq t$ , then  $|\mathcal{M}(\mathcal{A}^{\mathbb{Z}}, \gamma)| = 1$ .

**Definition 13 (WPD)** A labeled timed automaton  $\mathcal{A}^{\mathbb{Z}}$  (42) is called *weakly periodically detectable* if  $L^\omega(\mathcal{A}^{\mathbb{Z}}) \neq \emptyset$  implies that there is  $t \in \mathbb{Z}_+$ , for some  $\omega$ -timed word  $w \in L^\omega(\mathcal{A}^{\mathbb{Z}})$ , for each prefix  $w' \sqsubset w$ , there is  $w'' \in (E \times \mathbb{R}_{\geq 0})^*$  such that  $|\ell(w'')| < t$ ,  $w'w'' \sqsubset w$ , and  $|\mathcal{M}(\mathcal{A}^{\mathbb{Z}}, \ell(w'w''))| = 1$ .

By definition, a deterministic timed automaton satisfies the four definitions of detectability.

#### 4.4 Decidability and undecidability of detectability

In this section, we prove that in labeled timed automata, the strong detectability verification problem is PSPACE-complete, while weak (periodic) detectability is undecidable, which remarkably differentiates a labeled timed automaton  $\mathcal{A}^{\mathbb{T}}$  from a labeled weighted automaton  $\mathcal{A}^{\mathbb{Q}^k}$ .

In order to prove PSPACE-hardness of verifying strong detectability, we use the following reduction that is almost the same as the one used to prove PSPACE-hardness of verifying diagnosability of labeled timed automata [23]. Given a deterministic timed automaton  $\bar{\mathcal{A}}^{\mathbb{T}}$  (which is always detectable as mentioned above) and a target state  $q_f$ , add two transitions from  $q_f$  to two new states  $q_1$  and  $q_2$ , and add two self-loops on  $q_1$  and  $q_2$ , all the four transitions have the same event and the same clock constraint **true**. Call the new automaton  $\bar{\mathcal{A}}_{ext}^{\mathbb{T}}$ . All the events of  $\bar{\mathcal{A}}_{ext}^{\mathbb{T}}$  are set to be observable with themselves as their labels. Then, it can be seen that  $q_f$  is reachable in  $\bar{\mathcal{A}}^{\mathbb{T}}$  if and only if  $\bar{\mathcal{A}}_{ext}^{\mathbb{T}}$  is not strongly (periodically) detectable. By the PSPACE-hardness of the reachability problem in deterministic timed automata [26], we have it is PSPACE-hard to verify strong (periodic) detectability of labeled timed automata.

In order to verify strong detectability of  $\mathcal{A}^{\mathbb{T}}$ , we use the standard *parallel composition*  $\mathcal{A}^{\mathbb{T}} \parallel \mathcal{A}^{\mathbb{T}}$  [23] in which observable edges of  $\mathcal{A}^{\mathbb{T}}$  with the same label are synchronized but unobservable edges interleave. We make two copies of  $\mathcal{A}^{\mathbb{T}}$ ,  $\mathcal{A}_i^{\mathbb{T}} = (Q_i, E_i, Q_0^i, C_i, \Delta_i, \Sigma, \ell_i)$ ,  $i = 1, 2$ , by renaming states, events, and clocks of  $\mathcal{A}^{\mathbb{T}}$ :

- Each state  $q$  of  $\mathcal{A}^{\mathbb{T}}$  is renamed  $q_1$  in  $\mathcal{A}_1^{\mathbb{T}}$  and  $q_2$  in  $\mathcal{A}_2^{\mathbb{T}}$ .
- Each event  $e$  of  $\mathcal{A}^{\mathbb{T}}$  is renamed  $e_1$  in  $\mathcal{A}_1^{\mathbb{T}}$  and  $e_2$  in  $\mathcal{A}_2^{\mathbb{T}}$ .
- Each clock  $x$  of  $\mathcal{A}^{\mathbb{T}}$  is renamed  $x_1$  in  $\mathcal{A}_1^{\mathbb{T}}$  and  $x_2$  in  $\mathcal{A}_2^{\mathbb{T}}$ .
- The edges are copied and renamed correspondingly.
- For  $i = 1, 2$ , for all events  $e_i \in E_i$ ,  $\ell_i(e_i) := \ell(e)$ .

$\mathcal{A}^{\mathbb{T}} \parallel \mathcal{A}^{\mathbb{T}}$  is defined by

$$(Q', E', Q_0', C', \Delta', \Sigma, \ell'), \quad (49)$$

where  $Q' = Q_1 \times Q_2$ ,  $E' = \{(e_1, e_2) \mid e_1 \in E_1, e_2 \in E_2, \ell_1(e_1) = \ell_2(e_2) \in \Sigma\} \cup \{(e_1, \epsilon) \mid e_1 \in E_1, \ell_1(e_1) = \epsilon\} \cup \{(\epsilon, e_2) \mid e_2 \in E_2, \ell_2(e_2) = \epsilon\}$ ,  $Q_0' = Q_0^1 \times Q_0^2$ ,  $C' = C_1 \cup C_2$ , for every two observable edges  $(q_i, e_i, q'_i, \lambda_i, \zeta_i)$  of  $\mathcal{A}_i^{\mathbb{T}}$ ,  $i = 1, 2$ , with  $\ell_1(e_1) = \ell_2(e_2) \in \Sigma$ , construct an observable edge  $((q_1, q_2), (e_1, e_2), (q'_1, q'_2), \lambda_1 \cup \lambda_2, \zeta_1 \wedge \zeta_2)$  of  $\mathcal{A}^{\mathbb{T}} \parallel \mathcal{A}^{\mathbb{T}}$ , for every unobservable edge  $(q_1, e_1, q'_1, \lambda_1, \zeta_1)$  of  $\mathcal{A}_1^{\mathbb{T}}$  and every state  $q_2$  of  $\mathcal{A}_2^{\mathbb{T}}$ , construct an unobservable edge  $((q_1, q_2), (e_1, \epsilon), (q'_1, q_2), \lambda_1, \zeta_1)$  of  $\mathcal{A}^{\mathbb{T}} \parallel \mathcal{A}^{\mathbb{T}}$ , for every state  $q_1$  of  $\mathcal{A}_1^{\mathbb{T}}$  and every unobservable edge  $(q_2, e_2, q'_2, \lambda_2, \zeta_2)$  of  $\mathcal{A}_2^{\mathbb{T}}$ , construct an unobservable edge  $((q_1, q_2), (\epsilon, e_2), (q_1, q'_2), \lambda_2, \zeta_2)$  of  $\mathcal{A}^{\mathbb{T}} \parallel \mathcal{A}^{\mathbb{T}}$ , for every event  $(e_1, e_2) \in E'$ ,  $\ell'((e_1, e_2)) := \ell_1(e_1) = \ell_2(e_2)$ .

$\mathcal{A}^{\mathbb{T}} \parallel \mathcal{A}^{\mathbb{T}}$  can be computed in time polynomial in the size of  $\mathcal{A}^{\mathbb{T}}$ . Let  $\rho$  be a finite run of  $\mathcal{A}^{\mathbb{T}} \parallel \mathcal{A}^{\mathbb{T}}$ , for  $i = 1, 2$ , let  $\rho^i$  be obtained by erasing all elements of  $\mathcal{A}_{3-i}^{\mathbb{T}}$  from  $\rho$

and aggregating all consecutive time delays without events between them. Then one has  $\rho$  is a finite run of  $\mathcal{A}^{\boxtimes} \parallel \mathcal{A}^{\boxtimes}$  if and only if  $\rho^1$  and  $\rho^2$  are finite runs of  $\mathcal{A}_1^{\boxtimes}$  and  $\mathcal{A}_2^{\boxtimes}$ , respectively, and for such  $\rho, \rho^1, \rho^2$ , one has  $\text{time}(\rho) = \text{time}(\rho^1) = \text{time}(\rho^2)$  [23]. For example, consider finite run

$$\begin{aligned} \rho = & ((q_0^1, q_0^2), (v_0^1, v_0^2)) \xrightarrow[\lambda_1^1 \cup \lambda_1^2, \zeta_1^1 \wedge \zeta_1^2]{t_1, (e_1^1, e_1^2)} ((q_1^1, q_1^2), (v_1^1, v_1^2)) \xrightarrow[\lambda_2^2, \zeta_2^2]{t_2, (\epsilon, e_2^2)} \\ & ((q_1^1, q_2^2), (v_2^1, v_2^2)) \xrightarrow[\lambda_3^1 \cup \lambda_3^2, \zeta_3^1 \wedge \zeta_3^2]{t_3, (e_3^1, e_3^2)} ((q_3^1, q_3^2), (v_3^1, v_3^2)), \end{aligned}$$

the corresponding  $\rho^1$  and  $\rho^2$  are as follows:

$$\begin{aligned} \rho^1 = & (q_0^1, v_0^1) \xrightarrow[\lambda_1^1, \zeta_1^1]{t_1, e_1^1} (q_1^1, v_1^1) \xrightarrow[\lambda_3^1, \zeta_3^1]{t_2+t_3, e_3^1} (q_3^1, v_3^1), \\ \rho^2 = & (q_0^2, v_0^2) \xrightarrow[\lambda_2^2, \zeta_2^2]{t_1, e_1^2} (q_1^2, v_1^2) \xrightarrow[\lambda_2^2, \zeta_2^2]{t_2, e_2^2} (q_2^2, v_2^2) \xrightarrow[\lambda_3^2, \zeta_3^2]{t_3, e_3^2} (q_3^2, v_3^2). \end{aligned}$$

Then

$$\begin{aligned} \text{time}(\rho) = \text{time}(\rho^1) = \text{time}(\rho^2) &= t_1 + t_2 + t_3, \\ \ell(\tau(\rho)) = \ell(\tau(\rho^1)) = \ell(\tau(\rho^2)) &= (\ell(e_1^1), t_1)(\ell(e_3^1), t_1 + t_2 + t_3). \end{aligned}$$

*Example 16* Reconsider the labeled timed automaton  $\mathcal{A}_1^{\boxtimes}$  in Example 15 (shown in Fig. 19). Part of the parallel composition  $\mathcal{A}_1^{\boxtimes} \parallel \mathcal{A}_1^{\boxtimes}$  is shown in Fig. 20.  $\square$

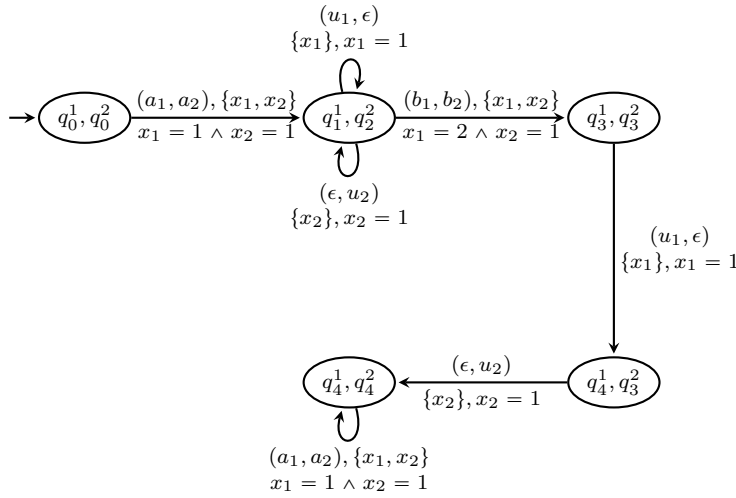

**Fig. 20** Part of the parallel composition  $\mathcal{A}_1^{\boxtimes} \parallel \mathcal{A}_1^{\boxtimes}$ , where  $\mathcal{A}_1^{\boxtimes}$  is in Fig 19.

By using the parallel composition  $\mathcal{A}^{\mathfrak{T}} \parallel \mathcal{A}^{\mathfrak{T}}$ , we give an equivalent condition for strong detectability of  $\mathcal{A}^{\mathfrak{T}}$  (analogous to the equivalent condition for strong detectability of labeled weighted automaton  $\mathcal{A}^{\mathfrak{M}}$  in Theorem 1 based on its self-composition  $\text{CC}_A(\mathcal{A}^{\mathfrak{M}})$ ). Differently from Theorem 1 in which  $\text{CC}_A(\mathcal{A}^{\mathfrak{M}})$  was directly used, here  $\mathcal{A}^{\mathfrak{T}} \parallel \mathcal{A}^{\mathfrak{T}}$  cannot be directly used because  $\mathcal{A}^{\mathfrak{T}}$  is time-variant, i.e., when  $\mathcal{A}^{\mathfrak{T}}$  was in the same state at different time instants, the possible next transitions may vary. We use the region automaton [26] of  $\mathcal{A}^{\mathfrak{T}} \parallel \mathcal{A}^{\mathfrak{T}}$  to obtain the equivalent condition.

The region automaton  $\text{RA}(\bar{\mathcal{A}}^{\mathfrak{T}})$  of a timed automaton  $\bar{\mathcal{A}}^{\mathfrak{T}}$  (here labels are not useful) is actually a finite-state automaton each of whose states is a pair of a state of  $\bar{\mathcal{A}}^{\mathfrak{T}}$  and a clock region (a special subset of  $(\mathbb{R}_{\geq 0})^C$ ). The set  $(\mathbb{R}_{\geq 0})^C$  is partitioned into a finite number of subsets (called clock regions) based on a special equivalence relation  $\sim$  on  $\mathbb{R}_{\geq 0}^C$ , where each clock region is an equivalence class and each clock of all vectors in the same clock region will be reset in the same order as time advances (if possible). We refer the reader to [26] for details of constructing such a finite partition and a region automaton. The size of a region automaton is exponential in the size of  $\bar{\mathcal{A}}^{\mathfrak{T}}$ . The runs of an  $\bar{\mathcal{A}}^{\mathfrak{T}}$  correspond to the runs of its region automaton  $\text{RA}(\bar{\mathcal{A}}^{\mathfrak{T}})$ . In detail, for every run  $\pi$  (44), after replacing each  $v_i$  by the clock region  $[v_i]_{\sim}$  generated by  $v_i$  and removing each  $t_i, \lambda_i, \zeta_i$ , then a run of  $\text{RA}(\bar{\mathcal{A}}^{\mathfrak{T}})$  is obtained. Finding a run of  $\bar{\mathcal{A}}^{\mathfrak{T}}$  that corresponds to a given run of  $\text{RA}(\bar{\mathcal{A}}^{\mathfrak{T}})$  can also be done (although more complicatedly). Then based on the correspondence and argument similar to that in the proof of Theorem 1, the following result holds.

**Theorem 15** *A labeled timed automaton  $\mathcal{A}^{\mathfrak{T}}$  (42) is not strongly detectable if and only if in the region automaton  $\text{RA}(\mathcal{A}^{\mathfrak{T}} \parallel \mathcal{A}^{\mathfrak{T}})$  of the parallel composition  $\mathcal{A}^{\mathfrak{T}} \parallel \mathcal{A}^{\mathfrak{T}}$  (49),*

(i) *there exists a transition sequence*

$$((q_0^1, q_0^2), R_0) \xrightarrow{s'_1} ((q_1^1, q_1^2), R_1) \xrightarrow{s'_2} ((q_1^1, q_1^2), R_1) \xrightarrow{s'_3} ((q_2^1, q_2^2), R_2)$$

*such that  $((q_0^1, q_0^2), R_0)$  is initial,  $s'_2$  contains at least one observable event of  $\mathcal{A}^{\mathfrak{T}} \parallel \mathcal{A}^{\mathfrak{T}}$ ,  $q_1^1 \neq q_2^1$ ,*

(ii)  *$(q_2^1, R_2|_{C_1})$  is reachable in the region automaton  $\text{RA}(\mathcal{A}^{\mathfrak{T}})$  of  $\mathcal{A}^{\mathfrak{T}}$  and there is a cycle reachable from  $(q_2^1, R_2|_{C_1})$  in  $\text{RA}(\mathcal{A}^{\mathfrak{T}})$ , where  $R_2|_{C_1}$  is the projection of clock region  $R_2$  to the left component of  $\mathcal{A}^{\mathfrak{T}} \parallel \mathcal{A}^{\mathfrak{T}}$ .*

By using nondeterministic search, the conditions in Theorem 15 can be checked in NPSpace, without computing the whole  $\text{RA}(\mathcal{A}^{\mathfrak{T}} \parallel \mathcal{A}^{\mathfrak{T}})$  and  $\text{RA}(\mathcal{A}^{\mathfrak{T}})$ . Hence by  $\text{coNPSpace} = \text{NPSpace} = \text{PSPACE}$ , the following complexity result follows.

**Theorem 16** *The strong detectability verification problem is PSPACE-complete in labeled timed automata.*

In labeled weighted automaton  $\mathcal{A}^{\mathfrak{Q}^k}$ , we have proven that weak (periodic) detectability can be verified in 2-EXPTIME (Theorem 9 and Theorem 10), however, here the two properties become undecidable in labeled timed automata. We will use the following undecidable problem to do reduction.

**Problem 3 (Universality)** Let  $\bar{\mathcal{A}}_{single}^{\Sigma}$  be a timed automaton with a single state, a single event  $a$ , and using clock constants 0 and 1 only. Decide whether  $L(\bar{\mathcal{A}}_{single}^{\Sigma}) = \text{TW}^*(\{a\})$ , i.e., whether  $\bar{\mathcal{A}}_{single}^{\Sigma}$  accepts every timed word over alphabet  $\{a\}$ .

**Lemma 5 ([45])** *Problem 3 is undecidable.*

By Lemma 5 ([45, Theorem 1]), we prove the undecidability of weak (periodic) detectability.

**Theorem 17** *The weak (periodic) detectability of timed automata is undecidable.*

**Proof** Given a timed automaton  $\bar{\mathcal{A}}_{single}^{\Sigma}$  with a single state  $q_0$ , a single event  $a$ , and using clock constants 0 and 1 only. Add a new initial state  $q'_0$  and self-loop on  $q'_0$  with event  $a$  and clock constraint **true**. The newly added timed automaton is denoted by  $\tilde{\mathcal{A}}_{single}^{\Sigma}$ . It is easy to see that  $\tilde{\mathcal{A}}_{single}^{\Sigma}$  is deterministic and accepts every timed word over alphabet  $\{a\}$  (i.e.,  $L(\tilde{\mathcal{A}}_{single}^{\Sigma}) = \text{TW}^*(\{a\})$ ), and  $L^{\omega}(\tilde{\mathcal{A}}_{single}^{\Sigma}) = \text{TW}^{\omega}(\{a\})$ . Set  $\ell(a) = a$ , i.e.,  $a$  is observable. As mentioned above, every deterministic timed automaton is detectable. Choose a timed word  $w$  in  $\text{TW}^*(\{a\}) \setminus L(\bar{\mathcal{A}}_{single}^{\Sigma})$  (if any), construct an  $\omega$ -timed word  $w' = w(a, \text{time}(w)+1)(a, \text{time}(w)+2) \dots \in L^{\omega}(\tilde{\mathcal{A}}_{single}^{\Sigma})$ , then for every timed label sequence  $\gamma \sqsubset \ell(\tau(w'))$ , if  $|\gamma| \geq |w|$  then  $\mathcal{M}(\bar{\mathcal{A}}_{single}^{\Sigma} \cup \tilde{\mathcal{A}}_{single}^{\Sigma}, \gamma) = \{q'_0\}$ . Hence  $L(\bar{\mathcal{A}}_{single}^{\Sigma}) = \text{TW}^*(\{a\})$  if and only if  $\bar{\mathcal{A}}_{single}^{\Sigma} \cup \tilde{\mathcal{A}}_{single}^{\Sigma}$  is not weakly (periodically) detectable.  $\square$

*Remark 5* In [23], for labeled timed automata, it is proven that the diagnosability verification problem is PSPACE-complete, and a *diagnoser* (supposed to be recursive, see [46]) is also constructed and fault diagnosis is done in 2-EXPTIME in the size of a given labeled timed automaton and in the length of a given timed labeled sequence. This diagnoser can be regarded as an observer, because it can be used to do state estimation. However, it cannot be computed with complexity upper bounds, because if so, then it could be used to verify weak (periodic) detectability and current-state opacity which are undecidable (Theorem 17, [44]) in labeled timed automata.  $\square$

*Remark 6* The results above in this section were all obtained over weakly monotone time, i.e., in a  $(\omega)$ -timed word, its time sequence is (not necessarily strictly) increasing. All these results also hold over strongly monotone time, i.e., in a  $(\omega)$ -timed word, its time sequence is strictly increasing. The reachability problem is also PSPACE-hard in deterministic timed automata over strongly monotone time [26], so the strong (periodic) detectability verification problem is also PSPACE-hard in labeled timed automata over strongly monotone time. The PSPACE-easiness of verifying strong detectability of labeled timed automata can be obtained by using the region automata of timed automata over strongly monotone time [26] (the difference of region automata over strongly monotone time and over weakly monotone time can be found in [47]). The undecidability of the weak (periodic) detectability problem can be proved by using the undecidability of the universality problem for timed automata with a single state, a single event, and using clock constants 1, 2, and 3 only, over strongly monotone time ([45, Theorem 2]).  $\square$

## 5 conclusion

In this paper, we extended the notions of concurrent composition, observer, and detector from labeled finite-state automata to labeled weighted automata over monoids. By using these extended notions, we gave equivalent conditions for four fundamental notions of detectability (i.e., strong (periodic) detectability and weak (periodic) detectability) for such automata. Particularly, for a labeled weighted automaton  $\mathcal{A}^{\mathbb{Q}^k}$  over the monoid  $(\mathbb{Q}^k, +)$ , we proved that its concurrent composition, observer, and detector can be computed in NP, 2-EXPTIME, and 2-EXPTIME, respectively. Moreover, for  $\mathcal{A}^{\mathbb{Q}^k}$ , we gave a coNP upper bound on verifying its strong detectability, and 2-EXPTIME upper bounds on verifying its strong periodic detectability and weak (periodic) detectability. We also gave coNP lower bounds for verifying strong (periodic) detectability of labeled deterministic weighted automata over monoid  $(\mathbb{N}, +, 0)$ .

The original methods developed in the current paper have been extended to labeled real-time automata which are a subclass of labeled timed automata with a single clock and whose clock constraints are all intervals in  $\mathbb{R}_{\geq 0}$  with rational or infinite endpoints [48]. Four definitions of state-based opacity were formulated for labeled real-time automata in [49], and were also verified in 2-EXPTIME by using the observers of labeled real-time automata computable in 2-EXPTIME. The results in the current paper and those in [49] provide all technical details for computing observers of labeled real-time automata.

In addition, in order to differentiate labeled weighted automata over monoids from labeled timed automata, we also initially explored detectability in labeled timed automata, and proved that the strong detectability verification problem is PSPACE-complete, while weak (periodic) detectability is undecidable.

It is the first time that the detectability verification results for general labeled weighted automata over monoid  $(\mathbb{Q}^k, +)$  were obtained algorithmically. The original methods proposed in the current paper will provide foundations for characterizing other fundamental properties such as diagnosability and opacity, for general labeled weighted automata over monoids. The algorithms for computing the observers of  $\mathcal{A}^{\mathbb{Q}^k}$  could also imply that many results obtained in labeled finite-state automata under the supervisory control framework can be extended to  $\mathcal{A}^{\mathbb{Q}^k}$ . Several related open problems are as follows: whether the detectors of a general  $\mathcal{A}^{\mathbb{Q}^k}$  can be computed in coNP, whether strong periodic detectability of a general  $\mathcal{A}^{\mathbb{Q}^k}$  can be verified in coNP, what the complexity low bounds for verifying weak (periodic) detectability of  $\mathcal{A}^{\mathbb{Q}^k}$  are, studies on basic properties of labeled weighted automata over other monoids, etc.

## References

1. E.F. Moore. Gedanken-experiments on sequential machines. *Automata Studies, Annals of Math. Studies*, 34:129–153, 1956.
2. R.E. Kalman. Mathematical description of linear dynamical systems. *Journal of the Society for Industrial and Applied Mathematics Series A Control*, 1(12):152–192, 1963.



3. A. Giua and C. Seatzu. Observability of place/transition nets. *IEEE Transactions on Automatic Control*, 47(9):1424–1437, Sep 2002.
4. S. Shu, F. Lin, and H. Ying. Detectability of discrete event systems. *IEEE Transactions on Automatic Control*, 52(12):2356–2359, Dec 2007.
5. S. Sandberg. *Homing and Synchronizing Sequences*, pages 5–33. Springer Berlin Heidelberg, Berlin, Heidelberg, 2005.
6. K. Zhang, L. Zhang, and R. Su. A weighted pair graph representation for reconstructibility of Boolean control networks. *SIAM Journal on Control and Optimization*, 54(6):3040–3060, 2016.
7. M. Sampath, R. Sengupta, S. Lafortune, K. Sinnamohideen, and D. Teneketzis. Diagnosability of discrete-event systems. *IEEE Transactions on Automatic Control*, 40(9):1555–1575, Sep 1995.
8. C. N. Hadjicostis. *Estimation and Inference in Discrete Event Systems*. Communications and Control Engineering. Springer Nature Switzerland AG, 2020.
9. K. Zhang. A unified method to decentralized state detection and fault diagnosis/prediction of discrete-event systems. *Fundamenta Informaticae*, 181:339–371, 2021.
10. L. Mazaré. Using unification for opacity properties. In *Proceedings of the Workshop on Issues in the Theory of Security (WITS'04)*, pages 165–176, 2004.
11. W.M. Wonham and K. Cai. *Supervisory Control of Discrete-Event Systems*. Springer International Publishing, 2019.
12. C. G. Cassandras and S. Lafortune. *Introduction to Discrete Event Systems*. Springer Publishing Company, Incorporated, 2nd edition, 2010.
13. S. Shu and F. Lin. Generalized detectability for discrete event systems. *Systems & Control Letters*, 60(5):310–317, 2011.
14. K. Zhang. The problem of determining the weak (periodic) detectability of discrete event systems is PSPACE-complete. *Automatica*, 81:217–220, 2017.
15. K. Zhang and A. Giua.  $K$ -delayed strong detectability of discrete-event systems. In *Proceedings of the 58th IEEE Conference on Decision and Control (CDC)*, pages 7647–7652, Dec 2019.
16. T. Masopust. Complexity of deciding detectability in discrete event systems. *Automatica*, 93:257–261, 2018.
17. K. Zhang and A. Giua. Weak (approximate) detectability of labeled Petri net systems with inhibitor arcs. *IFAC-PapersOnLine*, 51(7):167–171, 2018. 14th IFAC Workshop on Discrete Event Systems WODES 2018.
18. T. Masopust and X. Yin. Deciding detectability for labeled Petri nets. *Automatica*, 104:238–241, 2019.
19. K. Zhang and A. Giua. On detectability of labeled Petri nets and finite automata. *Discrete Event Dynamic Systems*, 30(3):465–497, 2020.
20. H. Lan, Y. Tong, J. Guo, and C. Seatzu. Verification of C-detectability using Petri nets. *Information Sciences*, 528:294–310, 2020.
21. C. Keroglou and C. N. Hadjicostis. Verification of detectability in probabilistic finite automata. *Automatica*, 86:192–198, 2017.
22. X. Yin. Initial-state detectability of stochastic discrete-event systems with probabilistic sensor failures. *Automatica*, 80:127–134, 2017.
23. S. Tripakis. Fault diagnosis for timed automata. In Werner Damm and Ernst Rüdiger Olderog, editors, *Formal Techniques in Real-Time and Fault-Tolerant Systems*, pages 205–221, Berlin, Heidelberg, 2002. Springer Berlin Heidelberg.
24. F. Cassez. The complexity of codiagnosability for discrete event and timed systems. *IEEE Transactions on Automatic Control*, 57(7):1752–1764, July 2012.
25. J. Li, D. Lefebvre, C.N. Hadjicostis, and Z. Li. Observers for a class of timed automata based on elapsed time graphs. *IEEE Transactions on Automatic Control*, page online, 2021.
26. R. Alur and D. L. Dill. A theory of timed automata. *Theoretical Computer Science*, 126(2):183–235, 1994.
27. A. Lai, S. Lahaye, and A. Giua. Verification of detectability for unambiguous weighted automata. *IEEE Transactions on Automatic Control*, 66(3):1437–1444, 2021.
28. A. Lai, S. Lahaye, and J. Komenda. Observer construction for polynomially ambiguous max-plus automata. *IEEE Transactions on Automatic Control*, page online, 2021.
29. L. Daviaud, I. Jecker, P.-A. Reynier, and D. Villevalois. Degree of sequentiality of weighted automata. In Javier Esparza and Andrzej S. Murawski, editors, *Foundations of Software Science and Computation Structures*, pages 215–230, Berlin, Heidelberg, 2017. Springer Berlin Heidelberg.
30. M.-P. Béal and O. Carton. Determinization of transducers over finite and infinite words. *Theoretical Computer Science*, 289(1):225–251, 2002.

31. M. Sipser. *Introduction to the Theory of Computation*. International Thomson Publishing, 1st edition, 1996.
32. P. E. Caines, R. Greiner, and S. Wang. Dynamical logic observers for finite automata. In *Proceedings of the 27th IEEE Conference on Decision and Control*, pages 226–233 vol.1, Dec 1988.
33. P. E. Caines, R. Greiner, and S. Wang. Classical and logic-based dynamic observers for finite automata. *IMA Journal of Mathematical Control and Information*, 8(1):45–80, 03 1991.
34. F. Cassez and S. Tripakis. Fault diagnosis with static and dynamic observers. *Fundamenta Informaticae*, 88(4):497–540, 2008.
35. M. Hack. Petri net languages. Technical report, Cambridge, MA, USA, 1975.
36. K. Zhang, L. Zhang, and L. Xie. *Discrete-Time and Discrete-Space Dynamical Systems*. Communications and Control Engineering. Springer International Publishing, 2020.
37. H. C. Yen. A unified approach for deciding the existence of certain Petri net paths. *Information and Computation*, 96(1):119–137, 1992.
38. M. F. Atig and P. Habermehl. On Yen’s path logic for Petri nets. In Olivier Bournez and Igor Potapov, editors, *Reachability Problems*, pages 51–63, Berlin, Heidelberg, 2009. Springer Berlin Heidelberg.
39. M. Nykänen and E. Ukkonen. The exact path length problem. *Journal of Algorithms*, 42(1):41–53, 2002.
40. E. Grädel. Subclasses of Presburger arithmetic and the polynomial-time hierarchy. *Theoretical Computer Science*, 56(3):289–301, 1988.
41. M.R. Garey and D.S. Johnson. *Computers and Intractability: A Guide to the Theory of NP-Completeness*. W. H. Freeman & Co., USA, 1990.
42. C.H. Papadimitriou. On the complexity of integer programming. *J. ACM*, 28(4):765–768, October 1981.
43. A. Schrijver. *Theory of Linear and Integer Programming*. John Wiley & Sons, Inc., USA, 1986.
44. F. Cassez. The dark side of timed opacity. In Jong Hyuk Park, Hsiao-Hwa Chen, Mohammed Atiquz-zaman, Changhoon Lee, Tai-hoon Kim, and Sang-Soo Yeo, editors, *Advances in Information Security and Assurance*, pages 21–30, Berlin, Heidelberg, 2009. Springer Berlin Heidelberg.
45. S. Adams, J. Ouaknine, and J. Worrell. Undecidability of universality for timed automata with minimal resources. In Jean-François Raskin and P. S. Thiagarajan, editors, *Formal Modeling and Analysis of Timed Systems*, pages 25–37, Berlin, Heidelberg, 2007. Springer Berlin Heidelberg.
46. P. Bouyer, F. Chevalier, and D. D’Souza. Fault diagnosis using timed automata. In *Proceedings of the 8th International Conference on Foundations of Software Science and Computation Structures*, FOSSACS’05, pages 219–233, Berlin, Heidelberg, 2005. Springer-Verlag.
47. J. Ouaknine and J. Worrell. Universality and language inclusion for open and closed timed automata. In Oded Maler and Amir Pnueli, editors, *Hybrid Systems: Computation and Control*, pages 375–388, Berlin, Heidelberg, 2003. Springer Berlin Heidelberg.
48. C. Dima. Real-time automata. *Journal of Automata, Languages and Combinatorics*, 6:3–24, 01 2001.
49. K. Zhang. State-Based Opacity of Real-Time Automata. In Alonso Castillo-Ramirez, Pierre Guillon, and Kévin Perrot, editors, *27th IFIP WG 1.5 International Workshop on Cellular Automata and Discrete Complex Systems (AUTOMATA 2021)*, volume 90 of *Open Access Series in Informatics (OA-SIcs)*, pages 12:1–12:15, Dagstuhl, Germany, 2021. Schloss Dagstuhl – Leibniz-Zentrum für Informatik.
50. A. Lai, S. Lahaye, and A. Giua. State estimation of max-plus automata with unobservable events. *Automatica*, 105:36–42, 2019.
51. A. Turing. On computable numbers, with an application to the Entscheidungsproblem. In *Proceedings of the London Mathematical Society*, pages 230–265, 1936.

## Appendix

*Remark 7* Now we illustrate how to compute the observer of labeled weighted automaton  $\mathcal{A}_0^{\mathbb{N}}$  in Fig. 3 defined in [25]. First, we unfold states of  $\mathcal{A}_0^{\mathbb{N}}$ . Because the maximum among the weights of all outgoing transitions of  $q_0$  is 10, we unfold  $q_0$  to  $q_{0,1}, \dots, q_{0,11}$ . Similarly, we unfold  $q_i$  to  $q_{i,1}, q_{i,2}, i \in \llbracket 1, 4 \rrbracket$ . Then we obtain the

intermediate automaton as in Fig. 21, where “1” means time delay “1” without transition, “0” means an unobservable transition, and  $a$  means an observable transition. Second, we compute the powerset construction of the intermediate automaton as in Fig. 22. Third, we remove redundant states from the powerset construction and then recover states of  $\mathcal{A}_0^{\mathbb{N}}$  as in Fig. 23, where all  $q_{i,\max(q_i)}$  were removed except for those as ending states of  $a$ -transitions, then change all the remaining  $q_{i,j}$  to  $q_i$ , now we obtain the observer. Fourth, the observer is simplified as in Fig. 24 (by accumulating 1-transitions), which is similar to but a little different from the observer  $\mathcal{A}_{0obs}^{\mathbb{N}}$  defined in the current paper (as in Fig. 14).

In [25], for divergence-free  $\mathcal{A}^{\mathbb{Q}_{\geq 0}}$ , an observer (obtained in the above third step) has at most  $\sum_{k=0}^{|Q|} \binom{|Q|}{k} (2^M)^k = (1 + 2^M)^{|Q|}$  states and at most  $(1 + 2^M)^{|Q|} (2^M + |\Sigma|)$  transitions; for general  $\mathcal{A}^{\mathbb{Q}_{\geq 0}}$ , an observer (obtained in the above third step, e.g., in Fig. 23) has at most  $2^{2^M |Q|}$  states and at most  $2^{2^M |Q|} (2^M + |\Sigma|)$  transitions, where  $|Q|$  denotes the number of states of  $\mathcal{A}^{\mathbb{Q}_{\geq 0}}$ ;  $M = \log_2 (\max_{i \in \llbracket 1, l \rrbracket} \{Nm_i/n_i\})$ ;  $m_1/n_1, \dots, m_l/n_l$  are enumerations of all positive weights of  $\mathcal{A}^{\mathbb{Q}_{\geq 0}}$ ;  $m_i$  and  $n_i$ ,  $i \in \llbracket 1, l \rrbracket$ , are relatively positive prime integers;  $N$  is the least common multiple of  $n_1, \dots, n_l$ .

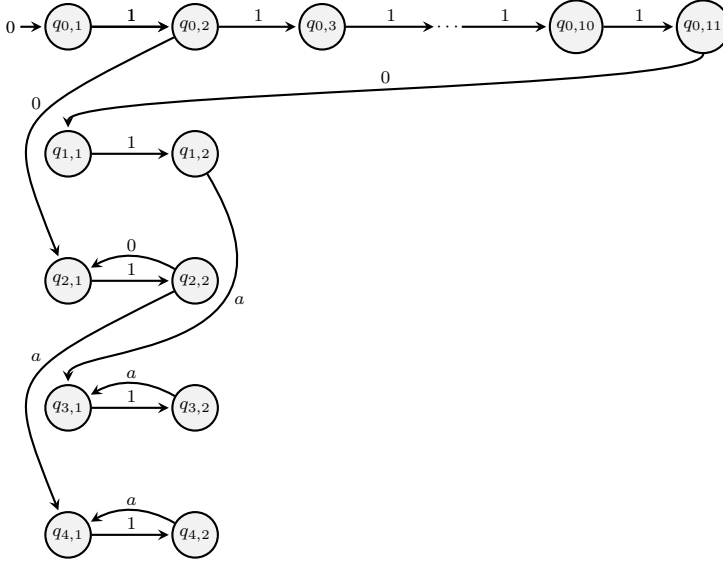

Fig. 21 The first step of computing the observer (defined in [25]) of automaton  $\mathcal{A}_0^{\mathbb{N}}$  in Fig. 3.

□

*Remark 8* We now compare the *current-state estimate* (15) with the *current-state estimate* used in [4, 13, 14, 16] and the *set of  $\gamma$ -consistent states* of labeled weighted automata over *semirings* used in [27, 50], where  $\gamma$  is a weighted label sequence.

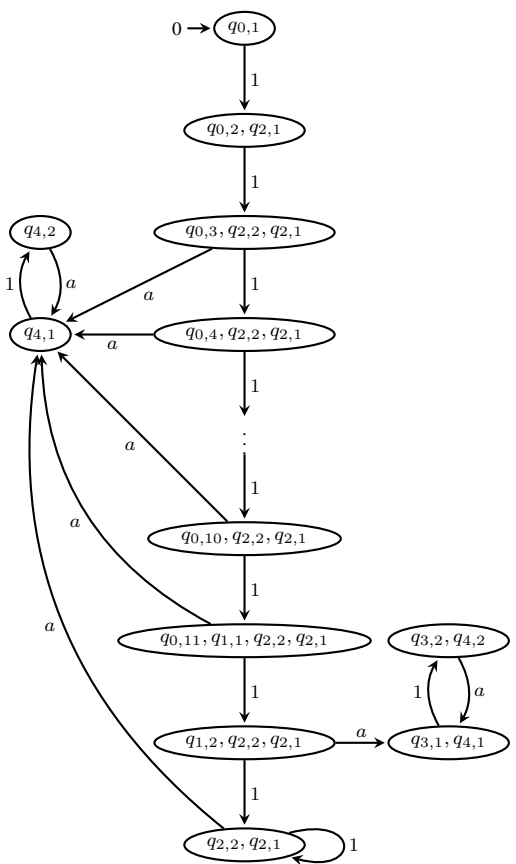

Fig. 22 The second step of computing the observer (defined in [25]) of automaton  $\mathcal{A}_0^N$  in Fig. 3.

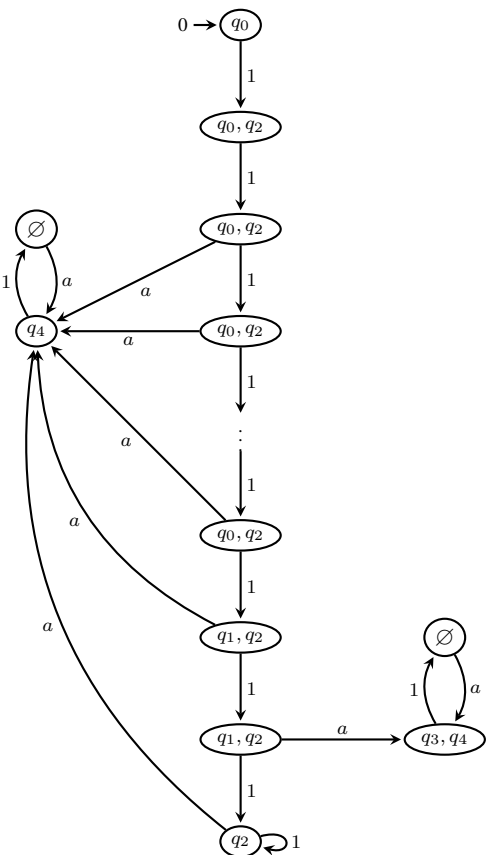
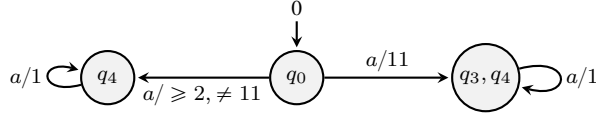

Fig. 23 The third step of computing the observer (defined in [25]) of automaton  $\mathcal{A}_0^N$  in Fig. 3. In this step, the observer was obtained.



**Fig. 24** The fourth step of computing the observer (defined in [25]) of automaton  $\mathcal{A}_0^{\mathbb{N}}$  in Fig. 3. In this step, the observer was simplified.

As mentioned before, a labeled finite-state automaton studied in [4, 13, 16, 14] can be regarded as an automaton  $\mathcal{A}^{\mathbb{N}}$  such that all unobservable transitions are instantaneous and every two observable transitions with the same label have the same weight in  $\mathbb{N}$ . In this regard, (15) reduces to the current-state estimate in [4, 13, 16, 14] in form. However, because labeled finite-state automata are untimed models, in [4, 13, 16, 14], it is not specified how much time is needed for the execution of an observable transition.

The set of  $\gamma$ -consistent states is the counterpart of the current-state estimate in labeled weighted automata over semirings. Consider a labeled weighted automaton  $\mathcal{A}^{\mathbb{Q}} = (\mathbb{Q}, Q, E, Q_0, \Delta, \alpha, \mu, \Sigma, \ell)$  over monoid  $(\mathbb{Q}, +, 0)$  (as in (3)) and a labeled weighted automaton  $\mathcal{A}^{\underline{\mathbb{Q}}}$  over semiring  $\underline{\mathbb{Q}} = (\mathbb{Q} \cup \{-\infty\}, \max, +, -\infty, 0)$  such that their only difference lies in that in  $\mathcal{A}^{\mathbb{Q}}$  the weights are chosen from monoid  $(\mathbb{Q}, +)$ , but the weights in  $\mathcal{A}^{\underline{\mathbb{Q}}}$  are chosen from semiring  $\underline{\mathbb{Q}}$ . Consider a path

$$\pi := q_0 \xrightarrow{e_1} q_1 \xrightarrow{e_2} \dots \xrightarrow{e_n} q_n$$

as in (4), its weighted word (as in (5)) is

$$\tau(\pi) := (e_1, t_1)(e_2, t_2) \dots (e_n, t_n),$$

where for every  $i \in \llbracket 1, n \rrbracket$ ,  $t_i = \sum_{j=1}^i \mu(e_j)_{q_{j-1}q_j}$ . Recall that the weight of  $\pi$  is defined by  $t_n$ .

In [27, 50], the weighted sequence of  $\pi$  is defined by

$$\sigma(\pi) = (e_1, t'_1)(e_2, t'_2) \dots (e_n, t'_n),$$

where for every  $i \in \llbracket 1, n \rrbracket$ ,  $t'_i$  is the maximum among the weights of all paths from  $Q_0$  to  $q_i$  under event sequence  $e_1 \dots e_i$ . The label sequence  $\ell(\sigma(\pi))$  of a weighted sequence  $\sigma(\pi)$  is defined in the same way as the label sequence of a weighted word, i.e.,  $\ell$  erases  $(e_i, t'_i)$  if  $e_i$  is unobservable, and maps  $(e_i, t'_i)$  to  $(\ell(e_i), t'_i)$  otherwise. Given  $\gamma \in (\Sigma \times \underline{\mathbb{Q}})^*$ , the set of  $\gamma$ -consistent states is defined by

$$C(\gamma) = \{q \in Q \mid (\exists \text{ a path } \pi = q_0 \xrightarrow{s} q) \quad (50) \\ [(q_0 \in Q_0) \wedge (s \in E^*) \wedge (\ell(\sigma(\pi)) = \gamma)]\}.$$

There are two differences between the set  $C(\gamma)$  of  $\gamma$ -consistent states and current-state estimate  $\mathcal{M}(\mathcal{A}^{\underline{\mathbb{Q}}}, \gamma)$ : (A) in the former two operations “max” and “+” are considered, in the latter only “+” is considered, (B) in the former after the last observable event in  $s$ , all unobservable paths are considered, in the latter after the last observable

event in  $s$ , only unobservable, instantaneous paths are considered. The first difference is major, but the second is minor and neglectable. The first difference shows that  $\mathcal{A}^{\mathbb{Q}_{\geq 0}}$  can represent a max-plus timed system, while  $\mathcal{A}^{\mathbb{Q}_{> 0}}$  can represent a real-time system. For unambiguous  $\mathcal{A}^{\mathbb{Q}}$  and  $\mathcal{A}^{\mathbb{Q}}$ , the difference (A) vanishes because in such automata, under every event sequence, there exists at most one path from  $Q_0$  to any state. Hence, the unique difference between the definitions of detectability of unambiguous  $\mathcal{A}^{\mathbb{Q}}$  in [27] and those of unambiguous  $\mathcal{A}^{\mathbb{Q}}$  in the current paper comes from the difference (B). If one method can be used to verify the detectability in [27], then it can be slightly modified to verify the detectability in the current paper, and vice versa. So (B) is minor and neglectable.

In a self-composition  $\text{CC}_A(\mathcal{A}^{unam, \mathbb{Q}})$  as in Definition 5, for each state  $(q_1, q_2)$  of  $\text{CC}_A(\mathcal{A}^{unam, \mathbb{Q}})$ , for all states  $q_3, q_4$  of  $\mathcal{A}^{unam, \mathbb{Q}}$  such that  $q_3$  (resp.,  $q_4$ ) is reachable from  $q_1$  (resp.,  $q_2$ ) through some unobservable (not necessarily instantaneous) path, add two unobservable transitions  $(q_1, q_2) \rightarrow (q_3, q_4)$  and  $(q_3, q_4) \rightarrow (q_1, q_2)$  into  $\text{CC}_A(\mathcal{A}^{unam, \mathbb{Q}})$ . Then after putting the updated self-composition into Theorem 1, we obtain an equivalent condition for the strong detectability of  $\mathcal{A}^{unam, \mathbb{Q}}$  studied in [27]. On the other hand, for an observer  $\mathcal{A}_{obs}^{unam, \mathbb{Q}}$  as in Definition 7, at each state  $x \in X$ , we add every state  $q$  that is reachable from some state in  $x$  through some (not necessarily instantaneous) unobservable path into  $x$ , then after putting the updated observer  $\tilde{\mathcal{A}}_{obs}^{unam, \mathbb{Q}}$  into Theorem 2, Theorem 4, and Theorem 5, we obtain equivalent conditions for the strong periodic detectability, weak detectability, and weak approximate detectability of  $\mathcal{A}^{unam, \mathbb{Q}}$  studied in [27]. Recall that the above verification does not depend on the divergence-freeness assumption, but the verification in [27] depends on the assumption.

On the other hand, the deterministic finite automaton  $G'_{obs}$  returned by [27, Algorithm 1] can be used to verify the detectability studied in the current paper for divergence-free  $\mathcal{A}^{unam, \mathbb{Q}}$  and  $\mathcal{A}^{unam, \mathbb{Q}}$ , while the observer  $G_{obs}$  returned by [27, Algorithm 1] can be used to verify the detectability defined in [27] for divergence-free  $\mathcal{A}^{unam, \mathbb{Q}}$ . Recall that  $G_{obs}$  was obtained from  $G'_{obs}$  in the same way as obtaining  $\tilde{\mathcal{A}}_{obs}^{unam, \mathbb{Q}}$  from  $\mathcal{A}_{obs}^{unam, \mathbb{Q}}$ .

Now we use automaton  $\mathcal{A}_1^{\mathbb{N}}$  (which can also be regarded as automaton  $\mathcal{A}_1^{\mathbb{N}}$  over semiring  $\mathbb{N}$ ) in Fig. 4 to show the essential differences between the two notions. Reconsider the paths  $\pi_1, \dots, \pi_5$  in (11). By definition, one has

$$\sigma(\pi_1) = (a, 1)(b, 3), \quad \ell(\sigma(\pi_1)) = (\rho, 1)(\rho, 3), \quad (51a)$$

$$\sigma(\pi_2) = (a, 1)(b, 3), \quad \ell(\sigma(\pi_2)) = (\rho, 1)(\rho, 3), \quad (51b)$$

$$\sigma(\pi_3) = (a, 1)(u, 2)(b, 4), \quad \ell(\sigma(\pi_3)) = (\rho, 1)(\rho, 4), \quad (51c)$$

$$\sigma(\pi_4) = (a, 1)(u, 2)(b, 4), \quad \ell(\sigma(\pi_4)) = (\rho, 1)(\rho, 4), \quad (51d)$$

$$\sigma(\pi_5) = (a, 1)(b, 3)(u, 4), \quad \ell(\sigma(\pi_5)) = (\rho, 1)(\rho, 3). \quad (51e)$$

Then

$$C((\rho, 1)(\rho, 2)) = \emptyset, \quad (52a)$$

$$C((\rho, 1)(\rho, 3)) = \{q_3, q_4\}. \quad (52b)$$

Compared with (17) (i.e.,  $\mathcal{M}(\mathcal{A}_1^{\mathbb{N}}, (\rho, 1)(\rho, 2)) = \mathcal{M}(\mathcal{A}_1^{\mathbb{N}}, (\rho, 1)(\rho, 3)) = \{q_3\}$ ), one can see the difference between  $\mathcal{M}(\mathcal{A}_1^{\mathbb{N}}, (\rho, 1)(\rho, 2))$  and  $C((\rho, 1)(\rho, 2))$  is caused by (A), but the difference between  $\mathcal{M}(\mathcal{A}_1^{\mathbb{N}}, (\rho, 1)(\rho, 3))$  and  $C((\rho, 1)(\rho, 3))$  is caused by (B). Although there is a transition sequence  $q_0 \xrightarrow{a/1} q_2 \xrightarrow{b/1} q_3$ , there exists no weighted sequence  $(a, 1)(b, 2)$ , so  $C((\rho, 1)(\rho, 2)) = \emptyset$ .

The above difference (A) also induces another remarkable difference between  $\mathcal{A}^{\mathbb{Q}}$  and  $\mathcal{A}^{\mathbb{Q}}$ . In Remark 4, we show that for any weighted label sequence  $\gamma(\sigma_2, t_2) \in (\Sigma \times \mathbb{Q})^+$ , one can compute  $\mathcal{M}(\mathcal{A}^{\mathbb{Q}}, \gamma(\sigma_2, t_2))$  from  $\mathcal{M}(\mathcal{A}^{\mathbb{Q}}, \gamma)$ . However, the results in [50, Example 7] show that generally  $C(\gamma(\sigma_2, t_2))$  cannot be computed from  $C(\gamma)$ , but must be computed from the initial time. This shows that a notion of observer for general  $\mathcal{A}^{\mathbb{Q}}$  might not be computable with complexity upper bounds.  $\square$

*Remark 9* The method of computing observer  $\mathcal{A}_{obs}^{unam, \mathbb{Q}}$  for divergence-free  $\mathcal{A}^{unam, \mathbb{Q}}$  in [27] is as follows. Due to the feature of unambiguity, a given  $\mathcal{A}^{unam, \mathbb{Q}}$  is firstly<sup>6</sup> transformed to a labeled finite-state automaton  $\mathcal{A}'$  in exponential time, the subsequent procedure of computing  $\mathcal{A}_{obs}^{unam, \mathbb{Q}}$  is almost the same as the procedure of computing the observer  $\mathcal{A}'_{obs}$  of  $\mathcal{A}'$  as in [4], hence the size of  $\mathcal{A}_{obs}^{unam, \mathbb{Q}}$  is exponential in the size of  $\mathcal{A}^{unam, \mathbb{Q}}$ , which is the same as the case that the size of the observer  $\mathcal{A}_{obs}$  is exponential in that of automaton  $\mathcal{A}$ . Note that for  $\mathcal{A}^{unam, \mathbb{Q}}$  that contains an unobservable cycle (that is,  $\mathcal{A}^{unam, \mathbb{Q}}$  is not divergence-free), generally the method in [27] cannot be used to verify detectability of such automata. For example, consider automaton  $\mathcal{A}_0^{\mathbb{N}}$  over semiring  $\mathbb{N}$  shown in Fig. 3, there is an unobservable self-loop on state  $q_2$ . Every number denotes the execution time of the corresponding transition, e.g., when  $\mathcal{A}_0^{\mathbb{N}}$  is in state  $q_0$  and event  $u$  occurs,  $\mathcal{A}_0^{\mathbb{N}}$  transitions to state  $q_1$ , the execution time of this transition is 10. Hence when we observe  $a$  at instant 11, we know that  $\mathcal{A}_0^{\mathbb{N}}$  can be in states  $q_3$  or  $q_4$ . However, by using the method in [27], after the first step as mentioned above, we obtain the finite-state automaton shown in Fig. 25, by which we know that when we observe  $a$  at instant 11,  $\mathcal{A}_0^{\mathbb{N}}$  can only be in state  $q_3$ . Hence, the detectability of automata like  $\mathcal{A}_0^{\mathbb{N}}$  cannot be verified by using the method in [27]. On the other hand, it is not pointed out in [27] that whether an observer  $\mathcal{A}_{obs}^{unam, \mathbb{Q}}$  is computable heavily depends on the weights. If the weights are real numbers, then generally the observer is uncomputable, because there exist only countably infinitely many computable real numbers [51].  $\square$

<sup>6</sup> Informally, this step is to aggregate every path  $q_0 \xrightarrow{s_1} q_1 \xrightarrow{e_2} q_2$ , where  $s_1$  is a sequence of unobservable events of length no greater than the number of states and  $e_2$  is an observable event, to a path  $q_0 \xrightarrow{e_2} q_2$  whose weight is equal to the weight of  $q_0 \xrightarrow{s_1} q_1 \xrightarrow{e_2} q_2$ . After this step, the obtained structure may not be a weighted automaton any more, because a path  $q_0 \xrightarrow{e_2} q_2$  may have two different weights; however, after regarding every pair of event  $e$  and the weight of a transition under  $e$  as a new event, then a labeled finite-state automaton is obtained.

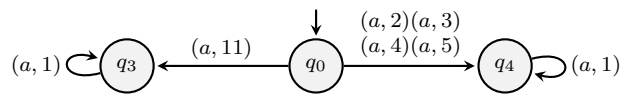

**Fig. 25** Finite-state automaton computed from  $\mathcal{A}_0^{\mathbb{N}}$  in Fig 3 by using the method in [27].