

The Fluted Fragment with Transitive Relations[☆]

Ian Pratt-Hartmann^a, Lidia Tendera^{b,*}

^aUniversity of Opole, Poland/University of Manchester, UK

^bUniversity of Opole, Institute of Computer Science, Oleska 48, 45-052 Opole, Poland

Abstract

We study the satisfiability problem for the fluted fragment extended with transitive relations. The logic enjoys the finite model property when only one transitive relation is available and the finite model property is lost when additionally either equality or a second transitive relation is allowed. We show that the satisfiability problem for the fluted fragment with one transitive relation and equality remains decidable. On the other hand we show that the satisfiability problem is undecidable already for the two-variable fragment of the logic in the presence of three transitive relations (or two transitive relations and equality).

Keywords: fluted logic, transitivity, satisfiability, decidability
2000 MSC: 03B25, 03B70

1. Introduction

The *fluted fragment*, here denoted \mathcal{FL} , is a fragment of first-order logic in which, roughly speaking, the order of quantification of variables coincides with the order in which those variables appear as arguments of predicates. The allusion is presumably architectural: we are invited to think of arguments of predicates as being ‘lined up’ in columns. The following formulas are sentences of \mathcal{FL}

$$\begin{aligned} &\text{No student admires every professor} \\ &\forall x_1(\text{student}(x_1) \rightarrow \neg \forall x_2(\text{prof}(x_2) \rightarrow \text{admires}(x_1, x_2))) \end{aligned} \quad (1)$$

$$\begin{aligned} &\text{No lecturer introduces any professor to every student} \\ &\forall x_1(\text{lecturer}(x_1) \rightarrow \\ &\quad \neg \exists x_2(\text{prof}(x_2) \wedge \forall x_3(\text{student}(x_3) \rightarrow \text{intro}(x_1, x_2, x_3))))), \end{aligned} \quad (2)$$

with the ‘lining up’ of variables illustrated in Fig. 1. By contrast, none of the formulas

$$\forall x_1.r(x_1, x_1)$$

[☆]This is a revised and substantially extended version of the MFCS 2019 paper [19].

*Corresponding author

Email addresses: `ipratt@cs.man.ac.uk` (Ian Pratt-Hartmann), `tendera@uni.opole.pl` (Lidia Tendera)

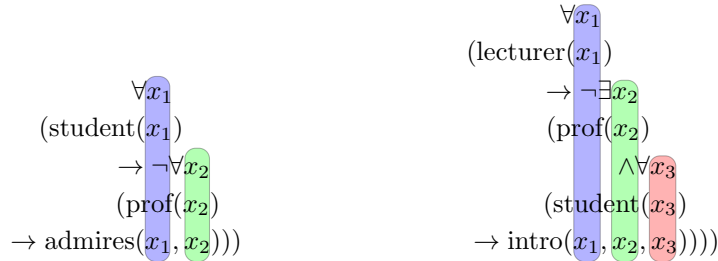

Figure 1: The ‘lining up’ of variables in the fluted formulas (1) and (2); all quantification is executed on the right-most available column.

$$\begin{aligned} & \forall x_1 \forall x_2 (r(x_1, x_2) \rightarrow r(x_2, x_1)) \\ & \forall x_1 \forall x_2 \forall x_3 (r(x_1, x_2) \wedge r(x_2, x_3) \rightarrow r(x_1, x_3)), \end{aligned}$$

expressing, respectively, the reflexivity, symmetry and transitivity of the relation r , is fluted, as the atoms involved cannot be arranged so that their argument sequences ‘line up’ in the fashion of Fig. 1.

The history of this fragment is somewhat tortuous. The basic idea of *fluted logic* can be traced to a paper given by W.V. Quine to the 1968 *International Congress of Philosophy* [22], in which the author defined the *homogeneous modal formulas*. Quine later relaxed this fragment, in the context of a discussion of predicate-functor logic, to what he called ‘fluted’ quantificational schemata [23], claiming that the satisfiability problem for the relaxed fragment is decidable. The viability of the proof strategy sketched by Quine was explicitly called into question by Noah [15], and the subject then taken up by W.C. Purdy [20], who gave his own definition of ‘fluted formulas’, proving decidability. It is questionable whether Purdy’s reconstruction is faithful to Quine’s intentions: the matter is clouded by differences between the definitions of predicate functors in Noah’s and Quine’s respective papers [15] and [23], both of which Purdy cites. In fact, Quine’s original definition of ‘fluted’ quantificational schemata appears to coincide with a logic introduced—apparently independently—by A. Herzig [4]. Rightly or wrongly, however, the name ‘fluted fragment’ has now attached itself to Purdy’s definition in [20]; and we shall continue to use it in that way in the present article. See Sec. 2 for a formal definition.

To complicate matters further, Purdy claimed in [21] that \mathcal{FL} (i.e. the fluted fragment, in our sense, and his) has the exponential-sized model property: if a fluted formula φ is satisfiable, then it is satisfiable over a domain of size bounded by an exponential function of the number of symbols in φ . Purdy concluded that the satisfiability problem for \mathcal{FL} is NEXPTIME-complete. These latter claims are false. It was shown in [17] that, although \mathcal{FL} has the finite model property, there is no elementary bound on the sizes of the models required, and the satisfiability problem for \mathcal{FL} is non-elementary. More precisely, define \mathcal{FL}^m to be the subfragment of \mathcal{FL} in which at most m variables (free or bound) appear.

Then the satisfiability problem for \mathcal{FL}^m is $\lfloor m/2 \rfloor$ -NEXPTIME-hard for all $m \geq 2$ and in $(m - 2)$ -NEXPTIME for all $m \geq 3$ [18]. It follows that the satisfiability problem for \mathcal{FL} is TOWER-complete, in the framework of [24]. These results fix the exact complexity of satisfiability of \mathcal{FL}^m for small values of m . Indeed, the satisfiability problem for FO^2 , the two-variable fragment of first-order logic, is known to be NEXPTIME-complete [3], whence the corresponding problem for \mathcal{FL}^2 is certainly in NEXPTIME. Moreover, for $0 \leq m \leq 1$, \mathcal{FL}^m coincides with the m -variable fragment of first-order logic, whence its satisfiability problem is NPTIME-complete. Thus, taking 0-NEXPTIME to mean NPTIME, we see that the satisfiability problem for \mathcal{FL}^m is $\lfloor m/2 \rfloor$ -NEXPTIME-complete, at least for $m \leq 4$.

The focus of the present paper is what happens when we add to the fluted fragment the ability to stipulate that certain designated binary relations are *transitive*, or are *equivalence relations*. The motivation comes from analogous results obtained for other decidable fragments of first-order logic. Consider basic propositional modal logic K. Under the standard translation into first-order logic (yielded by Kripke semantics), we can regard K as a fragment of first-order logic—indeed as a fragment of \mathcal{FL}^2 . From basic modal logic K, we obtain the logic K4 under the supposition that the accessibility relation on possible worlds is transitive, and the logic S5 under the supposition that it is an equivalence relation: it is well-known that the satisfiability problems for K and K4 are PSPACE-complete, whereas that for S5 is NPTIME-complete [13]. (For analogous results on *graded* modal logic, see [6].) Closely related are also description logics (cf. [1]) with *role hierarchies* and *transitive roles*. In particular, the description logic \mathcal{SH} , which has the finite model property, is an EXPTIME-complete fragment of \mathcal{FL} with transitivity. Similar investigations have been carried out in respect of FO^2 , which has the finite model property and whose satisfiability problem, as just mentioned, is NEXPTIME-complete. The finite model property is lost when one transitive relation or two equivalence relations are allowed. For equivalence, everything is known: the (finite) satisfiability problem for FO^2 in the presence of a single equivalence relation remains NEXPTIME-complete, but this increases to 2-NEXPTIME-complete in the presence of two equivalence relations [9, 10], and becomes undecidable with three. For transitivity, we have an incomplete picture: the *finite* satisfiability problem for FO^2 in the presence with a single transitive relation is decidable in 3-NEXPTIME [16], while the decidability of the satisfiability problem remains open (cf. [26]); the corresponding problems with two transitive relations are both undecidable [11].

Adding equivalence relations to the fluted fragment poses no new problems. Existing results on of FO^2 with two equivalence relations can be used to show that the satisfiability and finite satisfiability problems for \mathcal{FL} (not just \mathcal{FL}^2) with *two* equivalence relations are decidable. Furthermore, the proof that the corresponding problems for FO^2 in the presence of *three* equivalence relations are undecidable can easily be seen to apply also to \mathcal{FL}^2 . On the other hand, the situation with transitivity is less straightforward. We show in the sequel that the satisfiability and finite satisfiability problems for \mathcal{FL} remain decidable in the presence of a single transitive relation and equality. (This logic lacks the finite

model property.) On the other hand, the satisfiability and the finite satisfiability problems for \mathcal{FL} in the presence of two transitive relations and equality, or indeed, in the presence of three transitive relations (but without equality) are all undecidable. For the fluted fragment with two transitive relations but *without* equality, the situation is not fully resolved. We show in the sequel that this fragment lacks the finite model property; this contrasts with the situation in description logics, where not only \mathcal{SH} but also its extension \mathcal{SHI} retain the finite model property, independently of the number of transitive relations [14]. However, the decidability of both satisfiability and finite satisfiability for this fragment remain open. Table 1 gives an overview of these results in comparison with known results on FO^2 .

Some indication that flutedness interacts in interesting ways with transitivity is given by known complexity results on various extensions of guarded two-variable fragment with transitive relations. The *guarded fragment*, denoted GF, is that fragment of first-order logic in which all quantification is of either of the forms $\forall \bar{v}(\alpha \rightarrow \psi)$ or $\exists \bar{v}(\alpha \wedge \psi)$, where α is an atomic formula (a so-called *guard*) featuring all free variables of ψ . The *guarded two-variable fragment*, denoted GF^2 , is the intersection of GF and FO^2 . It is straightforward to show that the addition of two transitive relations to GF^2 yields a logic whose satisfiability problem is undecidable. However, as long as the distinguished transitive relations appear only in guards, we can extend the whole of GF with any number of transitive relations, yielding the so-called *guarded fragment with transitive guards*, whose satisfiability problem is in 2-EXP TIME [25]. Intriguingly, in the two-variable case, we obtain a reduction in complexity if we require transitive relations in guards to point *forward*—i.e. allowing only $\forall v(t(u, v) \rightarrow \psi)$ rather than $\forall v(t(v, u) \rightarrow \psi)$, and similarly for existential quantification. These restrictions resemble flutedness, of course, except that they prescribe the order of variables only in *guards*, rather than in the whole formula. Thus, the extension of GF^2 with (any number of) transitive guards has a 2-EXP TIME -complete satisfiability problem; however, the corresponding problem under the restriction to one-way transitive guards is EXPSpace -complete [8]. Since the above-mentioned extensions of GF^2 lack the finite model property, their satisfiability and the finite satisfiability problems do not coincide. Decidability and complexity bounds for the finite satisfiability problems are established in [11, 12].

2. Preliminaries

All signatures in this paper are purely relational, i.e., there are no individual constants or function symbols. We do, however, allow 0-ary relations (proposition letters). We use the notation $\varphi \dot{\vee} \psi$ to denote the exclusive disjunction of φ and ψ .

Let $\bar{x}_\omega = x_1, x_2, \dots$ be a fixed sequence of variables. We define the sets of formulas $\mathcal{FL}^{[m]}$ (for $m \geq 0$) by structural induction as follows: (i) any non-equality atom $\alpha(x_\ell, \dots, x_m)$, where x_ℓ, \dots, x_m is a contiguous (possibly empty) subsequence of \bar{x}_ω , is in $\mathcal{FL}^{[m]}$; (ii) $\mathcal{FL}^{[m]}$ is closed under boolean combinations;

Special symbols	Decidability and Complexity	
	\mathcal{FL}^m ($m \geq 2$)	FO^2
no transitive r.	$\lceil m/2 \rceil$ -NEXPTIME-hard in $(m-2)$ -NEXPTIME* [17, 18]	FMP NEXPTIME-compl. [3]
1 transitive r.	FMP [19]	<i>Sat</i> : ?
1 transitive r. with =	<i>Sat</i> : in m -NEXPTIME Theorem 20 <i>FinSat</i> : in $(m+1)$ -NEXPTIME Corollary 21	<i>Sat</i> : ? <i>FinSat</i> : in 3-NEXPTIME [16]
2 transitive r.	<i>Sat</i> : ? <i>FinSat</i> : ?	undecidable [7, 5]
2 transitive r. with =	undecidable Theorem 25	undecidable
1 trans. & 1 equiv. with =	undecidable Corollary 26	undecidable
3 transitive r.	undecidable <i>Sat</i> : Theorem 29 <i>FinSat</i> : Theorem 30	undecidable
3 equivalence r.	undecidable Corollary 31	undecidable

Table 1: Overview of \mathcal{FL}^m and FO^2 over restricted classes of structures. *) in case $m > 2$, and NEXPTIME-complete for \mathcal{FL}^2 . Undecidability of extensions of FO^2 shown in grey were known earlier, but now can be inherited from remaining results of the Table.

(iii) if φ is in $\mathcal{FL}^{[m+1]}$, then $\exists x_{m+1}\varphi$ and $\forall x_{m+1}\varphi$ are in $\mathcal{FL}^{[m]}$. The set of *fluted formulas* is defined as $\mathcal{FL} = \bigcup_{m \geq 0} \mathcal{FL}^{[m]}$. A *fluted sentence* is a fluted formula with no free variables. Thus, when forming Boolean combinations in the fluted fragment, all the combined formulas must have as their free variables some suffix of some prefix x_1, \dots, x_m of \bar{x}_ω ; and, when quantifying, only the last variable in this prefix may be bound. Note also that proposition letters (0-ary predicates) may, according to the above definitions, be combined freely with formulas: if φ is in $\mathcal{FL}^{[m]}$, then so, for example, is $\varphi \wedge P$, where P is a proposition letter. For $m \geq 0$, denote by \mathcal{FL}^m the m -variable sub-fragment of \mathcal{FL} , i.e. the set of formulas of \mathcal{FL} featuring at most m variables, free or bound. Do not confuse \mathcal{FL}^m with $\mathcal{FL}^{[m]}$. For example, (1) is in \mathcal{FL}^m just in case $m \geq 2$, and (2) is in \mathcal{FL}^m just in case $m \geq 3$; but they are both in $\mathcal{FL}^{[0]}$. Note that \mathcal{FL}^m -formulas cannot, by force of syntax, feature predicates of arity greater than m . The fragments $\mathcal{FL}^{[m]}_{=}$, $\mathcal{FL}_{=}$ and $\mathcal{FL}^m_{=}$ are defined analogously, except that equality atoms $x_{m-1} = x_m$ are allowed in $\mathcal{FL}^{[m]}_{=}$ for $m \geq 2$.

We denote by $\mathcal{FL}^k\text{T}$ the extension of \mathcal{FL} with k distinguished binary predicates assumed to be interpreted as transitive relations; and we denote by $\mathcal{FL}_{=}^k\text{T}$ the corresponding extension of $\mathcal{FL}_{=}$. We denote their m -variable sub-fragments ($m \geq 2$) by $\mathcal{FL}^m k\text{T}$, respectively $\mathcal{FL}_{=}^m k\text{T}$. A predicate is called *ordinary* if it

is neither the equality predicate nor one of the distinguished predicates. Finally, we denote by $\mathcal{FL}_{=}^2 1T^u$ the sub-fragment of $\mathcal{FL}_{=}^2 1T$ in which no binary predicates occur except equality and the distinguished predicate, i.e., where the non-logical signature consists purely of nullary and unary predicates, together with one distinguished binary predicate.

If \mathcal{L} is any logic, we denote its satisfiability problem by $Sat(\mathcal{L})$ and its finite satisfiability problem by $FinSat(\mathcal{L})$, understood in the usual way.

2.1. Variable-free syntax for fluted formulas

Assuming, as we shall, that the arity of every predicate is fixed in advance, variables in fluted formulas carry no information, and therefore can be omitted. Thus, for example, sentences (1) and (2) can be written as follows

$$\begin{aligned} \text{No student admires every professor} \\ \forall(\text{student} \rightarrow \neg\forall(\text{prof} \rightarrow \text{admires})) \end{aligned} \tag{3}$$

$$\begin{aligned} \text{No lecturer introduces any professor to every student} \\ \forall(\text{lecturer} \rightarrow \neg\exists(\text{prof} \wedge \forall(\text{student} \rightarrow \text{intro}))), \end{aligned} \tag{4}$$

As an exercise, try converting (4) back into (2). The only ambiguity here comes from the choice of the highest-indexed variable; for example, the notation $\forall(\text{prof} \rightarrow \text{admires})$ can mean $\forall x_{m+1}(\text{prof}(x_{m+1}) \rightarrow \text{admires}(x_m, x_{m+1}))$ for any $m \geq 1$. However, such ambiguity is perfectly harmless, and in fact—as the present authors have found—rather convenient. Variable-free syntax for fluted formulas takes a little getting used to, but makes for a compact presentation; we shall standardly employ it in the sequel. We write \forall^m to denote a block of m universal quantifiers; thus, if $\varphi \in \mathcal{FL}^{[m]}$, then $\forall^m \varphi \in \mathcal{FL}^{[0]}$. The elimination of variables seems to have been part of Quine’s original motivation for introducing the fluted fragment (or at least one of its close relatives).

2.2. Loss of the finite model property

The logic $\mathcal{FL} 1T$ possesses the finite model property (see Table 1). However, this is no longer true if we add either equality or a second transitive relation, as shown by the examples below.

Example 1. Consider the $\mathcal{FL}_{=}^2 1T$ -sentence $\varphi_1 = \forall\exists.T_1 \wedge \forall\forall(T_1 \rightarrow \neg =)$, where T_1 is a distinguished binary predicate denoting a transitive relation. This sentence is satisfiable, but not finitely satisfiable.

Proof. In standard first-order syntax, φ_1 reads as follows:

$$\varphi_1 = \forall x\exists y.T_1(x, y) \wedge \forall x\forall y(T_1(x, y) \rightarrow x \neq y).$$

It is obvious that φ_1 is satisfiable (for example by the structure \mathbb{N} with T_1 interpreted as $<$), but not finitely satisfiable. \square

Example 2. Consider the $\mathcal{FL}^2\text{T}$ -sentence

$$\varphi_2 = \exists p_0 \wedge \forall (p_0 \dot{\vee} p_1 \dot{\vee} p_2) \wedge \forall \forall \neg(T_1 \wedge T_2) \wedge \bigwedge_{i=0,1,2} \forall (p_i \rightarrow (\exists (p_{i+1} \wedge \neg(T_1 \vee T_2)) \wedge \forall (p_{i+2} \rightarrow T_1 \vee T_2))),$$

where the p_i ($0 \leq i \leq 2$) are unary predicates (addition in subscripts interpreted modulo 3), and T_1, T_2 are distinguished binary predicates denoting transitive relations. This sentence is satisfiable, but not finitely satisfiable.

Proof. For readers still getting used to variable-free notation, we again restore the variables in φ_2 :

$$\begin{aligned} \exists x_1. p_0(x_1) \wedge \forall x_1 (p_0(x_1) \dot{\vee} p_1(x_1) \dot{\vee} p_2(x_1)) \wedge \forall x_1 \forall x_2 \neg(T_1(x_1, x_2) \wedge T_2(x_1, x_2)) \wedge \\ \bigwedge_{i=0,1,2} \forall x_1 (p_i(x_1) \rightarrow (\exists x_2 (p_{i+1}(x_2) \wedge \neg(T_1(x_1, x_2) \vee T_2(x_1, x_2))) \wedge \\ \forall x_1 (p_{i+2}(x_1) \rightarrow T_1(x_1, x_2) \vee T_2(x_1, x_2))))). \end{aligned}$$

One can easily check that the structure \mathbb{N} with the following interpretation of the predicate letters

$$\begin{aligned} p_i(n) & \text{ iff } n \bmod 3 = i \\ T_1(n, m) & \text{ iff } n + 1 < m \\ T_2(n, m) & \text{ iff } n > m \end{aligned}$$

is a model of φ_2 .

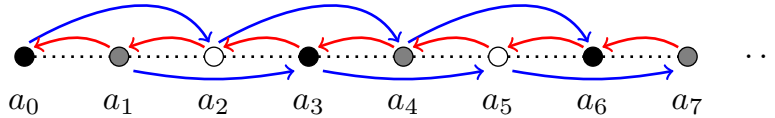

Figure 2: Infinite chain in models of φ_2 from Example 2. Pairs (a_i, a_{i+1}) are neither in T_1 nor in T_2 ; depicted by dotted lines. Blue and red arrows depict pairs belonging to the transitive relations T_1 and T_2 .

To see that φ_2 is not finitely satisfiable, suppose $\mathfrak{A} \models \Psi$. By the existential conjuncts of φ_2 , there exist distinct elements $a_0, a_1, a_2 \in A$ such that $a_i \in p_i$ and $(a_0, a_1), (a_1, a_2) \notin T_1 \cup T_2$ (cf. Figure 2). The universal conjuncts of φ_2 imply that $(a_0, a_2), (a_1, a_0)$ and (a_2, a_1) belong to $T_1 \cup T_2$ but not to $T_1 \cap T_2$. One can check that with transitive T_1 and T_2 this allows for only two options: (i) $(a_1, a_0), (a_2, a_1) \in T_1$ and $(a_0, a_2) \in T_2$, or (ii) $(a_1, a_0), (a_2, a_1) \in T_2$ and $(a_0, a_2) \in T_1$. In both cases applying transitivity of T_1 or of T_2 we have $(a_2, a_0) \in$

$T_1 \cup T_2$. But then the existential conjuncts require a new witness, say a_3 , for a_2 such that $(a_2, a_3) \notin T_1 \cup T_2$. Again, taking the universal conjuncts into considerations, we get $(a_3, a_1) \in T_1 \cup T_2$. So, the situation repeats, and indeed \mathfrak{A} embeds an infinite chain of elements such that, for each consecutive pair, $(a_i, a_{i+1}) \notin T_1 \cup T_2$. \square

2.3. Fluted types and cliques

Suppose \mathfrak{A} is a structure interpreting the distinguished binary predicate T as a transitive relation. A *clique* of \mathfrak{A} is a maximal subset $B \subseteq A$ with the property that, for all distinct $a, b \in B$, $\mathfrak{A} \models T[a, b]$. Every element $a \in A$ is a member of exactly one clique, and if that clique has size greater than 1, then, necessarily $\mathfrak{A} \models T[a, a]$. Furthermore, if B_1 and B_2 are cliques, then either every element of B_1 is related to every element of B_2 by T , or no element of B_1 is related to any element of B_2 by T . In this way, $T^{\mathfrak{A}}$ induces a strict partial order on the set of cliques. If a singleton $\{a\}$ is a clique, then it may or may not be the case that $\mathfrak{A} \models T[a, a]$. If $\mathfrak{A} \models \neg T[a, a]$, then we call a (or sometimes $\{a\}$) a *soliton*.

In this paper, we adapt the familiar notions of atom, literal, m -type and clause to the fluted environment. A *fluted m -atom* is an atomic formula of $\mathcal{FL}_{\equiv}^{[m]}$. Remembering that we are using variable-free syntax, we see that a fluted m -atom is simply a predicate p having arity at most m . A *fluted m -literal* is a fluted m -atom or its negation; a *fluted m -type* is a maximal consistent conjunction of fluted m -literals. If $\bar{a} = a_1, \dots, a_m$ is a tuple of elements in some structure \mathfrak{A} , then \bar{a} satisfies a unique fluted m -type over Σ , denoted $\text{ftp}^{\mathfrak{A}}[\bar{a}]$. We silently identify fluted m -types with their conjunctions where appropriate; thus, any fluted m -type may be regarded as a (quantifier-free) $\mathcal{FL}^{[m]}$ -formula. Finally, a *fluted m -clause* is a disjunction of fluted m -literals. We allow the empty clause \perp . We silently identify a finite set of clauses Γ with its conjunction where convenient, thus writing Γ in formulas instead of the (technically more correct) $\bigwedge \Gamma$. A fluted m -atom/literal/clause is automatically a fluted m' -atom/literal/clause for all $m' > m$; the same is not true of fluted m -types for signatures containing predicates of arity greater than m . In any case, reference to m is suppressed if inessential or clear from context.

At various points in Sec. 3, it will be convenient to appeal to the technique of resolution theorem-proving in order to simplify formulas. If $\gamma = \gamma' \vee A$ and $\delta = \delta' \vee \neg A$ are both fluted m -clauses, where A is a fluted atom, then so is the clause $\gamma' \vee \delta'$, called a *fluted resolvent* of γ and δ . If the predicate in A is ordinary and has maximum arity both among the predicates of γ and among those of δ , then we say that $\gamma' \vee \delta'$ is the *maximal ordinary resolvent* (or *mo-resolvent*) of γ and δ . (Recall that a predicate is called *ordinary* if it is neither the equality predicate nor one of the distinguished predicates.) Thus mo-resolution is simply a restricted version of resolution. By regarding fluted m -clauses as shorthand for their universal closures, resolution—and in particular mo-resolution—can be seen as a valid inference rule: from $\forall^m(\gamma' \vee A)$ and $\forall^m(\delta' \vee \neg A)$, infer $\forall^m(\gamma' \vee \delta')$. We remark that, if A is the only literal of γ involving an m -ary predicate, and similarly for $\neg A$ in δ , then the mo-resolvent $\gamma' \vee \delta'$ will be a fluted $(m - 1)$ -

clause (and therefore also a fluted m -clause). This is will prove important when dealing with the fragments $\mathcal{FL}_{=}^m kT$ for $m > 2$.

If Γ is a set of fluted clauses, denote by Γ^* the smallest set of fluted clauses including Γ and closed under mo-resolution, in the sense that if $\gamma, \delta \in \Gamma^*$ mo-resolve to form ϵ , then $\epsilon \in \Gamma^*$. Clearly, Γ^* is finite if Γ is. Further, if Γ is a set of m -clauses, for $m \geq 2$, and taking m to be clear from context, we denote by Γ° the result of removing from Γ^* any clauses involving any ordinary predicates of arity m . If $m > 2$, then Γ° is necessarily a set of fluted $(m - 1)$ -clauses; and if $m = 2$, then Γ° is a set of fluted 2-clauses involving no binary predicates other than (possibly) $=$ or the distinguished predicates T_k .

The following lemma is, in effect, nothing more than the familiar completeness theorem for (ordered) propositional resolution.

Lemma 3. *Let Γ be a set of fluted m -clauses, and τ a fluted m -type over the signature of Γ° . If $\Gamma^\circ \cup \{\tau\}$ is consistent, then there exists a fluted type τ^+ over the signature of Γ such that $\tau^+ \supseteq \tau$ and $\Gamma \cup \{\tau^+\}$ is consistent.*

Proof. Enumerate the ordinary m -ary predicates occurring in Γ as p_1, \dots, p_n . Note that none of these predicates occurs in τ . Define a *level- i extension* of τ inductively as follows: (i) τ is an level-0 extension of τ ; (ii) if τ' is a level- i extension of τ ($0 \leq i < n$), then $\tau' \cup \{p_{i+1}\}$ and $\tau' \cup \{\neg p_{i+1}\}$ are level- $(i + 1)$ extensions of τ . Thus, the level- n extensions of τ are exactly the fluted m -types over the signature of Γ extending τ . If τ' is a level- i extension of τ ($0 \leq i < n$), we say that τ' *violates* a clause δ if, for every literal in γ , the opposite literal is in τ' ; we say that τ' *violates* a set of clauses Δ if τ' violates some $\delta \in \Delta$. Suppose now that τ' is a level- i extension of τ ($0 \leq i < n$). We claim that, if both $\tau' \cup \{p_{i+1}\}$ and $\tau' \cup \{\neg p_{i+1}\}$ violate Γ^* , then so does τ' . For suppose otherwise. In that case, there must be a clause $\neg p_{i+1} \vee \gamma' \in \Gamma^*$ violated by $\tau' \cup \{p_{i+1}\}$ and a clause $p_{i+1} \vee \gamma' \in \Gamma^*$ violated by $\tau' \cup \{\neg p_{i+1}\}$. But then τ' violates the mo-resolvent $\gamma' \vee \delta'$, contradicting the supposition that τ' does not violate Γ^* . This proves the claim. Now, since τ is by hypothesis consistent with Γ° , it certainly does not violate Γ° . Moreover, since it involves no ordinary predicates of arity m , τ does not violate Γ^* either. By the above claim, then, there must be at least one level- n extension of τ which does not violate $\Gamma^* \supseteq \Gamma$. Since τ^+ is a fluted m -type, this proves the lemma. \square

3. The decidability of fluted logic with one transitive relation and equality

In this section, we study the logic $\mathcal{FL}_{=}1T$, the fluted fragment with equality and a single distinguished transitive relation; we also consider its m -variable sub-fragment, $\mathcal{FL}_{=}^m 1T = \mathcal{FL}_{=}1T \cap \text{FO}^m$, for all $m \geq 2$. As already mentioned, even the smallest of these fragments lacks the finite model property. Nevertheless, we show that the satisfiability problem for $\mathcal{FL}_{=}1T$ is decidable; indeed, $\text{Sat}(\mathcal{FL}_{=}^m 1T)$ is in $(m + 1)\text{-NEXPTIME}$ for $m \geq 2$. Given known results on the fluted fragment, it follows that $\text{Sat}(\mathcal{FL}_{=}1T)$ is TOWER-complete,

according to the framework of super-elementary complexity classes developed in Schmitz [24]. The structure of the proof is as follows. Recall that $\mathcal{FL}_{=}^2 1T^u$ is the sub-fragment of $\mathcal{FL}_{=}^2 1T$ in which no binary predicates appear other than T and $=$. In Sec. 3.1, we prove an upper complexity bound of 2-NEXPTIME for $Sat(\mathcal{FL}_{=}^2 1T^u)$; in Sec. 3.2, we show that $Sat(\mathcal{FL}_{=}^2 1T)$ is also in 2-NEXPTIME, via a reduction to $Sat(\mathcal{FL}_{=}^2 1T^u)$; and in Sec. 3.3, we show that $Sat(\mathcal{FL}_{=}^m 1T)$ is in m -NEXPTIME, via a series of exponential-sized reductions to $Sat(\mathcal{FL}_{=}^2 1T)$. In all these reductions, we take particular care of the sizes both of the formulas produced, and of their signatures.

We will be dealing here with logics featuring a single distinguished transitive relation, and we use the letter T for the corresponding binary predicate. Thus, if \mathfrak{A} is a structure, we always assume that $T^{\mathfrak{A}}$ is a transitive relation on A . A formula of $\mathcal{FL}_{=}^m 1T$ is said to be in *normal form* if it has the shape

$$\bigwedge_{i \in S} \forall^{m-1} (\mu_i \rightarrow \exists (\kappa_i \wedge \Gamma_i)) \wedge \bigwedge_{j \in T} \forall^{m-1} (\nu_j \rightarrow \forall \Delta_j) \wedge \forall^m \Omega, \quad (5)$$

where S and T are finite sets of indices, such that, for $i \in S$ and $j \in T$, μ_i and ν_j are quantifier-free fluted formulas of arity at most $(m-1)$, κ_i is a formula of any of the four forms $(T \wedge =)$, $(T \wedge \neq)$, $(\neg T \wedge =)$, $(\neg T \wedge \neq)$, and Γ_i , Δ_j and Ω are sets of fluted clauses in $\mathcal{FL}_{=}^m 1T$. (Here, of course, we are making use of our convention that finite sets of clauses are identified with their conjunctions.) We refer to the formulas κ_i as *control formulas*; observe in this regard that the binary predicates T and $=$ count as atomic formulas of $\mathcal{FL}^{[m]}$ for all $m \geq 2$. The following lemma is slightly modified from [18, Lemma 4.1], where it was proved for the sub-fragment without equality. The proof, however, is virtually identical, and we may simply state:

Lemma 4. *Let φ be an $\mathcal{FL}_{=}^2 1T$ -sentence. We can compute, in time bounded by a polynomial function of $\|\varphi\|$, a normal-form $\mathcal{FL}_{=}^2 1T$ -formula ψ such that: (i) $\models \psi \rightarrow \varphi$; and (ii) any model of φ can be expanded to a model of ψ .*

We show in Lemmas 16 and 17 how, in the two-variable case, normal form formulas can be further massaged into a collection of extremely simple formulas for which the satisfiability problem is easy to analyse. Since that analysis forms the core of the whole proof, that is where we shall begin.

3.1. Basic formulas in $\mathcal{FL}_{=}^2 1T^u$

In the logic $\mathcal{FL}_{=}^2 1T^u$, the only binary predicates available are equality and the distinguished predicate, T . These suffice, however, to state that an element is related by T to itself, for example, using the unary formula $\exists (= \wedge T)$. We may therefore suppose that we have available a distinguished *unary* predicate \hat{T} , which we take to be satisfied, in any structure, by precisely those elements related to themselves by T : i.e. $\mathfrak{A} \models \hat{T}[a] \Leftrightarrow \mathfrak{A} \models T[a, a]$; this constitutes no essential increase in the expressive power of $\mathcal{FL}_{=}^2 1T^u$. In this section (3.1), then, all signatures are implicitly assumed to contain both T and \hat{T} , interpreted

as described. Under this assumption, a soliton is a clique consisting of a single element a such that $\mathfrak{A} \models \hat{T}[a]$.

Our goal is to establish that the satisfiability problem for this fragment is in 2-NEXPTIME. In fact, it suffices to confine our attention to conjunctions of so-called *basic* formulas of this fragment (defined below). Our strategy is to show that any satisfiable, finite set Ψ of basic formulas has a *certificate*, of size bounded by a doubly exponential function of $\|\Psi\|$, which guarantees the existence of a (possibly infinite) model.

Let Σ be a signature for $\mathcal{FL}^2_1T^u$. Call an $\mathcal{FL}^2_1T^u$ -formula over Σ *basic* if it is of one of the following forms, where π and π' are fluted 1-types over Σ and μ a quantifier-free formula over Σ of arity 1:

$$\begin{array}{ll}
\text{(B1)} \quad \forall(\pi \rightarrow \exists(\mu \wedge T \wedge \neq)) & \text{(B5)} \quad \forall(\pi \rightarrow \forall(\pi \rightarrow (= \vee T))) \\
\text{(B2)} \quad \forall(\pi \rightarrow \exists(\mu \wedge \neg T \wedge \neq)) & \text{(B6)} \quad \forall(\pi \rightarrow \forall(\pi \rightarrow (= \vee \neg T))) \\
\text{(B3)} \quad \forall(\pi \rightarrow \forall(\pi' \rightarrow T)) \quad (\pi \neq \pi') & \text{(B7)} \quad \forall\mu \\
\text{(B4)} \quad \forall(\pi \rightarrow \forall(\pi' \rightarrow \neg T)) \quad (\pi \neq \pi') & \text{(B8)} \quad \exists\mu.
\end{array}$$

Suppose \mathfrak{A} is a structure, B a clique of \mathfrak{A} , and π, π' fluted 1-types. Say that B is *determined* by the pair $\{\pi, \pi'\}$ if it is the unique clique of \mathfrak{A} in which π and π' are both realized. We call \mathfrak{A} *quadratic* if, for any clique B determined by some pair of fluted 1-types $\{\pi, \pi'\}$, there exists a fluted 1-type π^* such that B is the unique clique of \mathfrak{A} in which π^* is realized. That is, in a quadratic structure, any clique which can be uniquely identified as the only clique containing a given pair of fluted 1-types, π and π' , can be uniquely identified as the only clique containing some (possibly different) fluted 1-type π^* .

Let Φ be a set of basic formulas over some signature Σ , and write $\ell = |\Sigma|$. Now let Σ^* be Σ together with the fresh unary predicates $p_0, \dots, p_{2\ell-1}$, let \bar{p}_0 be the formula $\neg p_0 \wedge \dots \wedge \neg p_{2\ell-1}$, and let $\Phi^* = \{\varphi^* \mid \varphi \in \Phi \cup \{\exists T\}\}$, where

$$\varphi^* := \begin{cases} \forall(\pi \wedge \bar{p}_0 \rightarrow \exists(\mu \wedge \bar{p}_0 \wedge \chi)) & \text{if } \varphi = \forall(\pi \rightarrow \exists(\mu \wedge \chi)) \\ \forall(\pi \wedge \bar{p}_0 \rightarrow \forall(\pi' \wedge \bar{p}_0 \rightarrow \chi)) & \text{if } \varphi = \forall(\pi \rightarrow \forall(\pi' \rightarrow \chi)) \\ \forall(\bar{p}_0 \rightarrow \mu) & \text{if } \psi = \forall\mu \\ \exists(\mu \wedge \bar{p}_0) & \text{if } \psi = \exists\mu. \end{cases}$$

Modulo trivial logical manipulation, Φ^* is a set of basic formulas over Σ^* . Call any fluted 1-type π over Σ^* such that $\models \pi \rightarrow \bar{p}_0$ *proper*. Clearly, the proper fluted 1-types over Σ^* are in natural 1–1 correspondence with the fluted 1-types over Σ .

Lemma 5. *Suppose Φ is a set of basic formulas. The following are equivalent: (i) Φ is satisfiable; (ii) $\Phi^* \cup \{\forall \bar{p}_0\}$ is satisfiable; (iii) Φ^* is satisfied in a quadratic structure; (iv) Φ^* is satisfiable.*

Proof. (i) \Rightarrow (ii): If $\mathfrak{A} \models \Phi$, let \mathfrak{B} be the expansion of \mathfrak{A} obtained by taking every element of A to satisfy \bar{p}_0 . It is obvious that $\mathfrak{B} \models \Phi^* \cup \{\forall \bar{p}_0\}$. (ii) \Rightarrow (iii):

Suppose $\mathfrak{A} \models \Phi^* \cup \{\forall \bar{p}_0\}$. For each (unordered) pair, π, π' of distinct, proper fluted 1-types (over Σ^*) such that there is exactly one clique, u of \mathfrak{A} in which both are realized, choose a fresh, *improper* fluted 1-type over Σ^* , and simply add a new element with that fluted 1-type to u . Because there are certainly $2^{2^{|\sigma|}} - 1$ improper fluted 1-types, we never run out of fresh, improper fluted 1-types, so let \mathfrak{B} be the resulting structure. Since the new elements do not satisfy \bar{p}_0 , we have $\mathfrak{B} \models \Phi^*$. And since all the newly realized fluted 1-types occur only in single cliques, \mathfrak{B} is quadratic. (iii) \Rightarrow (iv) is trivial. (iv) \Rightarrow (i): Suppose $\mathfrak{A} \models \Phi^*$, and let \mathfrak{B} be restriction of \mathfrak{A} to the (necessarily non-empty) set of elements satisfying \bar{p}_0 . It is obvious that $\mathfrak{B} \models \Phi$. \square

Lemma 5 tells us that any set Φ of basic formulas over Σ can be transformed, in polynomial time, to a set Φ^* of basic formulas over a larger signature Σ^* such that Φ has a model if and only if Φ^* has a quadratic model. In the following lemmas, therefore, we may assume this conversion has been carried out, and concern ourselves with establishing conditions for a set of basic formulas Φ to have a *quadratic* model.

For the remainder of Sec. 3.1, we fix a signature Σ of unary predicates. All fluted 1-types are assumed to be over the signature Σ , and are, as usual, identified with their conjunctions where convenient. We denote by Π_Σ the set of these fluted 1-types. We always use the (possibly decorated) letters π to range over fluted 1-types, and μ to range over quantifier-free formulas of arity 1 in the signature Σ . Thus, all such π and μ are $\mathcal{FL}_{=}^2 1T^u$ -formulas. We use Π to range over sets of fluted 1-types.

A *clique-type* is a function $\xi : \Pi_\Sigma \rightarrow \{0, 1, 2\}$. If \mathfrak{A} is a structure interpreting Σ , B is a clique of \mathfrak{A} , and $a \in B$, then the *clique-type of B* is the function $\text{ctp}^\mathfrak{A}[a] : \Pi_\Sigma \rightarrow \{0, 1, 2\}$ given by

$$\text{ctp}^\mathfrak{A}[a](\pi) = \begin{cases} 2 & \text{if } \pi \text{ is realized in } \mathfrak{A} \text{ by at least two elements of } B \\ 1 & \text{if } \pi \text{ is realized in } \mathfrak{A} \text{ by exactly one element of } B \\ 0 & \text{otherwise.} \end{cases}$$

Intuitively, we should think of a clique type as a multi-set of fluted 1-types, with counting truncated at 2. We write $\pi \in \xi$ to mean that $\xi(\pi) \geq 1$, and treat ξ as the set of fluted 1-types $\{\pi \mid \pi \in \xi\}$ where convenient, thus writing, for example $\xi \cup \Pi$ for $\{\pi \mid \pi \in \xi \text{ or } \pi \in \Pi\}$, and so on. A *soliton clique-type* ξ is one such that $-\hat{T} \in \bigcup \xi$. A *clique-super-type* is a pair (ξ, Π) , where ξ is a clique-type and Π a set of fluted 1-types. The *clique-super-type of a* is the pair $\text{cstp}^\mathfrak{A}[a] = (\text{ctp}^\mathfrak{A}[a], \Pi)$, where

$$\Pi = \{\text{ftp}^\mathfrak{A}[b] \mid \mathfrak{A} \models T[a, b] \text{ and } \mathfrak{A} \not\models T[b, a] \text{ for some } b \in A\}.$$

Intuitively, a clique-super-type is the type of some clique together with a specification of which fluted 1-types outside that clique can be reached via the predicate T . If B is a clique, then all elements of B obviously have the same clique-type and the same clique-super-type, denoted by $\text{ctp}^\mathfrak{A}[B]$ and $\text{cstp}^\mathfrak{A}[B]$, respectively.

We now describe the principal data-structure used to test satisfiability of sets of basic $\mathcal{FL}_{=}^2 1T^u$ -formulas. A *certificate* is a triple $\mathcal{C} = \langle \Omega, \ll, V \rangle$, where Ω is a set of clique super-types, \ll a strict partial order on Π_Σ , and $V \subseteq \Pi_\Sigma$, subject to the following conditions:

- (C1) if $\langle \xi, \Pi \rangle \in \Omega$ and $\pi' \in \Pi$, then there exists $\langle \xi', \Pi' \rangle \in \Omega$ such that
 - (i) $\pi' \in \xi'$, (ii) $\Pi' \cup \xi' \subseteq \Pi$, and (iii) $\xi \cap V \cap \Pi' = \emptyset$;
- (C2) if $\langle \xi, \Pi \rangle, \langle \xi', \Pi' \rangle \in \Omega$ are distinct, $\pi \in \xi$, $\pi' \in \xi'$ and $\pi \ll \pi'$, then $\xi' \cup \Pi' \subseteq \Pi$;
- (C3) if $\langle \xi, \Pi \rangle, \langle \xi', \Pi' \rangle \in \Omega$ and $\xi \cap \xi' \cap V \neq \emptyset$, then $\xi = \xi'$ and $\Pi = \Pi'$;
- (C4) if $\langle \xi, \Pi \rangle \in \Omega$ and ξ is a soliton clique-type, then there exists $\pi \in \Pi_\Sigma$ such that $\xi(\pi) = 1$ and $\xi(\pi') = 0$ for all $\pi' \in \Pi_\Sigma \setminus \{\pi\}$;
- (C5) if $\langle \xi, \Pi \rangle \in \Omega$, $\pi' \in \xi$ and $\pi \ll \pi'$, then $\pi \notin \Pi$;
- (C6) if $\langle \xi, \Pi \rangle \in \Omega$, $\pi, \pi' \in \xi$ and $\pi \ll \pi'$ then $\xi \cap V \neq \emptyset$.

If \mathfrak{A} is a structure, then the *certificate of \mathfrak{A}* is the tuple $\mathcal{C}(\mathfrak{A}) = \langle \Omega, \ll, V \rangle$, where: $\Omega = \{\text{cstp}^{\mathfrak{A}}[a] \mid a \in A\}$ is the set of clique-super-types realized in \mathfrak{A} ; $\pi \ll \pi'$ if and only if π and π' are realized in \mathfrak{A} , $\mathfrak{A} \models \forall(\pi \rightarrow \forall(\pi' \rightarrow T))$ and $\mathfrak{A} \not\models \forall(\pi' \rightarrow \forall(\pi \rightarrow T))$; and V is the set of fluted 1-types realized in exactly one clique of \mathfrak{A} .

Lemma 6. *The relation \ll in the construction of $\mathcal{C}(\mathfrak{A})$ is a strict partial order on Π_Σ .*

Proof. We need only check transitivity. Suppose, $\pi \ll \pi'$ and $\pi' \ll \pi''$. Trivially, $\mathfrak{A} \models \forall(\pi \rightarrow \forall(\pi'' \rightarrow T))$. On the other hand, if we also have $\mathfrak{A} \models \forall(\pi'' \rightarrow \forall(\pi \rightarrow T))$, then $\mathfrak{A} \models \forall(\pi'' \rightarrow \forall(\pi' \rightarrow T))$, contradicting $\pi' \ll \pi''$. Hence $\pi \ll \pi''$. \square

Lemma 7. *If \mathfrak{A} is any quadratic structure interpreting Σ , then $\mathcal{C}(\mathfrak{A})$ is a certificate.*

Proof. Write $\mathcal{C}(\mathfrak{A}) = \langle \Omega, \ll, V \rangle$. By Lemma 6, \ll is a strict partial order on Π_Σ . We must check conditions (C1)–(C6).

(C1): Suppose $\langle \xi, \Pi \rangle \in \Omega$ and $\pi' \in \Pi$. Let a be such that $\text{cstp}^{\mathfrak{A}}[a] = \langle \xi, \Pi \rangle$. Then there exists $b \in A$ such that $\text{ftp}^{\mathfrak{A}}[b] = \pi'$ and $\mathfrak{A} \models T[a, b]$, but with a and b lying in different cliques. Let $\text{cstp}^{\mathfrak{A}}[b] = \langle \xi', \Pi' \rangle$. Then: (i) $\langle \xi', \Pi' \rangle \in \Omega$ by construction of Ω ; (ii) $\xi' \cup \Pi' \subseteq \Pi$ by transitivity of $T^{\mathfrak{A}}$; and (iii) if $\pi'' \in \xi \cap V$, then all elements with fluted 1-type π'' lie in the same clique as a . Since a and b are not in the same clique, b cannot be related by T to any of these elements, which is to say $\pi'' \notin \Pi'$.

(C2): Suppose $\langle \pi, \Pi \rangle, \langle \pi', \Pi' \rangle \in \Omega$ are distinct, $\pi \in \xi$, $\pi' \in \xi'$ and $\pi \ll \pi'$. Let $a, b \in A$ be such that $\text{cstp}^{\mathfrak{A}}[a] = \langle \xi, \Pi \rangle$ and $\text{cstp}^{\mathfrak{A}}[b] = \langle \xi', \Pi' \rangle$. If $\pi \ll \pi'$, then $\mathfrak{A} \models T[a, b]$. Moreover, if a and b belong to different cliques, then $\xi' \cup \Pi' \subseteq \Pi$, by the transitivity of T .

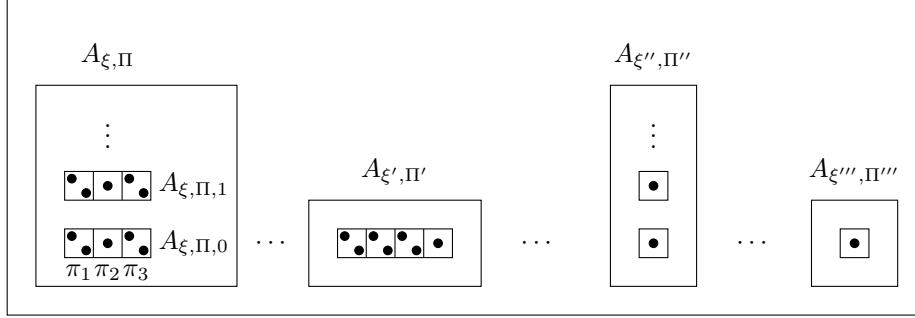

Figure 3: Construction of the domain A of $\mathfrak{A}(\mathcal{C})$ for \mathcal{C} a certificate.

(C3): Suppose $\langle \xi, \Pi \rangle, \langle \xi', \Pi' \rangle \in \Omega$ and $\xi \cap \xi' \cap V \neq \emptyset$. Let $a, b \in A$ be such that $\text{cstp}^{\mathfrak{A}}[a] = \langle \xi, \Pi \rangle$ and $\text{cstp}^{\mathfrak{A}}[b] = \langle \xi', \Pi' \rangle$. If there exists a fluted 1-type π'' realized both in the clique of a and in the clique of b , and, moreover, in just one clique of \mathfrak{A} , then a and b are in the same clique.

(C4): Suppose $\langle \xi, \Pi \rangle \in \Omega$ and $\neg \hat{T} \in \bigcup \xi$. By construction, there exists $b \in A$ such that $\text{ctp}^{\mathfrak{A}}[b] = \xi$, and $\mathfrak{A} \not\models \hat{T}[b]$. But then b is the only element of its clique, and we may set $\pi = \text{ftp}^{\mathfrak{A}}[b]$.

(C5): Suppose $\langle \xi, \Pi \rangle \in \Omega$, $\pi' \in \xi$ and $\pi \ll \pi'$. Let $a, a' \in A$ be such that $\text{cstp}^{\mathfrak{A}}[a] = \langle \xi, \Pi \rangle$, $\text{ftp}^{\mathfrak{A}}[a'] = \pi'$, and a' is in the same clique as a . To show that $\pi \notin \Pi$, we must show that, for all $b \in A$ such that $\text{ftp}^{\mathfrak{A}}[b] = \pi$, either $\mathfrak{A} \not\models T[a, b]$ or b is in the same clique as a . But this follows immediately from $\pi \ll \pi'$.

(C6): Suppose $\langle \xi, \Pi \rangle \in \Omega$, $\pi, \pi' \in \xi$ and $\pi \ll \pi'$. It follows that there is exactly one clique of \mathfrak{A} , say u , in which π and π' are both realized, and that $\text{cstp}^{\mathfrak{A}}[u] = \langle \xi, \Pi \rangle$. Since \mathfrak{A} is, by assumption, quadratic, there exists a fluted 1-type $\pi^* \in \xi$ realized only in u . Thus $\xi \cap V \neq \emptyset$. \square

Now suppose $\mathcal{C} = \langle \Omega, \ll, V \rangle$ is a certificate. We proceed to define a structure \mathfrak{A} . As an aide to intuition, we give an informal sketch first. The domain A is the disjoint union of sets $A_{\xi, \Pi}$, where (ξ, Π) ranges over Ω ; the elements of $A_{\xi, \Pi}$ will all be assigned the clique-super-type (ξ, Π) . If ξ contains no fluted 1-type π such that $\pi \in V$, then $A_{\xi, \Pi}$ will consist of infinitely many sets $A_{\xi, \Pi, i}$ ($i \geq 0$), referred to in the construction as ‘cells’. (It will later turn out that the cells are exactly the T -cliques.) If, on the other hand, ξ contains a fluted 1-type π such that $\pi \in V$, then $A_{\xi, \Pi}$ will consist of a single cell $A_{\xi, \Pi, 0}$. Note that, in the latter case, there will only ever be a single pair $(\xi, \Pi) \in \Omega$ such that $\pi \in \xi$, by (C3). Each cell $A_{\xi, \Pi, i}$ is in turn the disjoint union of sets $A_{\pi, \xi, \Pi, i}$, where π ranges over the fluted 1-types in ξ . Each element of the set $A_{\pi, \xi, \Pi, i}$ will be given fluted 1-type π , and this set has cardinality equal to $\xi(\pi)$ (i.e. either 1 or 2). Fig. 3 gives a schematic representation of the domain A , showing some representative sets $A_{\xi, \Pi}$; here, ξ contains the fluted 1-types π_1, π_2 and π_3 with the indicated multiplicities.

The relation T is defined as the transitive closure of the union of three

relations, t_0 , t_1 and t_2 , each of which plays a specific role. The relation t_0 specifies T within each cell, $A_{\xi, \Pi, i}$. As long as ξ contains no fluted 1-type π such that $-\hat{T} \in \pi$, we take t_0 to be the total relation on $A_{\xi, \Pi, i}$. If, on the other hand, ξ does contain a fluted 1-type π such that $-\hat{T} \in \pi$, then we take t_0 to be the empty relation on $A_{\xi, \Pi, i}$. Note that, in the latter case, $A_{\xi, \Pi, i}$ is in fact a singleton, by (C4). The relation t_1 , in essence, secures the existential commitments required by the clique-super-types. Specifically, if $a \in A_{\xi, \Pi, i}$ and $\pi' \in \Pi$, we select some $(\xi', \Pi') \in \Omega$ such that $\xi' \cup \Pi' \subseteq \Pi$ (possible by (C1)), and choose cells included in $A_{\xi', \Pi', j}$ whose elements will act as ‘witnesses’ for the fact that a has to be related by T to something of type π' . We need to be careful which cells we choose, however, because there is a danger of creating loops in the resulting graph of t_1 -links, which would result in the merging of more than one cell into a single clique. To avoid such loops, if $a \in A_{\xi, \Pi, i}$, we generally pick witnesses in $A_{\xi', \Pi', i+2}$ (so that, in particular, the last index increases). In one case, however, we must break this rule: if ξ' contains a fluted 1-type π'' such that $\pi'' \in V$, then $A_{\xi', \Pi', j}$ exists only for the value $j = 0$, and we need to do some work to ensure that unwanted loops do not arise here. Finally, the relation t_2 deals with the T -relations mandated by \ll . If $A_{\xi, \Pi, i}$ and $A_{\xi', \Pi', j}$ are distinct cells with $\pi \in \xi$ and $\pi' \in \xi'$, where $\pi \ll \pi'$, we take all elements of the former cell to be related by t_2 to all elements of the latter. Again, we need to do some work to ensure that this does not generate unwanted loops in the graph of t_1 - and t_2 -links.

Turning to the formal definition of \mathfrak{A} , we begin with the construction of the domain, A . For all $(\xi, \Pi) \in \Omega$, all $\pi \in \xi$ and all $i \in \mathbb{N}$, let $a_{\pi, \xi, \Pi, i}^+$ and $a_{\pi, \xi, \Pi, i}^-$ be fresh objects. Set

$$\begin{aligned}
A_{\pi, \xi, \Pi, i} &= \begin{cases} \{a_{\pi, \xi, \Pi, i}^+, a_{\pi, \xi, \Pi, i}^-\} & \text{if } \xi(\pi) = 2 \\ \{a_{\pi, \xi, \Pi, i}^+\} & \text{otherwise (i.e. if } \xi(\pi) = 1) \end{cases} \\
A_{\xi, \Pi, i} &= \bigcup_{\pi \in \xi} A_{\pi, \xi, \Pi, i} \\
A_{\xi, \Pi} &= \begin{cases} \bigcup_{i \in \mathbb{N}} A_{\xi, \Pi, i} & \text{if } \xi \cap V = \emptyset \\ A_{\xi, \Pi, 0} & \text{otherwise} \end{cases} \\
A &= \bigcup_{(\xi, \Pi) \in \Omega} A_{\xi, \Pi}.
\end{aligned}$$

The sets $A_{\xi, \Pi, i}$ will be called *cells*. If ξ is a soliton clique-type, we call the cell $A_{\xi, \Pi, i}$ a *soliton-cell*. It follows from (C4) that, in this case, $A_{\xi, \Pi, i} = \{a_{\pi, \xi, \Pi, i}^+\}$ for some fluted 1-type π . Note that the converse does not hold: it is perfectly feasible for the cell $A_{\xi, \Pi, i}$ to consist of the single element $a_{\pi, \xi, \Pi, i}^+$ even though $\hat{T} \in \pi$. Having defined A , we may set the extensions of all the ordinary (unary) predicates by stipulating $\text{ftp}^{\mathfrak{A}}[a] = \pi$ for all $a = a_{\pi, \xi, \Pi, i}^p \in A$, where $p \in \{+, -\}$.

It remains only to set the extension of the distinguished predicate T . To this end, we define three binary relations, t_0 , t_1 and t_2 . Let $a = a_{\pi, \xi, \Pi, i}^p$ and $a' = a_{\pi', \xi', \Pi', j}^{p'}$; and let $u = A_{\xi, \Pi, i}$ and $v = A_{\xi', \Pi', j}$ be the respective cells of

a and a' . We declare $t_0(a, a')$ if and only if $u = v$ (i.e. $\xi = \xi'$, $\Pi = \Pi'$, and $i = j$), and ξ is not a soliton clique-type. That is: t_0 holds between pairs of elements in the same non-soliton cell. Now declare $t_1(a, a')$ if (a) $\xi' \cup \Pi' \subseteq \Pi$; (b) $\xi' \cap V = \emptyset \Rightarrow j \geq i + 2$; and (c) $\xi \cap V \cap \Pi' = \emptyset$. Note that the relation t_1 depends only on the *cells* of its relata: that is to say, if $b \in u$ and $b' \in v$, then $t_1(a, a')$ implies $t_1(b, b')$. There being no ambiguity, we shall write, in this case, $t_1(u, v)$. Finally, declare $t_2(a, a')$ if $u \neq v$ and, for some fluted 1-types $\pi \in \xi$ and $\pi' \in \xi'$, we have $\pi \ll \pi'$. Again, we write in this case $t_2(u, u')$, since this relation depends only on the cells of its relata. Having defined the relations t_0 , t_1 and t_2 , we let $T^{\mathfrak{A}}$ be the transitive closure of $t_0 \cup t_1 \cup t_2$. We denote the structure \mathfrak{A} , constructed from the certificate \mathcal{C} as just described, by $\mathfrak{A}(\mathcal{C})$. Notice that $\mathfrak{A}(\mathcal{C})$ will in general be infinite.

We must check that $\mathfrak{A}(\mathcal{C})$ interprets the predicates T and \hat{T} consistently. Lemmas 8–11 do precisely this.

Lemma 8. *If $t_1(a, a')$, then a and a' occupy different cells of A .*

Proof. Suppose for contradiction that $t_1(a, a')$ with $a = a_{\pi, \xi, \Pi, i}^p$ and $a' = a_{\pi', \xi, \Pi, i}^{p'}$. By condition (a) in the definition of t_1 , we have $\xi \subseteq \Pi$, and, by condition (b), we have, $\xi \cap V \neq \emptyset$, whence $\xi \cap V \cap \Pi \neq \emptyset$, contradicting condition (c). \square

Now consider the directed graph on the set of cells of A defined by the relation $t_1 \cup t_2$. We show that this graph is acyclic. It follows that the cells (both soliton and non-soliton) are the cliques of the relation $T^{\mathfrak{A}}$, and hence that $T^{\mathfrak{A}}$ induces a strict partial order on these cells.

Lemma 9. *Suppose u_0, \dots, u_k ($k \geq 1$) is a sequence of cells such that, for all h ($0 \leq h < k$) either $t_1(u_h, u_{h+1})$ or $t_2(u_h, u_{h+1})$. Writing $u_h = A_{\xi_h, \Pi_h, i_h}$ for all h ($0 \leq h \leq k$), we have $\xi_k \cup \Pi_k \subseteq \Pi_0$.*

Proof. We proceed by induction on k . For the base case ($k = 1$) if $t_1(u_0, u_1)$, then the result is immediate by (a) in the definition of t_1 . If $t_2(u_0, u_1)$, then there exist $\pi_0 \in \xi_0$ and $\pi_1 \in \xi_1$ such that $\pi_0 \ll \pi_1$. The result then follows from (C2). For the inductive case ($k > 1$), we have by inductive hypothesis, $\xi_{k-1} \cup \Pi_{k-1} \subseteq \Pi_0$; and from the base case applied to the sequence u_{k-1}, u_k , we have $\xi_k \cup \Pi_k \subseteq \Pi_{k-1}$. \square

Lemma 10. *There exists no sequence of cells $u_0, \dots, u_k = u_0$ ($k \geq 2$) such that, for all h ($0 \leq h < k$) either $t_1(u_h, u_{h+1})$ or $t_2(u_h, u_{h+1})$.*

Proof. Suppose for contradiction that such a sequence exists, again writing $u_h = A_{\xi_h, \Pi_h, i_h}$ for all h ($0 \leq h \leq k$). By Lemma 9, $\Pi_0 = \dots = \Pi_k = \Pi$, say, and $\xi_h \in \Pi$ for all h ($0 \leq h \leq k$). It follows that we cannot have $t_2(u_h, u_{h+1})$ for any h ($0 \leq h < k$), since, if there exist $\pi_h \in \xi_h$ and $\pi_{h+1} \in \xi_{h+1}$ with $\pi_h \ll \pi_{h+1}$, then, by (C5), $\pi_{h+1} \notin \Pi_h = \Pi$, contradicting $\xi_{h+1} \subseteq \Pi$. Thus, we may assume that $t_1(u_h, u_{h+1})$ for all h ($0 \leq h < k$). Necessarily, $i_{h+1} \leq i_h$ for some h in the same range; indeed, by rotating the original sequence if necessary, we may

assume without loss of generality that $h < k - 1$. By (b) in the definition of t_1 , $\xi_{h+1} \cap V \neq \emptyset$, and by (c), $\xi_{h+1} \cap V \cap \Pi_{h+2} = \emptyset$. But we have just argued that $\xi_{h+1} \subseteq \Pi$ and $\Pi_{h+2} = \Pi$. This is a contradiction. \square

Lemma 11. *In the structure $\mathfrak{A} = \mathfrak{A}(\mathcal{C})$, we have $\hat{T}^{\mathfrak{A}} = \{a \in A \mid \mathfrak{A} \models T[a, a]\}$.*

Proof. Fix $a \in A_{\pi, \xi, \Pi, i}$. If $\mathfrak{A} \models \hat{T}[a]$, then $\hat{T} \in \pi$, whence, by (C4), ξ is not a soliton clique type. Hence $t_0(a, a)$, and $\mathfrak{A} \models T[a, a]$. Conversely, if $\mathfrak{A} \not\models \hat{T}[a]$, then $\neg \hat{T} \in \pi$, so that ξ is certainly a soliton type, and a is not related to itself by t_0 . On the other hand, by Lemma 10, there is no sequence of cells u_0, \dots, u_k ($k \geq 2$) with $a \in u_0 = u_k$, such that, for all h ($0 \leq h < k$), either $t_1(u_h, u_{h+1})$ or $t_2(u_h, u_{h+1})$. Since $T^{\mathfrak{A}}$ is the transitive closure of $t_0 \cup t_1 \cup t_2$, we see that $\mathfrak{A} \not\models T[a, a]$, as required. \square

Thus, from a quadratic structure \mathfrak{A} , we can define a certificate $\mathcal{C}(\mathfrak{A})$, and from a certificate \mathcal{C} , we can define a structure $\mathfrak{A}(\mathcal{C})$. (It is easy to see that \mathfrak{A} will in fact be quadratic, though this is inessential.) Let $\mathcal{C} = \langle \Omega, \ll, V \rangle$ be a certificate and ψ a basic formula. We next define a relation \models of *satisfaction* between these relata. In this definition, for any fluted 1-type π , we say that π *occurs* in \mathcal{C} if, there exists $\langle \xi, \Pi \rangle \in \Omega$ such that $\pi \in \xi$.

1. ψ is $\forall(\pi \rightarrow \exists(\mu \wedge T \wedge \neq))$: $\mathcal{C} \models \psi$ if and only if, for all $\langle \xi, \Omega \rangle \in \Omega$, with $\pi \in \xi$, either (i) $\models \pi \rightarrow \mu$ and $\xi(\pi) = 2$; or (ii) there exists $\pi' \in \xi$ such that $\pi' \neq \pi$ and $\models \pi' \rightarrow \mu$; or (iii) there exists $\pi' \in \Pi$ such that $\models \pi' \rightarrow \mu$.
2. ψ is $\forall(\pi \rightarrow \exists(\mu \wedge \neg T \wedge \neq))$: $\mathcal{C} \models \psi$ if and only if, for all $\langle \xi, \Pi \rangle \in \Omega$ with $\pi \in \xi$, there exists $\langle \xi', \Pi' \rangle \in \Omega$ such that (i) $\models \pi' \rightarrow \mu$; (ii) there exist no $\pi'' \in \Pi$ and $\pi''' \in \xi'$ such that $\pi'' \ll \pi'''$; (iii) $\xi' \cap \Pi \cap V = \emptyset$; and (iv) $\langle \xi, \Pi \rangle = \langle \xi', \Pi' \rangle \Rightarrow \xi \cap V = \emptyset$.
3. ψ is $\forall(\pi \rightarrow \forall(\pi' \rightarrow T))$, where $\pi \neq \pi'$: $\mathcal{C} \models \psi$ if and only if one of the following obtains: (i) one of π or π' does not occur in \mathcal{C} ; (ii) $\pi \ll \pi'$; or (iii) for all $\langle \xi, \Pi \rangle, \langle \xi', \Pi' \rangle \in \Omega$ such that $\pi \in \Pi$ and $\pi' \in \xi'$, we have $\xi = \xi'$, $\Pi = \Pi'$ and $\xi \cap V \neq \emptyset$.
4. ψ is $\forall(\pi \rightarrow \forall(\pi' \rightarrow \neg T))$, where $\pi \neq \pi'$: $\mathcal{C} \models \psi$ if and only if for all $\langle \xi, \Pi \rangle \in \Omega$ such that $\pi \in \xi$, $\pi' \notin \xi \cup \Pi$.
5. ψ is $\forall(\pi \rightarrow \forall(\pi \rightarrow (= \vee T)))$: $\mathcal{C} \models \psi$ if and only if there is at most one $\langle \xi, \Pi \rangle \in \Omega$ such that $\pi \in \xi$, and, if such a $\langle \xi, \Pi \rangle$ exists, then $\xi \cap V \neq \emptyset$.
6. ψ is $\forall(\pi \rightarrow \forall(\pi \rightarrow (= \vee \neg T)))$: $\mathcal{C} \models \psi$ if and only if for all $\langle \xi, \Pi \rangle \in \Omega$, $\pi \notin \xi \cap \Pi$, and $\xi(\pi) \leq 1$.
7. ψ is $\forall\mu$: $\mathcal{C} \models \psi$ if and only if, for all $\langle \xi, \Pi \rangle \in \Omega$ and $\pi \in \xi$, $\models \pi \rightarrow \mu$.
8. ψ is $\exists\mu$: $\mathcal{C} \models \psi$ if and only if there exist $\langle \xi, \Pi \rangle \in \Omega$ and $\pi \in \xi$ such that $\models \pi \rightarrow \mu$.

Finally, we show that satisfaction of formulas by certificates corresponds to satisfaction of formulas by structures in the sense captured by the following two lemmas.

Lemma 12. *Let ψ be a basic formula, and suppose $\mathfrak{A} \models \psi$ for some quadratic structure \mathfrak{A} . Then $\mathcal{C}(\mathfrak{A}) \models \psi$.*

Proof. Write $\mathcal{C}(\mathfrak{A}) = \langle \Omega, \ll, V \rangle$. We consider the forms of ψ in turn.

1. ψ is $\forall(\pi \rightarrow \exists(\mu \wedge T \wedge \neq))$: Suppose $\mathfrak{A} \models \psi$ and $(\xi, \Pi) \in \Omega$ with $\pi \in \xi$. Let $a \in A$ be such that $\text{cstp}^{\mathfrak{A}}[a] = (\xi, \Pi)$ and $\text{ftp}^{\mathfrak{A}}[a] = \pi$. Pick $b \in A \setminus \{a\}$ such that $\mathfrak{A} \models \mu[b]$ and $\mathfrak{A} \models T[a, b]$, and let $\text{ftp}^{\mathfrak{A}}[b] = \pi'$. Thus, $\models \pi' \rightarrow \mu$. (i) If a and b are in the same clique of \mathfrak{A} and $\pi = \pi'$, then $\models \pi \rightarrow \mu$, and $\xi(\pi) = 2$. (ii) If a and b are in the same clique, but $\pi' \neq \pi$, then $\pi' \in \xi$. (iii) If a and b are not in the same clique, then $\pi \in \Pi$.
2. ψ is $\forall(\pi \rightarrow \exists(\mu \wedge \neg T \wedge \neq))$: Suppose $\mathfrak{A} \models \psi$ and $(\xi, \Pi) \in \Omega$ with $\pi \in \xi$. Let $a \in A$ be such that $\text{cstp}^{\mathfrak{A}}[a] = (\xi, \Pi)$ and $\text{ftp}^{\mathfrak{A}}[a] = \pi$. Pick $b \in A \setminus \{a\}$ such that $\mathfrak{A} \models \mu[b]$ and $\mathfrak{A} \not\models T[a, b]$, and let $\text{cstp}^{\mathfrak{A}}[b] = (\xi', \Pi')$, and $\text{ftp}^{\mathfrak{A}}[b] = \pi'$. (i) Thus, $\models \pi' \rightarrow \mu$. (ii) Suppose, for contradiction, that there exist $\pi'' \in \Pi$ and $\pi''' \in \xi'$ such that $\pi'' \ll \pi'''$. Then there exist $b'', b''' \in A$ such that $\mathfrak{A} \models T[a, b'']$, $\mathfrak{A} \models T[b'', b''']$, with b''' in the same clique as b , contradicting the assumption that $\mathfrak{A} \not\models T[a, b]$. (iii) Suppose, for contradiction, that $\pi'' \in \xi' \cap \Pi \cap V$. Then there exists $b'' \in A$ with $\text{ftp}^{\mathfrak{A}}[b''] = \pi''$, realized in just one clique (namely, the clique of b) and an element b''' with $\text{ftp}^{\mathfrak{A}}[b'''] = \pi''$ and $\mathfrak{A} \models T[a, b''']$. This contradicts the supposition that $\mathfrak{A} \not\models T[a, b]$. (iv) Suppose, for contradiction, that $(\xi, \Pi) = (\xi', \Pi')$ and $\pi'' \in \xi \cap V$. Then the cliques of both a and b contain elements of fluted 1-type π'' , with such elements realized in just one clique. Thus a and b are in the same clique, which contradicts the supposition that $\mathfrak{A} \not\models T[a, b]$.
3. ψ is $\forall(\pi \rightarrow \forall(\pi' \rightarrow T))$, where $\pi \neq \pi'$: Suppose $\mathfrak{A} \models \psi$. (i) If π and π' are not both realized in \mathfrak{A} , then they do not both occur in \mathcal{C} . If π and π' are both realized in \mathfrak{A} , and $\mathfrak{A} \not\models \forall(\pi' \rightarrow \forall(\pi \rightarrow T))$, then $\pi \ll \pi'$. (iii) Otherwise, π and π' are realized in \mathfrak{A} , but there is a clique, say u , containing all these realizing elements. Hence, if $(\xi, \Pi), (\xi', \Pi') \in \Omega$ with $\pi \in \xi$ and $\pi' \in \xi'$, then $(\xi, \Pi) = (\xi', \Pi')$, and $\pi \in V$, whence $\xi \cap V \neq \emptyset$.
4. ψ is $\forall(\pi \rightarrow \forall(\pi' \rightarrow \neg T))$, where $\pi \neq \pi'$: Suppose $\mathfrak{A} \models \psi$ and $(\xi, \Pi) \in \Omega$ with $\pi \in \xi$. Then there exist $a \in A$ such that $\text{cstp}^{\mathfrak{A}}[a] = (\xi, \Pi)$. By the definition of $\text{cstp}^{\mathfrak{A}}[a]$, $\pi' \notin \xi \cup \Pi$.
5. ψ is $\forall(\pi \rightarrow \forall(\pi \rightarrow (= \vee T)))$: Suppose $\mathfrak{A} \models \psi$. Then all elements $a \in A$ such that $\text{ftp}^{\mathfrak{A}}[a] = \pi$ lie in a single clique, so let their common clique-super-type be (ξ, Π) . Thus, (ξ, Π) is the only element of Ω such that $\pi \in \xi$; moreover, if this element exists, we have $\pi \in V$, and hence $\xi \cap V \neq \emptyset$.
6. ψ is $\forall(\pi \rightarrow \forall(\pi \rightarrow (= \vee \neg T)))$: Suppose $\mathfrak{A} \models \psi$ and $(\xi, \Pi) \in \Omega$ with $\pi \in \xi$. Let $a \in A$ be such that $\text{cstp}^{\mathfrak{A}}[a] = (\xi, \Pi)$ and $\text{ftp}^{\mathfrak{A}}[a] = \pi$, and let u be the

clique of a in \mathfrak{A} . Since $\mathfrak{A} \models \psi$, there is certainly no element $b \in A \setminus u$ such that $\text{ftp}^{\mathfrak{A}}[b] = \pi$ and $\mathfrak{A} \models T[b, a]$, whence $\pi \notin \Pi$. On the other hand, there is no element $b \in u \setminus \{a\}$ such that $\text{ftp}^{\mathfrak{A}}[b] = \pi$, whence $\xi(\pi) = 1$.

The cases $\forall\mu$ and $\exists\mu$ are routine. \square

Lemma 13. *Let ψ be a basic formula, and suppose $\mathcal{C} \models \psi$ for some certificate \mathcal{C} . Then $\mathfrak{A}(\mathcal{C}) \models \psi$.*

Proof. Write $\mathcal{C} = \langle \Omega, \ll, V \rangle$ and $\mathfrak{A} = \mathfrak{A}(\mathcal{C})$. We consider the forms of ψ in turn.

1. ψ is $\forall(\pi \rightarrow \exists(\mu \wedge T \wedge \neq))$: Suppose $\mathcal{C} \models \psi$ and $a \in A$ with $\text{ftp}^{\mathfrak{A}}[a] = \pi$. We may write $a = a_{\pi, \xi, \Pi, i}^p$, for $(\xi, \Pi) \in \Omega$ with $\pi \in \xi$. We must show that there exists $b \in A \setminus \{a\}$ such that $\mathfrak{A} \models \mu[b]$ and $\mathfrak{A} \models T[a, b]$. (i) If $\models \pi \rightarrow \mu$ and $\xi(\pi) = 2$, then, by construction of \mathfrak{A} , there exists $b = a_{\pi, \xi, \Pi, i}^{p'}$ with $p' \neq p$. Thus, $\text{ftp}^{\mathfrak{A}}[b] = \pi$ and $t_0(a, b)$, whence $\mathfrak{A} \models T[a, b]$. (ii) If there exists $\pi' \in \xi$ such that $\pi' \neq \pi$ and $\models \pi' \rightarrow \mu$, there exists $b = a_{\pi', \xi, \Pi, i}^p$. Thus, $\text{ftp}^{\mathfrak{A}}[b] = \pi'$ and $t_0(a, b)$, whence $\mathfrak{A} \models T[a, b]$. (iii) If there exists $\pi' \in \Pi$ such that $\models \pi' \rightarrow \mu$, then, by (C1), choose $(\xi', \Pi') \in \Omega$ with $\pi' \in \xi'$, $\xi' \cup \Pi' \subseteq \Pi$ and $\xi \cap \Pi' \cap V = \emptyset$. Suppose on the one hand that $\xi' \cap V = \emptyset$. Then we may let $b = a_{\pi', \xi', \Pi', i+2}^+$. Certainly, $\text{ftp}^{\mathfrak{A}}[b] = \pi'$. It suffices to prove that $t_1(a, b)$, whence $\mathfrak{A} \models T[a, b]$. We consider conditions (a)–(c) in the definition of t_1 . (a) We have already established that $\xi' \cup \Pi' \subseteq \Pi$. (b) Trivially, $i+2 \geq i+2$. (c) *A fortiori*, $\xi' \cap V \cap \Pi = \emptyset$. Suppose on the other hand that $\xi' \cap V \neq \emptyset$. Then we may let $b = a_{\pi', \xi', \Pi', 0}^+$. Since $\xi \cap \Pi' \cap V = \emptyset$, we have $\xi \neq \xi'$, so that $b \neq a$. Again, consider conditions (b) and (c) in the definition of t_1 . For (b), we are supposing anyway that $\xi' \cap V \neq \emptyset$, and for (c), we have already established that $\xi \cap \Pi' \cap V = \emptyset$. Thus, in all cases, we have $\mathfrak{A} \models \mu[b]$ and $\mathfrak{A} \models T[a, b]$, as required.
2. ψ is $\forall(\pi \rightarrow \exists(\mu \wedge \neg T \wedge \neq))$: Suppose $\mathcal{C} \models \psi$ and $a \in A$ with $\text{ftp}^{\mathfrak{A}}[a] = \pi$. We may write $a = a_{\pi, \xi, \Pi, i}^p$, for $(\xi, \Pi) \in \Omega$ with $\pi \in \xi$. Then we may select $(\xi', \Pi') \in \Omega$ with $\pi' \in \xi'$ such that: (i) $\models \pi' \rightarrow \mu$; (ii) there exists no $\pi'' \in \Pi$ and $\pi''' \in \xi'$ such that $\pi'' \ll \pi'''$; (iii) $\xi' \cap \Pi \cap V = \emptyset$; and (iv) $(\xi, \Pi) = (\xi', \Pi') \Rightarrow \xi \cap V = \emptyset$. Suppose on the one hand that $(\xi', \Pi') \neq (\xi, \Pi)$. Let $b = a_{\pi', \xi', \Pi', 0}^+$, so that, by construction of \mathfrak{A} , $\text{ftp}^{\mathfrak{A}}[b] = \pi'$. We must show that $a \neq b$ and $\mathfrak{A} \not\models T[a, b]$. Let u be the cell containing a and u' the cell containing b . Since $(\xi', \Pi') \neq (\xi, \Pi)$, we have $u \neq u'$, whence, certainly $a \neq b$. So suppose for contradiction that there is a sequence of $(t_1 \cup t_2)$ -links from u to u' . Let $u'' \in A_{\xi'', \Pi''}$, say, be the penultimate element of this sequence. Certainly, there is no t_2 -link from u'' to u' , since this would require $\pi'' \in \xi''$ and $\pi''' \in \xi'$ with $\pi'' \ll \pi'''$. But by Lemma 9, we would then have $\pi'' \in \Pi$, which is ruled out by (ii). On the other hand, if there were a t_1 -link from u'' to u' , then we would have $\xi' \cap V \neq \emptyset$, and again by Lemma 9, $\xi' \subseteq \Pi$, whence $\xi' \cap V \cap \Pi \neq \emptyset$, which is ruled out by (iii). Suppose on the other hand that $(\xi', \Pi') = (\xi, \Pi)$. But then (iv) implies $\xi \cap V = \emptyset$, so that we may select $b = a_{\pi', \xi, \Pi, j}^+$, where $j = 1$ if $i = 0$ and $j = 0$ otherwise. Again,

let u be the cell containing a and u' the cell containing b . Thus $u \neq u'$, whence certainly $a \neq b$. Moreover, $\mathfrak{A} \models \mu[b]$. Again, it remains to show that $\mathfrak{A} \not\models T[a, b]$. Suppose there is a chain $u = u_0, \dots, u_k = u'$ of $(t_1, \cup t_2)$ -links. By construction of t_1 , we must have $t_2(u_{k-1}, u_k)$, since $j \leq 1$. Then there exists $\pi'' \in \xi_{k-1}$ and $\pi''' \in \xi_k$ such that $\pi'' \ll \pi'''$. Then, certainly, $k > 1$ since, otherwise, $\xi_0 = \xi_k = \xi$ contains both π'' and π''' with $\pi'' \ll \pi'''$ and $\xi \cap V = \emptyset$, which contravenes (C6). But if $k > 1$, then $\pi \in \Pi$ by Lemma 9, which contravenes (C5). Thus, we have shown that $\mathfrak{A} \not\models T[a, b]$ as required.

3. ψ is $\forall(\pi \rightarrow \forall(\pi' \rightarrow T))$, where $\pi \neq \pi'$: Suppose $\mathcal{C} \models \psi$, and that $a, a' \in A$ with $\text{ftp}^{\mathfrak{A}}[a] = \pi$ and $\text{ftp}^{\mathfrak{A}}[a'] = \pi'$. Write $a = a_{\pi, \xi, \Pi, i}^p$ and $a' = a_{\pi', \xi', \Pi', j}^{p'}$. We must show that $\mathfrak{A} \not\models T[a, a']$. We consider the three possibilities in the definition of $\mathcal{C} \models \psi$. (i) By construction of \mathfrak{A} , π and π' both occur in \mathcal{C} , so the first possibility does not arise. (ii) Suppose that $\pi \ll \pi'$. If a and a' are in different cells, then then we immediately have $t_2(a, a')$. If, on the other hand, a and a' are in the same cell, then since $\pi \neq \pi'$, by (C4), $-\hat{T} \notin \cup \xi$, whence $t_0(a, a')$. (iii) Suppose that there is a single clique-super-type $(\xi, \Pi) \in \Omega$ such that ξ contains either π or π' and that $\xi \cap V \neq \emptyset$. By the construction of \mathfrak{A} , a and a' belong to the same cell $A_{\xi, \Pi, 0}$, and again by (C4), $-\hat{T} \notin \cup \xi$, whence $t_0(a, a')$. In all cases, then, $\mathfrak{A} \models T[a, a']$, as required.
4. ψ is $\forall(\pi \rightarrow \forall(\pi' \rightarrow \neg T))$, where $\pi \neq \pi'$: Suppose $\mathcal{C} \models \psi$, and that $a, a' \in A$ with $\text{ftp}^{\mathfrak{A}}[a] = \pi$ and $\text{ftp}^{\mathfrak{A}}[a'] = \pi'$. Write $a = a_{\pi, \xi, \Pi, i}^p$ and $a' = a_{\pi', \xi', \Pi', j}^{p'}$. From the definition of $\mathcal{C} \models \psi$, we have $\pi' \notin \xi \cup \Pi$, whence $\xi \neq \xi'$. Thus, a and a' occupy different cells, say, u and u' , respectively. By Lemma 9, there is no chain $u = u_0, \dots, u_k = u'$ of $(t_1 \cup t_2)$ -links. Therefore, $\mathfrak{A} \not\models T[a, a']$, as required.
5. ψ is $\forall(\pi \rightarrow \forall(\pi \rightarrow (= \vee T)))$: Suppose $\mathcal{C} \models \psi$, and that $a, a' \in A$ with $\text{ftp}^{\mathfrak{A}}[a] = \text{ftp}^{\mathfrak{A}}[a'] = \pi$ and $a \neq a'$. From the definition of $\mathcal{C} \models \psi$ and the construction of \mathfrak{A} , a and a' belong to the same set $A_{\xi, \Pi}$ and, moreover, $\xi \cap V \neq \emptyset$. It follows that a and a' belong to the cell $A_{\pi, \xi, \Pi, 0}$. Since $a \neq a'$, by the construction of A , $\xi(\pi) = 2$, whence by (C4), ξ is not a soliton clique-type, whence $t_0(a, a')$. Thus $\mathfrak{A} \models T[a, a']$, as required.
6. ψ is $\forall(\pi \rightarrow \forall(\pi \rightarrow (= \vee \neg T)))$: Suppose $\mathcal{C} \models \psi$. It follows immediately by construction of \mathfrak{A} that no set $A_{\pi, \xi, \Pi, i}$ can have cardinality greater than 1. Now suppose $a, a' \in A$ with $\text{ftp}^{\mathfrak{A}}[a] = \text{ftp}^{\mathfrak{A}}[a'] = \pi$ and $a \neq a'$. Thus, a and a' are not in the same cell, and hence by Lemma 9, $\mathfrak{A} \models T[a, a']$ implies $\xi' \subseteq \Pi$, whence $\pi \in \Pi$, contradicting the definition of $\mathcal{C} \models \psi$. Thus, $\mathfrak{A} \not\models T[a, a']$, as required.

The cases $\forall\mu$ and $\exists\mu$ are routine. □

Lemma 14. *There exists a non-deterministic procedure which, when given a set Φ of basic $\mathcal{FL}_{=}^2 1\Gamma^u$ -formulas over a signature Σ , will terminate in time bounded by $g(2^{2^{g(\|\Sigma\|)}} + \|\Phi\|)$, for some fixed polynomial g , and which has an accepting run if and only if Φ is satisfiable.*

Proof. Let Φ be given. By Lemma 5, the following are equivalent: Φ is satisfiable; Φ^* is satisfied in a quadratic structure; Φ^* is satisfiable. Observe that Φ^* (a set of basic formulas over some signature $\Sigma^* \supseteq \Sigma$) can be computed in time bounded by a polynomial function of Φ . By Lemma 12, if Φ^* is satisfiable over a quadratic structure then there exists a certificate \mathcal{C} , interpreting Σ^* , such that $\mathcal{C} \models \Phi^*$. By Lemma 13, if there exists a certificate \mathcal{C} over Σ^* , such that $\mathcal{C} \models \Phi^*$, then Φ^* is satisfiable. Evidently $\|\mathcal{C}\|$ is bounded by a doubly exponential function of $|\Sigma^*|$, and the condition $\mathcal{C} \models \Phi^*$ may be checked in time bounded by a polynomial function of $\|\Phi^*\| + \|\mathcal{C}\|$. \square

3.2. The logic $\mathcal{FL}_{=}^2 1T$

The next step is to allow arbitrary (non-distinguished) binary predicates; that is, we consider the logic $\mathcal{FL}_{=}^2 1T$, the 2-variable fluted fragment with equality and a single, distinguished, transitive relation T .

In the context of a structure interpreting a relational signature, a *king* is an element whose fluted 1-type is not realized by any other element in that structure. The fluted 1-types of kings are called *royal*. We make use of the well-known fact that, in two-variable logic, parts of structures may be duplicated as long as they contain no king. We use the formulation appearing in [16, Lemma 4.1]. The proof given there concerns two-variable first-order logic with a single distinguished predicate interpreted as a *partial order*; however, the proof for the (present) case in which it is interpreted as a *transitive relation* is identical, and we need not repeat it here.

Lemma 15. *Let \mathfrak{A}_1 be a structure over domain A_1 , A_0 the set of kings of \mathfrak{A}_1 , \mathfrak{A}_0 the restriction of \mathfrak{A} to A_0 , and $B_1 = A_1 \setminus A_0$. There exists a family of sets $\{B_i\}_{i \geq 2}$, pairwise disjoint and disjoint from A_1 , a family of bijections $\{f_i\}_{i \geq 1}$, where $f_i : B_i \rightarrow B_1$, and a sequence of structures $\{\mathfrak{A}_i\}_{i \geq 2}$, where \mathfrak{A}_i has domain $A_i = A_0 \cup B_1 \cup B_2 \cup \dots \cup B_i$, such that, for all $i \geq 1$:*

- (i) $\mathfrak{A}_{i-1} \subseteq \mathfrak{A}_i$, and all 2-types realized in \mathfrak{A}_i are realized in \mathfrak{A}_1 ;
- (ii) for all $a \in B_i$ and all $b \in A_1$, if $f_i(a) \neq b$, then $\text{ftp}^{\mathfrak{A}_i}[a, b] = \text{ftp}^{\mathfrak{A}_1}[f_i(a), b]$;
- (iii) for all $a \in B_i$, all j ($1 \leq j \leq i$) and all $b \in B_j$, if $f_i(a) \neq f_j(b)$, then $\text{ftp}^{\mathfrak{A}_i}[a, b] = \text{ftp}^{\mathfrak{A}_1}[f_i(a), f_j(b)]$;
- (iv) $T^{\mathfrak{A}_i}$ is a transitive relation.

Intuitively, the sets B_2, \dots, B_i are copies of B_1 . This copying process may be continued indefinitely (or even infinitely); we require only finitely many iterations in this paper.

Recall the notion of normal form for $\mathcal{FL}_{=}^m 1T$ given in (5). For $m = 2$, we obtain the special case

$$\bigwedge_{i \in S} \forall (\mu_i \rightarrow \exists (\kappa_i \wedge \Gamma_i)) \wedge \bigwedge_{j \in T} \forall (\nu_j \rightarrow \forall \Delta_j) \wedge \forall \forall \Omega, \quad (6)$$

where S and T are finite sets of indices, such that, for $i \in S$ and $j \in T$, μ_i and ν_j are quantifier-free formulas of arity 1, κ_i is a control formula, and Γ_i , Δ_j , and Ω are sets of fluted 2-clauses. Our strategy will be to reduce the satisfiability problem for formulas of the form (6) to that of sets of basic $\mathcal{FL}_{=}^2\text{1T}^u$ -formulas. We begin by introducing a variant of the normal form for $\mathcal{FL}_{=}^2\text{1T}$. A formula of this logic is in *spread normal form* if it has the shape

$$\bigwedge_{h \in R} \exists \lambda_h \wedge \bigwedge_{i \in S} \forall (\mu_i \rightarrow \exists (o_i \wedge \kappa_i \wedge \Gamma_i)) \wedge \bigwedge_{j \in T} \forall (\nu_j \rightarrow \forall \Delta_j) \wedge \forall \forall \Omega \wedge \bigwedge_{i, i' \in S}^{i \neq i'} \forall (o_i \rightarrow \neg o_{i'}), \quad (7)$$

where R is an index set, the λ_h ($h \in R$) are quantifier-free, unary formulas, the o_i ($i \in S$) are unary predicates, and S , T , Ω , μ_i , ν_j , κ_i , Γ_i , Δ_j are as before. The essential change here is the insertion of the atoms o_i into the conjuncts $\forall (\mu_i \rightarrow \exists (\kappa_i \wedge \Gamma_i))$ of (6) together with the addition of the conjuncts $\forall (o_i \rightarrow \neg o_{i'})$ for distinct indices i and i' . The point is that, if an object satisfies μ_i for several indices i , the corresponding witnesses of the formula $\exists (o_i \wedge \kappa_i \wedge \Gamma_i)$ for that element are all distinct. As we might say, the witness requirements are ‘spread’ over different objects. The other change in (7) is the addition of the conjuncts $\exists \lambda_h$. These are required if we are going to convert normal-form $\mathcal{FL}_{=}^2\text{1T}$ -sentences into spread normal form without incurring an unacceptable inflation in the size of the signature, as promised by the next lemma.

Lemma 16. *Let φ be a normal-form $\mathcal{FL}_{=}^2\text{1T}$ -formula and $\Pi = \{\pi_1, \dots, \pi_L\}$ a set of fluted 1-types over the signature of φ . We can compute, in time bounded by an exponential function of $\|\varphi\|$, a formula ψ in spread normal form, such that: (i) the signature of ψ is bounded in size by a polynomial function of $\|\varphi\|$; (ii) $\models \psi \rightarrow \varphi$; and (iii) if φ has a (finite) model in which Π is the set of royal fluted 1-types, then ψ has a (finite) model.*

Proof. Let φ have the shape

$$\bigwedge_{i \in S} \forall (\mu_i \rightarrow \exists (\kappa_i \wedge \Gamma_i)) \wedge \bigwedge_{j \in T} \forall (\nu_j \rightarrow \forall \Delta_j) \wedge \forall \forall \Omega.$$

Let o_i be a fresh unary predicate for each $i \in S$, let $k = \lceil \log((L+1) \cdot |S|) \rceil$, and let w_0, \dots, w_{k-1} be a collection of fresh unary predicates. Observe that k is polynomially bounded as a function of $\|\varphi\|$. For each $i \in S$ and each ℓ ($0 \leq \ell \leq L$), we take $\bar{w}\langle i, \ell \rangle$ to be a distinct formula of the form $\pm w_0 \wedge \dots \wedge \pm w_k$. As a guide to intuition, read the (1-place) formula $\bar{w}\langle i, 0 \rangle$ as characterizing those elements a such that there exists a non-royal b with a, b satisfying Γ_i , read the formulas $\bar{w}\langle i, \ell \rangle$ ($1 \leq \ell \leq L$) as characterizing those elements a such that a, b_ℓ satisfies Γ_i , where b_ℓ is the king with fluted 1-type π_ℓ , and finally take the predicates o_i to pick out pairwise disjoint collections of non-royal elements (we will say more presently about how these sets are chosen).

We define ψ to be the conjunction of the following formulas.

$$\bigwedge_{\ell=1}^L \exists \pi_\ell \quad (8)$$

$$\bigwedge_{i \in S} \forall(\bar{w}\langle i, 0 \rangle \rightarrow \exists(o_i \wedge \kappa_i \wedge \Gamma_i)) \quad (9)$$

$$\bigwedge_{i \in S} \bigwedge_{\ell=1}^L \forall(\bar{w}\langle i, \ell \rangle \rightarrow \forall(\pi_\ell \rightarrow (\kappa_i \wedge \Gamma_i))) \quad (10)$$

$$\bigwedge_{i \in S} \forall(\mu_i \rightarrow \bigvee_{\ell=0}^L \bar{w}\langle i, \ell \rangle) \quad (11)$$

$$\bigwedge_{j \in T} \forall(\nu_j \rightarrow \forall \Delta_j) \quad (12)$$

$$\bigwedge_{i, i' \in S}^{i \neq i'} \forall \neg(o_i \wedge o'_i) \wedge \forall \forall \Omega. \quad (13)$$

The conjuncts (8)–(11) clearly entail $\bigwedge_{i \in S} \forall(\mu_i \rightarrow \exists(\kappa_i \wedge \Gamma_i))$. Thus, $\psi \rightarrow \varphi$. Suppose, on the other hand, $\mathfrak{A}_1 \models \varphi$ with the set of royal types in \mathfrak{A}_1 equal to Π . We may assume without loss of generality that $S = \{1, \dots, s\}$. Let the set of kings in \mathfrak{A}_1 be A_0 , and apply the construction of Lemma 15 to obtain the structures $\mathfrak{A}_2, \dots, \mathfrak{A}_s$. Let $\mathfrak{B} = \mathfrak{A}_s$, a model of φ with domain $B = A_0 \cup B_1 \cup \dots \cup B_s$. For all $a \in B$, if there exists a non-royal element b such that $\mathfrak{B} \models \Gamma_i[a, b]$, then there exists such a b in each of the sets B_1, \dots, B_s . Now expand \mathfrak{B} to a model \mathfrak{B}^+ by setting $o_i^{\mathfrak{B}^+} = B_i$, and interpreting the predicates w_0, \dots, w_{k-1} so that the formulas $\bar{w}\langle i, \ell \rangle$ ($0 \leq \ell \leq L$) have the interpretations suggested above. It is then simple to check that $\mathfrak{B}^+ \models \psi$. We remark finally that the consequents $(\kappa_i \wedge \Gamma_i)$ occurring in (10) can of course be written as a set of fluted clauses since $=, \neq, T$ and $\neg T$ are fluted literals. Hence ψ is in spread normal form. \square

Lemma 17. *Let φ be a spread normal-form $\mathcal{FL}_{=1}^2$ T-formula. We can compute, in time bounded by an exponential function of $\|\varphi\|$, a set Φ of basic formulas, such that: (i) the signature of Φ consists of the unary predicates occurring in φ together with the distinguished predicate T ; (ii) $\models \varphi \rightarrow \bigwedge \Phi$; and (iii) any model of Φ can be expanded to a model of φ .*

Proof. Let φ be given, having the shape

$$\bigwedge_{h \in R} \exists \lambda_h \wedge \bigwedge_{i \in S} \forall(\mu_i \rightarrow \exists(o_i \wedge \kappa_i \wedge \Gamma_i)) \wedge \bigwedge_{j \in T} \forall(\nu_j \rightarrow \forall \Delta_j) \wedge \forall \forall \Omega \wedge \bigwedge_{i, i' \in S}^{i \neq i'} \forall(o_i \rightarrow \neg o_{i'}),$$

and recall from Sec. 2.3 that, for any fluted clause set Γ , Γ° denotes the result of saturating under mo-resolution, and then removing any clauses involving ordinary predicates of maximal arity (in this case 2). Noting that each o_i is a (1-literal) clause, and regarding each control formula κ_i as a pair of (1-literal) clauses, let ψ be the corresponding conjunction

$$\bigwedge_{h \in R} \exists \lambda_h \quad (14)$$

$$\bigwedge_{i \in S} \bigwedge_{J \subseteq T} \forall \left((\mu_i \wedge \bigwedge_{j \in J} \nu_j) \rightarrow \exists (\kappa_i \cup \{o_i\} \cup \Gamma_i \cup \bigcup_{j \in J} \Delta_j \cup \Omega)^\circ \right) \quad (15)$$

$$\bigwedge_{J \subseteq T} \forall \left(\bigwedge_{j \in J} q_j \rightarrow \forall \left(\bigcup_{j \in J} \Delta_j \cup \Omega \right)^\circ \right) \quad (16)$$

$$\bigwedge_{\substack{i \neq i' \\ i, i' \in S}} \forall \neg (o_i \wedge o_{i'}). \quad (17)$$

It is immediate by the validity of mo-resolution that $\models \varphi \rightarrow \psi$. We claim that any model of ψ may be expanded to a model of φ . For suppose $\mathfrak{B} \models \psi$; we expand to a structure \mathfrak{B}^+ interpreting a signature Σ^+ which additionally features the non-distinguished binary predicates occurring in φ as follows. Fix any $a \in B$, and let $J = \{j \in J \mid \mathfrak{B} \models \nu_j[a]\}$. For each $i \in S$, if $\mathfrak{B} \models \mu_i[a]$, by (15), there exists $b_i \in B$ such that $\mathfrak{B} \models (\kappa_i \cup \{o_i\} \cup \Gamma_i \cup \bigcup_{j \in J} \Delta_j \cup \Omega)^\circ[a, b_i]$, and by (17), these b_i are all distinct. For each $i \in S$, let $\tau_i = \text{ftp}^{\mathfrak{B}}[a, b_i]$. Obviously, $\models \tau_i \rightarrow \kappa_i$. By Lemma 3, there exists a fluted type τ_i^+ in the signature Σ^+ , such that $\tau_i^+ \supseteq \tau_i$ and $\tau_i^+ \models \{o_i\} \cup \Gamma_i \cup \bigcup_{j \in J} \Delta_j \cup \Omega$. Therefore, we may assign the pair a, b_i to the extensions of the predicates in $\Sigma^+ \setminus \Sigma$ in such a way that its fluted 2-type is τ_i^+ . Since the various b_i are distinct, no clashes arise. Performing this operation for every element a , we have a partially defined structure \mathfrak{B}^+ such that, however it is completed, $\mathfrak{B}^+ \models \bigwedge_{i \in S} \forall (\mu_i \rightarrow \exists (\kappa_i \wedge \Gamma_i))$, and, moreover, the conjuncts $\forall (\nu_j \rightarrow \forall \Delta_j)$ (for $j \in T$) and $\forall \forall \Omega$ have not been violated. To complete the definition of \mathfrak{B}^+ , consider any ordered pair a, b for which the predicates in $\Sigma^+ \setminus \Sigma$ have not been assigned. Let $J = \{j \in J \mid \mathfrak{B} \models \nu_j[a]\}$, so that, by (16), $\mathfrak{B} \models \left(\bigcup_{j \in J} \Delta_j \cup \Omega \right)^\circ$. Letting $\tau = \text{ftp}^{\mathfrak{B}}[a, b]$, by Lemma 3 there exists a fluted type τ^+ in the signature Σ^+ , such that $\tau^+ \supseteq \tau$ and $\tau^+ \models \bigcup_{j \in J} \Delta_j \cup \Omega$. Therefore, we may assign the pair a, b to the extensions of the predicates in $\Sigma^+ \setminus \Sigma$ in such a way that its fluted 2-type is τ^+ . At the end of this process, we have $\mathfrak{B}^+ \models \bigwedge_{j \in T} \forall (\nu_j \rightarrow \forall \Delta_j) \wedge \forall \forall \Omega$. Since \mathfrak{B}^+ is an expansion of \mathfrak{B} , we certainly have $\mathfrak{B}^+ \models \bigwedge_{h \in R} \exists \lambda_h$, and also $\mathfrak{B}^+ \models \bigwedge_{i, i' \in S}^{i \neq i'} \forall \neg (o_i \wedge o_{i'})$ by (14) and (17).

The desired set of basic formulas Φ can now be obtained from ψ by simple manipulation. The conjuncts in (14) and (17) are already basic. The conjuncts in (15) are all of the forms $\forall (\eta \rightarrow \exists (\neq \wedge \pm T \wedge \theta))$ or $\forall (\eta \rightarrow \exists (= \wedge \pm T \wedge \theta))$. Clearly, we may eliminate occurrences of T and $=$ from θ , so assume that this has been done, and θ is a quantifier-free formula of arity 1. In the former case,

we replace the conjunct with a collection of conjuncts $\forall(\pi \rightarrow \exists(\neq \wedge \theta \wedge \pm T))$, where π ranges over all fluted 1-types consistent with η ; such conjuncts are basic, of the forms (B1) or (B2). In the latter case, remembering that \hat{T} is a unary predicate interpreted as the diagonal of T , we see that all such formulas are either trivial or logically equivalent to a formula of the form (B7) ruling out a certain collection of fluted 1-types, and which can be computed in time bounded by an exponential function of $\|\varphi\|$. The conjuncts in (16) are all of the forms $\forall(\eta \rightarrow \forall\theta)$. Conversion to a conjunction of basic formulas of the forms (B3)–(B7) in time bounded by an exponential function of $\|\varphi\|$ is then completely routine, using similar considerations. \square

Thus, we have the promised upper bound for the problem $Sat\mathcal{FL}_{=}^21T$.

Lemma 18. *The satisfiability problem for $\mathcal{FL}_{=}^21T$ is in 2-NEXPTIME.*

Proof. Let an $\mathcal{FL}_{=}^21T$ -sentence φ be given. By Lemma 4, we may assume without loss of generality that φ is in normal form. Guess a set Π of fluted 1-types over the signature of φ and apply the procedure guaranteed by Lemma 16 to obtain, in time bounded by an exponential function of $\|\varphi\|$, a spread normal-form formula ψ , over a signature bounded by a polynomial function of $\|\varphi\|$, such that $\models \psi \rightarrow \varphi$, and, if φ has a (finite) model in which the set of royal fluted 1-types is Π , then ψ has a such a model too. By Lemma 17 we may then obtain, in time bounded by an exponential function of $\|\psi\|$, a set Φ_Π of basic $\mathcal{FL}_{=}^21T^u$ sentences, over the signature consisting of the unary predicates of ψ together with the distinguished predicate T , such that Φ_Π is satisfiable over the same domains as φ , assuming that the set of royal 1-types is Π . Hence it suffices to check the satisfiability of each such Φ_Π , non-deterministically, in time bounded by a doubly exponential function of $\|\varphi\|$. But this we can do by Lemma 14. \square

3.3. The logic $\mathcal{FL}_{=}^m1T$

Finally, we show how the satisfiability problem for $\mathcal{FL}_{=}^{m+1}1T$ can be reduced to the corresponding problem for $\mathcal{FL}_{=}^m1T$, but with exponential blow-up. The following notion will be useful. Let I be a finite set. A *cover* of I is a set $M = \{C_1, \dots, C_\ell\}$ of subsets of I such that $C_1 \cup \dots \cup C_\ell = I$; the elements of M will be referred to as *cells*. A *minimal cover* of I is a cover M of I such that no proper subset of M is a cover of I . Since no minimal cover of I can have more than I cells, we have $|MC(I)| \leq 2^{|I|^2}$. Denote by $MC(I)$ the set of minimal covers of I . If I is a set of integers, and M is a minimal cover of I , we may assume the cells of M to be enumerated in some standard way as C_1, \dots, C_ℓ .

Lemma 19. *Let φ be a normal-form $\mathcal{FL}_{=}^{m+1}1T$ -formula ($m \geq 2$). We can compute, in time bounded by an exponential function of $\|\varphi\|$, a normal-form $\mathcal{FL}_{=}^m1T$ -formula ψ such that φ and ψ are satisfiable over the same domains.*

Proof. Let φ be as given in (5). The control formulas κ_i occurring there involve only binary predicates, and thus will be—so far as this proof is concerned— inert. Indeed, since each κ_i is a conjunction of two (1-literal) clauses, we can

harmlessly absorb it into the respective clause set Γ_i . Thus, we may take φ to have the shape:

$$\bigwedge_{i \in S} \forall^m (\mu_i \rightarrow \exists \Gamma_i) \wedge \bigwedge_{j \in T} \forall^m (\nu_j \rightarrow \forall \Delta_j) \wedge \forall^{m+1} \Omega.$$

We may also assume without loss of generality that the indices in the sets S and T are integers. For each I ($I \subseteq S$) and each J ($J \subseteq T$), let $p_{I,J}$ and q_J be fresh $(m-1)$ -ary predicates. Further, for each minimal cover $M = \{C_1, \dots, C_\ell\}$ of I (enumerated in the standard way), let $p_{I,J,M}$ be a fresh $(m-1)$ -ary predicate, and for each h ($1 \leq h \leq \ell$), let $p_{I,J,M,h}$ be a fresh m -ary predicate.

Remembering that the Γ_i , Δ_j , and Ω occurring in φ are sets of fluted $(m+1)$ -clauses, let ψ be the conjunction of formulas

$$\bigwedge_{I \subseteq S} \bigwedge_{J \subseteq T} \forall^m \left(\bigwedge_{i \in I} \mu_i \wedge \bigwedge_{j \in J} \nu_j \rightarrow p_{I,J} \right) \quad (18)$$

$$\bigwedge_{J \subseteq T} \forall^m \left(\bigwedge_{j \in J} \nu_j \rightarrow q_J \right) \quad (19)$$

$$\bigwedge_{I \subseteq S} \bigwedge_{J \subseteq T} \forall^m \left(p_{I,J} \rightarrow \bigvee_{M \in MC(I)} p_{I,J,M} \right) \quad (20)$$

$$\bigwedge_{I \subseteq S} \bigwedge_{J \subseteq T} \bigwedge_{M \in MC(I)} \forall^{m-1} \left(p_{I,J,M} \rightarrow \bigwedge_{h=1}^{|M|} \exists (p_{I,J,M,h} \wedge \left(\bigcup_{i \in C_h} \Gamma_i \cup \bigcup_{j \in J} \Delta_j \cup \Omega \right)^\circ) \right) \quad (21)$$

$$\bigwedge_{I \subseteq S} \bigwedge_{J \subseteq T} \forall^{m-1} \left(q_J \rightarrow \bigwedge_{h=1}^{|M|} \forall \left(\bigcup_{j \in J} \Delta_j \cup \Omega \right)^\circ \right) \quad (22)$$

$$\bigwedge_{I \subseteq S} \bigwedge_{J \subseteq T} \bigwedge_{M \in MC(I)} \bigwedge_{1 \leq h < h' \leq |M|} \forall^m \neg (p_{I,J,M,h} \wedge p_{I,J,M,h'}). \quad (23)$$

Modulo re-arrangement of conjuncts, ψ is a normal-form formula of $\mathcal{FL}^m 1T$. It suffices therefore to show that φ and ψ are satisfiable over the same domains.

Suppose $\mathfrak{A} \models \varphi$. We expand to a model $\mathfrak{A}^+ \models \psi$ as follows. For any $(m-1)$ -tuple \bar{a} and any $I \subseteq S$ and $J \subseteq T$, if there exists $a \in A$ such that $\mathfrak{A} \models \mu_i[a, \bar{a}]$ for all $i \in I$ and $\mathfrak{A} \models \nu_j[a, \bar{a}]$ for all $j \in J$, assign \bar{a} to the extension of $p_{I,J}$, and pick some particular a for which this condition is satisfied. Since $\mathfrak{A} \models \varphi$, there exists a collection of distinct individuals b_1, \dots, b_ℓ and a minimal cover $M = \{C_1, \dots, C_\ell\}$ of I such that, for all h ($1 \leq h \leq \ell$), $\mathfrak{A} \models \left(\bigcup_{i \in C_h} \Gamma_i \cup \bigcup_{j \in J} \Delta_j \cup \Omega \right) [a, \bar{a}, b_h]$. Now assign \bar{a} to the extension of $p_{I,J,M}$, and for all h ($1 \leq h \leq \ell$), assign \bar{a}, b_h to the extension of $\mathfrak{A}^+ \models p_{I,J,M,h}$. It follows by the validity of the resolution rule, that, for all h ($1 \leq h \leq \ell$), $\mathfrak{A} \models \left(\bigcup_{i \in C_h} \Gamma_i \cup \bigcup_{j \in J} \Delta_j \cup \Omega \right)^\circ [\bar{a}, b_h]$, and, by construction, $\mathfrak{A}^+ \models p_{I,J,M,h}[\bar{a}, b_h]$. Carrying out this process for all possible $(m-1)$ -tuples \bar{a} , we see that \mathfrak{A}^+ verifies the formulas (18), (20) and (21). Moreover, since the individuals b_1, \dots, b_ℓ are by hypothesis distinct, no tuple \bar{a}, b_h satisfies both $p_{I,J,M,h}$ and $p_{I,J,M,h'}$ for $h' \neq h$,

so that \mathfrak{A}^+ verifies the formulas (23). Similarly, for any $(m-1)$ -tuple \bar{a} and any $J \subseteq T$, if there exists $a \in A$ such that $\mathfrak{A} \models \nu_j[a, \bar{a}]$ for all $j \in J$, assign \bar{a} to the extension of q_J , and pick some particular a for which this condition is satisfied. Since $\mathfrak{A} \models \varphi$, for any individual $b \in A$, we have $\mathfrak{A} \models \left(\bigcup_{j \in J} \Delta_J \cup \Omega \right) [a, \bar{a}, b]$, whence, by the validity of the resolution rule, $\mathfrak{A} \models \left(\bigcup_{j \in J} \Delta_J \cup \Omega \right)^\circ [\bar{a}, b]$. Thus, \mathfrak{A}^+ verifies the formulas (19) and (22), whence $\mathfrak{A}^+ \models \psi$, as required.

Suppose, conversely, that $\mathfrak{B} \models \psi$. We expand to a structure \mathfrak{B}^+ interpreting the $(m+1)$ -ary predicates of φ in such a way that $\mathfrak{B}^+ \models \varphi$. Fix for the moment some element a and $(m-1)$ -tuple of elements \bar{a} , and define $I = \{i \in S \mid \mathfrak{B} \models \mu_i[a, \bar{a}]\}$ and $J = \{j \in T \mid \mathfrak{B} \models \nu_j[a, \bar{a}]\}$. It follows from (18) that $\mathfrak{B} \models p_{I,J}[\bar{a}]$. Indeed, from (20), there exists a minimal cover $M = \{C_1, \dots, C_\ell\}$ of I such that $\mathfrak{B} \models p_{I,J,M}[\bar{a}]$, whence from (21), we can find elements b_1, \dots, b_ℓ such that, for all h ($1 \leq h \leq \ell$), $\mathfrak{B} \models \left(\bigcup_{i \in C_h} \Gamma_i \cup \bigcup_{j \in J} \Delta_J \cup \Omega \right)^\circ [\bar{a}, b_h]$, and $\mathfrak{B} \models p_{I,J,M,h}[\bar{a}, b_h]$. Letting $\tau_h = \text{ftp}^{\mathfrak{B}}[\bar{a}, b_h]$, it follows from Lemma 3 that there exists a fluted $(m+1)$ -type $\tau_h^+ \supseteq \tau_h$ such that $\models \tau_h^+ \rightarrow \left(\bigcup_{i \in C_h} \Gamma_i \cup \bigcup_{j \in J} \Delta_J \cup \Omega \right)$. From (23), the b_h are all distinct, so we may interpret the $(m+1)$ -ary predicates of φ in \mathfrak{B}^+ so that $\text{ftp}^{\mathfrak{B}^+}[a, \bar{a}, b_h] = \tau_h^+$. Carrying out this process for all m -tuples (a, \bar{a}) , we thus ensure that $\mathfrak{B}^+ \models \bigwedge_{i \in S} \forall^m(\mu_i \rightarrow \exists \Gamma_i)$. Note that we have not assigned any $(m+1)$ -tuples in such a way as to violate the constraints $\bigwedge_{j \in T} \forall^m(\nu_j \rightarrow \forall \Delta_j)$ or $\forall^{m+1}\Omega$. To complete the definition of \mathfrak{B}^+ , let a, \bar{a}, b be an $(m+1)$ -tuple for which the extensions of the $(m+1)$ -ary predicates have not been fixed. Again, let $J = \{j \in T \mid \mathfrak{B} \models \nu_j[a, \bar{a}]\}$. It follows from (19) that $\mathfrak{B} \models q_J[\bar{a}]$, and thence from (22) that $\mathfrak{B} \models \left(\bigcup_{j \in J} \Delta_J \cup \Omega \right)^\circ [\bar{a}, b]$. Now let $\tau = \text{ftp}^{\mathfrak{B}}[\bar{a}, b]$, so that, from Lemma 3, there exists a fluted $(m+1)$ -type $\tau^+ \supseteq \tau$ such that $\models \tau^+ \rightarrow \left(\bigcup_{j \in J} \Delta_J \cup \Omega \right)$. Hence we may interpret the $(m+1)$ -ary predicates of φ in \mathfrak{B}^+ so that $\text{ftp}^{\mathfrak{B}^+}[a, \bar{a}, b] = \tau^+$. At the end of this process, $\mathfrak{B}^+ \models \bigwedge_{j \in T} \forall^m(\nu_j \rightarrow \forall \Delta_j) \wedge \forall^{m+1}\Omega$. Thus, $\mathfrak{B}^+ \models \varphi$. \square

We have finally reached the goal of this section.

Theorem 20. *The satisfiability problem for $\mathcal{FL}_{=}^m 1T$ is in m -NEXPTIME.*

Proof. Let an $\mathcal{FL}_{=}^m 1T$ -sentence φ be given. By Lemma 4, we may assume without loss of generality that φ is in normal form. We proceed by induction, starting with $m = 2$. (The cases $m = 0$ and $m = 1$ are trivial.) The base case is Lemma 18. For the recursive case, Lemma 19 reduces the original problem to the corresponding problem for $m - 1$, but with an exponential blow-up. \square

Before moving to the next section we obtain a corollary concerning the finite satisfiability problem.

Corollary 21. *The finite satisfiability problem for $\mathcal{FL}_{=}^m 1T$ is in $(m+1)$ -NEXPTIME.*

Proof. The proof differs from the proof of Theorem 20 only in the base case, where we apply the fact that the finite satisfiability problem for FO^2 with one transitive relation and equality is decidable in 3-NEXPTIME [16]; this complexity bound obviously applies to $\mathcal{FL}=1\text{T}$. \square

4. Fluted Logic with more Transitive Relations

In the previous section, we considered \mathcal{FL}^2 extended with a single transitive relation and equality. In this section we consider \mathcal{FL}^2 extended with more transitive relations. Specifically, we show that the satisfiability and finite satisfiability problems for $\mathcal{FL}^2_2\text{T}$ (two-variable fluted logic with two transitive relations and equality) or for $\mathcal{FL}^2_3\text{T}$ (two-variable fluted logic with three transitive relations but without equality), are all undecidable.

A *tiling system* is a tuple $\mathbf{C} = (\mathcal{C}, H, V)$, where \mathcal{C} is a finite set of *tiles*, and $H, V \subseteq \mathcal{C} \times \mathcal{C}$ are the *horizontal* and *vertical* constraints. A *tiling* of \mathbb{N}^2 for \mathbf{C} is a function $f : \mathbb{N}^2 \rightarrow \mathcal{C}$, such that for all $X, Y \in \mathbb{N}$, $(f(X, Y), f(X + 1, Y)) \in H$ and $(f(X, Y), f(X, Y + 1)) \in V$. Intuitively, we think of f as assigning (a copy of) some tile in \mathcal{C} to each point with integer coordinates in the upper-right quadrant of the plane: this assignment must respect the horizontal and vertical constraints, understood as a list of which tiles may be placed immediately to the right of (respectively: immediately above) which others. A tiling is *periodic* if there exist m, n such that, for all X and Y , $f(X + m, Y) = f(X, Y + n) = f(X, Y)$. Denote by $\mathbb{N}_{m,n}^2$ the finite initial segment $[0, m - 1] \times [0, n - 1]$ of \mathbb{N}^2 . A *tiling* of $\mathbb{N}_{m,n}^2$ is a function $f : \mathbb{N}_{m,n}^2 \rightarrow \mathcal{C}$, such that for all X, Y ($0 \leq X < m - 1$, $0 \leq Y \leq n - 1$), $(f(X, Y), f(X + 1, Y)) \in H$ and for all X, Y ($0 \leq X \leq m - 1$, $0 \leq Y < n - 1$), $(f(X, Y), f(X, Y + 1)) \in V$. If f is a tiling (of either $\mathbb{N}_{m,n}^2$ or \mathbb{N}^2), we call the value $f(0, 0)$ the *initial condition*, and, if f is a tiling of $\mathbb{N}_{m,n}^2$, we call the value $f(m - 1, n - 1)$ the *final condition*.

There are many undecidability results concerning tiling systems. The *infinite tiling problem with initial condition* is the following: given a tiling system \mathbf{C} and a tile $C_0 \in \mathcal{C}$, does there exist a tiling of \mathbb{N}^2 for \mathbf{C} with initial condition C_0 ? The *finite tiling problem with initial and final conditions* is the following: given a tiling system \mathbf{C} and tiles $C_0, C_1 \in \mathcal{C}$, do there exist positive m, n and a tiling of $\mathbb{N}_{m,n}^2$ for \mathbf{C} with initial condition C_0 and final condition C_1 ? It is straightforward to show:

Proposition 22. *The infinite tiling problem with initial condition and the finite tiling problem with initial and final conditions are both undecidable.*

The following result, by contrast, is deep (see e.g. [2, p. 90]). Recall that sets A and B are *recursively inseparable* if there exists no recursive (=decidable) set S such that $A \subseteq S$ and $B \cap S = \emptyset$.

Proposition 23. *The set of tiling systems for which there exists a periodic tiling of \mathbb{N}^2 is recursively inseparable from the set of tiling systems for which there exists no tiling of \mathbb{N}^2 .*

4.1. The case of two transitive relations

In this section we show that both the satisfiability and the finite satisfiability problems for $\mathcal{FL}^2_{=}2T$ are undecidable. (Recall from Example 2 that \mathcal{FL}^22T admits infinity axioms.)

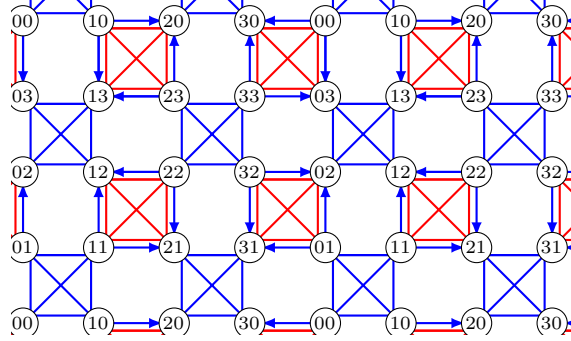

Figure 4: Intended expansion of the $\mathbb{N} \times \mathbb{N}$ grid with two transitive relations T_1 and T_2 . Edges without arrows represent connections in both direction. Nodes are marked by the indices of the $c_{i,j}$ s they satisfy.

Suppose the signature contains two transitive relations T_1 and T_2 , and additional unary predicates $c_{i,j}$ ($0 \leq i, j \leq 3$) called *local address predicates*. We write a formula φ_{grid} capturing several properties of the intended expansion of the \mathbb{N}^2 grid as shown in Fig. 4. There, each element with coordinates (X, Y) satisfies $c_{i,j}$, where $i = X \bmod 4$ and $j = Y \bmod 4$, and the transitive relations connect only some elements that are close in the grid. The formula φ_{grid} is a conjunction of the following statements (24)-(32).

There is an initial element:

$$\exists c_{0,0}. \quad (24)$$

The predicates $c_{i,j}$ enforce a partition of the universe:

$$\forall (\bigvee_{0 \leq i \leq 3} \bigvee_{0 \leq j \leq 3} c_{i,j}). \quad (25)$$

Transitive paths do not connect distinct elements with the same local address:

$$\bigwedge_{0 \leq i, j \leq 3} \forall (c_{i,j} \rightarrow \forall ((T_1 \vee T_2) \wedge c_{i,j} \rightarrow =)). \quad (26)$$

Each element belongs to a 4-element T_1 -clique:

$$\bigwedge_{i,j \in \{0,2\}} \forall ((c_{i,j} \rightarrow \exists (T_1 \wedge c_{i+1,j})) \wedge (c_{i+1,j} \rightarrow \exists (T_1 \wedge c_{i+1,j+1})) \wedge (c_{i+1,j+1} \rightarrow \exists (T_1 \wedge c_{i,j+1})) \wedge (c_{i,j+1} \rightarrow \exists (T_1 \wedge c_{i,j}))). \quad (27)$$

Each element belongs to a 4-element T_2 -clique:

$$\bigwedge_{i,j \in \{1,3\}} \forall ((c_{i,j} \rightarrow \exists(T_2 \wedge c_{i+1,j})) \wedge (c_{i+1,j} \rightarrow \exists(T_2 \wedge c_{i+1,j+1})) \wedge (c_{i+1,j+1} \rightarrow \exists(T_2 \wedge c_{i,j+1})) \wedge (c_{i,j+1} \rightarrow \exists(T_2 \wedge c_{ij}))). \quad (28)$$

Certain pairs of elements connected by one transitive relation are also connected by the other one, specifically:

$$\bigwedge_{i=0,2} \forall(c_{i,i} \rightarrow \forall((T_1 \vee T_2) \wedge (c_{i,i-1} \vee c_{i-1,i}) \rightarrow (T_1 \wedge T_2))) \quad (29)$$

$$\bigwedge_{i=1,3} \forall(c_{i,i} \rightarrow \forall((T_1 \vee T_2) \wedge (c_{i,i+1} \vee c_{i+1,i}) \rightarrow (T_1 \wedge T_2))) \quad (30)$$

$$\bigwedge_{i=0,2} \forall(c_{i,i+1} \rightarrow \forall((T_1 \vee T_2) \wedge (c_{i,i+2} \vee c_{i-1,i+1}) \rightarrow (T_1 \wedge T_2))) \quad (31)$$

$$\bigwedge_{i=1,3} \forall(c_{i,i-1} \rightarrow \forall((T_1 \vee T_2) \wedge (c_{i,i} \vee c_{i,i-2}) \rightarrow (T_1 \wedge T_2))). \quad (32)$$

A model of φ_{grid} is shown in Fig. 4. Observe that the formulas (27) and (28) work in tandem with (26). Namely, both (27) and (28) generate, for a given element a of some local address $c_{i,j}$ in any model of φ_{grid} four new elements of certain local addresses such that the fourth element, say a' , has the same local address as the element a . Formula (26) then implies $a = a'$, hence the element a is a member of a 4-element T_1 -clique and a member of a (distinct) 4-element T_2 -clique; members of these cliques can be uniquely identified by their local addresses (cf. Fig. 4). One can also obtain finite models over a toroidal grid structure $\mathbb{Z}_{4m} \times \mathbb{Z}_{4m}$ ($m > 0$) by identifying elements from columns 0 and $4m$ and from rows 0 and $4m$.

We show that any model of φ_{grid} embeds the standard grid \mathbb{N}^2 in a natural way. To see this, for all i, j in the range $0 \leq i, j < 4$, define the formulas $h_{i,j}$ and $v_{i,j}$ as follows:

$$h_{i,j} := \begin{cases} T_1 \wedge c_{i+1,j} & \text{if } i \text{ is even} \\ T_2 \wedge c_{i+1,j} & \text{otherwise} \end{cases} \quad v_{i,j} := \begin{cases} T_1 \wedge c_{i,j+1} & \text{if } j \text{ is even} \\ T_2 \wedge c_{i,j+1} & \text{otherwise.} \end{cases}$$

The intuition is that, for any element a satisfying $c_{i,j}$, $h_{i,j}$ will be satisfied by the pair $[a, b]$ just in case b is immediately to the right of a , and $v_{i,j}$ will be satisfied by the pair $[a, b]$ just in case b is immediately above a . (See Fig. 4.)

Lemma 24. *In any model \mathfrak{A} , of φ_{grid} , the following hold for any i, j in the range $0 \leq i, j < 4$:*

$$\mathfrak{A} \models c_{i,j}[a] \Rightarrow \text{there exists } b \text{ s.t. } \mathfrak{A} \models h_{i,j}[a, b] \text{ and } a' \text{ s.t. } \mathfrak{A} \models v_{i,j}[a, a'] \quad (33)$$

$$\mathfrak{A} \models c_{i,j}[a] \wedge h_{i,j}[a, b] \wedge v_{i,j}[a, a'] \wedge v_{i+1,j}[b, b'] \Rightarrow \mathfrak{A} \models h_{i,j+1}[a', b']. \quad (34)$$

Proof. Let $a \in A$ and $\mathfrak{A} \models c_{i,j}[a]$. The existence of b in (33) is immediate from (27) for i, j even, and from (28) for i, j odd. Suppose i is even and j is odd. By the last conjunct of (27), there is $a_1 \in A$ such that $T_1[a, a_1] \wedge c_{i,j-1}[a_1]$. By (27) again, there are $a_2, a_3, a_4 \in A$ such that $\mathfrak{A} \models T_1[a_1, a_2] \wedge c_{i+1,j-1}[a_2] \wedge T_1[a_2, a_3] \wedge c_{i+1,j}[a_3] \wedge T_1[a_3, a_4] \wedge c_{i,j}[a_4]$. By transitivity of T_1 , $\mathfrak{A} \models T_1[a, a_4]$ and by (26), $a = a_4$, so the elements a, a_1, a_2, a_3 form a T_1 -clique in \mathfrak{A} , hence $T_1[a, a_3]$ holds and, indeed, $\mathfrak{A} \models h_{i,j}[a, a_3]$. In the same way we show the existence of b when i is odd and j even, and, also, the existence of a' . We should regard the witnesses for the formulas $\exists h_{i,j}$ and $\exists v_{i,j}$ with respect to any element a are the horizontal and vertical neighbours, respectively, of a .

We now establish (34) proceeding separately for the possible indices i and j . Consider first the case $i = j = 0$, and suppose a, a', b and b' are elements of \mathfrak{A} such that $\mathfrak{A} \models c_{0,0}[a] \wedge T_1[a, b] \wedge c_{1,0}[b] \wedge T_1[a, a'] \wedge c_{0,1}[a'] \wedge T_1[b, b'] \wedge c_{1,1}[b']$. By (27) b' is a member of a T_1 -clique consisting of elements of local addresses $c_{1,1}, c_{0,1}, c_{0,0}, c_{1,0}$. Since by (26) the relation T_1 does not connect distinct elements of the same local address, a' belongs to the T_1 -clique of b' , so $\mathfrak{A} \models T_1[a', b']$, and the claim follows.

Consider now the case $i = 3, j = 0$, and suppose a, a', b and b' are elements such that $\mathfrak{A} \models c_{3,0}[a] \wedge T_1[a, a'] \wedge c_{3,1}[a'] \wedge T_2[a, b] \wedge c_{0,0}[b] \wedge T_1[b, b'] \wedge c_{0,1}[b']$. Applying (28) together with (26) to b , we see that b is a member of a 4-element T_2 -clique consisting of elements of local addresses $c_{0,0}, c_{3,0}, c_{3,3}, c_{0,3}$. By (26), a is a member of this clique, whence $\mathfrak{A} \models T_2[b, a]$. By (29), $\mathfrak{A} \models T_1[b, a]$. Moreover, b' is in a T_1 -clique of b , and so $\mathfrak{A} \models T_1[b', b]$. By transitivity of T_1 , $\mathfrak{A} \models T_1[b', a']$. Now, by (31), $\mathfrak{A} \models T_2[b', a']$. By (28), a' is a member of a T_2 -clique that, by (26), must contain b' . Hence $h_{3,0}[a', b']$ holds and the claim follows.

The remaining cases are dealt with similarly. \square

Lemma 24 shows that any model \mathfrak{A} of φ_{grid} contains, in effect, a homomorphic embedding of the infinite grid \mathbb{N}^2 . Specifically, we define a function $\iota : \mathbb{N}^2 \rightarrow A$ as follows. Set $\iota(0, 0)$ to be some witness for (1). By (33), we may choose $\iota(1, 0), \iota(2, 0), \dots$ such that, for all $X \geq 0$, setting $i = X \bmod 4$, we have $\mathfrak{A} \models h_{i,0}[\iota(X, 0), \iota(X + 1, 0)]$; and then, for every $X \geq 0$, we may choose $\iota(X, 1), \iota(X, 2), \dots$ such that for every $Y \geq 0$, setting $j = Y \bmod 4$, we have $\mathfrak{A} \models v_{i,j}[\iota(X, Y), \iota(X, Y + 1)]$. A simple induction on Y using (34) then shows that, for all X and Y , $\mathfrak{A} \models h_{i,j}[\iota(X, Y), \iota(X + 1, Y)]$.

We can now map any tiling system \mathcal{C} to an $\mathcal{FL}^2_{=2T}$ -formula $\eta_{\mathcal{C}}$ in such a way that \mathcal{C} has a tiling if and only if $\eta_{\mathcal{C}}$ is satisfiable. We simply let $\eta_{\mathcal{C}}$ be the conjunction of φ_{grid} with the following formulas.

Each node encodes precisely one tile:

$$\forall \left(\bigvee_{C \in \mathcal{C}} C \wedge \bigwedge_{C \neq D} (\neg C \vee \neg D) \right). \quad (35)$$

Adjacent tiles respect H and V :

$$\bigwedge_{C \in \mathcal{C}} \bigwedge_{0 \leq i, j < 4} \forall \left(C \wedge c_{i,j} \rightarrow \forall \left((h_{i,j} \rightarrow \bigvee_{C':(C,C') \in H} C') \wedge (v_{i,j} \rightarrow \bigvee_{C':(C,C') \in V} C') \right) \right). \quad (36)$$

If f is a tiling of \mathbb{N}^2 for \mathcal{C} , we expand the standard grid model of φ_{grid} by taking any predicate $C \in \mathcal{C}$ to be satisfied by $(X, Y) \in \mathbb{N}^2$ just in case $f(X, Y) = C$. It is a simple matter to check that $\eta_{\mathcal{C}}$ is true in the resulting structure. Conversely, if $\mathfrak{A} \models \eta_{\mathcal{C}}$, then $\mathfrak{A} \models \varphi_{grid}$, and so there exists a grid embedding $\iota : \mathbb{N}^2 \rightarrow A$. We then define a function $f : \mathbb{N}^2 \rightarrow \mathcal{C}$ by setting $f(X, Y)$ to be the unique tile $C \in \mathcal{C}$ such that $\mathfrak{A} \models C[\iota(X, Y)]$, which is well-defined by (35). By (36), f is a tiling for \mathcal{C} .

Indeed, the same argument shows that, $\eta_{\mathcal{C}}$ has a *finite* model if and only if there is a *periodic* tiling of \mathbb{N}^2 for \mathcal{C} . Since, as remarked above, the set of tiling systems for which there exists no tiling of the plane is recursively inseparable from the set of tiling systems for which there exists a periodic tiling of the plane, we obtain:

Theorem 25. *The satisfiability problem and the finite satisfiability problems for $\mathcal{FL}_{=2}^2T$ are both undecidable.*

A quick check reveals that the formula $\eta_{\mathcal{C}}$ lies in the guarded fragment of first-order logic. Moreover, the proof of Lemma 24 remains valid even if T_2 is required to be an equivalence relation. Thus we have:

Corollary 26. *The satisfiability problem and the finite satisfiability problems for the intersection of $\mathcal{FL}_{=2}^2T$ with the guarded fragment are both undecidable. This result continues to hold if, in place of $\mathcal{FL}_{=2}^2T$, we have $\mathcal{FL}_{=1}^2T1E$, the two-variable fluted fragment together with identity, one transitive relation and one equivalence relation.*

We conclude the section by remarking that decidability of the satisfiability and the finite satisfiability problems for $\mathcal{FL}^m 2T$ remains open for every $m \geq 2$. We showed in Example 2 that these two problems are distinct.

4.2. The case of three transitive relations

In this section we show that the satisfiability problem and the finite satisfiability problem for $\mathcal{FL}^2 3T$ are both undecidable. (Note that equality is not available in this logic.) We start by reducing the infinite tiling problem to the satisfiability problem.

We write a formula φ_{grid} capturing several properties of the intended expansion of the \mathbb{N}^2 grid as shown in Fig. 5. The formula φ_{grid} comprises a large number of conjuncts. To help give an overview of the construction, we have organized these conjuncts into groups, each of which secures a particular property (or collection of properties) exhibited by its models. We use the following notational conventions. If i is an integer, $i/2$ indicates integer division without remainder (e.g., $5/2 = 2$); moreover, $[i]_k$ denotes the remainder of i on division by k , and $[i]$ (i.e., without the subscript) denotes $[i]_6$.

The signature of φ_{grid} comprises the unary predicates $c_{i,j}$ and $d_{i,j}$ ($0 \leq i, j \leq 5$) and bt , lf , dg and dg^+ , together with the distinguished binary predicates T_0 , T_1 and T_2 . We call the $c_{i,j}$ and $d_{i,j}$ *local address predicates*, and require that they partition the universe:

$$\forall \left(\bigvee_{0 \leq i, j \leq 5} c_{i,j} \dot{\vee} \bigvee_{0 \leq i, j \leq 5} d_{i,j} \right). \quad (37)$$

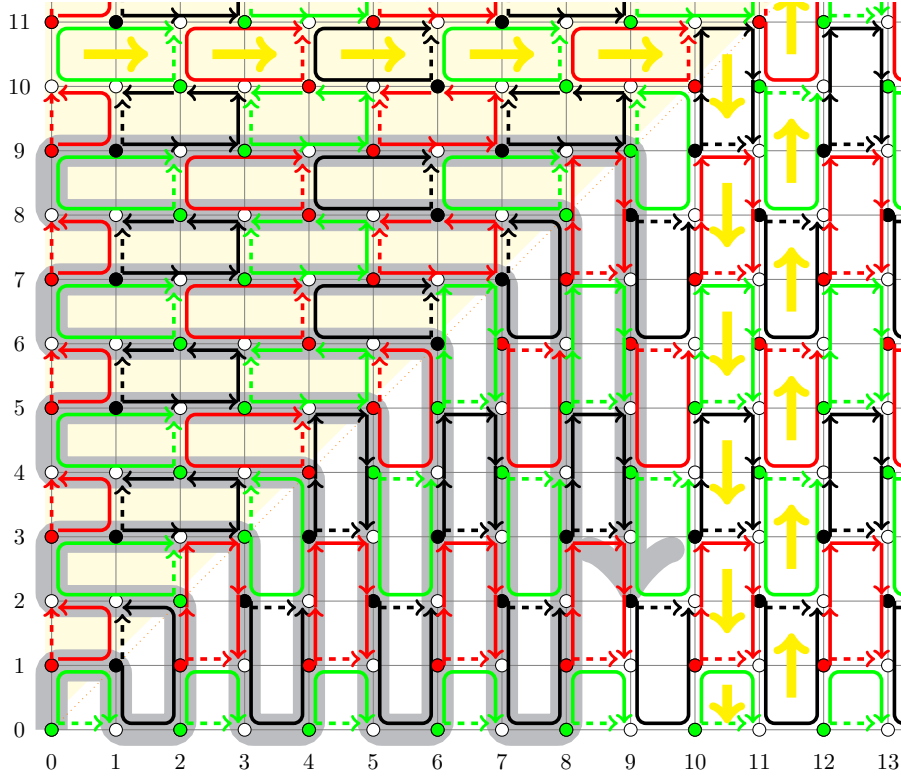

Figure 5: Intended expansion of the $\mathbb{N} \times \mathbb{N}$ grid and the boustrophedon order (thick gray path).

Informally, we think of an element in a structure interpreting these predicates as having integer coordinates (X, Y) in the plane such that if $Y > X$, then its local address is $c_{i,j}$, where $i = \lfloor X \rfloor$ and $j = \lfloor Y \rfloor$, and if $Y \leq X$, then its local address is $d_{i,j}$, with i and j determined in the same way. We call the unary predicates bt , lf , dg and dg^+ *control predicates*, and require them to interact with the local address predicates in certain ways:

$$\forall (bt \rightarrow \bigvee_{i=0}^5 d_{i,0}) \wedge \forall (lf \rightarrow \bigvee_{j=0}^5 c_{0,j}) \wedge \forall (dg \rightarrow \bigvee_{i=0}^5 d_{i,i}) \wedge \forall (dg^+ \rightarrow \bigvee_{j=0}^5 c_{j, \lfloor j+1 \rfloor}). \quad (38)$$

Informally, we think of an element with coordinates (X, Y) as satisfying bt if $Y = 0$ ('bottom'), lf if $X = 0$ and $Y > 0$ ('left, but not bottom'), dg if $Y = X$ ('diagonal'), and dg^+ if $Y = X + 1$ ('super-diagonal'). Finally, we call the binary predicates T_0 , T_1 and T_2 *colours*. To aid visualization, we use the respective synonyms black, green and red for these predicates.

We take φ_{grid} to contain conjuncts generating a sequence of elements $\{a_t\}_{t \geq 0}$ satisfying the $c_{i,j}$ and $d_{i,j}$ in a particular order. The intuition is that the elements of this sequence (each of which is assigned integer coordinates in the plane) follows the boustrophedon depicted in Fig. 5 (thick grey arrow). There is an 'initial' element corresponding to the left bottom node:

$$\exists(d_{0,0} \wedge \text{dg} \wedge \text{bt}). \quad (39)$$

This element has a T_1 -successor satisfying $c_{0,1}$, dg^+ and lf :

$$\forall(\text{bt} \wedge \text{dg} \rightarrow \exists(c_{0,1} \wedge \text{dg}^+ \wedge \text{lf} \wedge T_1)). \quad (40)$$

Other elements satisfying $d_{i,j}$ in the sequence have successors given by the following conjuncts:

$$\bigwedge_{i=0,2,4} \bigwedge_{j=0}^5 \forall(d_{i,j} \wedge \neg \text{dg} \rightarrow \exists(d_{i,\lfloor j+1 \rfloor} \wedge \neg \text{bt} \wedge T_{\lfloor j/2 \rfloor_3} \wedge T_{\lfloor (j+1)/2+1 \rfloor_3})) \quad (41)$$

$$\bigwedge_{i=1,3,5} \bigwedge_{j=0}^5 \forall(d_{i,j} \wedge \neg \text{bt} \rightarrow \exists(d_{i,\lfloor j-1 \rfloor} \wedge \neg \text{dg} \wedge T_{\lfloor j/2+1 \rfloor_3} \wedge T_{\lfloor (j+1)/2-1 \rfloor_3})) \quad (42)$$

$$\bigwedge_{i=1,3,5} \forall(d_{i,0} \wedge \text{bt} \wedge \neg \text{dg} \rightarrow \exists(d_{\lfloor i+1 \rfloor,0} \wedge \text{bt} \wedge \neg \text{dg} \wedge T_0)) \quad (43)$$

$$\bigwedge_{i=0,2,4} \forall(d_{i,i} \wedge \neg \text{bt} \wedge \text{dg} \rightarrow \exists(c_{\lfloor i-1 \rfloor, i} \wedge \text{dg}^+ \wedge \neg \text{lf} \wedge T_{\lfloor i/2-1 \rfloor_3} \wedge T_{\lfloor i/2 \rfloor_3})). \quad (44)$$

Likewise, each element satisfying $c_{i,j}$ in the sequence has a successor given by the following conjuncts:

$$\bigwedge_{j=0,2,4} \bigwedge_{i=0}^5 \forall(c_{i,j} \wedge \neg \text{lf} \rightarrow \exists(c_{\lfloor i-1 \rfloor, j} \wedge \neg \text{dg}^+ \wedge T_{\lfloor i/2-1 \rfloor_3} \wedge T_{\lfloor (i+1)/2 \rfloor_3})) \quad (45)$$

$$\bigwedge_{j=1,3,5} \bigwedge_{i=0}^5 \forall(c_{i,j} \wedge \neg \text{dg}^+ \rightarrow \exists(c_{\lfloor i+1 \rfloor, j} \wedge \neg \text{lf} \wedge T_{\lfloor i/2+1 \rfloor_3} \wedge T_{\lfloor (i+1)/2-1 \rfloor_3})) \quad (46)$$

$$\bigwedge_{j=0,2,4} \forall(c_{0,j} \wedge \text{lf} \rightarrow \exists(c_{0,j+1} \wedge \text{lf} \wedge \neg \text{dg}^+ \wedge T_1)) \quad (47)$$

$$\bigwedge_{j=1,3,5} \forall(c_{j-1,j} \wedge \text{dg}^+ \rightarrow \exists(d_{j,j} \wedge \text{dg} \wedge \neg \text{bt} \wedge T_{\lfloor (j+1)/2 \rfloor_3} \wedge T_{\lfloor (j+3)/2 \rfloor_3})). \quad (48)$$

Starting with a_0 witnessing the formula (39), we see that formulas (40)–(48) generate, potentially, further elements. Accordingly, we call these conjuncts of

φ_{grid} the *generation rules*. Since the address predicates $c_{i,j}$ and $d_{i,j}$ form a partition, at most one of these formulas has its preconditions satisfied, so we obtain a sequence a_0, a_1, a_2, \dots , satisfying the various predicates specified by those formulas. It is not obvious that the sequence $\{a_t\}$ defined in this way continues forever; but we shall show that it does.

We give an informal explanation of how the sequence $\{a_t\}$ works. A good way to understand what is happening is to suppose that there is some element a_{t+1} in the sequence such that $d_{i,0}[a_{t+1}]$ (with i even) and $\text{bt}[a_{t+1}]$. (The formal proof below ensures that such t exists; but for now we shall take this on trust.) Only two possible generation rules can apply: (41) and (44), depending on whether $\text{dg}[a_{t+1}]$. If $\neg\text{dg}[a_{t+1}]$, then rule (41) applies and ensures that $d_{i,[j+1]}[a_{t+2}]$. The first index in the local address remains as i , but the second index is incremented modulo 6. Now the situation repeats, with the applicable generation rules being (41) and (44). Thus, either the former is applied forever, or we eventually generate an element a_{t+} , say, such that $d_{i,j'}[a_{t+}]$ (for some j') and $\text{dg}[a_{t+}]$. We will see presently that the first of these alternatives is not possible; and on this assumption, we shall refer to the elements a_{t+1}, \dots, a_{t+} as an *upward column*. The generation rule (41) ensures that each element in this sequence is related to the next by two different colour-predicates. Let us call these—in the order they appear in (41)—the *primary* colour and the *secondary* colour, respectively. Since $d_{i,0}[a_{t+1}]$, and remembering our mnemonics *black*, *green* and *red* for T_0 , T_1 and T_2 , respectively, we see that the sequences of primary and secondary colours on this upward column are

black, black, green, green, red, red, . . .
green, red, red, black, black, green, . . .

repeating (as long as the column continues) with a period of six. This is illustrated by the even-numbered columns in Fig. 5 below the diagonal, where the primary colours are drawn to the left and the secondaries to the right. Furthermore, rule (41) also ensures that the local addresses in the sequence are all $d_{i,j}$, with i constant and j cycling through the numbers $0, \dots, 5$.

A scan of the generation rules shows that a_{t+1} can itself only have been generated by (43), in which case we have $d_{[i-1],0}[a_t]$ and $\text{bt}[a_t]$, and indeed, by (38), $\neg\text{dg}[a_t]$. Working backwards, the only way we could have generated a_t is by (42), whence $d_{[i-1],1}[a_{t-1}]$ and $\neg\text{bt}[a_{t-1}]$. Comparing the local addresses of a_t and a_{t-1} , we see that the first index is $[i-1]$ in both cases, but the second index has been incremented modulo 6. Let us continue to work back. Only two possible generation rules could have yielded a_{t-1} : (42) and (48), depending on whether $\text{dg}[a_{t-1}]$. If $\neg\text{dg}[a_{t-1}]$, then a_{t-1} must have been generated by (42), whence $d_{[i-1],2}[a_{t-2}]$. As this cannot carry on for ever (for a_0 has local address $d_{0,0}$ and $[i-1]$ is odd), we must have some $t^- < t$ such that $d_{[i-1],j'}[a_{t-}]$ (for some j') and $\text{dg}[a_{t-}]$. We refer to the subsequence a_{t-}, \dots, a_t as a *downward column*. Each element in this sequence generates its successor via rule (42), which ensures that the former is related to the latter by two different colour-predicates, which we call—again in the order they appear in (42)—the *primary*

colour and the *secondary* colour, respectively. Since $d_{i,0}[a_t]$, we see that the sequences of primary and secondary colours on this upward again cycle through the colours with period 6, but this time *ending* in the respective patterns

\dots , green, black, black, red, red, green
 \dots , red, red, green, green, black, black.

This is illustrated by the odd-numbered columns in Fig. 5 below the diagonal, where the primary colours are drawn to the left and the secondaries to the right. (To help the reader, Table 2 resolves the colour predicates in conjuncts (41), (42), (45) and (46) for each i and j .) In particular, we see that the sequence of primary colours counting forwards from a_{t+1} is the same as the sequence of secondary colours counting backwards from a_t . Furthermore, as we move backwards from a_t to a_{t-} , the elements all have local addresses $d_{\lfloor i-1 \rfloor, j'}$, with j' cycling through the numbers $0, \dots, 5$.

j	conjunct (41): ($i = 0, 2, 4$)		conjunct (42): ($i = 1, 3, 5$)		i	conjunct (45): (j even)		conjunct (46): (j odd)	
	<i>pr. c.</i>	<i>sec. c.</i>	<i>pr. c.</i>	<i>sec. c.</i>		<i>pr. c.</i>	<i>sec. c.</i>	<i>pr. c.</i>	<i>sec. c.</i>
0	0	1	1	2	0	2	0	1	2
1	0	2	0	2	1	1	0	1	0
2	1	2	0	1	2	1	2	2	0
3	1	0	2	1	3	0	2	2	1
4	2	0	2	0	4	0	1	0	1
5	2	1	1	0	5	2	1	0	2

Table 2: Primary and secondary colours resolved. (Intended to help the reader.)

Now let us concentrate on the few elements surrounding a_t and a_{t+1} . We have established that a_{t+1} was generated from a_t by application of rule (43), so that a_t and a_{t+1} joined by T_0 (black). Assuming that $t^- \leq t - 2$ and $t^+ \geq t + 3$, we have established that each element in the sequence a_{t-2}, \dots, a_{t+3} is related to the next by T_0 (black), whence by transitivity, $T_0[a_{t-2}, a_{t+3}]$. Thus we obtain a ‘black brick’ of six elements connected in sequence by T_0 , sitting on the bottom of the grid between a downward column and a following upward column (see Fig. 5). We now add to φ_{grid} conjuncts which we refer to as *transfer* formulas:

$$\bigwedge_{i=1,3,5} \bigwedge_{j=0,2,4} \forall (d_{i,j} \rightarrow \forall (d_{\lfloor i+1 \rfloor, j} \wedge T_{\lfloor j/2-1 \rfloor_3} \rightarrow T_{\lfloor j/2 \rfloor_3})) \quad (49)$$

$$\bigwedge_{i=0,2,4} \bigwedge_{j=1,3,5} \forall (d_{i,j} \rightarrow \forall (d_{\lfloor i+1 \rfloor, j} \wedge T_{\lfloor j/2-1 \rfloor_3} \rightarrow T_{\lfloor j/2+1 \rfloor_3})) \quad (50)$$

$$\bigwedge_{i=0,2,4} \forall (d_{i,i} \wedge dg \rightarrow \forall (c_{i, \lfloor i+1 \rfloor} \wedge T_{\lfloor i/2 \rfloor_3} \rightarrow T_{\lfloor i/2+1 \rfloor_3})) \quad (51)$$

$$\bigwedge_{i=1,3,5} \forall(d_{i,i} \wedge \text{dg} \rightarrow \forall(c_{i,[i+1]} \wedge T_{[i/2]_3} \rightarrow T_{[i/2-1]_3})) \quad (52)$$

$$\bigwedge_{i=0,2,4} \bigwedge_{j=0,2,4} \forall(c_{i,j} \rightarrow \forall(c_{i,[j+1]} \wedge T_{[i/2]_3} \rightarrow T_{[i/2+1]_3})) \quad (53)$$

$$\bigwedge_{i=1,3,5} \bigwedge_{j=1,3,5} \forall(c_{i,j} \rightarrow (c_{i,[j+1]} \wedge T_{[i/2]_3} \wedge \rightarrow T_{[i/2-1]_3})). \quad (54)$$

It follows from (49) (under the stated assumptions about the sequence a_{t-2}, \dots, a_{t+3}), that $T_1[a_{t-2}, a_{t+3}]$ (green). Now the argument repeats. Assuming that $t^- \leq t-4$ and $t^+ \geq t+5$, we see from the sequences of secondary colours in the downward column and primary colours in the upward column, that $T_1[a_{t-4}, a_{t-2}]$ and $T_1[a_{t+3}, a_{t+5}]$. But we have just argued that $T_1[a_{t-2}, a_{t+3}]$, so that, by transitivity, $T_2[a_{t-4}, a_{t+5}]$, giving us a ‘green brick’ consisting of the six elements $a_{t-4}, a_{t-3}, a_{t-2}, a_{t+3}, a_{t+4}, a_{t+5}$. (Note that these are not consecutive in the sequence $\{a_t\}$.) Furthermore, by (49), $T_2[a_{t-4}, a_{t+5}]$. Continuing this reasoning, as long as the downward and upward columns in question have at least $2\ell + 1$ elements, we must have $T_{[\ell]_3}[a_{t-2\ell}, a_{t+1+2\ell}]$. That is, the elements a_t display the pattern of ‘horizontal’ colour links between every second element of the $(i-1)$ st (downward) and i th (upward) columns, for i non-zero and even, as shown in Fig. 5.

Let us write T_\diamond to abbreviate $T_0 \vee T_1 \vee T_2$; thus $T_\diamond[a, b]$ means that a is related to b by at least one of the colours. We now add to φ_{grid} conjuncts which we refer to as *control formulas*:

$$\bigwedge_{i=0}^5 \forall(d_{i,i} \wedge \pm \text{dg} \rightarrow \forall(T_\diamond \wedge d_{[i+1],[i+1]} \rightarrow \pm \text{dg})) \quad (55)$$

$$\bigwedge_{i=0}^5 \forall(d_{i,0} \wedge \pm \text{bt} \rightarrow \forall(T_\diamond \wedge d_{[i+1],0} \rightarrow \pm \text{bt})) \quad (56)$$

$$\bigwedge_{j=0}^5 \forall(c_{[j-1],j} \wedge \pm \text{dg}^+ \rightarrow \forall(T_\diamond \wedge c_{j,[j+1]} \rightarrow \pm \text{dg}^+)) \quad (57)$$

$$\bigwedge_{j=0}^5 \forall(c_{0,j} \wedge \pm \text{lf} \rightarrow \forall(T_\diamond \wedge c_{0,[j+1]} \rightarrow \pm \text{lf})). \quad (58)$$

Here, the occurrences of \pm are assumed to be resolved in the same way within a numbered display: thus, each of (55)–(58) is actually a *pair* of formulas. In particular, the formulas (55) say that, if a is related to b by any colour, and the local addresses of a and b are as indicated, then a satisfies dg iff b does.

Returning to our example of a downward column a_{t-}, \dots, a_t , followed by an upward column a_{t+1}, a_{t+2}, \dots , we observe from (38) that, since j is odd and a_{t-} by assumption satisfies dg , we may write $t^- = t - 2\ell - 1$ for some ℓ . Furthermore, since this downward column was generated by rule (42), none of the elements $a_{t-2\ell}, \dots, a_t$ satisfies dg . It then follows from (55) and the colour links just established that successive elements $a_{t+2}, \dots, a_{t+2\ell+2}$ also do

not satisfy dg, and indeed that the upward column extends at least to the point $a_{t+2\ell+3}$. But since $a_{t-} = a_{t-2\ell-1}$ by assumption satisfies dg, it follows from (55) and the colour links just established that $a_{t+2\ell+3}$ does as well. Thus, the upward column ends precisely at the point $a_{t+} = a_{t+2\ell+3}$. Again, this is illustrated by adjacent columns below the diagonal in Fig. 5.

Similar reasoning applies to *rightward rows* (subsequences of $\{a_t\}$ in which elements satisfy $c_{i,j}$ with i fixed and odd, and with j cycling through the indices $0, \dots, 5$, as well as *leftward rows*, defined similarly. Using the same argument as for the $d_{i,j}$, we see that, if there is a leftward row of length $2\ell + 1$ ending in a_{t-1} (where, by assumption, all elements satisfy $c_{i,j}$ with i taking a common, even value), then there is a corresponding rightward row of length $2\ell + 2$, and starting with a_t . Moreover, elements in these rows are connected by vertical colour links as shown in Fig. 5, and none of the elements $a_t, \dots, a_{t+2\ell+1}$ satisfies dg^+ (but $a_{t+2\ell+2}$ does).

Finally, we consider what happens at the end of an upward column (an element a_{t+} satisfying dg, and hence $d_{i,i}$ with i even). At that point (44) ensures that a_{t++1} satisfies $c_{\lfloor i-1 \rfloor, i}$ and dg^+ . Moreover, $T_{i/2}[a_{t+}, a_{t++1}]$. Now consider the element a_{t-} at the start of the previous downward column. We have already argued that a_{t-} is related to a_{t+} by $T_{i/2}$. But then, by transitivity, $T_{i/2}[a_{t-}, a_{t++1}]$, and hence, by (52), $T_{\lfloor i/2-1 \rfloor 3}[a_{t-}, a_{t++1}]$. This allows us to coordinate the elements of the rightward row ending in a_{t-1} with the leftward row beginning from a_{t++2} . Similar remarks apply to columns.

This concludes the informal presentation of the formula φ_{grid} . Let us take stock. The generation rules (39)–(48) generate a sequence of elements $\{a_t\}_{t \geq 0}$ satisfying certain local address predicates and control predicates. Quite independently, we define the boustrophedon curve $\{(X_t, Y_t)\}_{t \geq 0}$ shown in Fig. 5. The transfer formulas (49)–(54) and control formulas (55)–(58) then ensure that the predicates satisfied by each element a_t are appropriate to the corresponding pair of coordinates (X_t, Y_t) . In particular, the local address predicates tell us whether we are above or below the diagonal, and give the values X_t and Y_t modulo 6; and the control predicates tell us whether (X_t, Y_t) lies on the bottom row, the left column, the diagonal or the super-diagonal. This is done by ensuring that (geometrically) neighbouring points are connected by colours as indicated in Fig. 5.

Let us now turn to the formal proof. Denote by $\zeta(t) = (X_t, Y_t)$ the coordinates of the t th point on the boustrophedon shown in Fig. 5, starting with $\zeta(0) = (X_0, Y_0) = (0, 0)$. We would like to show that, for each point in the sequence $\{a_t\}$, the following properties are satisfied.

- (P1) If $X_t < Y_t$, then $c_{i,j}[a_t]$, where $i = \lfloor X_t \rfloor$ and $j = \lfloor Y_t \rfloor$; if $X_t \geq Y_t$, then $d_{i,j}[a_t]$, where $i = \lfloor X_t \rfloor$ and $j = \lfloor Y_t \rfloor$.
- (P2) We have: $lf[a_t]$ if and only if $X_t = 0$ and $Y_t > 0$; $bt[a_t]$ if and only if $Y_t = 0$; $dg[a_t]$ if and only if $X_t = Y_t$; and $dg^+[a_t]$ if and only if $Y_t = X_t + 1$.
- (P3) If $s < t$ and the points (X_s, Y_s) and (X_t, Y_t) are connected by an arrow in Fig. 5 of colour T_k , then $T_k[a_s, a_t]$.

Lemma 27. *Suppose $\mathfrak{A} \models \varphi_{grid}$, and let the sequence a_0, a_1, \dots be constructed as described above. Then (P1)–(P3) hold for all $t \geq 0$.*

Proof. By induction on t . For $t = 0$, all statements in (P1)–(P3) are either trivial or immediate from 39. Furthermore, the only generation rule that applies in this case is (40), in which case (P1)–(P3) are immediately secured for $t = 1$. Suppose, then $t \geq 1$, and that (P1)–(P3) hold for all values up to t ; we show that they hold for $t+1$. We proceed by cases, depending on whether a_t satisfies either $d_{i,j}$ or $c_{i,j}$, and whether i (respectively, j) is odd or even. We give details for the case where a_t satisfies $d_{i,j}$ and i is even. The other cases are similar.

Assume first that a_t does not satisfy dg. The generation rule that applies in this case is (41), in whence a_{t+1} satisfies $d_{i, \lfloor j+1 \rfloor}$ but not bt. Now, by IH (P2), $X_t \neq Y_t$, hence by IH (P1): $X_t > Y_t$, with X_t even. By the construction of the boustrophedon, then, $X_{t+1} = X_t$ and $Y_{t+1} = Y_t + 1$ whence $X_{t+1} > 0$ and $X_{t+1} \geq Y_{t+1}$. This immediately secures all the conditions in (P1)–(P2) except for the condition that $\text{dg}[a_{t+1}]$ if and only if $X_{t+1} = Y_{t+1}$, which we must establish. In addition, we must establish (P3).

We begin with the latter. That $T_{j/2}[a_t, a_{t+1}]$ and $T_{\lfloor j/2+1 \rfloor_3}[a_t, a_{t+1}]$ is immediate from the generation rule (41). Consulting Fig. 5, it remains only to show that, if j is odd, and $s < t$ is such that $X_s = X_{t+1} - 1$ and $Y_s = Y_{t+1}$, then $T_{j/2}[a_s, a_{t+1}]$ and $T_{\lfloor j/2+1 \rfloor_3}[a_s, a_{t+1}]$. Now, using IH (P3), we see from Fig. 5 $T_{j/2}[a_s, a_{s+1}]$, $T_{j/2}[a_{s+1}, a_{s+2}]$, $T_{j/2}[a_{s+2}, a_{t-1}]$ and $T_{j/2}[a_{t-1}, a_t]$; and we have just established that $T_{j/2}[a_t, a_{t+1}]$. By transitivity of $T_{j/2}$, then, $T_{j/2}[a_s, a_{t+1}]$; and by the transfer formula (49), $T_{\lfloor j/2+1 \rfloor_3}[a_s, a_{t+1}]$. Thus (P3) is established. Returning to the missing condition in (P2), if j is even, then, by IH (P1), so is Y_t ; similarly, since i is even so is X_t . Thus $X_{t+1} = X_t \neq Y_{t+1} = Y_t + 1$, and moreover, by (38), $-\text{dg}[a_{t+1}]$, since $d_{i, j+1}[a_{t+1}]$. Thus, we may assume that j is odd. But now let $s' < t-1$ be such that $X_{s'} = X_t - 1$ and $Y_{s'} = Y_t$. By inspection of Fig. 5 and applying IH (P3), we see that $T_{j/2}[a_{s'-1}, a_{s'}]$, $T_{j/2}[a_{s'}, a_{t-1}]$, and $T_{j/2}[a_{t-1}, a_t]$; and, we have just established that $T_{j/2}[a_t, a_{t+1}]$. By transitivity, then, $T_{j/2}[a_{s'-1}, a_{t+1}]$. But by IH (P2), $\text{dg}[a_{s'-1}] \Leftrightarrow X_{s'-1} = Y_{s'-1}$, and by the choice of s' , $X_{s'-1} = Y_{s'-1} \Leftrightarrow X_{t+1} = Y_{t+1}$. Furthermore, having established that $T_{j/2}[a_{s'-1}, a_{t+1}]$, it follows by the control formula (55) that $\text{dg}[a_{s'-1}] \Leftrightarrow \text{dg}[a_{t+1}]$. Thus, $\text{dg}[a_{t+1}] \Leftrightarrow X_{t+1} = Y_{t+1}$ as required.

We assumed above that a_t does not satisfy dg; now suppose that it does. The generation rule that applies in this case is (44), and (P1)–(P2) follow instantly. To establish (P3), referring to Fig. 5, we observe first that the generation rule itself ensures that a_t is connected to a_{t+1} by $T_{\lfloor i/2-1 \rfloor_3}$ and $T_{\lfloor i/2 \rfloor_3}$. It remains to show that, if $s < t$ is such that $X_s = X_t - 1$ and $Y_s = Y_t - 1$, then a_s is connected to a_{t+1} by $T_{\lfloor i/2-1 \rfloor_3}$ and $T_{\lfloor i/2+1 \rfloor_3}$. By IH (P3), the successive pairs in the sequence $a_s, a_{s+1}, a_{t-2}, a_{t-1}, a_t$ are connected by $T_{\lfloor i/2-1 \rfloor_3}$; and we have just established that $T_{\lfloor i/2-1 \rfloor_3}[a_t, a_{t+1}]$. By transitivity, $T_{\lfloor i/2-1 \rfloor_3}[a_s, a_{t+1}]$. Since $d_{i-1, i-1}[a_s]$, and $c_{i-1, i}[a_{t+1}]$, it follows from the transfer formula (52) that $T_{\lfloor i/2+1 \rfloor_3}[a_s, a_{t+1}]$ as required. \square

Lemma 27 justifies us in picturing the sequence a_0, a_1, \dots as laid out in Fig. 5, but it does not tell us that the elements of this sequence are distinct.

However, we shall show that, in fact, φ_{grid} is an axiom of infinity. As a preliminary, consider the rectangles into which the upper-right quadrant of the plane is divided by the black, green and red lines in Fig. 5. We refer to these rectangles as *bricks*. Each brick consists of four or six points in the plain, with the former kind confined to the left-hand and bottom edges; moreover, the bricks form a natural sequence following the boustrophedon. Since every point $\zeta(t) = (X_t, Y_t)$ is associated with an element a_t in some model of φ_{grid} , we can think of bricks as the set of associated elements. And by inspection of Fig. 5, we see that for any brick B , there exists k ($0 \leq k < 3$) such that, for all elements $a_s, a_t \in B$ with $s < t$, we have $T_k[a_s, a_t]$. In other words, each brick has a *colour*, and, furthermore, an *orientation* induced by the ordering of points on the boustrophedon. We call the bricks below the diagonal having their left-hand margins in even columns *downward-pointing*, while those below the diagonal having their left-hand margins in odd columns are *upward-pointing*; similarly for *leftward-* and *rightward-pointing* bricks above the diagonal, depicted by yellow arrows in Figure 5. Of course, while the elements of B lie in order as the periphery of B is traversed, they are not in general consecutive in the sequence $\{a_t\}$. In the light of the above discussion, the following are evident.

- (E1) Every element satisfying $d_{i,j}$ except for a_0 lies on at least one upward-pointing brick and at least one downward pointing brick.
- (E2) The colour and orientation of a brick B is determined entirely by the local addresses of its elements; hence two elements with the same local address lie on bricks with the same set of colours/orientations.
- (E3) In particular, if B is a 6-element upward-pointing brick and its first element is a non-diagonal element, then that element has local address $d_{i,j}$ (i odd, j even), while the last element has local address $d_{[i+1],j}$, and the colour of B is $T_{\lfloor j/2 - 1 \rfloor_3}$.
- (E4) The first element of each brick B is related to all the others by the colour of B , and all the elements but the last are related to the last element by the colour of B .

In the proof of the following lemma, recall that $\zeta(t) = (X_t, Y_t)$, the t -th point in the boustrophedon.

Lemma 28. *Suppose $\mathfrak{A} \models \varphi_{grid}$, and let the sequence $\{a_t\}$ be as just constructed. Then the elements of this sequence are all distinct.*

Proof. Assume for contradiction that $a_s = a_t$ with $t < s$. We consider the case where $a_s = a_t$ satisfies some $d_{i,j}$; the case for elements satisfying some $c_{i,j}$ is handled similarly.

Assume first that $Y_s = Y_t$. Since $t < s$, and, a_s has the same local address as a_t (since they are identical), we must have $X_t < X_s$ and therefore, by (P1), $X_t < X_s - 5$. As a preliminary, we claim that, if a_s lies on a brick B and a_t on a brick D , then no element of either B or D can satisfy dg . For if B has an element

$a_{s'}$ such that $\text{dg}[a_{s'}]$, then $X_t < X_s - 5 \leq X_{s'} - 4 = Y_{s'} - 4 \leq Y_s - 2 = Y_t - 2 < Y_t$ contradicting (P1) and the fact that $a_s = a_t$ satisfies some predicate $d_{i,j}$. In particular, $a_s = a_t$ itself does not satisfy dg . If, on the other hand, D has an element $a_{t'}$ satisfying dg , then, by inspection of Fig 5, there is such a t' satisfying $t' > t$. Letting $s' = s + (t' - t)$, we see that since the sequences $a_s, \dots, a_{s'}$ and $a_t, \dots, a_{t'}$ are the same (and thus have the same local addresses), whence $X_s, \dots, X_{s'}$ and $X_t, \dots, X_{t'}$ move in the same way, so that $X_t < X_s - 5$ implies $X_{t'} < X_{s'} - 5$. Thus, recalling that $\text{dg}[a_{s'}]$ implies $X_{t'} = Y_{t'}$, and that $Y_s = Y_t$ by assumption, we have $X_{s'} > X_{t'} + 5 = Y_{t'} + 5 \geq Y_t + 3 = Y_s + 3 \geq Y_{s'} + 1 > Y_{s'}$, contradicting the supposition that $a_{t'} = a_{s'}$ satisfies dg . This proves the claim that neither a_s nor a_t lie on any brick containing a diagonal element.

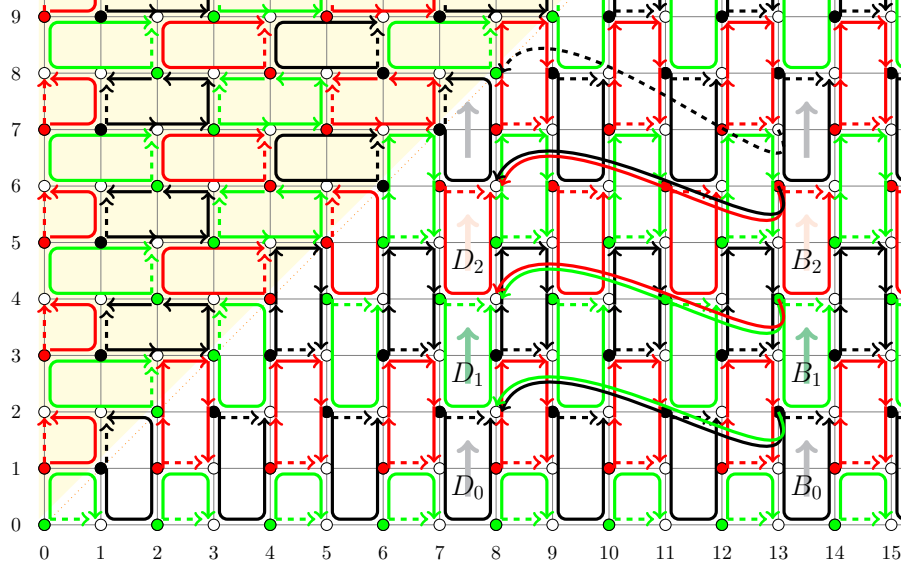

Figure 6: Proof of Lemma 28: $\zeta(s_0) = (13, 2)$, $\zeta(t_0) = (8, 2)$. $T_0[a_{s_0}, a_{t_0}]$ implies $T_1[a_{s_0}, a_{t_0}]$ implies $T_1[a_{s_1}, a_{t_1}]$ implies $T_2[a_{s_1}, a_{t_1}]$ implies $T_2[a_{s_2}, a_{t_2}]$ implies $T_0[a_{s_2}, a_{t_2}]$. The black edge from $(13, 7)$ to $(8, 8)$ yields the desired contradiction.

This claim having been established, we proceed to derive the promised contradiction. To make the proof easier, we suggest the reader follows with reference to the example $\zeta(s) = (14, 1)$ and $\zeta(t) = (8, 1)$ (see Fig. 6). Let B_0 and D_0 be the upward-pointing bricks containing, respectively, a_s and a_t , and having the same colour, say T_{k_0} . Let a_{s_0} be the first element on the brick B_0 , and a_{t_0} —the last element on the brick D_0 , in our example, $\zeta(s_0) = (13, 2)$ and $\zeta(t_0) = (8, 2)$. By (E4), $T_{k_0}[a_{s_0}, a_{t_0}]$, i.e. a_{s_0} is connected to a_{t_0} by an edge of some colour, T_{k_0} —in our example, black. The transfer formula (49) implies that $T_{\lfloor k_0+1 \rfloor_3}[a_{s_0}, a_{t_0}]$, in our case green. Now, write $k_1 = \lfloor k_0 + 1 \rfloor_3$, and let B_1 and D_1 be the upward-pointing bricks of colour T_{k_1} (in our case, green), containing, respectively, a_{s_0}

and a_{t_0} . Let a_{s_1} be the first element on the brick B_1 , and a_{t_1} —the last element on the brick D_1 , i.e. $\zeta(s_1) = (13, 4)$ and $\zeta(t_1) = (8, 4)$. Again, by (E4), a_{s_1} is connected to a_{t_1} by a T_{k_1} -edge (green), hence by (49), also by an edge of colour T_{k_2} , where $k_2 = \lfloor k_1 + 1 \rfloor_3$ (red).

Now the reasoning simply repeats, until either the brick above B_ℓ or the brick above D_ℓ contains an element satisfying dg. In particular, in our example, we consider B_2 and D_2 —the red upward-pointing bricks containing, respectively, a_{s_1} and a_{t_1} , and we let a_{s_2} be the first element on the brick B_2 , and a_{t_2} —the last element on the brick D_2 . So, $\zeta(s_2) = (13, 6)$ and $\zeta(t_2) = (8, 6)$. Again, by (E4), a_{s_2} is connected to a_{t_2} by a red edge, hence by (49), also by a black one. Now the black brick above D_2 contains diagonal elements (i.e. $l = 2$); in particular, $\text{dg}[a_{t_2+2}]$, where $\zeta(t_2 + 2) = (8, 8)$.

Recall that we are assuming that $Y_s = Y_t$. By (E2), we have $Y_{s_0} = Y_{t_0}$, and, since we have been following the two columns of the boustrophedon upward, $Y_{s_\ell} = Y_{t_\ell}$. Moreover, since $t < s$, we have $X_{t_\ell} < X_{s_\ell}$, and indeed, $X_{t_\ell} < X_{s_\ell} - 5$. So, indeed, the process stops when the brick above D_ℓ contains an element satisfying dg and, then, we necessarily have $\text{dg}[a_{t_\ell+2}]$. We have already established that $d_{i_0, \lfloor j_0+2\ell \rfloor}[a_{s_\ell}]$, $d_{\lfloor i_0+1 \rfloor, \lfloor j_0+2\ell \rfloor}[a_{t_\ell}]$ and $T_{k_0+l+1}[a_{s_\ell}, a_{t_\ell}]$ (black). By inspection of Fig. 5, we see that $T_{k_0+l+1}[a_{s_\ell-1}, a_{s_\ell}]$, and, indeed, $T_{k_0+l+1}[a_{t_\ell}, a_{t_\ell+2}]$. By transitivity, therefore $T_{k_0+l+1}[a_{s_\ell-1}, a_{t_\ell+2}]$. On the other hand, since $X_{s_\ell-1} > Y_{s_\ell-1}$, (P2) implies that $a_{s_\ell-1}$ does not satisfy dg. But then we have $d_{i_0, \lfloor j_0+2\ell+1 \rfloor}[a_{s_\ell-1}]$, $d_{\lfloor i_0+1 \rfloor, \lfloor j_0+2\ell+2 \rfloor}[a_{t_\ell+2}]$ and $T_{k+l+1}[a_{s_\ell-1}, a_{t_\ell+2}]$, which, in the presence of (38), violates the control formula (55). In our case, $\zeta(s_2 - 1) = (13, 7)$ and we have $d_{1,1}[a_{s_2-1}]$, $d_{2,2}[a_{t_2+2}]$, $T_0[a_{s_2-1}, a_{t_2+2}]$, $-\text{dg}[a_{s_2-1}]$ and $\text{dg}[a_{t_2+2}]$.

This deals with the case $Y_s = Y_t$. If $Y_s \neq Y_t$, then we let B_0 be any downward-pointing brick containing a_s , T_k be the colour of B_0 , and D_0 the downward-pointing brick containing a_t and having the same colour as D_0 . Again, we let s_0 be the first element on B_0 and t_0 be the last element on D_0 , following the preceding bricks B_1, B_2, \dots and D_1, D_2, \dots . This time, however, we will be moving *down* the columns until we reach B_ℓ and D_ℓ such that one of the elements $a_{s_\ell-1}$ or $a_{t_\ell+1}$ satisfies bt. Now, the assumption that $Y_s \neq Y_t$ implies that at most one of $a_{s_\ell-1}$ and $a_{t_\ell+1}$ satisfies bt, which yields a violation of the control formula (56) using parallel reasoning to the upward case. The process is depicted in Figure 7 for one particular case. \square

Equipped with Lemma 28 we can now define a natural embedding ι of \mathbb{N}^2 into any model \mathfrak{A} of φ_{grid} setting $\iota(X, Y) = a_t$, where a_t is the element of the infinite sequence as defined above such that $\zeta(t) = (X, Y)$. In view of the above discussion it is easy to see that ι has the following properties:

- (H1) If $X \geq Y$ then $T_\diamond[\iota(X, Y), \iota(X + 1, Y)]$. Moreover, if X is even then $T_\diamond[\iota(X, Y), \iota(X, Y + 1)]$, and if X is odd then $T_\diamond[\iota(X, Y + 1), \iota(X, Y)]$.
- (H2) If $X < Y$ then $T_\diamond[\iota(X, Y), \iota(X, Y + 1)]$. Moreover, if Y is even then $T_\diamond[\iota(X + 1, Y), \iota(X, Y)]$, and if Y is odd then $T_\diamond[\iota(X, Y), \iota(X + 1, Y)]$.

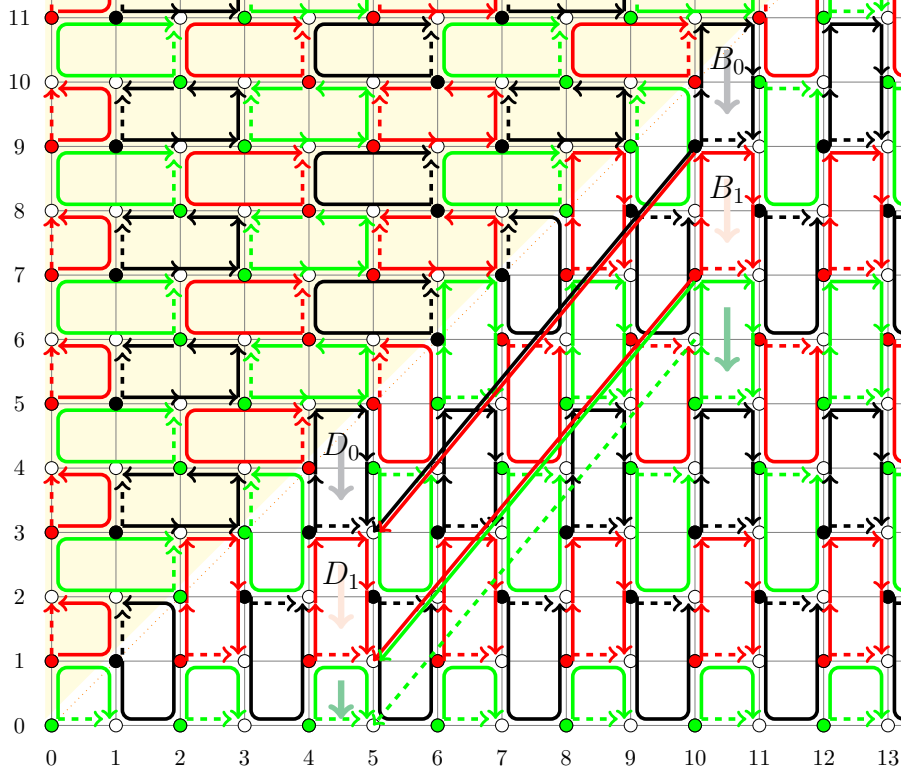

Figure 7: Proof of Lemma 28: $\zeta(s_0) = (10, 9)$, $\zeta(t_0) = (5, 3)$. $T_0[a_{s_0}, a_{t_0}]$ implies $T_2[a_{s_0}, a_{t_0}]$ implies $T_2[a_{s_1}, a_{t_1}]$ implies $T_1[a_{s_1}, a_{t_1}]$. $\zeta(s_1 - 1) = (10, 6)$, $\zeta(t_1 + 1) = (5, 0)$ and the green edge from $(10, 6)$ to $(5, 0)$ yields the desired contradiction with (56).

The above observation allows us to write formulas that properly assign tiles to elements of the model of φ_{grid} . We do this with a formula φ_{tile} , which again features several conjuncts. The first conjunct is straightforward. We require that each node encodes precisely one tile and the initial element satisfies the initial tiling condition by adding to φ_{tile} the formula:

$$\forall \left(\bigvee_{C \in \mathcal{C}} C \wedge \bigwedge_{C \neq D} (\neg C \vee \neg D) \wedge (\text{lf} \wedge \text{dg} \rightarrow C_0) \right). \quad (59)$$

The next formulas ensure that adjacent tiles respect the constraints H and V . To ensure that the horizontal constraints are satisfied we add to φ_{tile} the following conjuncts for every $C \in \mathcal{C}$:

$$\bigwedge_{0 \leq i, j \leq 5} \forall (C \wedge d_{ij} \rightarrow \forall (T_\diamond \wedge d_{[i+1], j} \rightarrow \bigvee_{C': (C, C') \in H} C')) \quad (60)$$

$$\bigwedge_{0 \leq i \leq 5} \bigwedge_{j=1,3,5} \forall (C \wedge c_{ij} \rightarrow \forall (T_{\diamond} \wedge (c_{[i+1],j} \vee d_{[i+1],j}) \rightarrow \bigvee_{C':(C,C') \in H} C')) \quad (61)$$

$$\bigwedge_{0 \leq i \leq 5} \bigwedge_{j=0,2,4} \forall (C \wedge (c_{i,j} \vee d_{i,j}) \rightarrow \forall (T_{\diamond} \wedge c_{[i-1],j} \rightarrow \bigvee_{C':(C',C) \in H} C')). \quad (62)$$

A similar group of conjuncts is added to handle the vertical constraints. Again, we add to φ_{tile} the following conjuncts for every $C \in \mathcal{C}$:

$$\bigwedge_{0 \leq i,j \leq 5} \forall (C \wedge (c_{i,j} \vee d_{i,j}) \rightarrow \forall (T_{\diamond} \wedge c_{i,[j+1]} \rightarrow \bigvee_{C':(C,C') \in V} C')) \quad (63)$$

$$\bigwedge_{i=0,2,4} \bigwedge_{0 \leq j \leq 5} \forall (C \wedge d_{i,j} \rightarrow \forall (T_{\diamond} \wedge d_{i,[j+1]} \rightarrow \bigvee_{C':(C,C') \in V} C')) \quad (64)$$

$$\bigwedge_{i=1,3,5} \bigwedge_{0 \leq j \leq 5} \forall (C \wedge d_{i,j} \rightarrow \forall (T_{\diamond} \wedge d_{i,[j-1]} \rightarrow \bigvee_{C':(C',C) \in V} C')). \quad (65)$$

This completes the definition of the formula φ_{tile} . Finally, let $\eta_{\mathcal{C}}$ be the conjunction of φ_{grid} and φ_{tile} . We show that $\eta_{\mathcal{C}}$ is satisfiable iff \mathcal{C} tiles \mathbb{N}^2 . Namely, if \mathcal{C} tiles \mathbb{N}^2 then to show that $\eta_{\mathcal{C}}$ is satisfiable we expand our intended model \mathfrak{G} for φ_{grid} assigning to every element of the grid a unique $C \in \mathcal{C}$ given by the tiling.

Now, let $\mathfrak{A} \models \eta_{\mathcal{C}}$. Since $\mathfrak{A} \models \varphi_{grid}$ consider the embedding ι of the standard \mathbb{N}^2 grid into \mathfrak{A} defined above. We define a tiling of the \mathbb{N}^2 grid assigning to every node $(X, Y) \in \mathbb{N}^2$ the unique tile C such that $\mathfrak{A} \models C(\iota(X, Y))$. Formula (59) ensures that this is well defined and satisfies the initial condition. Formulas (60)-(62) ensure that the horizontal constraints are satisfied and formulas (63)-(65) ensure that the vertical constraints are satisfied. Hence, we have the following

Theorem 29. *The satisfiability problem for \mathcal{FL}^23T , the two-variable fluted fragment with three transitive relations, is undecidable.*

We remark that since the formula φ_{grid} is an axiom of infinity, we cannot get simultaneously undecidability of the finite satisfiability problem applying Proposition 23. To prove the latter we reduce from the finite tiling problem. We proceed as follows. First, we modify the formula φ_{grid} so that it no longer constructs an infinite chain of witnesses but the process is allowed to stop whenever the boustrophedon meets an element on the bottom row. In other words, the chain of witnesses corresponds to a square domain $\mathbb{N}_{2n,2n}^2$, for some $n \geq 1$.

Denote the modified formula φ_{sgrid} . It contains some conjuncts taken directly φ_{grid} , some that are modified versions of conjuncts in φ_{grid} , and some that are new. First of all, we employ an additional control predicate rt intended to mark the rightmost column of the square domain. This is secured by adding the following new conjunct to φ_{sgrid} (complementing the formula (38)):

$$\forall (rt \rightarrow \bigvee_{i=0,2,4} \bigvee_{j=0}^5 d_{i,j}) \quad (66)$$

and the following new control formula:

$$\bigwedge_{i=0}^5 \bigwedge_{j=0}^5 \forall (d_{i,j} \wedge \pm \text{rt} \rightarrow \forall (T_\diamond \wedge d_{i,[j-1]} \rightarrow \pm \text{rt})). \quad (67)$$

In φ_{sgrid} we modify the formula (39) by ensuring that the initial element does not satisfy rt as follows:

$$\exists (d_{0,0} \wedge \text{dg} \wedge \text{bt} \wedge \neg \text{rt}). \quad (68)$$

Finally, we modify the formula (44); now we require a new witness only for bottom elements that are not on the rightmost column, writing:

$$\bigwedge_{i=1,3,5} \forall (d_{i,0} \wedge \text{bt} \wedge \neg \text{dg} \wedge \neg \text{rt} \rightarrow \exists (d_{[i+1],0} \wedge \text{bt} \wedge \neg \text{dg} \wedge T_0)). \quad (69)$$

Remaining conjuncts of φ_{grid} constitute conjuncts of φ_{sgrid} without modification.

Observe that φ_{sgrid} has finite models: if a witness a_t of the conjunct (48) happens to satisfy rt then the following witnesses $a_{t'}$ with $t' > t$, corresponding to a downward column in the model, also satisfy rt due to the control formula (67). As argued earlier, the chain of witnesses eventually reaches an element $a_{t''}$ satisfying bt , and this is where no new witnesses are required due to the modified conjunct (69). Moreover in every finite model of φ_{sgrid} one can embed a square grid $\mathbb{N}_{2n,2n}^2$ similarly as we did before embedding the \mathbb{N}^2 grid in models of φ_{grid} .

In order to complete the reduction of the finite tiling problem we need one more conjunct ensuring the final condition:

$$\forall (\text{dg} \wedge \text{rt} \rightarrow C_1). \quad (70)$$

It should be now straightforward to check that the conjunction of (70) with $\varphi_{sgrid} \wedge \varphi_{tile}$ is *finitely* satisfiable iff \mathcal{C} tiles $\mathbb{N}_{2n,2n}^2$, for some $n \geq 1$. Hence, we have the following:

Theorem 30. *The finite satisfiability problem for $\mathcal{FL}^2\mathcal{3T}$, the two-variable fluted fragment with three transitive relations, is undecidable.*

We complete this section noticing that all formulas used in the proofs of Theorems 29 and 30 are either guarded or can be rewritten as guarded. Furthermore, in the proof it would suffice to assume that T_0 , T_1 and T_2 are interpreted as equivalence relations. Hence, we can strengthen the above theorem as follows.

Corollary 31. *The (finite) satisfiability problem for the intersection of the fluted fragment with the two-variable guarded fragment is undecidable in the presence of three transitive relations (or three equivalence relations).*

5. Conclusions

In this paper, we considered the logics $\mathcal{FL}^m kT$ and $\mathcal{FL}^m_{=}kT$, the m -variable fluted fragment in the presence of (equality and) k transitive relations. We showed that the satisfiability problem for $\mathcal{FL}^m_{=}1T$ is in m -NEXPTIME, and indeed that the corresponding finite satisfiability problem is in $(m+1)$ -NEXPTIME. (It seems probable that this latter bound, at least, can be improved.) Together with known lower bounds on the m -variable fluted fragment, it follows that the satisfiability and finite satisfiability problems for $\mathcal{FL}_{=}1T$, the fluted fragment with equality and a single transitive relation, are both TOWER-complete. (This extends the result of [18], which establishes the same complexity for the fluted fragment without equality or any transitive relations.) We also showed, however, that decidability is easily lost when additional transitive relations are added: even the two-variable fluted fragments $\mathcal{FL}^2_{=}2T$ (two transitive relations plus equality) and $\mathcal{FL}^2_{=}3T$ (three transitive relations, but without equality) have undecidable satisfiability and finite satisfiability problems.

It is open whether the satisfiability or finite satisfiability problems for $\mathcal{FL}2T$ (two transitive relations, but without equality) are decidable. We point out that Lemma 19 in Section 3 could be generalized to normal-form formulas of $\mathcal{FL}^{m+1}2T$ (defined in the natural way). Hence, the (finite) satisfiability problem for \mathcal{FL}^m2T ($m > 2$) is decidable if and only if the corresponding problem \mathcal{FL}^22T is. Unfortunately neither the method of Sec. 3 (to show decidability) nor that of Sec. 4 (to show undecidability) appears to apply here. The barrier in the former case is that pairs of elements can be related by both of the transitive relations, T_1 and T_2 , via *distinct* T_1 - and T_2 -chains, so that simple certificates of the kind employed for $\mathcal{FL}^2_{=}1T^u$ do not guarantee the existence of models. The barrier in the latter case is that the grid construction has to build models featuring transitive paths of *bounded* length, and this seems not to be achievable with just two transitive relations.

Acknowledgements. This work is supported by the Polish National Science Centre grant 2018/31/B/ST6/03662.

References

- [1] F. Baader, D. Calvanese, D. L. McGuinness, D. Nardi, and P. F. Patel-Schneider, editors. *The Description Logic Handbook: Theory, Implementation, and Applications*. Cambridge University Press, 2003.
- [2] E. Börger, E. Grädel, and Y. Gurevich. *The Classical Decision Problem*. Springer, 1997.
- [3] E. Grädel, P. Kolaitis, and M. Vardi. On the decision problem for two-variable first-order logic. *Bulletin of Symbolic Logic*, 3(1):53–69, 1997.
- [4] A. Herzig. A new decidable fragment of first order logic. In *Abstracts of the 3rd Logical Biennial Summer School and Conference in Honour of S. C. Kleene*, June 1990.

- [5] Y. Kazakov. *Saturation-based decision procedures for extensions of the guarded fragment*. PhD thesis, Universität des Saarlandes, Saarbrücken, Germany, 2006.
- [6] Y. Kazakov and I. Pratt-Hartmann. A note on the complexity of the satisfiability problem for graded modal logic. In *Logic in Computer Science*, pages 407–416. IEEE, 2009.
- [7] E. Kieroński. Results on the guarded fragment with equivalence or transitive relations. In *Computer Science Logic*, volume 3634, pages 309–324. Springer Verlag, 2005.
- [8] E. Kieroński. On the complexity of the two-variable guarded fragment with transitive guards. *Information and Computation*, 204:1663–1703, 2006.
- [9] E. Kieroński, J. Michaliszyn, I. Pratt-Hartmann, and L. Tendera. Two-variable first-order logic with equivalence closure. *SIAM Journal on Computing*, 43(3):1012–1063, 2014.
- [10] E. Kieroński and M. Otto. Small substructures and decidability issues for first-order logic with two variables. *Journal of Symbolic Logic*, 77:729–765, 2012.
- [11] E. Kieroński and L. Tendera. On finite satisfiability of two-variable first-order logic with equivalence relations. In *Logic in Computer Science*. IEEE, 2009.
- [12] E. Kieroński and L. Tendera. Finite satisfiability of the two-variable guarded fragment with transitive guards and related variants. *ACM Transactions on Computational Logic*, 19(2):8:1–8:34, 2018.
- [13] R. Ladner. The computational complexity of provability in systems of modal propositional logic. *SIAM Journal on Computing*, 6:467–480, 1980.
- [14] C. Le Duc and M. Lamolle. Decidability of description logics with transitive closure of roles in concept and role inclusion axioms. In *Proceedings of the 23rd International Workshop on Description Logics (DL 2010), Waterloo, Ontario, Canada, May 4-7, 2010*, 2010.
- [15] A. Noah. Predicate-functors and the limits of decidability in logic. *Notre Dame Journal of Formal Logic*, 21(4):701–707, 1980.
- [16] I. Pratt-Hartmann. The finite satisfiability problem for two-variable, first-order logic with one transitive relation is decidable. *Mathematical Logic Quarterly*, 64(3):218–248, 2018.
- [17] I. Pratt-Hartmann, W. Szwaig, and L. Tendera. Quine’s fluted fragment is non-elementary. In *25th EACSL Annual Conference on Computer Science Logic, CSL*, volume 62 of *LIPICs*, pages 39:1–39:21. Schloss Dagstuhl - Leibniz-Zentrum fuer Informatik, 2016.

- [18] I. Pratt-Hartmann, W. Szwaast, and L. Tendera. The fluted fragment revisited. *Journal of Symbolic Logic*, 84(3):1020–1048, 2019.
- [19] I. Pratt-Hartmann and L. Tendera. The fluted fragment with transitivity. In Peter Rossmanith, Pinar Heggernes, and Joost-Pieter Katoen, editors, *44th International Symposium on Mathematical Foundations of Computer Science, MFCS 2019, August 26-30, 2019, Aachen, Germany*, volume 138 of *LIPICs*, pages 18:1–18:15. Schloss Dagstuhl - Leibniz-Zentrum für Informatik, 2019.
- [20] W. C. Purdy. Fluted formulas and the limits of decidability. *Journal of Symbolic Logic*, 61(2):608–620, 1996.
- [21] W. C. Purdy. Complexity and nicety of fluted logic. *Studia Logica*, 71:177–198, 2002.
- [22] W. V. Quine. On the limits of decision. In *Proceedings of the 14th International Congress of Philosophy*, volume III, pages 57–62. University of Vienna, 1969.
- [23] W. V. Quine. The variable. In *The Ways of Paradox*, pages 272–282. Harvard University Press, revised and enlarged edition, 1976.
- [24] S. Schmitz. Complexity hierarchies beyond Elementary. *ACM Transactions on Computation Theory*, 8(1:3):1–36, 2016.
- [25] W. Szwaast and L. Tendera. The guarded fragment with transitive guards. *Annals of Pure and Applied Logic*, 128:227–276, 2004.
- [26] W. Szwaast and L. Tendera. On the satisfiability problem for fragments of the two-variable logic with one transitive relation. *Journal of Logic and Computation*, 29(6):881–911, 2019.