

Full complexity classification of the list homomorphism problem for bounded-treewidth graphs *

Karolina Okrasa[†] Marta Piecyk[‡] Paweł Rzążewski[§]

September 23, 2020

Abstract

A homomorphism from a graph G to a graph H is an edge-preserving mapping from $V(G)$ to $V(H)$. Let H be a fixed graph with possible loops. In the list homomorphism problem, denoted by $\text{LHOM}(H)$, we are given a graph G , whose every vertex v is assigned with a list $L(v)$ of vertices of H . We ask whether there exists a homomorphism h from G to H , which respects lists L , i.e., for every $v \in V(G)$ it holds that $h(v) \in L(v)$.

The complexity dichotomy for $\text{LHOM}(H)$ was proven by Feder, Hell, and Huang [JGT 2003]. The authors showed that the problem is polynomial-time solvable if H belongs to the class called *bi-arc graphs*, and for all other graphs H it is NP-complete.

We are interested in the complexity of the $\text{LHOM}(H)$ problem, parameterized by the treewidth of the input graph. This problem was investigated by Egri, Marx, and Rzążewski [STACS 2018], who obtained tight complexity bounds for the special case of reflexive graphs H , i.e., if every vertex has a loop.

In this paper we extend and generalize their results for *all* relevant graphs H , i.e., those, for which the $\text{LHOM}(H)$ problem is NP-hard. For every such H we find a constant $k = k(H)$, such that the $\text{LHOM}(H)$ problem on instances with n vertices and treewidth t

- can be solved in time $k^t \cdot n^{\mathcal{O}(1)}$, provided that the input graph is given along with a tree decomposition of width t ,
- cannot be solved in time $(k - \varepsilon)^t \cdot n^{\mathcal{O}(1)}$, for any $\varepsilon > 0$, unless the SETH fails.

For some graphs H the value of $k(H)$ is much smaller than the trivial upper bound, i.e., $|V(H)|$.

Obtaining matching upper and lower bounds shows that the set of algorithmic tools we have discovered cannot be extended in order to obtain faster algorithms for $\text{LHOM}(H)$ in bounded-treewidth graphs. Furthermore, neither the algorithm, nor the proof of the lower bound, is very specific to treewidth. We believe that they can be used for other variants of the $\text{LHOM}(H)$ problem, e.g. with different parameterizations.

*The first author was supported by the ERC Starting Grant CUTACOMBS (grant agreement No. 714704). The second and the third author were supported by the Polish National Science Centre grant no. 2018/31/D/ST6/00062.

[†]Warsaw University of Technology, Faculty of Mathematics and Information Science and University of Warsaw, Institute of Informatics, k.okrasa@mini.pw.edu.pl

[‡]Warsaw University of Technology, Faculty of Mathematics and Information Science, m.piecyk@mini.pw.edu.pl

[§]Warsaw University of Technology, Faculty of Mathematics and Information Science and University of Warsaw, Institute of Informatics, p.rzazewski@mini.pw.edu.pl

1 Introduction

A popular line of research in studying computationally hard problems is to consider restricted instances, in order to understand the boundary between easy and hard cases. For example, most of natural problems can be efficiently solved on trees, using a bottom-up dynamic programming. This observation led to the definition of *treewidth*, which, informally speaking, measures how much a given graph resembles a tree. The notion of treewidth appears to be very natural and it was independently discovered by several authors in different contexts [3, 9, 42, 16].

For many problems, polynomial-time algorithms for graphs with bounded treewidth can be obtained by adapting the dynamic programming algorithms for trees. Most of these straightforward algorithms follow the same pattern, which was captured by the seminal meta-theorem by Courcelle [14]: he proved that each problem expressible in *monadic second order logic* (MSO_2) can be solved in time $f(\text{tw}(G)) \cdot n^{\mathcal{O}(1)}$ on graphs G with n vertices and treewidth $\text{tw}(G)$, where f is some function, depending on the MSO_2 formula describing the particular problem. As a consequence of this meta-theorem, in order to show that some problem Π is *fixed-parameter tractable* (FPT), parameterized by the treewidth, it is sufficient to show that Π can be described in a certain way.

The main problem with using the meta-theorem as a black-box is that the function f it produces is huge (non-elementary). We also know that this bound cannot be improved, if we want to keep the full generality of the statement [26]. Because of this, as the area of the so-called *fine-grained complexity* gained popularity [37], researchers turned back to studying particular problems, and asking about the best possible dependence on treewidth, i.e., the function f . This led to many exciting algorithmic results which significantly improved the naive dynamic programming approach [47, 7, 36].

There is a little caveat that applies to most of algorithms mentioned above: Usually we assume that the input graph is given along with its tree decomposition, and the running time is expressed in terms of the width of this decomposition. This might be a serious drawback, since finding an optimal tree decomposition is NP-hard [2]. However, finding a tree decomposition of given width (if one exists) can be done in FPT time [5, 8], which is often sufficient. Since we are interested in the complexity of certain problems, parameterized by the treewidth, we will not discuss the time needed to find a decomposition. Thus we will always assume that the input graph is given along with its tree decomposition.

In parallel to improving the algorithms, many lower bounds were also developed [38, 42, 16]. Let us point out that the main assumption from the classical complexity theory, i.e., $P \neq NP$, is too weak to provide any meaningful lower bounds in our setting. The most commonly used assumptions in the fine-grained complexity world, are the *Exponential-Time Hypothesis* (ETH) and the *Strong Exponential-Time Hypothesis* (SETH), both introduced by Impagliazzo and Paturi [32, 33]. Informally speaking, the ETH implies that 3-SAT with n variables cannot be solved in subexponential time, i.e., in time $2^{o(n)}$, and the SETH implies that CNF-SAT with n variables and m clauses cannot be solved in time $(2 - \varepsilon)^n \cdot m^{\mathcal{O}(1)}$, for any $\varepsilon > 0$.

For example the straightforward dynamic programming algorithm for k -COLORING works in time $k^{\text{tw}(G)} \cdot n^{\mathcal{O}(1)}$. As one of the first SETH-based lower bounds for problems parameterized by the treewidth, Lokshantov, Marx, and Saurabh [38] proved that this bound is tight.

Theorem 1 (Lokshantov, Marx, Saurabh [38]). *For any $k \geq 3$, there is no algorithm solving k -COLORING on a graph with n vertices and treewidth t in time $(k - \varepsilon)^t \cdot n^{\mathcal{O}(1)}$, unless the SETH fails.*

Graph homomorphisms. In this paper we are interested in extending [Theorem 1](#) for one of possible generalization of the k -COLORING problem. For graph G and H (both with possible loops on vertices), a *homomorphism* from G to H is a mapping $h: V(G) \rightarrow V(H)$, which preserves edges, i.e., for every edge

xy of G it holds that $h(x)h(y) \in E(H)$. The graph H is called a *target*. If h is a homomorphism from G to H , we denote it by writing $h : G \rightarrow H$. We also write $G \rightarrow H$ to indicate that some homomorphism from G to H exists.

By $\text{HOM}(H)$ we denote the computational problem of deciding whether an instance graph G admits a homomorphism to H (usually we consider H a fixed graph, but we might also treat it as a part of the input). Observe that if $H = K_k$, then $\text{HOM}(H)$ is equivalent to the k -COLORING problem. Because of that, homomorphisms to H are often called *H-colorings*. We will also refer to vertices of H as *colors*.

Let us briefly survey the some results concerning the complexity of variants of the $\text{HOM}(H)$ problem. For more information, we refer the reader to the comprehensive monograph by Hell and Nešetřil [30]. The complexity dichotomy for $\text{HOM}(H)$ was shown by Hell and Nešetřil [31]: the problem is polynomial-time-solvable if H contains a vertex with a loop or is bipartite, and NP-complete for all other graphs H . Since then, many interesting results concerning the complexity of graph homomorphisms have appeared [25, 48, 43, 15, 17, 13]. The fine-grained complexity of the $\text{HOM}(H)$ problem, parameterized by the treewidth of the input graph, was very recently studied by Okrasa and Rzażewski [41]. They were able to find tight SETH-bounds, conditioned on two conjectures from algebraic graph theory from early 2000s. As these conjectures remain wide open, we know no graph, for which the bounds from [41] do not apply.

A natural and interesting extension of the $\text{HOM}(H)$ problem is its *list* version. In the *list homomorphism problem*, denoted by $\text{LHOM}(H)$, the input consists of a graph G and a *H-lists* L , which means that L is a function which assigns to each vertex of G a subset of vertices of H . We ask whether there is a homomorphism h from G to H , which respects lists L , i.e., for each $x \in V(G)$ it holds that $h(x) \in L(x)$. If h is such a list homomorphism, we denote it by $h : (G, L) \rightarrow H$. We also write $(G, L) \rightarrow H$ to indicate that some homomorphism $h : (G, L) \rightarrow H$ exists.

The complexity of the $\text{LHOM}(H)$ problem was shown in three steps. First, Feder and Hell [19] provided a classification for the case that H is *reflexive*, i.e., every vertex has a loop. They proved that if H is an interval graph, then the problem is polynomial-time solvable, and otherwise it is NP-complete. The next step was showing the complexity dichotomy for *irreflexive graphs* (i.e., with no loops). Feder, Hell, and Huang [20] proved that if H is bipartite and its complement is a circular-arc graph, then the problem is polynomial-time solvable, and otherwise it is NP-complete. Interestingly, bipartite graphs whose complement is circular-arc were studied independently by Trotter and Moore [46] in the context of some poset problems. Finally, Feder, Hell, and Huang [21] provided the full classification for general graph H : the polynomial cases appear to be *bi-arc graphs*, which are also defined in terms of some geometric representation. Let us now skip the exact definition of bi-arc graphs, and we will get back to it in Section 4.1.

Let us point out that in all three papers mentioned above, the polynomial-time algorithms for $\text{LHOM}(H)$ exploited the geometric representation of H . On the other hand, all hardness proofs followed the same pattern. First, for each “easy” class \mathcal{C} (i.e., interval graphs, bipartite co-circular-arc graphs, and bi-arc graphs), the authors provided an alternative characterization in terms of forbidden subgraphs. In other words, they defined a (non-necessarily finite) family \mathcal{F} of graphs, such that $H \in \mathcal{C}$ if and only if H does not contain any $F \in \mathcal{F}$ as an induced subgraph. Then, for each $F \in \mathcal{F}$, the authors showed that $\text{LHOM}(F)$ is NP-complete. Note that this is sufficient, as every “hard” graph H contains some $F \in \mathcal{F}$, and every instance of $\text{LHOM}(F)$ is also an instance of $\text{LHOM}(H)$, where no vertex from $V(H) - V(F)$ appears in any list.

If the input graph G is given with a tree decomposition of width $\text{tw}(G)$, then the straightforward dynamic programming solves the $\text{LHOM}(H)$ problem in time $|V(H)|^{\text{tw}(G)} \cdot |V(G)|^{\mathcal{O}(1)}$. The study of the fine-grained complexity of the $\text{LHOM}(H)$ problem, parameterized by the treewidth of the input graph, was initiated by Egri, Marx, and Rzażewski [18]. They were able to provide the full complexity classification

for the case of reflexive graphs H , i.e., corresponding to the first step of the above-mentioned complexity dichotomy.

The authors defined a new and simple graph invariant, denoted by i^* , which is based on *incomparable sets* and the existence of a certain decompositions in H , and proved the following tight bounds.

Theorem 2 (Egri, Marx, Rzażewski [18]). *Let H be a fixed connected reflexive non-interval graph, and let $k = i^*(H)$. The $\text{LHOM}(H)$ problem on instances (G, L) with n vertices,*

- (a) *can be solved in time $k^{\text{tw}(G)} \cdot n^{\mathcal{O}(1)}$, provided that an optimal tree decomposition of G is given,*
- (b) *cannot be solved in time $(k - \varepsilon)^{\text{tw}(G)} \cdot n^{\mathcal{O}(1)}$ for any $\varepsilon > 0$, unless the SETH fails.*

In this paper we continue this line of research and provide the full complexity classification for all graphs H . Our results heavily extend the framework of Egri, Marx, Rzażewski [18] and generalize Theorem 2.

1.1 Our results.

In this paper we provide a full complexity classification of $\text{LHOM}(H)$, parameterized by the treewidth of an instance graph. Our results heavily extend the ones of Egri, Marx, Rzażewski [18] and generalize Theorem 2 to all relevant graphs H . Let us point out that instead of designing ad-hoc algorithms and reductions that are fine-tailored for a particular problem, we rather build a general framework that allows us to provide tight bounds for a natural and important family of problems.

We prove the complexity classification for $\text{LHOM}(H)$ in two steps. First, we consider the case that the target graph H is bipartite. Then we extend the results to general graphs H , with loops allowed.

Bipartite graphs H . We first deal with the case that H is bipartite (in particular, irreflexive), with bipartition classes X and Y . Recall that we are interested in graphs H , for which the $\text{LHOM}(H)$ problem is NP-hard, i.e., graphs that are not co-circular-arc graphs. Moreover, we consider only connected graphs H (as otherwise we can reduce to this case in polynomial time).

Let us present the high-level idea behind our algorithm for $\text{LHOM}(H)$. Consider an instance (G, L) , such that G is connected, and let $n = |V(G)|$. We may assume that G is bipartite, as otherwise (G, L) is clearly a no-instance. Furthermore, in any homomorphism from G to H , each bipartition class of G is mapped to a different bipartition class of H . We can assume that this is already reflected in the lists (we might have to solve two independent instances).

The algorithm is based on two main ideas. First, observe that if H contains two vertices u, v , which are in the same bipartition class, and each neighbor of u is a neighbor of v , then the only thing preventing us from using v instead u is the fact that v might not appear in some list containing u . Thus we might always assume that each list is an *incomparable set*, i.e., it does not contain two vertices u, v as above. By $i(H)$ we denote the size of a largest incomparable set contained in one bipartition class.

The second idea is related to a certain decomposition of H . By a *bipartite decomposition* we mean a partition of the vertex set of H into three subsets D, N, R , such that:

- at least one of sets $(D \cap X)$ and $(D \cap Y)$ has at least 2 elements,
- N is non-empty and induces a biclique in H ,
- the sets $(D \cap X) \cup (N \cap Y)$ and $(D \cap Y) \cup (N \cap X)$ induce bicliques in H ,
- N is a D - R -separator.

We show that if H has a bipartite decomposition, then we can reduce solving an instance (G, L) of $\text{LHOM}(H)$ to solving several instances of $\text{LHOM}(H_1)$ and $\text{LHOM}(H_2)$, where H_1 is the subgraph of H induced by D , and H_2 is obtained from H_2 by collapsing $D \cap X$ and $D \cap Y$ to single vertices.

This leads to the definition of $i^*(H)$ as the maximum value of $i(H')$ over all connected undecomposable induced subgraphs H' of H , which are not complements of a circular-arc graph (a graph is undecomposable if it has no bipartite decomposition). As our first result, we show that the algorithm exploiting decompositions recursively runs in time $i^*(H)^{\text{tw}(G)} \cdot n^{\mathcal{O}(1)}$.

One might wonder whether some additional observations could be used to improve the algorithm. As our second result, we show that this is not possible, assuming the SETH. This means that unless something unexpected happens in complexity theory, our algorithmic toolbox allows to solve $\text{LHOM}(H)$, parameterized by the treewidth, as fast as possible. More formally, we show the following theorem, which fully classifies the complexity of $\text{LHOM}(H)$ for bipartite graphs H .

Theorem 3. *Let H be a connected bipartite graph, whose complement is not a circular-arc graph, and let $k = i^*(H)$. Let G be a bipartite graph with n vertices and treewidth $\text{tw}(G)$.*

- (a) *Even if H is given as an input, the $\text{LHOM}(H)$ problem with instance (G, L) can be solved in time $k^{\text{tw}(G)} \cdot (n \cdot |H|)^{\mathcal{O}(1)}$ for any lists L , provided that G is given with an optimal tree decomposition.*
- (b) *Even if H is fixed, there is no algorithm that solves $\text{LHOM}(H)$ for every G and L in time $(k - \varepsilon)^{\text{tw}(G)} \cdot n^{\mathcal{O}(1)}$ for any $\varepsilon > 0$, unless the SETH fails.*

Note that for [Theorem 3 a\)](#), if H is not considered to be a constant, $n \cdot |H|$ is a natural measure of the size of an instance, as it is an upper estimate on the sum of sizes of all lists.

The main tool used in the proof of [Theorem 3 b\)](#) is the following technical lemma.

Lemma 4 (Constructing a $\text{NEQ}(S)$ -gadget). *Let H be a connected, bipartite, undecomposable graph, whose complement is not a circular-arc graph. Let S be an incomparable set of $k \geq 2$ vertices of H , contained in one bipartition class. Then there exists a $\text{NEQ}(S)$ -gadget, i.e., a graph F with H -lists L and two special vertices $x, x' \in V(F)$, such that $L(x) = L(x') = S$ and*

- *for any list homomorphism $h : (F, L) \rightarrow H$, it holds that $h(x) \neq h(x')$,*
- *for any distinct $s, s' \in S$ there is a list homomorphism $h : (F, L) \rightarrow H$, such that $h(x) = s$ and $h(x') = s'$.*

Let us point out that the graph constructed in [Lemma 4](#) can be seen as a *primitive-positive definition* of the inequality relation on S (see e.g. Bulatov [[12](#), Section 2.1]). However, we prefer to present our results using purely combinatorial terms.

The proof of [Lemma 4](#) is technically involved, but as soon as we have it, the proof of [Theorem 3 b\)](#) is straightforward. Consider an instance G of k -COLORING, where $k = i^*(H)$. Let H' be a connected, undecomposable, induced subgraph of H , whose complement is not a circular-arc graph, and contains an incomparable set S of size k . We construct a graph G^* by replacing each edge uv of G with a copy of the $\text{NEQ}(S)$ -gadget, given by [Lemma 4](#) (invoked for H' and S), so that u is identified with x and v is identified with x' . By the properties of the gadget, we observe that G^* has a list homomorphism to H if and only if G is a yes-instance of k -COLORING. Furthermore, the construction of the $\text{NEQ}(S)$ -gadget depends on H only, and H is assumed fixed, so we conclude that $\text{tw}(G^*) = \text{tw}(G) + \mathcal{O}(1)$. Therefore the statement of [Theorem 3 b\)](#) follows from [Theorem 1](#).

General graphs H . Next, we move to the general case. We aim to reduce the problem to the bipartite case. The main idea comes from Feder, Hell, and Huang [[21](#)] who showed a close connection between the $\text{LHOM}(H)$ problem and the $\text{LHOM}(H^*)$ problem, where H^* is the *associated bipartite graph* of H , i.e., the bipartite graph with bipartition classes $\{v' : v \in V(H)\}$ and $\{v'' : v \in V(H)\}$, where $u'v'' \in E(H^*)$

if and only if $uv \in E(H)$. Let us point out that we can equivalently define H^* as a categorical (direct) product of H and K_2 [28].

We extend the definition of i^* to non-bipartite graphs by setting $i^*(H) := i^*(H^*)$. Let us point out that this definition is consistent with the definition for bipartite graphs, and with the definition of i^* for reflexive graphs, introduced by Egri, Marx, and Rzażewski [18]. We show the following theorem, fully classifying the complexity of the $\text{LHOM}(H)$ problem, parameterized by the treewidth of the instance graph.

Theorem 5. *Let H be a connected non-bi-arc graph (with possible loops), and let $k = i^*(H)$. Let G be a graph with n vertices and treewidth $\text{tw}(G)$.*

- (a) *Even if H is given as an input, the $\text{LHOM}(H)$ problem with instance (G, L) can be solved in time $k^{\text{tw}(G)} \cdot (n \cdot |H|)^{\mathcal{O}(1)}$ for any lists L , provided that G is given with an optimal tree decomposition.*
- (b) *Even if H is fixed, there is no algorithm that solves $\text{LHOM}(H)$ for every G and L in time $(k - \varepsilon)^{\text{tw}(G)} \cdot n^{\mathcal{O}(1)}$ for any $\varepsilon > 0$, unless the SETH fails.*

As we mentioned before, both statements of [Theorem 5](#) follow from the corresponding statements in [Theorem 3](#). For the algorithmic part, we define certain decompositions of general graphs H and show that they coincide with bipartite decompositions H^* . This lets us reduce solving an instance (G, L) of $\text{LHOM}(H)$ to solving some instances of $\text{LHOM}(H^*)$.

On the complexity side, the reduction is even more direct: we show that an algorithm solving the $\text{LHOM}(H)$ problem on instances with treewidth t in time $(i^*(H) - \varepsilon)^t \cdot n^{\mathcal{O}(1)}$ could be used to solve the $\text{LHOM}(H^*)$ problem on instances with treewidth t in time $(i^*(H^*) - \varepsilon)^t \cdot n^{\mathcal{O}(1)}$, thus contradicting [Theorem 3 b](#)).

In the conclusion of the paper we discuss how the decompositions defined for general graphs H behave in two natural special cases: if H is either reflexive or irreflexive. Recall that they correspond to the first two steps of the complexity dichotomy for $\text{LHOM}(H)$ [19, 20]. We also analyze the complexity for *typical* graphs H , and prove the following.

Corollary 6. *For almost all graphs H with possible loops the following holds. Even if H is fixed, there is no algorithm that solves $\text{LHOM}(H)$ for every instance (G, L) in time $\mathcal{O}((|V(H)| - \varepsilon)^{\text{tw}(G)} \cdot n^{\mathcal{O}(1)})$ for any $\varepsilon > 0$, unless the SETH fails.*

Finally, we show how to generalize our approach of reducing instances of $\text{LHOM}(H)$ to instances of $\text{LHOM}(H')$, where H' is undecomposable. We believe that this idea could be exploited to study the complexity of $\text{LHOM}(H)$ in various regimes, e.g., for different parameterizations of input instances.

1.2 Comparison to the previous work.

Let us briefly discuss similarities and differences between our work and previous, closely related results by Egri, Marx, and Rzażewski [18] (about the complexity of the $\text{LHOM}(H)$ problem for reflexive H), and by Okrasa and Rzażewski [41] (about the complexity of the $\text{HOM}(H)$ problem).

At the high level, we follow the direction used by Egri *et al.* [18], but since we generalize their result to *all* relevant graphs H , the techniques become much more involved. The crucial idea was to reduce the problem to the bipartite case, and to define decompositions of general graphs that correspond to the decompositions of H^* . On the contrary, the case of reflexive graphs H is much more straightforward. In particular, there is just one type of decomposition that could be exploited algorithmically. Also, the structure of “hard” subgraphs is much simpler in this case, so the necessary gadgets are significantly easier to construct.

On the other hand, in order to prove hardness for the $\text{HOM}(H)$ problem, Okrasa and Rzażewski [41] used mostly *algebraic tools* that are able to capture the global structure of a graph. In contrast, our proofs are purely combinatorial. Furthermore, we are able to provide the full complexity classification for all graphs H , while the results of [41] are conditioned on two twenty-year-old conjectures.

1.3 Notation.

Let H be a graph. By $\text{comp}(H)$ we denote the set of connected components of H . For a vertex v , by $N(v)$ we denote the *neighborhood* of v , i.e., the set of vertices adjacent to v (note that $v \in N(v)$ if and only if v has a loop). For a set $U \subseteq V(H)$, we define $N(U) := \bigcup_{u \in U} N(u) - U$ and $N[U] := \bigcup_{u \in U} N(u) \cup U$. If $U = \{u_1, \dots, u_k\}$, we omit one pair of brackets and write $N(u_1, \dots, u_k)$ (respectively $N[u_1, \dots, u_k]$) instead of $N(\{u_1, \dots, u_k\})$ (respectively $N[\{u_1, \dots, u_k\}]$).

We say that two vertices x, y are *comparable* if $N(y) \subseteq N(x)$ or $N(x) \subseteq N(y)$. If two vertices are not comparable, we say that they are *incomparable*. A set of vertices is *incomparable* if all vertices are pairwise incomparable.

We say that a set $A \subseteq V(H)$ is *complete* to a set B if for every $a \in A$ and $b \in B$ the edge ab exists. On the other hand, A is *non-adjacent* to B if there are no edges with one endvertex in A and the other in B .

Let H be a bipartite graph, whose bipartition classes are denoted by X and Y . For a set $S \subseteq V(H)$ and $Z \in \{X, Y\}$, by S_Z we denote $S \cap Z$. For $A, B \subseteq V(H)$, we say that A is *bipartite-complete* to B if A_X is complete to B_Y and A_Y is complete to B_X .

2 Algorithm for bipartite target graphs

Observe that we might always assume that H is connected, as otherwise we can solve the problem for each connected component of H separately. Furthermore, without losing the generality we may assume certain properties of instances of $\text{LHOM}(H)$ that we need to solve.

Observation 7. *Let (G, L) be an instance of $\text{LHOM}(H)$, where H is connected and bipartite with bipartition classes X, Y . Without loss of generality, we might assume the following.*

1. *The graph G is connected and bipartite, with bipartition classes X_G and Y_G ,*
2. *$\bigcup_{x \in X_G} L(x) \subseteq X$ and $\bigcup_{y \in Y_G} L(y) \subseteq Y$,*
3. *for each $x \in V(G)$, the set $L(x)$ is incomparable.*

Proof. 1. If G is not connected, we need to solve the problem separately for each connected component. If G is not bipartite, then we can immediately report a no-instance.

2. Observe that in any homomorphism $f: (G, L) \rightarrow H$, either $f(X_G) \subseteq X$ and $f(Y_G) \subseteq Y$, or $f(X_G) \subseteq Y$ and $f(Y_G) \subseteq X$. Thus in order to solve (G, L) , we can separately solve two instances (G, L') and (G, L'') of $\text{LHOM}(H)$, defined as follows. For each $x \in X_G$ we define $L'(x) := L(x) \cap X$ and $L''(x) := L(x) \cap Y$, and for each $y \in Y_G$ we define $L'(y) := L(y) \cap Y$ and $L''(y) := L(y) \cap X$. Then (G, L) is a yes-instance of $\text{LHOM}(H)$ if and only if at least one of (G, L') and (G, L'') is a yes-instance of $\text{LHOM}(H)$. Thus if we can solve each of instances (G, L') and (G, L'') in time $T(G)$, then we can solve the instance (G, L) in time $2T(G)$.

3. If $N(u) \subseteq N(v)$ and both u and v appear on a list of some $x \in V(G)$, then in any homomorphism $f: (G, L) \rightarrow H$ with $f(x) = u$ we can always recolor x to the color v . The obtained mapping is still a list homomorphism from (G, L) to H , so we can safely remove u from $L(x)$. \square

An instance of $\text{LHOM}(H)$ that respects conditions in [Observation 7](#) is called *consistent*. From now on we will restrict ourselves to consistent instances. Let us introduce a graph parameter, which will play a crucial role in our investigations.

Definition 1 ($i(H)$). For a bipartite graph H , by $i(H)$ we denote the maximum size of an incomparable set in H , which is fully contained in one bipartition class.

Clearly for every H we have $i(H) \leq |H|$. Note that by [Observation 7](#) we obtain the following.

Corollary 8. *Let (G, L) be a consistent instance of $\text{LHOM}(H)$, where H is bipartite. Then $\max_{v \in V(G)} |L(v)| \leq i(H)$.*

2.1 Decomposition of bipartite graphs

Throughout this section we assume that the target graph H is bipartite with bipartition classes X and Y . In particular, it has no loops. Our algorithm for $\text{LHOM}(H)$ is based on the existence of a certain decomposition of H .

Definition 2 (Bipartite decomposition). A partition of $V(H)$ into an ordered triple of sets (D, N, R) is a *bipartite decomposition* if the following conditions are satisfied.

1. N is non-empty and separates D and R ,
2. $|D_X| \geq 2$ or $|D_Y| \geq 2$,
3. N induces a biclique in H ,
4. D is bipartite-complete to N .

Since so far we only consider bipartite decompositions, we will just call them decompositions. Later on we will introduce other types of decompositions and then the distinction will be important. If H admits a decomposition, then it is *decomposable*, otherwise it is *undecomposable*.

For a graph H with a decomposition (D, N, R) , the *factors of the decomposition* are two graphs H_1, H_2 defined as follows. The graph H_1 is the subgraph of H induced by the set D . The graph H_2 is obtained in the following way. For $Z \in \{X, Y\}$, if D_Z is non-empty, then we contract it to a vertex d_Z . If there is at least one edge between the sets D_X and D_Y , we add the edge $d_X d_Y$.

Note that both H_1 and H_2 are proper induced subgraphs of H . For H_1 it follows directly from the definition and H_2 can be equivalently defined as a graph obtained from H by removing all but one vertex from D_X (if $D_X \neq \emptyset$) and all but one vertex from D_Y (if $D_Y \neq \emptyset$). We leave the vertices that are joined by an edge, provided that such a pair exists.

Now let us demonstrate how the bipartite decomposition can be used algorithmically. Let $T(H, n, t)$ denote an upper bound for the complexity of $\text{LHOM}(H)$ on instances with n vertices, given along a tree decomposition of width t . In the following lemma we do not assume that $|H|$ is a constant.

Lemma 9 (Bipartite decomposition lemma). *Let H be a bipartite graph with bipartition classes X and Y , whose complement is not a circular-arc graph, and suppose H has a bipartite decomposition with factors H_1, H_2 . Assume that there are constants $\alpha \geq 1, c \geq 1$, and $d > 2$, such that $T(H_1, n, t) \leq \alpha \cdot c^t \cdot (n \cdot |H_1|)^d$ and $T(H_2, n, t) \leq \alpha \cdot c^t \cdot (n \cdot |H_2|)^d$. Then $T(H, n, t) \leq \alpha \cdot c^t \cdot (n \cdot |H|)^d$, if n is sufficiently large.*

Proof. Consider an instance (G, L) of $\text{LHOM}(H)$, recall that without loss of generality we may assume that it is consistent. Let the bipartition classes of G be X_G and Y_G and assume that $\bigcup_{x \in X_G} L(x) \subseteq X$ and $\bigcup_{y \in Y_G} L(y) \subseteq Y$.

Let (D, N, R) be a bipartite decomposition of H . We observe that for $Z \in \{X, Y\}$, and any two vertices $v \in D_Z, s \in N_Z$, we have $N(v) \subseteq N(s)$. Thus we may assume that no list contains both s and v . Let Q be the set of vertices of G which have at least one vertex from N in their lists.

Claim 9.1. *If there exists a list homomorphism $h: (G, L) \rightarrow H$, the image of each $C \in \text{comp}(G - Q)$ is entirely contained either in D or in R .*

Proof of Claim. By the definition of $\text{comp}(G - Q)$, the image of C is disjoint with N . Suppose there exist $a, b \in C$, such that $h(a) = u \in D$ and $h(b) = r \in R$. Since C is connected, there exists an a - b -path P in C . The image of P is an u - r -walk in H . But since N separates D and R in H , there is a vertex of P , which is mapped to a vertex of N , a contradiction. ■

Let us define lists L_1 as $L_1(x) := L(x) \cap D$, for every $x \in V(G) - Q$. For each $C \in \text{comp}(G - Q)$, we check if there exists a homomorphism $h_C: (C, L_1) \rightarrow H_1$. Let \mathbb{C}_1 be the set of those $C \in \text{comp}(G - Q)$, for which h_C exists. By **Claim 9.1**, we observe that if $C \notin \mathbb{C}_1$, then we can safely remove all vertices from D from the lists of vertices of C .

Now consider the graph H_2 . Let $Z \in \{X, Y\}$ and let d_Z be the vertex to which the set D_Z is collapsed (if it exists). Let us define an instance (G, L_2) of the $\text{LHOM}(H_2)$ problem, where the lists L_2 are as follows. If $v \in Z_G$ is a vertex from some component of \mathbb{C}_1 , then $L_2(v) := L(v) - D_Z \cup \{d_Z\}$ (note that in this case d_Z must exist). If v is a vertex from some component of $\text{comp}(G - Q) - \mathbb{C}_1$, then $L_2(v) := L(v) - D_Z$. Finally, if $v \in Q$, then $L_2(v) := L(v)$. Note that the image of each list is contained in $V(H_2)$. Moreover, note that $\bigcup_{x \in X_G} L_2(x) \subseteq R_X \cup N_X \cup \{d_X\}$ and $\bigcup_{y \in Y_G} L_2(y) \subseteq R_Y \cup N_Y \cup \{d_Y\}$.

Claim 9.2. *There is a list homomorphism $h: (G, L) \rightarrow H$ if and only if there is a list homomorphism $h': (G, L_2) \rightarrow H_2$.*

Proof of Claim. First, assume that $h : (G, L) \rightarrow H$ exists. Define $h' : V(G) \rightarrow V(H_2)$ in the following way:

$$h'(v) = \begin{cases} d_X & \text{if } h(v) \in D_X, \\ d_Y & \text{if } h(v) \in D_Y, \\ h(v) & \text{otherwise.} \end{cases}$$

Clearly h' is a homomorphism from G to H_2 , we need to show that it also respects lists L_2 . Suppose otherwise and let v be a vertex of G , such that $h'(v) \notin L_2(v)$. By symmetry, assume that $v \in X_G$, and thus $h'(v) \in X$. If $h'(v) \neq d_X$, then $h'(v) = h(v) \in (L(v) - D_X) \subseteq L_2(v)$. So suppose $h'(v) = d_X$ (and thus $h(v) \in D_X$) and $d_X \notin L_2(v)$. Observe that v cannot be a vertex from Q , since h maps v to a vertex of D_X and vertices from Q do not have any vertices of D in their lists. So the only case left is that v belongs to some connected component C of $G - Q$, which cannot be mapped to H_1 . But then, by [Claim 9.1](#), no vertex of C is mapped to any vertex of D , so $h(v) \notin D_X$, a contradiction.

Now suppose there exists a list homomorphism $h' : (G, L_2) \rightarrow H_2$. Define the following mapping h from $V(G)$ to $V(H)$. If $h'(v) \notin \{d_X, d_Y\}$, then we set $h(v) := h'(v)$. Otherwise, if $h'(v) \in \{d_X, d_Y\}$, then v is a vertex of some connected component $C \in \mathbb{C}_1$, and we define $h(v) := h_C(v)$. Clearly h preserves lists L : if $h(v) \notin D$, then $h(v) = h'(v) \in L_2(v) - \{d_X, d_Y\} \subseteq L(v)$; otherwise we use h_C , which preserves lists L by the definition.

Now suppose h does not preserve edges, so there are vertices $u \in X_G$ and $v \in Y_G$, such that uv is an edge of G and $h(u)h(v)$ is not an edge of H . If $h'(u) = d_X, h'(v) = d_Y$, or $h'(u) \neq d_X, h'(v) \neq d_Y$, then $h(u)h(v)$ must be an edge of H , otherwise we get a contradiction by the definitions of h_C (as since x and y are neighbors, they belong to the same C) and h' , respectively. So, by symmetry, suppose $h'(u) = d_X$ and $h'(v) \neq d_Y$. But then we observe that $h(u) \in D_X$ and $h(v) = h'(v) \in N_Y$, since h' is a homomorphism. And because N_Y is complete to D_X , so $h(u)h(v)$ is an edge – a contradiction. ■

Computing $\text{comp}(G - Q)$ can be done in time $\mathcal{O}(n \cdot |H| + n^2) = \mathcal{O}((n \cdot |H|)^2)$. Note that given a tree decomposition of G of width at most t , we can easily obtain a tree decomposition of each $C \in \text{comp}(G - Q)$ of width at most t . Computing h_C for all $C \in \text{comp}(G - Q)$ requires time at most

$$\sum_{C \in \text{comp}(G-Q)} T(H_1, |C|, t) \leq \sum_{C \in \text{comp}(G-Q)} \alpha \cdot c^t \cdot (|H_1| \cdot |C|)^d \leq \alpha \cdot c^t \cdot (|H_1| \cdot n)^d.$$

The estimation follows from the facts that $\sum_{C \in \text{comp}(G-Q)} |C| \leq n$, and n^d is superadditive with respect to n , i.e., $n_1^d + n_2^d \leq (n_1 + n_2)^d$. Computing lists L_2 can be performed in time $\mathcal{O}(|H| \cdot n)$. Finally, computing h' requires time $T(H_2, n, t) \leq \alpha \cdot c^t \cdot (|H_2| \cdot n)^d$. The total running time is therefore bounded by:

$$\mathcal{O}\left((n \cdot |H|)^2\right) + \alpha \cdot c^t \cdot (|H_1| \cdot n)^d + \mathcal{O}(|H| \cdot n) + \alpha \cdot c^t \cdot (|H_2| \cdot n)^d.$$

With a careful analysis one can verify that the above expression is bounded by $\alpha \cdot c^t \cdot (|H| \cdot n)^d$, provided that n is sufficiently large. □

2.2 Solving LHom(H) for bipartite targets

Let us define the main combinatorial invariant of the paper, $i^*(H)$:

Definition 3 ($i^*(H)$ for bipartite H). Let H be a connected bipartite graph, whose complement is not a circular-arc graph. Define

$$i^*(H) := \max\{i(H') : H' \text{ is an undecomposable, connected, induced subgraph of } H, \text{ whose complement is not a circular-arc graph}\}.$$

Observe that if H' is an induced subgraph of H , then $i(H') \leq i(H)$ and $i^*(H') \leq i^*(H)$, and thus $i^*(H) = i(H)$ for undecomposable H . Furthermore, we always have $i^*(H) \leq i(H)$, which in turn is upper-bounded by the size of the larger bipartition class of H , i.e., the natural bound on the size of the lists in an instance of $\text{LHOM}(H)$.

Let us point out that using [Definition 2](#) it is easy to create graphs H , for which $i^*(H)$ is arbitrarily smaller than this natural upper bound. For example, let $k \geq 3$ and let H_0 be obtained from $K_{k,k}$ by removing a perfect matching. Then H_0 is not the complement of a circular-arc graph, as it contains an induced C_6 . Now, for $j \geq 1$, the graph H_j is obtained from H_{j-1} by introducing another copy of H_0 and making all vertices from one bipartition class of H_{j-1} complete to a vertex of H_0 . It is straightforward to verify that for every $j \geq 1$ it holds that $i^*(H_j) = k + 1$, while each bipartition class of H_j has $j \cdot k$ vertices.

Now we are ready to present an algorithm solving $\text{LHOM}(H)$, note that again we do not assume that $|H|$ is a constant. We present the following, slightly more general variant of [Theorem 3 a](#)), where we also do not assume that the tree decomposition of G is optimal.

Theorem 3' a). *Let H be a connected bipartite graph (given as an input) and let (G, L) be an instance of $\text{LHOM}(H)$, where G has n vertices and is given along a tree decomposition of width t . Then there is an algorithm which decides whether $(G, L) \rightarrow H$ in time $\mathcal{O}(i^*(H)^t \cdot (n \cdot |H|)^{\mathcal{O}(1)})$.*

Proof. Clearly we can assume that n is sufficiently large, as otherwise we can solve the problem in polynomial time by brute-force.

Observe that with H we can associate a *recursion tree* \mathcal{R} , whose nodes are labeled with induced subgraphs of H . The root, denoted by $\text{node}(H)$ corresponds to the whole graph H . If H is undecomposable or is a complement of a circular-arc graph, then the recursion tree has just one node. Otherwise H has a decomposition with factors H_1 and H_2 , and then $\text{node}(H)$ has two children, $\text{node}(H_1)$ and $\text{node}(H_2)$, respectively. Recall that each factor has strictly fewer vertices than H , so we can construct \mathcal{R} recursively. Clearly, each leaf of \mathcal{R} is either the complement of a circular-arc graph (and thus the corresponding problem is polynomial-time solvable), or is an undecomposable induced subgraph of H . Note that a recursion tree may not be unique, as a graph may have more than one decomposition. However, the number of leaves is bounded by $\mathcal{O}(|H|)$ (actually, with a careful analysis we can show that it is at most $|H| - 2$), so the total number of nodes is $\mathcal{O}(|H|)$. Furthermore, it can be shown that in time polynomial in H we can check if H is undecomposable, or find a decomposition (we will prove it in [Lemma 23](#)). Since recognizing circular-arc graphs (and therefore of course their complements) is also polynomial-time solvable, we conclude that \mathcal{R} can be constructed in time polynomial in $|H|$.

If H is the complement of a circular-arc graph, then we solve the problem in polynomial time [\[20\]](#). If H is undecomposable, we run a standard dynamic programming algorithm on a tree decomposition of G (see [\[9, 6\]](#)). For each bag of the tree decomposition, and every partial list homomorphism from the graph induced by this bag to H we indicate whether this particular partial homomorphism can be extended to a list homomorphism of the graph induced by the subtree rooted at this bag. By [Corollary 8](#), the size of each list $L(x)$ for $x \in V(G)$ is at most $i(H)$, thus the complexity of the algorithm is bounded by $\alpha \cdot i(H)^t \cdot (n \cdot |H|)^d$ for some constants α, d . We can assume that $d > 2$, as otherwise we can always increase it.

So suppose H is decomposable and let us show that we can solve the problem in time $\alpha \cdot i^*(H)^t \cdot (n \cdot |H|)^d$. Let \mathcal{R} be a recursion tree of H and recall that its every leaf corresponds to an induced subgraph of H with strictly fewer vertices. Therefore, for any leaf node of \mathcal{R} , corresponding to the subgraph H' of H , we can solve every instance of $\text{LHOM}(H')$ with n vertices and a tree decomposition of width at most t in

time $\alpha \cdot i(H')^t \cdot (n \cdot |H'|)^d \leq \alpha \cdot i^*(H)^t \cdot (n \cdot |H'|)^d$. Now, applying [Lemma 9](#) in a bottom-up fashion, we conclude that we can solve $\text{LHom}(H)$ in time $\alpha \cdot i^*(H)^t \cdot (n \cdot |H|)^d = \mathcal{O}(i^*(H)^t \cdot (n \cdot |H|)^{\mathcal{O}(1)})$. \square

3 Hardness for bipartite target graphs

In this section we consider bipartite graphs H , which are not complements of circular-arc graphs. Let us discuss two equivalent definitions of this class of graphs.

Let X, Y be the bipartition classes of H and consider a circle C with two specified, distinct points p and q . A *co-circular-arc representation* of H is mapping of $V(H)$ to arcs of the circle C , such that (i) each arc corresponding to a vertex from X contains p but not q , (ii) each arc corresponding to a vertex from Y contains q but not p , and (iii) the vertices are adjacent if and only if their corresponding arcs are disjoint. It is known that the complement of H is a circular-arc graph if and only if H admits a co-circular-arc representation [45, 29].

However, for us it will be much more convenient to work with an equivalent definition of this class of graphs, discovered by Feder, Hell [20].

Definition 4 (Special edge asteroid). Let $k \geq 1$ and consider $A_X = \{u_0, \dots, u_{2k}\} \subseteq X$ and $A_Y = \{v_0, \dots, v_{2k}\} \subseteq Y$. The pair (A_X, A_Y) is a *special edge asteroid* if, for each $i \in \{0, \dots, 2k\}$, the vertices u_i and v_i are adjacent, and there exists a u_i - u_{i+1} -path $\mathcal{W}_{i,i+1}$ (indices are computed modulo $2k+1$), such that

- (a) there are no edges between $\{u_i, v_i\}$ and $\{v_{i+k}, v_{i+k+1}\} \cup \mathcal{W}_{i+k, i+k+1}$ and
- (b) there are no edges between $\{u_0, v_0\}$ and $\{v_1, \dots, v_{2k}\} \cup \bigcup_{i=1}^{2k-1} \mathcal{W}_{i, i+1}$.

Feder, Hell, and Huang [20] proved the following characterization of bipartite graphs, whose complements are circular-arc graphs.

Theorem 10 (Feder, Hell, and Huang [20]). *A bipartite graph H is the complement of a circular-arc graph if and only if H does not contain an induced cycle with at least 6 vertices or a special edge asteroid.*

We aim to prove Theorem 3 b). Actually we will show a version, which gives the lower bound parameterized by the pathwidth of G . Clearly such statement will be stronger, as $\text{pw}(G) \geq \text{tw}(G)$. This corresponds to the pathwidth variant of Theorem 1, also shown by Lokshantov, Marx, Saurabh [38].

Theorem 1' (Lokshantov, Marx, Saurabh [38]). *For any $k \geq 3$, there is no algorithm solving k -COLORING on a graph with n vertices and pathwidth t in time $(k - \varepsilon)^t \cdot n^{\mathcal{O}(1)}$, unless the SETH fails.*

Thus we show the following strengthening of Theorem 3 b).

Theorem 3' b). *Let H be a fixed bipartite graph, whose complement is not a circular-arc graph. Unless the SETH fails, there is no algorithm that solves the $\text{LHOM}(H)$ problem on instances with n vertices and pathwidth t in time $(i^*(H) - \varepsilon)^t \cdot n^{\mathcal{O}(1)}$, for any $\varepsilon > 0$.*

In order to prove Theorem 3' b), it is sufficient to show the following.

Theorem 11. *Let H be a fixed connected bipartite undecomposable graph, whose complement is not a circular-arc graph. Unless the SETH fails, there is no algorithm that solves the $\text{LHOM}(H)$ problem on instances with n vertices and pathwidth t in time $(i(H) - \varepsilon)^t \cdot n^{\mathcal{O}(1)}$, for any $\varepsilon > 0$.*

Let us show that Theorem 3' b) and Theorem 11 are equivalent.

(Theorem 11 \rightarrow Theorem 3' b)) Assume the SETH and suppose that Theorem 11 holds and Theorem 3' b) fails. So there is a bipartite graph H , whose complement is not a circular-arc graph, and an algorithm A that solves $\text{LHOM}(H)$ in time $(i^*(H) - \varepsilon)^{\text{pw}(G)} \cdot n^{\mathcal{O}(1)}$ for every input (G, L) , assuming that G is given along with its optimal path decomposition.

Let H' be an undecomposable connected induced subgraph of H , whose complement is not a circular-arc graph, and $i(H') = i^*(H)$. Let (G, L') be an arbitrary instance of $\text{LHOM}(H')$. Since H' is an induced subgraph of H , the instance (G, L') can be seen as an instance of $\text{LHOM}(H)$, where no vertex from $V(H) - V(H')$ appears in any list. The algorithm A solves this instance in time $(i^*(H) - \varepsilon)^{\text{pw}(G)} \cdot n^{\mathcal{O}(1)} = (i(H') - \varepsilon)^{\text{pw}(G)} \cdot n^{\mathcal{O}(1)}$, contradicting Theorem 11.

(Theorem 3' b) \rightarrow Theorem 11) Assume the SETH and suppose Theorem 3' b) holds and Theorem 11 fails. So there is a connected bipartite undecomposable graph H , whose complement is not a circular-arc graph, and an algorithm A that solves $\text{LHOM}(H)$ in time $(i(H) - \varepsilon)^{\text{pw}(G)} \cdot n^{\mathcal{O}(1)}$ for every input (G, L) . But since H is connected, bipartite, and undecomposable, we have $i^*(H) = i(H)$, so algorithm A contradicts Theorem 3' b).

3.1 Walks and obstructions: definitions and basic properties

Let us start this section with introducing some definitions and properties that will be heavily used in our hardness proof.

We call a set of edges *independent* if they form an induced matching. A *walk* \mathcal{P} is a sequence $\mathcal{P} = p_1, \dots, p_\ell$ of vertices of H , such that $p_i p_{i+1} \in E(H)$, for every $i \in [\ell - 1]$. We call $|\mathcal{P}| = \ell - 1$ the *length* of the walk \mathcal{P} . By $\overline{\mathcal{P}}$ we denote the walk \mathcal{P} reversed, i.e., $\overline{\mathcal{P}} = p_\ell, \dots, p_1$. If $|\mathcal{P}| > 0$, by \mathcal{P}^- and \mathcal{P}^+ , respectively, we denote the walks p_2, \dots, p_ℓ and $p_1, \dots, p_{\ell-1}$. If vertices a and b are, respectively, the first and the last vertex of a walk \mathcal{P} , we say that \mathcal{P} is an *a-b-walk* and denote it by $\mathcal{P} : a \rightarrow b$.

Now let us define the relation of walks, which will be crucial in our hardness reductions.

Definition 5 (Avoiding). For walks $\mathcal{P} = p_1, \dots, p_\ell$ and $\mathcal{Q} = q_1, \dots, q_\ell$ of equal length, such that p_1 is in the same bipartition class as q_1 , we say \mathcal{P} *avoids* \mathcal{Q} if $p_1 \neq q_1$ and for every $i \in [\ell - 1]$ it holds that $p_i q_{i+1} \notin E(H)$.

The following observation is immediate.

Observation 12. If $\mathcal{P} = p_1, p_2, \dots, p_\ell$ avoids $\mathcal{Q} = q_1, q_2, \dots, q_\ell$ and $\ell \geq 2$, then $q_2 \in N(q_1) - N(p_1)$ and $p_{\ell-1} \in N(p_\ell) - N(q_\ell)$. In particular, $N(q_1) \not\subseteq N(p_1)$ and $N(p_\ell) \not\subseteq N(q_\ell)$. \square

For walks $\mathcal{P} = p_1, \dots, p_\ell$ and $\mathcal{Q} = q_1, \dots, q_k$ such that $p_\ell = q_1$, we define $\mathcal{P} \circ \mathcal{Q} := p_1, \dots, p_\ell, q_2, \dots, q_k$ (in particular, $p_1, \dots, p_\ell \circ p_\ell = p_1, \dots, p_\ell$). We observe the following.

Observation 13. If $\mathcal{P} : x \rightarrow y$ avoids $\mathcal{Q} : p \rightarrow q$ and $\mathcal{P}' : y \rightarrow z$ avoids $\mathcal{Q}' : q \rightarrow r$, then $\mathcal{P} \circ \mathcal{P}'$ avoids $\mathcal{Q} \circ \mathcal{Q}'$. \square

We say that two disjoint sets S_1 and S_2 are *non-adjacent* if there is no edge with one vertex in S_1 and the other in S_2 . If it does not lead to confusion, we will sometimes identify a walk \mathcal{P} with the set of vertices in \mathcal{P} , so in particular we will say that walks \mathcal{P} and \mathcal{Q} are non-adjacent. Clearly, if two walks of the same length are non-adjacent, they avoid each other. For a walk $\mathcal{P} = p_1, p_2, \dots, p_\ell$ and some $1 \leq i \leq j \leq \ell$, we define the *p_i - p_j -subwalk* of \mathcal{P} , denoted by $\mathcal{P}[p_i, p_j]$, as $\mathcal{P}[p_i, p_j] := p_i, p_{i+1}, \dots, p_{j-1}, p_j$. (Note that the vertices p_i and p_j might appear on \mathcal{P} more than once, then $\mathcal{P}[p_i, p_j]$ can be chosen arbitrarily.) For a set \mathbb{P} of walks of equal length, we define the set $\mathbb{P}^{(i)} = \{v : v \text{ is the } i\text{-th vertex of some } \mathcal{P} \in \mathbb{P}\}$.

3.1.1 Special edge asteroids.

Let us consider a special edge asteroid (A_X, A_Y) , where $A_X = \{u_0, \dots, u_{2k}\} \subseteq X$ and $A_Y = \{v_0, \dots, v_{2k}\} \subseteq Y$. We use the notation from [Definition 4](#).

Observe that $\{u_0v_0, u_1v_1, u_{k+1}v_{k+1}\}$ is an independent set of edges. Note that for $i \in \{0, \dots, 2k\}$, there might be many ways to choose $\mathcal{W}_{i,i+1}$. We will select the actual path in the following way. First, among all possible paths that satisfy the conditions in the definition, we will only consider shortest ones (note that in particular they are induced). Second, if only possible, we will restrict our considerations to paths containing v_i . Finally, among all paths that are still in consideration, we will select one that contains v_{i+1} , if possible.

In the following observation we show that edge asteroid is symmetric with respect to bipartition of H .

Lemma 14. *Consider $A_X = \{u_0, \dots, u_{2k}\} \subseteq X$ and $A_Y = \{v_0, \dots, v_{2k}\} \subseteq Y$, such that (A_X, A_Y) is a special edge asteroid. Let paths $\{\mathcal{W}_{i,i+1}\}_{i=0}^{2k}$ be chosen as described above. Then for each $i \in \{0, \dots, 2k\}$ there exists an induced v_i - v_{i+1} -path $\mathcal{W}'_{i,i+1}$, such that*

- (a) *there are no edges between $\{u_i, v_i\}$ and $\{u_{i+k}, u_{i+k+1}\} \cup \mathcal{W}'_{i+k,i+k+1}$,*
- (b) *there are no edges between $\{u_0, v_0\}$ and $\{u_1, \dots, u_{2k}\} \cup \bigcup_{i=1}^{2k-1} \mathcal{W}'_{i,i+1}$.*

Furthermore $A_X \cup A_Y \cup \bigcup_{i=0}^{2k} \mathcal{W}_{i,i+1} = A_X \cup A_Y \cup \bigcup_{i=0}^{2k} \mathcal{W}'_{i,i+1}$.

Proof. Let $i \in \{0, \dots, 2k\}$. We obtain $\mathcal{W}'_{i,i+1}$ by modifying the endpoints of $\mathcal{W}_{i,i+1}$ as follows. If v_i (respectively v_{i+1}) already belongs to $\mathcal{W}_{i,i+1}$, then it must be the second (resp. last but one) vertex of $\mathcal{W}_{i,i+1}$, as this path is induced. Thus we remove u_i (resp. u_{i+1}). In the other case, if v_i (resp. v_{i+1}) does not appear on $\mathcal{W}_{i,i+1}$, we append it as the first (resp. last) vertex. Clearly such constructed $\mathcal{W}'_{i,i+1}$ is a v_i - v_{i+1} -path. Moreover, since $\mathcal{W}'_{i,i+1} \subseteq \mathcal{W}_{i,i+1} \cup \{v_i, v_{i+1}\}$, conditions (a) and (b) are satisfied by the definition of $\mathcal{W}_{i,i+1}$. Moreover, note that $A_X \cup A_Y \cup \bigcup_{i=0}^{2k} \mathcal{W}_{i,i+1} = A_X \cup A_Y \cup \bigcup_{i=0}^{2k} \mathcal{W}'_{i,i+1}$.

So we only need to argue that $\mathcal{W}'_{i,i+1}$ is an induced path. Clearly, if we only removed vertices u_i or u_{i+1} from $\mathcal{W}_{i,i+1}$, then $\mathcal{W}'_{i,i+1}$ is induced since $\mathcal{W}_{i,i+1}$ is. So suppose that v_i does not appear on $\mathcal{W}_{i,i+1}$, but is adjacent to some vertex of $\mathcal{W}_{i,i+1}$, other than u_i . It is straightforward to verify that in this case we could have chosen a shorter path $\mathcal{W}_{i,i+1}$, or one that is equally long, but contains v_i , which contradicts the choice of $\mathcal{W}_{i,i+1}$. The case if v_{i+1} does not appear in $\mathcal{W}_{i,i+1}$ is analogous. \square

Note that [Lemma 14](#) implies that if (A_X, A_Y) is a special edge asteroid, then so is (A_Y, A_X) . For (A_X, A_Y) and paths $\{\mathcal{W}_{i,i+1}\}_{i=0}^{2k}$ defined as above, we define the *asteroidal subgraph* \mathbb{O} to be the subgraph of H induced by $A_X \cup A_Y \cup \bigcup_{i=0}^{2k} \mathcal{W}_{i,i+1}$. To restore the symmetry of (A_X, A_Y) and (A_Y, A_X) , we will only require that walks $\{\mathcal{W}_{i,i+1}\}_{i=0}^{2k}$ and $\{\mathcal{W}'_{i,i+1}\}_{i=0}^{2k}$ are induced. Observe that by [Lemma 14](#), if \mathbb{O} is the asteroidal subgraph for (A_X, A_Y) , it is also the asteroidal subgraph for (A_Y, A_X) . Therefore, whenever we find in H an asteroidal subgraph, we can freely choose the appropriate special edge asteroid, usually we will do it implicitly. Also, we will always use the notation introduced above. In an asteroidal subgraph, in natural way we will treat paths $\mathcal{W}_{i,i+1}$ and $\mathcal{W}'_{i,i+1}$ as walks. Moreover, for each valid i we define $\mathcal{W}_{i+1,i} := \overline{\mathcal{W}_{i,i+1}}$.

3.1.2 Obstructions.

An induced subgraph \mathbb{O} of H is an *obstruction* if it is isomorphic to C_6 or C_8 , or it is an asteroidal subgraph. Note that each induced cycle with at least 10 vertices contains a special edge asteroid. Therefore we can restate [Theorem 10](#) in the following way, which will be more useful for us.

Corollary 15. *Let H be a bipartite graph, which is not the complement of a circular-arc graph. Then H contains an obstruction as an induced subgraph.*

Let us show basic properties of obstructions. We denote the consecutive vertices of the cycle C_k by w_1, w_2, \dots, w_k (with $w_1 w_k \in E(C_k)$). For special edge asteroids, we use the notation from [Definition 4](#).

Definition 6 ($C(\mathbb{O})$). For an obstruction \mathbb{O} , we define

$$C(\mathbb{O}) := \begin{cases} \{(w_1, w_5), (w_2, w_4)\} & \text{if } \mathbb{O} \text{ is isomorphic to } C_6, \\ \{(w_1, w_5), (w_2, w_6)\} & \text{if } \mathbb{O} \text{ is isomorphic to } C_8, \\ \{(u_0, u_1), (v_0, v_1)\} & \text{if } \mathbb{O} \text{ is an asteroidal subgraph.} \end{cases}$$

For a pair $(\alpha, \beta) \in C(\mathbb{O})$ we define (α', β') to be the other element of $C(\mathbb{O})$. Due to the symmetry of cycles and [Lemma 14](#), we will be able to assume symmetry between the elements of $C(\mathbb{O})$, i.e., the properties of (α, β) that we will require will also be satisfied for (α', β') . Thus in proofs it will usually be sufficient to consider one pair in $C(\mathbb{O})$, as the proof for the other one will be analogous.

In the following two observations we show the existence of some useful walks in \mathbb{O} .

Observation 16. *Let \mathbb{O} be an obstruction in H and let $C(\mathbb{O}) = \{(\alpha, \beta), (\alpha', \beta')\}$. Then for every pair of vertices x, y of \mathbb{O} , such that $x, y \notin N[\alpha, \alpha']$, there exists an x - y -walk $\mathcal{W}[x, y]$, using only vertices of \mathbb{O} , which is non-adjacent to $\{\alpha, \alpha'\}$.*

Proof. It is straightforward to observe that the graph $\mathbb{O} - N[\alpha, \alpha']$ is still connected, so the existence of claimed walks follows easily. The notation is justified by interpreting these walks in the case when \mathbb{O} is an asteroidal subgraph as subwalks of

$$\mathcal{W} := \mathcal{W}_{0,1}[p, u_1] \circ u_1, v_1, u_1 \circ \mathcal{W}_{1,2} \circ u_2, v_2, u_2 \circ \mathcal{W}_{2,3} \circ \dots \circ \mathcal{W}_{2k-1,2k} \circ u_{2k}, v_{2k}, u_{2k} \circ \mathcal{W}_{2k,0}[u_{2k}, q],$$

where p and q are, respectively, the first vertex of $\mathcal{W}_{0,1}$, which is not in $N[u_0, v_0]$, and the last vertex of $\mathcal{W}_{2k,0}$, which is not in $N[u_0, v_0]$. \square

Observation 17. *Let H be a bipartite graph with an obstruction \mathbb{O} , let $(\alpha, \beta) \in C(\mathbb{O})$.*

- (a) *There exist walks $\mathcal{X}, \mathcal{X}' : \alpha \rightarrow \beta$ and $\mathcal{Y}, \mathcal{Y}' : \beta \rightarrow \alpha$, such that \mathcal{X} avoids \mathcal{Y} and \mathcal{Y}' avoids \mathcal{X}' .*
- (b) *If \mathbb{O} is an asteroidal subgraph, let γ be the vertex in $\{u_{k+1}, v_{k+1}\}$ in the same bipartition class as α, β , and let $c \in \{\alpha, \beta, \gamma\}$. Then for any a, b , such that $\{a, b, c\} = \{\alpha, \beta, \gamma\}$, there exist walks $\mathcal{X}_c : \alpha \rightarrow a$ and $\mathcal{Y}_c : \alpha \rightarrow b$, and $\mathcal{Z}_c : \beta \rightarrow c$, such that $\mathcal{X}_c, \mathcal{Y}_c$ avoid \mathcal{Z}_c and \mathcal{Z}_c avoids $\mathcal{X}_c, \mathcal{Y}_c$.*

All walks use only vertices of \mathbb{O} .

Proof. Let us start with proving (a) in the case if \mathbb{O} is either isomorphic to C_6 or to C_8 , recall that consecutive vertices of such a cycle are denoted by w_1, w_2, \dots . We can also assume that $\alpha = w_1$ and $\beta = w_5$, as the other case is symmetric.

If $\mathbb{O} \simeq C_6$, we set

$$\begin{aligned} \mathcal{X} &:= w_1, w_6, w_5, w_4, w_5 & \mathcal{X}' &:= w_1, w_2, w_3, w_4, w_5, \\ \mathcal{Y} &:= w_5, w_4, w_3, w_2, w_1 & \mathcal{Y}' &:= w_5, w_6, w_1, w_2, w_1. \end{aligned}$$

If $\mathbb{O} \simeq C_8$, we set

$$\begin{aligned}\mathcal{X} = \mathcal{X}' &:= w_1, w_2, w_3, w_4, w_5, \\ \mathcal{Y} = \mathcal{Y}' &:= w_5, w_6, w_7, w_8, w_1.\end{aligned}$$

It is straightforward to verify that these walks satisfy the statement (a).

So from now on let us consider the case that \mathbb{O} is an asteroidal subgraph, and, by symmetry, assume that $\alpha = u_0$ and $\beta = u_1$. Then $\gamma = u_{k+1}$. Before we proceed to the proof of (a), let us define three auxiliary walks $\mathcal{A} : u_0 \rightarrow u_0$, $\mathcal{B} : u_0 \rightarrow u_{k+1}$, and $\mathcal{C} : u_1 \rightarrow u_1$, as follows.

$$\begin{aligned}\mathcal{A} &:= \mathcal{U}_0 \quad \circ \mathcal{U}_0 \quad \circ \mathcal{U}_0 \quad \circ \mathcal{U}_0 \quad \circ \dots \circ \mathcal{U}_0 \quad \circ \mathcal{U}_0, \\ \mathcal{B} &:= \mathcal{U}_0 \quad \circ \mathcal{W}_{0,2k} \circ \mathcal{U}_{2k} \quad \circ \mathcal{W}_{2k,2k-1} \circ \dots \circ \mathcal{U}_{k+2} \circ \mathcal{W}_{k+2,k+1}, \\ \mathcal{C} &:= \mathcal{W}[u_1, u_k] \circ \mathcal{U}_k \quad \circ \mathcal{W}_{k,k-1} \circ \mathcal{U}_{k-1} \quad \circ \dots \circ \mathcal{W}_{2,1} \circ \mathcal{U}_1,\end{aligned}$$

where $\mathcal{W}[u_1, u_k]$ is obtained from [Observation 16](#) and by \mathcal{U}_i we mean a walk $u_i, v_i, \dots, v_i, u_i$ of the appropriate length. Note that here we abuse the notation slightly, as the length of each \mathcal{U}_i might be different. By [Definition 4](#), we have that \mathcal{U}_i and $\mathcal{W}_{i+k, i+k+1}$ are non-adjacent, and so are sets $\{u_0, v_0\}$ and $\{v_1, \dots, v_{2k}\} \cup \bigcup_{i=1}^{2k-1} \mathcal{W}_{i, i+1}$. So it is straightforward to observe that \mathcal{A}, \mathcal{B} avoid \mathcal{C} and \mathcal{C} avoids \mathcal{A}, \mathcal{B} .

In order to prove (a), we define

$$\begin{aligned}\mathcal{X} = \mathcal{X}' &:= \mathcal{B} \circ \mathcal{U}_{k+1} \circ \mathcal{W}[u_{k+1}, u_1], \\ \mathcal{Y} = \mathcal{Y}' &:= \mathcal{C} \circ \mathcal{W}_{1,0} \circ \mathcal{U}_0,\end{aligned}$$

where $\mathcal{W}[u_{k+1}, u_1]$ is given by [Observation 16](#), and \mathcal{U}_i is defined as previously. Observe that these walks avoid each other because \mathcal{B} and \mathcal{C} avoid each other, the walk $\mathcal{W}_{1,0}$ is non-adjacent to $\{u_{k+1}, v_{k+1}\}$, and $\mathcal{W}[u_{k+1}, u_1]$ is non-adjacent to $\{u_0, v_0\}$ by [Observation 16](#).

Now let us show (b). Consider three cases. If $c = u_0$, then by symmetry assume that $a = u_1, b = u_{k+1}$, and define

$$\begin{aligned}\mathcal{X}_c &:= \mathcal{X} \circ \mathcal{U}_1, \\ \mathcal{Y}_c &:= \mathcal{X} \circ \mathcal{W}[u_1, u_{k+1}], \\ \mathcal{Z}_c &:= \mathcal{Y} \circ \mathcal{U}_0,\end{aligned}$$

where walks \mathcal{X}, \mathcal{Y} are given by statement (a) and $\mathcal{W}[u_1, u_{k+1}]$ is given by [Observation 16](#). Note that in case of asteroidal subgraph we have $\mathcal{X} = \mathcal{X}'$ and $\mathcal{Y} = \mathcal{Y}'$, and therefore \mathcal{X}, \mathcal{Y} avoid each other.

If $c = u_1$, then assume that $a = u_0, b = u_{k+1}$ and can observe that our auxiliary walks $\mathcal{A}, \mathcal{B}, \mathcal{C}$ already satisfy the statement of the lemma. Indeed, is it sufficient to set

$$\mathcal{X}_c := \mathcal{A}, \quad \mathcal{Y}_c := \mathcal{B}, \quad \mathcal{Z}_c := \mathcal{C}.$$

Finally, for $c = u_{k+1}$ and $a = u_0, b = u_1$, we can define

$$\begin{aligned}\mathcal{X}_c &:= \mathcal{U}_0 \quad \circ \mathcal{U}_0, \\ \mathcal{Y}_c &:= \mathcal{U}_0 \quad \circ \mathcal{W}_{0,1}, \\ \mathcal{Z}_c &:= \mathcal{W}[u_1, u_{k+1}] \circ \mathcal{U}_{k+1},\end{aligned}$$

where $\mathcal{W}[u_1, u_{k+1}]$ is given by [Observation 16](#). This completes the proof. \square

3.2 Main ingredients

In order to prove [Theorem 11](#) we will use several gadgets.

3.2.1 Building gadgets from walks.

First, let us show how we will use walks to create gadgets. For a set $\mathbb{D} = \{\mathcal{D}_i\}_{i=1}^k$ of walks of equal length $\ell \geq 1$, let $P(\mathbb{D})$ be a path with $\ell + 1$ vertices $p_1, \dots, p_{\ell+1}$, such that the list of p_i is $\mathbb{D}^{(i)}$, i.e., the set of i -th vertices of walks in \mathbb{D} . The vertex p_1 will be called the *input vertex* and $p_{\ell+1}$ will be called the *output vertex*.

Lemma 18. *Let $\mathbb{D} = \{\mathcal{D}_i\}_{i=1}^k$ be a set of walks of equal length $\ell \geq 1$, such that \mathcal{D}_i is an s_i - t_i -walk. Let A, B be a partition of \mathbb{D} into two non-empty sets. Moreover, for $C \in \{A, B\}$, define $S(C) = \{s_i : \mathcal{D}_i \in C\}$ and $T(C) = \{t_i : \mathcal{D}_i \in C\}$. Suppose that $S(A) \cap S(B) = \emptyset$ and $T(A) \cap T(B) = \emptyset$, and every walk in A avoids every walk in B . Then $P(\mathbb{D})$ with the input vertex x and the output vertex y has the following properties:*

- (a) $L(x) = S(A) \cup S(B)$ and $L(y) = T(A) \cup T(B)$,
- (b) for every $i \in [k]$ there is a list homomorphism $f_i : P(\mathbb{D}) \rightarrow H$, such that $f_i(x) = s_i$ and $f_i(y) = t_i$,
- (c) for every $f : P(\mathbb{D}) \rightarrow H$, if $f(x) \in S(A)$, then $f(y) \notin T(B)$.

Furthermore, if every walk in B avoids every walk in A , we additionally have

- (d) for every $f : P(\mathbb{D}) \rightarrow H$, if $f(x) \in S(B)$, then $f(y) \notin T(A)$.

Proof. For $i \in [k]$, let d_j^i denote the j -th vertex of \mathcal{D}_i , and denote consecutive vertices of $P(\mathbb{D})$ by $x = p_1, p_2, \dots, p_{\ell+1} = y$. The statement (a) follows directly from the definition of lists in $P(\mathbb{D})$. For (b), consider any $i \in [k]$ and define $f_i(p_j) := d_j^i$ for $j \in [\ell + 1]$. Observe that f_i is indeed a list homomorphism $P(\mathbb{D}) \rightarrow H$ since for every edge $p_j p_{j+1}$ of $P(\mathbb{D})$ it holds that $f_i(p_j)$ and $f_i(p_{j+1})$ are consecutive vertices d_j^i and d_{j+1}^i of the walk \mathcal{D}_i and thus they are adjacent in H . Moreover, clearly $f_i(x) = s_i$ and $f_i(y) = t_i$.

To show (c), suppose there exists a list homomorphism $f : P(\mathbb{D}) \rightarrow H$ such that $f(p_1) \in S(A)$ and $f(p_{\ell+1}) \in T(B)$. Let $i \in [\ell + 1]$ be the minimum integer such that there exists a walk \mathcal{D}_r in B with $f(p_i) = d_i^r$. Note that it exists since $f(p_{\ell+1}) \in T(B)$. Moreover, $i > 1$ since $f(p_1) \in S(A)$ and $S(A) \cap S(B) = \emptyset$. By minimality of i we have that $f(p_{i-1}) = d_{i-1}^s$ for some $\mathcal{D}_s \in A$. Thus there is a walk $\mathcal{D}_s \in A$ and a walk $\mathcal{D}_r \in B$, such that \mathcal{D}_s does not avoid \mathcal{D}_r , a contradiction. Similarly, we can show the property (d) by switching the roles of A and B . \square

For two gadgets $P = P(\mathbb{D})$ and $P' = P(\mathbb{D}')$, such that the list of the output vertex of P is the same as the list of the input vertex of P' , the *composition* of P and P' is gadget P'' obtained by identifying the output vertex of P and the input vertex of P' . The input and the output vertex of P'' are, respectively, the input vertex of P and the output vertex of P' .

3.2.2 Expressing basic relations.

Let H be an undecomposable, bipartite graph with an obstruction \mathbb{O} . We will show that the structure of \mathbb{O} is sufficiently rich to express some basic relations.

For a k -ary relation $R_k \subseteq V(H)^k$, by an R_k -gadget we mean a graph F with H -lists L and k specified vertices v_1, v_2, \dots, v_k , called *interface*, such that for every $i \in [k]$ it holds that

$$\{f(v_1)f(v_2)\dots f(v_k) \mid f : (F, L) \rightarrow H\} = R_k.$$

In other words, the set of all possible colorings of the interface vertices that can be extended to a list H -coloring of the whole gadget is precisely the relation we are expressing. In the definition of an R_k -gadget we do not insist that interface vertices are pairwise different.

Let $(\alpha, \beta) \in C(\mathbb{O})$. To make the definitions more intuitive, let us assign logic values to vertices α, β in the following way: α will be interpreted as false, and β will be interpreted as true. First, we need to express a k -ary relation $\text{OR}_k = \{\alpha, \beta\}^k - \{\alpha^k\}$ and a binary relation $\text{NAND}_2 = \{\alpha\alpha, \alpha\beta, \beta\alpha\}$. Note that the relations OR_k and NAND_2 are symmetric with respect to interface vertices.

Lemma 19. *Let H be a bipartite graph with an obstruction \mathbb{O} and let $(\alpha, \beta) \in C(\mathbb{O})$. For every $k \geq 2$ there exists an OR_k -gadget, and a NAND_2 -gadget.*

Proof. First, notice that for any $k \geq 3$, the relation OR_k can be expressed using a binary relation $\text{NEQ} = \{\alpha\beta, \beta\alpha\}$ and ternary OR_3 . Indeed, note that an OR_k -gadget with interface vertices x_1, x_2, \dots, x_k can be easily constructed by introducing an OR_{k-1} -gadget with interface vertices $x_1, x_2, \dots, x_{k-2}, y$, an OR_3 -gadget with interface vertices y', x_{k-1}, x_k , and a NEQ -gadget with interface vertices y, y' (this corresponds to the textbook NP-hardness reduction from SAT to 3-SAT [27, Sec. 3.1.1.]).

Let $\mathcal{X}, \mathcal{Y}, \mathcal{X}', \mathcal{Y}'$ be the walks given by [Observation 17](#). Let $P(\{\mathcal{X}, \mathcal{Y}\})$ be the path obtained by applying [Lemma 18](#) for $A = \{\mathcal{X}\}$ and $B = \{\mathcal{Y}\}$, and let $P(\{\mathcal{X}', \mathcal{Y}'\})$ be the path obtained by applying [Lemma 18](#) for $A = \{\mathcal{Y}'\}$ and $B = \{\mathcal{X}'\}$. It is straightforward to observe that the graph obtained by identifying the first vertex of $P(\{\mathcal{X}, \mathcal{Y}\})$ with the first vertex of $P(\{\mathcal{X}', \mathcal{Y}'\})$, and the last vertex of $P(\{\mathcal{X}, \mathcal{Y}\})$ with the last vertex of $P(\{\mathcal{X}', \mathcal{Y}'\})$, is a NEQ -gadget (whose interface are the identified vertices). So, in order to prove the lemma, we need to build gadgets for binary relations OR_2 , NAND_2 , and the ternary relation OR_3 .

Observe that an OR_2 -gadget can be obtained by identifying two of three interface vertices of an OR_3 -gadget. Thus it is sufficient to show how to construct an OR_3 -gadget and a NAND_2 -gadget. Let us first focus on constructing OR_3 .

By symmetry of \mathbb{O} , we can assume that $\alpha = w_1, \beta = w_5$ if \mathbb{O} is either an induced 6-cycle or an induced 8-cycle, or $\alpha = u_0, \beta = u_1$ if \mathbb{O} is an asteroidal subgraph. Set $\gamma = w_3$ in the former case, or $\gamma = u_{k+1}$ in the latter one.

The high-level idea is to construct, for every triple a, b, c , such that $\{a, b, c\} = \{\alpha, \beta, \gamma\}$, an $R(c)$ -gadget for the relation $R(c) = \{\alpha a, \alpha b, \beta \alpha, \beta \beta, \beta \gamma\}$. This gadget will be called P_c , and its interface vertices will be x and y , where $L(x) = \{\alpha, \beta\}$ and $L(y) = \{\alpha, \beta, \gamma\}$.

Suppose we have constructed graphs P_α, P_β , and P_γ . Let x_1, x_2, x_3 , respectively, be their x -vertices. Consider a graph G obtained by identifying the y -vertices of P_α, P_β , and P_γ to a single vertex y . The lists of vertices remain unchanged, note that all y -vertices have the same list $\{\alpha, \beta, \gamma\}$, so identifying the vertices does not cause any conflict here. Obviously we have $L(x_1) = L(x_2) = L(x_3) = \{\alpha, \beta\}$.

Observe it is not possible to map all x_1, x_2, x_3 to α . However, every triple of colors from $\{\alpha, \beta\}^3 - \{\alpha\alpha\alpha\}$ might appear on vertices x_1, x_2, x_3 in some list homomorphism from G to H . Thus the graph G satisfies the definition of an OR_3 -gadget, whose interface vertices are x_1, x_2, x_3 . So let us show how to construct P_c for every $c \in \{\alpha, \beta, \gamma\}$.

If \mathbb{O} is isomorphic to C_6 or C_8 , then the construction is straightforward and it is shown on [Figure 1](#) (the picture shows OR_3 -gadgets, with y -vertices of P_c 's already identified). For the case if \mathbb{O} is an asteroidal subgraph, the construction will be quite similar, but a bit more involved.

First, let us build an auxiliary gadget. Recall walks $\mathcal{W}[u_1, u_{k+1}]$ and $\mathcal{W}[u_{k+1}, u_1]$ given by [Observation 16](#),

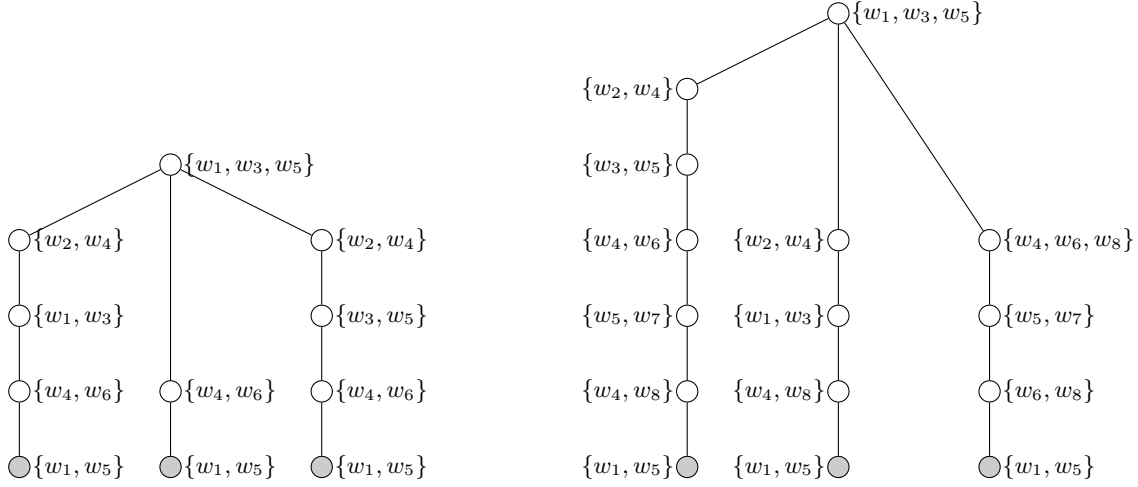

Figure 1: An OR_3 -gadget for $\mathbb{O} \simeq C_6$ (left) and for $\mathbb{O} \simeq C_8$ (right). Recall that the consecutive vertices of \mathbb{O} are denoted by (w_1, w_2, \dots) . The sets next to vertices indicate lists. Interface vertices are marked gray.

and consider the following walks of equal length:

$$\begin{aligned} \mathcal{A} &:= u_0, v_0, \dots, u_0 \circ u_0, v_0, \dots, u_0, \\ \mathcal{B}_1 &:= \mathcal{W}[u_1, u_{k+1}] \circ \mathcal{W}[u_{k+1}, u_1], \\ \mathcal{B}_2 &:= \mathcal{W}[u_1, u_{k+1}] \circ u_{k+1}, v_{k+1}, \dots, u_{k+1}. \end{aligned}$$

Note that \mathcal{A} is non-adjacent to $\mathcal{B}_1, \mathcal{B}_2$. Moreover, define

$$\begin{aligned} \mathcal{A}_1 &:= u_0, v_0, \dots, u_0, && \circ u_0, v_0, \dots, u_0, \\ \mathcal{A}_2 &:= \mathcal{W}_{1,0} && \circ u_0, v_0, \dots, u_0, \\ \mathcal{B} &:= u_{k+1}, v_{k+1}, \dots, u_{k+1} \circ \mathcal{W}[u_{k+1}, u_1], \end{aligned}$$

and note that $\mathcal{A}_1, \mathcal{A}_2$ are non-adjacent to \mathcal{B} . Thus, by [Lemma 18](#) we obtain that the graph F , which is a composition of $P(\{\mathcal{A}, \mathcal{B}_1, \mathcal{B}_2\})$ and $P(\{\mathcal{A}_1, \mathcal{A}_2, \mathcal{B}\})$, is a $\{u_0 u_0, u_1 u_0, u_1 u_1\}$ -gadget.

Now, suppose we are given a, b, c , such that $\{a, b, c\} = \{u_0, u_1, u_{k+1}\}$. Let $\mathcal{X}_c : u_0 \rightarrow a$, $\mathcal{Y}_c : u_0 \rightarrow b$, and $\mathcal{Z}_c : u_1 \rightarrow c$ be the walks given by [Observation 17](#), recall that $\mathcal{X}_c, \mathcal{Y}_c$ avoid \mathcal{Z}_c and \mathcal{Z}_c avoids $\mathcal{X}_c, \mathcal{Y}_c$. Consider the graph $P(\{\mathcal{X}_c, \mathcal{Y}_c, \mathcal{Z}_c\})$, obtained by applying [Lemma 18](#) for $A = \{\mathcal{X}_c, \mathcal{Y}_c\}$ and $B = \{\mathcal{Z}_c\}$ and recall that it is a $\{u_0 a, u_0 b, u_1 c\}$ -gadget. Now it is straightforward to observe that the composition of F and $P(\{\mathcal{X}_c, \mathcal{Y}_c, \mathcal{Z}_c\})$ is an $R(c)$ -gadget P_c (see [Figure 2](#)). This concludes the construction of the OR_3 -gadget.

Finally, observe that NAND_2 can be obtained by composition of a NEQ -gadget, an OR_2 -gadget (with one interface vertex as input and the other one as output), and a NEQ -gadget. \square

3.2.3 Distinguisher gadget.

Now let us introduce another gadget, which will be the main tool used in our hardness proof.

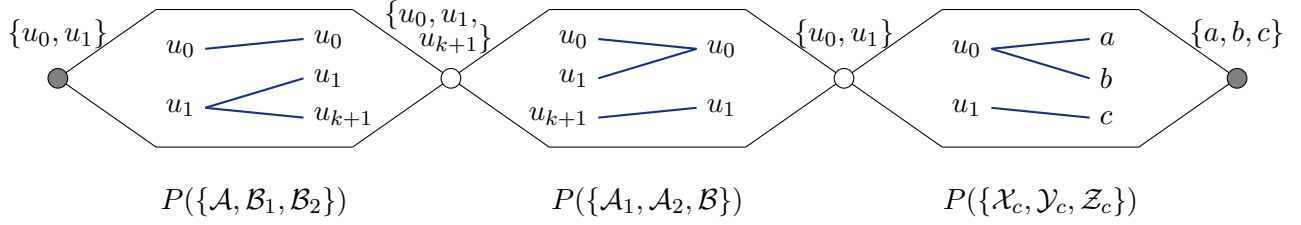

Figure 2: The $R(c)$ -gadget P_c as a composition of gadgets $P(\{\mathcal{A}, \mathcal{B}_1, \mathcal{B}_2\})$, $P(\{\mathcal{A}_1, \mathcal{A}_2, \mathcal{B}\})$, and $P(\{\mathcal{X}_c, \mathcal{Y}_c, \mathcal{Z}_c\})$. Blue lines denote possible mappings of a pairs of colors that might appear in the input and the output vertex of each gadget.

Definition 7 (Distinguisher). Let S be an incomparable set in H and let $(\alpha, \beta) \in C(\mathbb{O})$, such that $\{\alpha, \beta\} \cup S$ is contained in one bipartition class of H . Let $a, b \in S$. A *distinguisher* gadget is a graph $D_{a/b}$ with two specified vertices x (called *input*) and y (called *output*), and H -lists L such that:

- (D1.) $L(x) = S$ and $L(y) = \{\alpha, \beta\}$,
- (D2.) there is a list homomorphism $\varphi_a : (D_{a/b}, L) \rightarrow H$, such that $\varphi_a(x) = a$ and $\varphi_a(y) = \alpha$,
- (D3.) there is a list homomorphism $\varphi_b : (D_{a/b}, L) \rightarrow H$, such that $\varphi_b(x) = b$ and $\varphi_b(y) = \beta$,
- (D4.) for any $c \in S - \{a, b\}$ there is $\varphi_c : (D_{a/b}, L) \rightarrow H$, such that $\varphi_c(x) = c$ and $\varphi_c(y) \in \{\alpha, \beta\}$,
- (D5.) there is no list homomorphism $\varphi : (D_{a/b}, L) \rightarrow H$, such that $\varphi(x) = a$ and $\varphi(y) = \beta$.

Distinguisher gadgets will be constructed using the following lemma, whose proof is postponed to Section 3.4.

Lemma 27. Let H be a connected, bipartite, undecomposable graph, let \mathbb{O} be an obstruction in H and let $(\alpha, \beta) \in C(\mathbb{O})$. Let S be an incomparable set of $k \geq 2$ vertices of H , contained in the same bipartition class as α, β . Let a and b be two distinct vertices of S . For each $v \in S$ there exists a walk \mathcal{D}_v , of length at least two, satisfying the following properties:

- (1) for each $v \in S$, \mathcal{D}_v is a v - α -walk or a v - β -walk,
- (2) \mathcal{D}_a is an a - α -walk and \mathcal{D}_b is a b - β -walk,
- (3) for each $u, v \in S$, such that $\mathcal{D}_u : u \rightarrow \alpha$ and $\mathcal{D}_v : v \rightarrow \beta$, we have that \mathcal{D}_u avoids \mathcal{D}_v .

In particular, all walks have equal length.

By Lemma 18, the existence of distinguisher gadgets follows directly from Lemma 27 applied for A being the set of walks terminating at α , and B being the set of walks terminating at β .

Corollary 20. Let H be an undecomposable bipartite graph with an obstruction \mathbb{O} and let $(\alpha, \beta) \in C(\mathbb{O})$. Let S be an incomparable set in H contained in the same bipartition class as α, β , such that $|S| \geq 2$. Then for every pair (a, b) of distinct elements of S there exists a distinguisher $D_{a/b}$. \square

3.3 Hardness reduction

Suppose we are able to construct all gadgets mentioned above. The following lemma shows how to construct the main gadget, which will encode the inequality relation on an incomparable set S . Formally, by $\text{NEQ}(S) \subseteq S^2$ we denote the relation on S^2 , such that $ss' \in \text{NEQ}(S)$ if and only if $s \neq s'$.

Lemma 4 (Constructing a $\text{NEQ}(S)$ -gadget). Let H be a connected, bipartite, undecomposable graph, whose complement is not a circular-arc graph. Let S be an incomparable set of $k \geq 2$ vertices of H , contained in one

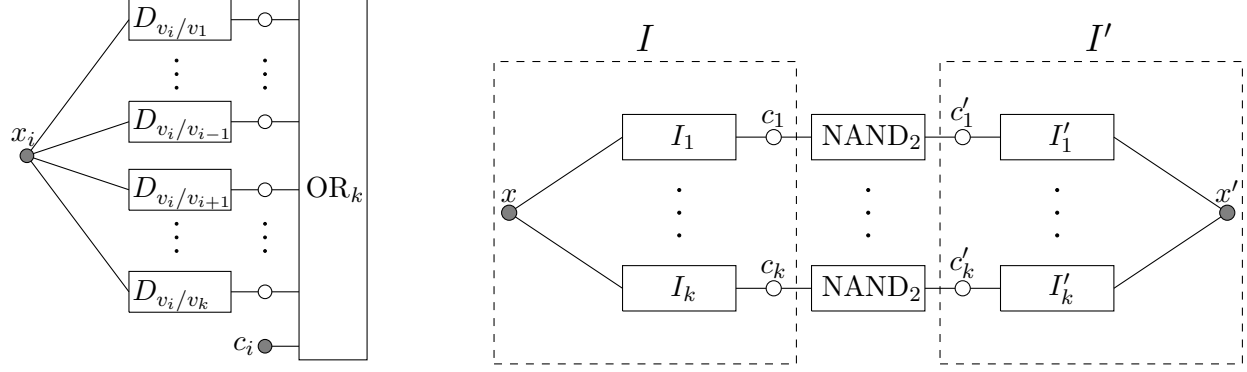

Figure 3: The graph I_i with special vertices x_i and c_i (left) and $\text{NEQ}(S)$ -gadget with interface vertices x, x' (right).

bipartition class. Then there exists a $\text{NEQ}(S)$ -gadget, i.e., a graph F with H -lists L and two special vertices $x, x' \in V(F)$, such that $L(x) = L(x') = S$ and

- *for any list homomorphism $h : (F, L) \rightarrow H$, it holds that $h(x) \neq h(x')$,*
- *for any distinct $s, s' \in S$ there is a list homomorphism $h : (F, L) \rightarrow H$, such that $h(x) = s$ and $h(x') = s'$.*

Proof. Let \odot be an obstruction in H and consider $(\alpha, \beta) \in C(\odot)$, such that α, β and the elements of S are in the same bipartition class of H . We denote the vertices of S by v_1, v_2, \dots, v_k . We will construct our gadget in three steps.

Step I. In this step we will show that for every $i \in [k]$ we can construct a graph I_i with two special vertices x_i and c_i and H -lists L , satisfying the following properties.

- $L(x_i) = S$ and $L(c_i) = \{\alpha, \beta\}$,
- for every list homomorphism $\varphi : (I_i, L) \rightarrow H$, if $\varphi(x_i) = v_i$, then $\varphi(c_i) = \beta$,
- for every $j \neq i$ there exists a list homomorphism $\varphi_j : (I_i, L) \rightarrow H$ such that $\varphi_j(x_i) = v_j$ and $\varphi_j(c_i) = \alpha$.

Let us fix any $i \in [k]$. For every $j \in [k] - \{i\}$ we call [Corollary 20](#) for $S, (\alpha, \beta)$, and $a = v_i, b = v_j$ to construct a distinguisher gadget D_{v_i/v_j} with the input $x_{i,j}$ and the output $y_{i,j}$. We identify the vertices $x_{i,j}$, for all feasible j , to a single vertex x_i , and introduce a new vertex c_i . Then we use [Lemma 19](#) to construct an OR_k gadget and identify its k interface vertices with distinct elements of $\{c_i\} \cup \{y_{i,j}\}_{j \neq i}$. This completes the construction of I_i (see [Figure 3](#), left).

Recall that the properties of the OR_k -gadget imply that every list homomorphism from I_i to H maps at least one of vertices in $\{c_i\} \cup \{y_{i,j}\}_{j \neq i}$ to β . By the property (D5.) in [Definition 7](#), for any $\varphi : (I_i, L) \rightarrow H$ with $\varphi(x_i) = v_i$, and for every $j \neq i$ it holds that $\varphi(y_{i,j}) = \alpha$. This in turn forces $\varphi(c_i) = \beta$.

On the other hand, by properties (D2.), (D3.), and (D4.), for any $j \neq i$ there is a homomorphism $\varphi_j : (I_i, L) \rightarrow H$, such that $\varphi_j(x_i) = v_j$ and $\varphi_j(y_{i,j}) = \beta$, which allows us to set $\varphi_j(c_i) = \alpha$. So I_i satisfies all desired properties.

Step II. In this step we will construct a graph I with H -lists L and special vertices x, c_1, \dots, c_k , satisfying the following properties.

- $L(x) = S$ and $L(c_i) = \{\alpha, \beta\}$ for every $i \in [k]$,

- for every list homomorphism $\varphi : (I, L) \rightarrow H$, if $\varphi(x) = v_i$, then $\varphi(c_i) = \beta$.
- for every $i \in [k]$ there exists a list homomorphism $\varphi_i : (I, L) \rightarrow H$, such that $\varphi_i(x) = v_i$ and $\varphi_i(c_i) = \beta$, and $\varphi_i(c_j) = \alpha$ for every $j \in [k] - \{i\}$.

The graph I is constructed by introducing k gadgets I_1, \dots, I_k , and identifying the vertices x_1, \dots, x_k into a single vertex x (see Figure 3, right). The desired properties of I follow directly from properties of I_i 's.

Step III. Finally, we can construct a $\text{NEQ}(S)$ -gadget. We introduce two copies of the gadget from the previous step, call them I and I' (we will use primes to denote the appropriate vertices of I'). For each $i \in [k]$, we introduce a NAND_2 -gadget and identify its interface vertices with vertices c_i and c'_i (see Figure 3, right). Let us call such constructed graph F . We claim that F is a $\text{NEQ}(S)$ -gadget, whose interface vertices are x and x' .

Clearly, $L(x) = L(x') = S$. Suppose that $\varphi : (F, L) \rightarrow H$ is a list homomorphism such that $\varphi(x) = \varphi(x') = v_i$. Then, by definition of I , we have $\varphi(c_i) = \varphi(c'_i) = \beta$, but this is impossible due to the properties of the NAND_2 -gadget joining c_i and c'_i .

On the other hand, let us choose any distinct $v_i, v_j \in S$. We can color I according to the homomorphism φ_i , and I' according to the homomorphism φ_j (both φ_i and φ_j are defined in Step II). In particular this means that x is mapped to v_i , x' is mapped to v_j , c_i and c'_j are mapped to β , and all other vertices in $\{c_1, \dots, c_k\} \cup \{c'_1, \dots, c'_k\}$ are mapped to α . Since $i \neq j$, by the definition of a NAND_2 -gadget, we can extend such defined mapping to all vertices of F . This completes the proof of the lemma. \square

Now, equipped with Lemma 4, we can easily prove Theorem 11.

Proof of Theorem 11. Recall that H is an undecomposable bipartite graph, whose complement is not a circular-arc graph. Let S be the largest incomparable set in H , contained in one bipartition class. Let $k = |S|$, i.e., $k = i(H)$.

Observe that since the complement of H is not a circular-arc graph, we have that $k \geq 3$. Indeed, recall that H contains an obstruction, which is either an induced C_6 , an induced C_8 , or an asteroidal subgraph. Observe that all vertices from one bipartition class of C_6 or C_8 form an incomparable set of size at least 3. On the other hand, recall that a special edge asteroid contains at least three independent edges, so their appropriate endvertices form the desired incomparable set.

We reduce from k -COLORING, let G be an instance. Clearly we can assume that G is connected and has at least 3 vertices. We will construct a graph G^* with H -lists L and the following properties:

- $(G^*, L) \rightarrow H$ if and only if G is k -colorable,
- the number of vertices of G^* is at most $g(H) \cdot |E(G)|$ for some function g of H ,
- the pathwidth of G^* is at most $g(H) + \text{pw}(G)$,
- G^* can be constructed in time $(|V(G)|)^{\mathcal{O}(1)} \cdot g'(H)$ for some function g' .

Observe that this will be sufficient to prove the theorem. Indeed, suppose that for some $\varepsilon > 0$ we can solve $\text{LHOM}(H)$ in time $\mathcal{O}^*((k - \varepsilon)^t)$ on instances of pathwidth t . Let us observe that applying this algorithm to G^* gives an algorithm solving the k -COLORING problem on G in time

$$(k - \varepsilon)^{\text{pw}(G^*)} \cdot |V(G^*)|^{\mathcal{O}(1)} \leq (k - \varepsilon)^{\text{pw}(G) + g(H)} \cdot (g(H) \cdot |E(G)|)^{\mathcal{O}(1)} = (k - \varepsilon)^{\text{pw}(G)} \cdot |V(G)|^{\mathcal{O}(1)},$$

where the last step follows since $|H|$ is a constant. Recall that by Theorem 1', the existence of such an algorithm for k -COLORING contradicts the SETH.

We start the construction of G^* with the vertex set of G . The lists of these vertices are set to S . Then, for each edge uv of G , we introduce a copy F_{uv} of the $\text{NEQ}(S)$ -gadget introduced in Lemma 4. We identify

the interface vertices of this gadget with u and v , respectively. This completes the construction of G^* . Let us show that it satisfies the properties (a)–(d).

Note that (a) follows directly from [Lemma 4](#). Indeed, consider an edge uv of G . On one hand, for every list homomorphism $f : (G^*, L) \rightarrow H$ we have that $f(u) \neq f(v)$. On the other hand, mapping u and v to any distinct vertices from S can be extended to a homomorphism of the whole graph F_{uv} .

To show (b), recall that the number of vertices of each F_{uv} depends only on H , let it be $g(H)$. Every original vertex of G belongs to some gadget in G^* , so G^* contains at most $g(H) \cdot |E(G)|$ vertices.

Next, consider a path decomposition \mathcal{T} of G of width $\text{pw}(G)$, let the consecutive bags be X_1, X_2, \dots, X_ℓ . We extend \mathcal{T} to a path decomposition \mathcal{T}^* of G^* as follows: for every edge uv in G we choose one bag X_i such that $u, v \in X_i$, and we add a new bag $X'_i = X_i \cup V(F)$, which becomes the immediate successor of X_i . We repeat this for every edge, making sure that for X_i we can only choose the original bags coming from \mathcal{T} . Note that it might happen that we will insert several new bags in a row, if the same X_i was chosen for different edges, but this is not a problem. Is it straightforward to observe that \mathcal{T}^* is a path decomposition of G^* , and the width of \mathcal{T}^* is at most $g(H) + \text{pw}(G)$. This proves (c).

Finally, it is straightforward to observe that the construction of G^* was performed in time polynomial in G (recall that we treat H as a constant-size graph). \square

3.4 Technical details of [Lemma 27](#)

In this section we show how to construct distinguisher gadgets, which were the main technical tool used in the proof of [Theorem 11](#).

3.4.1 Constructing avoiding walks from incomparable vertices to a specified vertex.

Intuitively, we aim to show that for any two incomparable vertices s, v , and a third vertex t , we can either construct walks from s to t and from v to v , or walks from v to t and from s to s , which satisfy certain avoiding conditions. However, due to some corner cases, the actual statement of the lemma is much more complicated.

Lemma 21. *Let H be a bipartite graph with bipartition classes X and Y . Let $s, v \in X$ be incomparable vertices and let $s' \in N(s) - N(v)$, $v' \in N(v) - N(s)$. Let $S \subseteq N(s, s', v, v')$ be non-empty. Let U be the set of vertices reachable from $\{s, v\}$ in $H - S$. We also assume that H has no decomposition (D, N, R) such that $\{s, v, s', v'\} \subseteq D$ and $S \subseteq N$. Then there is $y \in S$ and $x \in U$ (both in the same bipartition class) and two pairs of walks of length at least one:*

1. $\mathcal{A}, \mathcal{A}' : s \rightarrow y$ and $\mathcal{B}, \mathcal{B}' : v \rightarrow x$, or
2. $\mathcal{A}, \mathcal{A}' : v \rightarrow y$ and $\mathcal{B}, \mathcal{B}' : s \rightarrow x$,

such that \mathcal{A} avoids \mathcal{B} , \mathcal{B}' avoids \mathcal{A}' . Moreover, for every i it holds that $\{\mathcal{A}, \mathcal{B}\}^{(i)} \not\subseteq S$ and all four walks are entirely contained in $S \cup U$.

Furthermore one of the following holds:

- a) $x \in \{v, v'\}$ in case (1.) and $x \in \{s, s'\}$ in case (2.), or
- b) walks $\mathcal{B}, \mathcal{B}'$ are entirely contained in U .

Proof. We split the proof into three cases.

Case 1: There exists $a \in N(s, v)$ and $b \in S_X$ such that $ab \notin E(H)$. By symmetry assume that $a \in N(s)$. If $b \in N(v')$, we set $x = s, y = b$, and define $\mathcal{A} = \mathcal{A}' = v, v', b$ and $\mathcal{B} = s, s', s, \mathcal{B}' = s, a, s$, obtaining walks as in the statement (2.a). On the other hand, if $b \notin N(v')$, then necessarily $b \in N(s')$.

Then we take $x = v, y = b$, and define $\mathcal{A} = \mathcal{A}' = s, s', b$, and $\mathcal{B} = \mathcal{B}' = v, v', v$, which satisfy statement (1.a).

Case 2: There exists $a \in S_Y$ and $b \in N(s', v')$ such that $ab \notin E(H)$. By symmetry assume that $b \in N(s')$. If $a \in N(v)$, then we set $x = s', y = a$, and define $\mathcal{A} = v, a, \mathcal{B} = s, s', \mathcal{A}' = v, v', v, a$, and $\mathcal{B}' = s, s', b, s'$, obtaining statement (2.a). On the other hand, if $a \notin N(v)$, then $a \in N(s)$. In this case we take $x = v', y = a$, and define $\mathcal{A} = \mathcal{A}' = s, a$ and $\mathcal{B} = \mathcal{B}' = v, v'$, obtaining statement (1.a).

Case 3: S is bipartite-complete to $N[s, s', v, v']$. Note that this implies that $H[S]$ is a biclique.

Let K_Y (resp. K_X) be the set of all vertices w in U_Y (resp. U_X) such that there exists $s_w \in S_X$ (resp. S_Y) such that $ws_w \notin E(H)$. Since H has no decomposition (D, N, R) such that $s, v, s', v' \in D$ and $S \subseteq N$, we have that $K := K_X \cup K_Y \neq \emptyset$. Otherwise, U is bipartite-complete to S and there are no edges between U and $H - (S \cup U)$, so $(U, S, V(H) - (S \cup U))$ is a decomposition of H , a contradiction. Moreover, since we are in Case 3, we observe that $K \cap N[s, v, s', v'] = \emptyset$. Let \tilde{S} be a minimal $\{s, s', v, v'\}$ - K -separator in $H[U]$, contained in $N(s, v, s', v')$, and let \tilde{U} be the set of vertices reachable from $\{s, s', v, v'\}$ in $H[U] - \tilde{S}$. Note that $\tilde{U} \cup \tilde{S}$ is bipartite-complete to S .

For contradiction, suppose that the lemma does not hold and H is a counterexample with the minimum number of vertices, i.e., for any graph H' with strictly fewer vertices and any choice of four vertices and a set, satisfying the assumptions of the lemma, the desired walks exist.

Claim 21.1. *The graph $H[U]$, vertices s, s', v, v' , and the set \tilde{S} satisfy the assumptions of the lemma (where the role of S is played by \tilde{S}).*

Proof of Claim. Note that $s, s', v, v' \in U$, which in particular implies that the vertices s, v are incomparable in $H[U]$. Also, the set \tilde{S} is contained in $N(s, s', v, v') \cap U$.

Suppose that $H[U]$ has a decomposition (D, N, R) , where $\{s, s', v, v'\} \subseteq D$ and $\tilde{S} \subseteq N$. Since N is disjoint with K , we know that N is bipartite-complete to S , implying that $S \cup N$ is a biclique.

Hence, D is bipartite-complete to $S \cup N$ and there are no more vertices in H adjacent to D , so we obtained a decomposition $(D, N \cup S, V(H) - (D \cup N \cup S))$ of H , such that $s, s', v, v' \in D$ and $S \subseteq (N \cup S)$, a contradiction. ■

Since $S \neq \emptyset$ and $S \subseteq V(H) - U$, we obtain that $H[U]$ has strictly fewer vertices than H . So, by minimality of H , there exist $\tilde{x} \in \tilde{U}, \tilde{y} \in \tilde{S}$ and one of the following quadruples of walks:

$$\begin{aligned} \mathcal{C}, \mathcal{C}' : s \rightarrow \tilde{y} \quad \text{and} \quad \mathcal{D}, \mathcal{D}' : v \rightarrow \tilde{x} \quad (\text{statement (1.)}), \quad \text{or} \\ \mathcal{C}, \mathcal{C}' : v \rightarrow \tilde{y} \quad \text{and} \quad \mathcal{D}, \mathcal{D}' : s \rightarrow \tilde{x} \quad (\text{statement (2.)}), \end{aligned}$$

where \mathcal{C} avoids \mathcal{D} and \mathcal{D}' avoids \mathcal{C}' .

Let us consider the first situation (statement (1.)), i.e., that we obtained walks $\mathcal{C}, \mathcal{C}' : s \rightarrow \tilde{y}$ and $\mathcal{D}, \mathcal{D}' : v \rightarrow \tilde{x}$ (the other one is symmetric).

By minimality of \tilde{S} there exists a walk $\mathcal{P} : \tilde{y} \rightarrow w$, where $w \in K$ and no vertex from \mathcal{P} except \tilde{y} is in \tilde{S} . This means that no vertex from \mathcal{P} , except for the first vertex, is adjacent to any vertex from \tilde{U} , so, in particular, w is non-adjacent to \tilde{x} . Observe that since $K \cap \tilde{S} = \emptyset$ we must have $|\mathcal{P}| \geq 1$. Let w^\bullet be the last vertex of \mathcal{P}^\dagger (recall that by \mathcal{P}^\dagger we denote the walk \mathcal{P} with the last vertex removed); note that we may have $w^\bullet = \tilde{y}$.

Let \tilde{x}^\bullet be the last vertex of $(\mathcal{D}')^\dagger$. By **Observation 12** applied to $\mathcal{D}', \mathcal{C}'$ we know that \tilde{x}^\bullet is adjacent to \tilde{x} and non-adjacent to \tilde{y} . Moreover, since all vertices of \mathcal{D}' are in $\tilde{U} \cup \tilde{S}$, we note that \tilde{x}^\bullet is adjacent to all vertices from the appropriate bipartition class of S .

Now we will separately consider two subcases, depending whether the call for $H[U]$ resulted in the statement (1.a.) or (1.b.)

Case 3 a): the call for $H[U]$ resulted in the statement (1.a). This means that $\tilde{x} \in \{v, v'\}$ and $\{\mathcal{C}, \mathcal{D}\}^{(i)} \not\subseteq S$ for every i .

If $|\mathcal{P}| = 1$, i.e., $\mathcal{P} = \tilde{y}, w$, then we set $x = \tilde{y}$, $y = s_w$, and define:

$$\begin{aligned} \mathcal{A} &= \mathcal{D}' \circ \tilde{x}, \tilde{x}^\bullet, s_w & \mathcal{A}' &= \mathcal{D} \circ \tilde{x}, \tilde{x}^\bullet, s_w \\ \mathcal{B} &= \mathcal{C}' \circ \tilde{y}, w, \tilde{y} & \mathcal{B}' &= \mathcal{C} \circ \tilde{y}, w, \tilde{y}. \end{aligned} \quad (1)$$

Note that $s_w \in S$ is adjacent to $\tilde{x}^\bullet \in \tilde{U} \cup \tilde{S}$, as in this case $\tilde{y}, \tilde{x}, s_w$ are in one bipartition class, while \tilde{x}^\bullet is in the other one, and $\tilde{U} \cup \tilde{S}$ is bipartite-complete to S . Observe that the walks satisfy the condition in the statement (2.b).

So let us assume that $|\mathcal{P}| > 1$, i.e., $w^\bullet \neq \tilde{y}$. Define \tilde{x}' in a way that $\{\tilde{x}, \tilde{x}'\} = \{v, v'\}$. We define walks

$$\begin{aligned} \mathcal{R}' &= \tilde{x}, \tilde{x}^\bullet, \tilde{x} \circ \tilde{x}, \tilde{x}', \tilde{x}, \dots, \tilde{x}'' \\ \mathcal{R} &= \tilde{x}, \tilde{x}', \tilde{x} \circ \tilde{x}, \tilde{x}', \tilde{x}, \dots, \tilde{x}'' \end{aligned}$$

such that $|\mathcal{P}| = |\mathcal{R}| = |\mathcal{R}'|$, where \tilde{x}'' is either \tilde{x} or \tilde{x}' (i.e., either v or v'), depending on the parity of \mathcal{P} . Note that \tilde{x}'' is in the same bipartition class as w . We observe that \mathcal{P} avoids \mathcal{R}' : recall that \tilde{y} is non-adjacent to \tilde{x}^\bullet , and all other vertices of \mathcal{P} are in $U - (\tilde{S} \cup \tilde{U})$, and thus they are non-adjacent to $\{v, v'\} = \{\tilde{x}, \tilde{x}'\}$. Moreover, the latter implies that \mathcal{R} avoids \mathcal{P} . We set $x = w^\bullet$, $y = s_w$ and:

$$\begin{aligned} \mathcal{A} &= \mathcal{D}' \circ \mathcal{R} \circ \tilde{x}'', s_w & \mathcal{A}' &= \mathcal{D} \circ \mathcal{R}' \circ \tilde{x}'', s_w \\ \mathcal{B} &= \mathcal{C}' \circ \mathcal{P} \circ w, w^\bullet & \mathcal{B}' &= \mathcal{C} \circ \mathcal{P} \circ w, w^\bullet. \end{aligned} \quad (2)$$

Recall that $\tilde{x}'' \in \{v, v'\} \subseteq \tilde{U}$ and as S is bipartite-complete to \tilde{U} , we have that \tilde{x}'' is adjacent to $s_w \in S$. Moreover, we observe that \mathcal{A} avoids \mathcal{B} and \mathcal{B}' avoids \mathcal{A}' , as w^\bullet is in $U - (\tilde{S} \cup \tilde{U})$ and thus is non-adjacent to $\tilde{x}'' \in \tilde{U}$. It is straightforward to verify that the constructed walks satisfy the statement (2.b).

Case 3 b): the call for $H[U]$ resulted in the statement (1.b). If $\tilde{x} \notin \{v, v'\}$, then $\mathcal{D}, \mathcal{D}'$ are entirely contained in \tilde{U} , in particular $\tilde{x}, \tilde{x}^\bullet \in \tilde{U}$. We define $\mathcal{R} = \tilde{x}, \tilde{x}^\bullet, \tilde{x}, \dots, \tilde{x}''$ so that $|\mathcal{R}| = |\mathcal{P}|$, where \tilde{x}'' is either \tilde{x} or \tilde{x}^\bullet , depending on the parity of $|\mathcal{P}|$. Note that \mathcal{P} and \mathcal{R} avoid each other, as \tilde{y} is non-adjacent to \tilde{x}^\bullet , and no vertex from \mathcal{P} , except for \tilde{y} , is adjacent to any vertex of \tilde{U} .

We set $x = w^\bullet$, $y = s_w$ and:

$$\begin{aligned} \mathcal{A} &= \mathcal{D}' \circ \mathcal{R} \circ \tilde{x}'', s_w, & \mathcal{A}' &= \mathcal{D} \circ \mathcal{R} \circ \tilde{x}'', s_w, \\ \mathcal{B} &= \mathcal{C}' \circ \mathcal{P} \circ w, w^\bullet, & \mathcal{B}' &= \mathcal{C} \circ \mathcal{P} \circ w, w^\bullet. \end{aligned} \quad (3)$$

Similarly to the case of walks constructed in (2), we can observe that \mathcal{A} avoids \mathcal{B} and \mathcal{B}' avoids \mathcal{A}' . Note that this works also for the case $w^\bullet = \tilde{y}$, that is, if $|\mathcal{P}| = 1$. Then the walks from (3) are as follows:

$$\begin{aligned} \mathcal{A} &= \mathcal{D}' \circ \tilde{x}, \tilde{x}^\bullet, s_w, & \mathcal{A}' &= \mathcal{D} \circ \tilde{x}, \tilde{x}^\bullet, s_w, \\ \mathcal{B} &= \mathcal{C}' \circ \tilde{y}, w, \tilde{y}, & \mathcal{B}' &= \mathcal{C} \circ \tilde{y}, w, \tilde{y}, \end{aligned}$$

Finally, observe that in (3) we used only vertices from U (except s_w) and thus walks $\mathcal{B}, \mathcal{B}'$ are entirely contained in U , and for every i it holds that $\{\mathcal{A}, \mathcal{B}\}^{(i)} \not\subseteq S$. Thus we obtain the statement (2.b). of the lemma. \square

Lemma 22. *Let H be an undecomposable, bipartite graph with bipartition classes X, Y and let $s, v \in X$ be incomparable vertices. Let $T \subseteq X$ be a nonempty set of some vertices reachable from at least one of s, v , and incomparable with both s, v . Then there exist $t \in T$ and two pairs of walks:*

1. $\mathcal{A}, \mathcal{A}' : s \rightarrow t$ and $\mathcal{B}, \mathcal{B}' : v \rightarrow v$, or
 2. $\mathcal{A}, \mathcal{A}' : s \rightarrow s$ and $\mathcal{B}, \mathcal{B}' : v \rightarrow t$,
- such that \mathcal{A} avoids \mathcal{B} and \mathcal{B}' avoids \mathcal{A}' .

Proof. Since s and v are incomparable, there are $v' \in N(v) - N(s)$ and $s' \in N(s) - N(v)$.

Case 1: there exists $t \in T$ and a vertex $t'_v \in N(t) - N(v)$, which is adjacent to s . Let $v'_t \in N(v) - N(t)$, it exists since v and t are incomparable. Then we can set: $\mathcal{A} = \mathcal{A}' = s, t'_v, t, \mathcal{B} = v, v', v$ and $\mathcal{B}' = v, v'_t, v$. It is straightforward to verify that \mathcal{A} avoids \mathcal{B} and \mathcal{B}' avoids \mathcal{A}' . The case that there is $t \in T$ and $t'_s \in N(t) - N(s)$, such that $t'_s v \in E(H)$, is symmetric.

Case 2: for every $t \in T$, every neighbor of t is either adjacent to both s, v or non-adjacent to both.

Observe that this implies that $T \cap N(s', v') = \emptyset$: otherwise, if there is any $t \in T$ adjacent to one of s', v' , say s' , then s' must be adjacent to both s, v , which contradicts its definition. Let S be a minimal $\{s, v, s', v'\}$ - T -separator contained in $N(s, v, s', v')$ and let U be the set of vertices reachable from $\{s, s', v, v'\}$ in $H - S$. Observe that the graph H , vertices s, s', v, v' , and the set S satisfy the assumptions of Lemma 21. So, by Lemma 21, there are $y \in S$ and $x \in U$, and walks $\mathcal{C}, \mathcal{C}' : s \rightarrow y, \mathcal{D}, \mathcal{D}' : v \rightarrow x$ (statement (1.)) or $\mathcal{C}, \mathcal{C}' : v \rightarrow y, \mathcal{D}, \mathcal{D}' : s \rightarrow x$ (statement (2.)), such that \mathcal{C} avoids \mathcal{D} and \mathcal{D}' avoids \mathcal{C}' .

Suppose that calling Lemma 21 resulted in statement (1.), i.e., the obtained walks are $\mathcal{C}, \mathcal{C}' : s \rightarrow y$ and $\mathcal{D}, \mathcal{D}' : v \rightarrow x$ (the other case is symmetric). Let x^\bullet be the last vertex on $(\mathcal{D}')^\dagger$, note that it is adjacent to x and, by Observation 12, non-adjacent to y . By minimality of S there is $t \in T$ and a y - t -path \mathcal{P} of length at least 1, whose every vertex, except for y , is in $V(H) - (S \cup U)$. This implies that y is the only vertex of \mathcal{P} with a neighbor in U . Let us consider two subcases.

Case 2a: calling Lemma 21 resulted in statement (1.a). This means that $x \in \{v, v'\}$. Let us define x' , such that $\{x, x'\} = \{v, v'\}$. If $|\mathcal{P}| > 1$, we define $\mathcal{R} = x, x^\bullet, x, x', x, \dots, v$ and $\mathcal{R}' = x, x', \dots, v$, such that $|\mathcal{R}| = |\mathcal{R}'| = |\mathcal{P}|$. Recall that v and t are in the same bipartition class, so the last vertex of both walks is indeed v . Observe that \mathcal{P} avoids \mathcal{R} and \mathcal{R}' avoids \mathcal{P} , as x^\bullet is non-adjacent to y , and every vertex of \mathcal{P} , except y , is non-adjacent to every vertex of U , so, in particular, to $\{x, x'\} = \{v, v'\}$. We set:

$$\begin{aligned} \mathcal{A} &= \mathcal{C} \circ \mathcal{P}, & \mathcal{A}' &= \mathcal{C}' \circ \mathcal{P}, \\ \mathcal{B} &= \mathcal{D} \circ \mathcal{R}, & \mathcal{B}' &= \mathcal{D}' \circ \mathcal{R}', \end{aligned}$$

which are walks as in the statement (1.). And if $|\mathcal{P}| = 1$, i.e. $\mathcal{P} = y, t$, then $x = v'$ since x, y are in the same bipartition class. We can define $\mathcal{R} = v', x^\bullet, v', v, \mathcal{R}' = v', v, v', v$ and $\mathcal{P}' = y, t, t', t$, where t' is a vertex in $N(t) - N(s, v)$ (note that it exists, since t is incomparable with s, v and every vertex in $N(t) \cap N(s, v)$ is adjacent to both s, v by the definition of Case 2). Note that \mathcal{R}' avoids \mathcal{P}' and \mathcal{P}' avoids \mathcal{R} . We set:

$$\begin{aligned} \mathcal{A} &= \mathcal{C} \circ \mathcal{P}', & \mathcal{A}' &= \mathcal{C}' \circ \mathcal{P}', \\ \mathcal{B} &= \mathcal{D} \circ \mathcal{R}, & \mathcal{B}' &= \mathcal{D}' \circ \mathcal{R}', \end{aligned}$$

and obtain walks as in the statement (1.).

Case 2b: calling Lemma 21 resulted in statement (1.b). This means that walks $\mathcal{D}, \mathcal{D}'$ are entirely contained in U . Let t' be a neighbor of t such that $t' \notin S_Y$, again it exists in this case (recall that $S_Y \subseteq N(s, v)$). We set:

$$\begin{aligned} \mathcal{A} &= \mathcal{C} \circ \mathcal{P}^*, & \mathcal{A}' &= \mathcal{C}' \circ \mathcal{P}^*, \\ \mathcal{B} &= \mathcal{D} \circ \mathcal{D}^*, & \mathcal{B}' &= \mathcal{D}' \circ \mathcal{D}^*, \end{aligned}$$

where $\mathcal{P}^* := \mathcal{P} \circ t, t', \dots, t$ and $\mathcal{D}^* := \overline{\mathcal{D}'} \circ v, v', \dots, v$ are defined in a way that $|\mathcal{P}^*| = |\mathcal{D}^*| := \max(|\mathcal{P}|, |\mathcal{D}'|)$. Basically these walks play the same role as \mathcal{P} and $\overline{\mathcal{D}'}$, but extra padding added to one of them ensures they have the same length. Observe that \mathcal{D}^* is entirely contained in U and thus it avoids \mathcal{P}^* whose only vertex adjacent to U is the first one. Moreover \mathcal{P}^* avoids \mathcal{D}^* , since the first vertex of \mathcal{P} is y and it is non-adjacent to x^\bullet , which is the second vertex on \mathcal{D}^* . Thus \mathcal{A} avoids \mathcal{B} and \mathcal{B}' avoids \mathcal{A}' and we have obtained statement (1.). \square

Lemma 23. *Let H be a bipartite, undecomposable graph with bipartition classes X, Y , let $s, v \in X$ be incomparable vertices and let $t \in X$ be a vertex reachable from at least one of s, v . Then there exist a vertex $q \in X$ and two pairs of walks:*

1. $\mathcal{P}, \mathcal{P}' : s \rightarrow t$ and $\mathcal{Q}, \mathcal{Q}' : v \rightarrow q$, or
2. $\mathcal{P}, \mathcal{P}' : s \rightarrow q$ and $\mathcal{Q}, \mathcal{Q}' : v \rightarrow t$,

such that \mathcal{P} avoids \mathcal{Q} and \mathcal{Q}' avoids \mathcal{P}' . Moreover, if t is incomparable with at least one of s, v then $q = v$ in the first case and $q = s$ in the other.

Finally, given a bipartite graph H , in time polynomial in $|H|$ we can either find the desired walks or a decomposition of H .

Proof. Observe that if t is incomparable with both s, v , we can obtain the desired walks by applying Lemma 22 for s, v , and $T = \{t\}$.

Now let us assume that t is incomparable with exactly one of s, v , say v (the other case is symmetric) and let t'_v be a vertex in $N(t) - N(v)$ and let v'_t be a vertex in $N(v) - N(t)$. Since s and v are incomparable, there are $v'_s \in N(v) - N(s)$ and $s'_v \in N(s) - N(v)$. Since t is comparable with s , we either have $N(t) \subseteq N(s)$ or $N(s) \subseteq N(t)$. If $N(t) \subseteq N(s)$, we observe that t'_v must be adjacent to s , and v'_s must be non-adjacent to t since $v'_s \notin N(s)$. Then we set $q = v$, $\mathcal{P} = \mathcal{P}' = s, t'_v, t$, and $\mathcal{Q} = \mathcal{Q}' = v, v'_s, v$. On the other hand, if $N(s) \subseteq N(t)$, we observe that s'_v must be adjacent to t and v'_t must be non-adjacent to s . Then we set $q = v$, $\mathcal{P} = \mathcal{P}' = s, s'_v, t$, and $\mathcal{Q} = \mathcal{Q}' = v, v'_t, v$.

So from now we can assume that t is comparable with both s, v . Observe that it implies that either $N(s, v) \subseteq N(t)$, or $N(t) \subseteq N(s) \cap N(v)$. Note that the other cases are not possible: if we have, say, $N(v) \subseteq N(t)$ and $N(t) \subseteq N(s)$, then $N(v) \subseteq N(s)$, a contradiction. Observe that if there is $s' \in N(s) - N(v)$ and $v' \in N(v) - N(s)$, such that t is adjacent to at least one of s', v' , then we can set $S := \{t\} \subseteq N(s, s', v, v')$ and, by the assumption of H , it has no decomposition. Thus we can call Lemma 21 for vertices s, s', v, v' and the set $S = \{t\}$. Since t is the only vertex of S , we obtain a vertex q , reachable from $\{s, v\}$ in $H - \{t\}$, and walks $\mathcal{P}, \mathcal{P}' : s \rightarrow t$ and $\mathcal{Q}, \mathcal{Q}' : v \rightarrow q$, or $\mathcal{Q}, \mathcal{Q}' : v \rightarrow t$ and $\mathcal{P}, \mathcal{P}' : s \rightarrow q$, such that \mathcal{P} avoids \mathcal{Q} and \mathcal{Q}' avoids \mathcal{P}' .

So it only remains to consider the case in which t is non-adjacent to every vertex in $(N(s) - N(v)) \cup (N(v) - N(s))$. Choose arbitrary $s' \in N(s) - N(v)$ and $v' \in N(v) - N(s)$. Observe that by the case we are considering, we have $N(t) \subseteq N(s) \cap N(v)$, which implies that $N(t) \subseteq N(s, s', v, v')$. We call Lemma 21 for H , vertices s, s', v, v' , and the set $S = N(t)$. We obtain vertices $y \in N(t)$ and $x \in U$, where U is the set of vertices reachable from $\{s, v\}$ in $H - S$, and walks $\mathcal{A}, \mathcal{A}' : s \rightarrow y, \mathcal{B}, \mathcal{B}' : v \rightarrow x$ or

$\mathcal{A}, \mathcal{A}' : v \rightarrow y, \mathcal{B}, \mathcal{B}' : s \rightarrow x$ of length at least one, such that \mathcal{A} avoids \mathcal{B} and \mathcal{B}' avoids \mathcal{A}' . Let q be the last vertex on $(\mathcal{B}')^-$ – it is adjacent to x and non-adjacent to y . We also have that x is non-adjacent to t , since all neighbors of t are in S . If we obtain walks $\mathcal{A}, \mathcal{A}' : s \rightarrow y, \mathcal{B}, \mathcal{B}' : v \rightarrow x$ then we set:

$$\begin{aligned}\mathcal{P} &= \mathcal{A} \circ y, t, & \mathcal{P}' &= \mathcal{A}' \circ y, t, \\ \mathcal{Q} &= \mathcal{B} \circ x, q, & \mathcal{Q}' &= \mathcal{B}' \circ x, q,\end{aligned}$$

and if we obtain walks $\mathcal{A}, \mathcal{A}' : v \rightarrow y, \mathcal{B}, \mathcal{B}' : s \rightarrow x$, then we set:

$$\begin{aligned}\mathcal{P} &= \mathcal{B}' \circ x, q, & \mathcal{P}' &= \mathcal{B} \circ x, q, \\ \mathcal{Q} &= \mathcal{A}' \circ y, t, & \mathcal{Q}' &= \mathcal{A} \circ y, t.\end{aligned}$$

It is straightforward to verify that in both cases \mathcal{P} avoids \mathcal{Q} and \mathcal{Q}' avoids \mathcal{P}' . The proof, as well as the proofs of [Lemma 21](#) and [Lemma 22](#), are clearly constructive, so the claim about the polynomial-time algorithm follows easily. \square

3.4.2 Constructing walks from incomparable vertices to an obstruction.

Now we will introduce several lemmas about how our walks reach the obstruction.

Lemma 24. *Let H be an undecomposable, bipartite graph with an obstruction \mathbb{O} . Let $(\alpha, \beta) \in C(\mathbb{O})$, and let s be a vertex reachable from \mathbb{O} , which belongs to the same bipartition class as β but is incomparable with it. Then there exist walks $\mathcal{A}, \mathcal{A}' : s \rightarrow \alpha$ and $\mathcal{B}, \mathcal{B}' : \beta \rightarrow \beta$, such that \mathcal{A} avoids \mathcal{B} and \mathcal{B}' avoids \mathcal{A}' .*

Proof. We use [Lemma 23](#) for $s = \alpha, v = \beta$, and $t = s$ to obtain walks $\mathcal{P}, \mathcal{P}' : \alpha \rightarrow s$ and $\mathcal{Q}, \mathcal{Q}' : \beta \rightarrow \beta$ or $\mathcal{P}, \mathcal{P}' : \alpha \rightarrow \alpha$ and $\mathcal{Q}, \mathcal{Q}' : \beta \rightarrow s$, such that \mathcal{P} avoids \mathcal{Q} and \mathcal{Q}' avoids \mathcal{P}' . In the first case, it is enough to take $\mathcal{A} = \overline{\mathcal{P}'}, \mathcal{B} = \overline{\mathcal{Q}'}, \mathcal{A}' = \overline{\mathcal{P}}, \mathcal{B}' = \overline{\mathcal{Q}}$, and we are done. In the second case, we use [Lemma 23](#) again, now for $s = s, v = \beta$ and $t = \alpha$ and obtain walks $\mathcal{R}, \mathcal{R}' : s \rightarrow \alpha$ and $\mathcal{S}, \mathcal{S}' : \beta \rightarrow \beta$ or $\mathcal{R}, \mathcal{R}' : s \rightarrow s$ and $\mathcal{S}, \mathcal{S}' : \beta \rightarrow \alpha$, such that \mathcal{R} avoids \mathcal{S} and \mathcal{S}' avoids \mathcal{R}' . In the first case, we are done, as these are the walks we are looking for. In the second case we set

$$\begin{aligned}\mathcal{A} &= \mathcal{R} \circ \overline{\mathcal{Q}} \circ \mathcal{Y}', & \mathcal{A}' &= \mathcal{R}' \circ \overline{\mathcal{Q}'} \circ \mathcal{Y}, \\ \mathcal{B} &= \mathcal{S} \circ \overline{\mathcal{P}} \circ \mathcal{X}', & \mathcal{B}' &= \mathcal{S}' \circ \overline{\mathcal{P}'} \circ \mathcal{X},\end{aligned}$$

where $\mathcal{X}, \mathcal{X}' : \alpha \rightarrow \beta$ and $\mathcal{Y}, \mathcal{Y}' : \beta \rightarrow \alpha$ are obtained by [Observation 17](#). \square

In the next proof some constructions will depend on the bipartition class of a particular vertex. To avoid considering cases separately, for two non-necessarily distinct vertices u and u' , such that $u' \in N[u]$, we introduce a walk

$$\mathcal{E}[u, u'] := \begin{cases} u, u' & \text{if } uu' \in E(H), \\ u & \text{if } u = u'. \end{cases}$$

Note that if sets $\{u, u'\}$ and $\{v, v'\}$ are non-adjacent (again, it might be that $u = u'$ or $v = v'$), then the walks $\mathcal{E}[u, u']$ and $\mathcal{E}[v, v']$ are clearly non-adjacent.

Lemma 25. *Let H be a bipartite graph with an obstruction \mathbb{O} . Let $(\alpha, \beta) \in C(\mathbb{O})$ and let $s \in V(H)$ be a vertex reachable from \mathbb{O} , which belongs to the same bipartition class as α, β . Assume that $N(s) - N(\beta) \neq \emptyset$ and $\text{dist}(N[s] - N(\beta), \mathbb{O}) \leq 1$. Then one of the following exists:*

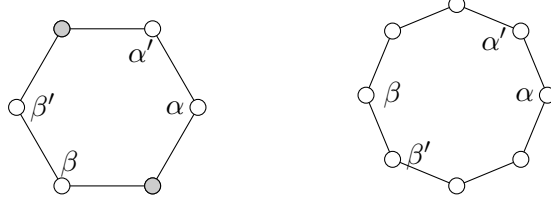

Figure 4: The position of elements of $C(\mathbb{O})$ when \mathbb{O} is isomorphic to C_6 (left) of C_8 (right). Gray vertices indicate the possible position of vertices p and r in the Case 2 of the proof of Lemma 25.

1. walks $\mathcal{P} : \alpha \rightarrow \alpha$, $\mathcal{Q} : s \rightarrow \alpha$ and $\mathcal{R} : \beta \rightarrow \beta$, such that \mathcal{P} , \mathcal{Q} avoid \mathcal{R} ,
2. walks $\mathcal{P} : \alpha \rightarrow \alpha$, $\mathcal{Q} : s \rightarrow \beta$ and $\mathcal{R} : \beta \rightarrow \beta$, such that \mathcal{P} avoids \mathcal{Q} , \mathcal{R} .

Proof. Let α', β' be the pair of vertices, such that $C(\mathbb{O}) = \{(\alpha, \beta), (\alpha', \beta')\}$.

By Definition 6 recall that edges $\alpha\alpha'$ and $\beta\beta'$ are independent. First, we consider some simple special cases separately. If $s\beta' \in E(H)$, we obtain the statement (2.) by setting

$$\begin{aligned}\mathcal{P} &= \alpha, \alpha' \alpha, \\ \mathcal{Q} &= s, \beta', \beta, \\ \mathcal{R} &= \beta, \beta', \beta.\end{aligned}$$

If now $s\beta' \notin E(H)$ and there exists $s' \in N(s) - N(\beta)$ such that $\alpha s' \in E(H)$ (in particular when s is adjacent to α'), then we obtain the statement (1.) by setting

$$\begin{aligned}\mathcal{P} &= \alpha, \alpha', \alpha, \\ \mathcal{Q} &= s, s', \alpha, \\ \mathcal{R} &= \beta, \beta', \beta.\end{aligned}$$

So assume that the cases above do not apply. Let us fix any $s' \in N(s) - N(\beta)$ for which $\text{dist}(\{s, s'\}, \mathbb{O}) \leq 1$. Note that the edges $\alpha\alpha'$, $\beta\beta'$, and ss' are independent.

Case 1: there exists $p \in N[s, s'] \cap V(\mathbb{O})$ such that $p \notin N(\alpha, \alpha')$. Clearly $p \notin \{\alpha, \alpha', \beta, \beta'\}$, as otherwise edges $\alpha\alpha'$, $\beta\beta'$, ss' would not be independent. Note that this implies that this case cannot occur if \mathbb{O} is isomorphic to C_6 , see Figure 4 (left). Let \bar{s} be an element of $\{s, s'\}$ which is a neighbor of p . Recall that since $p, \beta \notin N[\alpha, \alpha']$, by Observation 16, there exists a p - β -walk $\mathcal{W}[p, \beta]$, which is non-adjacent to $\{\alpha, \alpha'\}$. We define:

$$\begin{aligned}\mathcal{P} &:= \alpha, \alpha', \dots, \alpha, \\ \mathcal{Q} &:= \mathcal{E}[s, \bar{s}] \circ \bar{s}, p \circ \mathcal{W}[p, \beta], \\ \mathcal{R} &:= \beta, \beta', \dots, \beta,\end{aligned}$$

in a way that $|\mathcal{P}| = |\mathcal{R}| = |\mathcal{Q}|$. Clearly \mathcal{P} avoids \mathcal{R} . Moreover, \mathcal{P} avoids \mathcal{Q} since $s, s', p \notin N[\alpha, \alpha']$ and $\mathcal{W}[p, \beta]$ is non-adjacent to $\{\alpha, \alpha'\}$. Thus we obtain the statement (2.).

Case 2: $N[s, s'] \cap V(\mathbb{O}) \subseteq N(\alpha, \alpha')$. It implies that $\text{dist}(\{s, s'\}, \mathbb{O}) = 1$, as if $\{s, s'\} \cap V(\mathbb{O}) \neq \emptyset$, then $\{s, s'\}$ and $\{\alpha, \alpha'\}$ would be adjacent. So there exists $p \in N(s, s') \cap V(\mathbb{O}) \cap N(\alpha, \alpha')$. Again, let \bar{s} be an element of $\{s, s'\}$ which is a neighbor of p and let $\{\bar{\alpha}, \bar{\alpha}'\} := \{\alpha, \alpha'\}$ such that $\bar{\alpha}p \in E(H)$.

Note that if $p \notin N(\beta, \beta')$, we can set

$$\begin{aligned}\mathcal{P} &:= \alpha, \alpha', \dots, \alpha, \\ \mathcal{Q} &:= \mathcal{E}[s, \bar{s}] \circ \bar{s}, p, \bar{\alpha} \circ \mathcal{E}[\bar{\alpha}, \alpha] \\ \mathcal{R} &:= \beta, \beta', \dots, \beta.\end{aligned}$$

in a way that $|\mathcal{P}| = |\mathcal{R}| = |\mathcal{Q}|$. Then \mathcal{P}, \mathcal{Q} avoid \mathcal{R} and we get the statement (2.). Observe that if \mathbb{O} is isomorphic to C_8 , then the above case applies; see Figure 4 (right).

So we can assume that $p \in N(s, s') \cap N(\alpha, \alpha') \cap N(\beta, \beta')$. Let $\{\bar{\beta}, \bar{\beta}'\} := \{\beta, \beta'\}$, such that $\bar{\beta}p \in E(H)$. If \mathbb{O} is isomorphic to C_6 , then let r be the other vertex of \mathbb{O} which belongs to $N(\alpha, \alpha') \cap N(\beta, \beta')$ (r is uniquely determined, see Figure 4 (left)). As $pr \notin E(H)$, we define the walks that satisfy the statement (1.):

$$\begin{aligned}\mathcal{P} &:= \mathcal{E}[\alpha, \bar{\alpha}] \circ \bar{\alpha}, p, \bar{\alpha}, \bar{\alpha}' \circ \mathcal{E}[\bar{\alpha}', \alpha] \\ \mathcal{Q} &:= \mathcal{E}[s, \bar{s}] \circ \bar{s}, p, \bar{\alpha}, \bar{\alpha}' \circ \mathcal{E}[\bar{\alpha}', \alpha], \\ \mathcal{R} &:= \mathcal{E}[\beta, \bar{\beta}] \circ \bar{\beta}, \bar{\beta}', r, \bar{\beta}' \circ \mathcal{E}[\bar{\beta}', \beta].\end{aligned}$$

So finally consider the case that \mathbb{O} is an asteroidal subgraph. We use the notation introduced in Definition 4. Then $p \in \mathcal{W}_{0,i}$ for some $i \in \{1, 2k\}$, as all other vertices of \mathbb{O} are non-adjacent to α . Let $\{\kappa, \kappa'\} = \{u_{k+1}, v_{k+1}\}$ if $i = 1$ or $\{\kappa, \kappa'\} = \{u_k, v_k\}$ if $i = 2k$, where κ' and p are in the same bipartition class. Note that by the definition of a special edge asteroid we know that the walk $\mathcal{W}_{0,i}$, and in particular p , is non-adjacent to $\{\kappa, \kappa'\}$. Recall that the walk $\mathcal{W}[\beta, \kappa]$ given by Observation 16 is non-adjacent to $\{\alpha, \alpha'\} = \{u_0, v_0\}$. So, since we are in Case 2, we observe that s and s' are non-adjacent to $\{\kappa, \kappa'\}$ and to $\mathcal{W}[\beta, \kappa]$, as otherwise we would have chosen $p \in \{\kappa, \kappa'\} \cup \mathcal{W}[\beta, \kappa]$, such that $p \in N[s, s'] \cap V(\mathbb{O})$ and $p \notin N(\alpha, \alpha')$, ending up in Case 1. We set

$$\begin{aligned}\mathcal{P} &:= \alpha, \alpha', \dots, \alpha \circ \mathcal{E}[\alpha, \bar{\alpha}] \circ \bar{\alpha}, \bar{\alpha}', \bar{\alpha} \circ \mathcal{E}[\bar{\alpha}, \alpha] \circ \alpha, \alpha', \dots, \alpha, \\ \mathcal{Q} &:= s, s', \dots, s \circ \mathcal{E}[s, \bar{s}] \circ \bar{s}, p, \bar{\alpha} \circ \mathcal{E}[\bar{\alpha}, \alpha] \circ \alpha, \alpha', \dots, \alpha, \\ \mathcal{R} &:= \mathcal{W}[\beta, \kappa] \quad \quad \quad \circ \kappa, \kappa', \kappa \circ \mathcal{W}[\kappa, \beta],\end{aligned}$$

so that the lengths of the subwalks in each aligned column are equal. Clearly, \mathcal{R} is non-adjacent with both \mathcal{P} and \mathcal{Q} , so we obtain the statement (1). \square

Lemma 26. *Let H be a connected, undecomposable, bipartite graph with an obstruction \mathbb{O} , let $(\alpha, \beta) \in C(\mathbb{O})$ and let $s \in V(H)$ be a vertex reachable from \mathbb{O} , which belongs to the same bipartition class as β , but incomparable with it. Then at least one of the following exists:*

1. walks $\mathcal{P} : \alpha \rightarrow \alpha$, $\mathcal{Q} : s \rightarrow \alpha$ and $\mathcal{R} : \beta \rightarrow \beta$, such that \mathcal{P}, \mathcal{Q} avoid \mathcal{R} ,
2. walks $\mathcal{P} : \alpha \rightarrow \alpha$, $\mathcal{Q} : s \rightarrow \beta$ and $\mathcal{R} : \beta \rightarrow \beta$, such that \mathcal{P} avoids \mathcal{Q}, \mathcal{R} .

Proof. Let α', β' be the pair of vertices, such that $C(\mathbb{O}) = \{(\alpha, \beta), (\alpha', \beta')\}$. Let X, Y be the bipartition classes of H , such that $\alpha, \beta \in X$ and $\alpha', \beta' \in Y$. If $\text{dist}(N[s] - N(\beta), \mathbb{O}) \leq 1$, we are done by Lemma 25. Thus let us assume that $\text{dist}(N[s] - N(\beta), \mathbb{O}) \geq 2$. Fix any $s' \in N(s) - N(\beta)$ and observe that edges $\alpha\alpha', \beta\beta'$ and ss' are independent. Let P be the minimal s - \mathbb{O} -separator contained in $N(\mathbb{O})$. Let R be the set of vertices reachable from s in $H - P$ and let Q be the set of vertices reachable from α, β in $H - P$. Note that $V(\mathbb{O}) \subseteq Q$ and $s' \in R$, as it does not belong to $N(\mathbb{O})$.

Case 1: there exists $p \in P$ such that $p \notin N(\alpha, \beta, \alpha', \beta')$. Denote by \mathcal{S}_p the s - p -walk, such that \mathcal{S}_p^+ is contained in R (recall that \mathcal{S}_p^+ denotes the walk \mathcal{S}_p with the vertex p removed). The walk \mathcal{S}_p exists, because P is a minimal s - \mathbb{O} -separator. Let $p^\bullet \in R$ be the last vertex of \mathcal{S}_p^+ (it is possible that $p^\bullet = s$).

If $p \in P_X$, then clearly $p \in N(\mathbb{O}) - N(\beta)$, so $\text{dist}(N[p] - N(\beta), \mathbb{O}) \leq 1$. Moreover, $N(p) - N(\beta)$ is non-empty, because $p^\bullet \in N(p) - N(\beta)$. So by [Lemma 25](#) we can obtain walks $\mathcal{T} : \alpha \rightarrow \alpha, \mathcal{U} : p \rightarrow \lambda$ for $\lambda \in \{\alpha, \beta\}$, and $\mathcal{V} : \beta \rightarrow \beta$ such that if \mathcal{U} is a p - α -walk, then \mathcal{T}, \mathcal{U} avoid \mathcal{V} , and otherwise \mathcal{T} avoids \mathcal{U}, \mathcal{V} . Then we define $\mathcal{P} := \alpha, \alpha', \dots, \alpha \circ \mathcal{T}, \mathcal{Q} := \mathcal{S}_p \circ \mathcal{U}$, and $\mathcal{R} := \beta, \beta', \dots, \beta \circ \mathcal{V}$ in a way that $|\mathcal{P}| = |\mathcal{Q}| = |\mathcal{R}|$. Clearly, \mathcal{S}_p is non-adjacent to $\{\alpha, \alpha', \beta, \beta'\}$, because $\mathcal{S}_p^+ \subseteq R$ and $p \notin N(\alpha', \beta')$. Thus walks $\mathcal{P}, \mathcal{Q}, \mathcal{R}$ satisfy statement (1.) or (2.), depending on the statement in the call of [Lemma 25](#).

Similarly, if $p \in P_Y$, we observe that $\text{dist}(N[p] - N(\beta'), \mathbb{O}) \leq \text{dist}(p, \overline{\mathbb{O}}) = 1$ and $p^\bullet \in N(p) - N(\beta')$. Thus again we can use [Lemma 25](#), but now for $(\alpha', \beta') \in C(\mathbb{O})$ instead of (α, β) . We obtain walks $\mathcal{T} : \alpha' \rightarrow \alpha', \mathcal{U} : p \rightarrow \lambda'$ for $\lambda' \in \{\alpha', \beta'\}$ and $\mathcal{V} : \beta' \rightarrow \beta'$, such that if \mathcal{U} is a p - α' -walk, then \mathcal{T}, \mathcal{U} avoid \mathcal{V} and otherwise \mathcal{T} avoids \mathcal{U}, \mathcal{V} . We define

$$\begin{aligned}\mathcal{P} &= \alpha, \alpha', \dots, \alpha' \circ \mathcal{T} \circ \alpha', \alpha, \\ \mathcal{Q} &= \mathcal{S}_p \quad \quad \quad \circ \mathcal{U} \circ \lambda', \lambda, \\ \mathcal{R} &= \beta, \beta', \dots, \beta' \circ \mathcal{V} \circ \beta', \beta,\end{aligned}$$

where λ is the vertex in $\{\alpha, \beta\} \cap N(\lambda')$. Analogously like in the subcase when $p \in P_X$, we can verify that the statement of the lemma holds.

Case 2: for every $p \in P$ it holds that $p \in N(\alpha, \beta, \alpha', \beta')$. We use [Lemma 21](#) for $s = \alpha, s' = \alpha'v = \beta, v' = \beta'$ and $S = P$ to obtain vertices $y \in P$ and $x \in Q$ and walks $\mathcal{A}, \mathcal{A}' : \alpha \rightarrow y, \mathcal{B}, \mathcal{B}' : \beta \rightarrow x$ or $\mathcal{A}, \mathcal{A}' : \beta \rightarrow y, \mathcal{B}, \mathcal{B}' : \alpha \rightarrow x$, such that \mathcal{A} avoids $\mathcal{B}, \mathcal{B}'$ avoids \mathcal{A}' . Furthermore, for every i we have $\{\mathcal{A}, \mathcal{B}\}^{(i)} \not\subseteq P$ and $\mathcal{A}, \mathcal{A}', \mathcal{B}, \mathcal{B}' \subseteq P \cup Q$.

Observe that it is enough to consider the first case, i.e., $\mathcal{A}, \mathcal{A}' : \alpha \rightarrow y, \mathcal{B}, \mathcal{B}' : \beta \rightarrow x$. Indeed, observe that in the second case walks $\mathcal{X} \circ \mathcal{A}, \mathcal{X}' \circ \mathcal{A}' : \alpha \rightarrow y$ and $\mathcal{Y} \circ \mathcal{B}, \mathcal{Y}' \circ \mathcal{B}' : \beta \rightarrow x$, where $\mathcal{X}, \mathcal{X}', \mathcal{Y}, \mathcal{Y}'$ are given by [Observation 17](#), satisfy the assumptions of the first case.

Now let \mathcal{S}_y be the s - y -walk, such that \mathcal{S}_y^+ is contained in R . Define $\mathcal{A}^* := \alpha, \alpha', \alpha \circ \mathcal{A}, \mathcal{B}^* := \beta, \beta', \beta \circ \mathcal{B}$, and $\mathcal{S}^* := s, s', s \circ \mathcal{S}_y$. Observe that $|\mathcal{A}^*| = |\mathcal{B}^*|$ and we have $\alpha, \alpha' \in \mathcal{A}^*, \beta, \beta' \in \mathcal{B}^*$, and $s, s' \in \mathcal{S}^*$. Denote the consecutive vertices of these walks by $\mathcal{A}^* = a_1, \dots, a_\ell, \mathcal{B}^* = b_1, \dots, b_\ell$, and $\mathcal{S}^* = s_1, \dots, s_m$. Note that $a_1 = \alpha, s_1 = s, b_1 = \beta$ and $a_\ell = s_m = y, b_\ell = x$, and \mathcal{A}^* avoids \mathcal{B}^* .

Observe that there exist $i \in [\ell]$ and $j \in [m-1]$ such that $a_i s_j \in E(H)$ or $b_i s_j \in E(H)$ (for example we have $a_\ell = s_m = y$, so $a_\ell s_{m-1} \in E(H)$). Take minimum such j and for that j take minimum i .

Define $\mathcal{C}_\alpha := \alpha, \alpha', \dots, \alpha$ and $\mathcal{C}_\beta := \beta, \beta', \dots, \beta$, such that $|\mathcal{C}_\alpha| = |\mathcal{C}_\beta| = \max(j - i + 1, 0)$, and $\mathcal{C}_s := s, s', \dots, s$, such that $|\mathcal{C}_s| := \max(i - 1 - j, 0)$. Note that then three walks $\mathcal{C}_\alpha \circ a_1, \dots, a_{i-1}, \mathcal{C}_\beta \circ b_1, \dots, b_{i-1}$, and $\mathcal{C}_s \circ s_1, \dots, s_j$ have the same length.

We claim that only one of the edges $a_i s_j$ and $b_i s_j$ exists. Indeed, recall that for every $j \in [m-1]$ we have $s_j \in R$. On the other hand, walks \mathcal{A}^* and \mathcal{B}^* are contained in $Q \cup P$. So a_i (or b_i) can only be adjacent to s_j if $a_i \in P$ ($b_i \in P$). However, by the properties of \mathcal{A}, \mathcal{B} we know that at most one of a_i, b_i may be in P .

If $a_i s_j \in E(H)$ and $b_i s_j \notin E(H)$, we set

$$\begin{aligned}\mathcal{P} &= \mathcal{C}_\alpha \circ a_1, \dots, a_{i-1} \circ a_{i-1}, a_i \circ a_i, \dots, a_\ell \circ \overline{\mathcal{A}'} \\ \mathcal{Q} &= \mathcal{C}_s \circ s_1, \dots, s_j \quad \circ s_j, \quad a_i \circ a_i, \dots, a_\ell \circ \overline{\mathcal{A}'} \\ \mathcal{R} &= \mathcal{C}_\beta \circ b_1, \dots, b_{i-1} \circ b_{i-1}, b_i \circ b_i, \dots, b_\ell \circ \overline{\mathcal{B}'}\end{aligned}$$

Note that $\mathcal{P} = \mathcal{C}_\alpha \circ \mathcal{A}^* \circ \overline{\mathcal{A}'}$ and $\mathcal{R} = \mathcal{C}_\beta \circ \mathcal{B}^* \circ \overline{\mathcal{B}'}$. Observe that since $s, s' \in \mathcal{S}^*$, $\beta, \beta' \in \mathcal{B}$, and by the definition of j and i , the subwalk $\mathcal{C}_s \circ s_1, \dots, s_j$ of \mathcal{Q} is non-adjacent to the subwalk $\mathcal{C}_\beta \circ b_1, \dots, b_{i-1}$ of \mathcal{R} .

By analogous arguments we can see that if $b_i s_j \in E(H)$ and $a_i s_j \notin E(H)$, then for

$$\begin{aligned}\mathcal{P} &= \mathcal{C}_\alpha \circ a_1, \dots, a_{i-1} \circ a_{i-1}, a_i \circ a_{i+1}, \dots, a_\ell \circ \overline{\mathcal{A}'} \\ \mathcal{Q} &= \mathcal{C}_s \circ s_1, \dots, s_j \circ s_j, \quad b_i \circ b_{i+1}, \dots, b_\ell \circ \overline{\mathcal{B}'} \\ \mathcal{R} &= \mathcal{C}_\beta \circ b_1, \dots, b_{i-1} \circ b_{i-1}, \quad b_i \circ b_{i+1}, \dots, b_\ell \circ \overline{\mathcal{B}'}\end{aligned}$$

we have that \mathcal{P} avoids \mathcal{Q} and \mathcal{R} . □

3.4.3 Proof of Lemma 27.

All lemmas introduced so far will be used to prove Lemma 27.

Lemma 27. *Let H be a connected, bipartite, undecomposable graph, let \mathbb{O} be an obstruction in H and let $(\alpha, \beta) \in C(\mathbb{O})$. Let S be an incomparable set of $k \geq 2$ vertices of H , contained in the same bipartition class as α, β . Let a and b be two distinct vertices of S . For each $v \in S$ there exists a walk \mathcal{D}_v , of length at least two, satisfying the following properties:*

- (1) *for each $v \in S$, \mathcal{D}_v is a v - α -walk or a v - β -walk,*
 - (2) *\mathcal{D}_a is an a - α -walk and \mathcal{D}_b is a b - β -walk,*
 - (3) *for each $u, v \in S$, such that $\mathcal{D}_u : u \rightarrow \alpha$ and $\mathcal{D}_v : v \rightarrow \beta$, we have that \mathcal{D}_u avoids \mathcal{D}_v .*
- In particular, all walks have equal length.*

Before we prove Lemma 27 in full generality, we consider a special case. We say that an incomparable set S is *strongly incomparable* if for every $v \in S$ there exists $v' \in N(v)$ such that for every $u \in S - \{v\}$ it holds that $uv' \notin E(H)$. Observe that then the edges $\{vv'\}_{v \in S}$ are independent.

Lemma 28. *Lemma 27 holds if we additionally assume that S is strongly incomparable.*

Proof. Let X, Y be the bipartition classes of H such that $S = \{x_1, \dots, x_k\} \subseteq X$, where $k \geq 2, x_1 = a, x_2 = b$. To simplify the notation, we will write \mathcal{D}_i instead of \mathcal{D}_{x_i} . Let (α', β') be the pair, such that $C(\mathbb{O}) = \{(\alpha, \beta), (\alpha', \beta')\}$.

First, observe that all constructed walks must have even length, as they start and end in the same bipartition class. Thus the only possibility to have walks satisfying conditions (1)-(3), which are of length less than two, is if $|S| = 2$ and $a = \alpha$ and $b = \beta$. To avoid having walks of length 0, in this case we return walks $\mathcal{D}_a = \alpha, \alpha', \alpha$ and $\mathcal{D}_b = \beta, \beta', \beta$. So from now on we do not need to worry about the length of the walks.

We prove the lemma by induction on k . Consider the base case that $S = \{a, b\}$. By Lemma 23 used for $s = a, v = b$ and $t = \beta$, we obtain a vertex q and walks $\mathcal{P}, \mathcal{P}' : a \rightarrow \beta, \mathcal{Q}, \mathcal{Q}' : b \rightarrow q$ or $\mathcal{P}, \mathcal{P}' : a \rightarrow q, \mathcal{Q}, \mathcal{Q}' : b \rightarrow \beta$, such that \mathcal{P} avoids \mathcal{Q} and \mathcal{Q}' avoids \mathcal{P}' . Note that in both cases q must be incomparable with β (recall Observation 12), so we can use Lemma 24 for $s = q$ to obtain $\mathcal{A}, \mathcal{A}' : q \rightarrow \alpha$ and $\mathcal{B}, \mathcal{B}' : \beta \rightarrow \beta$, such that \mathcal{A} avoids \mathcal{B} and \mathcal{B}' avoids \mathcal{A}' .

If $\mathcal{P} : a \rightarrow q$ and $\mathcal{Q} : b \rightarrow \beta$, then clearly we can define $\mathcal{D}_a = \mathcal{P} \circ \mathcal{A}$ and $\mathcal{D}_b = \mathcal{Q} \circ \mathcal{B}$. On the other hand, if $\mathcal{P} : a \rightarrow \beta, \mathcal{Q} : b \rightarrow q$, we define $\mathcal{D}_a = \mathcal{P} \circ \mathcal{B}' \circ \mathcal{Y}'$ and $\mathcal{D}_b = \mathcal{Q} \circ \mathcal{A}' \circ \mathcal{X}'$, where $\mathcal{X}', \mathcal{Y}'$ are given by Observation 17.

So now assume that $S = \{x_1, \dots, x_k\}$ for $k \geq 3$ and $x_1 = a$, $x_2 = b$, and the lemma holds for $k - 1$. Let $\{\widetilde{\mathcal{D}}_i\}_{i=1}^{k-1}$ be the set of walks given by the inductive call for the set $S - \{x_k\}$. The consecutive vertices of $\widetilde{\mathcal{D}}_i$ are denoted by d_1^i, \dots, d_ℓ^i . Let A be the set of walks $\widetilde{\mathcal{D}}_i$ terminating at α and let B be the set of walks $\widetilde{\mathcal{D}}_i$ terminating at β . Clearly $\widetilde{\mathcal{D}}_a \in A$ and $\widetilde{\mathcal{D}}_b \in B$.

As S is strongly incomparable, for every $x_i \in S$ there exists $x'_i \in N(x_i)$, such that the edges in the set $\{x_i x'_i\}_{i \in [k]}$ are independent.

Case 1: There is an edge between $\{x_k, x'_k\}$ and $\bigcup_{i \in [k-1]} \widetilde{\mathcal{D}}_i$. This means that there is some $j \in [\ell]$ and $p \in [k-1]$, such that one of edges $x_k d_j^p$ or $x'_k d_j^p$ exists (note that both edges cannot exist since H is bipartite). We choose the minimum such j , and for this j , if only possible, we choose p such that $\widetilde{\mathcal{D}}_p \in B$.

Observe that $j > 1$, because otherwise $x_p x'_k \in E(H)$, a contradiction with the choice of x'_k . Let $\bar{x}_k \in \{x_k, x'_k\}$ be the vertex for which $\bar{x}_k d_j^p \in E(H)$. Then we define

$$\mathcal{D}_i := \begin{cases} x_k, x'_k, \dots, \bar{x}_k \circ \bar{x}_k, d_j^p, \dots, d_\ell^p & \text{if } i = k, \\ \widetilde{\mathcal{D}}_i & \text{if } i \in [k-1], \end{cases}$$

so that they have equal length. Denote the consecutive vertices of \mathcal{D}_k by d_1^k, \dots, d_ℓ^k . It is clear that these walks satisfy conditions (1) and (2), so we only need to prove the condition (3). Assume that there exist walks $\mathcal{D}_q : x_q \rightarrow \alpha$ and $\mathcal{D}_r : x_r \rightarrow \beta$, such that \mathcal{D}_q does not avoid \mathcal{D}_r . Note that by the inductive assumption this cannot happen if $q, r \in [k-1]$. Thus either $r = k$ or $q = k$.

Assume that $r = k$, i.e., \mathcal{D}_k is an x_k - β -walk. Note that this means that $\widetilde{\mathcal{D}}_p \in B$. Let $c \geq 2$ be the minimum index for which $d_{c-1}^q d_c^k \in E(H)$. If $c < j$, it means $d_{c-1}^q x_k \in E(H)$ or $d_{c-1}^q x'_k \in E(H)$, which contradicts the minimality of j . If $c \geq j$, then $d_c^k = d_c^p$, so d_{c-1}^q is adjacent to d_c^p . Thus the x_q - α walk $\widetilde{\mathcal{D}}_q$ does not avoid the x_p - β walk $\widetilde{\mathcal{D}}_p$, a contradiction.

So assume $q = k$, i.e., \mathcal{D}_k is an x_k - α -walk and $\widetilde{\mathcal{D}}_p$ is an x_p - α -walk. Let $c \geq 2$ be the smallest index for which $d_{c-1}^k d_c^p \in E(H)$. The argument is analogous: if $c < j$, then we have a contradiction with the minimality of j . If $c > j$, then the x_p - α -walk $\widetilde{\mathcal{D}}_p$ does not avoid the x_r - β walk $\widetilde{\mathcal{D}}_r$, a contradiction. Finally, if $c = j$, recall that we would choose r instead of p , as $\widetilde{\mathcal{D}}_r \in B$ and $\widetilde{\mathcal{D}}_p \notin B$. This completes the proof of this case.

Case 2: There are no edges between $\{x_k, x'_k\}$ and $\bigcup_{i \in [k-1]} \widetilde{\mathcal{D}}_i$. Then we use [Lemma 26](#) for α, β and $s = x_k$ to obtain walks \mathcal{P}, \mathcal{Q} and \mathcal{R} and define

$$\mathcal{D}_i := \begin{cases} \widetilde{\mathcal{D}}_i & \circ \mathcal{P} & \text{if } i \in A, \\ \widetilde{\mathcal{D}}_i & \circ \mathcal{R} & \text{if } i \in B, \\ x_k, x'_k, \dots, x_k & \circ \mathcal{Q} & \text{if } i = k, \end{cases}$$

so that all walks have the same length $\ell - 1$. We extend the naming of vertices of walks \mathcal{D}_i by denoting their consecutive vertices by d_1^i, \dots, d_ℓ^i , note that this is consistent with previous notation, as for every $i \in [k-1]$ the walk $\widetilde{\mathcal{D}}_i$ is the prefix of \mathcal{D}_i .

Again, properties (1) and (2) are straightforward, let us verify the property (3). As \mathcal{P} avoids \mathcal{R} and for every $q \in A$ and $r \in B$ the walk \mathcal{D}_q avoids \mathcal{D}_r , by [Observation 13](#) we know that the property (3) holds for all $q, r \in [k-1]$.

So we only need to consider two cases. First, assume that \mathcal{Q} is an x_k - α -walk (and thus so is \mathcal{D}_k), and \mathcal{P}, \mathcal{Q} avoid \mathcal{R} . Suppose that there exists $\mathcal{D}_r \in B$ such that \mathcal{D}_k does not avoid \mathcal{D}_r , i.e., there exists $c \geq 2$ such that $d_{c-1}^k d_c^r \in E(H)$. Recall that the number of vertices in $\widetilde{\mathcal{D}}_r$ is ℓ . If $c-1 \geq \ell$, then \mathcal{Q} does not avoid \mathcal{R} , a contradiction. And if $c-1 < \ell$, then $d_{c-1}^k \in \{x_k, x'_k\}$, so $\widetilde{\mathcal{D}}_r$ is adjacent to x_k or x'_k , a contradiction with the assumption of the case.

Now assume that \mathcal{Q} is an x_k - β -walk and there exists $q \in A$ such that \mathcal{D}_q does not avoid \mathcal{D}_k , i.e., there exists $c \geq 2$ such that $d_{c-1}^q d_c^k \in E(H)$. The arguments which lead to the contradiction are analogous – if $c-1 \geq \ell$, then \mathcal{P} does not avoid \mathcal{Q} , and if $c-1 < \ell$, then $\widetilde{\mathcal{D}}_q$ is adjacent to x_k or x'_k . \square

Now we are ready to prove [Lemma 27](#).

Proof of Lemma 27. Let X, Y be the bipartition classes of H such that $S = \{x_1, \dots, x_k\} \subseteq X$, where $k \geq 2$, $x_1 = a, x_2 = b$. Again, to simplify the notation, we will write \mathcal{D}_i instead of \mathcal{D}_{x_i} . Let $a' \in N(a) - N(b)$ and $b' \in N(b) - N(a)$. We define $x'_1 := a', x'_2 := b'$, and for every $i \geq 3$ such that $x_i \notin N(a')$ we choose x'_i to be any vertex from $N(x_i) - N(a)$; they exist, since S is incomparable.

Let $U = \{x_i, x'_i : x_i \notin N(a')\} \cup \{a, a'\}$, and let \mathcal{C} be the set of all connected components of $H - N(a, a')$. Note that x_i and x'_i are always in the same component from \mathcal{C} . Moreover, there is a component $C_a \in \mathcal{C}$, such that $V(C_a) = \{a, a'\}$, and a component $C_b \in \mathcal{C}$, such that $b, b' \in V(C_b)$. For each $C \in \mathcal{C}$ containing at least one vertex from U , we choose one vertex $u \in U_X \cap V(C)$ and call it the *representative* of C . The representatives are chosen arbitrarily, except that we choose b as the representative of C_b . Note that necessarily a is the representative of C_a . Let $R \subseteq S$ be the set of all vertices that are representatives of components in \mathcal{C} , clearly $a, b \in R$. For every vertex of $C \in \mathcal{C}$, its representative is the representative of C .

We claim that R is strongly incomparable. Indeed, note that for every $x_i \in R$, the vertex $x'_i \in N(x_i)$ is non-adjacent to every $x_j \in R - \{x_i\}$. This is because if x'_i is adjacent to some x_j , then, since x'_i is non-adjacent to a , both x_i, x_j must be in the same component in \mathcal{C} , so they cannot both belong to R . So calling [Lemma 28](#) for the set R and a, b, α, β gives us the family of walks $\{\widetilde{\mathcal{D}}_i\}_{x_i \in R}$.

Recall that the only vertices $x_i \in S$, for which x'_i is not defined yet, are in $(S \cap N(a')) - \{a\}$. Let us consider such x_i , clearly it is adjacent to some vertices in U_Y (at least a'). If there is some $x_j \in U$, such that:

- x_i is adjacent to x'_j , and
- $\widetilde{\mathcal{D}}_r$ terminates at β , where x_r is the representative of x_j ,

then we set $x'_i := x'_j$. Otherwise, we set $x'_i := a'$ (note that $\widetilde{\mathcal{D}}_a$ terminates at α). Now for every x_i we have defined x'_i , and always $x'_i \in U_Y$. In particular, no x'_i , except for a' , is adjacent to a .

Consider a vertex $x_i \in S$ and let $C \in \mathcal{C}$ be the component containing x'_i . Let x_r be the representative of C , and let \mathcal{Z}_i be a x'_i - x_r -walk, contained in C . We define

$$\mathcal{D}_i := \underbrace{x_i, x'_i \circ \mathcal{Z}_i \circ x_r, x'_r, \dots, x_r}_{t \text{ vertices}} \circ \widetilde{\mathcal{D}}_r,$$

where t is chosen so that all \mathcal{D}_i 's are of equal length. Let us denote by d_1^i, \dots, d_ℓ^i the consecutive vertices of \mathcal{D}_i , note that $d_t^i, d_{t+1}^i, \dots, d_\ell^i = \widetilde{\mathcal{D}}_r$ and $d_t^i = x_r$.

It is clear that all walks \mathcal{D}_i terminate at α or β , and in particular \mathcal{D}_a is an a - α -walk and \mathcal{D}_b is a b - β -walk, so the properties (1) and (2) hold. To prove the property (3), suppose that there are $p, q \in [k]$ such that $\mathcal{D}_p : x_p \rightarrow \alpha$ does not avoid $\mathcal{D}_q : x_q \rightarrow \beta$. So there exists $c \geq 2$ such that d_{c-1}^p is adjacent to d_c^q . Let $x_{p'}, x_{q'}$ be, respectively, the representatives of x_p and x_q . Clearly $x_{p'}, x_{q'} \in R$. Note that if $c-1 \geq t$, then

the $x_{p'}\text{-}\alpha\text{-walk } \widetilde{\mathcal{D}}_{p'}$ does not avoid the $x_{q'}\text{-}\beta\text{-walk } \widetilde{\mathcal{D}}_{q'}$, a contradiction with the properties of the walks $\{\widetilde{\mathcal{D}}_i\}_{x_i \in R}$ ensured by Lemma 28.

If $2 \leq c - 1 < t$, then there exists an $x_{p'}\text{-}x_{q'}$ -path in $H - N(a, a')$, so they are in the same connected component in \mathcal{C} . Since each component in \mathcal{C} has exactly one representative, we obtain that $p' = q'$ and thus \mathcal{D}_p and \mathcal{D}_q both terminate in α or in β .

Finally, consider $c = 2$, which means that $d_1^p = x_p$ is adjacent to $d_2^q = x'_q$. There are three possibilities: (i) $x_p, x'_q \notin N(a, a')$, or (ii) $x_p \in N(a')$, or (iii) $x'_q \in N(a)$. In case (i) we observe that x_p and x'_q are in the same connected component in \mathcal{C} , which means that $x_{p'} = x_{q'}$, so both walks $\mathcal{D}_p, \mathcal{D}_q$ terminate at the same vertex. In case (ii), recall that when choosing x'_p , we gave preference to vertices whose representative's walk terminates at β (see the second condition in definition). Thus we would have chosen $x'_p = x'_q$, a contradiction. Finally, in case (iii), recall that $x'_q = a'$. But since the representative of a' is a , the walk \mathcal{D}_q terminates at α , a contradiction. This completes the proof of the lemma. \square

4 Algorithm for general target graphs

In this section we will generalize the invariant $i^*(H)$ and extend [Theorem 3' a\)](#) to all targets relevant target graphs H . Let us start with a simple observation, which is an analogue of [Observation 7](#).

Observation 29. *Let (G, L) be an instance of $\text{LHOM}(H)$. Without loss of generality we might assume the following.*

- (1) *The graph G is connected,*
- (2) *for each $x \in V(G)$, the set $L(x)$ is incomparable,*
- (3) *for each edge $xy \in E(G)$, for every $u \in L(x)$ there is $v \in L(y)$, such that $uv \in E(H)$.*

Proof. The first two items are analogous to the corresponding ones in [Observation 7](#). For the last item observe that if $u \in L(x)$ is non-adjacent (in H) to every element of $L(y)$, then we can safely remove u from $L(x)$. \square

The high-level idea is to reduce the general case of $\text{LHOM}(H)$ to the case, when the target is bipartite, and then use [Theorem 3' a\)](#). For this, we will consider the so-called *associated instances*, introduced by Feder, Hell, and Huang [\[21\]](#) (see [Section 4.1](#)).

We will also separately consider some special graphs that we call *strong split graphs*. A graph H is a *strong split graph*, if its vertex set can be partitioned into two sets B and P , where B is independent and P induces a reflexive clique. We call the pair (B, P) *the partition of H* . Note that the partition is unique: all vertices without loops must belong to B and all vertices with loops must belong to P .

4.1 Associated instances and clean homomorphisms

For a graph $G = (V, E)$, by G^* we denote the *associated bipartite graph*, defined as follows. The vertex set of G^* is the union of two independent sets: $\{x' : x \in V\}$ and $\{x'' : x \in V\}$. The vertices x' and y'' are adjacent if and only if $xy \in E$. Note that the edges of type $x'x''$ in G^* correspond to loops in G . The vertices x' and x'' are called *twins*.

Let (G, L) be an instance of $\text{LHOM}(H)$. An *associated instance* is the instance (G^*, L^*) of $\text{LHOM}(H^*)$, where L^* are *associated lists* defined as follows. For $x \in V(G)$, we set $L^*(x') = \{u' : u \in L(x)\}$ and $L^*(x'') = \{u'' : u \in L(x)\}$. Note that in the associated lists, the vertices appearing in the list of x' are precisely the twins of the vertices appearing in the list of x'' . A homomorphism $f : (G^*, L^*) \rightarrow H^*$ is *clean* if it maps twins to twins, i.e., $f(x') = u'$ if and only if $f(x'') = u''$. The following simple observation was the crucial step of the proof of the complexity dichotomy for list homomorphisms, shown by Feder, Hell, and Huang [\[21\]](#). We state it using slightly different language, which is more suitable for our purpose.

Proposition 30 (Feder, Hell, Huang [\[21\]](#)). *Let (G, L) be an instance of $\text{LHOM}(H)$. Then it is a yes-instance if and only if (G^*, L^*) admits a clean homomorphism to H^* .*

Let us point out that the restriction to clean homomorphisms is necessary for the equivalence. Indeed, consider for example $G = K_3$ and $H = C_6$, so clearly $G \not\rightarrow H$. However, we have $G^* \simeq C_6$ and $H^* \simeq 2C_6$, so $G^* \rightarrow H^*$.

Recall that if H is bipartite, then $\text{LHOM}(H)$ is polynomial-time solvable if H is the complement of a circular-arc graph [\[20\]](#), and NP-complete otherwise. Feder, Hell, and Huang [\[21\]](#) proved the following dichotomy theorem.

Theorem 31 (Feder, Hell, Huang [\[21\]](#)). *Let H be an arbitrary graph (with loops allowed).*

1. The $LHOM(H)$ problem is polynomial-time solvable if H is a bi-arc graph, and NP-complete otherwise.
2. The graph H is a bi-arc-graph if and only if H^* is the complement of a circular-arc graph.

So for our problem the interesting graphs H are those, for which H^* is not the complement of a circular-arc graph. In the observation below we summarize some properties of associated instances.

Observation 32. Consider an instance (G, L) of $LHOM(H)$ and the associated instance (G^*, L^*) of $LHOM(H^*)$. Suppose that G is given along with a tree decomposition of width t .

- (1) For each $v \in V(G)$ and $u \in V(H)$, we have $u \in L(v)$ if and only if $u' \in L^*(v')$ if and only if $u'' \in L^*(v'')$. In particular, each list is contained in one bipartition class of H^* .
- (2) In polynomial time we can construct a tree decomposition \mathcal{T}^* of G^* of width at most $2t$ with the property that for each $x \in V(G)$, each bag of \mathcal{T}^* either contains both x', x'' or none of them.

Proof. The first item follows directly from the definition of (G^*, L^*) . To see the second item, consider a tree decomposition \mathcal{T} of G . We construct \mathcal{T}^* by taking the same tree structure as for \mathcal{T} , and replacing each vertex v of G in each bag of \mathcal{T} by the vertices v', v'' of G^* . It is straightforward to verify that this way we obtain a tree decomposition of \mathcal{T}^* with the desired properties. \square

Observe that for bipartite H , the graph H^* consists of two disjoint copies of H , so clearly $i^*(H) = i^*(H^*)$. This motivates the following definition, generalizing [Definition 3](#).

Definition 8 ($i^*(H)$ for general H). Let H be a connected non-bi-arc graph. Define

$$i^*(H) := i^*(H^*).$$

4.2 Decompositions of general target graphs

In this section we generalize the notion of decompositions of bipartite graphs, introduced in [Section 2.1](#), to all graphs (with possible loops). The high-level idea is to define decompositions of H , so that they will correspond to bipartite decompositions of H^* . We consider the following three types of decompositions of a graph H (see [Figure 5](#)). Note that unless stated explicitly, we do not insist that any of the defined sets is non-empty.

Definition 9 (F -decomposition). A partition of $V(H)$ into an ordered triple of sets (F, K, Z) is an F -decomposition if the following conditions are satisfied (see [Figure 5](#), left).

1. K is non-empty and it separates F and Z ,
2. $|F| \geq 2$,
3. K induces a reflexive clique,
4. F is complete to K .

Definition 10 (BP -decomposition). A partition of $V(H)$ into an ordered five-tuple of sets (B, P, M, K, Z) is a BP -decomposition if the following conditions are satisfied (see [Figure 5](#), middle).

1. $K \cup M$ is non-empty and there are no edges between $(P \cup B)$ and Z ,
2. $|P| \geq 2$ or $|B| \geq 2$,
3. $K \cup P$ induces a reflexive clique and B is an independent set,
4. M is complete to $P \cup K$ and B is complete to K ,
5. B is non-adjacent to M .

Definition 11 (*B*-decomposition). A partition of $V(H)$ into an ordered six-tuple of sets $(B_1, B_2, K, M_1, M_2, Z)$ is a *B*-decomposition if the following conditions are satisfied (see Figure 5, right).

1. $K \cup M_1 \cup M_2$ is non-empty and it separates $(B_1 \cup B_2)$ and Z ,
2. $|B_1| \geq 2$ or $|B_2| \geq 2$,
3. K induces a reflexive clique and each of B_1, B_2 is an independent set,
4. K is complete to $M_1 \cup M_2 \cup B_1 \cup B_2$, and M_2 is complete to $M_1 \cup B_1$, and M_1 is complete to B_2 ,
5. B_1 is non-adjacent to M_1 and B_2 is non-adjacent to M_2 .

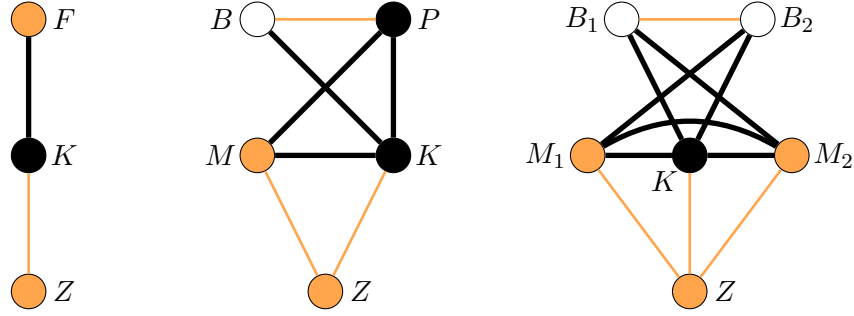

Figure 5: A schematic view of an *F*-decomposition (left), a *BP*-decomposition (middle), and a *B*-decomposition of H (right). Disks correspond to sets of vertices: white ones depict independent sets, black ones depict reflexive cliques, and orange ones depict arbitrary subgraphs. Similarly, thick black lines indicate that all possible edges between two sets exist, and thin orange lines depict edges that might exist, but do not have to. The lack of a line means that there are no edges between two sets.

Observe that a graph H can have more than one decomposition: for example, if (B, P, M, K, Z) is an *BP*-decomposition of H , but $M = \emptyset$, then $(B \cup P, K, Z)$ is an *F*-decomposition of H .

For each kind of decomposition, we define its *factors* as the following pair of graphs (H_1, H_2) .

for an *F*-decomposition: $H_1 = H[F]$ and H_2 is obtained from H by contracting F to a vertex f . It has a loop if and only if F is not an independent set.

for a *BP*-decomposition: $H_1 = H[B \cup P]$ and H_2 is obtained from H by contracting P and B respectively (if they are non-empty), to vertices p and b , such that p has a loop and b does not. Also, $pb \in E(H_2)$ if and only if there is any edge between P and B in H .

for a *B*-decomposition: $H_1 = H[B_1 \cup B_2]$ and H_2 is obtained from H by contracting B_1 and B_2 respectively (if they are non-empty), to vertices b_1 and b_2 (without loops). Also, $b_1b_2 \in E(H_2)$ if and only if there is any edge between B_1 and B_2 in H .

Let us prove that if H is not a strong split graph, then the three types of decompositions defined above precisely correspond to bipartite decompositions of the associated bipartite graph H^* . For any $W \subseteq V(H)$, we define two subsets of $V(H^*)$ as follows: $W' := \{x' : x \in W\}$ and $W'' := \{x'' : x \in W\}$.

Lemma 33. *Let H be a connected, non-bi-arc graph, which is not a strong split graph. Then H^* admits a bipartite decomposition if and only if H admits a *B*-, a *BP*-, or an *F*-decomposition.*

Proof. First, observe that a subset $W \subseteq V(H)$ induces a reflexive clique in H if and only if $W' \cup W''$ induces a biclique in H^* .

Let us show that if H has a decomposition, then H^* has a bipartite decomposition (D, N, R) . We consider three cases, depending on the type of a decomposition of H .

If H has an F -decomposition (F, K, Z) , we define D, N, R as follows (see Figure 6 a)):

$$\begin{aligned} D &:= F' \cup F'', \\ N &:= K' \cup K'', \\ R &:= Z' \cup Z''. \end{aligned}$$

Now the fact that (D, N, R) is a bipartite decomposition of H^* (recall Definition 2) follows directly from the definition of a F -decomposition (recall Definition 9): each property in Definition 2 follows from the corresponding property in Definition 9.

The other two cases are analogous. If H has a BP -decomposition, then we define D, N, R as follows (see Figure 6 b)):

$$\begin{aligned} D &:= B' \cup P'', \\ N &:= K' \cup M' \cup P' \cup K'', \\ R &:= Z' \cup Z'' \cup M'' \cup B''. \end{aligned}$$

Finally, if H has a B -decomposition $(B_1, B_2, K, M_1, M_2, Z)$, then we define D, N, R as follows (see Figure 6 c)):

$$\begin{aligned} D &:= B'_1 \cup B'_2, \\ N &:= K' \cup M'_1 \cup K'' \cup M'_2, \\ R &:= Z' \cup M'_2 \cup B'_2 \cup Z'' \cup M'_1 \cup B'_1. \end{aligned}$$

It is straightforward to verify that in both cases (D, N, R) is a bipartite decomposition of H^* .

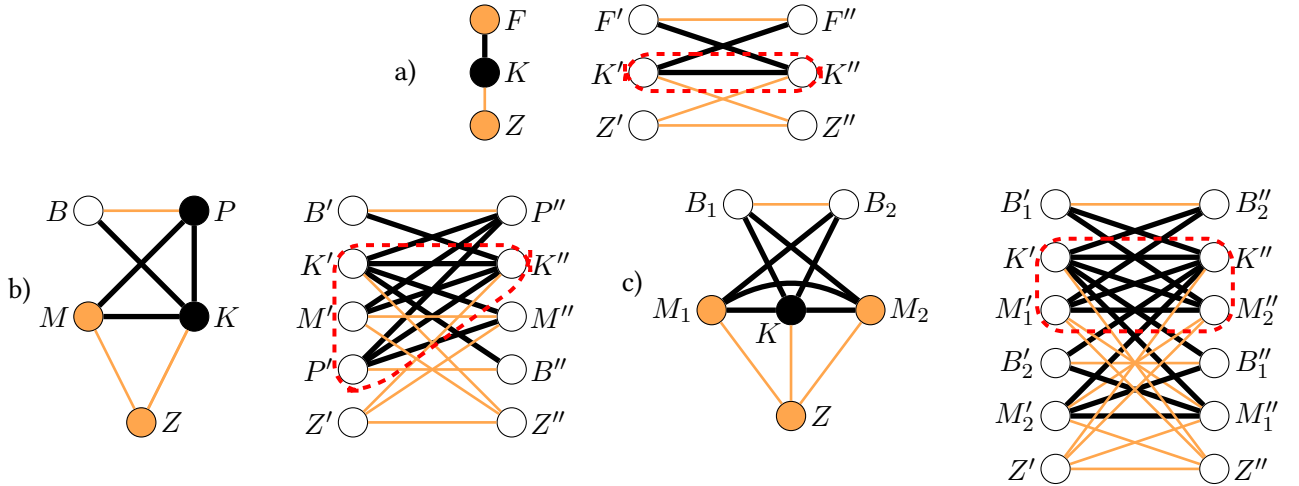

Figure 6: Decompositions of a graph H (left) and their corresponding bipartite decompositions (D, N, R) of H^* (right): a) an F -decomposition, b) a BP -decomposition and c) a B -decomposition. Dashed lines mark the set N .

Now we suppose that (D, N, R) is a bipartite decomposition of H^* and recall that $N \neq \emptyset$ and one bipartition class of D has at least two elements. We aim to show that H has one of the decompositions defined above. We partition the vertices of H into nine sets as follows (see Figure 7):

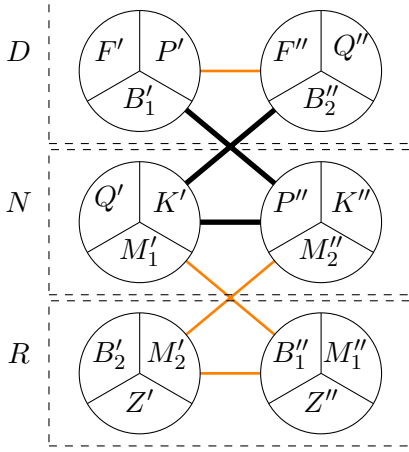

Figure 7: Schematic definition of sets in the proof of Lemma 33. E.g. P is the set of those $x \in V(G)$, for which $x' \in D$ and $x'' \in N$.

$$\begin{aligned}
F &:= \{x : x' \in D, x'' \in D\}, & Q &:= \{x : x' \in N, x'' \in D\}, & B_2 &:= \{x : x' \in R, x'' \in D\}, \\
P &:= \{x : x' \in D, x'' \in N\}, & K &:= \{x : x' \in N, x'' \in N\}, & M_2 &:= \{x : x' \in R, x'' \in N\}, \\
B_1 &:= \{x : x' \in D, x'' \in R\}, & M_1 &:= \{x : x' \in N, x'' \in R\}, & Z &:= \{x : x' \in R, x'' \in R\}.
\end{aligned}$$

Clearly, from the definition of the bipartite decomposition it follows that some pairs of these sets cannot be both non-empty (e.g. F and M_2 , because F' must be complete to M_2'' and in the same time F'' is non-adjacent to M_2'). Observe that $M_1 \cup Q \cup K$ is complete to $Q \cup B_2 \cup F \cup P \cup M_2 \cup K$ and $P \cup M_2 \cup K$ is complete to $B_1 \cup P \cup F \cup M_1 \cup Q \cup K$. Also, $B_1 \cup P \cup F$ is non-adjacent to $M_1 \cup B_1 \cup Z$ and $B_2 \cup Q \cup F$ is non-adjacent to $M_2 \cup B_2 \cup Z$. In particular, it implies that P, Q , and K must be reflexive cliques and B_1, B_2 are independent sets. Finally, at least one of the sets $B_1 \cup P \cup F$ and $B_2 \cup Q \cup F$ has at least two vertices and at least one of the sets $M_1 \cup Q \cup K$ and $P \cup M_2 \cup K$ is non-empty.

Case 1: $F \neq \emptyset$. It implies that $M_1, M_2 = \emptyset$. If $K \neq \emptyset$, then it is straightforward to observe that $(F \cup P \cup Q \cup B_1 \cup B_2, K, Z)$ is an F -decomposition of H . If $K = \emptyset$, then also $Z = \emptyset$, as we assumed that H is connected. Moreover, since $M_1 \cup M_2 \cup P \cup Q \cup K \neq \emptyset$, at least one of P, Q is non-empty. Assume that $P \neq \emptyset$, as the other case is symmetric. Recall that this means that $B_1 = \emptyset$.

If $Q \neq \emptyset$, then $B_2 = \emptyset$ and $(F \cup Q, P, \emptyset)$ is an F -decomposition. So let $Q = \emptyset$. If $|F| \geq 2$, then (F, P, B_2) is an F -decomposition. If $|B_2| \geq 2$ or $|P| \geq 2$, then $(B_2, P, F, \emptyset, \emptyset)$ is a BP -decomposition. So in the last case we have $|F| = |P| = 1$ and $|B_2| \leq 1$. It is easy to verify that then H is a bi-arc graph (or, equivalently, H^* does not contain an induced cycle on at least 6 vertices or an edge asteroid). This contradicts our assumption on H .

Case 2: $F = \emptyset$. We consider three subcases: either $B_1, B_2 \neq \emptyset$, or $B_1 = \emptyset$ and $B_2 \neq \emptyset$ (the case $B_1 \neq \emptyset$ and $B_2 = \emptyset$ is symmetric), or $B_1, B_2 = \emptyset$. The first case implies that $P, Q = \emptyset$, so we immediately obtain a B -decomposition $(B_1, B_2, K, M_1, M_2, Z)$.

In the second one we have $Q = \emptyset$. If $P \neq \emptyset$, then $M_1 = \emptyset$. If additionally $M_2 \cup K \neq \emptyset$, then there exists a BP -decomposition (B_2, P, M_2, K, Z) . On the other hand, if $M_2 \cup K = \emptyset$, then $Z = \emptyset$ by connectivity of

H . Thus the only non-empty sets are P and B_2 , and therefore H is a strong split graph. Finally, if $P = \emptyset$, then H admits a B -decomposition $(\emptyset, B_2, K, M_1, M_2, Z)$.

So let us assume that $B_1, B_2 = \emptyset$. We will consider further subcases: either $M_1, M_2 \neq \emptyset$, or $M_1 = \emptyset$ and $M_2 \neq \emptyset$ (the other case, i.e., $M_1 \neq \emptyset$ and $M_2 = \emptyset$, is symmetric), or $M_1, M_2 = \emptyset$. Note that if $M_1, M_2 \neq \emptyset$, then $P, Q = \emptyset$, so $D = \emptyset$, which is a contradiction with (D, N, R) being a bipartite decomposition of H^* . If $M_1 = \emptyset$ and $M_2 \neq \emptyset$, then $Q = \emptyset$ and $|P| \geq 2$ and we have a BP -decomposition $(\emptyset, P, M_2, K, Z)$. Lastly, when $M_1, M_2 = \emptyset$, then without loss of generality $|P| \geq 2$ and either $(P, Q \cup K, Z)$ is an F -decomposition, or $Q \cup K = \emptyset$, then by connectivity of H the set Z must be empty and H is just a reflexive clique induced by P . However, such a graph is a bi-arc graph, a contradiction. \square

Let us point out that one application of a BP -decomposition or a B -decomposition corresponds to two consecutive applications of a bipartite decomposition in H^* . Consider the case of a BP -decomposition and the bipartite decomposition $(B' \cup P'', K' \cup M' \cup P' \cup K'', Z' \cup M'' \cup B'' \cup Z'')$ of H' . Note that after contracting B' to b' and P'' to p'' , we still have a decomposition $(P' \cup B'', K' \cup K'' \cup M'' \cup \{p''\}, M' \cup \{b'\} \cup Z' \cup Z'')$ of the second factor $(H^*)_2$ of H^* . Similarly, in the case of a B -decomposition, we still have another bipartite decomposition of $(H^*)_2$, where the new set D is $B'_1 \cup B'_2$.

Note that in a BP -decomposition, a B -decomposition, and an F -decomposition, when F is an independent set or contains a vertex with a loop, the factors are always induced subgraphs of H . Indeed, we can equivalently obtain H_2 by removing certain vertices from H . In the last case of an F -decomposition, when F contains at least one edge and has only vertices without loops, H_2 is not an induced subgraph of H . We can equivalently define H_2 as the graph obtained by removing from F all but two vertices that are adjacent to each other, and then replacing them with a vertex with a loop.

In the following lemma we consider a graph H' that was obtained from H by a series of decompositions (i.e., it is a factor of H , or a factor of a factor of H etc.). We show that even if H' is not an induced subgraph of H , the associated bipartite graph H'^* is still an induced subgraph of H^* .

Lemma 34. *Let H' be a graph obtained from H by a series of decompositions. Then H'^* is an induced subgraph of H^* .*

Proof. Recall that by the definitions of decompositions, H' was obtained from H by a sequence of two types of operations:

- (O1) removing some vertices or, equivalently, taking an induced subgraph (BP -decomposition, B -decomposition, and F -decomposition when the set F contains a vertex with a loop or is independent),
- (O2) removing some vertices and then contracting two adjacent vertices a, b , such that $N(a) - \{b\} = N(b) - \{a\}$ and none of a, b has a loop, to a vertex c with a loop; vertices a and b are removed from the graph and the new vertex c becomes adjacent to all vertices in $N(a) - \{b\} = N(b) - \{a\}$ (F -decomposition, when F has no vertex with a loop and contains at least one edge, see Figure 8).

Observe that if only the first type of operation was applied, then H' is an induced subgraph of H , which implies that H'^* is an induced subgraph of H^* . Let us analyze the case when some operations of the second type were applied as well.

In this case H' might not be an induced subgraph of H , but each newly created vertex c uniquely corresponds to two adjacent vertices, i.e., a, b . Moreover, when the operation was applied, a and b had the same neighborhoods in the current graph, except of being adjacent to each other. Note that both a and b are vertices of H : they do not have loops, while we only add vertices with loops. Furthermore, when c is created, a and b are removed from a graph, so each vertex is used in the operation of the second type at most once.

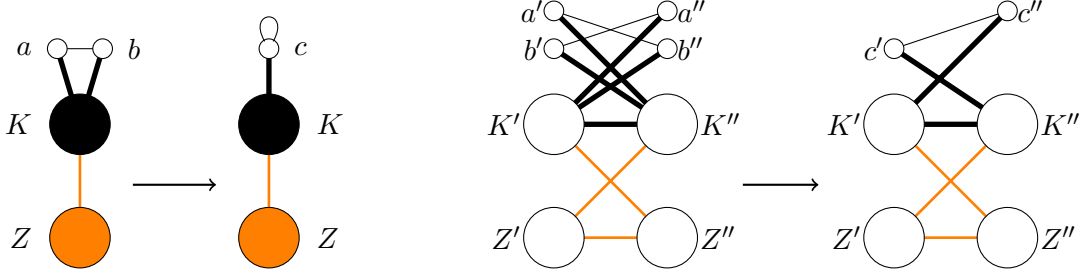

Figure 8: Operation (O2) applied to vertices a, b in H (left) and corresponding operation applied to vertices a', a'', b', b'' in H^* (right).

Let us consider H^* . Note that the edge ab of H corresponds to two edges $a'b''$ and $a''b'$ in H^* . Note that we can map the vertex c' to a' and c'' to b'' . Since $N(a) - \{b\} = N(b) - \{a\}$, when the operation was applied, the associated bipartite graph of the obtained graph is indeed an induced subgraph of H^* , and the mapping mentioned above defines the isomorphism from H^* to a subgraph of H^* . \square

Finally, we show an analogue of [Lemma 9](#), where we explain how decompositions can be used algorithmically. Recall that $T(H, n, t)$ denotes an upper bound for the complexity of $\text{LHOM}(H)$ on instances with n vertices, given along a tree decomposition of width t . In the following lemma we do not assume that $|H|$ is a constant.

Lemma 35 (General decomposition lemma). *Let H be a connected, non-bi-arc graph, and let Γ be a decomposition of H (i.e., Γ is either an F -, a BP -, or a B -decomposition) with factors H_1, H_2 . If there exist constants $c \geq 1$ and $d > 2$ such that $T(H_1, n, t) = \mathcal{O}(c^t \cdot (n \cdot |H_1|)^d)$ and $T(H_2, n, t) = \mathcal{O}(c^t \cdot (n \cdot |H_2|)^d)$, then $T(H, n, t) = \mathcal{O}(c^t \cdot (n \cdot (|H| + 2))^d)$.*

Since every type of decomposition is handled in a slightly different way, for the sake of readability we split [Lemma 35](#) into three lemmas, one for each type of decomposition. Their proofs are similar to the proof of [Lemma 9](#). We also take more care about constants to make sure that the estimation holds even if H is not fixed.

Lemma 36 (F -decomposition lemma). *Let H be a connected, non-bi-arc graph, and let (F, K, Z) be an F -decomposition of H . If there exist constants $\alpha, c \geq 1$ and $d > 2$ such that $T(H_1, n, t) \leq \alpha \cdot c^t \cdot (n \cdot |H_1|)^d$ and $T(H_2, n, t) \leq \alpha \cdot c^t \cdot (n \cdot |H_2|)^d$, then $T(H, n, t) \leq \alpha \cdot c^t \cdot (n \cdot |H|)^d$, provided that n is sufficiently large.*

Proof. Let (G, L) be an instance of $\text{LHOM}(H)$ with n vertices, given along with a tree decomposition of width t . Define $Q := \{x \in V(G) : L(x) \cap K \neq \emptyset\}$ and note that by [Observation 29 \(2\)](#) no vertex from Q has a vertex from F in its list. First, we observe that an analogue of [Claim 9.1](#) in the proof of [Lemma 9](#) holds in this situation too (the proof is essentially the same as the proof of [Claim 9.1](#), so we do not repeat it).

Claim 36.1. *If there exists a list homomorphism $h: (G, L) \rightarrow H$, the image of each $C \in \text{comp}(G - Q)$ is entirely contained either in F or in Z . \blacksquare*

For every $x \in V(G) - Q$ we define $L_1(x) := L(x) \cap F$ and for every component $C \in \text{comp}(G - Q)$ we check if there exists a homomorphism $h_C : (C, L_1) \rightarrow H_1$. Let \mathbb{C}_1 be the set of those $C \in \text{comp}(G - Q)$, for which h_C exists.

Now let us define an instance (G, L_2) of $\text{LHOM}(H_2)$ as follows. If $x \in Q$, then we set $L_2(x) := L(x)$, note that in this case $F \cap L(x) = \emptyset$. On the other hand, if $x \notin Q$, then it is in exactly one $C \in \text{comp}(G - Q)$. If $C \in \text{comp}(G - Q) - \mathbb{C}_1$, then we set $L_2(x) := L(x) - F$. If $C \in \mathbb{C}_1$, then we set $L_2(x) := L(x) - F \cup \{f\}$.

Claim 36.2. *There exists a list homomorphism $h : (G, L) \rightarrow H$ if and only if there exists a list homomorphism $h' : (G, L_2) \rightarrow H_2$.*

Proof of Claim. First, assume that $h : (G, L) \rightarrow H$ exists. We define $h' : V(G) \rightarrow V(H_2)$ as follows:

$$h'(x) := \begin{cases} f & \text{if } h(x) \in F, \\ h(x) & \text{otherwise.} \end{cases}$$

It is straightforward to verify that h' is a homomorphism from G to H_2 . Let us show that it respects lists L_2 . Indeed, consider a vertex $x \in V(G)$. If $h(x) \notin F$, then $h'(x) = h(x) \in L(x) - F \subseteq L_2(x)$. On the other hand, if $h(x) \in F$, then $L(x) \cap F \neq \emptyset$, so x is in some $C \in \text{comp}(G - Q)$. Since $h(x) \in F$, then by [Claim 36.1](#) the image of C is contained in F , so $C \in \mathbb{C}_1$. Thus $h'(x) = f \in L_2(x)$.

Now assume that there exists a homomorphism $h' : (G, L_2) \rightarrow H_2$. We define $h : V(G) \rightarrow V(H)$ as follows. If $h'(x) \neq f$, then we set $h(x) := h'(x)$. On the other hand, if $h'(x) = f$, then we know that x belongs to some $C \in \mathbb{C}_1$. In this case we set $h(x) := h_C(x)$. Note that h respects lists L , as in the first case $h'(x) = h(x)$ clearly belongs to $(L_2(x) - \{f\}) \subseteq L(x)$, and in the second one it follows from the definition of h_C .

Now let us show that h is a homomorphism. Consider an edge $xy \in E(G)$. If $h'(x) = h'(y) = f$, then $x, y \notin Q$, so they must both belong to the same $C \in \mathbb{C}_1$ and $h(x)h(y) = h_C(x)h_C(y) \in E(H)$, by the definition of h_C . Similarly, if $h'(x), h'(y) \in K \cup Z$, we have that $h(x)h(y) = h'(x)h'(y) \in E(H)$ by the definition of h' .

So suppose that $h'(x) = f$ and $h'(y) \in K \cup Z$. Note that since h' is a homomorphism, we have $h'(y) \in K$. Recall that the set K is complete to F , so $h(x) \in F$ is adjacent to $h(y) = h'(y) \in K$. ■

Computing Q and $\text{comp}(G - Q)$ can be done in total time $\mathcal{O}(n|H| + n^2) = \mathcal{O}((n \cdot |H|)^2)$. Computing h_C for all $C \in \text{comp}(G - Q)$ requires time at most

$$\sum_{C \in \text{comp}(G - Q)} T(H_1, |C|, t) \leq \sum_{C \in \text{comp}(G - Q)} \alpha \cdot c^t \cdot (|H_1| \cdot |C|)^d \leq \alpha \cdot c^t \cdot (|H_1| \cdot n)^d.$$

Computing lists L_2 can be performed in time $\mathcal{O}(|H| \cdot n)$. Finally, computing h' requires time $T(H_2, n, t) \leq \alpha \cdot c^t \cdot (|H_2| \cdot n)^d$. Similarly to the proof of [Lemma 9](#), if n is sufficiently large, then the total running time can be bounded by $\alpha \cdot c^t \cdot (|H| \cdot n)^d$, as claimed. □

The case of a *BP*-decomposition is slightly more complicated, as there might be vertices of G , whose lists contain both vertices from P (which is a part of H_1) and from M (which is a part of the separator). These vertices require special handling.

Lemma 37 (BP-decomposition lemma). *Let H be a connected, non-bi-arc graph, and let (B, P, M, K, Z) be a BP-decomposition of H with factors H_1, H_2 . If there exist constants $\alpha, c \geq 1$ and $d > 2$ such that $T(H_1, n, t) \leq \alpha \cdot c^t \cdot (n \cdot |H_1|)^d$ and $T(H_2, n, t) \leq \alpha \cdot c^t \cdot (n \cdot |H_2|)^d$, then $T(H, n, t) \leq \alpha \cdot c^t \cdot (n \cdot |H|)^d$, provided that n is sufficiently large.*

Proof. Let (G, L) be an instance of $\text{LHom}(H)$ with n vertices, given along with a tree decomposition of with t . We define $Q := \{x \in V(G) : L(x) \cap (M \cup K) \neq \emptyset\}$. We say that a vertex $x \in V(G)$ is of *type B* (resp. *type P*) if $L(x) \cap B \neq \emptyset$ (resp. $L(x) \cap P \neq \emptyset$). Note that by [Observation 29 \(2\)](#) no vertex is simultaneously of type B and type P. Moreover, no vertex of type B is in Q . Let Q' be the set of vertices of type P in Q . Note that by [Observation 29 \(2\)](#) each vertex from Q' has in its list some vertices from M and some vertices from P , but no vertices from K .

Notice that now we cannot just consider components of $G - Q$ independently from each other and from the vertices from Q , as we did in the case of an F -decomposition. This is because the coloring we choose for these components influences the coloring of vertices from Q' , which in turn influences the coloring of some other components of $G - Q$. Thus, instead of considering components of $G - Q$ separately, we gather them together with their neighbors from Q' and only then compute the homomorphisms to H_1 . This intuition is formalized by the following argument.

Let $\mathbb{S}_1, \mathbb{S}_2$, and \mathbb{S} be families of sets defined as follows

$$\mathbb{S}_1 := \bigcup_{C \in \text{comp}(G-Q)} \{V(C)\} \quad \text{and} \quad \mathbb{S}_2 := \bigcup_{x \in Q'} \{\{x\}\} \quad \text{and} \quad \mathbb{S} := \mathbb{S}_1 \cup \mathbb{S}_2.$$

Let $\sim \subseteq \mathbb{S}^2$ be a relation, defined as follows: $S_1 \sim S_2$ if and only if (i) $S_1 \in \mathbb{S}_1$, i.e., it is a vertex set of some $C \in \text{comp}(G - Q)$ and (ii) $S_2 \in \mathbb{S}_2$, i.e., $S_2 = \{x\}$ for some $x \in Q'$, and (iii) x is adjacent to some vertex of type B from S_1 . Let $\simeq \subseteq \mathbb{S}^2$ be the smallest equivalence relation containing \sim and consider the set \mathbb{S}/\simeq of equivalence classes of \simeq .

Now we form the set \mathbb{C}' as follows. Consider a class $\pi \in \mathbb{S}/\simeq$, it is a subset of $\mathbb{S}_1 \cup \mathbb{S}_2$, i.e., a family of pairwise disjoint subsets of $(V(G) - Q) \cup Q'$. We construct a subgraph C' of G , whose vertex set is the union of all sets in π . An edge $xy \in E(G)$ exists in C' if its both endvertices belong to one element of π (i.e., it is an edge of some $C \in \text{comp}(G - Q)$, such that $V(C) \in \pi$), or is an edge joining some $x \in Q'$, such that $\{x\} \in \pi$, with a vertex y , which is a vertex of type B in C , such that $V(C) \in \pi$. Note that the edges of the second kind are exactly the edges which justified including $\{x\}$ and $V(C)$ in the same equivalence class $\pi \in \mathbb{S}/\simeq$. Moreover, each $C' \in \mathbb{C}'$ is connected. Finally, we define $\mathbb{C} := \{G[V(C')] : C' \in \mathbb{C}'\}$, observe that it is a set of pairwise disjoint induced subgraphs of G .

The following analogue of [Claim 9.1](#) and [Claim 36.1](#) is a crucial step towards proving the lemma.

Claim 37.1. *If there exists a list homomorphism $h: (G, L) \rightarrow H$, the image of each $C \in \mathbb{C}$ is entirely contained either in $P \cup B$ or in $M \cup Z$.*

Proof of Claim. Consider $C \in \mathbb{C}$ and assume that there exist $x, y \in V(C)$ such that $h(x) \in P \cup B$ and $h(y) \in M \cup Z$. Recall that there exists $C' \in \mathbb{C}'$, which is a connected spanning subgraph of C . Let \mathcal{P} be a x - y -path in C' . Recall that no vertex of C (and thus of \mathcal{P}) has a vertex from K in its list. This implies that on \mathcal{P} there exists an edge zz' , such that $h(z) \in P$ and $h(z') \in M$. Clearly, $z' \in Q'$. Moreover, $z \notin Q'$, as in C' there are no edges between vertices of Q' . So z must be a vertex of type P from $V(G) - Q$. However, in C' there are no edges between Q' and vertices of type P in $V(G) - Q$, a contradiction. ■

Let $C \in \mathbb{C}$. For every $x \in V(C)$ we define $L_1(x) := L(x) \cap (P \cup B)$. Denote by \mathbb{C}_1 the set of these subgraphs $C \in \mathbb{C}$, for which there exists a list homomorphism $h_C : (C, L_1) \rightarrow H_1$. We define an instance (G, L_2) of $\text{LHom}(H_2)$ as follows:

$$L_2(x) := \begin{cases} L(x) - P \cup \{p\} & \text{if } x \text{ is of type } P \text{ and belongs to some subgraph in } \mathbb{C}_1, \\ L(x) - B \cup \{b\} & \text{if } x \text{ is of type } B \text{ and belongs to some subgraph in } \mathbb{C}_1, \\ L(x) - (P \cup B) & \text{otherwise.} \end{cases}$$

Recall that no vertex x is simultaneously of type P and B , so L_2 is well-defined. Now let us show the following.

Claim 37.2. *There exists a list homomorphism $h : (G, L) \rightarrow H$ if and only if there exists a list homomorphism $h' : (G, L_2) \rightarrow H_2$.*

Proof of Claim. First, assume that $h : (G, L) \rightarrow H$ exists. Define $h' : V(G) \rightarrow V(H_2)$ in the following way:

$$h'(x) := \begin{cases} p & \text{if } h(x) \in P, \\ b & \text{if } h(x) \in B, \\ h(x) & \text{otherwise.} \end{cases}$$

The fact that h' is a homomorphism follows from the definition of H_2 and the fact that h is a homomorphism. We need to show for every x we have $h'(x) \in L_2(x)$.

If $h'(x) \notin \{p, b\}$, then $h'(x) = h(x) \in L(x) - (P \cup B) \subseteq L_2(x)$. So assume that $h'(x) \in \{p, b\}$. This means that $h(x) \in P \cup B$, so $x \in (V(G) - Q) \cup Q'$. This means that x belongs to some $C \in \mathbb{C}$, and since $h(x) \in P \cup B$, by Claim 37.1, we observe that $C \in \mathbb{C}_1$. Moreover, if $h'(x) = p$, then x is of type P , and if $h'(x) = b$, then x is of type B . Therefore $h'(x) \in L_2(x)$.

Now suppose there exists a list homomorphism $h' : (G, L_2) \rightarrow H_2$. We define a mapping $h : V(G) \rightarrow V(H)$ as follows. If $h'(x) \notin \{p, b\}$, then $h(x) := h'(x)$. Otherwise, by the definition of L_2 , the vertex x must belong to exactly one subgraph C in \mathbb{C}_1 . In this case we set $h(x) := h_C(x)$. Note that for every $x \in V(G)$ we have $h(x) \in L(x)$: if $h'(x) \notin \{p, b\}$, then $h(x) = h'(x) \in L_2(x) - \{p, b\} \subseteq L(x)$, and if $h'(x) \in \{p, b\}$, then $h(x) \in L(x)$ by the definition of h_C .

Now let us show that h is a homomorphism. Let xy be an edge of G and consider the following cases.

1. If $h'(x), h'(y) \notin \{p, b\}$, then $h(x)h(y) = h'(x)h'(y) \in E(H_2 - \{p, b\}) \subseteq E(H)$, by the fact that h' is a homomorphism.
2. If $h'(x) = b$ and $h'(y) = p$, then x is of type B and is in $V(G) - Q$, while y is of type P and belongs to $(V(G) - Q) \cup Q'$. Recall that by the definition of \sim , vertices x, y belong to the same subgraph $C \in \mathbb{C}$. Moreover, $C \in \mathbb{C}_1$, as only in this case p and b could appear on the lists of x, y . This gives $h(x)h(y) = h_C(x)h_C(y) \in E(H_1) \subseteq E(H)$, by the definition of h_C .
3. The case $h'(x) = h'(y) = b$ cannot occur, as h' is a homomorphism and b has no loop.
4. If $h'(x) = h'(y) = p$, then $p \in L_2(x) \cap L_2(y)$, so both x, y are of type P , and each of them belongs to some subgraph in \mathbb{C}_1 . Let us call these subgraphs C_x and C_y , respectively, and observe that $h(x) = h_{C_x}(x)$ and $h(y) = h_{C_y}(y)$. As h_{C_x} and h_{C_y} are homomorphisms to H_1 , we know that $h_{C_x}(x), h_{C_y}(y) \in P \cup B$. But since neither $L(x)$ or $L(y)$ contains elements from B , we have $h_{C_x}(x), h_{C_y}(y) \in P$. This means that $h(x)h(y) = h_{C_x}(x)h_{C_y}(y)$ is an edge of H , as P is a reflexive clique.
5. If $h'(x) = b$ and $h'(y) \notin \{p, b\}$, then $h'(y) = h(y) \in K$, as h' maps xy to an edge of H_2 . Again, let C be the subgraph from \mathbb{C}_1 which contains x and observe that x must be of type B , as $b \in L_2(x)$. So $h(x) = h_C(x) \in B$, which implies that $h(x)h(y) \in E(H)$, as B is complete to K .
6. If $h'(x) = p$ and $h'(y) \notin \{p, b\}$, then $h'(y) = h(y) \in K \cup M$. Again, let C be the subgraph in \mathbb{C}_1 , which contains x and observe that p is of type P . So $h(x) = h_C(x) \in P$, which implies that $h(x)h(y) \in E(H)$, as P is complete to $K \cup M$.

This concludes the proof of the claim. ■

The running time analysis is analogous to the case of an F -decomposition. Note that \mathbb{S}/\sim and thus \mathbb{C} can be computed in total time $\mathcal{O}(n \cdot |H|)^2$. With a reasoning analogous to the one in the proof of Lemma 36, we conclude that if n is sufficiently large, then the problem can be solved in time $\alpha \cdot c^t \cdot (n \cdot |H|)^d$. □

The final lemma, concerning B -decompositions, is the most complicated one. Since in this case the first factor, H_1 , is bipartite, we know that every subgraph C of G that is mapped to H_1 must be bipartite too. However, unlike in the case when the whole graph H is bipartite (i.e., [Lemma 9](#)), we do not know in advance which bipartition class of C is mapped to which bipartition class of H_1 . Thus for every C we need to consider both possibilities.

Lemma 38 (B -decomposition lemma). *Let H be a connected, non-bi-arc graph, and let $(B_1, B_2, K, M_1, M_2, Z)$ be a B -decomposition of H . If there exist constants α, c, d such that $T(H_1, n, t) \leq \alpha/2 \cdot c^t \cdot (n \cdot |H_1|)^d$ and $T(H_2, n, t) \leq \alpha \cdot c^t \cdot (n \cdot |H_2|)^d$, then $T(H, n, t) \leq \alpha \cdot c^t \cdot (n \cdot |H|)^d$, provided that n is sufficiently large.*

Proof. Let (G, L) be an instance of $\text{LHOM}(H)$ with n vertices, given along with a tree decomposition of with t . We define $Q := \{x \in V(G) : L(x) \cap (M_1 \cup M_2 \cup K) \neq \emptyset\}$. Furthermore we define two subsets of Q as follows: $Q_1 := \{x \in Q : L(x) \cap B_1 \neq \emptyset\}$ and $Q_2 := \{x \in Q : L(x) \cap B_2 \neq \emptyset\}$. Note that by [Observation 29 \(2\)](#), if $L(x)$ contains a vertex from K , then $x \notin Q_1 \cup Q_2$. Furthermore, if $L(x)$ contains a vertex from M_1 , then $x \notin Q_1$, and if $L(x)$ contains a vertex from M_2 , then $x \notin Q_2$. This means that Q_1 is disjoint with Q_2 . Moreover, every vertex from Q_1 has in its list a vertex from B_1 and a vertex from M_2 , while every vertex from Q_2 has in its list a vertex from B_2 and a vertex from M_1 .

Similarly to e.g. [Claim 36.1](#), we observe that every connected component C of $G - Q$ must be entirely mapped either to $B_1 \cup B_2$ or to Z . Recall that $H_1 = H[B_1 \cup B_2]$ is bipartite, so if C is not bipartite, then we can safely remove all vertices from $B_1 \cup B_2$ from the lists of vertices of C , let us still call these lists L . Let S_1 be the set of bipartite components of $G - Q$.

Now let us consider an auxiliary graph G' defined as follows. The vertex set of G' is $Q_1 \cup Q_2$. We add to G' all edges of G with one end in Q_1 and the other in Q_2 . Observe that for each component C of G' and any list homomorphism $(G, L) \rightarrow H$, either all vertices of C are mapped to $B_1 \cup B_2$ (with $V(C) \cap Q_1$ mapped to B_1 and $V(C) \cap Q_2$ mapped to B_2), or all vertices of C are mapped to $M_1 \cup M_2 \cup Z$ (with $V(C) \cap Q_1$ mapped to $M_2 \cup Z$ and $V(C) \cap Q_2$ mapped to $M_1 \cup Z$). Again, recall that $H[B_1 \cup B_2] = H_1$ is bipartite. Thus if for any $C \in \text{comp}(G')$, the graph $G[V(C)]$ is not bipartite, then we can safely remove all vertices from $B_1 \cup B_2$ from the lists of the vertices of C . We still call these lists L . Let S_2 be the set of those $C \in \text{comp}(G')$, for which $G[V(C)]$ is bipartite. Note that in this case $C = G[V(C)]$.

Observe that $S_1 \cup S_2$ is a collection of pairwise vertex-disjoint bipartite induced subgraphs of G . Furthermore, no vertex appearing in a subgraph from $S_1 \cup S_2$ has a vertex from K in its list. Moreover, we observe that for any list homomorphism $(G, L) \rightarrow H$, each $C \in S_1 \cup S_2$ must be entirely mapped to $B_1 \cup B_2$ or to $M_1 \cup M_2 \cup Z$. This is straightforward for $C \in S_1$, as these vertices do not contain any vertex from $K \cup M_1 \cup M_2$ in their lists. For $C \in S_2$, we can observe that in the other case we would obtain $uv \in E(C)$, such that u is mapped to a vertex in B_1 and v is mapped to a vertex in M_2 , or u is mapped to a vertex in B_2 and v is mapped to a vertex in M_1 . However, notice that for no edge of C such configuration of lists is possible.

Let $C \in S_1 \cup S_2$ and suppose it gets mapped to $B_1 \cup B_2$. If $C \in S_2$, then we know which bipartition class of C is mapped to B_1 and which is mapped to B_2 , i.e., $V(C) \cap Q_1$ is mapped to B_1 and $V(C) \cap Q_2$ is mapped to B_2 . On the other hand, if $C \in S_1$, both options might be possible.

We define a set \mathbb{S}_1 as follows: for each $C \in S_1$ with bipartition classes X, Y , we add to \mathbb{S}_1 two triples: (C, X, Y) and (C, Y, X) . Similarly we define a set \mathbb{S}_2 : for each $C \in S_2$, we add to \mathbb{S}_2 the triple $(C, V(C) \cap Q_1, V(C) \cap Q_2)$. Finally, define $\mathbb{S} := \mathbb{S}_1 \cup \mathbb{S}_2$.

The intuition behind \mathbb{S} is that it represents the subgraphs that could be mapped to $B_1 \cup B_2$, taking into considerations that some of them (i.e., the ones from S_1) could be mapped to $B_1 \cup B_2$ in two ways. A triple $(C, X, Y) \in \mathbb{S}$ indicates that C could be potentially mapped to $B_1 \cup B_2$ in a way that X is mapped to B_1 and Y is mapped to B_2 .

Now we proceed similarly to the proof of Lemma 37. We define a relation $\sim \subseteq \mathbb{S}^2$, so that $(C_1, X_1, Y_1) \sim (C_2, X_2, Y_2)$ if and only if the following conditions hold: (i) $(C_1, X_1, Y_1) \in \mathbb{S}_1$, and (ii) $(C_2, X_2, Y_2) \in \mathbb{S}_2$, and (iii) there is an edge with one endvertex in X_1 and the other in Y_2 , or an edge with one endvertex in Y_1 , and the other in X_2 . Note that if $(C_1, X_1, Y_1) \sim (C_2, X_2, Y_2)$ and there is a list homomorphism $h: (G, L) \rightarrow H$, then either: (i) both C_1 and C_2 are mapped to $B_1 \cup B_2$ where $h(X_1 \cup X_2) \subseteq B_1$ and $h(Y_1 \cup Y_2) \subseteq B_2$, or (ii) no vertex from $X_1 \cup X_2$ is mapped to B_1 and no vertex from $Y_1 \cup Y_2$ is mapped to B_2 . This is because lists of vertices from $X_1 \cup Y_1$ do not contain any vertex from $K \cup M_1 \cup M_2$, while lists of vertices of X_2 (resp. Y_2) do not contain any vertex from $M_1 \cup B_2 \cup K$ (resp. $M_2 \cup B_1 \cup K$).

Now let \simeq be the smallest equivalence relation containing \sim , and let \mathbb{S}/\simeq be the set of equivalence classes of \simeq . We will define a set \mathbb{C} of subgraphs of G .

Consider an equivalence class $\pi = \{(C_1, X_1, Y_1), \dots, (C_s, X_s, Y_s)\}$ from \mathbb{S}/\simeq , and define $X_\pi := \bigcup_{i \in [s]} X_i$ and $Y_\pi := \bigcup_{i \in [s]} Y_i$. Let C_π be the subgraph of G induced by $X_\pi \cup Y_\pi$. Recall that by the definition of \sim , either (i) all vertices from X_π must be mapped to B_1 and all vertices from Y_π must be mapped to B_2 , or (ii) no vertex from X_π is mapped to B_1 and no vertex from Y_π is mapped to B_2 . Thus if C_π is not bipartite, then we can safely remove all vertices from B_1 from the lists of X_π and all vertices from B_2 from the lists of Y_π , we still call these lists L .

On the other hand, if C_π is bipartite, we note that its bipartition classes are exactly X_π and Y_π . We add to \mathbb{C} the triple (C_π, X_π, Y_π) . Now \mathbb{C} can be seen as a collection of bipartite induced subgraphs of G , containing only vertices from $(V(G) - Q) \cup (Q_1 \cup Q_2)$, such that each vertex from $V(G) - Q$ appears in at most two of them, while every vertex from $Q_1 \cup Q_2$ appears in one of them.

We claim that at the current step the following holds.

Claim 38.1. *If x is a vertex such that $L(x) \cap B_1 \neq \emptyset$ (resp. $L(x) \cap B_2 \neq \emptyset$), then there exists $(C, X, Y) \in \mathbb{C}$, such that $x \in X$ (resp. $x \in Y$).*

Proof of Claim. Let us show the claim for the case that $L(x) \cap B_1 \neq \emptyset$, as the other case is symmetric. Note that since x has a vertex from B_1 in its list, then either $x \in Q_1$ or $x \in V(G) - Q$.

In the first case, note that there is exactly one $(C', X', Y') \in \mathbb{S}_2$, such that $x \in X' \cup Y'$, and, since $x \in Q_1$, we know that $x \in X'$. Consider the class π in \mathbb{S}/\simeq containing (C', X', Y') , and the triple (C_π, X_π, Y_π) . Clearly $x \in X_\pi$. Note that if C_π is not bipartite, we would have removed all vertices of B_1 from the list of x . But since $L(x) \cap B_1 \neq \emptyset$, the graph C_π must be bipartite and thus (C_π, X_π, Y_π) is the desired triple in \mathbb{C}_1 .

So suppose that $x \in V(G) - Q$, and therefore x is in some bipartite connected component C' of $G - Q$. Let X', Y' be the bipartition classes of C' , such that $x \in X'$. Recall that both triples (C', X', Y') and (C', Y', X') are in \mathbb{S}_1 . Let π and π' be the equivalence classes from \mathbb{S}/\simeq , containing (C', X', Y') and (C', Y', X') , respectively.

Observe that if $\pi = \pi'$, then $x \in X_\pi \cap Y_\pi$ and C_π is not bipartite. Indeed, the definition of \sim implies that there is an odd length walk starting and terminating at x . So in this case we have removed all vertices from $B_1 \cup B_2$ from the list of x .

So finally assume that $\pi \neq \pi'$ and consider (C_π, X_π, Y_π) and $(C_{\pi'}, X_{\pi'}, Y_{\pi'})$. Note that $x \in X_\pi \cap Y_{\pi'}$. If C_π is not bipartite, then we would have removed all vertices of B_1 from the list of x . Therefore C_π must be bipartite and $(C_\pi, X_\pi, Y_\pi) \in \mathbb{C}$ is the desired triple. \blacksquare

The following claim follows from the definition of \mathbb{C} and the reasoning there.

Claim 38.2. *Let $(C, X, Y) \in \mathbb{C}$ and suppose that there exists a list homomorphism $h: (G, L) \rightarrow H$.*

(a) *The image of C is entirely contained in $B_1 \cup B_2$ or in $M_1 \cup M_2 \cup Z$.*

(b) If the image of C is contained in $B_1 \cup B_2$, then either $h(X) \subseteq B_1$ and $h(Y) \subseteq B_2$ or $h(X) \subseteq B_2$ and $h(Y) \subseteq B_1$. \blacksquare

Let $(C, X, Y) \in \mathbb{C}$. For every $x \in X$ we define $L_1(x) := L(x) \cap B_1$ and for every $x \in Y$ we define $L_1(x) := L(x) \cap B_2$. Denote by \mathbb{C}_1 the set of these triples $(C, X, Y) \in \mathbb{C}$, for which there exists a homomorphism $h_{(C, X, Y)} : (C, L_1) \rightarrow H_1$.

We define an instance (G, L_2) of $\text{LHOM}(H_2)$ as follows:

$$L_2(x) := \begin{cases} L(x) - (B_1 \cup B_2) \cup \{b_1, b_2\} & \text{if there is some } (C_1, X_1, Y_1) \in \mathbb{C}_1, \text{ such that } x \in X_1 \\ & \text{and some } (C_2, X_2, Y_2) \in \mathbb{C}_1, \text{ such that } x \in Y_2, \\ L(x) - (B_1 \cup B_2) \cup \{b_1\} & \text{if there is some } (C_1, X_1, Y_1) \in \mathbb{C}_1, \text{ such that } x \in X_1, \\ & \text{but no } (C_2, X_2, Y_2) \in \mathbb{C}_1, \text{ such that } x \in Y_2, \\ L(x) - (B_1 \cup B_2) \cup \{b_2\} & \text{if there is some } (C_2, X_2, Y_2) \in \mathbb{C}_1, \text{ such that } x \in Y_2, \\ & \text{but no } (C_1, X_1, Y_1) \in \mathbb{C}_1, \text{ such that } x \in X_1, \\ L(x) - (B_1 \cup B_2) & \text{otherwise.} \end{cases}$$

Note that L_2 are H_2 -lists. Furthermore, by [Claim 38.1](#) we observe that $L_2(x) \cap \{b_1, b_2\} = \emptyset$ if (i) $L(x) \cap (B_1 \cup B_2) = \emptyset$, or (ii) $L(x) \cap (B_1 \cup B_2) \neq \emptyset$, but for every $(C, X, Y) \in \mathbb{C}$, such that $x \in X \cup Y$, we have $(C, X, Y) \notin \mathbb{C}_1$. This means that removing $B_1 \cup B_2$ from the list of x was justified.

Finally, we are ready to show the main claim of the lemma.

Claim 38.3. *There exists a list homomorphism $h : (G, L) \rightarrow H$ if and only if there exists a list homomorphism $h' : (G, L_2) \rightarrow H_2$.*

Proof of Claim. First, assume that $h : (G, L) \rightarrow H$ exists. Define $h' : V(G) \rightarrow V(H)$ in the following way:

$$h'(x) := \begin{cases} b_1 & \text{if } h(x) \in B_1, \\ b_2 & \text{if } h(x) \in B_2, \\ h(x) & \text{otherwise.} \end{cases}$$

The fact that h' is a homomorphism follows from the definition of H_2 and the fact that h is a homomorphism. We need to show that for every x we have $h'(x) \in L_2(x)$.

If $h'(x) \notin \{b_1, b_2\}$, then $h'(x) = h(x) \in L(x) - (B_1 \cup B_2) \subseteq L_2(x)$. So consider the case that $h'(x) = b_1$ (the case if $h'(x) = b_2$ is symmetric). This means that $h(x) \in B_1$ and thus $L(x) \cap B_1 \neq \emptyset$, so, by [Claim 38.1](#), there is some $(C, X, Y) \in \mathbb{C}$, such that $x \in X$. Since $h(x) \in B_1$, [Claim 38.2 \(a\)](#) implies that h maps all vertices of C to $B_1 \cup B_2$, and by [Claim 38.2 \(b\)](#) we have that $h(X) \subseteq B_1$ and $h(Y) \subseteq B_2$. Therefore $(C, X, Y) \in \mathbb{C}_1$ and thus $b_1 \in L_2(x)$ by the definition of L_2 .

Now suppose there exists a list homomorphism $h' : (G, L_2) \rightarrow H_2$. We define a mapping $h : V(G) \rightarrow V(H)$ as follows. If $h'(x) \notin \{b_1, b_2\}$, then $h(x) := h'(x)$. If $h'(x) \in \{b_1, b_2\}$, then, by the definition of L_2 , there is $(C, X, Y) \in \mathbb{C}_1$, such that $x \in X$ if $h'(x) = b_1$ or $x \in Y$ if $h'(x) = b_2$. Moreover, recall that by the construction of \mathbb{C} this (C, X, Y) is unique. Then we set $h(x) = h_{(C, X, Y)}(x)$.

For every $x \in V(G)$ we have $h(x) \in L(x)$: if $h'(x) \notin \{b_1, b_2\}$, then $h(x) = h'(x) \in L_2(x) - \{b_1, b_2\} \subseteq L(x)$, and if $h'(x) \in \{b_1, b_2\}$, then $h(x) \in L(x)$ by the definition of $h_{(C, X, Y)}$.

So let us show that h is a homomorphism. Consider an edge xy of G and the following cases.

1. If $h'(x), h'(y) \notin \{b_1, b_2\}$, then $h(x)h(y) = h'(x)h'(y) \in E(H_2 - \{b_1, b_2\}) \subseteq E(H)$, by the fact that h' is a homomorphism.

2. If $h'(x) = b_1$ and $h'(y) = b_2$, then, by the definition of L_2 , there are $(C_1, X_1, Y_1) \in \mathbb{C}_1$ and $(C_2, X_2, Y_2) \in \mathbb{C}_1$, such that $x \in X_1$ and $y \in Y_2$. But since there is an edge from X_1 to Y_2 , we must have $(C_1, X_1, Y_1) = (C_2, X_2, Y_2)$, by the definition of \sim and \mathbb{C} . So we have $h(x)h(y) = h_{(C_1, X_1, Y_1)}(x)h_{(C_1, X_1, Y_1)}(y) \in E(H_1) \subseteq E(H)$.
3. The case $h'(x) = h'(y) = b_1$ or $h'(x) = h'(y) = b_2$ cannot occur, as h' is a homomorphism and b_1, b_2 have no loops.
4. Finally, consider the case that $h'(x) \in \{b_1, b_2\}$ and $h'(y) \notin \{b_1, b_2\}$. Assume that $h'(x) = b_1$, as the other case is symmetric. This implies that $h(x) \in B_1$. Since h' is a homomorphism, we observe that $h(y) = h'(y) \in K \cup M_2$. Therefore $h(x)h(y) \in E(H)$.

This concludes the proof of the claim. \blacksquare

We observe that \mathbb{C} can be computed in total time $\mathcal{O}((n \cdot |H|)^2)$. Computing $h_{(C, X, Y)}$ for all $(C, X, Y) \in \mathbb{C}$ can be done in total time:

$$\sum_{(C, X, Y) \in \mathbb{C}} T(H_1, |C|, t) \leq \sum_{(C, X, Y) \in \mathbb{C}} \alpha/2 \cdot c^t \cdot (|H_1| \cdot |C|)^d \leq 2 \left(\alpha/2 \cdot c^t \cdot (|H_1| \cdot n)^d \right) = \alpha \cdot c^t \cdot (|H_1| \cdot n)^d,$$

as every vertex of G might appear twice in subgraphs in \mathbb{C} . The rest of the argument is exactly the same as in the case of an F -decomposition and a BP -decomposition. Finally we conclude that if n is sufficiently large, then the problem can be solved in time $\alpha \cdot c^t \cdot (n \cdot |H|)^d$. \square

4.3 Special case: strong split graphs

As we have seen, in [Lemma 33](#) we have assumed that H is not a strong split graph. This case is somehow special, as if H is a strong split graph, then the straightforward bipartite decomposition of H^* does not correspond to any of decompositions defined in the preceding section. We will consider these graphs H separately.

Lemma 39. *Let H be a strong split graph with partition (B, P) . Let H' be the graph obtained from H by removing all edges with both endvertices in P , including loops. The $LHOM(H)$ problem with instance (G, L) with n vertices, given along with a tree decomposition of width t , can be solved in time $\mathcal{O}\left(i^*(H')^t \cdot (n \cdot |H|)^{\mathcal{O}(1)}\right)$.*

Proof. Let X (resp. Y) be the set of vertices $x \in V(G)$, such that $L(x) \cap B \neq \emptyset$ (resp. $L(x) \cap P \neq \emptyset$). Observe that for every $p \in P$ and $b \in B$ we have $N(b) \subseteq N(p)$, so, by [Observation 29 \(2\)](#), the sets X and Y are disjoint. Since we can assume that there are no vertices of G with empty lists, we conclude that X, Y is a partition of $V(G)$.

Furthermore, notice that if X is not independent, then we can immediately report that (G, L) is a no-instance. So assume that X is independent. Let G' be the graph obtained from G by removing all edges with both endvertices in Y , including loops. Clearly H' and G' are bipartite, with bipartition classes B, P and X, Y , respectively. Furthermore, any tree decomposition of G is also a tree decomposition of G' .

Recall that (i) P is a reflexive clique and (ii) $L(X) \subseteq B$ and $L(Y) \subseteq P$. Furthermore, (iii) in order to obtain G' and H' we have removed all edges with two endvertices inside Y and P , respectively. These three facts imply the following.

Claim 39.1. *Consider a function $h : V(G) \rightarrow V(H)$, such that for every $x \in V(G)$ it holds that $h(x) \in L(x)$. Then h is a homomorphism from G to H if and only if it is a homomorphism from G' to H' . \blacksquare*

Thus we can determine whether $(G, L) \rightarrow H$ by calling the algorithm for bipartite target graphs, given by [Theorem 3' a\)](#). \square

In the following corollary we bound the running time of the algorithm from [Lemma 39](#) in terms of the original target graph.

Corollary 40. *Let \widehat{H} be a graph and let H be a strong split graph, which was obtained from \widehat{H} by a series of decompositions. The $\text{LHOM}(H)$ problem with instance (G, L) with n vertices, given along with a tree decomposition of width t , can be solved in time $\mathcal{O}(i^*(\widehat{H})^t \cdot (n \cdot |H|)^{\mathcal{O}(1)})$.*

Proof. Let H' be defined as in [Lemma 39](#). Note that if H' is the complement of a circular-arc graph, then the problem can be solved in polynomial time, so the claim clearly holds. Otherwise, let H'' be the connected, induced, undecomposable subgraph of H' , whose complement is not a circular-arc graph, such that $i(H'') = i^*(H')$.

Recall from [Lemma 34](#) that H^* is an induced subgraph of \widehat{H}^* . Observe that H^* consists of two copies of H' , induced by the sets $B' \cup P''$ and $B'' \cup P'$, with additional edges joining every vertex from P' with every vertex from P'' . Thus H' is an induced subgraph of H^* , and therefore H'' is an induced subgraph of \widehat{H}^* . This means that $i^*(\widehat{H}) = i^*(\widehat{H}^*) \geq i(H'') = i^*(H')$. Therefore the algorithm from [Lemma 39](#) solved (G, L) in time $\mathcal{O}(i^*(H')^t \cdot (n \cdot |H|)^{\mathcal{O}(1)}) = \mathcal{O}(i^*(\widehat{H})^t \cdot (n \cdot |H|)^{\mathcal{O}(1)})$. \square

4.4 Solving $\text{LHOM}(H)$ for general target graphs

By [Lemma 33](#), it is straightforward to observe the following.

Observation 41. *If H is a connected, undecomposable, non-bi-arc graph, then $i^*(H)$ is the size of the largest incomparable set in H .* \square

In this section we will prove the following, slightly stronger version of [Theorem 5 a\)](#), where the input tree decomposition is not assumed to be optimal.

Theorem 5' a). *Let H be non-bi-arc graph. Even if H is given as an input, the $\text{LHOM}(H)$ problem with instance (G, L) can be solved in time $\mathcal{O}(i^*(H)^t \cdot (n \cdot |H|)^{\mathcal{O}(1)})$ for any lists L , provided that G is given with its tree decomposition of width t .*

The main idea is similar to the one in the proof of [Theorem 3' a\)](#): given an instance of $\text{LHOM}(H)$, we recursively decompose H into smaller subgraphs and reduce the initial instance to a number of instances of list homomorphism to these smaller subgraphs. Finally, we solve the problem for leaves of the recursion tree, and then, using [Lemma 35](#) in a bottom-up fashion, we will compute the solution to the original instance.

The only thing missing is how to solve the instances corresponding to leaves of the recursion tree. We describe this in the following lemma.

Lemma 42. *Let H be an arbitrary graph. Then any n -vertex instance (G, L) of $\text{LHOM}(H)$ can be solved in time $\mathcal{O}(i(H^*)^t \cdot (n \cdot |H|)^{\mathcal{O}(1)})$, assuming a tree decomposition of G with width at most t is given.*

Proof. Let (G^*, L^*) be the associated instance of $\text{LHOM}(H^*)$. By [Proposition 30](#), we know that $(G, L) \rightarrow H$ if and only if there is a clean homomorphism $(G^*, L^*) \rightarrow H^*$. We will focus on finding such a clean homomorphism.

First, recall that by [Observation 29 \(2\)](#) and [Observation 32 \(1\)](#), the instance (G^*, L^*) is consistent. So, by [Corollary 8](#), the size of each list in L^* is at most $i(H^*)$. Moreover, by [Observation 32 \(1\)](#), for every $x \in$

$V(G)$, the vertices in $L^*(x')$ are precisely the twins of vertices in $L^*(x'')$. Finally, by [Observation 32 \(2\)](#), in polynomial time we can obtain a tree decomposition \mathcal{T}^* of G^* with width at most $2t$, in which vertices of G^* come in pairs: whenever any bag contains x' , it also contains x'' .

Consider the straightforward dynamic programming algorithm for $\text{LHOM}(H^*)$, using the tree decomposition \mathcal{T}^* of G^* . We observe that since we are looking for a clean homomorphism, we do not need to remember partial solutions, in which the colors of twins do not agree. Thus, even though the size of each bag of \mathcal{T}^* is at most $2t$, the number of partial colorings we need to consider is bounded by $(\max_{x \in V(G^*)} |L^*(x)|)^t \leq i(H^*)^t$. So the claim follows. \square

Finally, let us wrap everything up and prove [Theorem 5' a\)](#). The proof is analogous to the proof of [Theorem 3' a\)](#).

Proof of Theorem 5' a). Again, we can assume that n is sufficiently large, as otherwise we can solve the problem by brute-force.

Let (G, L) be an instance of $\text{LHOM}(H)$, where G has n vertices and is given along with its tree decomposition of width at most t . We proceed as in the [Theorem 3' a\)](#). We consider a recursion tree \mathcal{R} , obtained by decomposing H recursively. For each node corresponding to some graph H' , we construct its children recursively, unless none of the following happens (i) H' is a bi-arc graph, (ii) H' is bipartite, (iii) H' is a strong split graph, or (iv) H' is undecomposable.

We compute the solutions in a bottom-up fashion. First, consider a leaf of the recursion tree, let the corresponding target graph for this node of \mathcal{R} be H' . If H' is a bi-arc graph, we can solve the problem in polynomial time. If H' is bipartite, we solve the problem in time $\beta \cdot i^*(H') \cdot (n \cdot |H'|)^{d_1} \leq \beta \cdot i^*(H) \cdot (n \cdot |H'|)^{d_1}$ for some constants β and d_1 , using the algorithm from [Theorem 3' a\)](#). If H' is a strong split graph, we can solve the problem in time $\gamma \cdot i^*(H) \cdot (n \cdot |H'|)^{d_2}$, for constants γ, d_2 , using the algorithm from [Corollary 40](#).

So finally consider the remaining case, i.e., that H' is connected, non-bi-arc, non-bipartite, undecomposable, which is not a strong split graph. Furthermore we know that H' was obtained from H by a sequence of decompositions.

Recall that by [Lemma 42](#), we can solve the instances of $\text{LHOM}(H')$ in time $\delta \cdot i(H'^*)^t \cdot (n \cdot |H'|)^{d_3}$, for some constants δ, d_3 . Let us consider the graph H'^* , by [Lemma 34](#) we know that H'^* is an induced subgraph of H^* . Also, H'^* is either connected (if H' is non-bipartite), or consists of two disjoint copies of H' (if H' is bipartite). Moreover, by [Lemma 33](#), we observe that H'^* is undecomposable. Thus, by the definition of $i^*(H)$, we observe that

$$i(H'^*) \leq \max\{i(H''): H'' \text{ is an undecomposable, connected, induced subgraph of } H^*, \\ \text{whose complement is not a circular-arc graph}\} = i^*(H).$$

So the algorithm from [Lemma 42](#) solves the instances corresponding to leaves of \mathcal{R} in time $\delta \cdot i^*(H)^t \cdot (n \cdot |H'|)^{d_3}$. Define $\alpha := \max(2\beta, \gamma, \delta)$ and $d := \max(d_1, d_2, d_3, 3)$.

By applying [Lemma 35](#) (in fact, [Lemma 36](#), [Lemma 37](#), and [Lemma 38](#), note that we adjusted the constants α and d so that their assumptions are satisfied) for every non-leaf node of \mathcal{R} in a bottom-up fashion, we conclude that we can solve $\text{LHOM}(H)$ in time $\alpha \cdot i^*(H)^t \cdot (n \cdot |H|)^d = \mathcal{O}\left(i^*(H)^t \cdot (n \cdot |H|)^{\mathcal{O}(1)}\right)$, which completes the proof. \square

5 Hardness for general target graphs

We aim to show the following. Note that again we are able to show the hardness parameterized by the pathwidth. Actually, we can show that the lower bound holds even if the input graph G is bipartite.

Theorem 5' b). *Let H be a fixed non-bi-arc graph. Unless the SETH fails, there is no algorithm that solves the $\text{LHOM}(H)$ problem on bipartite instances with n vertices and pathwidth t in time $(i^*(H) - \varepsilon)^t \cdot n^{\mathcal{O}(1)}$, for any $\varepsilon > 0$.*

The crucial observation is the following.

Proposition 43. *Let H be a graph and let (G, L) be a consistent instance of $\text{LHOM}(H^*)$. Define $L' : V(G) \rightarrow 2^{V(H)}$ as $L'(x) := \{u : \{u', u''\} \cap L(x) \neq \emptyset\}$. Then $(G, L) \rightarrow H^*$ if and only if $(G, L') \rightarrow H$.*

Proof. First, consider $f : (G, L) \rightarrow H^*$. For every $x \in V(G)$, we define $f'(x)$ to be the unique vertex u of H , such that $f(x) \in \{u', u''\}$. Note that since $\{u', u''\} \cap L(x) \neq \emptyset$, we have $u \in L'(x)$. Now consider an edge xy of G . Since f is a homomorphism, we have $f(x)f(y) \in E(H^*)$. Without loss of generality assume that $f(x) = u'$ and $f(y) = v''$ for some some edge uv of H (possibly $u = v$). But then $f'(x)f'(y) = uv \in E(H)$, so f' is a homomorphism from (G, L') to H .

Now consider a homomorphism $f' : (G, L') \rightarrow H$. Since (G, L) is consistent, we know that G is bipartite with bipartition classes X_G and Y_G , where $L(X_G) \subseteq \{u' : u \in V(H)\}$ and $L(Y_G) \subseteq \{u'' : u \in V(H)\}$. Let $x \in V(G)$ and $f'(x) = u$. Then we set $f(x) = u'$ if $x \in X_G$ or $f(x) = u''$ if $x \in Y_G$. First, let us show that f respects the lists L . Consider a vertex $x \in X_G$ (the case of a vertex in Y_G is symmetric). Since $f'(x) = u$, we observe that $u \in L'(x)$, which means that $u' \in L(x)$. So f respects lists L . Now consider an edge xy of G , such that $x \in X_G$ and $y \in Y_G$. Assume that $f'(x) = u$ and $f'(y) = v$, where uv is an edge of H (possibly $u = v$). Then $f(x)f(y) = u'v''$, which is an edge of H^* . So f is a homomorphism from G to H^* . \square

Clearly [Theorem 5' b\)](#) implies [Theorem 3' b\)](#). We will show that the reverse implication also holds. Recall that we have already shown that [Theorem 3' b\)](#) is equivalent to [Theorem 11](#), so in fact we will prove that all these three theorems are equivalent.

(Theorem 3' b) \rightarrow Theorem 5' b) Suppose [Theorem 3' b\)](#) holds and [Theorem 5' b\)](#) fails. So there is a non-bi-arc graph H and an algorithm A that solves $\text{LHOM}(H)$ in time $(i^*(H) - \varepsilon)^{\text{pw}(G)} \cdot n^{\mathcal{O}(1)}$ for every bipartite input (G, L) , provided that G is given along with its optimal path decomposition.

Recall that $i^*(H) = i^*(H^*)$. Let (G, L) be an arbitrary instance of $\text{LHOM}(H^*)$. We can assume that G is bipartite and connected, and the instance (G, L) is consistent. Consider the instance (G, L') of $\text{LHOM}(H)$, constructed as in [Proposition 43](#). The algorithm A solves this instance in time $(i^*(H) - \varepsilon)^{\text{pw}(G)} \cdot n^{\mathcal{O}(1)}$. By [Proposition 43](#), this is equivalent to solving the instance (G, L) of $\text{LHOM}(H^*)$ in time $(i^*(H^*) - \varepsilon)^{\text{pw}(G)} \cdot n^{\mathcal{O}(1)}$, contradicting [Theorem 3' b\)](#).

6 Conclusion

Let us conclude the paper with some side remarks and pointing out several open problems.

6.1 Special cases: reflexive and irreflexive graphs

Recall that the crucial tool for our algorithmic results were the decompositions of a connected graph H , introduced in [Section 2.1](#) (for bipartite graphs H) and in [Section 4.2](#) (for general graphs H). Let us analyze how the general decompositions behave in two natural special cases: if H is either a reflexive or an irreflexive graph. We use the notation introduced in [Definition 9](#), [Definition 10](#), and [Definition 11](#).

First we consider the case that H is reflexive, i.e., every vertex of H has a loop. Let us point out that a B -decomposition cannot occur in this case, as the sets B_1, B_2 are empty. In case of an F -decomposition we obtain exactly the decomposition defined by Egri *et al.* [[18](#), Lemma 8]. Finally, in the case of a BP -decomposition, note that the set B is empty and therefore each vertex in P has exactly the same neighborhood. Thus the total contribution of the vertices in P to $i^*(H)$ is at most 1. Therefore the only type of decomposition that can be algorithmically exploited in reflexive graph is the F -decomposition, as observed by Egri *et al.* [[18](#)].

Now let us consider the case that H is irreflexive, i.e., no vertex of H has a loop. Observe that the sets K and P are reflexive cliques, so they are empty in our case. Thus BP -decompositions and F -decompositions do not occur in this case (recall that H is connected). Therefore the only possibility left is a B -decomposition, in which the set K is empty. Let us point out that this decomposition is very similar to the bipartite decomposition, in particular, the graph H_1 is bipartite (while H_2 might be non-bipartite). This gives even more evidence that the case of bipartite graphs H is a crucial step to understanding the complexity of the $\text{LHOM}(H)$ problem. Actually, if H is bipartite, then the B -decomposition turns out to be equivalent to the bipartite decomposition introduced in [Section 2.1](#). The argument used in [Lemma 9](#) is significantly simpler than the one in [Lemma 38](#), as in the bipartite case we can assume that the instance is consistent and we know which vertices will be mapped to B_1 , and which to B_2 . In the general case we do not know it, so we need to consider both possibilities, as we do in [Lemma 38](#).

6.2 Typical graphs H

Knowing the precise complexity bounds for $\text{LHOM}(H)$, we might be interested in a question, how hard is to find a list homomorphism to a *typical* graph H . We say that a property P holds for *almost all graphs*, if for a graph G , chosen with uniform probability from the set of all graphs with n vertices, the probability that G satisfies P tends to 1 as $n \rightarrow \infty$. Properties that hold for almost all graphs can be studied in terms of the *random graph* $G(n, 1/2)$. Formally, it is a probability space over all graph with vertex set $[n]$, where the edge ij exists with probability $1/2$. Here we extend the usual model by allowing loops on vertices (also with probability $1/2$), but this does not change much in the reasoning. See the monograph of Alon and Spencer for more information [[1](#)].

It is well-known and straightforward to observe that for any fixed graph \mathbb{O} , almost all graphs contain \mathbb{O} as an induced subgraph. By applying this for, say, $\mathbb{O} = C_6$, we obtain that almost all graphs are non-bi-arc graphs. Also, it is known that almost all graphs are connected [[10](#), [39](#)]. Finally, let us consider incomparable sets in a typical graph H .

Lemma 44. *For almost all graphs H , every pair of distinct vertices is incomparable.*

Proof. Consider a random graph with vertex set $[n]$, where each edge (including loops) appears independently from others with probability $1/2$. For each $i, j \in [n]$ (non-necessarily distinct) we introduce a random variable $I_{i,j}$, whose value is 1 if and only if the edge ij exists. Clearly $N(i) \subseteq N(j)$ if and only if $I_{j,k} \geq I_{i,k}$ for every $k \in [n]$.

For every $i \neq j$ and every k , the probability that $I_{j,k} \geq I_{i,k}$ is $3/4$. Thus, for fixed $i \neq j$, the probability that $N(i) \subseteq N(j)$ is $(3/4)^n$. So the probability that there is a pair i, j , such that $N(i) \subseteq N(j)$, is at most $n(n-1)(3/4)^n$, which tends to 0 as $n \rightarrow \infty$. This means that with probability tending to 1 all pairs of distinct vertices are incomparable. \square

Note that this in particular implies that almost all graphs are undecomposable, as each decomposition necessarily contains pairs of comparable vertices. Similarly, almost all graphs are not strong split graphs. Since for connected, undecomposable graphs H , the value of $i^*(H)$ is equal to the size of the largest incomparable set in H (recall [Observation 41](#)), we conclude that for almost all graphs H we have $i^*(H) = |V(H)|$.

All these observations lead to the following corollary (note that again we can strengthen the statement given in the introduction by replacing the treewidth by the pathwidth).

Corollary 6'. *For almost all graphs H with possible loops the following holds. Even if H is fixed, there is no algorithm that solves $\text{LHOM}(H)$ for every instance (G, L) on n vertices in time $\mathcal{O}((|V(H)| - \varepsilon)^{\text{pw}(G)} \cdot n^{\mathcal{O}(1)})$ for any $\varepsilon > 0$, unless the SETH fails.*

6.3 Generalized algorithm

We believe that the decompositions that we discovered can be used for many problems concerning the complexity of variants of the $\text{LHOM}(H)$ problem, e.g., for various other parameterizations.

First, let us point out that in the proofs of [Lemma 9](#) and [Lemma 35](#), we did not really require that the running time is of the form $\mathcal{O}(c^{\text{tw}(G)} \cdot (n \cdot |H|)^d)$, for a constant c . Actually, it is sufficient that the bound on the running time is convex and non-decreasing. Let us start with a technical lemma.

Lemma 45. *Let $f: [1, \infty) \rightarrow \mathbb{R}$ be a non-decreasing, convex function. Then for any $x, y \in [1, \infty)$ it holds that $f(x) + f(y) \leq f(x+y) + f(1)$.*

Proof. First, observe that for each $z \geq 1$ and for each $\theta \in [0, 1]$, we have

$$f(\theta z) \leq f(\theta z + (1 - \theta)) \leq \theta f(z) + (1 - \theta)f(1).$$

Consider $x, y \in [1, \infty)$. Define $\theta := \frac{x}{x+y}$ and observe that $\theta \in [0, 1]$. So we have the following.

$$\begin{aligned} f(x) + f(y) &= f(\theta(x+y)) + f((1-\theta)(x+y)) \\ &\leq (\theta f(x+y) + (1-\theta)f(1)) + ((1-\theta)f(x+y) + \theta f(1)) \\ &= f(x+y) + f(1). \end{aligned} \quad \square$$

Next, recall that in each variant of the decomposition lemma, all instances for which we computed partial results were induced subgraphs of G , the original instance. This motivates the following, generalized statement, which can be used as a black-box to prove algorithmic and hardness results about $\text{LHOM}(H)$.

Theorem 46. *Let H be a graph. In time $|H|^{\mathcal{O}(1)}$ we can construct a family \mathcal{H} of $\mathcal{O}(|H|)$ connected graphs, such that:*

- (1) H is a bi-arc graph if and only if every $H' \in \mathcal{H}$ is a bi-arc graph,
- (2) if H is bipartite, then each $H' \in \mathcal{H}$ is an induced subgraph of H , and is either the complement of a circular-arc graphs or is undecomposable,
- (3) otherwise, for each $H' \in \mathcal{H}$, the graph H'^* is an induced subgraph of H^* and at least one of the following holds:
 - (a) H' is a bi-arc graph, or
 - (b) H' a strong split graph and has an induced subgraph H'' , which is not a bi-arc graph and is an induced subgraph of H , or
 - (c) $(H')^*$ is undecomposable,
- (4) for every instance (G, L) of $\text{LHOM}(H)$ with n vertices, the following implication holds:
If there exists a non-decreasing, convex function $f_H: \mathbb{N} \rightarrow \mathbb{R}$, such that for every $H' \in \mathcal{H}$, for every induced subgraph G' of G , and for every H' -lists L' on G' , we can decide whether $(G', L') \rightarrow H'$ in time $f_H(|V(G')|)$, then we can solve the instance (G, L) in time

$$\mathcal{O}\left(|H|f_H(n) + n^2 \cdot |H|^3\right).$$

Sketch of proof. The proof is analogous to the proofs of [Theorem 3' a\)](#) and [Theorem 5' a\)](#), so we only provide the sketch. Let us construct the recursion tree \mathcal{R} of H as we did in [Theorem 5' a\)](#). However, we do not terminate once we reach a bipartite graph, but in this case we continue as in [Theorem 3' a\)](#). Let \mathcal{H} the set of graphs associated with the leaves of \mathcal{R} .

Let us discuss property (1). Since we never decompose strong split graphs, [Lemma 33](#) implies that a decomposition of any graph F considered in the construction of \mathcal{R} corresponds to a bipartite decomposition of F^* . Furthermore, recall that a graph F' is a bi-arc graph if and only if F'^* is the complement of a circular-arc graph. Thus in order to show (1) it is sufficient to show that if F' is bipartite and has a bipartite decomposition with factors F_1 and F_2 , such that both F_1, F_2 are the complements of circular-arc graphs, then F is the complement of a circular-arc graph. It can be verified using the co-circular-arc representations, introduced in [Section 3](#), see [Figure 9](#).

Property (2) follows directly from the definition of the bipartite decomposition. Property (3) follows from the definitions of decompositions, [Lemma 33](#), and [Lemma 34](#). The only possible issue is the additional condition in (3b). Suppose after a series of decomposition applied to H we obtain a strong split graph H' , which is not a bi-arc graph (otherwise we are in case (3a)). Recall that the only possible vertices of H' that are not originally in H have loops, and all their neighbors also have loops (recall the F -decomposition). Thus such vertices belong to the reflexive clique in H' and have no neighbors outside this clique. In order to prove property (3b) one needs to verify that the graph H'' obtained from H' by removing all such vertices is still a non-bi-arc graph. This can be shown using the restricted structure of strong split graphs and the property shown in the previous paragraph: if some bipartite graph F has a bipartite decomposition such that both factors are complements of circular-arc graphs, then F is a complement of a circular-arc graph. The details are left to the reader.

Now let us discuss property (4). Recall that we can solve the instances corresponding to the leaves of \mathcal{R} , and then proceed in a bottom-up fashion. Even though there might be more than one instance corresponding to a leaf node, recall that the numbers of vertices of such instances sum up to n . So, consider a leaf node of \mathcal{R} , associated with some $H' \in \mathcal{H}$, and let n_1, n_2, \dots, n_p be the numbers of vertices in the instances of $\text{LHOM}(H')$ created in the recursion. By [Lemma 45](#) we can bound the running time related to this leaf node by

$$f_H(n_1) + f_H(n_2) + \dots + f_H(n_p) \leq f_H(n_1 + n_2) + f_H(1) + f_H(n_3) + \dots + f_H(n_p) \leq \dots \leq f_H(n) + n f_H(1).$$

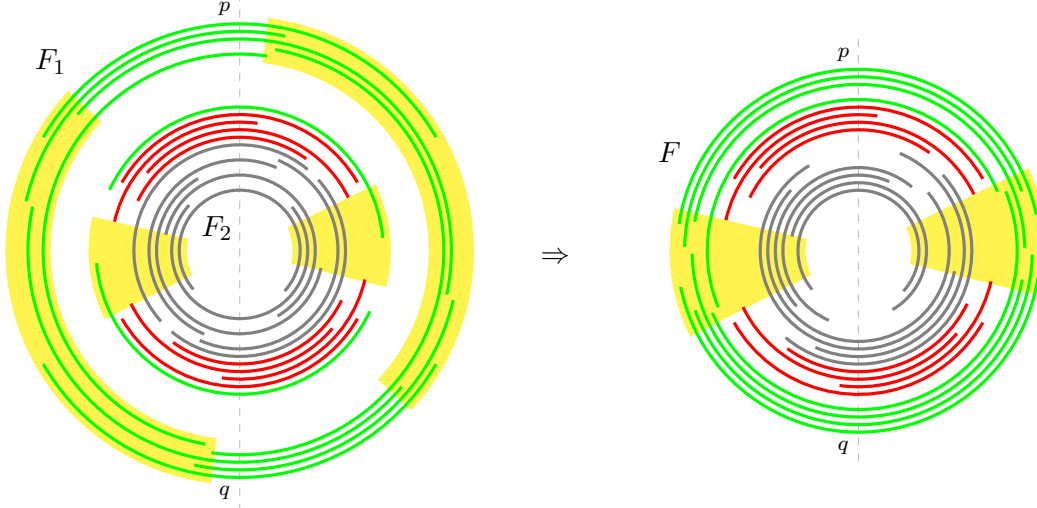

Figure 9: Assume that F is bipartite and has a bipartite decomposition (D, N, R) with factors F_1, F_2 , which are both complements of circular-arc graphs. Fix some co-circular-arc representations of F_1 and F_2 (left). In the representation of F_2 (left, interior), arcs corresponding to sets $\{d_X, d_Y\}$, N , and R are indicated respectively by green, red, and gray color. Observe that (i) since N is a biclique, there must be some space between “north” and “south” red arcs (yellow), (ii) since N is a separator, all gray arcs must intersect the opposite green arc, and (iii) since N is bipartite-complete to $\{d_X, d_Y\}$, no green arc can intersect opposite red arcs. So we can obtain a representation of F by “squeezing” the non-trivial part of the representation of F_1 in the yellow area.

Now let us consider an internal node of \mathcal{R} , it is associated with some subgraph H' of H . Recall that the computation for this node consists of the computations for child nodes and $\mathcal{O}(n^2|H'|^2) = \mathcal{O}(n^2|H|^2)$ additional steps. Since the total number of nodes of \mathcal{R} is $\mathcal{O}(|H|)$, we can bound the total running time for the root node (i.e., the time needed to solve (G, L)) by

$$\begin{aligned} \mathcal{O}\left(\sum_{H' \in \mathcal{H}} (f_H(n) + n f_H(1)) + n^2 \cdot |H|^3\right) &= \mathcal{O}\left(|H| f_H(n) + |H| n f_H(1) + n^2 \cdot |H|^3\right) \\ &= \mathcal{O}\left(|H| f_H(n) + n^2 \cdot |H|^3\right), \end{aligned}$$

which completes the proof. \square

Let us point out that if we apply [Theorem 46](#) to an irreflexive graph, then the case [\(3b\)](#) does not occur. Indeed, the only strong split graph that is irreflexive has no edges, and, in particular, is a bi-arc graph. Thus H'' with properties given in [Theorem 46 \(3b\)](#) cannot exist.

6.4 Gadgets for general graphs

Recall that we proved hardness for general graphs H by reducing the problem to the bipartite case. In particular, all our gadgets, including the most important $\text{NEQ}(S)$ -gadget, are constructed for bipartite graphs only. However, we believe that in some other contexts it might be useful to be able to obtain such

gadgets also for non-bipartite H . Luckily, our constructions can be simply translated to this case too. Observe that the proof of [Proposition 43](#) gives the following, slightly stronger version.

Proposition 47. *Let H be an undecomposable non-bi-arc graph. Let G be a bipartite graph with bipartition classes X, Y and H^* -lists L , where $L(X) \subseteq V(H)'$ and $L(Y) \subseteq V(H)''$. Define $L' : V(G) \rightarrow 2^{V(H)}$ as $L'(v) = \{u : \{u', u''\} \cap L(v) \neq \emptyset\}$. Then the following hold:*

1. *For $f : (G, L) \rightarrow H^*$, define $f' : V(G) \rightarrow V(H)$ by setting $f'(v)$ to be the unique vertex u of H , such that $f(v) \in \{u', u''\}$. Then f' is a list homomorphism from (G, L') to H .*
2. *For $f' : (G, L') \rightarrow H$, define $f : V(G) \rightarrow V(H^*)$ by setting $f(v) := u'$ if $v \in X$ and $f(v) := u''$ if $v \in Y$, where $u = f'(v)$. Then f is a list homomorphism from (G, L) to H^* .*

In particular we can extend [Lemma 4](#) and construct and $\text{NEQ}(S)$ -gadget for every non-bi-arc graph that might appear as a leaf of the recursion tree of H .

Corollary 48. *Let H be a connected non-bi-arc graph, which is either*

- a) *undecomposable, or*
- b) *a strong split graph, such that the graph H' , obtained from H by removing all edges with both endvertices in P (including loops), is undecomposable.*

Let $S \subseteq V(H)$, such that $|S| \geq 2$ and for any $a, b \in S$ we have $N(a) \not\subseteq N(b)$ and $N(b) \not\subseteq N(a)$. Then there exists a $\text{NEQ}(S)$ -gadget, i.e., a graph F with H -lists L and two special vertices $x, y \in V(F)$, such that $L(x) = L(y) = S$ and

- *for any list homomorphism $h : (F, L) \rightarrow H$, it holds that $h(x) \neq h(y)$,*
- *for any distinct $a, b \in S$ there is a list homomorphism $h : (F, L) \rightarrow H$, such that $h(x) = a$ and $h(y) = b$.*

Proof. In case a), by [Lemma 33](#), H^* is undecomposable. Thus the claim follows directly from applying [Proposition 47](#) to the $\text{NEQ}(S')$ -gadget for H^* (where $S' := \{s' : s \in S\}$), constructed in [Lemma 4](#).

In case b), let (B, P) be the partition of H . Observe that for every $b \in B$ and $p \in P$ we have $N(b) \subseteq N(p)$, so S is either contained in B , or in P . In other words, S is contained in one bipartition class of H' . Let (F, L) be the $\text{NEQ}(S)$ -gadget for H' . Recall that H' is an induced subgraph of H^* , so L are H^* -lists. Now the claim follows from applying [Proposition 47](#) to (F, L) . \square

Note that all other gadgets, e.g. distinguishers, could be generalized in a similar way.

6.5 Further research directions

In this paper we have shown tight complexity bounds for the list homomorphism problem, parameterized by the treewidth of the instance graph.

A very natural question, mentioned also in [\[18\]](#), is to provide analogous results for the non-list variant of the problem, denoted by $\text{HOM}(H)$. Let us point out that despite of the obvious similarity of $\text{HOM}(H)$ and $\text{LHOM}(H)$, the methods used to obtain hardness proofs for these problems are very different. For the list variant most hardness proofs (including all proofs in this paper) are purely combinatorial [\[19, 20, 21\]](#) and are based on considering some local structures in the target graph – note that we can ignore the remaining vertices of H by not including them in any list. On the other hand, in the $\text{HOM}(H)$ problem, we need to be able to capture the structure of the whole graph H at once. This is the reason why hardness proofs for the non-list variant usually require using some algebraic tools [\[31, 11, 44\]](#).

Very recently, Okrasa and Rzażewski were able to provide tight bounds for the complexity of $\text{HOM}(H)$, assuming two conjectures from algebraic graph theory from early 2000s [\[41\]](#). It would be very interesting

to strengthen these results, either by proving the mentioned two conjectures, or by providing a different reduction.

Another interesting direction is to consider one of many other variants of the graph homomorphism problem. Let us mention one, i.e., *locally surjective homomorphism*, denoted by $\text{LSHom}(H)$. In this problem we ask for a homomorphism from an instance graph G to the target graph H , which is surjective on each neighborhood. In other words, if we map some vertex $x \in V(G)$ to some vertex $v \in V(H)$, then every neighbor of v must appear as a color of some neighbor of x [24, 22, 23, 40]. We believe that it is interesting to show tight complexity bounds for this problem. One of the reasons why this problem is challenging is that the natural dynamic programming runs in time $2^{\mathcal{O}(|H| \cdot \text{tw}(G))} \cdot (n + |H|)^{\mathcal{O}(1)}$. Thus in order to show that this bound is tight, it is not sufficient to design edge gadgets encoding inequality and substitute all edges of the instance of k -COLORING with these edge gadgets, as we did in this paper. Since the number of colors needs to be exponential in H , one should also design some *vertex gadgets*, which will encode the exponential number of possible states.

Finally, instead of changing the problem, we can consider changing the parameter. We believe that an exciting question is to find tight bounds for $\text{Hom}(H)$ and $\text{LHom}(H)$, parameterized by the *cutwidth* of the instance graph, denoted by $\text{cw}(G)$. Quite recently Jansen and Nederlof showed that the chromatic number of a graph can be found in time $2^{\mathcal{O}(\text{cw}(G))} \cdot n^{\mathcal{O}(1)}$ [35], i.e., the base of the exponential factor does not depend on the number of colors. Jansen [34] asked whether the same is possible for $\text{Hom}(H)$ and $\text{LHom}(H)$, if the target H is not complete? Note that while the chromatic number of a graph can be found in time $2^n \cdot n^{\mathcal{O}(1)}$ [4], for the $\text{Hom}(H)$ and $\text{LHom}(H)$ problems the $|H|^{\mathcal{O}(n)}$ -time algorithm is essentially best possible, assuming the ETH [15]. We believe that a similar phenomenon might occur if the cutwidth is a parameter.

Acknowledgment. We are grateful to Daniél Marx and Lászlo Egri for much advice regarding the topic and to Kamil Szpojankowski for an inspiring discussion about almost all graphs.

References

- [1] Noga Alon and Joel H. Spencer. *The Probabilistic Method, Third Edition*. Wiley-Interscience series in discrete mathematics and optimization. Wiley, 2008.
- [2] Stefan Arnborg, Derek G. Corneil, and Andrzej Proskurowski. Complexity of finding embeddings in a k -tree. *SIAM J. Algebraic Discrete Methods*, 8(2):277–284, April 1987.
- [3] Stefan Arnborg and Andrzej Proskurowski. Linear time algorithms for NP-hard problems restricted to partial k -trees. *Discrete Applied Mathematics*, 23(1):11–24, 1989.
- [4] Andreas Björklund, Thore Husfeldt, and Mikko Koivisto. Set partitioning via inclusion-exclusion. *SIAM J. Comput.*, 39(2):546–563, 2009.
- [5] Hans L. Bodlaender. A linear-time algorithm for finding tree-decompositions of small treewidth. *SIAM J. Comput.*, 25(6):1305–1317, 1996.
- [6] Hans L. Bodlaender, Paul S. Bonsma, and Daniel Lokshantov. The fine details of fast dynamic programming over tree decompositions. In *Parameterized and Exact Computation - 8th International Symposium, IPEC 2013, Sophia Antipolis, France, September 4-6, 2013, Revised Selected Papers*, pages 41–53, 2013.
- [7] Hans L. Bodlaender, Marek Cygan, Stefan Kratsch, and Jesper Nederlof. Deterministic single exponential time algorithms for connectivity problems parameterized by treewidth. *Inf. Comput.*, 243:86–111, 2015.
- [8] Hans L. Bodlaender, Pål Grønås Drange, Markus S. Dregi, Fedor V. Fomin, Daniel Lokshantov, and Michal Pilipczuk. A $c^k n$ 5-approximation algorithm for treewidth. *SIAM J. Comput.*, 45(2):317–378, 2016.
- [9] Hans L. Bodlaender and Arie M. C. A. Koster. Combinatorial optimization on graphs of bounded treewidth. *Comput. J.*, 51(3):255–269, May 2008.
- [10] Béla Bollobás. The diameter of random graphs. *Transactions of the American Mathematical Society*, 267(1):41–52, 1981.
- [11] Andrei A. Bulatov. H -coloring dichotomy revisited. *Theor. Comput. Sci.*, 349(1):31–39, 2005.
- [12] Andrei A. Bulatov. Constraint satisfaction problems: Complexity and algorithms. In Shmuel Tomi Klein, Carlos Martín-Vide, and Dana Shapira, editors, *Language and Automata Theory and Applications*, pages 1–25, Cham, 2018. Springer International Publishing.
- [13] Rajesh Chitnis, László Egri, and Dániel Marx. List H -coloring a graph by removing few vertices. *Algorithmica*, 78(1):110–146, 2017.
- [14] Bruno Courcelle. The monadic second-order logic of graphs. I. Recognizable sets of finite graphs. *Inf. Comput.*, 85(1):12–75, 1990.
- [15] Marek Cygan, Fedor V. Fomin, Alexander Golovnev, Alexander S. Kulikov, Ivan Mihajlin, Jakub Pachocki, and Arkadiusz Socala. Tight lower bounds on graph embedding problems. *J. ACM*, 64(3):18:1–18:22, 2017.

- [16] Marek Cygan, Fedor V Fomin, Łukasz Kowalik, Daniel Lokshantov, Dániel Marx, Marcin Pilipczuk, Michał Pilipczuk, and Saket Saurabh. *Parameterized algorithms*. Springer, 2015.
- [17] László Egri, Andrei A. Krokhnin, Benoît Larose, and Pascal Tesson. The complexity of the list homomorphism problem for graphs. *Theory Comput. Syst.*, 51(2):143–178, 2012.
- [18] László Egri, Dániel Marx, and Paweł Rzażewski. Finding list homomorphisms from bounded-treewidth graphs to reflexive graphs: a complete complexity characterization. In Rolf Niedermeier and Brigitte Vallée, editors, *35th Symposium on Theoretical Aspects of Computer Science, STACS 2018, February 28 to March 3, 2018, Caen, France*, volume 96 of *LIPICs*, pages 27:1–27:15. Schloss Dagstuhl - Leibniz-Zentrum fuer Informatik, 2018.
- [19] Tomas Feder and Pavol Hell. List homomorphisms to reflexive graphs. *Journal of Combinatorial Theory, Series B*, 72(2):236 – 250, 1998.
- [20] Tomás Feder, Pavol Hell, and Jing Huang. List homomorphisms and circular arc graphs. *Combinatorica*, 19(4):487–505, 1999.
- [21] Tomás Feder, Pavol Hell, and Jing Huang. Bi-arc graphs and the complexity of list homomorphisms. *Journal of Graph Theory*, 42(1):61–80, 2003.
- [22] Jirí Fiala and Jana Maxová. Cantor-Bernstein type theorem for locally constrained graph homomorphisms. *Eur. J. Comb.*, 27(7):1111–1116, 2006.
- [23] Jirí Fiala and Daniël Paulusma. A complete complexity classification of the role assignment problem. *Theor. Comput. Sci.*, 349(1):67–81, 2005.
- [24] Jirí Fiala, Daniël Paulusma, and Jan Arne Telle. Matrix and graph orders derived from locally constrained graph homomorphisms. In Joanna Jedrzejowicz and Andrzej Szepietowski, editors, *Mathematical Foundations of Computer Science 2005, 30th International Symposium, MFCS 2005, Gdansk, Poland, August 29 - September 2, 2005, Proceedings*, volume 3618 of *Lecture Notes in Computer Science*, pages 340–351. Springer, 2005.
- [25] Fedor V. Fomin, Pinar Heggernes, and Dieter Kratsch. Exact algorithms for graph homomorphisms. *Theory Comput. Syst.*, 41(2):381–393, 2007.
- [26] Markus Frick and Martin Grohe. The complexity of first-order and monadic second-order logic revisited. *Ann. Pure Appl. Logic*, 130(1-3):3–31, 2004.
- [27] Michael R. Garey and David S. Johnson. *Computers and Intractability: A Guide to the Theory of NP-Completeness*. W. H. Freeman & Co., New York, NY, USA, 1979.
- [28] Richard Hammack, Wilfried Imrich, and Sandi Klavžar. *Handbook of product graphs*. Discrete Mathematics and its Applications (Boca Raton). CRC Press, Boca Raton, FL, second edition, 2011. With a foreword by Peter Winkler.
- [29] Pavol Hell and Jing Huang. Two remarks on circular arc graphs. *Graphs Comb.*, 13(1):65–72, 1997.
- [30] Pavol Hell and Jaroslav Nešetřil. *Graphs and homomorphisms*. Oxford University Press, 2004.

- [31] Pavol Hell and Jaroslav Nešetřil. On the complexity of H -coloring. *J. Comb. Theory, Ser. B*, 48(1):92–110, 1990.
- [32] Russell Impagliazzo and Ramamohan Paturi. On the complexity of k -SAT. *J. Comput. Syst. Sci.*, 62(2):367–375, 2001.
- [33] Russell Impagliazzo, Ramamohan Paturi, and Francis Zane. Which problems have strongly exponential complexity? *J. Comput. Syst. Sci.*, 63(4):512–530, 2001.
- [34] Bart M. P. Jansen. personal communication.
- [35] Bart M. P. Jansen and Jesper Nederlof. Computing the chromatic number using graph decompositions via matrix rank. *Theor. Comput. Sci.*, 795:520–539, 2019.
- [36] Tomasz Kociumaka and Marcin Pilipczuk. Deleting vertices to graphs of bounded genus. *Algorithmica*, 81(9):3655–3691, 2019.
- [37] Stefan Kratsch, Daniel Lokshantov, Dániel Marx, and Peter Rossmanith. Optimality and tight results in parameterized complexity (dagstuhl seminar 14451). *Dagstuhl Reports*, 4(11):1–21, 2014.
- [38] Daniel Lokshantov, Dániel Marx, and Saket Saurabh. Known algorithms on graphs of bounded treewidth are probably optimal. *ACM Trans. Algorithms*, 14(2):13:1–13:30, 2018.
- [39] John W Moon and Leo Moser. Almost all $(0, 1)$ matrices are primitive. *Studia Scient. Math. Hung.*, 1:153–156, 1966.
- [40] Karolina Okrasa and Paweł Rzażewski. Subexponential algorithms for variants of the homomorphism problem in string graphs. *J. Comput. Syst. Sci.*, 109:126–144, 2020.
- [41] Karolina Okrasa and Paweł Rzażewski. Fine-grained complexity of graph homomorphism problem for bounded-treewidth graphs. In *Proceedings of the 2020 ACM-SIAM Symposium on Discrete Algorithms*, pages 1578–1590, 2020.
- [42] Michał Pilipczuk. Problems parameterized by treewidth tractable in single exponential time: A logical approach. In *MFCS 2011*, volume 6907, pages 520–531. Springer, 2011.
- [43] Paweł Rzażewski. Exact algorithm for graph homomorphism and locally injective graph homomorphism. *Inf. Process. Lett.*, 114(7):387–391, 2014.
- [44] Mark H. Siggers. A new proof of the H -coloring dichotomy. *SIAM Journal on Discrete Mathematics*, 23(4):2204–2210, 2010.
- [45] Jeremy P. Spinrad. Circular-arc graphs with clique cover number two. *J. Comb. Theory, Ser. B*, 44(3):300–306, 1988.
- [46] William T. Trotter and John I. Moore. Characterization problems for graphs, partially ordered sets, lattices, and families of sets. *Discrete Mathematics*, 16(4):361 – 381, 1976.
- [47] Johan M. M. van Rooij, Hans L. Bodlaender, and Peter Rossmanith. Dynamic programming on tree decompositions using generalised fast subset convolution. In Amos Fiat and Peter Sanders, editors, *Algorithms - ESA 2009, 17th Annual European Symposium, Copenhagen, Denmark, September 7-9, 2009. Proceedings*, volume 5757 of *Lecture Notes in Computer Science*, pages 566–577. Springer, 2009.

- [48] Magnus Wahlström. New plain-exponential time classes for graph homomorphism. *Theory Comput. Syst.*, 49(2):273–282, 2011.