

Games on graphs: a compositional approach

Elena Di Lavore 

Department of Software Science, Tallinn University of Technology, Estonia
elena.di@taltech.ee

Jules Hedges 

Max Planck Institute for Mathematics in the Sciences, Leipzig, Germany
jules.hedges@mis.mpg.de

Paweł Sobociński 

Department of Software Science, Tallinn University of Technology, Estonia
pawel.sobocinski@taltech.ee

Abstract

The analysis of games played on graph-like structures is of increasing importance due to the prevalence of social networks, both virtual and physical, in our daily life. As well as being relevant in computer science, mathematical analysis and computer simulations of such distributed games are vital methodologies in economics, politics and epidemiology, amongst other fields. Our contribution is to give compositional semantics of a family of such games as a well-behaved mapping, a strict monoidal functor, from a category of open graphs (syntax) to a category of open games (semantics). As well as introducing the theoretical framework, we identify some applications of compositionality.

2012 ACM Subject Classification Theory of computation → Categorical semantics

Keywords and phrases game theory, category theory, network games, open games, open graphs, compositionality

Funding *Elena Di Lavore*: European Union through the ESF funded Estonian IT Academy research measure (project 2014-2020.4.05.19-0001)

Paweł Sobociński: European Union through the ESF funded Estonian IT Academy research measure (project 2014-2020.4.05.19-0001)

1 Introduction

Compositionality concerns finding homomorphic mappings

$$\mathbf{Syntax} \rightarrow \mathbf{Semantics}. \tag{1}$$

This concept, of foundational importance in computer science, originated in formal logic [21, 22], and is at the centre of formal semantics of programming languages [24]. In recent years, there have been several *2-dimensional* examples [6, 4, 1] of the approach, where both **Syntax** and **Semantics** are symmetric monoidal categories. Usually **Syntax** is freely generated from a (monoidal) signature, possibly modulo some equations. This opens up the possibility of recursive definitions and proofs by structural induction, familiar from our experience with ordinary, 1-dimensional syntax.

In this paper, we consider an instance of (1) that is—at first sight—radically different from the usual concerns of programming and logic: network games [5]. Network games involve a number of agents who play concurrently, and share information with other players based on some underlying, ambient network topology. Indeed, the utility of each player typically depends on the structure of the network. An obvious application area is social networks [10], but such games are also studied in economics [11], politics [23] and epidemiology [15], amongst other fields.

In formal accounts of network games, graphs play the role of network topologies. Players are identified with graph vertices, and their utility is influenced only by their choices and those of their immediate neighbours. Network games are thus “games on graphs”. A simple example is the *majority game*: players “win” when they make the same choice as the majority of their neighbours.

In what way do such games fit into the conceptual framework of (1)? Our main contribution is the framing of certain network games as monoidal functors from a suitable category [7] of *open graphs* **Grph**, which is our **Syntax**, to the category [12] of open games **Game**, which is our **Semantics**. That is, given a network game specification \mathcal{N} (e.g. the majority game), such games are functors

$$F_{\mathcal{N}}: \mathbf{Grph} \rightarrow \mathbf{Game} \quad (2)$$

that in particular, for any *closed* graph $\Gamma \in \mathbf{Grph}$, yield the game $F_{\mathcal{N}}(\Gamma)$, which is the game \mathcal{N} played on Γ . However, compositionality means that such games are actually “glued together” from simpler, *open* games. In fact, $F_{\mathcal{N}}$ maps each vertex of Γ to an open game called the *utility-maximising player*, and the connectivity of Γ is mapped, following the rules of \mathcal{N} , to structure in **Game**.

Our contribution thus makes the intuitively obvious idea that the data of network games is dependent on their network topology precise. Concrete descriptions of network games, given a fixed topology, are often quite involved: our approach means that they can be derived in a principled way from basic building blocks. In some cases, the compositional description can also help in the mathematical analysis of games. For example, in the case of the majority game, the right decomposition of a network topology Γ as an expression in **Grph** can yield a recipe for the Nash equilibrium of $F_{\mathcal{N}}(\Gamma)$ in **Game** in terms of the equilibria of the open games obtained via $F_{\mathcal{N}}$ from the open graphs in the decomposition. While a compositional analysis of equilibria is not always possible, we argue compositional reasoning can, nevertheless, be a valuable weapon in the modelling arsenal.

Technically, we proceed as follows. We introduce a novel game called *monoid network game* (Definition 7) that generalises all of our motivating examples. Roughly speaking, monoid network games are parametrised wrt (i) a monoid that aggregates information from neighbours and (ii) functions that govern how that information is propagated in the network. Our category of open graphs **Grph** (Definition 17) is an extension of the approach developed in [7], from undirected graphs to undirected multigraphs. Our **Grph** is different from other notions of “open graph” in the literature, e.g. via cospans [9]. Indeed, our approach is centred around the use of *adjacency matrices*, which are commonly used in graph theory to encode connectivity. The emphasis on the matrix algebra means that **Grph** has the structure of commutative bialgebra—equivalent to the algebra of ordinary \mathbb{N} matrices [14, 25]—but also additional structure that captures the algebraic content of adjacency matrices. Given that **Grph** has a presentation in terms of generators and equations, to obtain (2) it suffices to define it on the generators and check that **Grph**-equations are respected in **Game**. This is our main result, Theorem 26.

In addition to the presentation of **Grph** in terms of generators and equations, we characterise it as a more concrete category \mathcal{A} (Theorem 22) which makes its status as the category of open graphs more apparent. The result can be understood as a kind of normal form for the morphisms of **Grph**, which is useful to describe concrete instantiations of $F_{\mathcal{N}}$ for arbitrary open graphs (Theorem 28).

Our work is a first step towards a more principled way of defining games parametrised by graphs. Future work will extend both the notions of graphs (e.g. by considering directed

graphs), as well as the kinds of games played on them. While we do identify some applications, we believe that compositional reasoning is severely under-rated in traditional game theory, and that its adoption will lead to both more flexible modelling frameworks, as well as more scalable mathematical analyses.

Structure of the paper.

We introduce our network game running examples in §2 and unify them under the umbrella of monoid network games. Next, we recall the basics of open games in §3 and identify the building blocks needed for (2). In §4 we introduce the category **Grph** of open, undirected multigraphs, and give a combinatorial characterisation account, which is useful in applications. The construction of $F_{\mathcal{N}}$ is in §5, and several applications of our compositional framework are given in §6.

2 Games on graphs

In this section we introduce motivating examples for our compositional framework and introduce the a novel notion of game called the *monoid network game* that unifies them.

Network games [13] are parametric wrt a particular network topology, usually represented by a graph. Players correspond to the vertices, and each player's payoff is affected only by the choices of its immediate *neighbours*: those players that are connected via an edge. In this sense, network games are *games played on graphs*. Undirected multigraphs are expressive enough for our purposes.

► **Definition 1.** *An undirected multigraph is a tuple $G = (V_G, E_G)$, where V_G is the set of vertices and E_G is a symmetric multi-relation on V_G : a function $E_G: V_G \times V_G \rightarrow \mathbb{N}$ st $E_G(v_i, v_j) = E_G(v_j, v_i)$.*

Another, common way of capturing the connectivity of a graph is via *adjacency matrices*, which often play an important role in graph theory. They are also crucial for our compositional account.

► **Definition 2.** *Assuming an ordering on the set of vertices of a graph, square matrices A with entries from \mathbb{N} can record connections between vertex i and j in A_{ij} : a 0-entry signifies no edge between i and j , and non-zero entries count the connections. Ordinary matrices are too concrete to uniquely represent connectivity since edges between i and j can be recorded in the (i, j) th entry or the (j, i) th entry. One could use symmetric matrices or triangular matrices. For us, it is better to equate matrices that encode the same connectivity: $A \sim A'$ iff $A + A^T = A' + A'^T$. We will refer to equivalence classes $[A]$ as adjacency matrices. A finite undirected multigraph can then be defined, equivalently, as a pair $(k_G, [A])$ where $k_G \in \mathbb{N}$ and $[A]$ is a $k_G \times k_G$ adjacency matrix with \mathbb{N} entries.*

Let $\mathbf{G}(n)$ be the set of undirected multigraphs with n vertices, enumerated as v_1, \dots, v_n .

► **Definition 3 (Network game).** *An n -player network game \mathcal{N} consists of, for each player $1 \leq i \leq n$, a set of choices X_i and a payoff $u_i: \mathbf{G}(n) \times \prod_{j=1}^n X_j \rightarrow \mathbb{R}$, st for each $G \in \mathbf{G}(n)$,*

$$u_i(G, \underline{x}) = u_i(G, \underline{x}')$$

whenever $x_i = x'_i$ and $x_j = x'_j$ for all $(v_i, v_j) \in E_G$: each player's payoff is affected only by its neighbours. The set of strategies is $\prod_{i=1}^n X_i$ and its elements $\underline{x} \in \prod_{i=1}^n X_i$ are strategy

4 Games on graphs: a compositional approach

profiles.

The best response, for a graph $G \in \mathbf{G}(n)$, is a relation $\mathbb{B}_{\mathcal{N}}$ on the set of strategies, defined by

$$(\underline{x}, \underline{x}') \in \mathbb{B}_{\mathcal{N}} \Leftrightarrow \forall 1 \leq i \leq n. \forall y_i \in X_i. u_i(G, \underline{x}[i \mapsto x'_i]) \geq u_i(G, \underline{x}[i \mapsto y_i])$$

A Nash equilibrium, for a graph $G \in \mathbf{G}(n)$, is a strategy profile \underline{x} s.t. for each player $1 \leq i \leq n$,

$$u_i(G, \underline{x}) \geq u_i(G, \underline{x}[i \mapsto x'_i])$$

for each possible alternative $x'_i \in X_i$. This is a fix-point of the best response relation.

We now recall three important examples of network games.

► **Example 4 (Majority game).** Each player has two choices, $X_i = \{Y, N\}$. A player receives a utility of 1 if its choice is the majority choice among its neighbours in the graph, and 0 otherwise, i.e.

$$u_i(G, \underline{x}) = \begin{cases} 1 & \text{if } |\{v_j \mid (v_i, v_j) \in E_G \text{ and } x_i = x_j\}| \geq |\{v_j \mid (v_i, v_j) \in E_G \text{ and } x_i \neq x_j\}| \\ 0 & \text{otherwise.} \end{cases}$$

The Nash equilibria are strategy profiles where each player takes the majority choice of its neighbours.

► **Example 5 (Best-shot public goods game).** Each player has two choices, $X_i = \{Y, N\}$, interpreted as investing or not investing in a public good. The investment has a cost $0 < c < 1$ to the player who invests, and gives a utility of 1 to the investor and every neighbour. We can imagine that players are already partially satisfied with the current situation and assign a utility of $1 - c + \epsilon$, with $0 < \epsilon < c$, to the situation where neither the player nor its neighbours invest. The utility functions thus are:

$$u_i(G, \underline{x}) = \begin{cases} 1 - c & \text{if } x_i = Y \\ 1 & \text{if } x_i = N \text{ and } x_j = Y \text{ for some } (v_i, v_j) \in E_G \\ 1 - c + \epsilon & \text{otherwise.} \end{cases}$$

The Nash equilibrium is when no player invests, an example of a ‘tragedy of the commons’.

► **Example 6 (Weakest-link public goods game).** Each player’s choice is an investment, valued in \mathbb{R}_+ . Investment have a cost to the player given by an increasing cost function $c : \mathbb{R}_+ \rightarrow \mathbb{R}_+$ where $c(0) = 0$, and the utility is given by the *minimum* level of investment of the player and all neighbours:

$$u_i(G, \underline{x}) = \min_{j=i \text{ or } (v_i, v_j) \in E_G} x_j - c(x_i).$$

A necessary condition for a Nash equilibrium is that no player invests more than any of its neighbours.

In Examples 4, 5 and 6 every player has the same set of choices, and the utility depends in a uniform way on neighbours’ choices. We collect these examples under the umbrella of *monoid network games*. To the best of our knowledge, the following definition has not previously appeared in the literature.

► **Definition 7** (Monoid network game). A monoid network game is a tuple $\mathcal{N} = (X, M, f, g)$ where:

- X is the set of choices for each player
- $M = (M, \oplus, e)$ is a commutative monoid
- $f : X \rightarrow M$ and $g : X \times M \rightarrow \mathbb{R}$ are functions such that each utility function has the form

$$u_i(G, \underline{x}) = g \left(x_i, \bigoplus_{(v_i, v_j) \in E_G} f(x_j) \right).$$

Examples 4, 5, 6 are indeed examples of monoid network games:

- The majority game (Example 4) has the monoid $(\mathbb{N}, +, 0) \times (\mathbb{N}, +, 0)$, counting the Y and N ‘votes’. Define $f : \{Y, N\} \rightarrow \mathbb{N}^2$ by $f(Y) = (1, 0)$ and $f(N) = (0, 1)$, and $g : \{Y, N\} \times \mathbb{N}^2 \rightarrow \mathbb{R}$ is:

$$g(x, (n_1, n_2)) = \begin{cases} 1 & \text{if } x = Y \text{ and } n_1 \geq n_2 \\ 1 & \text{if } x = N \text{ and } n_1 \leq n_2 \\ 0 & \text{otherwise.} \end{cases}$$

- The best-shot public goods game (Example 5) is a monoid network game with the monoid $\mathbf{Bool} = (\{Y, N\}, \vee, N)$, where \vee is logical or, $f : \mathbf{Bool} \rightarrow \mathbf{Bool}$ is the identity, and $g : \mathbf{Bool} \times \mathbf{Bool} \rightarrow \mathbb{R}$:

$$g(x, y) = \begin{cases} 1 - c & \text{if } x = Y \\ 1 & \text{if } x = N \text{ and } y = Y \\ 1 - c + \epsilon & \text{if } x = N \text{ and } y = N \end{cases}$$

- The weakest-link public goods game (Example 6) has the monoid $\mathbb{R}_+^\infty = (\{\mathbb{R}_+ \cup \{\infty\}, \min, \infty)$, f the embedding $\mathbb{R}_+ \hookrightarrow \mathbb{R}_+^\infty$, and $g : \mathbb{R}_+ \times \mathbb{R}_+^\infty \rightarrow \mathbb{R}$ is $g(x, y) = \min(x, y) - c(x)$.

3 Open games

Open games were introduced in [12] as a compositional approach to game theory.

► **Definition 8** (Open game). Let X, Y, R, S, Σ be sets. An open game $\mathcal{G} : \left(\begin{smallmatrix} X \\ S \end{smallmatrix} \right) \xrightarrow{\Sigma} \left(\begin{smallmatrix} Y \\ R \end{smallmatrix} \right)$ consists of:

- (i) $\mathbb{P}_{\mathcal{G}} : \Sigma \times X \rightarrow Y$, called *play function*
- (ii) $\mathbb{C}_{\mathcal{G}} : \Sigma \times X \times R \rightarrow S$, called *coplay function*
- (iii) $\mathbb{B}_{\mathcal{G}} : X \times (Y \rightarrow R) \rightarrow \mathcal{P}(\Sigma^2)$, called *best response function*.

Roughly speaking, an open game is a process that (i) given a *strategy* and *observation*, decides a *move*, and (ii) given an strategy, observation, and a *utility*, returns a *coutility* to the environment. Coutility is not a concept of classical game theory, but it enables compositionality by incorporating the fact that players reason about the future consequences of their actions. Finally, (iii), the best response function, which, given a context for the game returns a relation on the set of strategies. A strategy σ is related to another strategy σ' if the latter is a best response to the former.

An open game is thought of as a process that receives observations (X) ‘from the past’, and the utility (R) ‘from the future’. Similarly, it outputs moves (Y) covariantly and coutility (S) contravariantly.

6 Games on graphs: a compositional approach

$$\begin{array}{c} X \rightarrow \\ \left[\mathcal{G} \right] \\ S \leftarrow \end{array} \begin{array}{c} \leftarrow Y \\ \leftarrow R \end{array}$$

Open games are morphisms in a symmetric monoidal category **Game**. Composition, shown below left, is sequential play: $\mathcal{H} \cdot \mathcal{G}$ is thought of as \mathcal{H} happening after \mathcal{G} , observing the moves of \mathcal{G} and feeding back its coutility as \mathcal{G} 's utility. The monoidal product of open games represents two games played independently. The games are placed side by side with no connections, as shown below right.

$$\begin{array}{c} X \rightarrow \\ \left[\mathcal{G} \right] \\ S \leftarrow \end{array} \begin{array}{c} Y \\ \leftarrow R \end{array} \begin{array}{c} \leftarrow \\ \left[\mathcal{H} \right] \\ \leftarrow Q \end{array} \begin{array}{c} X_1 \rightarrow \\ X_2 \rightarrow \\ \left[\mathcal{G}_1 \right] \\ S_1 \leftarrow \\ S_2 \leftarrow \end{array} \begin{array}{c} \leftarrow Y_1 \\ \leftarrow Y_2 \\ \leftarrow R_1 \\ \leftarrow R_2 \end{array}$$

In order to formally define composition and monoidal product of games, it is useful to rephrase the definition in terms of lenses [18]. The details are recalled in Appendix A.

► **Definition 9 (The category **Game**).** **Game** is the symmetric monoidal category that has pairs of sets $(\begin{smallmatrix} X \\ S \end{smallmatrix})$ as objects and (equivalence classes of) open games $\mathcal{G}: (\begin{smallmatrix} X \\ S \end{smallmatrix}) \xrightarrow{\Sigma} (\begin{smallmatrix} Y \\ R \end{smallmatrix})$ as morphisms.

Classical games are *scalars* in **Game**, i.e. open games $(\begin{smallmatrix} 1 \\ 1 \end{smallmatrix}) \rightarrow (\begin{smallmatrix} 1 \\ 1 \end{smallmatrix})$. The fix-points of the best response functions of scalars in **Game** are the Nash equilibria of the classical game they represent.

Next we define specific open games used in our compositional account of network games. The first is the Utility Maximising Player, modelling typical players of classical game theory.

► **Definition 10 (Utility Maximising Player).** Let X and Y be sets and $\text{argmax}: \mathbb{R}^Y \rightarrow \mathcal{P}(Y)$ take a function $\kappa: Y \rightarrow \mathbb{R}$ to the subset of Y where κ is maximised. Define \mathcal{D} to be:

$$\mathcal{D}: \left(\begin{smallmatrix} X \\ 1 \end{smallmatrix} \right) \xrightarrow{Y^X} \left(\begin{smallmatrix} Y \\ \mathbb{R} \end{smallmatrix} \right) \quad \begin{array}{c} X \rightarrow \\ \left[\max \right] \\ \leftarrow Y \\ \leftarrow \mathbb{R} \end{array}$$

$$\begin{cases} \mathbb{P}_{\mathcal{D}}(f, x) = f(x) \\ \mathbb{C}_{\mathcal{D}}(f, x, r) = * \\ \mathbb{B}_{\mathcal{D}}(x, \kappa) = \{(y, y') \in Y^X \times Y^X : y'(x) \in \text{argmax}(\kappa)\} \end{cases}$$

The category of sets and functions **Set** embeds into **Game** in two ways. In our compositional account of network games, these embeddings encode how neighbours influence each other's utilities.

► **Definition 11.** Let X, Y be sets and $f: X \rightarrow Y$ a function. Its covariant lifting is defined:

$$f^*: \left(\begin{smallmatrix} X \\ 1 \end{smallmatrix} \right) \xrightarrow{1} \left(\begin{smallmatrix} Y \\ 1 \end{smallmatrix} \right) \quad \begin{array}{c} X \rightarrow \\ \left[f \right] \\ \rightarrow Y \end{array}$$

$$\begin{cases} \mathbb{P}_{f^*}(*, x) = f(x) \\ \mathbb{C}_{f^*}(*, x, *) = * \\ \mathbb{B}_{f^*}(x, *) = \{(*, *)\} \end{cases}$$

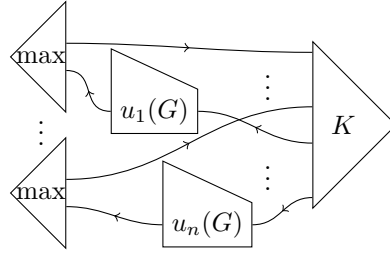

■ **Figure 1** Open game representing a network game \mathcal{N} played on a multigraph G

Similarly, its contravariant lifting is the following:

$$f_* : \left(\frac{1}{Y} \right) \xrightarrow{1} \left(\frac{1}{X} \right)$$

$$\begin{cases} \mathbb{P}_{f_*}(*, *) = * \\ \mathbb{C}_{f_*}(*, *, x) = f(x) \\ \mathbb{B}_{f_*}(*, x) = \{(*, *)\} \end{cases} \quad Y \leftarrow \boxed{f} \leftarrow X$$

To obtain the games of Examples 4, 5 and 6 as scalars in **Game**, the players are taken to be utility-maximising players. The connectivity of the ambient multigraph G determines their utility functions as contravariant liftings $u_i(G)$, while the context K sends back the choices of all players:

$$K : \left(X^n \times \dots \times X^n \right) \xrightarrow{1} \left(\frac{1}{1} \right)$$

$$\mathbb{C}_K(\underline{x}) = (\underline{x}, \dots, \underline{x}).$$

The respective games are then obtained as the composition illustrated in Fig. 1. When the network game \mathcal{N} is a *monoid* network game, the corresponding class of open games is given by a monoidal functor from **Grph**, defined in the next section, to **Game**. These details are in Section 5.

4 Open graphs

Here we extend the compositional approach to graph theory of [7] from simple graphs to undirected multigraphs, thereby identifying a “syntax” of network games as the arrows of a prop¹ **Grph**, generated from a monoidal signature and equations. We also provide a useful characterisation of **Grph** that explains its arrows as “open graphs”. Differently from other approaches [3, 9], **Grph** uses adjacency matrices (Definition 2). Indeed, the presentation includes generators

$$\bullet \text{---} : 0 \rightarrow 1, \quad \text{---} \bullet : 2 \rightarrow 1, \quad \text{---} \bullet : 1 \rightarrow 0, \quad \text{---} \bullet \text{---} : 1 \rightarrow 2 \quad (\text{BIALG})$$

and the equations of Fig. 2. The prop **B** generated by this data is isomorphic [14, 25] to the prop of matrices with entries from \mathbb{N} , with composition being matrix multiplication.

► **Example 12.** The following string diagram in **B** corresponds to the 3×2 matrix $\begin{pmatrix} 2 & 1 \\ 0 & 1 \\ 1 & 0 \end{pmatrix}$.

¹ A prop [16, 14] is a symmetric strict monoidal category where the objects are \mathbb{N} , and $m \otimes n := m + n$.

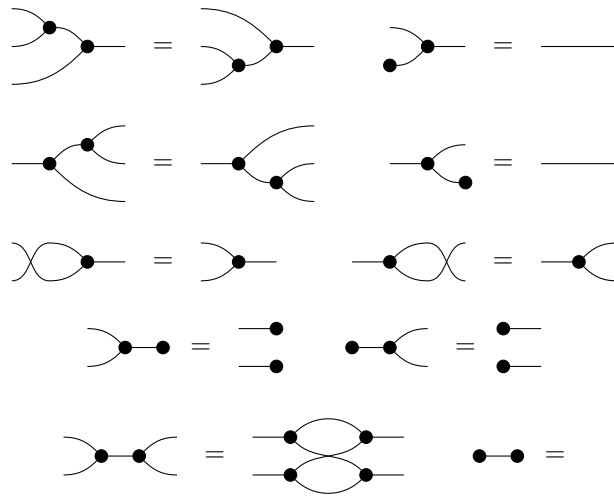

■ **Figure 2** Commutative bialgebra equations, yielding prop **B**.

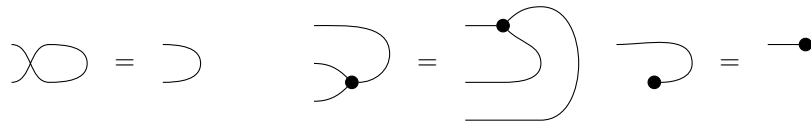

■ **Figure 3** Equations of **U**, which together with the equations of Fig. 2 yield prop **BU**.

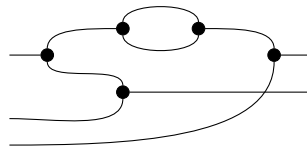

To convert between the two, think of the matrix as recording the numbers of paths: indeed, the (i, j) th entry in the matrix is the number of paths from the i th left port to the j th right port.

Next, we add a “cup” generator denoted

$$\cup : 2 \rightarrow 0 \tag{U}$$

with its equations given in Fig. 3. Let **BU** be the prop obtained from **(BIALG)** and **(U)**, quotiented by equations in Figs. 2 and 3. Just as **B** captures ordinary matrices, **BU** captures adjacency matrices:

► **Proposition 13.** *For $n \in \mathbb{N}$, the hom-set $[n, 0]$ of **BU** is in bijection with $n \times n$ adjacency matrices.*

► **Example 14.** The equivalence relation of adjacency matrices is captured by the equations of Fig. 3. Consider two equivalent matrices $A = \begin{pmatrix} 0 & 1 \\ 1 & 0 \end{pmatrix} \sim \begin{pmatrix} 0 & 2 \\ 0 & 0 \end{pmatrix} = A'$. Their corresponding diagram in **BU** is obtained by constructing their diagram in **B** as in Example 12 and “plugging” them in the following.

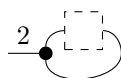

The two diagrams obtained are equated by the axioms of **BU**.

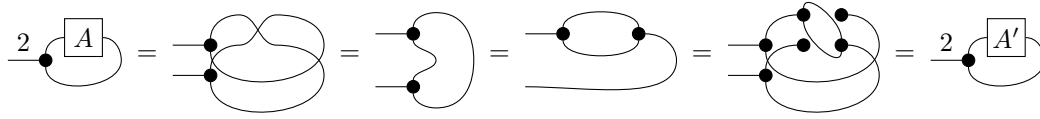

The prop **BU** can be given a straightforward combinatorial characterisation as the prop **Adj**.

► **Definition 15 (Adj).** A morphism $\alpha: m \rightarrow n$ in the prop **Adj** [7] is a pair $(B, [A])$, where $B \in \text{Mat}_{\mathbb{N}}(m, n)$ is a matrix, while $[A]$, with $A \in \text{Mat}_{\mathbb{N}}(m, m)$, is an adjacency matrix. The components of **Adj** morphisms can be read off a “normal form” for **BU** arrows, as illustrated below.

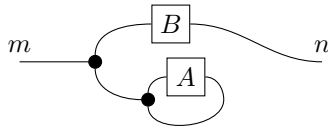

Composition in **Adj** becomes intuitive when visualised with string diagrams.

$$(B, [A]) \circ (B', [A']) = (BB', [A + BA'A'^T])$$

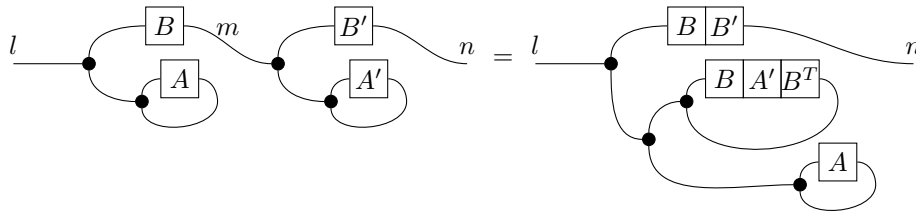

► **Proposition 16.** **BU** is isomorphic to the prop **Adj**. ◀

The proof is similar to the case for \mathbb{Z}_2 shown in in [7]. An extension of **BU** with just one additional generator and no additional equations yields the prop **Grph** of central interest for us.

► **Definition 17.** The prop **Grph** is obtained by from the generators in (BIALG) and (U) together with a generator $\bullet \text{---} : 0 \rightarrow 1$. The equations are those of Figs. 2 and 3.

As we shall see, arrows $0 \rightarrow 0$ in **Grph** are precisely finite undirected multigraphs taken up-to isomorphism: the additional generator plays the role of a graph vertex.

► **Example 18.** For example, the first of the following represents a multigraph with two vertices, connected by a single edge. The second one, two vertices connected by two edges. The third one, is a multigraph with three vertices and two edges between them.

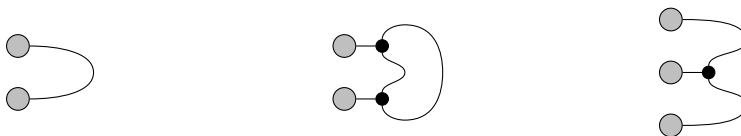

While the arrows $[0, 0]$ are (isomorphism classes of) multigraphs, general arrows can be understood as open graphs but their description is a little bit more involved. Roughly speaking, they are graphs together with interfaces, and data that specifies the connectivity of the graph to its interfaces. We make this explicit below. Indeed, we shall see (Theorem 22) that the prop \mathcal{A} , defined below, is isomorphic to **Grph** – for this reason we use **Grph** string diagrams to illustrate its structure.

► **Definition 19** (The prop \mathcal{A}). A morphism $\Gamma: m \rightarrow n$ in the prop \mathcal{A} is defined by

$$\Gamma = (k, [A], B, C, D, [E]) \tag{3}$$

where $k \in \mathbb{N}$, $A \in \mathbf{Mat}_{\mathbb{N}}(m, m)$, $B \in \mathbf{Mat}_{\mathbb{N}}(m, n)$, $C \in \mathbf{Mat}_{\mathbb{N}}(m, k)$, $D \in \mathbf{Mat}_{\mathbb{N}}(k, n)$ and $E \in \mathbf{Mat}_{\mathbb{N}}(k, k)$. Similarly to **Adj** (Definition 15), the components of (3) can be read off a “normal form” for arrows of **Grph**, as visualised below right.

Tuples (3) are taken up to an equivalence relation that captures the fact that the order of the vertices is immaterial. Let $\Gamma \sim \Gamma'$ iff they are morphisms of the same type, $\Gamma, \Gamma': m \rightarrow n$ with k vertices, and there is a permutation matrix $P \in \mathbf{Mat}(k, k)$ such that $\Gamma' = (k, [A], B, CP^T, PD, [PEP^T])$. The justification for this equivalence is the equality of the following two string diagrams in **Grph**, below (for the details, see Appendix B on page 19).

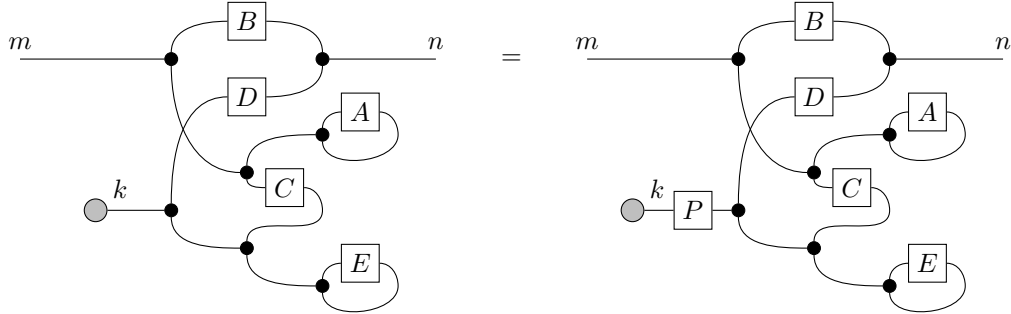
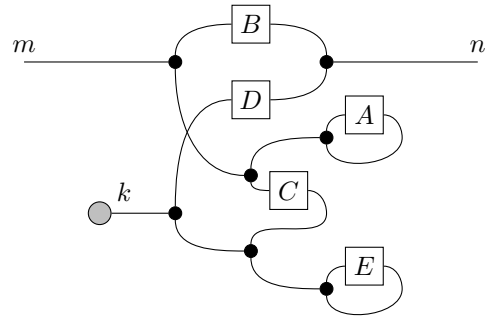

It is worthwhile to give some intuition for the components of (3). The idea is that an arrow Γ specifies a multigraph $G = (k, [E])$, and:

- B specifies connections between the two boundaries, bypassing G
- C specifies the connections between the left boundary and G
- D specifies the connections between G and the right boundary
- A specifies the connections between the interfaces on the left boundary. This allows Γ to introduce connections between the vertices of an “earlier” open graph Δ . See Example 20 below.

Defining composition in \mathcal{A} is straightforward, given the above intuitions, but the details are rather tedious: see Lemma 37 in Appendix B.

► **Example 20.** In a composite term $\Delta ; \Gamma$, the second component may introduce edges between the vertices in the first component. The first diagram in Example 18 can be decomposed as follows, where the second component connects the two vertices in the first component.

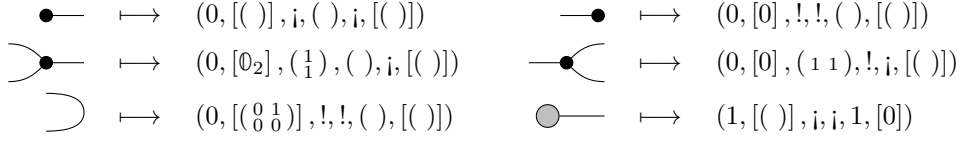
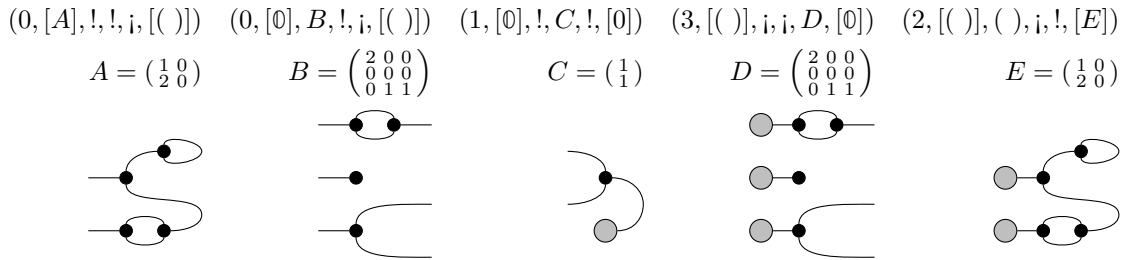

Figure 4 Image of θ on the generators



We write $!$ for matrices with no columns, j for matrices with no rows and $()$ for the empty matrix.

► **Example 21.** The following show the role of each component of \mathcal{A} morphisms, when isolated as the only non-trivial component. The leftmost open graph has only left-side ports. It introduces a self loop and two additional connections. The second has only connections between the left and right interfaces; the first left port is connected twice to the first right right, the second port is disconnected, and the third left port is connected to the second and third right ports. The third open graph has one vertex connected to the two left ports. The fourth has three vertices connected to the right ports, following the specification in the second. The rightmost (closed) multigraph has its two vertices connected according to the specification of the leftmost vertex-less open graph.



The main result in this section is the following.

► **Theorem 22.** *There is an isomorphism of props $\theta: \mathbf{Grph} \rightarrow \mathcal{A}$.*

The remainder of this section builds a proof of the above, summarised in the diagram below.

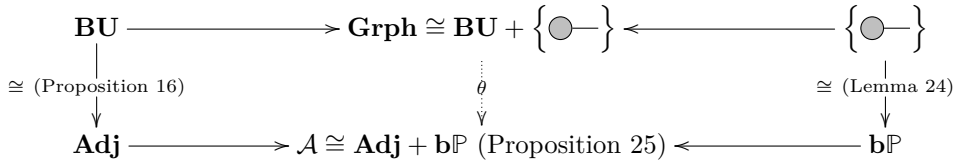

First, note that \mathbf{Grph} is the coproduct $\mathbf{BU} + \{0 \rightarrow 1\}$ in the category of props, where $\{0 \rightarrow 1\}$ is the free prop on a single generator $0 \rightarrow 1$. Next, we characterise $\{0 \rightarrow 1\}$ as \mathbf{bP} , defined below, in Lemma 24. Given that $\mathbf{BU} \cong \mathbf{Adj}$, as shown in Proposition 16, to show the existence of θ it suffices to show that \mathcal{A} satisfies the universal property of the coproduct $\mathbf{Adj} + \mathbf{bP}$, which we do in Proposition 25. The action of θ on the generators of \mathbf{Grph} is shown in Fig. 4.

► **Definition 23** (\mathbf{bP}). The prop of bound permutations \mathbf{bP} has as morphisms $m \rightarrow m+k$ pairs $[(k, P)]$ where $k \in \mathbb{N}$ and $P \in \mathbf{Mat}_{\mathbb{N}}(m+k, m+k)$ is a permutation matrix. Such pairs are identified to ensure that the order of the lower k rows of P is immaterial. Roughly speaking, considering P as a permutation of $m+k$ inputs to $m+k$ outputs, in $[(k, P)]$ the final k inputs are “bound”. Explicitly, $(k, P) \sim (k, P')$ iff there is a permutation $\sigma \in \mathbf{Mat}_{\mathbb{N}}(k, k)$ st $P = \begin{pmatrix} \mathbb{1}_m & 0 \\ 0 & \sigma \end{pmatrix} P'$. Composition is defined:

$$(l, Q) \circ (k, P) = (k+l, \begin{pmatrix} P & 0 \\ 0 & \mathbb{1}_l \end{pmatrix} Q)$$

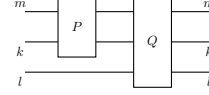

Identities are identity matrices $id_n = (0, \mathbb{1}_n)$. The fact that \mathbf{bP} is a prop is Lemma 38 in Appendix B.

► **Lemma 24.** \mathbf{bP} is isomorphic to $\left\{ \begin{array}{c} \bullet \\ \text{---} \end{array} \right\}$.

Proof. Let us call $\phi = (0, (1)) : 0 \rightarrow 1$, which is a morphism in \mathbf{bP} . We show directly that, for any other prop \mathbb{P} that contains a morphism $v : 0 \rightarrow 1$, there is a unique prop homomorphism $\alpha^\# : \mathbf{bP} \rightarrow \mathbb{P}$ such that $\alpha^\#(\phi) = v$. The details are given as Lemma 39 in Appendix B. ◀

Given the results of Proposition 16 and Lemma 24, we obtain the isomorphism $\theta : \mathbf{Grph} \rightarrow \mathcal{A}$, thereby completing the proof of Theorem 22, by showing that:

► **Proposition 25.** \mathcal{A} satisfies the universal property of the coproduct $\mathbf{Adj} + \mathbf{bP}$.

Proof. In order to show that \mathcal{A} is a coproduct $\mathbf{Adj} + \mathbf{bP}$, we define the two inclusions.

$$\begin{array}{ll} i_1 : \mathbf{Adj} \longrightarrow \mathcal{A} & i_2 : \mathbf{bP} \longrightarrow \mathcal{A} \\ n \longmapsto n & n \longmapsto n \\ (B, [A]) \longmapsto (0, [A], B, !, i, [(\])) & (k, P) \longmapsto (k, [0_n], P_*^{[1, n]}, 0_{nk}, P_*^{[n+1, n+k]}, [0_k]) \end{array}$$

We indicate with $P_*^{[1, n]}$ the first n rows of the matrix P and, similarly, with $P_*^{[n+1, n+k]}$ the rows between the $n+1$ -th and the $n+k$ -th. It is not difficult to show that these are indeed homomorphism, the details are given as Claim 40 in Appendix B.

Now, we show that, for any other prop \mathcal{C} with prop homomorphisms $\mathbf{Adj} \xrightarrow{f_1} \mathcal{C} \xleftarrow{f_2} \mathbf{bP}$, there exists a unique prop homomorphism $H : \mathcal{A} \rightarrow \mathcal{C}$ such that $H \circ i_1 = f_1$ and $H \circ i_2 = f_2$. Define the map:

$$\begin{array}{l} H : \mathcal{A} \longrightarrow \mathcal{C} \\ n \longmapsto n \\ (k, [A], B, C, D, [E]) \longmapsto f_1 \left(\begin{pmatrix} B \\ D \end{pmatrix}, \left[\begin{pmatrix} A & C \\ 0 & E \end{pmatrix} \right] \right) \circ (\mathbb{1}_m \otimes f_2(k, \mathbb{1}_k)) \end{array}$$

We verify that H is a homomorphism in Lemma 41 in Appendix B. Next, we confirm that $H \circ i_1 = f_1$ and $H \circ i_2 = f_2$:

$$H \circ i_1(B, [A]) = H(0, [A], B, !, i, [(\]))$$

$$= f_1(B, [A]) \circ (\mathbb{1}_m \otimes f_2(0, \mathbb{1}_0)) \left(\begin{array}{c} \text{Diagram: A box with } B \text{ and } A \text{ inside, } f_1 \text{ above, } f_2 \text{ below, and } \mathbb{1}_0 \text{ at the bottom.} \end{array} \right) = f_1(B, [A]) \left(\begin{array}{c} \text{Diagram: A box with } B \text{ and } A \text{ inside, } f_1 \text{ above.} \end{array} \right)$$

$$\begin{aligned} H \circ i_2(k, P) &= H(k, [\mathbb{0}_n], P_*^{[1,n]}, \mathbb{0}_{nk}, P_*^{[n+1, n+k]}, [\mathbb{0}_k]) \\ &= f_1(P, [\mathbb{0}_{n+k}]) \circ (\mathbb{1}_n \otimes f_2(k, \mathbb{1}_k)) \left(\begin{array}{c} \text{Diagram: A box with } P \text{ inside, } f_1 \text{ above, } f_2 \text{ below, and } k \text{ at the bottom.} \end{array} \right) = P \circ f_2(k, \mathbb{1}_{n+k}) \left(\begin{array}{c} \text{Diagram: A box with } P \text{ inside, } f_2 \text{ below, and } k \text{ at the bottom.} \end{array} \right) \\ &= f_2(k, P) \left(\begin{array}{c} \text{Diagram: A box with } P \text{ inside, } f_2 \text{ below, and } k \text{ at the bottom.} \end{array} \right) \end{aligned}$$

Moreover, H is the unique prop homomorphism with these properties. In fact, suppose there is $H': \mathcal{A} \rightarrow \mathcal{C}$ such that $H' \circ i_1 = f_1$ and $H' \circ i_2 = f_2$. Then:

$$\begin{aligned} H'(k, [A], B, C, D, [E]) &= H'(i_1((\frac{B}{D}), [(\frac{A}{C} \ E)]) \circ (\mathbb{1}_m \otimes i_2(k, \mathbb{1}_k))) \\ &= H' i_1((\frac{B}{D}), [(\frac{A}{C} \ E)]) \circ (H'(\mathbb{1}_m) \otimes H' i_2(k, \mathbb{1}_k)) \\ &= f_1((\frac{B}{D}), [(\frac{A}{C} \ E)]) \circ (\mathbb{1}_m \otimes f_2(k, \mathbb{1}_k)) \\ &= H(k, [A], B, C, D, [E]). \end{aligned}$$

◀

5 Games on graphs via functorial semantics

Here we show that monoid network games \mathcal{N} define monoidal functors $F_{\mathcal{N}}: \mathbf{Grph} \rightarrow \mathbf{Game}$, which is our main contribution. To every open graph Γ , $F_{\mathcal{N}}$ associates an open game, where \mathcal{N} is played on Γ . We give an explicit account of the $F_{\mathcal{N}}$ -image of open graphs Γ , using the characterisation of Theorem 22. We also explain how $F_{\mathcal{N}}$ acts on closed graphs, which gives classical games.

Fix a monoid network game $\mathcal{N} = (X, M, f, g)$ (Definition 7). Since \mathbf{Grph} is presented by generators and equations, it suffices to define $F_{\mathcal{N}}$ on the generators and prove that it respects the equations.

- On objects, $F_{\mathcal{N}}(1) = (\frac{M}{M})$. Thus, for $n \in \mathbf{Grph}$, we have $F_{\mathcal{N}}(n) = (\frac{M^n}{M^n})$
- The vertex $\text{max} \circlearrowleft : 0 \rightarrow 1$ is mapped to the open game $F_{\mathcal{N}}(\text{max} \circlearrowleft) : (\frac{1}{1}) \xrightarrow{X} (\frac{M}{M})$ defined by
 - $\Sigma_{F_{\mathcal{N}}(\text{max} \circlearrowleft)} = X$
 - $\mathbb{P}_{F_{\mathcal{N}}(\text{max} \circlearrowleft)}(x_i, *) = f(x_i)$
 - $\mathbb{C}_{F_{\mathcal{N}}(\text{max} \circlearrowleft)}(x_i, *, m) = *$
 - $(x_i, x'_i) \in \mathbb{B}_{F_{\mathcal{N}}(\text{max} \circlearrowleft)}(*, \kappa) : M \rightarrow M$ iff $x'_i \in \arg \max_{x''_i: X} g(x''_i, \kappa(f(x''_i)))$
- The generators (BIALG) are mapped to the bialgebra structure on (M, M) induced by the monoid action of M . Specifically, they are:

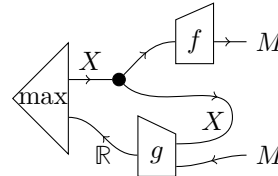

$$\begin{array}{l}
F_{\mathcal{N}}(\text{---}\bullet\text{---}): \begin{pmatrix} M \\ M \end{pmatrix} \xrightarrow{1} \begin{pmatrix} M^2 \\ M^2 \end{pmatrix} \quad \begin{array}{c} M \rightarrow \bullet \\ \bullet \rightarrow M \\ \bullet \rightarrow M \\ \bullet \rightarrow M \end{array} \quad F_{\mathcal{N}}(\text{---}\bullet): \begin{pmatrix} M \\ M \end{pmatrix} \xrightarrow{1} \begin{pmatrix} 1 \\ 1 \end{pmatrix} \quad \begin{array}{c} M \rightarrow \bullet \\ M \leftarrow \ominus \end{array} \\
\left\{ \begin{array}{l} \mathbb{P}(*, m) = (m, m) \\ \mathbb{C}(*, m_1, m_2, m_3) = m_2 \oplus m_3 \end{array} \right. \quad \begin{array}{c} M \leftarrow \oplus \\ \oplus \rightarrow M \\ \oplus \rightarrow M \\ \oplus \rightarrow M \end{array} \quad \left\{ \begin{array}{l} \mathbb{P}(*, m) = * \\ \mathbb{C}(*, m, *) = e \end{array} \right. \\
F_{\mathcal{N}}(\text{---}\bullet\text{---}): \begin{pmatrix} M \\ M \end{pmatrix} \xrightarrow{1} \begin{pmatrix} M^2 \\ M^2 \end{pmatrix} \quad \begin{array}{c} M \rightarrow \oplus \\ \oplus \rightarrow M \\ \oplus \rightarrow M \\ \oplus \rightarrow M \end{array} \quad F_{\mathcal{N}}(\bullet\text{---}): \begin{pmatrix} 1 \\ 1 \end{pmatrix} \xrightarrow{1} \begin{pmatrix} M \\ M \end{pmatrix} \quad \begin{array}{c} \ominus \rightarrow M \\ \bullet \leftarrow M \end{array} \\
\left\{ \begin{array}{l} \mathbb{P}(*, m_1, m_2) = m_1 \oplus m_2 \\ \mathbb{C}(*, m_1, m_2, m_3) = (m_1, m_1) \end{array} \right. \quad \begin{array}{c} M \rightarrow \oplus \\ \oplus \rightarrow M \\ \oplus \rightarrow M \\ \oplus \rightarrow M \end{array} \quad \left\{ \begin{array}{l} \mathbb{P}(*, *) = e \\ \mathbb{C}(*, *, m) = * \end{array} \right.
\end{array}$$

where each of these open games is built from lifted functions (Definition 11).

- $\text{---}\bullet\text{---}: 2 \rightarrow 0$ is mapped to the following open game (see [12])

$$\begin{array}{l}
F_{\mathcal{N}}(\text{---}\bullet\text{---}): \begin{pmatrix} M^2 \\ M^2 \end{pmatrix} \xrightarrow{1} \begin{pmatrix} 1 \\ 1 \end{pmatrix} \quad \begin{array}{c} M \text{---}\bullet\text{---} \\ M \text{---}\bullet\text{---} \\ M \text{---}\bullet\text{---} \\ M \text{---}\bullet\text{---} \end{array} \\
\left\{ \begin{array}{l} \mathbb{P}(*, m_1, m_2) = * \\ \mathbb{C}(*, m_1, m_2, *) = (m_2, m_1) \end{array} \right.
\end{array}$$

To prove that $F_{\mathcal{N}}$ is a symmetric monoidal functor it suffices to show that the equations of **Grph** are respected; this is a straightforward but somewhat lengthy computation.

- **Theorem 26.** $F_{\mathcal{N}}$ defines a symmetric monoidal functor **Grph** \rightarrow **Game**.

Proof. See Appendix C, on page 29. ◀

Note that $F_{\mathcal{N}}$ does *not* respect the axioms of (C1) or (C2) of [7], so it does not define a functor **ABUV** \rightarrow **Game** in the terminology of that paper. This, together with the increased expressivity of multigraphs over simple graphs, motivates our extension from **ABUV** to **Grph**.

Using Theorem 22, we have a convenient “normal form” for the arrows of **Grph** and can therefore give an explicit description of the image of any (open) graph Γ under $F_{\mathcal{N}}$. First, we specialise to closed graphs because these result in ordinary network games. This result—a sanity check for our compositional framework—is a corollary of the more general Theorem 28, proved subsequently.

- **Corollary 27.** Let $\mathcal{N} = (X, M, f, g)$ be a monoid network game, and consider $\Gamma: 0 \rightarrow 0$ in **Grph**, an undirected multigraph with k vertices. Then the open game $F_{\mathcal{N}}(\Gamma): \begin{pmatrix} 1 \\ 1 \end{pmatrix} \xrightarrow{X^k} \begin{pmatrix} 1 \\ 1 \end{pmatrix}$ has:

- $\Sigma_{F_{\mathcal{N}}(\Gamma)} = X^k$ as its strategy profiles,
- $\mathbb{B}_{F_{\mathcal{N}}(\Gamma)}(*, *) \subseteq X^k \times X^k$ is the best response relation of \mathcal{N} played on Γ .

Note that while the expressions in the statement of Theorem 28 below may seem involved, they are actually derived in an entirely principled manner from the generators of **Grph**, given our compositional framework. Indeed, the proof is by structural induction on the morphisms of **Grph**.

- **Theorem 28.** Let $\mathcal{N} = (X, M, f, g)$ be a monoid network game. Let $\Gamma: i \rightarrow j$ be a morphism in **Grph** with k vertices st $\theta(\Gamma) = (k, [A], B, C, D, [E])$, where $A: i \times i$, $B: i \times j$, $C: i \times k$, $D: k \times j$ and $E: k \times k$. Then the open game $F_{\mathcal{N}}(\Gamma): \begin{pmatrix} M^i \\ M^i \end{pmatrix} \xrightarrow{X^k} \begin{pmatrix} M^j \\ M^j \end{pmatrix}$ is as follows:

- The set of strategy profiles is $\Sigma(F_{\mathcal{N}}(\Gamma)) = X^k$
- The play function $\mathbb{P}_{F_{\mathcal{N}}(\Gamma)} : X^k \times M^i \rightarrow M^j$ is given by $\mathbb{P}_{F_{\mathcal{N}}(\Gamma)}(\underline{\sigma}, \underline{x}) = B^T \underline{x} \oplus D^T f(\underline{\sigma})$
- The coplay function $\mathbb{C}_{F_{\mathcal{N}}(\Gamma)} : X^k \times M^i \times M^j \rightarrow M^i$ is $\mathbb{C}_{F_{\mathcal{N}}(\Gamma)}(\underline{\sigma}, \underline{x}, \underline{r}) = (A + A^T)\underline{x} \oplus B\underline{r} \oplus C f(\underline{\sigma})$
- The best response relation $\mathbb{B}_{F_{\mathcal{N}}(\Gamma)} : M^i \times (M^j \rightarrow M^j) \rightarrow \mathcal{P}(X^k \times X^k)$ is given by $(\underline{\sigma}, \underline{\sigma}') \in \mathbb{B}_{F_{\mathcal{N}}(\Gamma)}(\underline{x}, \kappa)$ iff, for all k ,

$$\sigma'_k \in \operatorname{argmax}_{s \in X} g(s, (C^T)_*^k \underline{x} \oplus D_*^k \kappa (B^T \underline{x} \oplus D^T f(\underline{\sigma}[k \mapsto s])) \oplus (E + E^T)_*^k f(\underline{\sigma}[k \mapsto s]))$$

Proof. See Appendix C on page 31. ◀

6 Examples

We return to our motivating examples: the majority (Example 4), the best-shot public goods (Example 5) and the weakest-link public goods (Example 6) games, and demonstrate various applications of our framework. We first show that computing the Nash equilibrium of the majority game played on interconnected cliques reduces to calculating equilibria of its clique subgames.

► **Example 29 (Majority game).** In the majority game the best response can be decomposed into the best responses of its components. Let \mathcal{N} be the monoid network game that models the majority game, defined on page 5, and consider a graph composed of N cliques, connected as follows:

- each vertex of each clique can be connected to at most one vertex of another clique,
 - in each clique there is at least one vertex not connected to any vertex outside its clique.
- Such graphs decompose as N open graphs, each a clique with some vertices connected to its boundary. We omit the details and give, instead, an illustrative example: below left is a picture of three connected cliques, while the schematic string diagram on the right is a corresponding expression in **Grph**.

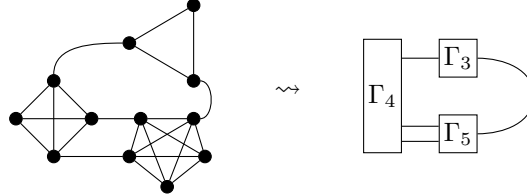

It is easy to show (Appendix D, Proposition 42) that the choice of each clique does not depend on the choices of other cliques. Indeed, the Nash equilibria of the majority game played on connected cliques in our sense are those strategy profiles where, in every clique, all players make the same choice. In particular, there are 2^N Nash equilibria.

In some cases, players can take into account the choice of another player with a different intensity. This can be modelled by changing the number of edges between the vertices. Let us consider the above example with some of the vertices connected multiple times. This modification of the network—illustrated on the right—reflects in a modification of the equilibria, which are now strategy profiles in which every player takes the same choice.

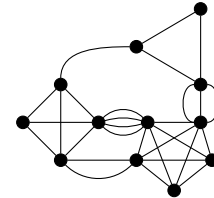

In the best-shot public goods game (Example 5), the Nash equilibrium is when no player invests. In Example 30, we modify this game by allowing one player to interact with the

environment. This modification “opens” the game to one of type $(\frac{1}{1}) \rightarrow (\frac{X}{\mathbb{R}})$: as a result, the Nash equilibrium changes.

► **Example 30** (Best-shot public goods game). Consider the best-shot public goods game played on a graph that contains a vertex connected to all other vertices. Removing the central vertex from this graph leaves an open graph that we will call Γ .

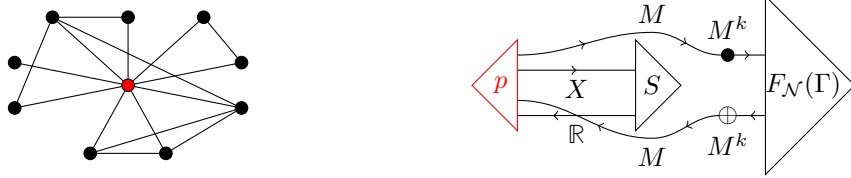

Here, $F_{\mathcal{N}}(\Gamma)$ is the best-shot public goods game played on the open graph Γ , p is the central player that have been substituted, and S is the external open game that influences p . The utility function of player p and the coplay function of S are as follows.

$$u_p(\Gamma, x) = \begin{cases} 1 - c + \delta & \text{if } x_c = 1 \\ 1 - \epsilon & \text{if } x_c = 0 \wedge \exists(c, j) \in E_{\Gamma} \ x_j = 1 \\ 1 - c & \text{if } \forall j \ x_j = 0 \end{cases} \quad S: (\frac{X}{\mathbb{R}}) \xrightarrow{1} (\frac{1}{1})$$

$$\mathbb{C}(*, x, *) = \begin{cases} \delta & \text{if } x = 1 \\ -\epsilon & \text{if } x = 0 \end{cases}$$

The addition of the open game S and the modification of player p modifies the Nash equilibrium to be the strategy profile where the central player invests and no other player does. The idea is that the “external” agent S incentivises the central player p to invest. The details are in Appendix D.

Our last example illustrates a common situation where the compositional description of a game does *not* allow a compositional analysis of the best response. However, in this case, compositionality can be used to give a variant of the weakest-link public goods game (Example 6) where different cost functions are used in different parts of the ambient graph G . The desired game is obtained by composing the resulting open games according to the structure of G .

► **Example 31** (Weakest-link public goods game). Consider the weakest-link public goods game played on a connected graph G . Suppose that players have different cost functions. We partition them according to their cost functions, and use this partition to decompose the G into an expression in **Grph**, as illustrated for a particular example below:



While the definition above uses our compositional techniques, the Nash equilibrium (Appendix D, Propositions 46 and 47) is calculated on the resulting closed game, and is a strategy profile where every player invests equally, with utility depending on individual cost functions.

7 Conclusions

Our contribution is a compositional account of network games via strict monoidal functors. This adds a class of network games to the games that have been expressed in compositional game theory [12, 2]. Of independent interest is our work on the category **Grph**, extending [7].

This is an approach to “open graphs” that, as we have seen, is compatible with the structure of open games, and in future work we will identify other uses of this category.

We also intend to extend the class of open graphs to *directed* open graphs. The motivation for this is that, in some network games, interactions between players are *not* bidirectional. Consider, for example, a variant of the majority game where there is an “influencer”: a player whose choice affects the choices of other players, but is not in turn conversely affected.

We will also extend the menagerie of games that can be played on a graph. We plan to study games with more generic utility functions, incomplete information, and repeated games. It could also prove interesting to study natural transformations between the functors that define games, and explore the game theoretical relevance of such transformations.

References

- 1 John C Baez and Brendan Fong. A compositional framework for passive linear networks. *arXiv preprint arXiv:1504.05625*, 2015.
- 2 Joe Bolt, Jules Hedges, and Philipp Zahn. Bayesian open games, 2019. arXiv preprint [arXiv:1910.03656](https://arxiv.org/abs/1910.03656).
- 3 Filippo Bonchi, Fabio Gadducci, Aleks Kissinger, Paweł Sobociński, and Fabio Zanasi. Rewriting modulo symmetric monoidal structure. In *Thirty-first annual ACM/IEEE symposium on Logic and Computer Science (LiCS 2016)*, pages 710–719, 2016.
- 4 Filippo Bonchi, Paweł Sobociński, and Fabio Zanasi. The calculus of signal flow diagrams I: Linear relations on streams. *Inf. Comput.*, 252:2–29, 2017.
- 5 Yann Bramoullé, Andrea Galeotti, and Brian Rogers. *The Oxford handbook of the economics of networks*. Oxford University Press, 2016.
- 6 Roberto Bruni, Hernán C. Melgratti, and Ugo Montanari. A connector algebra for P/T nets interactions. In *Concurrency Theory (CONCUR '11)*, volume 6901 of *LNCS*, pages 312–326. Springer, 2011. doi:10.1007/978-3-642-23217-6_21.
- 7 Apiwat Chantawibul and Paweł Sobociński. Towards compositional graph theory. In *Proceedings of MFPS'15*, volume 319 of *ENTCS*, pages 121–136, 2015. doi:10.1016/j.entcs.2015.12.009.
- 8 Bryce Clarke, Derek Elkins, Jeremy Gibbons, Fosco Loregian, Bartosz Milewski, Emily Pillmore, and Mario Román. Profunctor optics, a categorical update, 2020. arXiv preprint [arXiv:2001.07488v1](https://arxiv.org/abs/2001.07488v1).
- 9 Brendan Fong. Decorated cospans. *Theory and Applications of Categories*, 30(33):1096–1120, 2015.
- 10 James H Fowler and Nicholas A Christakis. Dynamic spread of happiness in a large social network: longitudinal analysis over 20 years in the framingham heart study. *BMJ*, 337, 2008. URL: <https://www.bmj.com/content/337/bmj.a2338>, arXiv:<https://www.bmj.com/content/337/bmj.a2338.full.pdf>, doi:10.1136/bmj.a2338.
- 11 Andrea Galeotti. Talking, searching and pricing. *International Economic Review*, 51(4):1159–1174, 2010. URL: <https://onlinelibrary.wiley.com/doi/abs/10.1111/j.1468-2354.2010.00614.x>, arXiv:<https://onlinelibrary.wiley.com/doi/pdf/10.1111/j.1468-2354.2010.00614.x>, doi:10.1111/j.1468-2354.2010.00614.x.
- 12 Neil Ghani, Jules Hedges, Viktor Winschel, and Philipp Zahn. Compositional game theory. In *Proceedings of Logic in Computer Science (LiCS) 2018*. ACM, 2018. doi:10.1145/3209108.3209165.
- 13 Matthew Jackson and Yves Zenou. Games on networks. In *Handbook of game theory with economic applications*, volume 4, chapter 3, pages 95–163. Elsevier, 2015. doi:10.1016/B978-0-444-53766-9.00003-3.
- 14 Stephen Lack. Composing PROPs. *Theor. App. Categories*, 13(9):147–163, 2004.

- 15 Qiu Li, MingChu Li, Lin Lv, Cheng Guo, and Kun Lu. A new prediction model of infectious diseases with vaccination strategies based on evolutionary game theory. *Chaos, Solitons & Fractals*, 104:51 – 60, 2017. URL: <http://www.sciencedirect.com/science/article/pii/S0960077917303156>, doi:<https://doi.org/10.1016/j.chaos.2017.07.022>.
- 16 Saunders Mac Lane. Categorical algebra. *Bull. Amer. Math. Soc.*, 71:40–106, 1965.
- 17 Saunders Mac Lane. *Categories for the Working Mathematician*. Springer-Verlag New York, 1978.
- 18 Frank Joseph Oles. *A Category-theoretic Approach to the Semantics of Programming Languages*. PhD thesis, Syracuse University, Syracuse, NY, USA, 1982. AAI8301650.
- 19 Matthew Pickering, Jeremy Gibbons, and Nicolas Wu. Profunctor optics: Modular data accessors. *Programming Journal*, 1(2):7, 2017. URL: <https://doi.org/10.22152/programming-journal.org/2017/1/7>, doi:10.22152/programming-journal.org/2017/1/7.
- 20 Mitchell Riley. Categories of optics, 2018. arXiv preprint [arXiv:1809.00738](https://arxiv.org/abs/1809.00738).
- 21 Alfred Tarski. The concept of truth in the languages of the deductive sciences. *Prace Towarzystwa Naukowego Warszawskiego, Wydział III Nauk Matematyczno-Fizycznych*, 34(13-172):198, 1933.
- 22 Alfred Tarski and Robert L Vaught. Arithmetical extensions of relational systems. *Compositio mathematica*, 13:81–102, 1957.
- 23 Giorgio Topa. Social Interactions, Local Spillovers and Unemployment. *The Review of Economic Studies*, 68(2):261–295, 04 2001. URL: <https://doi.org/10.1111/1467-937X.00169>, arXiv: <https://academic.oup.com/restud/article-pdf/68/2/261/4369386/68-2-261.pdf>, doi: 10.1111/1467-937X.00169.
- 24 Glynn Winskel. *The formal semantics of programming languages: an introduction*. MIT press, 1993.
- 25 Fabio Zanasi. *Interacting Hopf Algebras: the theory of linear systems*. PhD thesis, École Normale Supérieure, 2015.

A

 Definitions for Section 3

For the formal definition of an open game, it is convenient to use the notion of *lens* [18]. (For other references to how lenses are used in functional programming see [19] or [20, 8].)

► **Definition 32 (Lens).** Given sets X, S, Y, R , a lens $\lambda: \binom{X}{S} \rightarrow \binom{Y}{R}$ is given by two functions

- $v_\lambda: X \rightarrow Y$ called the *view function*
- $u_\lambda: X \times R \rightarrow S$ called the *update function*

Lens composition of $\lambda: \binom{X}{S} \rightarrow \binom{Y}{R}$ and $\mu: \binom{Y}{R} \rightarrow \binom{Z}{Q}$ is given by $v_{\mu \circ \lambda} = v_\mu \circ v_\lambda$ and $u_{\mu \circ \lambda}(x, q) = u_\lambda(x, u_\mu(v_\lambda(x), q))$. Lenses form a symmetric monoidal category, with the monoidal product that is given on objects by $\binom{X_1}{S_1} \otimes \binom{X_2}{S_2} = \binom{X_1 \times X_2}{S_1 \times S_2}$.

► **Definition 33 (Open game).** Let X, Y, R, S, Σ be sets. An open game $\mathcal{G}: \binom{X}{S} \xrightarrow{\Sigma} \binom{Y}{R}$ is:

- A family of lenses $\lambda_\sigma: \binom{X}{S} \rightarrow \binom{Y}{R}$ indexed by $\sigma \in \Sigma$
- $\mathbb{B}_{\mathcal{G}}: \mathbb{H}(\mathcal{G}) \times \mathbb{K}(\mathcal{G}) \rightarrow \mathcal{P}(\Sigma^2)$, called the *best response function*, where

$$\mathbb{H}(\mathcal{G}) = \text{Lens} \left[\binom{1}{1}, \binom{X}{S} \right] \cong X, \quad \mathbb{K}(\mathcal{G}) = \text{Lens} \left[\binom{Y}{R}, \binom{1}{1} \right] \cong Y \rightarrow R$$

are called, respectively, the *history* and *continuation* of \mathcal{G} . The pair $(\mathbb{H}(\mathcal{G}), \mathbb{K}(\mathcal{G}))$ is called the *context* of \mathcal{G} .

Spelling out this definition, the game \mathcal{G} is given by three functions.

- $\mathbb{P}_{\mathcal{G}}: \Sigma \times X \rightarrow Y$, called *play function*
- $\mathbb{C}_{\mathcal{G}}: \Sigma \times X \times R \rightarrow S$, called *coplay function*
- $\mathbb{B}_{\mathcal{G}}: X \times (Y \rightarrow R) \rightarrow \mathcal{P}(\Sigma^2)$, called *best response function*

In order to be able to express a network game compositionally, we need the definitions of composition and monoidal product of open games.

► **Definition 34** (Sequential composition of open games). Let $\mathcal{G}: \left(\begin{smallmatrix} X \\ S \end{smallmatrix}\right) \xrightarrow{\Sigma_{\mathcal{G}}} \left(\begin{smallmatrix} Y \\ R \end{smallmatrix}\right)$ and $\mathcal{H}: \left(\begin{smallmatrix} Y \\ R \end{smallmatrix}\right) \xrightarrow{\Sigma_{\mathcal{H}}} \left(\begin{smallmatrix} Z \\ Q \end{smallmatrix}\right)$ be open games. Their sequential composition

$$\mathcal{H} \cdot \mathcal{G}: \left(\begin{smallmatrix} X \\ S \end{smallmatrix}\right) \xrightarrow{\Sigma_{\mathcal{G}} \times \Sigma_{\mathcal{H}}} \left(\begin{smallmatrix} Z \\ Q \end{smallmatrix}\right)$$

is given by the parametric lens $(\mathcal{H} \cdot \mathcal{G})_{(\sigma, \tau)} = \mathcal{H}_{\tau} \circ \mathcal{G}_{\sigma}$ indexed by $(\sigma, \tau) \in \Sigma_{\mathcal{G}} \times \Sigma_{\mathcal{H}}$. Let $x \in \mathbb{H}(\mathcal{H} \cdot \mathcal{G})$ and $\kappa \in \mathbb{K}(\mathcal{H} \cdot \mathcal{G})$. The best response function of $\mathcal{H} \cdot \mathcal{G}$ is defined as follows.

$$\mathbb{B}_{\mathcal{H} \cdot \mathcal{G}}(x, \kappa) = \{(\sigma, \tau, \sigma', \tau') \in (\Sigma_{\mathcal{G}} \times \Sigma_{\mathcal{H}})^2 : (\sigma, \sigma') \in \mathbb{B}_{\mathcal{G}}(x, \kappa \circ \mathcal{H}_{\tau}) \wedge (\tau, \tau') \in \mathbb{B}_{\mathcal{H}}(\mathcal{G}_{\sigma} \circ x, \kappa)\}$$

► **Definition 35** (Parallel composition of open games). Let $\mathcal{G}_1: \left(\begin{smallmatrix} X_1 \\ S_1 \end{smallmatrix}\right) \xrightarrow{\Sigma_1} \left(\begin{smallmatrix} Y_1 \\ R_1 \end{smallmatrix}\right)$ and $\mathcal{G}_2: \left(\begin{smallmatrix} X_2 \\ S_2 \end{smallmatrix}\right) \xrightarrow{\Sigma_2} \left(\begin{smallmatrix} Y_2 \\ R_2 \end{smallmatrix}\right)$ be open games. Their parallel composition

$$\mathcal{G}_1 \otimes \mathcal{G}_2: \left(\begin{smallmatrix} X_1 \times X_2 \\ S_1 \times S_2 \end{smallmatrix}\right) \xrightarrow{\Sigma_1 \times \Sigma_2} \left(\begin{smallmatrix} Y_1 \times Y_2 \\ R_1 \times R_2 \end{smallmatrix}\right)$$

is given by the parametric lens $(\mathcal{G}_1 \otimes \mathcal{G}_2)_{(\sigma_1, \sigma_2)} = (\mathcal{G}_1)_{\sigma_1} \otimes (\mathcal{G}_2)_{\sigma_2}$ indexed by $(\sigma_1, \sigma_2) \in \Sigma_1 \times \Sigma_2$. Let $(x_1, x_2) \in \mathbb{H}(\mathcal{G}_1 \otimes \mathcal{G}_2)$ and $\kappa \in \mathbb{K}(\mathcal{G}_1 \otimes \mathcal{G}_2)$. The best response function of $\mathcal{G}_1 \otimes \mathcal{G}_2$ is defined as follows.

$$\begin{aligned} \mathbb{B}_{\mathcal{G}_1 \otimes \mathcal{G}_2}(x_1 \otimes x_2, \kappa) = & \{(\sigma_1, \sigma_2, \sigma'_1, \sigma'_2) \in (\Sigma_1 \times \Sigma_2)^2 : \\ & (\sigma_1, \sigma'_1) \in \mathbb{B}_{\mathcal{G}_1}(x_1, \kappa \circ \Pi_1(\mathcal{G}_2, \sigma_2, x_2)) \wedge \\ & (\sigma_2, \sigma'_2) \in \mathbb{B}_{\mathcal{G}_2}(x_2, \kappa \circ \Pi_2(\mathcal{G}_1, \sigma_1, x_1))\} \end{aligned}$$

where Π_1 and Π_2 are the lenses

$$\begin{aligned} \Pi_1(\mathcal{G}_2, \sigma_2, x_2): \left(\begin{smallmatrix} Y_1 \\ R_1 \end{smallmatrix}\right) & \rightarrow \left(\begin{smallmatrix} Y_1 \times Y_2 \\ R_1 \times R_2 \end{smallmatrix}\right) & \Pi_2(\mathcal{G}_1, \sigma_1, x_1): \left(\begin{smallmatrix} Y_2 \\ R_2 \end{smallmatrix}\right) & \rightarrow \left(\begin{smallmatrix} Y_1 \times Y_2 \\ R_1 \times R_2 \end{smallmatrix}\right) \\ \left\{ \begin{array}{l} v_{\Pi_1}(y) = (y, \mathbb{P}_{\mathcal{G}_2}(\sigma_2, x_2)) \\ u_{\Pi_1} = \pi_{R_1} \end{array} \right. & & \left\{ \begin{array}{l} v_{\Pi_2}(y) = (\mathbb{P}_{\mathcal{G}_1}(\sigma_1, x_1), y) \\ u_{\Pi_2} = \pi_{R_2} \end{array} \right. \end{aligned}$$

Composition of open games is not associative on the nose for the simple reason that $\Sigma_1 \times (\Sigma_2 \times \Sigma_3) \neq (\Sigma_1 \times \Sigma_2) \times \Sigma_3$. It is needed to quotient by the following equivalence relation.

► **Definition 36** (Equivalence classes of open games). Two open games $\mathcal{G}: \left(\begin{smallmatrix} X \\ S \end{smallmatrix}\right) \xrightarrow{\Sigma} \left(\begin{smallmatrix} Y \\ R \end{smallmatrix}\right)$ and $\mathcal{G}': \left(\begin{smallmatrix} X \\ S \end{smallmatrix}\right) \xrightarrow{\Sigma'} \left(\begin{smallmatrix} Y \\ R \end{smallmatrix}\right)$ are equivalent if there is a bijection $s: \Sigma \rightarrow \Sigma'$ such that, for all $\sigma, \rho \in \Sigma$, $x \in X$, $r \in R$ and $\kappa: Y \rightarrow R$,

$$\begin{aligned} \mathbb{P}_{\mathcal{G}}(\sigma, x) &= \mathbb{P}_{\mathcal{G}'}(s(\sigma), x) \\ \mathbb{C}_{\mathcal{G}}(\sigma, x, r) &= \mathbb{C}_{\mathcal{G}'}(s(\sigma), x, r) \\ (\sigma, \rho) \in \mathbb{B}_{\mathcal{G}}(x, \kappa) &\Leftrightarrow (s(\sigma), s(\rho)) \in \mathbb{B}_{\mathcal{G}'}(x, \kappa) \end{aligned}$$

At this point, it is possible to define the category whose morphisms are open games [12].

B Proofs for Section 4

Details for definition 19. By naturality of the symmetries, the vertex generators commute with any permutation matrix P .

$$\bullet \xrightarrow{k} \boxed{P} \text{---} = \bullet \xrightarrow{k} \text{---}$$

Thus, we can show that $\Gamma = (k, [A], B, C, D, [E])$ and $\Gamma' = (k, [A], B, CP^T, PD, [PEP^T])$ represent the same open graph.

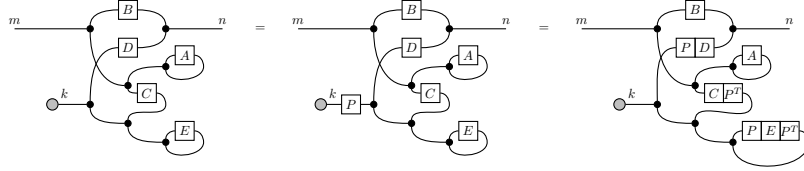

► **Lemma 37.** \mathcal{A} is a prop.

Proof. We start by proving that \mathcal{A} is a category. Composition is defined as follows because the diagram on the left, which is the graphical composition of the two morphisms, can be rewritten, using the axioms of \mathbf{B} , as the diagram on the right, which represents the definition of composition given as a formula.

$$\Gamma' \circ \Gamma = \left(k + k', [A + BA'B^T], BB', (C + B(A' + A'^T)D^T | BC'), \begin{pmatrix} DB' \\ D' \end{pmatrix}, \left[\begin{array}{cc} E + DA'D^T & DC' \\ 0 & E' \end{array} \right] \right)$$

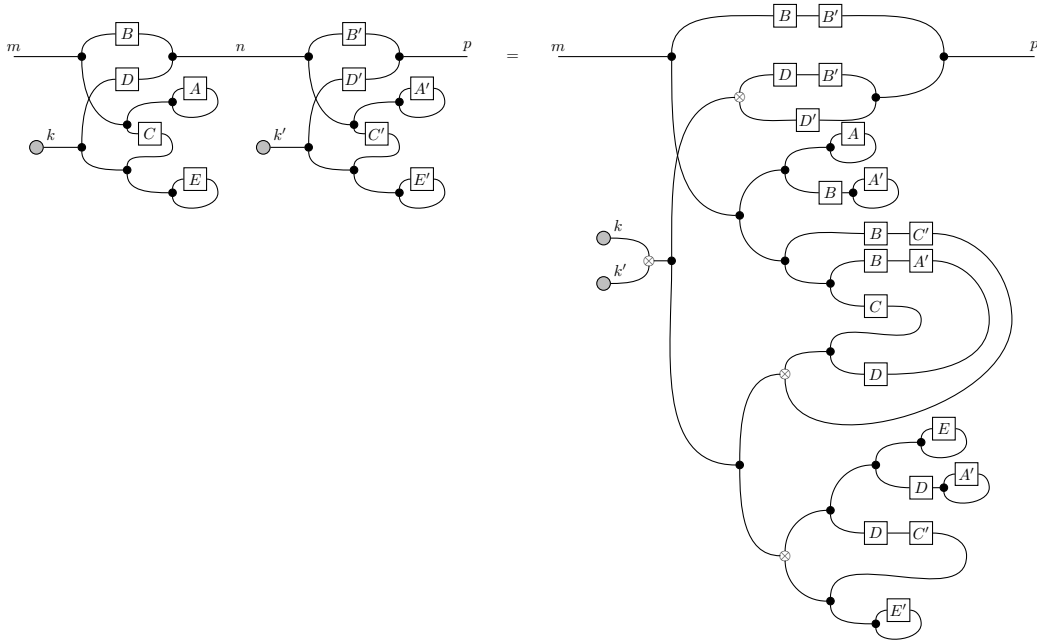

Identities are defined in the obvious way.

$$\mathbb{1}_n = (0, [0_n], \mathbb{1}_n, !, i, [(\)])$$

We need to check that the definition of composition is coherent with the equivalence classes. Let $\Gamma = (k, [A], B, C, D, [E]) \sim (k, [A], B, CP^T, PD, [PEP^T]) = \Gamma_0$ and $\Gamma' = (k', [A'], B', C', D', [E']) \sim (k', [A'], B', C'P'^T, P'D', [P'E'P'^T]) = \Gamma'_0$.

$$\Gamma'_0 \circ \Gamma_0$$

$$\begin{aligned}
&= (k + k', [A + BA'B^T], BB', (CP^T + B(A' + A'^T)D^T P^T | BC' P'^T), \\
&\quad \left(\begin{array}{c} PDB' \\ P'D' \end{array} \right), \left[\left(\begin{array}{cc} PEP^T + PDA'D^T P^T & PDC' P'^T \\ 0 & P'E' P'^T \end{array} \right) \right] \\
&\sim \Gamma' \circ \Gamma
\end{aligned}$$

with permutation matrix $\begin{pmatrix} P & 0 \\ 0 & P' \end{pmatrix}$.

Composition is associative because the matrices relative to the vertices are $[]$ -equivalent.

$$\begin{aligned}
&\Gamma'' \circ (\Gamma' \circ \Gamma) \\
&= (k + k' + k'', [A + B(A' + B'A''B'^T)B^T], BB'B'', \\
&\quad (C + B(A' + A'^T + B'(A'' + A''^T)B'^T)D^T | B(C' + B'(A'' + A''^T)D'^T | B(B'C'')), \\
&\quad \left(\begin{array}{c} DB'B'' \\ D'B'' \\ D'' \end{array} \right), \left[\left(\begin{array}{ccc} E+D(A'+B'A''B'^T)D^T & D(C'+B'A''D'^T) & D(B'C'') \\ D'A''B'^TD^T & E'+D'A''D'^T & D'C'' \\ 0 & 0 & E'' \end{array} \right) \right] \\
&= (k + k' + k'', [A + B(A' + B'A''B'^T)B^T], BB'B'', \\
&\quad (C + B(A' + A'^T + B'(A'' + A''^T)B'^T)D^T | B(C' + B'(A'' + A''^T)D'^T | B(B'C'')), \\
&\quad \left(\begin{array}{c} DB'B'' \\ D'B'' \\ D'' \end{array} \right), \left[\left(\begin{array}{ccc} E+D(A'+B'A''B'^T)D^T & D(C'+B'(A''+A''^T)D'^T) & D(B'C'') \\ 0 & E'+D'A''D'^T & D'C'' \\ 0 & 0 & E'' \end{array} \right) \right] \\
&= (\Gamma'' \circ \Gamma') \circ \Gamma
\end{aligned}$$

Clearly, composition is unital and we proved that \mathcal{A} is a category. Now we prove that it is monoidal.

Lead by the interpretation of the matrices that define a morphism, we define monoidal product as follows.

$$\Gamma \otimes \Gamma' = (k + k', [(\begin{smallmatrix} A & 0 \\ 0 & A' \end{smallmatrix})], (\begin{smallmatrix} B & 0 \\ 0 & B' \end{smallmatrix}), (\begin{smallmatrix} C & 0 \\ 0 & C' \end{smallmatrix}), (\begin{smallmatrix} D & 0 \\ 0 & D' \end{smallmatrix}), [(\begin{smallmatrix} E & 0 \\ 0 & E' \end{smallmatrix})])$$

The monoidal unit is the empty diagram.

$$\mathbb{1} = (0, [(\quad), (\quad), (\quad), (\quad), [(\quad)])$$

We verify that monoidal product is well-defined on equivalence classes. Let

$$\begin{aligned}
\Gamma &= (k, [A], B, C, D, [E]) \sim (k, [A], B, CP^T, PD, [PEP^T]) = \Gamma_0 \\
\Gamma' &= (k', [A'], B', C', D', [E']) \sim (k', [A'], B', C'P'^T, P'D', [P'E'P'^T]) = \Gamma'_0
\end{aligned}$$

Then,

$$\begin{aligned}
&\Gamma_0 \otimes \Gamma'_0 \\
&= \left(k + k', [(\begin{smallmatrix} A & 0 \\ 0 & A' \end{smallmatrix})], (\begin{smallmatrix} B & 0 \\ 0 & B' \end{smallmatrix}), \left(\begin{array}{cc} CP^T & 0 \\ 0 & C'P'^T \end{array} \right), \left(\begin{array}{cc} PD & 0 \\ 0 & P'D' \end{array} \right), \left[\left(\begin{array}{cc} PEP^T & 0 \\ 0 & P'E'P'^T \end{array} \right) \right] \right) \\
&\sim \Gamma \otimes \Gamma'
\end{aligned}$$

with permutation matrix $\begin{pmatrix} P & 0 \\ 0 & P' \end{pmatrix}$, which is the monoidal product of P and P' .

Clearly, monoidal product is strictly associative and unital. Therefore, the pentagon and the triangle equations [17] hold trivially. We are left to check that the monoidal product is a functor.

$$\begin{aligned}
&(\Gamma_0 \circ \Gamma) \otimes (\Gamma'_0 \circ \Gamma_0) \\
&= (k + k_0 + k' + k'_0, \left[\left(\begin{array}{cc} A+BA_0A^T & 0 \\ 0 & A'+B'A'_0A'^T \end{array} \right) \right], \left(\begin{array}{cc} BB_0 & 0 \\ 0 & B'B'_0 \end{array} \right), \\
&\quad \left(\begin{array}{ccc} C+B(A_0+A_0^T)D^T & BC_0 & 0 \\ 0 & 0 & C'+B'(A'_0+A_0'^T)D'^T & B'C'_0 \end{array} \right), \\
&\quad \left(\begin{array}{cc} 0 & 0 \end{array} \right) \right)
\end{aligned}$$

$$\begin{aligned}
& \left(\begin{array}{cc} DB_0 & 0 \\ D_0 & 0 \\ 0 & D'B'_0 \\ 0 & D'_0 \end{array} \right), \left[\left(\begin{array}{ccc} E+DA_0D^T & DC_0 & 0 \\ 0 & E_0 & 0 \\ 0 & 0 & E'+D'A'_0D'^T \\ 0 & 0 & 0 \end{array} \right) \begin{array}{c} 0 \\ 0 \\ D'C'_0 \\ E'_0 \end{array} \right) \\
\sim & (k+k'+k_0+k'_0, \left[\left(\begin{array}{cc} A+BA_0A^T & 0 \\ 0 & A'+B'A'_0A'^T \end{array} \right), \left(\begin{array}{cc} BB_0 & 0 \\ 0 & B'B'_0 \end{array} \right), \right. \\
& \left. \left(\begin{array}{ccc} C+B(A_0+A_0^T)D^T & 0 & BC_0 \\ 0 & C'+B'(A'_0+A_0'^T)D'^T & 0 \end{array} \right) \begin{array}{c} 0 \\ 0 \\ B'C'_0 \end{array} \right) \\
& \left. \left(\begin{array}{cc} DB_0 & 0 \\ D_0 & 0 \\ 0 & D'B'_0 \\ 0 & D'_0 \end{array} \right), \left[\left(\begin{array}{ccc} E+DA_0D^T & 0 & DC_0 \\ 0 & E'+D'A'_0D'^T & 0 \\ 0 & 0 & E_0 \end{array} \right) \begin{array}{c} 0 \\ 0 \\ D'C'_0 \\ E'_0 \end{array} \right) \right] \\
= & (\Gamma_0 \otimes \Gamma'_0) \circ (\Gamma \otimes \Gamma')
\end{aligned}$$

with permutation matrix $P = \begin{pmatrix} \mathbb{1} & 0 & 0 & 0 \\ 0 & 0 & \mathbb{1} & 0 \\ 0 & \mathbb{1} & 0 & 0 \\ 0 & 0 & 0 & \mathbb{1} \end{pmatrix}$.

Thus, \mathcal{A} is a monoidal category. Finally, we prove that it is symmetric. Let $\sigma_{m,n}$ indicate the symmetry and let it be defined as follows.

$$\sigma_{m,n} = (0, [0], \left(\begin{array}{cc} 0 & \mathbb{1}_m \\ \mathbb{1}_n & 0 \end{array} \right), !, i, [(\)])$$

Clearly, the symmetry is its own inverse: $\sigma_{m,n} \circ \sigma_{n,m} = \mathbb{1}_{m+n}$.

Moreover, σ is natural.

$$\begin{aligned}
\sigma_{n,n'} \circ (\Gamma \otimes \Gamma') &= (k+k', [(\begin{array}{cc} A & 0 \\ 0 & A' \end{array})], \left(\begin{array}{cc} 0 & B \\ B' & 0 \end{array} \right), \left(\begin{array}{cc} C & 0 \\ 0 & C' \end{array} \right), \left(\begin{array}{cc} 0 & D \\ D' & 0 \end{array} \right), [(\begin{array}{cc} E & 0 \\ 0 & E' \end{array})]) \\
&\sim (k+k', [(\begin{array}{cc} A & 0 \\ 0 & A' \end{array})], \left(\begin{array}{cc} 0 & B \\ 0 & B' \end{array} \right), \left(\begin{array}{cc} 0 & C \\ C' & 0 \end{array} \right), \left(\begin{array}{cc} D' & 0 \\ 0 & D \end{array} \right), [(\begin{array}{cc} E' & 0 \\ 0 & E \end{array})]) \\
&= (\Gamma' \otimes \Gamma) \circ \sigma_{m,m'}
\end{aligned}$$

with permutation matrix $P = \begin{pmatrix} 0 & \mathbb{1} \\ \mathbb{1} & 0 \end{pmatrix}$.

Lastly, the symmetry satisfies the hexagon equations.

$$\begin{aligned}
(\mathbb{1}_n \otimes \sigma_{p,m}) \circ \sigma_{m,n+p} &= (0, [0], \left(\begin{array}{ccc} 0 & 0 & \mathbb{1}_m \\ \mathbb{1}_n & 0 & 0 \\ 0 & \mathbb{1}_p & 0 \end{array} \right) \left(\begin{array}{ccc} \mathbb{1}_n & 0 & 0 \\ 0 & 0 & \mathbb{1}_p \\ 0 & \mathbb{1}_m & 0 \end{array} \right), !, i, [(\)]) \\
&= (0, [0], \left(\begin{array}{ccc} 0 & \mathbb{1}_m & 0 \\ \mathbb{1}_n & 0 & 0 \\ 0 & 0 & \mathbb{1}_p \end{array} \right), !, i, [(\)]) \\
&= \sigma_{m,n} \otimes \mathbb{1}_p
\end{aligned}$$

$$\begin{aligned}
(\sigma_{p,m} \otimes \mathbb{1}_n) \circ \sigma_{m+n,p} &= (0, [0], \left(\begin{array}{ccc} 0 & \mathbb{1}_m & 0 \\ 0 & 0 & \mathbb{1}_n \\ \mathbb{1}_p & 0 & 0 \end{array} \right) \left(\begin{array}{ccc} 0 & \mathbb{1}_p & 0 \\ \mathbb{1}_m & 0 & 0 \\ 0 & 0 & \mathbb{1}_n \end{array} \right), !, i, [(\)]) \\
&= (0, [0], \left(\begin{array}{ccc} \mathbb{1}_m & 0 & 0 \\ 0 & 0 & \mathbb{1}_n \\ 0 & \mathbb{1}_p & 0 \end{array} \right), !, i, [(\)]) \\
&= \mathbb{1}_m \otimes \sigma_{n,p}
\end{aligned}$$

Thus, \mathcal{A} is a symmetric monoidal category whose objects are natural numbers. In other words, it is a prop. \blacktriangleleft

► **Lemma 38.** \mathbf{bP} is a prop.

Proof. The proof proceeds exactly as the previous one. We will use diagrammatic calculus of \mathbf{Mat} for the permutation matrix of the morphisms in order to make the proofs more readable. We start by proving that \mathbf{bP} is a category. Composition is well-defined on equivalence classes by the monoidal structure of \mathbf{Mat} . Let $(k, P) \sim (k, \begin{pmatrix} \mathbb{1}_m & 0 \\ 0 & \sigma \end{pmatrix} P) = (k, P')$ and $(l, Q) \sim (l, \begin{pmatrix} \mathbb{1}_{m+k} & 0 \\ 0 & \rho \end{pmatrix} Q) = (l, Q')$.

$$\begin{aligned}
 & (l, Q') \circ (k, P') \\
 &= (k+l, \left(\begin{pmatrix} \mathbb{1}_m & 0 \\ 0 & \sigma \end{pmatrix} P \begin{pmatrix} 0 & 0 \\ 0 & \mathbb{1}_l \end{pmatrix} \right) \left(\begin{pmatrix} \mathbb{1}_{m+k} & 0 \\ 0 & \rho \end{pmatrix} Q \right) \\
 &= (k+l, \left(\begin{pmatrix} \mathbb{1}_m & 0 & 0 \\ 0 & \sigma & 0 \\ 0 & 0 & \rho \end{pmatrix} \begin{pmatrix} P & 0 \\ 0 & \mathbb{1}_l \end{pmatrix} Q \right) \\
 &\sim (l, Q) \circ (k, P)
 \end{aligned}$$

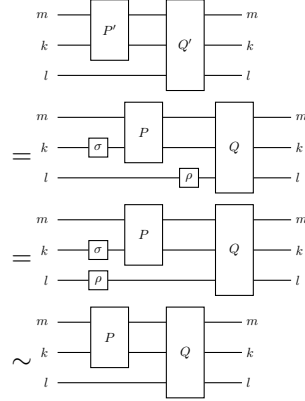

with permutation matrix $\begin{pmatrix} \mathbb{1}_m & 0 & 0 \\ 0 & \sigma & 0 \\ 0 & 0 & \rho \end{pmatrix}$. Composition is clearly associative because it is associative in **Mat**.

$$\begin{aligned}
 & ((l, R) \circ (k, Q)) \circ (j, P) \\
 &= (j+k+l, \left(\begin{pmatrix} P & 0 \\ 0 & \mathbb{1}_{k+l} \end{pmatrix} \begin{pmatrix} Q & 0 \\ 0 & \mathbb{1}_l \end{pmatrix} R \right) \\
 &= (j+k+l, \left(\begin{pmatrix} P & 0 \\ 0 & \mathbb{1}_k \end{pmatrix} Q \begin{pmatrix} 0 & 0 \\ 0 & \mathbb{1}_l \end{pmatrix} \right) R \\
 &= (l, R) \circ ((k, Q) \circ (j, P))
 \end{aligned}$$

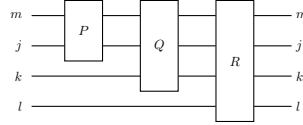

Composition is unital by unitality of the composition in **Mat**.

$$\begin{aligned}
 (k, P) \circ (0, \mathbb{1}_m) &= (0+k, \mathbb{1}_{m+k}P) = (k, P) \\
 (0, \mathbb{1}_{m+k}) \circ (k, P) &= (k+0, P\mathbb{1}_{m+k}) = (k, P)
 \end{aligned}$$

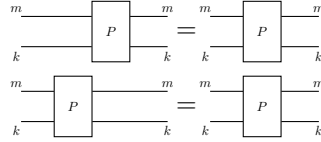

The monoidal product is defined with a symmetry on the left because we need to keep track of which of the inputs are bound.

$$(k, P) \otimes (k', P') = (k+k', \left(\begin{pmatrix} \mathbb{1}_m & 0 & 0 & 0 \\ 0 & 0 & \mathbb{1}_{m'} & 0 \\ 0 & \mathbb{1}_k & 0 & 0 \\ 0 & 0 & 0 & \mathbb{1}_{k'} \end{pmatrix} \begin{pmatrix} P & 0 \\ 0 & P' \end{pmatrix} \right))$$

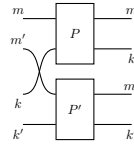

The monoidal unit is the empty diagram.

$$\mathbb{1} = (0, ())$$



Monoidal product is well-defined on equivalence classes by naturality of the symmetries in **Mat**. Let $(k, P) \sim (k, \begin{pmatrix} \mathbb{1}_m & 0 \\ 0 & \sigma \end{pmatrix} P) = (k, P')$ and $(l, Q) \sim (l, \begin{pmatrix} \mathbb{1}_n & 0 \\ 0 & \rho \end{pmatrix} Q) = (l, Q')$.

$$(k, P') \otimes (l, Q')$$

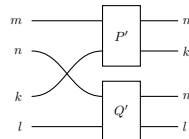

$$\begin{aligned}
&= (k + l, \left(\begin{array}{cccc} \mathbb{1}_m & 0 & 0 & 0 \\ 0 & 0 & \mathbb{1}_n & 0 \\ 0 & \mathbb{1}_k & 0 & 0 \\ 0 & 0 & 0 & \mathbb{1}_l \end{array} \right) \left(\begin{array}{cc} (\begin{array}{cc} \mathbb{1}_m & 0 \\ 0 & \sigma \end{array})P & 0 \\ 0 & (\begin{array}{cc} \mathbb{1}_n & 0 \\ 0 & \rho \end{array})Q \end{array} \right)) \\
&= (k + l, \left(\begin{array}{cccc} \mathbb{1}_m & 0 & 0 & 0 \\ 0 & \mathbb{1}_n & 0 & 0 \\ 0 & 0 & \sigma & 0 \\ 0 & 0 & 0 & \rho \end{array} \right) \left(\begin{array}{cccc} \mathbb{1}_m & 0 & 0 & 0 \\ 0 & 0 & \mathbb{1}_n & 0 \\ 0 & \mathbb{1}_k & 0 & 0 \\ 0 & 0 & 0 & \mathbb{1}_l \end{array} \right) \left(\begin{array}{cc} P & 0 \\ 0 & Q \end{array} \right)) \\
&\sim (k, P) \otimes (l, Q)
\end{aligned}$$

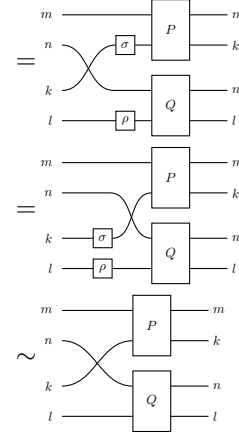

with permutation matrix $\begin{pmatrix} \mathbb{1}_{m+n} & 0 & 0 \\ 0 & \sigma & 0 \\ 0 & 0 & \rho \end{pmatrix}$. Monoidal product is a functor because we can change the order in which we enumerate the vertices and because symmetries are natural in **Mat**. For the calculations below, we indicate with $C = \begin{pmatrix} \mathbb{1}_m & 0 & 0 & 0 \\ 0 & 0 & \mathbb{1}_{m'} & 0 \\ 0 & \mathbb{1}_{k+l} & 0 & 0 \\ 0 & 0 & 0 & \mathbb{1}_{k'+l'} \end{pmatrix} \left(\begin{array}{cc} \begin{pmatrix} P & 0 \\ 0 & \mathbb{1}_l \end{pmatrix} Q & 0 \\ 0 & \begin{pmatrix} P' & 0 \\ 0 & \mathbb{1}_{l'} \end{pmatrix} Q' \end{array} \right)$ the matrix associated to $((l, Q) \circ (k, P)) \otimes ((l', Q') \circ (k', P'))$.

$$\begin{aligned}
&((l, Q) \circ (k, P)) \otimes ((l', Q') \circ (k', P')) \\
&= (k + l + k' + l', C) \\
&\sim (k + k' + l + l', \left(\begin{array}{cccc} \mathbb{1}_{m+m'+k} & 0 & 0 & 0 \\ 0 & 0 & \mathbb{1}_{k'} & 0 \\ 0 & \mathbb{1}_l & 0 & 0 \\ 0 & 0 & 0 & \mathbb{1}_{l'} \end{array} \right) C) \\
&= ((l, Q) \otimes (l', Q')) \circ ((k, P) \otimes (k', P'))
\end{aligned}$$

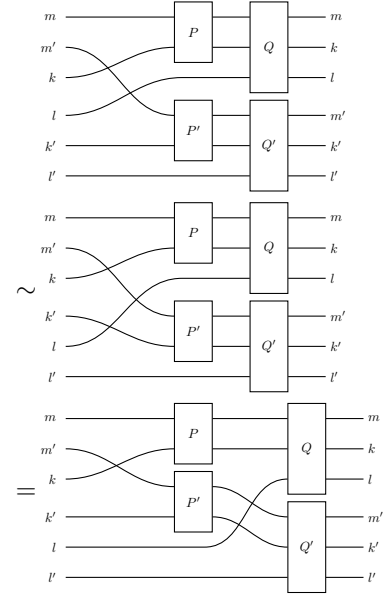

Monoidal product is clearly unital. The symmetry is lifted from **Mat**.

$$\sigma_{m,n} = (0, \begin{pmatrix} 0 & \mathbb{1}_m \\ \mathbb{1}_n & 0 \end{pmatrix})$$

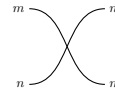

The symmetry is its own inverse and it satisfies the hexagon equations because it does so in **Mat**.

Therefore, **bP** is a prop. ◀

► **Lemma 39.** \mathbf{bP} is isomorphic to the free prop on one generator $0 \rightarrow 1$.

Proof. Define

$$\alpha^\# : \mathbf{bP} \longrightarrow \mathbb{P}$$

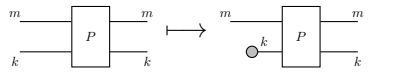
$$(k, P) \longmapsto P \circ (\mathbb{1}_m \otimes \bigotimes_k v)$$

where $P \in \mathbb{P}$ is the product of the symmetries that form P in \mathbf{bP} .

We prove that $\alpha^\#$ is well-defined on equivalence classes. Let $(k, P) \sim (k, (\begin{smallmatrix} \mathbb{1}_m & 0 \\ 0 & \sigma \end{smallmatrix}) P) = (k, P')$.

$$\begin{aligned} & \alpha^\#(k, P') \\ &= ((\begin{smallmatrix} \mathbb{1}_m & 0 \\ 0 & \sigma \end{smallmatrix}) P) \circ (\mathbb{1}_m \otimes v^k) \\ &= P \circ (\mathbb{1}_m \otimes \sigma) \circ (\mathbb{1}_m \otimes v^k) \\ &= P \circ (\mathbb{1}_m \otimes \sigma \circ v^k) \\ &= P \circ (\mathbb{1}_m \otimes v^k) \\ &= \alpha^\#(k, P) \end{aligned}$$

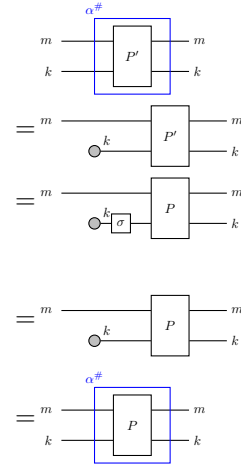

We show graphically that $\alpha^\#$ is a prop homomorphism

$$\begin{aligned} \alpha^\#(\mathbb{1}) &= \mathbb{1} \\ \alpha^\#(\mathbb{1}_n) &= \text{---}^n\text{---} = \mathbb{1}_n \\ \alpha^\#(0, \sigma) &= \text{---}\sigma\text{---} = \sigma \\ \alpha^\#((l, Q) \circ (k, P)) &= \text{---}^k\text{---} \text{---}^l\text{---} \text{---}^m\text{---} = \text{---}^k\text{---} \text{---}^l\text{---} \text{---}^m\text{---} = \alpha^\#(l, Q) \circ \alpha^\#(k, P) \\ \alpha^\#((k, P) \otimes (k', P')) &= \text{---}^m\text{---} \text{---}^{m'}\text{---} \text{---}^k\text{---} \text{---}^{k'}\text{---} = \text{---}^m\text{---} \text{---}^{m'}\text{---} \text{---}^k\text{---} \text{---}^{k'}\text{---} = \alpha^\#(k, P) \otimes \alpha^\#(k', P') \end{aligned}$$

and, by its definition,

$$\alpha^\#(\phi) = v$$



$$\begin{aligned}
 i_2(\mathbb{1}) &= \text{---} &= \mathbb{1} \\
 i_2(\mathbb{1}_n) &= \text{---}^n &= \mathbb{1}_n \\
 i_2(0, \sigma) &= \text{---} \boxed{\sigma} \text{---} &= \sigma \\
 i_2((l, Q) \circ (k, P)) &= \text{---} \begin{array}{c} \text{---} \boxed{P} \text{---} \boxed{Q} \text{---} \\ \text{---} \end{array} \text{---} &= i_2(l, Q) \circ i_1(k, P) \\
 i_2((k, P) \otimes (k', P')) &= \text{---} \begin{array}{c} \text{---} \boxed{P} \text{---} \\ \text{---} \boxed{P'} \text{---} \end{array} \text{---} &= i_2(k, P) \otimes i_2(k', P')
 \end{aligned}$$

► **Lemma 41.** *H, defined on page 12, is a prop homomorphism.*

Proof. Recall the definition of *H*.

$$\begin{aligned}
 H: \mathcal{A} &\longrightarrow \mathcal{C} \\
 n &\longmapsto n \\
 (k, [A], B, C, D, [E]) &\longmapsto f_1 \left(\left(\begin{array}{c} B \\ D \end{array} \right), \left[\left(\begin{array}{cc} A & C \\ 0 & E \end{array} \right) \right] \right) \circ (\mathbb{1}_m \otimes f_2(k, \mathbb{1}_k))
 \end{aligned}$$

where we called $w = \left(\begin{array}{c} B \\ D \end{array} \right), \left[\left(\begin{array}{cc} A & C \\ 0 & E \end{array} \right) \right]$, which is a morphism in **Adj**.

We need to prove that *H* is well-defined on equivalence classes. Let $\Gamma = (k, [A], B, C, D, [E]) \sim (k, [A], B, CP^T, PD, [PEP^T]) = \Gamma'$.

$$\begin{aligned}
 H(\Gamma') &= f_1 \left(\left(\begin{array}{c} B \\ PD \end{array} \right), \left[\left(\begin{array}{cc} A & CP^T \\ 0 & PEP^T \end{array} \right) \right] \right) \circ (\mathbb{1}_m \otimes f_2(k, \mathbb{1}_k)) \\
 &= f_1 \left(\left(\begin{array}{c} B \\ 0 \end{array} \right), \left[\left(\begin{array}{cc} A & C \\ 0 & E \end{array} \right) \right] \right) \circ \left(\left(\begin{array}{c} \mathbb{1}_m & 0 \\ 0 & P \end{array} \right), [0] \right) \circ (\mathbb{1}_m \otimes f_2(k, \mathbb{1}_k))
 \end{aligned}$$

$$= f_1 \left(\begin{pmatrix} B \\ D \end{pmatrix}, \left[\begin{pmatrix} A & C \\ 0 & E \end{pmatrix} \right] \right) \circ (\mathbb{1}_m \otimes P) \circ (\mathbb{1}_m \otimes f_2(k, \mathbb{1}_k))$$

$$= f_1 \left(\begin{pmatrix} B \\ D \end{pmatrix}, \left[\begin{pmatrix} A & C \\ 0 & E \end{pmatrix} \right] \right) \circ (\mathbb{1}_m \otimes P \circ f_2(k, \mathbb{1}_k))$$

$$= f_1 \left(\begin{pmatrix} B \\ D \end{pmatrix}, \left[\begin{pmatrix} A & C \\ 0 & E \end{pmatrix} \right] \right) \circ (\mathbb{1}_m \otimes f_2(k, \mathbb{1}_k)) = H(\Gamma)$$

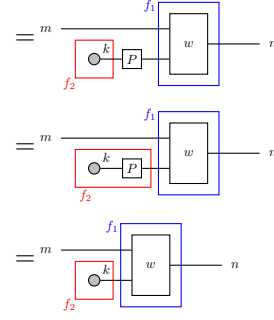

We prove that H is a prop homomorphism. Clearly, H is identity on objects. Moreover, it preserves composition, as it is shown by the diagrams.

$$H(\Gamma') \circ H(\Gamma)$$

$$= f_1 \left(\begin{pmatrix} B' \\ D' \end{pmatrix}, \left[\begin{pmatrix} A' & C' \\ 0 & E' \end{pmatrix} \right] \right) \circ (\mathbb{1}_n \otimes f_2(k', \mathbb{1}_{k'}))$$

$$\circ f_1 \left(\begin{pmatrix} B \\ D \end{pmatrix}, \left[\begin{pmatrix} A & C \\ 0 & E \end{pmatrix} \right] \right) \circ (\mathbb{1}_m \otimes f_2(k, \mathbb{1}_k))$$

$$= f_1 \left(\begin{pmatrix} B' \\ D' \end{pmatrix}, \left[\begin{pmatrix} A' & C' \\ 0 & E' \end{pmatrix} \right] \right) \circ (f_1 \left(\begin{pmatrix} B \\ D \end{pmatrix}, \left[\begin{pmatrix} A & C \\ 0 & E \end{pmatrix} \right] \right) \otimes \mathbb{1}_k)$$

$$\circ (\mathbb{1}_m \otimes f_2(k, \mathbb{1}_k) \otimes f_2(k', \mathbb{1}_{k'}))$$

$$= f_1 \left(\left(\begin{pmatrix} B' \\ D' \end{pmatrix}, \left[\begin{pmatrix} A' & C' \\ 0 & E' \end{pmatrix} \right] \right) \circ \left(\left(\begin{pmatrix} B \\ D \end{pmatrix}, \left[\begin{pmatrix} A & C \\ 0 & E \end{pmatrix} \right] \right) \otimes \mathbb{1}_k \right)$$

$$\circ (\mathbb{1}_m \otimes f_2((k, \mathbb{1}_k) \otimes (k', \mathbb{1}_{k'})))$$

$$= f_1 \left(\begin{pmatrix} BB' \\ DB' \\ D' \end{pmatrix}, \left[\begin{pmatrix} A+BA'B^T & C+BA'D^T & BC' \\ DA'B^T & E+DA'D^T & DC' \\ 0 & 0 & E' \end{pmatrix} \right] \right)$$

$$\circ (\mathbb{1}_m \otimes f_2(k+k', \mathbb{1}_{k+k'}))$$

$$= f_1 \left(\begin{pmatrix} BB' \\ DB' \\ D' \end{pmatrix}, \left[\begin{pmatrix} A+BA'B^T & C+B(A'+A'^T)D^T & BC' \\ 0 & E+DA'D^T & DC' \\ 0 & 0 & E' \end{pmatrix} \right] \right)$$

$$\circ (\mathbb{1}_m \otimes f_2(k+k', \mathbb{1}_{k+k'}))$$

$$= H(\Gamma' \circ \Gamma)$$

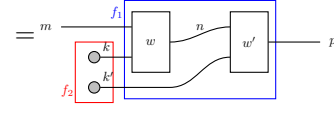
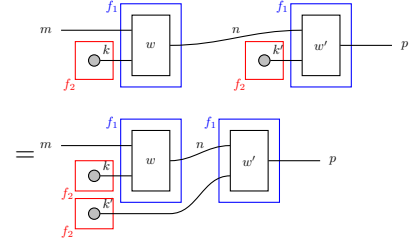

H preserves identities.

$$H(\mathbb{1}_n) = H(0, [0_n], \mathbb{1}_n, !, i, [(\)])$$

$$= f_1(\mathbb{1}_n, [0_n]) \circ (\mathbb{1}_n \otimes f_2(0, \mathbb{1}_0)) = \mathbb{1}_n$$

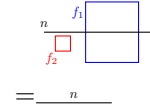

H preserves monoidal product. This is also more clearly seen with the string diagrams.

$$H(\Gamma) \otimes H(\Gamma')$$

$$= (f_1 \left(\begin{pmatrix} B \\ D \end{pmatrix}, \left[\begin{pmatrix} A & C \\ 0 & E \end{pmatrix} \right] \right) \circ (\mathbb{1}_m \otimes f_2(k, \mathbb{1}_k)))$$

$$\otimes (f_1 \left(\begin{pmatrix} B' \\ D' \end{pmatrix}, \left[\begin{pmatrix} A' & C' \\ 0 & E' \end{pmatrix} \right] \right) \circ (\mathbb{1}_n \otimes f_2(k', \mathbb{1}_{k'})))$$

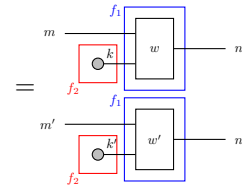

$$\begin{aligned}
 &= (f_1 \left(\left(\begin{smallmatrix} B \\ D \end{smallmatrix} \right), \left[\left(\begin{smallmatrix} A & C \\ 0 & E \end{smallmatrix} \right) \right] \right) \otimes f_1 \left(\left(\begin{smallmatrix} B' \\ D' \end{smallmatrix} \right), \left[\left(\begin{smallmatrix} A' & C' \\ 0 & E' \end{smallmatrix} \right) \right] \right) \\
 &\quad \circ (\mathbb{1}_m \otimes \sigma_{m',k} \otimes \mathbb{1}_{k'}) \circ (\mathbb{1}_{m+m'} \otimes f_2(k, \mathbb{1}_k) \otimes f_2(k', \mathbb{1}_{k'})) \\
 \\
 &= f_1 \left(\left(\left(\begin{smallmatrix} B \\ D \end{smallmatrix} \right), \left[\left(\begin{smallmatrix} A & C \\ 0 & E \end{smallmatrix} \right) \right] \right) \otimes \left(\left(\begin{smallmatrix} B' \\ D' \end{smallmatrix} \right), \left[\left(\begin{smallmatrix} A' & C' \\ 0 & E' \end{smallmatrix} \right) \right] \right) \right) \\
 &\quad \circ \left(\left(\begin{pmatrix} \mathbb{1}_m & 0 & 0 & 0 \\ 0 & 0 & \mathbb{1}_{m'} & 0 \\ 0 & \mathbb{1}_k & 0 & 0 \\ 0 & 0 & 0 & \mathbb{1}_{k'} \end{pmatrix}, [\mathbb{0}_{m+m'+k+k'}] \right) \right) \\
 &\quad \circ (\mathbb{1}_{m+m'} \otimes f_2(k+k', \mathbb{1}_{k+k'})) \\
 \\
 &= f_1 \left(\left(\begin{pmatrix} B & 0 \\ 0 & B' \\ D & 0 \\ 0 & D' \end{pmatrix}, \left[\begin{pmatrix} A & 0 & C & 0 \\ 0 & A' & 0 & C' \\ 0 & 0 & E & 0 \\ 0 & 0 & 0 & E' \end{pmatrix} \right] \right) \right) \\
 &\quad \circ (\mathbb{1}_{m+m'} \otimes f_2(k+k', \mathbb{1}_{k+k'})) \\
 \\
 &= H(\Gamma \otimes \Gamma')
 \end{aligned}$$

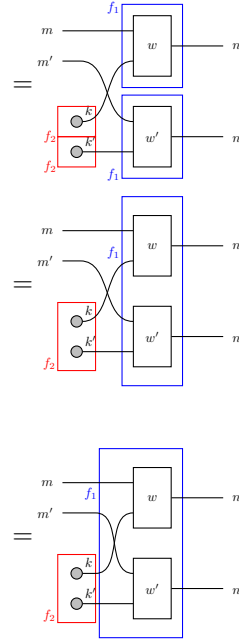

It is easy to show that H preserves monoidal unit.

$$\begin{aligned}
 H(\mathbb{1}) &= H(0, [(\)], (\), (\), (\), [(\)]) \\
 &= f_1((\), [(\)]) \circ (\mathbb{1}_0 \otimes f_2(0, \mathbb{1}_0)) = \mathbb{1}
 \end{aligned}$$

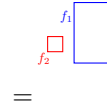

Finally, H preserves symmetries.

$$\begin{aligned}
 H(\sigma_{m,n}) &= H(0, [\mathbb{0}_{m+n}], \left(\begin{smallmatrix} 0 & \mathbb{1}_m \\ \mathbb{1}_n & 0 \end{smallmatrix} \right), !, i, [(\)]) \\
 &= f_1 \left(\left(\begin{smallmatrix} 0 & \mathbb{1}_m \\ \mathbb{1}_n & 0 \end{smallmatrix} \right), [\mathbb{0}_{m+n}] \right) \circ (\mathbb{1}_{m+n} \otimes f_2(0, \mathbb{1}_0)) \\
 \\
 &= f_1(\sigma_{m,n}) = \sigma_{m,n}
 \end{aligned}$$

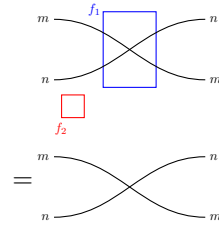

C Proofs for Sections 5

Proof of Theorem 26 . $F_{\mathcal{N}}$ respects the equations of **Grph** because both the tuples $(\rightarrow \bullet \leftarrow, \bullet \leftarrow, \leftarrow \bullet \leftarrow, \leftarrow \bullet \leftarrow)$ and $(\rightarrow \bullet \leftarrow, \rightarrow \bullet \leftarrow, \rightarrow \bullet \leftarrow, \rightarrow \bullet \leftarrow)$ satisfy the commutative bialgebra axioms in figure 2, and they both interact as in figure 3 with the cup $\left. \begin{array}{c} \curvearrowright \\ \curvearrowright \end{array} \right\}$.



We explain in detail that the functor $F_{\mathcal{N}}$ preserves associativity of the black monoid, the rest of the equations are written with the same convention. We write on the left-most and right-most sides morphisms in **Grph** that, by associativity, they must be equal. In the centre, we write the morphisms in **Game** to which they are mapped (indicated with \mapsto) by the functor $F_{\mathcal{N}}$. These morphisms are equal in **Game** by associativity of the monoid operation \oplus on M and coassociativity of copying. Thus, we can say that $F_{\mathcal{N}}$ preserves associativity of the black monoid.

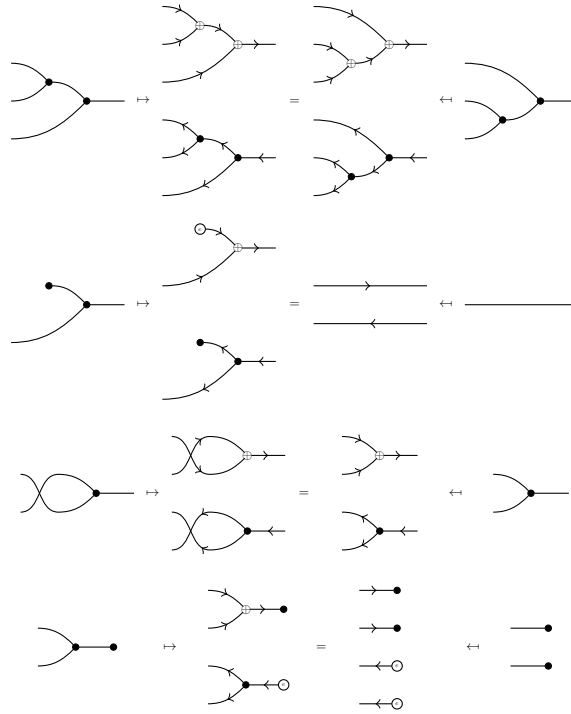

and similarly for their transposed versions.

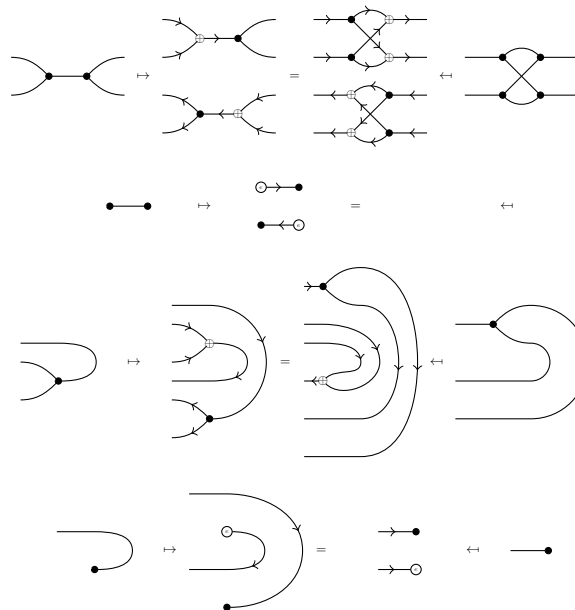



Proof of Corollary 27. $\Gamma = (k, [(), (), i, !, [E]]$. Then, by Theorem 28,

$$\begin{aligned} (\sigma, \sigma') \in \mathbb{B}_{F_{\mathcal{N}}(\Gamma)} &\Leftrightarrow \forall k' \sigma'_{k'} \in \operatorname{argmax}_{s \in X} g(s, (E + E^T)^{k'}_* f(\sigma[k' \mapsto s])) \\ &\Leftrightarrow \forall k' \sigma'_{k'} \in \operatorname{argmax}_{s \in X} g(s, \bigoplus_{\substack{v_j v_{k'} \in E_{\mathcal{G}} \\ j \neq k'}} f(\sigma_j) \oplus \bigoplus_{v_{k'} v_{k'} \in E_{\mathcal{G}}} f(s)) \end{aligned}$$

Thus, fix-points of $\mathbb{B}_{F_{\mathcal{N}}(\Gamma)}$ are Nash equilibria for $F_{\mathcal{N}}(\Gamma)$ and vice versa.

$$\begin{aligned} (\sigma^*, \sigma^*) \in \mathbb{B}_{F_{\mathcal{N}}(\Gamma)} &\Leftrightarrow \forall k' \forall s \in X g(\sigma^*, \bigoplus_{v_j v_{k'} \in E_{\Gamma}} f(\sigma_j^*)) \geq g(s, \bigoplus_{v_j v_{k'} \in E_{\Gamma}} f(\sigma_j) \oplus \bigoplus_{v_{k'} v_{k'} \in E_{\Gamma}} f(s)) \\ &\Leftrightarrow \forall k' \forall s \in X u_{k'}(\Gamma, \sigma^*) \geq u_{k'}(\Gamma, \sigma^* [k' \mapsto s]) \\ &\Leftrightarrow \sigma^* \text{ is a Nash equilibrium for } F_{\mathcal{N}}(\Gamma) \end{aligned}$$

Proof of Theorem 28. The proof proceeds by structural induction on Γ .

It is straightforward to check from the definition of $F_{\mathcal{N}}$ that the generators of **Grph** are sent to open games of the required form.

We need to check that composition is of the form as in the statement. We compute explicitly its play, coplay and best response functions.

$$\begin{aligned} \mathbb{P}_{F_{\mathcal{N}}(\Gamma' \circ \Gamma)}((\underline{\sigma}, \underline{\sigma}'), \underline{x}) &= \mathbb{P}_{F_{\mathcal{N}}(\Gamma') \cdot F_{\mathcal{N}}(\Gamma)}((\underline{\sigma}, \underline{\sigma}'), \underline{x}) \\ &= \mathbb{P}_{F_{\mathcal{N}}(\Gamma')}(\underline{\sigma}', B^T \underline{x} \oplus D^T f(\underline{\sigma})) \\ &= B'^T B^T \underline{x} \oplus B'^T D^T f(\underline{\sigma}) \oplus D'^T f(\underline{\sigma}') \\ &= (BB')^T \underline{x} \oplus \left(\frac{DB'}{D'} \right)^T f\left(\begin{pmatrix} \underline{\sigma} \\ \underline{\sigma}' \end{pmatrix} \right) \end{aligned}$$

$$\begin{aligned} \mathbb{C}_{F_{\mathcal{N}}(\Gamma' \circ \Gamma)}((\underline{\sigma}, \underline{\sigma}'), \underline{x}, \underline{q}) &= \mathbb{C}_{F_{\mathcal{N}}(\Gamma') \cdot F_{\mathcal{N}}(\Gamma)}((\underline{\sigma}, \underline{\sigma}'), \underline{x}, \underline{q}) \\ &= \mathbb{C}_{F_{\mathcal{N}}(\Gamma)}(\underline{\sigma}, \underline{x}, \mathbb{C}_{F_{\mathcal{N}}(\Gamma')}(\underline{\sigma}', \mathbb{P}_{F_{\mathcal{N}}(\Gamma)}(\underline{\sigma}, \underline{x}), \underline{q})) \\ &= (A + A^T) \underline{x} \oplus B((A' + A'^T)(B^T \underline{x} \oplus D^T f(\underline{\sigma})) \oplus B' \underline{q} \oplus C' f(\underline{\sigma}')) \oplus C f(\underline{\sigma}) \\ &= ((A + BA'B^T) + (A + BA'B^T)^T) \underline{x} \oplus BB' \underline{q} \oplus (C + B(A' + A'^T)D^T | BC') f\left(\begin{pmatrix} \underline{\sigma} \\ \underline{\sigma}' \end{pmatrix} \right) \end{aligned}$$

$$\begin{aligned} (\underline{\rho}, \underline{\rho}') \in \mathbb{B}_{F_{\mathcal{N}}(\Gamma' \circ \Gamma)}(\underline{x}, \kappa) &\Leftrightarrow ((\underline{\sigma}, \underline{\tau}), (\underline{\sigma}', \underline{\tau}')) \in \mathbb{B}_{F_{\mathcal{N}}(\Gamma') \circ F_{\mathcal{N}}(\Gamma)}(\underline{x}, \kappa) \\ &\Leftrightarrow (\underline{\sigma}, \underline{\sigma}') \in \mathbb{B}_{F_{\mathcal{N}}(\Gamma)}(\underline{x}, \kappa \circ F_{\mathcal{N}}(\Gamma')_{\underline{\tau}}) \wedge (\underline{\tau}, \underline{\tau}') \in \mathbb{B}_{F_{\mathcal{N}}(\Gamma')} (F_{\mathcal{N}}(\Gamma)_{\underline{\sigma}} \circ \underline{x}, \kappa) \end{aligned}$$

$$\begin{aligned}
& \Leftrightarrow \forall k \sigma'_k \in \operatorname{argmax}_{s \in X} g(s, (C^T)_*^k \underline{x} \oplus D_*^k \mathbb{C}_{F_N(\Gamma')}(\underline{\tau}, B^T \underline{x} \oplus D^T f(\underline{\sigma}[k \mapsto s])), \\
& \quad \kappa(\mathbb{P}_{F_N(\Gamma')}(\underline{\tau}, B^T \underline{x} \oplus D^T f(\underline{\sigma}[k \mapsto s]))) \oplus (E + E^T)_*^k f(\underline{\sigma}[k \mapsto s])) \\
& \quad \wedge \forall k' \tau'_{k'} \in \operatorname{argmax}_{s \in X} g(s, (C'^T)_*^{k'} \mathbb{P}_{F_N(\Gamma')}(\underline{\sigma}, \underline{x}) \oplus (D')_*^{k'} \kappa(B'^T \mathbb{P}_{F_N(\Gamma')}(\underline{\sigma}, \underline{x}) \\
& \quad \oplus D'^T f(\underline{\tau}[k' \mapsto s])) \oplus (E + E'^T)_*^{k'} f(\underline{\tau}[k' \mapsto s])) \\
& \\
& \Leftrightarrow \forall k \sigma'_k \in \operatorname{argmax}_{s \in X} g(s, (C^T + D(A' + A'^T)B^T)_*^k \underline{x} \\
& \quad \oplus (D(A' + A'^T)D^T + E + E^T)_*^k f(\underline{\sigma}[k \mapsto s])) \\
& \quad \oplus (DC')_*^k f(\underline{\tau}) \oplus (DB')_*^k \kappa((BB')^T \underline{x} \oplus (DB')^T f(\underline{\sigma}[k \mapsto s]) \oplus D'^T f(\underline{\tau}))) \\
& \quad \wedge \forall k' \tau'_{k'} \in \operatorname{argmax}_{s \in X} g(s, ((BC')^T)_*^{k'} \underline{x} \oplus (E' + E'^T)_*^{k'} f(\underline{\tau}[k' \mapsto s])) \\
& \quad \oplus ((DC')^T)_*^{k'} f(\underline{\sigma}) \oplus (D')_*^{k'} \kappa((BB')^T \underline{x} \oplus (DB')^T f(\underline{\sigma}) \oplus D'^T f(\underline{\tau}[k' \mapsto s]))) \\
& \\
& \Leftrightarrow \forall a = 1, \dots, k + k' \\
& \quad s \in \operatorname{argmax}_{s \in X} g\left(s, \begin{pmatrix} C^T + D(A' + A'^T)B^T \\ C'^T B^T \end{pmatrix}^a \underline{x} \right) \\
& \quad \oplus \begin{pmatrix} DB' \\ D' \end{pmatrix}_*^a \kappa((BB')^T \underline{x} \oplus (B'^T D^T | D'^T) f(\underline{\rho}[a \mapsto \rho'_a])) \\
& \quad \oplus \begin{pmatrix} E + E^T + D(A' + A'^T)D^T & DC' \\ C'^T D^T & E' + E'^T \end{pmatrix}_*^a f(\underline{\rho}[a \mapsto \rho'_a]))
\end{aligned}$$

Similarly, we show that monoidal product has the desired form.

$$\begin{aligned}
& \mathbb{P}_{F_N(\Gamma \otimes \Gamma')}((\underline{\sigma}, \underline{\sigma}'), (\underline{x}, \underline{x}')) \\
& = \mathbb{P}_{F_N(\Gamma) \otimes F_N(\Gamma')}((\underline{\sigma}, \underline{\sigma}'), (\underline{x}, \underline{x}')) \\
& = (B^T \underline{x} \oplus D^T f(\underline{\sigma}), B'^T \underline{x}' \oplus D'^T f(\underline{\sigma}')) \\
& = \begin{pmatrix} B & 0 \\ 0 & B' \end{pmatrix}^T \begin{pmatrix} \underline{x} \\ \underline{x}' \end{pmatrix} \oplus \begin{pmatrix} D & 0 \\ 0 & D' \end{pmatrix}^T f\left(\begin{pmatrix} \underline{\sigma} \\ \underline{\sigma}' \end{pmatrix}\right) \\
& \\
& \mathbb{C}_{F_N(\Gamma \otimes \Gamma')}((\underline{\sigma}, \underline{\sigma}'), (\underline{x}, \underline{x}'), (\underline{r}, \underline{r}')) \\
& = \mathbb{C}_{F_N(\Gamma) \otimes F_N(\Gamma')}((\underline{\sigma}, \underline{\sigma}'), (\underline{x}, \underline{x}'), (\underline{r}, \underline{r}')) \\
& = ((A + A^T)\underline{x} \oplus B\underline{r} \oplus C f(\underline{\sigma}), (A' + A'^T)\underline{x}' \oplus B'\underline{r}' \oplus C' f(\underline{\sigma}')) \\
& = \left(\begin{pmatrix} A & 0 \\ 0 & A' \end{pmatrix} + \begin{pmatrix} A & 0 \\ 0 & A' \end{pmatrix}^T \right) \begin{pmatrix} \underline{x} \\ \underline{x}' \end{pmatrix} \oplus \begin{pmatrix} B & 0 \\ 0 & B' \end{pmatrix} \begin{pmatrix} \underline{r} \\ \underline{r}' \end{pmatrix} \oplus \begin{pmatrix} B & 0 \\ 0 & B' \end{pmatrix} f\left(\begin{pmatrix} \underline{\sigma} \\ \underline{\sigma}' \end{pmatrix}\right) \\
& \\
& (\underline{\rho}, \underline{\rho}') \in \mathbb{B}_{F_N(\Gamma' \otimes \Gamma)}((\underline{x}, \underline{x}'), (\kappa, \kappa')) \\
& \Leftrightarrow ((\underline{\sigma}, \underline{\tau}), (\underline{\sigma}', \underline{\tau}')) \in \mathbb{B}_{F_N(\Gamma') \otimes F_N(\Gamma)}((\underline{x}, \underline{x}'), (\kappa, \kappa')) \\
& \Leftrightarrow (\underline{\sigma}, \underline{\sigma}') \in \mathbb{B}_{F_N(\Gamma)}(\underline{x}, \kappa(-, \mathbb{P}_{F_N(\Gamma')}(\underline{\tau}, \underline{x}')))) \wedge (\underline{\tau}, \underline{\tau}') \in \mathbb{B}_{F_N(\Gamma')}(\underline{x}', \kappa'(\mathbb{P}_{F_N(\Gamma)}(\underline{\sigma}, \underline{x}), -)) \\
& \Leftrightarrow \forall k \sigma'_k \in \operatorname{argmax}_{s \in X} g(s, (C^T)_*^k \underline{x} \oplus D_*^k \kappa(B^T \underline{x} \oplus D^T f(\underline{\sigma}[k \mapsto s]), B'^T \underline{x}' \oplus D'^T f(\underline{\tau}))) \\
& \quad \oplus (E + E^T)_*^k f(\underline{\sigma}[k \mapsto s])) \\
& \quad \wedge \forall k' \tau'_{k'} \in \operatorname{argmax}_{s \in X} g(s, (C'^T)_*^{k'} \underline{x}' \oplus (D')_*^{k'} \kappa'(B^T \underline{x} \oplus D^T f(\underline{\sigma}), B'^T \underline{x}' \oplus D'^T f(\underline{\tau}[k' \mapsto s]))) \\
& \quad \oplus (E' + E'^T)_*^{k'} f(\underline{\tau}[k' \mapsto s]))
\end{aligned}$$

$$\begin{aligned}
&\Leftrightarrow \forall a = \dots, k + k' \\
&\quad \rho'_a \in \operatorname{argmax}_{s \in X} g\left(s, \left(\begin{pmatrix} C & 0 \\ 0 & C' \end{pmatrix}^T\right)_*^a \begin{pmatrix} \underline{x} \\ \underline{x}' \end{pmatrix}\right) \\
&\quad \oplus \left(\left(\begin{pmatrix} D & 0 \\ 0 & D' \end{pmatrix}^T\right)_*^a \langle \kappa, \kappa' \rangle \left(\begin{pmatrix} B & 0 \\ 0 & B' \end{pmatrix}^T \begin{pmatrix} \underline{x} \\ \underline{x}' \end{pmatrix} \oplus \left(\begin{pmatrix} D & 0 \\ 0 & D' \end{pmatrix}^T f(\underline{\rho}[a \mapsto s])\right)\right) \\
&\quad \quad \oplus \left(\left(\begin{pmatrix} E & 0 \\ 0 & E' \end{pmatrix} + \left(\begin{pmatrix} E & 0 \\ 0 & E' \end{pmatrix}^T\right)_*^a f(\underline{\rho}[a \mapsto s])\right)
\end{aligned}$$

◀

D Proofs for Section 6

► **Proposition 42.** *The fix-points of the best response function $\mathbb{B}_{F_{\mathcal{N}}(\Gamma_m)}(\underline{x}, \kappa)$ of $F_{\mathcal{N}}(\Gamma_m)$ do not depend on \underline{x} and κ . In particular, the equilibria are given by every player in the clique making the same choice.*

Proof. The fix-points of $\mathbb{B}_{F_{\mathcal{N}}(\Gamma_m)}(\underline{x}, \kappa)$ are the Nash equilibria of the game $F_{\mathcal{N}}(\Gamma_m)$ given the context (\underline{x}, κ) . In this setting, the context represents the choices of the players that can be connected to the boundaries of $F_{\mathcal{N}}(\Gamma_m)$. Therefore, we will prove that the Nash equilibria of this game do not depend on the choices of the players that can be connected to the boundaries.

Let M be the number of vertices in the component Γ_m . Let f_i ('friends' of player i) indicate the number of neighbours of player i that take the same choice as player i , including a possible neighbour connected at the boundary. Similarly, let e_i ('enemies' of player i) indicate the number of neighbours of player i that take the different choice from player i .

By hypothesis, there is a player in the clique Γ_m that has no edges connected to the boundaries. Let k be this player. Then, all its neighbours are vertices of Γ_m and are neighbours of any other vertex in Γ_m .

Suppose $e_k = 0$. Then every player takes the same choice and gets utility 1, which is the maximum value. Thus, no player has the incentive to deviate from its choice and this strategy profile is a Nash equilibrium.

Suppose $e_k > 0$ and let k' be one of the 'enemies' of player k . Then, the 'friends' of k' are the 'enemies' of k minus player k' plus one eventual connection of k' to the boundaries

$$f_{k'} \leq e_k - 1 + 1 = e_k$$

Similarly, since all the 'friends' of player k are neighbours of k' as well, the 'enemies' of k' are at least the 'friends' of k plus player k

$$e_{k'} \geq f_k + 1$$

If $f_k < e_k$, this strategy profile is not a Nash equilibrium because player k would increase its own utility from 0 to 1 by changing its choice.

Then, suppose that $f_k \geq e_k$. By the inequalities above,

$$f_{k'} \leq e_k \leq f_k < f_k + 1 \leq e_{k'}$$

Then, this strategy profile is not a Nash equilibrium because player k' 's choice is not the majority one and k' would increase its own utility by changing its choice.

This means that the strategy profile with at least two players taking a different choice cannot be an equilibrium.

Therefore, the only equilibria are that every player chooses Y or every player chooses N and they do not depend on the inputs x and κ of the best response function $\mathbb{B}_{F_{\mathcal{N}}(\Gamma_m)}(x, \kappa)$. ◀

► **Example 43** (details of Example 30). We explain here the details of the definitions of the components of this game.

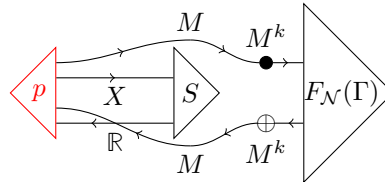

Γ is the open graph obtained by removing the central vertex from the original graph and \mathcal{N} is the best-shot public goods game as in Example 2. Then, the game \mathcal{N} played on the open graph Γ is given by $F_{\mathcal{N}}(\Gamma)$ and is represented by

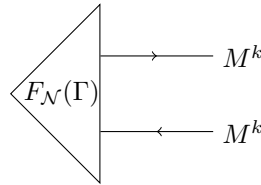

The central player can be obtained by composing together a player like all the other ones with an open game that represents the source of the incentive for this player. First, we modify the player by copying its moves to the outside and allowing a direct external influence on its utility.



Then, we compose it with the source S of the incentive, which is given by the open game

$$S: \left(\begin{matrix} X \\ \mathbb{R} \end{matrix} \right) \xrightarrow{1} \left(\begin{matrix} 1 \\ 1 \end{matrix} \right)$$

$$\mathbb{C}(*, x, *) = \begin{cases} \delta & \text{if } x = 1 \\ -\epsilon & \text{if } x = 0 \end{cases}$$

and we obtain the open game.

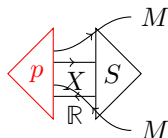

By reconnecting this player with the rest of the network game we obtain the game showed in Example 30. We can analyse it by computing the best responses of its components separately. The following proposition computes the best response of $F_{\mathcal{N}}(\Gamma)$.

► **Proposition 44.** *The best response of $F_{\mathcal{N}}(\Gamma)$ does not depend on its input. In particular, the fix-point of $\mathbb{B}_{F_{\mathcal{N}}(\Gamma)}(*, \kappa)$ is the strategy profile where no player invests, for every value of κ .*

Proof. We start by computing the best response function $\mathbb{B}_i(*, \kappa)$ of a player and showing that it is the same for every value of κ . With this information, we can prove the thesis.

By definition, $(\sigma_i, \sigma'_i) \in \mathbb{B}_i(*, \kappa) \Leftrightarrow \sigma'_i \in \operatorname{argmax}_{s \in X} g(s, \kappa(s))$. Since $\kappa: M \rightarrow M$, where $M = \{Y, N\}$, it can assume four values $\mathbb{1}, !_Y, !_N, \neg$, which denote the identity, the constant on Y , the constant on N and negation respectively. The maximum utilities that can be achieved in these cases are $1 - c + \epsilon, 1, 1 - c + \epsilon, 1$ respectively. All of these values are reached with $s = N$.

Therefore, the only fix-point of $\mathbb{B}_i(*, \kappa)$ can be (N, N) for any value of κ .

The best response of $F_{\mathcal{N}}(\Gamma)$ is of the form $\mathbb{B}_{F_{\mathcal{N}}(\Gamma)}(*, \kappa) = \mathbb{B}_1(*, \sim) \times \dots \times \mathbb{B}_k(*, \sim)$, where \sim indicates a generic argument that we do not need to compute because of what we showed above. Thus, the fix-point of $\mathbb{B}_{F_{\mathcal{N}}(\Gamma)}(*, \kappa)$, for any value of κ , is the strategy profile where no player invests. ◀

Now, we can compute the Nash equilibrium of the whole game.

► **Proposition 45.** *The (unique) Nash equilibrium of the game described at the beginning is that the central player invests and no other player does.*

Proof. We compute the fix-point of the best response of the game by composing $F_{\mathcal{N}}(\Gamma)$ with the central player.

$$\begin{aligned} (\underline{\sigma}, \underline{\sigma}) \in \mathbb{B}_{\mathcal{G}} &\Leftrightarrow (\underline{\sigma}_{-p}, \underline{\sigma}_{-p}) \in \mathbb{B}_{F_{\mathcal{N}}(\Gamma)}(*, \sigma_p) \wedge (\sigma_p, \sigma_p) \in \mathbb{B}_p(*, \bigvee \underline{\sigma}_{-p}) \\ &\Leftrightarrow \forall i \neq p \sigma'_i = N \wedge \sigma_p \in \operatorname{argmax}_{s \in X} \{g(s, N) + \mathbb{C}_S(s)\} \\ &\Leftrightarrow \forall i \neq p \sigma'_i = N \wedge \sigma_p = Y \end{aligned}$$

where we used the result of Proposition 44. Thus, every fix-point of the global best response relation is σ such that $\forall i \neq p \sigma_i = N$ and $\sigma_p = Y$. ◀

► **Proposition 46.** *Suppose there are i and j such that $\sigma_i \neq \sigma_j$. Then $\underline{\sigma}$ cannot be a Nash equilibrium.*

Proof. The graph Γ is connected, then there is a path between the vertices i and j . If $\sigma_i \neq \sigma_j$, then there are neighbouring vertices i' and j' on the path such that $\sigma_{i'} > \sigma_{j'}$.

Then,

$$u_{i'}(\Gamma, \underline{\sigma}) = \min_{l=i' \vee i' l \in E_{\Gamma}} \sigma_l - c_{i'}(\sigma_{i'}) \leq \sigma_{j'} - c_{i'}(\sigma_{i'}) < \sigma_{j'} - c_{i'}(\sigma_{j'})$$

This means that player i' can increase its own utility by choosing the investment level $\sigma_{j'}$. Thus, under the current hypothesis, $\underline{\sigma}$ cannot be a Nash equilibrium. ◀

► **Proposition 47.** *Suppose every player chooses the same level of investment x^* . Then, $\underline{\sigma} = (x^*, \dots, x^*)$ is a Nash equilibrium iff for every player i and for every other $x < x^*$, $x - c_i(x) < x^* - c_i(x^*)$.*

Proof. The strategy profile $\underline{\sigma}$ is a Nash equilibrium if and only if, for every player i ,

$$\begin{aligned} &\Leftrightarrow x^* \in \operatorname{argmax} u_i(\Gamma, (x, \underline{\sigma}_{-i})) \\ &\Leftrightarrow x^* \in \operatorname{argmax} \min\{x, x^*\} - c_i(x) \\ &\Leftrightarrow \forall x < x^* \quad x - c_i(x) < x^* - c_i(x^*) \end{aligned}$$

◀