

STABILITY, FINITENESS AND DIMENSION FOUR

CURTIS PRO AND FREDERICK WILHELM

ABSTRACT. We prove that for any $k \in \mathbb{R}$, $v > 0$, and $D > 0$ there are only finitely many diffeomorphism types of closed Riemannian 4-manifolds with sectional curvature $\geq k$, volume $\geq v$, and diameter $\leq D$.

Let $\mathcal{M}_{k,v,d}^{K,V,D}(n)$ denote the class of closed Riemannian n -manifolds M with

$$\begin{aligned} k &\leq \sec M \leq K, \\ v &\leq \text{vol } M \leq V, \text{ and} \\ d &\leq \text{diam } M \leq D, \end{aligned}$$

where \sec is sectional curvature, vol is volume, and diam is diameter.

Cheeger's finiteness theorem says that $\mathcal{M}_{k,v,0}^{K,\infty,D}(n)$ contains only finitely many diffeomorphism types ([5], [6], [23], [29]). Removing the hypothesis of an upper curvature bound, Grove, Petersen, and Wu showed that for $n \neq 3$, $\mathcal{M}_{k,v,0}^{\infty,\infty,D}(n)$ has only finitely many homeomorphism types ([16]). Perelman then proved his stability theorem ([26],[21]) which, together with Gromov's precompactness theorem, extends the Grove, Petersen, Wu result to give finiteness of homeomorphism types in $\mathcal{M}_{k,v,0}^{\infty,\infty,D}(n)$ in all dimensions. Using [23], the Grove-Petersen-Wu/Perelman finiteness theorem says for $n \neq 4$, $\mathcal{M}_{k,v,0}^{\infty,\infty,D}(n)$ contains only finitely many diffeomorphism types.

In contrast to other dimensions, there are compact topological 4-manifolds that admit infinitely many distinct smooth structures ([12], cf. also [10], [11]). So it is natural that Problem 1.1 in [1] asks whether $\mathcal{M}_{k,v,0}^{\infty,\infty,D}(4)$ also contains only finitely many diffeomorphism types. We resolve this here and thus get the following generalization of Cheeger's finiteness theorem.

Theorem A. *For any $k \in \mathbb{R}$, $v > 0$, $D > 0$, and $n \in \mathbb{N}$ the class $\mathcal{M}_{k,v,0}^{\infty,\infty,D}(n)$ contains only finitely many diffeomorphism types.*

Theorem A is optimal in the sense that the conclusion is false if any one of the hypotheses is removed ([15]). Perelman showed that the conclusion is also false if the lower bound on sectional curvature is weakened to a lower bound on Ricci curvature ([28]). On the other hand, Cheeger and Naber proved that the conclusion of Theorem A holds in dimension 4, if the lower bound on sectional curvature is replaced by a two sided bound on Ricci curvature ([8]). To do this, they prove the limits of manifolds in their class can have only isolated singularities, in the appropriate sense. In contrast, the limit spaces that correspond to Theorem A can have bifurcating singular sets of all dimensions $\leq n - 2$ (see e.g. Figure 8).

1991 *Mathematics Subject Classification.* 53C20.

Key words and phrases. Diffeomorphism Stability, Alexandrov Geometry.

This work was supported by a grant from the Simons Foundation (#358068, Frederick Wilhelm).

A crucial distinction between $\mathcal{M}_{k,v,0}^{K,\infty,D}(n)$ and $\mathcal{M}_{k,v,0}^{\infty,\infty,D}(n)$ is that there is a uniform lower bound for the injectivity radii of all $M \in \mathcal{M}_{k,v,0}^{K,\infty,D}(n)$, whereas the spaces of $\mathcal{M}_{k,v,0}^{\infty,\infty,D}(n)$ do not even have a uniform lower bound for their contractibility radii ([5], [6], [15]). This leads to a further contrast: if X is in the Gromov–Hausdorff closure of $\mathcal{M}_{k,v,0}^{K,\infty,D}(n)$ then all points of X have neighborhoods that are almost isometric to small euclidean balls. Simple examples show that this is false for $\mathcal{M}_{k,v,0}^{\infty,\infty,D}(n)$.

In the 1980’s, Gromov’s Compactness Theorem provided a new perspective on Cheeger’s Finiteness Theorem. In particular, we learned that if $M_i \in \mathcal{M}_{k,v,0}^{K,\infty,D}(n)$ converge to X , then all but finitely many of the M_i must be diffeomorphic to X . (See, for example, [7]). As Gromov also showed that $\mathcal{M}_{k,0,0}^{\infty,\infty,D}(n)$ is precompact, Cheeger’s finiteness theorem becomes a corollary. Combined with Perelman’s Stability Theorem, this leads naturally to the

Diffeomorphism Stability Question. (*Problem 32 in [30]*) *Given $k \in \mathbb{R}$, $v, D > 0$, and $n \in \mathbb{N}$, let $\{M_\alpha\}_{\alpha=1}^\infty \subset \mathcal{M}_{k,v,0}^{\infty,\infty,D}(n)$ be a Gromov–Hausdorff convergent sequence. Are all but finitely many of the M_α s diffeomorphic to each other?*

An affirmative answer to this question would have far reaching consequences. For example, Grove and the second author showed

Theorem. ([18]) *If the answer to the Diffemorphism Stability Question is “yes”, then every Riemannian n -manifold M with $\sec M \geq 1$ and $\text{diam } M > \frac{\pi}{2}$ is diffeomorphic to \mathbb{S}^n .*

Theorem A follows by combining Gromov’s Precompactness Theorem with the following result.

Theorem B. *Diffeomorphism Stability holds in dimension 4.*

The remainder of the paper is a proof of Theorem B. To start, we fix a sequence

$$\{M_\alpha\}_{\alpha=1}^\infty \subset \mathcal{M}_{k,v,0}^{\infty,\infty,D}(4) \text{ that converges to } X.$$

Our goal is to prove that all but finitely many of the M_α are diffeomorphic to each other. By work of Kuwae, Machigashira, and Shioya, the desired diffeomorphism is known to exist away from the singularities of X (see [22] and Theorem C, below). We call this the KMS diffeomorphism. Our strategy is to extend a version of the KMS diffeomorphism to progressively more singular regions. To do this we show in Limit Lemma G (below) that any M_α sufficiently close to X admits a very special type of handle decomposition that is related to the singular structure of X . The handles of Limit Lemma G will allow us to use theorems of Cerf and Smale to carry out the required extension. We start with a review of the Cerf and Smale theorems. Cerf showed that any diffeomorphism of \mathbb{S}^3 extends to \mathbb{D}^4 (see [4] cf also [2] and [19]). The following is a consequence

Cerf’s Extension Theorem. *Let M and \tilde{M} be two smooth 4-manifolds with smoothly embedded closed 4-disks, $D^4 \subset M$ and $\tilde{D}^4 \subset \tilde{M}$. Let $\Phi : \overline{M \setminus D^4} \rightarrow \overline{\tilde{M} \setminus \tilde{D}^4}$ be a diffeomorphism so that $\Phi(\partial D^4) = \partial \tilde{D}^4$. Then Φ extends to a diffeomorphism $M \rightarrow \tilde{M}$.*

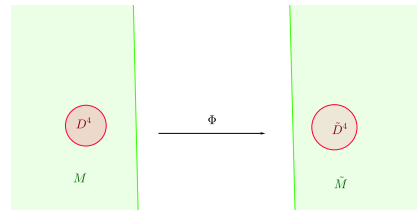

Figure 1. Cerf’s Extension Theorem

We also use an extension theorem that is essentially due to Smale. It follows from the fact that, for $n = 1$ or 2 , the diffeomorphism group of the n -sphere deformation retracts to the orthogonal group ([37]). To state Smale's Theorem, we recall that a smooth n -manifold M is obtained from a smooth n -manifold Ω by **attaching an $(n - j)$ -handle, H** , provided:

1. $M = \Omega \cup H$.
2. Ω and H are open in M .
3. H is the total space of a trivial vector bundle $p_H : H \rightarrow \mathbb{B}^j$ with fiber \mathbb{R}^{n-j} . Here \mathbb{B}^j is an open ball in \mathbb{R}^j .
4. The restriction of p_H to $H \setminus \Omega$ is a trivial bundle over \mathbb{B}^j whose fibers are diffeomorphic to the closed ball in \mathbb{R}^{n-j} . In particular, the restriction of p_H to $\partial(H \setminus \Omega)$ is a trivial sphere bundle over \mathbb{B}^j .

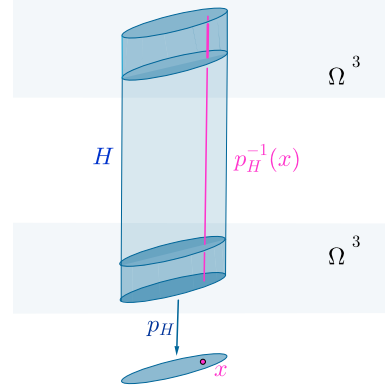

Figure 2. This is a 1-handle H attached to a 3-manifold Ω^3 . The projection p_H is topologically from \mathbb{R}^3 to \mathbb{R}^2 . The dark blue depicts the intersection of Ω^3 and H .

Smale's Extension Theorem. *Let $M, \tilde{M}, \Omega,$ and $\tilde{\Omega}$ be smooth 4-manifolds. For $k \in \{1, 2\}$, suppose that M is obtained from Ω by attaching a $(4 - k)$ -handle, (H, p_H) , and that \tilde{M} is obtained from $\tilde{\Omega}$ by attaching an $(4 - k)$ -handle, $(\tilde{H}, p_{\tilde{H}})$.*

Let

$$\Phi : \text{closure}(\Omega) \rightarrow \text{closure}(\tilde{\Omega})$$

be a diffeomorphism so that

$$p_{\tilde{H}} \circ \Phi|_{H \cap \Omega} = p_H|_{H \cap \Omega}. \tag{0.0.1}$$

Then Φ extends to a diffeomorphism $M \rightarrow \tilde{M}$ so that $p_{\tilde{H}} \circ \Phi = p_H$.

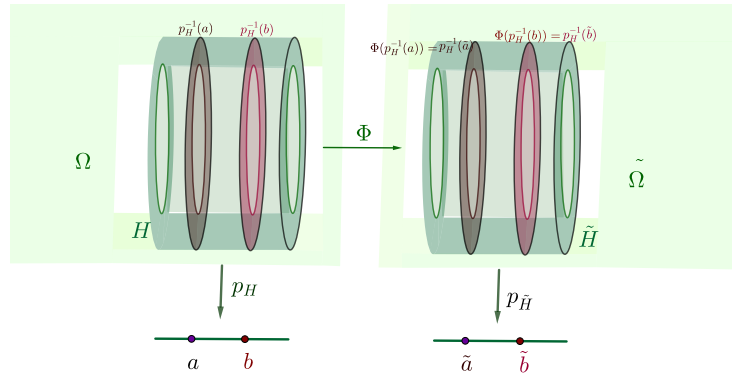

Figure 3. Pictured are 2-handles H, \tilde{H} attached to 3-manifolds $\Omega, \tilde{\Omega}$. The dark green depicts the intersections. Originally the diffeomorphism Φ takes Ω to $\tilde{\Omega}$; however, because it also takes fibers of p_H to fibers of $p_{\tilde{H}}$, and because $\text{Diff}(S^1)$ deformation retracts to $O(2)$, Φ extends to a diffeomorphism from $\Omega \cup H \rightarrow \tilde{\Omega} \cup \tilde{H}$. Since $\text{Diff}(S^2)$ deformation retracts to $O(3)$, the same statement applies if H and \tilde{H} are 3-handles attached to 4-manifolds.

Together with Invariance of Domain, the hypotheses of Smale's Extension Theorem imply that Φ takes $\partial\Omega$ to $\partial\tilde{\Omega}$. Each of these is a trivial sphere bundle that bounds the trivial disk

bundles $H \setminus \Omega$ and $\tilde{H} \setminus \tilde{\Omega}$, respectively. This, together with (0.0.1) and Smale's deformation retraction of $\text{Diff}(S^{4-k-1})$ to $O(4-k)$, gives the method to extend Φ to a diffeomorphism from M to \tilde{M} .

The strategy to prove Theorem B, which we outline in the next section, is to show any two manifolds M_α and M_β that are sufficiently close to X admit a special type of handle decomposition that is related to the singular structure of X . This handle decomposition, together with Cerf and Smale's Extension Theorems then allows us to extend a version of the KMS diffeomorphism to a diffeomorphism from M_α to M_β .

OUTLINE OF THE PROOF

Central to the proof of Theorem B is the approximation of geometric structures in X with corresponding structures in all but finitely many of the M_α . We call these approximations in the M_α *stable* structures. Our objective is to show that the singular structure of X leads to a stable handle decomposition in the M_α . We formulate this precisely in Limit Lemma G, below. First we establish necessary terminology.

We will use the 0, 1, and 2-strained subsets of X to construct 4, 3, and 2-handles in the M_α . So, for the remainder of the paper we assume that the reader has a working knowledge of the concept of an (l, δ) -strained point in an Alexandrov space. These were originally defined in [3], where they were called burst points (see also, e.g., [35]).

The starting point in the proof of Theorem B is to construct a diffeomorphism between open, almost-dense subsets of any two of the M_α that are sufficiently close to the following subset of X .

Definition. *Given $\delta > 0$, we let X_δ^4 be the points of X that are $(4, \delta)$ -strained.*

Definition. *Let $U \subset X$ be an open subset and $p : U \rightarrow \mathbb{R}^k$ a map. Given a sequence of sets $\{U_\alpha\}_{\alpha=1}^\infty$ and maps $\{p_\alpha : U_\alpha \rightarrow \mathbb{R}^k\}_{\alpha=1}^\infty$ where $U_\alpha \subset M_\alpha$ is open, we call $\{(U_\alpha, p_\alpha)\}_{\alpha=1}^\infty$ an **approximation** of (U, p) provided $U_\alpha \rightarrow U$ and $p_\alpha \rightarrow p$ in the Gromov-Hausdorff topology.*

Kuwae, Machigashira, and Shioya have already constructed diffeomorphisms between approximations of the top stratum. More precisely

Theorem C (Kuwae-Machigashira-Shioya [22]). *There is a $\delta > 0$ so that every open $\Omega \subset X_\delta^4$ with $\text{closure}(\Omega) \subset X_\delta^4$ has approximations $\Omega_\alpha \subset M_\alpha$ so that for all but finitely many α and β there is a diffeomorphism*

$$\Phi_{\beta, \alpha} : \Omega_\alpha \rightarrow \Omega_\beta.$$

To prove Theorem B we show that there is a choice of $\Omega \subset X_\delta^4$ so that all but finitely many of the M_α are obtained from the corresponding Ω_α by first attaching a finite number of 2-handles, then a finite number of 3-handles, and lastly a finite number of 4-handles. We also show, using Cerf and Smale's Extension Theorems, that at each stage of attachment, $\Phi_{\beta, \alpha}$ can be extended over the attached handle. The end result is a diffeomorphism between M_α and M_β . To accomplish this, we will need to establish several compatibility conditions between $\Phi_{\beta, \alpha}$ and the handle decompositions of M_α and M_β . Next we give several definitions related to these compatibility conditions which will allow us to state Limit Lemma G.

Definition. A subset $H \subset X$ together with a map $p_H : H \rightarrow \mathbb{R}^k$ is called (k, \varkappa) -**framed** provided there are approximations $H_\alpha \subset M_\alpha$ of H and $p_\alpha : H_\alpha \rightarrow \mathbb{R}^k$ of p_H with the following properties:

1. For all but finitely many α , the maps $p_\alpha : H_\alpha \rightarrow \mathbb{R}^k$ are C^1 , \varkappa -almost Riemannian submersions for some $\varkappa > 0$ whose images are diffeomorphic to an open ball in \mathbb{R}^k .
2. For all but finitely many α , the pair (H_α, p_α) is a trivial vector bundle.

Definition. Let $H \subset X$ be k -framed. A function $r_H : H \rightarrow \mathbb{R}$ is called a **fiber exhaustion function** for H if and only if for all but finitely many α there are approximations H_α, p_α and r_α of H, p_H , and r_H so that the restriction of r_α to each fiber of p_α has exactly one critical point which is nondegenerate and maximal.

The fiber exhaustion function r_{H_α} plays the role of the *negative* of the radial function for each fiber of $(H_\alpha^k, r_{H_\alpha})$, and hence has a maximum rather than a minimum. This is an artifact of our construction, which gives r_H as a concave down function.

Officially, a framed set is a triple, (H, p, r) , but to simplify the exposition we will take the liberty of writing it either as a pair, (H, p) , or a singleton, H , depending on the context. When (H, p_H) is (k, \varkappa) -framed and neither p_H or \varkappa are needed for discussion, we will just say H is k -framed. We use the superscript k , as in H^k , to indicate that H^k is k -framed. We adopt the convention that any expression involving the symbol dp_H implicitly asserts that the expression holds with the symbol dp_H replaced by the differential dp_α for all but finitely many α .

Definition. Given $\delta, \varkappa > 0$, a cover $\mathcal{H} = \mathcal{H}^0 \cup \mathcal{H}^1 \cup \mathcal{H}^2$ of $X \setminus X_\delta^4$ is called \varkappa -**framed** if the \mathcal{H}^k consist of a finite number of (k, \varkappa) -framed sets (H, p_H, r_H) . In the event that \mathcal{H} does not cover $X \setminus X_\delta^4$, we will call it a \varkappa -**framed collection**.

Although the notion of a framed cover depends on the parameters \varkappa and δ , in the interest of simplicity, we will usually not mention this explicitly, and we adopt the convention that all statements about framed covers are only valid for sufficiently large α and sufficiently small \varkappa and δ .

The proof of Theorem B is broken down into the following steps. First, we construct a framed cover \mathcal{H} of $X \setminus X_\delta^4$, opens sets

$$\Omega_\alpha \subset M_\alpha, \Omega_\beta \subset M_\beta,$$

as in Theorem C, and a diffeomorphism $\Phi_{\beta, \alpha} : \Omega_\alpha \rightarrow \Omega_\beta$ so that for $\gamma = \alpha$ or β ,

- $M_\gamma = \Omega_\gamma \cup \mathcal{H}_\gamma$.
- All of the 2-framed sets $H^2 \in \mathcal{H}^2$ have approximations $H_\gamma^2 \in \mathcal{H}_\gamma^2$ that are disjoint 2-handles attached to Ω_α , and
- $\Phi_{\beta, \alpha}$ satisfies the hypotheses of Smale's Extension Theorem and hence extends over each of these disjoint 2-handles.

This produces a diffeomorphism $\Phi_{\beta, \alpha}^2 : \Omega_\alpha^2 \rightarrow \Omega_\beta^2$ where $\Omega_\gamma^2 = \Omega_\gamma \cup (\cup \mathcal{H}_\gamma^2)$ for $\gamma = \alpha$ or β . For the next step, we require that

- all of the 1-framed sets $H^1 \in \mathcal{H}^1$ have approximations $H_\alpha^1 \in \mathcal{H}_\alpha^1$ that are disjoint 3-handles attached to Ω_α^2 , and

- $\Phi_{\beta,\alpha}^2$ satisfies the hypotheses of Smale's Extension Theorem and hence extends over each of these disjoint 3-handles.

This produces a diffeomorphism $\Phi_{\beta,\alpha}^3 : \Omega_\alpha^3 \rightarrow \Omega_\beta^3$ where $\Omega_\gamma^3 = \Omega_\gamma^2 \cup (\cup \mathcal{H}_\gamma^1)$ for $\gamma = \alpha$ or β . The last step requires that

- all 0-framed sets $H^0 \in \mathcal{H}^0$ have approximations $H_\alpha^0 \in \mathcal{H}_\alpha^0$ that are disjoint 4-handles attached to Ω_α^3 , and
- $\Phi_{\beta,\alpha}^3$ satisfies the hypotheses of Cerf's Extension Theorem and hence extends over each of these disjoint 4-handles.

The final product is the desired diffeomorphism $\Phi : M_\alpha \rightarrow M_\beta$. This only works because our framed cover \mathcal{H} satisfies certain other constraints. For example, the Smooth Schoenflies Problem is open in dimension 4, so to perform the final extension, we will identify $M_\beta \setminus \Phi_{\beta,\alpha}^3(\Omega_\alpha^3)$ with a disjoint union of 4-disks. This is the main role of the fiber exhaustion functions r_H and the conditions that we impose on them in Definitions E and F below.

The next definition provides the condition on the framed sets that allows us to identify them as handles attached in the manner that our extension process requires.

Definition D. Let $\mathcal{H} = \mathcal{H}^0 \cup \mathcal{H}^1 \cup \mathcal{H}^2$ be a framed cover and let $\Omega \subset X_\delta^4$ be an open set. We say that \mathcal{H} is Ω -**proper** provided

1. For each $(H_2, p_2) \in \mathcal{H}^2$ and each $x \in H_2$,

$$\partial(\text{closure}(p_2^{-1}(p_2(x)))) \subset \Omega. \quad (0.0.2)$$

2. For each $(H_1, p_1) \in \mathcal{H}^1$ and each $x \in H_1$,

$$\partial(\text{closure}(p_1^{-1}(p_1(x)))) \subset \Omega \cup \mathcal{H}^2. \quad (0.0.3)$$

3. For each $(H_0, p_0) \in \mathcal{H}^0$ and each $x \in H_0$,

$$\partial(\text{closure}(p_0^{-1}(p_0(x)))) \subset \Omega \cup \mathcal{H}^2 \cup \mathcal{H}^1.$$

To ensure that our various diffeomorphisms can be extended over handles, we require two further conditions. The first imposes a constraint on how the KMS-diffeomorphism $\Phi_{\beta,\alpha} : \Omega_\alpha \rightarrow \Omega_\beta$ interacts with our framed cover.

Definition E. Let $\mathcal{H} = \mathcal{H}^0 \cup \mathcal{H}^1 \cup \mathcal{H}^2$ be a framed cover, and let $\Omega \subset X_\delta^4$ be an open set with $\text{closure}(\Omega) \subset X_\delta^4$. We say that \mathcal{H} **respects** Ω if and only if

$$X = \cup \mathcal{H} \cup \Omega,$$

and the following hold:

1. There are approximations Ω_α of Ω and, for all but finitely many α, β , diffeomorphisms

$$\Phi_{\beta,\alpha} : \Omega_\alpha \longrightarrow \Omega_\beta.$$

2. For each $k \in \{0, 1, 2\}$ and k -framed set $(H^k, p, r) \in \mathcal{H}^k$, there are approximations $(H_\alpha^k, p_\alpha, r_\alpha)$ and $(H_\beta^k, p_\beta, r_\beta)$ so that

$$\begin{aligned} \Phi_{\beta,\alpha}(\Omega_\alpha \cap H_\alpha) &= \Omega_\beta \cap H_\beta, \\ p_\alpha \circ \Phi_{\alpha,\beta} &= p_\beta, \text{ and } r_\alpha \circ \Phi_{\alpha,\beta} = r_\beta. \end{aligned}$$

Our collection of 2–framed sets \mathcal{H}^2 is disjoint, so if the previous definition is satisfied, we can use Smale’s Theorem to extend the diffeomorphism $\Phi_{\beta,\alpha}$ to the elements of \mathcal{H}^2 . To allow the extension process to continue to the 1– and 0–framed sets, the intersections of our framed sets will satisfy the following additional constraint.

Definition F. (Figure 4) For $k < l$, let (H^k, p_{H^k}, r_{H^k}) be k –framed and let (H^l, p_{H^l}, r_{H^l}) be l –framed. We say that H^k and H^l **intersect respectfully** if and only if there is a neighborhood N of $\partial(\text{closure}(p_{H^l}(H^l)))$ so that for all $x \in p_{H^l}^{-1}(N) \cap H^k$,

$$p_{H^l}^{-1}(p_{H^l}(x)) \subset p_{H^k}^{-1}(p_{H^k}(x)) \text{ and} \quad (0.0.4)$$

$$p_{H^l}^{-1}(p_{H^l}(x)) \subset r_{H^k}^{-1}(r_{H^k}(x)). \quad (0.0.5)$$

A framed collection is **respectful** provided all intersections of sets with different framing dimensions are respectful.

In Section 1, we combine the preceding ideas and show that Theorem B follows from

Limit Lemma G. If δ is sufficiently small, then there is a respectful framed cover $\mathcal{H} = \mathcal{H}^0 \cup \mathcal{H}^1 \cup \mathcal{H}^2$, of $X \setminus X_\delta^4$ with the following properties:

1. For $k = 0, 1$, or 2 , the closures of the elements of \mathcal{H}^k are pairwise disjoint.
2. There is an open $\Omega \subset X_\delta^4$ so that \mathcal{H} respects Ω and is Ω –proper.

Section 2 establishes notations and conventions. The remainder and vast majority of the paper is divided into three parts and an appendix, which together are a proof of Limit Lemma G. The parts are divided into subordinate sections. The parts are numbered 0, 1, and 2 because the main goal of the respective parts is to make the collections of 0–, 1–, and 2–framed sets disjoint. The appendix completes the proof of Limit Lemma G by showing that X_δ^4 respects \mathcal{H} .

To prove Limit Lemma G we establish four other, successively better covering lemmas. The first is essentially due to Perelman and is proven in Section 3 (cf [18], [20], and [35]).

Perelman Covering Lemma. Given $\varkappa, \delta > 0$, there is a \varkappa –framed cover $\mathcal{P} = \mathcal{P}^0 \cup \mathcal{P}^1 \cup \mathcal{P}^2$ of $X \setminus X_\delta^4$.

Each of Parts 0, 1 and 2 begins with a detailed summary. We refer the reader to these summaries for an outline of the rest of the paper.

Remark. The idea of using the Cerf and Smale extension theorems to extend diffeomorphisms is also used in e.g. [17], [18], [34], and [35].

Acknowledgment. Theorem A answers Problem 1.1 of the American Institute of Mathematics Problem list for manifolds of nonnegative curvature, which was discussed at the AIM

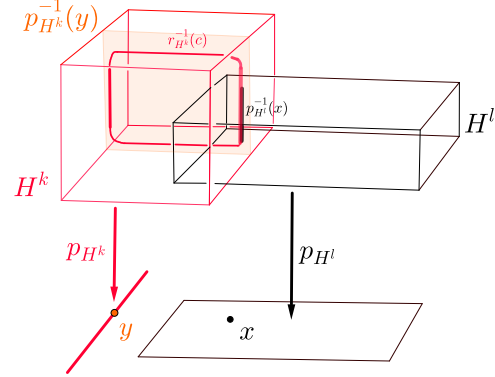

Figure 4. The framed sets H^k and H^l intersect respectfully, because the fibers of p_{H^l} that intersect H^k are contained in both the fibers of p_{H^k} and level sets of the fiber exhaustion function r_{H^k} of H^k .

workshop with the same name in September, 2007. The second author is grateful to AIM for supporting his attendance at this workshop and to the participants for the many insights that they shared. We thank Vitali Kapovitch for showing us the example in Figure 8, for discussions related to Corollary 3.14, and, in general, for several extensive conversations about this problem over the years. We are grateful to Michael Sill for multiple preliminary discussions about this work, to Stefano Vidussi for conversations about the topological issues, and to Karsten Grove and Catherine Searle for listening to extended outlines of the proof and providing valuable feedback and advice.

1. WHY THEOREM B FOLLOWS FROM LIMIT LEMMA G

In this section, we prove Theorem B assuming Limit Lemma G. The key ingredients are the Cerf and Smale Extension Theorems stated above.

Proof of Theorem B assuming Limit Lemma G. Let Ω be an open subset of X_δ^4 that satisfies Part 2 of Limit Lemma G. Then there are open sets $\Omega_\beta \subset M_\beta$ and $\Omega_\alpha \subset M_\alpha$ and a diffeomorphism $\Phi_{\beta,\alpha}^4 : \Omega_\alpha \rightarrow \Omega_\beta$ as in Definition E. In particular, for $k \in \{0, 1, 2\}$ and all $(H, p, r) \in \mathcal{H}^k$, there are approximations $(H_\alpha, p_\alpha, r_\alpha) \in \mathcal{H}_\alpha^k$ and $(H_\beta, p_\beta, r_\beta) \in \mathcal{H}_\beta^k$ so that

$$\Phi_{\beta,\alpha}^4(\Omega_\alpha \cap H_\alpha) = \Omega_\beta \cap H_\beta, \quad (1.0.1)$$

$$p_\beta \circ \Phi_{\beta,\alpha} = p_\alpha, \text{ and } r_\beta \circ \Phi_{\beta,\alpha} = r_\alpha. \quad (1.0.2)$$

For $\gamma = \alpha$ or β , set $\Omega_\gamma^2 := \Omega_\gamma \cup (\cup \mathcal{H}_\gamma^2)$ and $\Omega_\gamma^1 := \Omega_\gamma^2 \cup (\cup \mathcal{H}_\gamma^1)$. It follows that for all sufficiently large γ ,

$$M_\gamma = \Omega_\gamma^1 \cup (\cup \mathcal{H}_\gamma^0).$$

Since the 2-framed sets of \mathcal{H}_γ^2 are disjoint, Equations (1.0.1) and (1.0.2), together with the Smale Extension Theorem and the fact that \mathcal{H} is Ω -proper, allow us to successively extend $\Phi_{\beta,\alpha} : \Omega_\alpha \rightarrow \Omega_\beta$ to each 2-framed set to get a diffeomorphism

$$\Phi_{\beta,\alpha}^2 : \Omega_\alpha^2 \rightarrow \Omega_\beta^2$$

so that for all $(H^2, p) \in \mathcal{H}^2$,

$$\Phi_{\beta,\alpha}^2(H_\alpha^2) = H_\beta^2, \quad (1.0.3)$$

and

$$p_\beta \circ \Phi_{\beta,\alpha}^2|_{H_\alpha^2} = p_\alpha|_{H_\alpha^2}. \quad (1.0.4)$$

Since \mathcal{H} is respectful (see (0.0.4),(0.0.5)), Equations (1.0.1), (1.0.2), (1.0.3), and (1.0.4) give us that for every $(H, p, r) \in \mathcal{H}^0 \cup \mathcal{H}^1$,

$$\Phi_{\beta,\alpha}^2(\Omega_\alpha^2 \cap H_\alpha) = \Omega_\beta^2 \cap H_\beta, \quad (1.0.5)$$

$$p_\beta \circ \Phi_{\beta,\alpha}^2|_{H_\alpha \cap \Omega_\alpha^2} = p_\alpha|_{H_\alpha \cap \Omega_\alpha^2}, \text{ and } r_\beta \circ \Phi_{\beta,\alpha}^2|_{H_\alpha^2} = r_\alpha|_{H_\alpha}. \quad (1.0.6)$$

Equations (1.0.5) and (1.0.6), Smale's Extension Theorem, and the fact that \mathcal{H} is Ω -proper allow us to successively extend $\Phi_{\beta,\alpha}^2 : \Omega_\alpha^2 \rightarrow \Omega_\beta^2$ to each 1-framed set to get a diffeomorphism

$$\Phi_{\beta,\alpha}^1 : \Omega_\alpha^1 \rightarrow \Omega_\beta^1$$

so that for all $(H, p, r) \in \mathcal{H}^1$,

$$\Phi_{\beta,\alpha}^1(H_\alpha) = H_\beta, \text{ and} \quad (1.0.7)$$

$$p_\beta \circ \Phi_{\beta,\alpha}^1|_{H_\alpha \cap \Omega_\alpha^3} = p_\alpha|_{H_\alpha \cap \Omega_\alpha^3}. \quad (1.0.8)$$

Equations (1.0.1) through (1.0.8), together with our assumption that \mathcal{H} is respectful, give us that for all $(H^0, r) \in \mathcal{H}^0$,

$$r_\beta \circ \Phi_{\beta,\alpha}^1|_{H_\alpha^0} = r_\alpha|_{H_\alpha^0}. \quad (1.0.9)$$

The final step is to apply the Cerf Extension Theorem to get the desired diffeomorphism, $\Phi : M_\alpha \longrightarrow M_\beta$. \square

2. NOTATIONS AND CONVENTIONS

For the remainder of the paper, we fix a sequence $\{M_\alpha\}_{\alpha=1}^\infty \subset \mathcal{M}_{k,v,0}^{\infty,\infty,D}(4)$ that Gromov-Hausdorff converges to X , that is,

$$\lim_{\alpha \rightarrow \infty} M_\alpha = X.$$

Our goal is to prove that all but finitely many of the M_α s are diffeomorphic to each other. We have seen that to do this, it suffices to prove Limit Lemma G. We assume throughout that all metric spaces are complete, and the reader has a basic familiarity with Alexandrov spaces, including, but not limited to [3]. We adopt all of the Notations and Conventions from [35], and in addition,

1. We write \mathbb{S}^n for the unit sphere in \mathbb{R}^{n+1} , \mathbb{B}^n for an open unit n -ball, and $\mathbb{B}^n(r)$ for an open r -ball in \mathbb{R}^n .
2. For a metric space Y , we let λY be the metric space obtained from Y by multiplying all distances by λ .
3. Given a constant $C \in \mathbb{R}$, we use the symbols C^- and C^+ to denote constants that are slightly smaller or slightly larger than C . We adopt the convention that any statement involving C^- or C^+ implicitly asserts that there is a choice of $C^- \in (\frac{C}{2}, C)$ or a choice of C^+ in $(C, 2C)$ for which the statement is true.
4. Specific constants appear throughout the paper. While we have strived to make the dependencies among these constants clear, they are not chosen to be optimal, with the exception of $\frac{\pi}{6}$ in Theorem 11.5. Rather we have endeavored to choose them in a way that maximizes the readability of the paper. Even with optimal constants, our methods do not lead to a practical estimate for the number of diffeomorphism classes for most cases of Theorem A.
5. If $\Omega(r)$ is a parameterized family of sets with $\Omega = \Omega(r_0)$, we write Ω^+ or Ω^- for $\Omega(r_0^+)$ or $\Omega(r_0^-)$ respectively. We adopt the convention that any statement involving Ω^+ or Ω^- implicitly asserts that there is a choice of Ω^+ or a choice of Ω^- for which the statement is true.
6. For $\lambda \geq 1$, we say that an embedding ι is λ -bilipshitz if both ι and ι^{-1} are λ -Lipshitz.
7. Let \mathcal{C} and \mathcal{D} be collections of subsets of X . We say that the Hausdorff distance between \mathcal{C} and \mathcal{D} is $< \varepsilon$ if and only if there is a bijection $\Phi : \mathcal{C} \longrightarrow \mathcal{D}$ so that $\text{dist}_{\text{Haus}}(C, \Phi(C)) < \varepsilon$ for all $C \in \mathcal{C}$.
8. For a simplicial complex \mathcal{T} , we adopt the convention that \mathcal{T}_i is the collection of i -simplices of \mathcal{T} and that $|\mathcal{T}|$ is the underlying polyhedron.
9. For $A \subset X$, we write \bar{A} for the closure of A in X .

Definition 2.1. A subset $U \subset X$ together with a map $p_U : U \rightarrow \mathbb{R}^k$ is called a *stable \varkappa -almost Riemannian submersion* provided:

1. There are approximations $U_\alpha \subset M_\alpha$ of U and $p_\alpha : U_\alpha \rightarrow \mathbb{R}^k$ of p_U .
2. For all but finitely many α and some $\varkappa > 0$, the maps $p_\alpha : U_\alpha \rightarrow \mathbb{R}^k$ are C^1 , \varkappa -almost Riemannian submersions whose images are diffeomorphic to an open ball in \mathbb{R}^k .

Remark. When there is no possibility of confusion, we will omit the word *stable* and call such a map a *Riemannian submersion*.

Definition 2.2. Given $\varkappa > 0$ and two maps $\pi, p : U \rightarrow \mathbb{R}^k$, we say that

$$|\pi - p|_{C^1_{\text{stab}}} < \varkappa$$

if and only if for all but finitely many α , there are approximations $\{\pi_\alpha\}$ and $\{p_\alpha\}$ of π and p so that

$$|\pi_\alpha - p_\alpha|_{C^1} < \varkappa.$$

Similarly, we say that

$$|d\pi - dp|_{\text{stab}} < \varkappa$$

if and only if for all but finitely many α , there are approximations $\{\pi_\alpha\}$ and $\{p_\alpha\}$ of π and p so that

$$|d\pi_\alpha - dp_\alpha| < \varkappa.$$

Part 0. The Perelman-Plaut Covering Lemma

In the first section of this part, we prove the Perelman Covering Lemma (Section 3 of the paper). In the rest of the paper, we re-do the Perelman cover multiple times, obtaining at each stage covers that are progressively closer to satisfying the conclusions of Limit Lemma G. The end result is a respectful framed cover so that for $k = 0, 1$, or 2 , the collection of k -framed sets is disjoint.

Before attempting to make the 1- and 2- framed sets disjoint, we constrain the way that they intersect in Section 4. The argument uses a sphere theorem of Plaut's from [33], so we call the resulting cover the Perelman-Plaut Framed Cover (see Lemma 4.1 and Figures 9, 12, 10, and 11).

The focus of Parts 1 and 2 of the paper is to replace the collections of 1- and 2- framed sets of the Perelman-Plaut Framed Cover by collections that are pairwise disjoint. To separate the 1-framed sets, we add additional 0-framed sets, and to separate the 2-framed sets, we add additional 0- and 1- framed sets. The additional 0- and 1- framed sets are subsets of existing 1- and 2- framed sets. The main idea is that

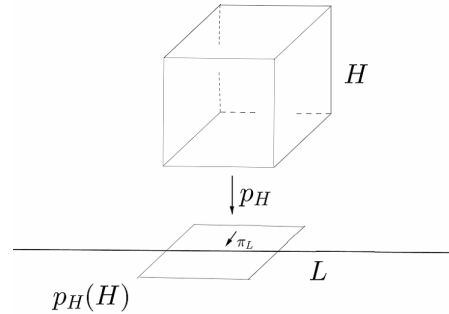

Figure 5. (H, p_H) is 2-framed. $(H, \pi_L \circ p_H)$ is artificially 1-framed.

if (H, p_H) is l -framed, then H is often k -framed for all $k \in \{0, 1, \dots, l\}$. Indeed if $L \subset \mathbb{R}^l$ is an affine k -dimensional subspace, then by composing p_H with orthogonal projection $\pi_L : \mathbb{R}^l \rightarrow L$, we get a submersion $\pi_L \circ p_H$ to the lower-dimensional Euclidean space, L . With this and some other mild hypotheses, H becomes k -framed. When we take this perspective on H , we say that H is **artificially k -framed** (see Figures 5 and 6). The concept of artificially framed sets is formally introduced in Subsection 5.1.

In the remainder of Part 0, we develop tools to deform framed covers to respectful covers and to verify the disjointness of framed sets. These are the topics of Subsections 5.6 and 5.11.

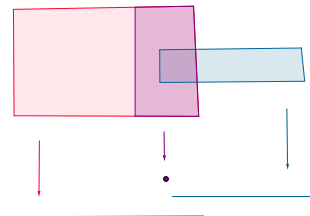

Figure 6. The purple artificially 0-framed set is separating the red and blue 1-framed sets.

3. THE PERELMAN FRAMED COVER

In this section, we prove the Perelman Covering Lemma.

Lemma 3.1 (Perelman Covering Lemma). *Given $\varkappa, \delta > 0$, there is a finite \varkappa -framed cover $\mathcal{P} = \mathcal{P}^0 \cup \mathcal{P}^1 \cup \mathcal{P}^2$ of $X \setminus X_\delta^4$.*

We will show this follows from next result (cf [18, 20, 35]).

Lemma 3.2 (Framed Lemma). *Given a (k, δ) -strained point $q \in X$ and $d > 0$, there is a $(k, \tau(\delta))$ -framed set (F, p_F, r_F) with $q \in F$ so that*

$$\text{diam}(F) \leq d. \quad (3.2.1)$$

With just a little extra effort, we will also take the following major step toward getting a proper cover.

Lemma 3.3 (Proper Lemma). *Let $q \in X$ be as in the Framed Lemma. We can choose F to satisfy the conclusion of the Framed Lemma and to also have the property that for every $y \in p_F(F)$, every point in the boundary of the closure of the fiber $p_F^{-1}(y)$ is $(k + 1, \tau(\delta))$ -strained.*

Proof of the Perelman Covering Lemma assuming Lemma 3.2. Let τ_F and τ_P be the τ s of the Framed and Proper Lemmas, respectively. Set

$$\tau := \max \{ \tau_P, \tau_F \}.$$

Given $\varkappa, \delta > 0$, choose δ_1, δ_2 so that $0 < \delta_1 < \delta_2 < \delta$,

$$\tau(\delta_2) < \min\{\delta, \varkappa\}, \text{ and } \tau(\delta_1) < \min\{\delta_2, \delta, \varkappa\}. \quad (3.3.1)$$

Let \mathfrak{s}^0 be the points of X that are not $(1, \delta_1)$ -strained. Since \mathfrak{s}^0 is compact, we cover \mathfrak{s}^0 by 0-framed sets and let \mathcal{P}^0 be a finite subcollection. We show in Proposition 3.11 (below) that \mathfrak{s}^0 is isolated. We can thus choose the diameters of the F small enough so that the closures of the F are disjoint.

By the definition of \mathfrak{s}^0 , all points in $X \setminus (\cup \mathcal{P}^0)^-$ are at least $(1, \delta_1)$ -strained. Let \mathfrak{s}^1 be all points in $X \setminus (\cup \mathcal{P}^0)^-$ that are not $(2, \delta_2)$ -strained. Use compactness and the Framed Lemma to choose a finite collection \mathcal{P}^1 of $(1, \tau_F(\delta_1))$ -framed sets that cover \mathfrak{s}^1 .

All points in $X \setminus ((\mathcal{UP}^0)^- \cup (\mathcal{UP}^1)^-)$ are then at least $(2, \delta_2)$ -strained in X . Let \mathfrak{s}^2 be all points in $X \setminus ((\mathcal{UP}^0)^- \cup (\mathcal{UP}^1)^-)$ that are not $(4, \delta)$ -strained. Again using compactness, construct a finite cover \mathcal{P}^2 of \mathfrak{s}^2 by $(2, \tau_F(\delta_2))$ -framed sets. It follows that $X \setminus X_\delta^4 \subset (\mathcal{UP}^0)^- \cup (\mathcal{UP}^1)^- \cup (\mathcal{UP}^2)^-$, as desired. \square

3.4. Lemmas 3.2 and 3.3. Except for the statement about the diameter, the Framed Lemma is a consequence of results in, e.g., [18, 20, 35]. Since we will also use several explicit facts from the proof, we give a self-contained exposition below.

The main tool is a reformulation of Perelman's construction of a strictly concave function on small neighborhoods of any point q in an Alexandrov space X (see Proposition 3.1 of [35], cf pages 389-390 of [14]).

Proposition 3.5 (Perelman's Concave Function). *For $q \in X$, let p be any point in the interior of a segment with endpoint q . Given $\varepsilon > 0$, there is a $\rho > 0$ and a C^1 -function*

$$f_p : B(q, \rho) \longrightarrow \mathbb{R}$$

that is strictly (-1) -concave and satisfies

$$|f_p - \text{dist}_p|_{C^1_{\text{stab}}} < \varepsilon. \quad (3.5.1)$$

Proof. Apart from Inequality (3.5.1), this is Proposition 3.1 of [35]. To establish Inequality (3.5.1), note that in [35] we saw that

$$f_p(\cdot) := \frac{1}{\text{vol}(B(p, \eta))} \int_{z \in B(p, \eta)} \psi \circ \text{dist}_z(\cdot), \quad (3.5.2)$$

where $\psi : \mathbb{R} \longrightarrow \mathbb{R}$ is an appropriately chosen, smooth, strictly increasing function. Inequality (3.5.1) follows from (3.5.2) and the fact that we have chosen p to be in the interior of a segment with endpoint q . \square

Since Perelman's functions are determined by distance functions, they are stable under Gromov-Hausdorff convergence. Our proof of the Framed and Proper Lemmas combines this fact together with the following "ideal" model for local Alexandrov geometry.

Proposition 3.6. *Suppose q is (k, δ, r) -strained in X . If λ is sufficiently small, there is a $\tau(\delta, \lambda)$ -embedding*

$$\Phi_\lambda : \frac{1}{\lambda} B(q, \lambda) \longrightarrow \mathbb{R}^k \times C(E) \quad (3.6.1)$$

so that $\Phi_\lambda(q) = (0, *)$, where $C(E)$ is the Euclidean cone on some Alexandrov space E with $\text{curv} \geq 1$, and $*$ is the cone point in $C(E)$.

Motivated by this result, we call $\mathbb{R}^k \times C(E)$ the **ideal tangent cone** and denote it by $T_q^{\text{ideal}} X$. In Corollary 3.10 (below), we show that on compact sets, $T_q^{\text{ideal}} X$ is almost isometric to $T_q X$ and that the Euclidean factor of $T_q^{\text{ideal}} X$ corresponds to an almost Euclidean factor of $T_q X$. Thus $T_q^{\text{ideal}} X$ is the idealized local model we would have if the δ of (k, δ, r) were 0. Before proving Proposition 3.6, we exploit it to prove the Framed and Proper Lemmas.

Proof of the Framed and Proper Lemmas assuming Proposition 3.6. First we use Perelman's functions to construct a k -framed neighborhood of $(0, *)$ in $\mathbb{R}^k \times C(E)$. Combining this with the $\tau(\delta, \lambda)$ -embedding (3.6.1), we will get our k -framed neighborhood of q .

Motivated by euclidean geometry, for $v, w \in T_q^{\text{ideal}} X$ with $\text{dist}((0, *), v) = \text{dist}((0, *), w) = 1$, we let $\angle(v, w)$ denote the intrinsic distance between v and w in

$$S((0, *), 1) := \{u \in T_q^{\text{ideal}} X \mid \text{dist}((0, *), u) = 1\}.$$

To construct k -framed sets about $(0, *)$ in $T_q^{\text{ideal}} X$, we select points $\{v_1, \dots, v_k\}$ in $T_q^{\text{ideal}} X$ that are close to an orthonormal basis for \mathbb{R}^k and satisfy $\angle(v_i, v_j) > \pi/2$ for all $i \neq j$. Next, we select a finite set of points $\{e_i\} \subset S((0, *), 1)$ that are close to E and satisfy

1. $\angle(e_i, v_j) > \pi/2$ for all i and all j .
2. $\{e_i\}$ is no more than $\pi/100$ from a subset of E that is $\frac{\pi}{8}$ -dense in E .

We then take the Perelman functions f_{v_i}, f_{-v_i} , and f_{e_j} from Proposition 3.5 and adjust them by adding constants so that they all agree at $(0, *)$. By Proposition 3.5, there is a $\tilde{\beta}_{\max}$ and a $\tilde{\nu}_{\max}$ so that the f_{v_i} and the f_{e_i} are (-1) -concave on

$$F := \mathbb{B}^l(\tilde{\beta}_{\max}) \times B(*, \tilde{\nu}_{\max}).$$

The density of the configuration of the $\{v_i\}$ and $\{e_j\}$ then implies that the strictly concave down function

$$h = \min_{i,j} \{f_{v_i}, f_{-v_i}, f_{e_j}\}$$

has a unique maximum at $(0, *)$. Moreover, if $\tilde{\beta}_{\max}$ and $\tilde{\nu}_{\max}$ are sufficiently small, then $\text{diam}(F) \leq d$. Since the $\{v_i\}$ are close to an orthonormal basis, the map $p_F : F \rightarrow \mathbb{R}^k$ defined as

$$p_F = (f_{v_1}, \dots, f_{v_k}) \tag{3.6.2}$$

is a $\tau(\delta)$ -almost Riemannian Submersion, if $\tilde{\beta}_{\max}$ and $\tilde{\nu}_{\max}$ are sufficiently small. Since $\angle(v_i, v_j) > \pi/2$, $\angle(e_i, v_j) > \pi/2$, and the f_{e_i} are (-1) -concave, the function $r_F : F \rightarrow \mathbb{R}$ defined as

$$r_F = \min_i \{f_{e_i}\}$$

is (-1) -concave when restricted to any fiber of p_F (see e.g., pages 663–664 in [38]). By construction, the restriction of r_F to the fiber $p_F^{-1}(p_F(0, *))$ is maximal at $(0, *)$, and by concavity, this maximum is unique. By continuity, for any $b \in \mathbb{B}^l(\tilde{\beta}_{\max})$, the unique maximum of $r_F|_{p_F^{-1}(b) \cap F}$ will be no more than $\frac{\tilde{\nu}_{\max}}{100}$ from $\mathbb{R}^k \times \{*\}$ provided $\tilde{\beta}_{\max}$ is sufficiently small. In particular, (F, p_F) is a fiber bundle whose fibers are disks. Since the base $\mathbb{B}^l(\tilde{\beta}_{\max})$ of (F, p_F) is contractible, (F, p_F) is a trivial vector bundle.

Since every point in $\mathbb{R}^k \times (C(E) \setminus \{*\})$ is $(k+1)$ -strained and the maxima of r_F along the fibers of p_F are close to $\mathbb{R}^k \times \{*\}$, the Proper Lemma 3.3 holds for the framed set $(F, p_F, r_F) \subset T_q^{\text{ideal}} X$. Since being $(k+1)$ -strained is stable under Gromov-Hausdorff approximation, the Proper Lemma 3.3 follows from Proposition 3.6. \square

For the proof of Proposition 3.6, we use the Join Lemma from [17] and a Theorem of Plaut from [33]. Plaut calls a set of $2n$ points $x_1, y_1, \dots, x_n, y_n$ in a metric space Y **spherical** if $\text{dist}(x_i, y_i) = \pi$ for all i and $\det[\cos \text{dist}(x_i, x_j)] > 0$.

Remark. If x_1, \dots, x_n are points in $\mathbb{S}^{n+k} \subset \mathbb{R}^{n+k+1}$, then $\sqrt{\det[\cos \text{dist}_{\mathbb{S}^{n+k}}(x_i, x_j)]}$ is the n -dimensional volume of the parallelepiped spanned by $\{x_1, \dots, x_n\}$. So Plaut's condition should be viewed as a quantification of linear independence.

Theorem 3.7 (Plaut [33]). *If X has curvature ≥ 1 and contains a spherical set σ of $2(n+1)$ points, then there is a subset $S \subset X$ that contains σ and is isometric to \mathbb{S}^n .*

Definition 3.8. *As in [35] (cf also [3, 25]), we say an Alexandrov space Σ with $\text{curv } \Sigma \geq 1$ is **globally** (m, δ) -strained by pairs of subsets $\{A_i, B_i\}_{i=1}^m$ provided*

$$\begin{aligned} |\text{dist}(a_i, b_j) - \frac{\pi}{2}| < \delta, & \quad \text{dist}(a_i, b_i) > \pi - \delta, \\ |\text{dist}(a_i, a_j) - \frac{\pi}{2}| < \delta, & \quad |\text{dist}(b_i, b_j) - \frac{\pi}{2}| < \delta \end{aligned}$$

for all $a_i \in A_i, b_i \in B_i$ and $i \neq j$.

Lemma 3.9. *Given natural numbers $k \leq n+1$ and $v > 0$, there is a $\delta > 0$ with the following property: If Σ is a globally (k, δ) -strained n -dimensional Alexandrov space with $\text{curv } \geq 1$ and $\text{vol} > v$, then there is an Alexandrov space E of $\text{curv } \geq 1$ and a $\tau(\delta|v)$ -homeomorphism*

$$h : \Sigma \longrightarrow \mathbb{S}^{k-1} * E,$$

where $\mathbb{S}^{k-1} * E$ has the spherical join metric.

Proof. If not, then there is a sequence of n -dimensional Alexandrov spaces $\{\Sigma_i\}$ with $\text{curv } \geq 1$ and $\text{vol} > v$ that are globally (k, δ_i) -strained with $\delta_i \rightarrow 0$, and that are not $\tau(\delta_i|v)$ -homeomorphic to a space of the form $\mathbb{S}^{k-1} * E$.

After passing to a convergent subsequence, we have $\lim_{i \rightarrow \infty} \Sigma_i = \Sigma$, where Σ is globally $(k, 0)$ -strained. This global strainer for Σ is a spherical set of $2k$ points. By Plaut's theorem (above), Σ contains a metrically embedded copy of \mathbb{S}^{k-1} . By the Join Lemma, there is an Alexandrov space E of $\text{curv } \geq 1$ so that Σ is isometric to the spherical join $\mathbb{S}^{k-1} * E$. By Perelman's Stability Theorem, all but finitely many of the Σ_i s are $\tau(\delta_i|v)$ -homeomorphic to Σ , a contradiction. \square

A lower volume bound and an upper diameter bound for an Alexandrov space X give a lower bound for the volume of all spaces of directions of X . So applying the previous result with Σ being a space of directions of X gives us

Corollary 3.10. *Let X be an n -dimensional Alexandrov space with $\text{curv } \geq -1$. Given $k \in \{0, 1, \dots, n\}$, there is a $\delta > 0$ with the following property:*

If $q \in X$ is (k, δ) -strained, then there is a space E of $\text{curv } \geq 1$ and a pointed homeomorphism

$$\Psi : (T_q X, *) \longrightarrow (T_q^{\text{ideal}} X, (0, *))$$

whose restriction to any r -ball around $*$ in $T_q X$ is a $\tau(\delta)$ r -embedding.

This, together with the Parameterized Stability Theorem ([21], Theorem 7.8) and the fact $(\lambda X, q) \rightarrow (T_q X, *)$ as $\lambda \rightarrow \infty$, gives us Proposition 3.6.

We close this subsection with a proof of the fact that 0-strained points in X are isolated.

Proposition 3.11. *Given $\delta > 0$, the set of points in X that are not $(1, \delta)$ -strained is isolated.*

Proof. Suppose $q \in X$ is not $(1, \delta)$ -strained and $x \in X$ satisfies $\text{dist}(q, x) = \frac{\lambda}{2}$. Let

$$\Omega_\lambda : \frac{1}{\lambda}B(q, \lambda) \longrightarrow B(*, 1) \subset T_q X$$

be a $\tau(\lambda)$ -Gromov-Hausdorff approximation with

$$\text{dist}\left(\Omega_\lambda(x), \frac{1}{2}\uparrow_q^x\right) < \tau(\lambda). \quad (3.11.1)$$

In $T_p X$, we have that $\frac{1}{2}\uparrow_q^x$ is $(k, \delta, r) = (1, 0, \frac{1}{4})$ -strained by $*$ and the direction \uparrow_q^x . For $\delta > 0$, the property of being (k, δ, r) -strained is Gromov-Hausdorff stable, so (3.11.1) gives us that x is $(1, \tau(\delta, \lambda), \frac{1}{4})$ -strained in $\frac{1}{\lambda}X$, and hence x is $(1, \tau(\delta, \lambda), \frac{\lambda}{4})$ -strained in X . Since x was an arbitrary point with $\text{dist}(q, x) = \frac{\lambda}{2}$, the result follows. \square

3.12. The Parameterized Perelman Framed Cover. In this section, we record further properties of the Perelman cover that are consequences of its construction.

Lemma 3.13 (Parameterized Framed Lemma). *Let $q \in X$ be (k, δ, r) -strained. There are numbers β_{\max} and ν_{\max} and a $(k, \tau(\delta))$ -framed neighborhood $(F(\beta_{\max}, \nu_{\max}), p, r)$ of q so that the following hold:*

1. *For all $(\beta, \nu) \in [\beta_{\max}/1000, \beta_{\max}] \times [\nu_{\max}/1000, \nu_{\max}]$, there is a set $F(\beta, \nu) \subset F(\beta_{\max}, \nu_{\max})$ so that $(F(\beta, \nu), p, r)$ is $(k, \tau(\delta))$ -framed and $F(\beta, \nu)$ satisfies the conclusion of the Proper Lemma.*
2. *If $\beta_1 < \beta_2$ and $\nu_1 < \nu_2$, then*

$$F(\beta_1, \nu_1) \Subset F(\beta_2, \nu_2).$$

3. *The Gromov-Hausdorff distance*

$$\text{dist}(F(\beta, \nu), \mathbb{B}^k(\beta) \times B(*, \nu)) < \tau(\delta)(\beta_{\max} + \nu_{\max}),$$

where $\mathbb{B}^k(\beta) \times B(*, \nu)$ is a product of metric balls in $T_q^{\text{ideal}} X = \mathbb{R}^k \times C(E)$.

Proof. We get Parts 1 and 2 by combining the construction of F from the proof of the Framed Lemma with the Proper Lemma. To prove Part 3, we first observe that since the statement is Gromov-Hausdorff stable, as in the proof of Lemma 3.2, it suffices to prove the result with X replaced by $T_q^{\text{ideal}} X$ and q replaced by $(0, *)$. The rest of the proof is very similar to the the proof of Lemma 3.2, the difference being we replace $\{v_1, \dots, v_k\}$ with a ξ -dense subset of $\{s_i\} \subset S((0, *), 1) \cap \mathbb{R}^k$, and we require that $\{e_i\}$ be a set that is no more than ξ from a ξ -dense subset of E . We let

$$h_B = \min\{f_{s_i}\} \text{ and } r = \min\{f_{e_j}\}.$$

We again add constants to f_{s_i} and f_{e_j} so that they all agree at $(0, *)$. This allows us to assume that $h_B|_{\mathbb{R}^k \times *}$ and $r|_{0 \times C(E)}$ have their unique maximums at $(0, *)$. We define p_F via (3.6.2), as before, and let $F(\beta_{\max}, \nu_{\max})$ be the intersection of superlevels of h_B and r .

For each of the f_{s_i} and the f_{e_j} , let ε be as in (3.5.1). By choosing both ε and ξ to be small, we force the directions of maximal decrease of h_B and r at a point $(u, v) \in F(\beta_{\max}, \nu_{\max})$ to be arbitrarily close to the radial fields of $\mathbb{R}^k \times \{v\}$ and $\{u\} \times C(E)$, uniformly on compact

subsets of $\{\mathbb{B}^k(\beta_{\max}) \setminus \{0\}\} \times \{B(*, \nu_{\max}) \setminus \{0\}\}$. Part 3 follows by combining this with the Fundamental Theorem of Calculus. \square

Remark. *In many cases, the sets from Lemma 3.13 that we consider will be those for which the two parameters are equal. When this occurs, we will write $F(\beta)$ for $F(\beta, \beta)$. When the precise values of the parameters are inconsequential, we will simply write F .*

Part 1 of Lemma 3.13 gives us

Corollary 3.14 (Quantitatively Proper). *The sets $(F(\beta_{\max}, \nu_{\min}), p, r)$ from Lemma 3.13 have the property that every point of*

$$F(\beta_{\max}, \nu_{\max}) \setminus F(\beta_{\max}, \nu_{\max}/1000)$$

is $(k+1, \tau(\delta))$ -strained.

In fact, our choices of ε and ξ in the proof of the Parameterized Framed Lemma give us that (r_F, p_F) is an explicit $(k+1)$ -framing for the points in $F(\beta_{\max}, \nu_{\max}) \setminus F(\beta_{\max}, \nu_{\max}/1000)$.

Corollary 3.15. *For each $x \in F(\beta_{\max}, \nu_{\max}) \setminus F(\beta_{\max}, \frac{\nu_{\max}}{1,000})$, there is a neighborhood N_x of x that is the total space of a stable trivial vector bundle*

$$\begin{aligned} p_{N_x} &: N_x \longrightarrow \mathbb{R} \times \mathbb{R}^k \\ p_{N_x}(x) &= (r_F(x), p_F(x)) \end{aligned} \tag{3.15.1}$$

whose projection is a $\tau(\delta)$ -almost Riemannian submersion. In particular, $\{F, N_x\}$ is a respectful framed collection.

Remark. *The constant $\frac{1}{1,000}$ in (3.14) can of course be replaced by any positive constant we like, but as far as we know, this constant must be chosen before F is constructed. We believe this is necessary because of the possibility of bifurcating strata. We are grateful to Vitali Kapovitch for pointing this out to us (cf Figure 8).*

Together the results of this section give us a parameterized version of the Perelman Covering Lemma.

Definition 3.16. *A framed cover $\mathcal{H} = \mathcal{H}^0 \cup \mathcal{H}^1 \cup \mathcal{H}^2$ of $X \setminus X_\delta^4$ is **parameterized** if there is a $b > 1$ so that for $t \in [\frac{1}{2}, b]$,*

$$\mathcal{H}^0(t) \cup \mathcal{H}^1(t) \cup \mathcal{H}^2(t) := \{F_i^0(t\beta_i^0)\}_{F_i^0 \in \mathcal{H}^0} \cup \{F_i^1(t\beta_i^1)\}_{F_i^1 \in \mathcal{H}^1} \cup \{F_i^2(t\beta_i^2)\}_{F_i^2 \in \mathcal{H}^2}$$

is a framed cover of $X \setminus X_\delta^4$, and for each $k = 0, 1, 2$, each member of the 1-parameter family $\{F_i^k(t\beta_i^k)\}_{t \in [\frac{1}{2}, b]}$ of k -framed sets satisfies the conclusions of Lemma 3.13 and Corollary

*3.14. We say that \mathcal{H}^k is **parameterized on** $[\frac{1}{2}, b]$.*

By combining the proof of the Perelman Covering Lemma with Lemma 3.13 and Corollary 3.14 we get the

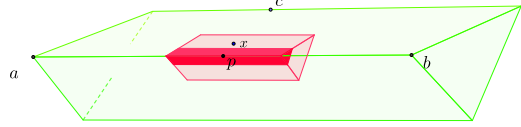

Figure 7. Let X be the double of the convex subset of \mathbb{R}^3 in the picture. The double of the red set is 1-strained in X by (a, b) . Lemma 3.14 guarantees that the light red points are also 2-strained. For example, x is 2-strained by $\{(a, b), (p, c)\}$.

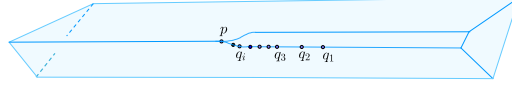

Figure 8. In Figure 7, the points that cannot be 2–strained are precisely those on the segment ab . However, the double of the convex set in this picture explains why it is difficult to improve on the statement in Corollary 3.14, apart from the comment that $\frac{1}{1,000}$ can be any a priori constant. Consider applying Lemma 3.13 to each of the points q_i . There are two ways to avoid the upper branch of 1–strained points: the quantity β_{max} can converge to 0 as the $q_i \rightarrow p$, or the branch can be “swallowed” by $F(\beta_{max}, \frac{\nu_{max}}{1,000})$. These considerations together with the fact that the bifurcation in this figure can be repeated any finite number of times leads us to think that a practical improvement of Corollary 3.14 is not possible.

Parameterized Perelman Covering Lemma 3.17. *For all $\delta > 0$, there is a parameterized framed cover $\mathcal{P} = \mathcal{P}^0 \cup \mathcal{P}^1 \cup \mathcal{P}^2$ of $X \setminus X_\delta^4$ so that the closures of elements of \mathcal{P}^0 are pairwise disjoint, and for each $k \in \{0, 1, 2\}$, \mathcal{P}^k is parameterized on $[\frac{1}{2}, 25]$.*

Convention: From this point all of our framed covers will be parameterized. To keep the nomenclature simple, we will use the term framed cover for parameterized framed cover. All of our assertions about framed covers will also be valid for slightly larger and slightly smaller versions of the covers, but in the interest of simplicity, typically, we will not mention this.

4. THE PERELMAN-PLAUT FRAMED COVER

In this section, we improve the Perelman Framed Cover to one for which the intersections of the 1- and 2-framed sets are more tightly constrained. We call these constraints κ –lined up, vertically separated, and fiber swallowing (see Figures 9, 12, 10, and 11). Before defining these new terms, we state the result.

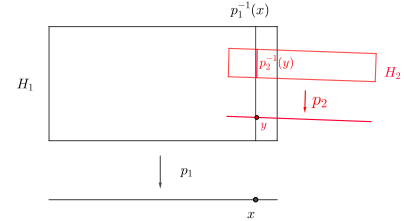

Figure 9. Fiber swallowing and κ -lined up

Lemma 4.1 (Perelman-Plaut Covering Lemma). *Given $\delta, \kappa, \mu > 0$, there is a $\varkappa_0 > 0$ with the following property: For all $\varkappa \in (0, \varkappa_0)$, there is a parameterized, \varkappa -framed cover $\mathcal{Z} = \mathcal{Z}^0 \cup \mathcal{Z}^1 \cup \mathcal{Z}^2$ of $X \setminus X_\delta^4$ so that*

1. *The closures of the elements of \mathcal{Z}^0 are pairwise disjoint.*
2. *\mathcal{Z}^1 and \mathcal{Z}^2 are κ -lined up, vertically separated, and fiber swallowing.*
3. *Given $k \in \{0, 1, 2\}$, all k -framed sets $F_i^k(\beta_i^k)$ in \mathcal{Z}^k satisfy $\beta_i^k \leq \mu$.*

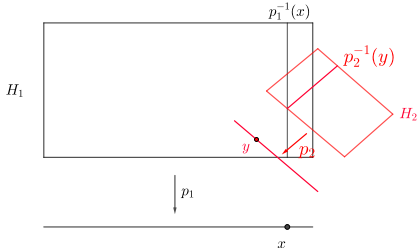

Figure 10. Not κ -lined up

We start with the definition of κ -lined up.

Definition 4.2 (See Figures 9, 10, and 12). *Given $\kappa > 0$, we say two almost Riemannian submersions $q, p : U \rightarrow \mathbb{R}^k$ are κ -lined up provided*

$$|dp - I_{p,q} \circ dq|_{\text{stab}} < \kappa \quad (4.2.1)$$

*for some isometry $I_{p,q} : \mathbb{R}^k \rightarrow \mathbb{R}^k$. We say that p and q are **lined up** if there is a diffeomorphism $I_{p,q} : \mathbb{R}^k \rightarrow \mathbb{R}^k$ so that $p = I_{p,q} \circ q$.*

Definition 4.3. Given $\kappa > 0$, let \mathcal{U} be a collection of k -framed sets parameterized on $[\frac{1}{2}, 25]$. We say that \mathcal{U} is κ -lined up provided for all $(F_1(\beta_1), p_1), (F_2(\beta_2), p_2) \in \mathcal{U}$ with $F_1(\beta_1) \cap F_2(\beta_2) \neq \emptyset$, the submersions p_1 and p_2 are κ -lined up on $F_m(5\beta_m) \cap F_q(5\beta_q)$.

Definition 4.4. A collection of k -framed sets U parameterized on $[\frac{1}{2}, 25]$ is called **vertically separated** if and only if for all $(\tilde{F}(\tilde{\beta}), \tilde{p}), (F(\beta), p) \in U$ with $\tilde{\beta} \geq \beta$ and $\tilde{F}(4\tilde{\beta}, \tilde{\beta}) \cap F(\beta, \beta) = \emptyset$,

$$\text{dist}(\tilde{F}(\tilde{\beta}), F(\beta)) \geq \frac{\tilde{\beta}}{6}.$$

Definition 4.5. A collection of k -framed sets \mathcal{U} is called **fiber swallowing** if for all $(F(\beta), p), (\tilde{F}(\tilde{\beta}), \tilde{p}) \in \mathcal{U}$ and all $x \in F(\beta) \cap \tilde{F}(\tilde{\beta})$,

$$p^{-1}(p(x)) \cap F\left(\beta, \frac{1}{100}\beta\right) \subset \tilde{F}\left(\tilde{\beta}^+, \frac{5}{100}\tilde{\beta}\right), \quad (4.5.1)$$

provided $\tilde{\beta} \geq \beta$.

Let τ_{PF} and τ_{QP} be the τ s of the Parameterized Framed Lemma (3.13) and the Quantitatively Proper Corollary (3.14), respectively. Set $\tau := \max\{\tau_{PF}, \tau_{QP}\}$. Given $\delta, \varkappa > 0$, choose δ_1, δ_2 so that $0 < \delta_1 < \delta_2 < \delta$,

$$\tau(\delta_2) < \min\{\delta, \varkappa\} \text{ and } \tau(\delta_1) < \min\{\delta_2, \varkappa, \delta\}. \quad (4.5.2)$$

By adding a non-redundancy criterion to the construction of \mathcal{P} , we will get a framed cover $\mathcal{Z} = \mathcal{Z}^0 \cup \mathcal{Z}^1 \cup \mathcal{Z}^2$ so that \mathcal{Z}^1 and \mathcal{Z}^2 are κ -lined up, vertically separated, and fiber swallowing.

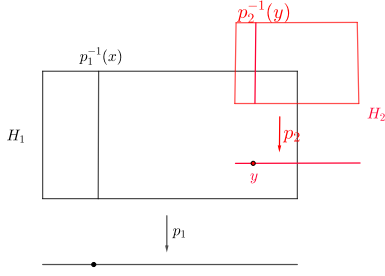

Figure 12. κ -lined up but not fiber swallowing

the closures of the elements of \mathcal{Z}^0 are disjoint. It only remains to prove Part 2 of Lemma 4.1, that is, we must show \mathcal{Z}^1 and \mathcal{Z}^2 are both κ -lined up, vertically separated, and fiber swallowing. The following technical result is the key to proving this.

Proposition 4.6 (Line up—see Figure 13). *Given $\varepsilon_1, \kappa > 0$, there is a $\varkappa > 0$ so that if (F_1, p_{F_1}) , and (F_2, p_{F_2}) are (k, \varkappa) -framed sets from the Lemma 3.13, then either*

1. all points in $F_1 \cap F_2$ are $(k+1, \varepsilon_1)$ -strained, or
2. p_{F_1} and p_{F_2} are κ -lined up,

provided $\max\{\text{diam}(F_1), \text{diam}(F_2)\}$ is small enough compared with r .

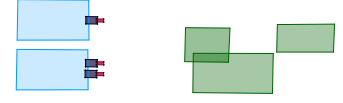

Figure 11. The framed sets on the left are vertically separated. Those on the right are not vertically separated.

We set $\mathcal{Z}^0 = \mathcal{P}^0$, and repeat the construction of the 1-framed sets in the proof of the Perelman Covering Lemma (3.1), with the added constraint that we require each $Z \in \mathcal{Z}^1$ to actually contain a point of X that is not $(2, \delta_2)$ -strained. Having obtained \mathcal{Z}^1 , we impose the analogous requirement on \mathcal{Z}^2 , namely that each of its elements contain a point of X that is not $(4, \delta)$ -strained. \mathcal{Z} is thus a \varkappa -framed cover of $X \setminus X_\delta^4$, and since $\mathcal{Z}^0 = \mathcal{P}^0$, the

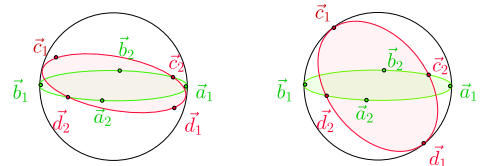

Figure 13. Both pictures are of directions that correspond to two sets of strainers $\{(a_1, b_1), (a_2, b_2)\}$ and $\{(c_1, d_1), (c_2, d_2)\}$ in an unknown space of directions Σ_p . In the picture on the left, the corresponding submersions are κ -lined up. In the picture on the right, the submersions are not κ -lined up, so p is actually 3-strained.

Before giving the proof we show that this proposition implies that \mathcal{Z} is κ -lined up, vertically separated, and fiber swallowing. We start with the κ -lined up assertion.

Proposition 4.7. *Assume that Proposition 4.6 holds. Given $\delta, \kappa > 0$, there is a $\varkappa > 0$ so that the \varkappa -framed cover \mathcal{Z} constructed above is κ -lined up, provided the diameters of all elements of \mathcal{Z} are sufficiently small.*

Proof. Since the elements of \mathcal{Z} are close to a product of balls, if $(F_1(\beta_1), p_1), (F_2(\beta_2), p_2) \in \mathcal{Z}^k$, $\beta_1 \leq \beta_2$, and $F_1(\beta_1) \cap F_2(\beta_1) \neq \emptyset$, then

$$F_1(\beta_1) \subset F_2(5\beta_2).$$

Set $\delta = \delta_3 = \delta_4$ and for $k = 1, 2$, let $\varepsilon_1 = \delta_{k+1}$. Assume \varkappa and the diameter of each element of \mathcal{Z} is small enough so that the line up Proposition 4.6 holds for all pairs $\{F_1(5\beta_1), F_2(5\beta_2)\}$ with $F_1, F_2 \in \mathcal{Z}^k$. If $F_1(\beta_1) \cap F_2(\beta_2) \neq \emptyset$, we claim p_1 and p_2 are κ -lined up. If not, by Proposition 4.6, all points of $F_1(5\beta_1) \cap F_2(5\beta_2)$ are $(k+1, \delta_{k+1})$ -strained. However, if $\beta_1 \leq \beta_2$, then $F_1(\beta_1) \subset F_2(5\beta_2)$, so all points of $F_1(\beta_1)$ are $(k+1, \delta_{k+1})$ -strained. Since this contradicts the fact that $F_1 \in \mathcal{Z}^k$, \mathcal{Z}^k is κ -lined up. \square

Next we show that \mathcal{Z} is vertically separated and fiber swallowing.

Proposition 4.8. *Given $\delta > 0$, there are $\kappa, \varkappa > 0$ so that if \mathcal{Z} is one of the κ -lined up \varkappa -framed covers of $X \setminus X_\delta^4$ constructed above, then \mathcal{Z} is vertically separated and fiber swallowing.*

Proof. For $k = 1, 2$, suppose $F_1(\beta_1), F_2(\beta_2) \in \mathcal{Z}^k$, $\beta_2 \geq \beta_1$, $F_1(\beta_1, \beta_1) \cap F_2(4\beta_2, \beta_2) = \emptyset$, and $\text{dist}(F_1(\beta_1), F_2(\beta_2)) < \frac{\beta_2}{6}$. Then $F_1(\beta_1) \subset F_2(4\beta_2, 4\beta_2) \setminus F_2(4\beta_2, \beta_2)$. Combined with the Quantitatively Proper Corollary (3.14), this implies that all points of $F_1(\beta_1)$ are $\tau_{QP}(\delta_k) < \tau(\delta_k) < \delta_{k+1}$ -strained, where, as before, $\delta = \delta_3 = \delta_4$. This contradicts $F_1 \in \mathcal{Z}^k$, so \mathcal{Z}^k is vertically separated.

For $k = 1, 2$, suppose $F_1(\beta_1), F_2(\beta_2) \in \mathcal{Z}^k$, $\beta_2 \geq \beta_1$ and $x \in F_1(\beta_1) \cap F_2(\beta_2)$. Set

$$B_1(x) := p_1^{-1}(p_1(x)) \cap F_1\left(\beta_1, \frac{1}{100}\beta_1\right).$$

We will show $B_1(x) \subset F_2(\beta_2^+, \frac{5}{100}\beta_2)$.

By Part 3 of Lemma 3.13, if $y, y' \in B_1(x)$, then

$$\text{dist}(y, y') < \frac{2^+}{100}\beta_1.$$

If κ and \varkappa are small enough and $y \in B_1(x) \setminus F_2(\beta_2^+, \frac{5}{100}\beta_2)$, then

$$\text{dist}\left(y, F_2\left(\beta_2, \frac{1}{100}\beta_2\right)\right) > \left(\frac{5}{100} - \frac{1^+}{100}\right)\beta_2 = \left(\frac{4^-}{100}\right)\beta_2.$$

The previous two displays give us,

$$B_1(x) \cap F_2\left(\beta_2^+, \frac{2^-}{100}\beta_2\right) = \emptyset.$$

Together with the fact that $\{F_1, F_2\}$ is κ -lined up, this gives us that

$$F_1 \left(\beta_1, \frac{1}{100} \beta_1 \right) \subset F_2(5\beta_2) \setminus F_2 \left(5\beta_2, \frac{1}{1,000} \beta_2 \right),$$

provided κ and \varkappa are small enough. Combined with the Quantitatively Proper Corollary (3.14), this implies that all points of F_1 are $\tau_{QP}(\delta_k) < \tau(\delta_k) < \delta_{k+1}$ -strained, where, as before, $\delta = \delta_3 = \delta_4$. This contradicts $F_1 \in \mathcal{Z}^k$. Thus $B_1(x) \subset F_2(\beta_2^+, \frac{5}{100}\beta_2)$, and \mathcal{Z}^k is fiber swallowing. \square

4.9. The Line Up Proposition 4.6. To complete the proof of Lemma 4.1, in this subsection we prove the Line Up Proposition (4.6).

We will need the next two results on the stability of straining directions from [35]. Here we assume that $\{M_\alpha\}_\alpha$ is a sequence of n -dimensional Alexandrov spaces that converge to X and that $B \subset X$ is (k, δ, r) -strained by $\{(a_i, b_i)\}_{i=1}^k$.

Proposition 4.10 (Lemma 1.4 in [35]). *For any $x \in B$ and $i \neq j$, if θ is any of the angles $\sphericalangle(a_i, x, b_j)$, $\sphericalangle(b_i, x, b_j)$, $\sphericalangle(a_i, x, a_j)$, then*

$$|\pi/2 - \theta| < \tau(\delta).$$

To state the next result, we adopt Petrunin's convention ([32]) that \uparrow_x^p denotes the set of directions of segments from x to p . Later we will use \uparrow_x^p to denote the direction of a single segment from x to p .

Proposition 4.11 (Proposition 1.5 in [35]). *Suppose $y \in B$ and $\{(a_i^\alpha, b_i^\alpha)\}_{i=1}^k \subset M_\alpha \times M_\alpha$ converge to $\{(a_i, b_i)\}_{i=1}^k$. Let $c^\alpha \in M_\alpha$ converge to $c \in B \setminus \{y\}$.*

Then for $y^\alpha \in M^\alpha$ with $y^\alpha \rightarrow y$,

$$\left| \sphericalangle \left(\uparrow_{y^\alpha}^{a_i^\alpha}, \uparrow_{y^\alpha}^{c^\alpha} \right) - \sphericalangle \left(\uparrow_y^{a_i}, \uparrow_y^c \right) \right| < \tau(\delta) + \tau \left(\frac{1}{\alpha} |r| \right).$$

Let (F_1, p_{F_1}) and (F_2, p_{F_2}) be as in the Line Up Proposition (4.6). Suppose that F_1 and F_2 are constructed via (k, δ, r) -strainers $\{(a_i, b_i)\}_{i=1}^k$ and $\{(c_i, d_i)\}_{i=1}^k$, and $\text{diam } \{F_1\}, \text{diam } \{F_2\} \leq d$, for some $d > 0$. Use a superscript index α to denote approximations of these structures in M_α . Applying the previous result to this situation gives us

Corollary 4.12. *For $x^\alpha, y^\alpha \in F_1^\alpha \cap F_2^\alpha$,*

$$\left| \sphericalangle \left(\uparrow_{x^\alpha}^{a_i^\alpha}, \uparrow_{x^\alpha}^{c_j^\alpha} \right) - \sphericalangle \left(\uparrow_{y^\alpha}^{a_i^\alpha}, \uparrow_{y^\alpha}^{c_j^\alpha} \right) \right| < \tau(\delta) + \tau \left(\frac{1}{\alpha}, d|r| \right).$$

In the next proposition, we show $p_{F_1^\alpha}$ and $p_{F_2^\alpha}$ are κ -lined up provided the differential $dp_{F_2^\alpha}$ at some point $x^\alpha \in F_1^\alpha(\beta_1) \cap F_2^\alpha(\beta_2)$ is almost an isometry when restricted to the horizontal space of $p_{F_1^\alpha}$.

Proposition 4.13. *Let H_1^α be the horizontal distribution of $p_{F_1^\alpha}$. Given $\kappa > 0$, there is a $\lambda_0 < 1$ so that if for some $x \in F_1^\alpha \cap F_2^\alpha$ and some $\lambda \in (\lambda_0, 1)$, $(dp_{F_2^\alpha})_x$ is $\frac{1}{\lambda}$ -bilipschitz on the unit sphere of H_1^α , then $p_{F_1^\alpha}$ and $p_{F_2^\alpha}$ are κ -lined up, provided $\tau(\delta) + \tau \left(\frac{1}{\alpha}, d|r| \right) < \kappa$.*

Proof. Let $(p_{F_1^\alpha})^i$ and $(p_{F_2^\alpha})^i$ be the i^{th} -coordinate functions of $p_{F_1^\alpha}$ and $p_{F_2^\alpha}$.

Since $p_{F_2^\alpha}$ is a $\tau(\delta)$ -almost Riemannian submersion, the hypothesis that $(dp_{F_2^\alpha})_x|_{H_1^\alpha}$ is $\frac{1}{\lambda}$ -bilipschitz tells us that at x , the horizontal distributions

$$H_1^\alpha = \text{span} \left\{ \nabla (p_{F_1^\alpha})^i \right\}_i \quad \text{and} \quad H_2^\alpha = \text{span} \left\{ \nabla (p_{F_2^\alpha})^j \right\}_j$$

nearly coincide. On the other hand, Corollary 4.12 tells us that the angles between the above gradients do not vary by more than $\tau(\delta) + \tau\left(\frac{1}{\alpha}, d|r\right)$ on $F_1^\alpha \cap F_2^\alpha$. It follows that H_1^α and H_2^α nearly coincide throughout $F_1^\alpha \cap F_2^\alpha$. Since both of $p_{F_1^\alpha}$ and $p_{F_2^\alpha}$ are $\tau(\delta)$ -almost Riemannian submersions, it follows that that $p_{F_1^\alpha}$ and $p_{F_2^\alpha}$ are κ -lined up, provided

$$\tau(\delta) + \tau\left(\frac{1}{\alpha}, d|r\right) < \kappa,$$

and λ_0 is close enough to 1.

Proposition 4.14 (see Figure 14). *Let V be an inner product space with k -dimensional subspaces H_1 and H_2 . Let S_1 be the unit sphere in H_1 . Let B be an orthonormal basis for H_1 , and let*

$$\pi : V \longrightarrow H_2$$

be orthogonal projection.

For all $\lambda \in \left(\frac{1}{2}, 1\right)$, there is a $\tilde{\lambda} \in (\lambda, 1)$ so that either $\pi|_{S_1}$ is $\frac{1}{\tilde{\lambda}}$ -bilipschitz, or for some $b \in B$,

$$|\pi(b)| < \tilde{\lambda}.$$

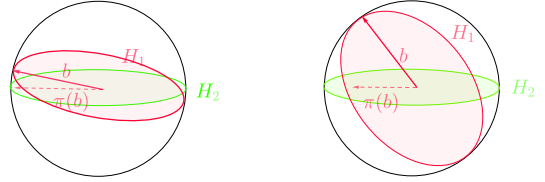

Figure 14. In the figure on the left, the orthogonal projection of the unit sphere in the subspace H_1 to the subspace H_2 is almost an isometry. The fact that this is not the case on the right is detected by the vector b whose orthogonal projection to H_2 has length significantly less than 1.

Proof. Since π is orthogonal projection, it is 1-Lipshitz on unit vectors, and $|\pi(b)| \leq 1$ for all $b \in B$.

If the result is false, there is a $\lambda \in \left(\frac{1}{2}, 1\right)$ and a sequence $\{\tilde{\lambda}_i\}_{i=1}^\infty \subset (\lambda, 1)$ with $\tilde{\lambda}_i \rightarrow 1$ so that $\pi|_{S_1}$ is not $\frac{1}{\tilde{\lambda}}$ -bilipschitz and

$$\tilde{\lambda}_i \leq |\pi(b)| \leq 1 \quad \text{for all } b \in B.$$

Sending $i \rightarrow \infty$, it follows that

$$|\pi(b)| = 1 \quad \text{for all } b \in B. \quad (4.14.1)$$

Since $\pi|_{S_1}$ is 1-Lipshitz but not $\frac{1}{\lambda}$ -bilipschitz, there is a $s \in S_1$ so that $|\pi(s)| < \lambda$. Combining this with (4.14.1), we see that for at least two distinct elements of B , say b_1 and b_2 ,

$$|\langle \pi(b_1), \pi(b_2) \rangle| > \tau(1 - \lambda). \quad (4.14.2)$$

(4.14.1) and (4.14.2) together imply that $\pi|_{S_1}$ is not 1-Lipschitz. Since π is an orthogonal projection, this is a contradiction. \square

The following is a natural deformation of the hypotheses of Plaut's Theorem 3.7.

Definition 4.15. *A set of $2n$ points $x_1, y_1, \dots, x_n, y_n$ in a metric space Y is called $(\delta|v)$ -almost spherical if $\text{dist}(x_i, y_i) > \pi - \delta$ for all i and $\det[\cos \text{dist}(x_i, x_j)] > v > 0$.*

The following result gives a connection between strainers and almost spherical sets.

Proposition 4.16 (Proposition 1.14 in [35]). *Let X have curvature ≥ 1 , dimension n , and contain a $(\delta|v)$ -almost spherical set S of $2(m+1)$ points. Then there is an $(m+1, \tau(\delta|v))$ -global strainer $\{(a_i, b_i)\}_{i=1}^{m+1}$ for X .*

We are ready to prove the Line Up Proposition.

Proof of Proposition 4.6. Let H_1^α and H_2^α be the horizontal distributions of $p_{F_1^\alpha}$ and $p_{F_2^\alpha}$. Let S_1 be the unit sphere in H_1^α . Given $\kappa > 0$, we use Proposition 4.13 to choose $\delta, d > 0$, α , and $\lambda \in (\frac{1}{2}, 1)$ so that if $dp_{F_2^\alpha}|_{S_1}$ is $\frac{1}{\lambda}$ -bilipschitz at a point, then p_{F_1} and p_{F_2} are κ -lined up everywhere. Therefore, if p_{F_1} and p_{F_2} are not κ -lined up, then $dp_{F_2^\alpha}|_{H_1}$ is not $\frac{1}{\lambda}$ -bilipschitz everywhere on $F_1^\alpha \cap F_2^\alpha$. By Proposition 4.14, we then have that for all $y^\alpha \in F_1^\alpha \cap F_2^\alpha$, there is $\tilde{\lambda} \in (\lambda, 1)$ and a straining direction, say $\uparrow_{y^\alpha}^{a_1^\alpha} \in \Sigma_{y^\alpha}$, so that

$$\left| dp_{F_2^\alpha} \left(\uparrow_{y^\alpha}^{a_1^\alpha} \right) \right| < \tilde{\lambda}. \quad (4.16.1)$$

By further constraining δ, d , and α , and appealing to Proposition 4.11, we see that $\tilde{\lambda}$ can be chosen independent of $y^\alpha \in F_1^\alpha \cap F_2^\alpha$.

It follows from Lemma 4.10 that there is a choice of τ that we will call τ_{vol} so that

$$\det \left(\left\{ \cos \angle \left(\uparrow_{y^\alpha}^{c_i^\alpha}, \uparrow_{y^\alpha}^{c_j^\alpha} \right) \right\}_{i,j} \right) > 1 - \tau_{\text{vol}}(\delta). \quad (4.16.2)$$

Writing a $(k+1) \times (k+1)$ matrix in the form

$$\begin{pmatrix} k \times k & k \times 1 \\ k \times 1 & 1 \times 1 \end{pmatrix}$$

and interpreting the following determinant as the square of the $(k+1)$ -volume of the parallelepiped determined by $\left\{ \uparrow_{y^\alpha}^{c_i^\alpha} \right\}_{i=1}^k \cup \left\{ \uparrow_{y^\alpha}^{a_1^\alpha} \right\}$ embedded in \mathbb{R}^{k+1} , we conclude, using (4.16.1) and (4.16.2), that

$$\det \begin{pmatrix} \left\{ \cos \angle \left(\uparrow_{y^\alpha}^{c_i^\alpha}, \uparrow_{y^\alpha}^{c_j^\alpha} \right) \right\}_{i,j} & \left\{ \cos \angle \left(\uparrow_{y^\alpha}^{a_1^\alpha}, \uparrow_{y^\alpha}^{c_j^\alpha} \right) \right\}_{1,j} \\ \left\{ \cos \angle \left(\uparrow_{y^\alpha}^{c_i^\alpha}, \uparrow_{y^\alpha}^{a_1^\alpha} \right) \right\}_{i,1} & \cos \angle \left(\uparrow_{y^\alpha}^{a_1^\alpha}, \uparrow_{y^\alpha}^{a_1^\alpha} \right) \end{pmatrix} > 1 - \tau_{\text{vol}}(\delta) - \tilde{\lambda}^2.$$

Letting $\alpha \rightarrow \infty$ gives us

$$\det \begin{pmatrix} \left\{ \cos \angle \left(\uparrow_y^{c_i}, \uparrow_y^{c_j} \right) \right\}_{i,j} & \left\{ \cos \angle \left(\uparrow_y^{a_1}, \uparrow_y^{c_j} \right) \right\}_{1,j} \\ \left\{ \cos \angle \left(\uparrow_y^{c_i}, \uparrow_y^{a_1} \right) \right\}_{i,1} & \cos \angle \left(\uparrow_y^{a_1}, \uparrow_y^{a_1} \right) \end{pmatrix} \geq 1 - \tau_{\text{vol}}(\delta) - \tilde{\lambda}^2.$$

So for each $y \in F_1 \cap F_2$, $\left\{ \left(\uparrow_y^{c_i}, \uparrow_y^{d_i} \right) \right\}_{i=1}^k$ together with $\left(\uparrow_y^{a_1}, \uparrow_y^{b_1} \right)$ forms a $\left(\delta | 1 - \tau_{\text{vol}}(\delta) - \tilde{\lambda}^2 \right)$ -almost spherical set $S \subset \Sigma_y$ of $2(k+1)$ points.

To complete the proof, we further constrain δ so that

$$\tau_{\text{plaut}} \left(\delta | 1 - \tau_{\text{vol}}(\delta) - \tilde{\lambda}^2 \right) < \varepsilon_1,$$

where τ_{plaut} is the τ of Proposition 4.16. Thus Proposition 4.16 gives that each point of $F_1 \cap F_2$ is $(k+1, \varepsilon_1)$ -strained, as claimed. \square

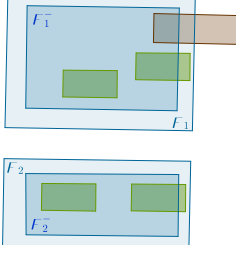

Figure 15. The collection of green 1-framed sets thoroughly respects the collection of 0-framed sets $\{F_1, F_2\}$; however, the brown set does not thoroughly respect $\{F_1, F_2\}$.

4.16. Improving the Perelman-Plaut Cover. The next step in the proof of Limit Lemma G is to modify the Perelman-Plaut Covering Lemma (4.1) by constraining the way that the 1- and 2-framed sets intersect the 0-framed sets and imposing further geometric constraints on the 1-framed sets. The results are stated in Lemma 4.19 (below). The constraint on intersections is called **thorough respect**.

Definition 4.17 (see Figure 15). *Let $\mathcal{U} = \mathcal{U}^0 \cup \mathcal{U}^1 \cup \mathcal{U}^2$ be a framed collection. For $0 \leq k < l \leq 2$, suppose that for each $U^l \in \mathcal{U}^l$ there is at most one set $F \in \mathcal{U}^k$ such that*

$$U^l \cap F^- \neq \emptyset. \quad (4.17.1)$$

In this event, suppose further that

$$U^l \subset F \quad (4.17.2)$$

*and U^l intersects F respectfully. When this occurs for a single $l > k$, we say that \mathcal{U}^l **thoroughly respects** \mathcal{U}^k . When this occurs for all $l > k$, we say that \mathcal{U}^k is **thoroughly respectful**.*

The main result of this subsection asserts that the cover of Lemma 4.1 can be chosen to have a thoroughly respectful 0-stratum. To establish this, we will modify some of the framed sets as follows.

Definition 4.18 (see Figure 16). *Let F and $p_F : F \rightarrow \mathbb{R}^k$ be as in Lemma 3.2. Given a half space $H \subset \mathbb{R}^k$ so that $H \cap p_F(F)$ is diffeomorphic to an open ball, we call*

$$K \equiv p_F^{-1}(H \cap p_F(F))$$

*a **framed half space**.*

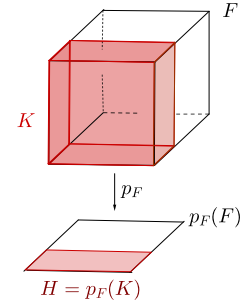

Figure 16. A framed half space

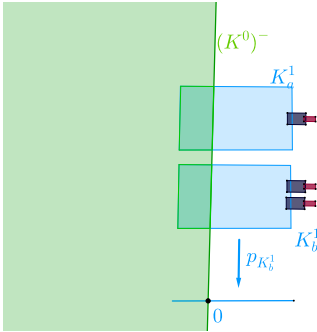

Figure 17. This depicts how elements K_a^1 and K_b^1 of \mathcal{K}^1 intersect an element K^0 of \mathcal{K}^0 , as described in Lemma 4.19.

Lemma 4.19. *There is a framed cover $\mathcal{K} = \mathcal{K}^0 \cup \mathcal{K}^1 \cup \mathcal{K}^2$ that has all of the properties of the cover \mathcal{Z} of Lemma 4.1. In addition, \mathcal{K}^0 is thoroughly respectful, and*

1. *For each $F \in \mathcal{K}^1$, there is a $\beta_F > 0$ so that*

$$p_F(\bar{F}(\beta)) = [0, \beta_F]. \quad (4.19.1)$$

2. *Set $\Omega_0 := \cup \mathcal{K}^0$. If $F(\beta_F), \tilde{F}(\tilde{\beta}_F) \in \mathcal{K}^1$, $F \cap \Omega_0^- \neq \emptyset$, and $\tilde{F} \cap \Omega_0^- = \emptyset$, then*

$$\beta_F \geq 100\tilde{\beta}_F, \quad (4.19.2)$$

and if (Z, r_Z) is the element of \mathcal{K}^0 so that $F \cap Z \neq \emptyset$, then

$$p_F(\bar{F} \cap \bar{Z}^-) = \{0\}, \quad (4.19.3)$$

and p_F is lined up with r_Z .

3. If $F_l \in \mathcal{K}^1$ and $\overline{F_l(\beta_l)} \cap \Omega_0^- \neq \emptyset$, then

$$F_l(\beta_l) \cap \bigcup_{i=1}^{l-1} F_i(\beta_i^+) = \emptyset \quad (4.19.4)$$

and

$$p_{F_l}^{-1} \left[0, \frac{\beta_l}{2} \right] \cap \bigcup_{i=l+1}^L F_i(\beta_i^+) = \emptyset, \quad (4.19.5)$$

where $\mathcal{K}^1 = \{F_i(\beta_i^+)\}_{i=1}^L$.

Proof. For δ_1 and δ_2 as in (4.5.2), let

$$\begin{aligned} X^0 &= \{p \in X \mid p \text{ is not } (1, \delta_1)\text{-strained}\}, \\ X^1 &= \{p \in X \mid p \text{ is } (1, \delta_1)\text{-strained, but not } (2, \delta_2)\text{-strained}\}, \\ X^2 &= \{p \in X \mid p \text{ is } (2, \delta_2)\text{-strained, but not } (4, \delta)\text{-strained}\}, \text{ and} \\ X^4 &= \{p \in X \mid p \text{ is } (4, \delta)\text{-strained}\}. \end{aligned} \quad (4.19.6)$$

Let

$$\mathcal{Z} = \mathcal{Z}^0 \cup \mathcal{Z}^1 \cup \mathcal{Z}^2$$

be the framed cover of Lemma 4.1, and set

$$\mathcal{K}^0 \equiv \mathcal{Z}^0.$$

For $l \in \{1, 2\}$, when we construct $\mathcal{K}^l \equiv \{F_i^l(\beta_i^l)\}$, we require that the β_i^l be small enough so that (4.17.1) and (4.17.2) hold with $k = 0$. This is possible because Inequality (3.2.1) allows us to choose our framed sets to be as small as we please, and we have a fixed collection, \mathcal{Z}^0 , whose closures are disjoint.

To each $Z \in \mathcal{Z}^0$ and each $x \in \partial \bar{Z}^- \cap X^l$, we apply Corollary 3.15. This yields a collection of framed half spaces $F^l_{\text{near}} \equiv \{K^l_{\text{near},i}(\beta^l_{\text{near},i})\}$ that cover $X^l \cap \partial \Omega_0^-$, and satisfy (3.15.1). It follows that if $F \in \mathcal{K}^l_{\text{near}}$ intersects $Z \in \mathcal{Z}^0$, then r_Z and p_F are lined up.

For each $F \in \mathcal{K}^1_{\text{near}}$, we post compose with an appropriate isometry to arrange that $p_K(\bar{F}) = [0, \beta_F]$. In particular, $\mathcal{K}^1_{\text{near}}$ then satisfies (4.19.1). Since our 1-framed sets respect the radial functions of our 0-framed sets, we can also arrange for (4.19.3) to hold.

Our collection of half spaces now satisfies Definition 4.17 but is unlikely to cover $(X^1 \cup X^2) \setminus \Omega^0$. To remedy this, we repeat the procedure of the proof of Lemma 4.1 with the extra requirement that if the additional framed sets are $F_j^l(\beta_j^l)$, then

$$\max_j \{\beta_j^l\} \leq \frac{1}{100} \min_i \{\beta^l_{\text{near},i}\}. \quad (4.19.7)$$

Call the resulting framed cover $\mathcal{K} = \mathcal{K}^0 \cup \mathcal{K}^1 \cup \mathcal{K}^2$. Then \mathcal{K}^0 is thoroughly respectful and disjoint, and \mathcal{K}^1 and \mathcal{K}^2 are fiber swallowing, vertically separated, and κ -lined up. Inequality (4.19.7) ensures that (4.19.2) holds. Thus Part 2 holds. To prove Part 1, for each $F \in \mathcal{K}^1$, we post compose p_F with an appropriate isometry to arrange that $p_F(\bar{F}) = [0, \beta_F]$ for all $F \in \mathcal{K}^1$.

To prove (4.19.4), order $\mathcal{K}^1 := \{F_j(\beta_j)\}_j$ so that if $i \leq l$, then $\beta_i \geq \beta_l$. Suppose that $\overline{F_l(\beta_l)} \cap \Omega_0^- \neq \emptyset$ and $F_l(\beta_l) \cap F_i(\beta_i^+) \neq \emptyset$ for some $i \leq l-1$. Since $\beta_i \geq \beta_l$, it follows from Part 2 that $\overline{F_i(\beta_i)} \cap \Omega_0^- \neq \emptyset$. Since \mathcal{K}^0 is thoroughly respectful, it follows that there are $Z_l, Z_i \subset \mathcal{K}^0$ so that

$$F_l(\beta_l) \subset Z_l \text{ and } F_i(\beta_i) \subset Z_i. \quad (4.19.8)$$

Taking into account that $F_l(\beta_l) \cap F_i(\beta_i^+) \neq \emptyset$ and that the collection \mathcal{K}^0 has pairwise disjoint closures, it follows, after a possible further restriction on the β_j , that $Z_l = Z_i =: Z$. From the thorough respect condition, we conclude

$$F_i(\beta_i) \cup F_l(\beta_l) \subset Z.$$

Via Part 2, we have that on their common domains, r_Z, p_{F_i} , and p_{F_l} are lined up, and

$$p_{F_i}(\partial \bar{Z}^-) = p_{F_l}(\partial \bar{Z}^-) = 0.$$

This, together with the fiber swallowing condition, Equation (4.19.1), and the fact that p_{F_l} and p_{F_i} are κ -lined up, \varkappa -almost Riemannian submersions gives us

$$F_l\left(\beta_l^-, \frac{\beta_l}{2}\right) \subset F_i(\beta_i).$$

Combining this with (3.14), we see that we may delete such a F_l from our collection without losing the property that $\mathcal{K}^0 \cup \mathcal{K}^1$ covers X^1 . After performing these deletions, \mathcal{K}^1 satisfies (4.19.4). Via a similar argument that also exploits (4.19.2), we can remove redundant sets from \mathcal{K}^1 until (4.19.5) holds. \square

Throughout the remainder of the paper, we set

$$\Omega_0 := \cup \mathcal{K}^0.$$

We call \mathcal{K}^0 and \mathcal{K}^1 the natural 0 and 1 strata of X .

5. TOOLS TO MANIPULATE A FRAMED COVER

In this section, we develop tools used throughout the remainder of the paper to prove Limit Lemma G. In Subsection 5.1, we introduce **artificially framed sets** which we later use to construct a cover with the disjointness properties required by Limit Lemma G (see Figures 5 and 6). In Subsection 5.6, we develop tools to deform framed covers to respectful framed covers, and in Subsection 5.11, we establish some tools to verify disjointness.

5.1. Artificially Framed Sets. In this subsection, we introduce **artificially framed sets**. They are the main tool that we will use to make the framed cover of Limit Lemma G have the required disjointness properties.

Definition 5.2. *Let $(F(\beta, \nu), p_F)$ be an l -framed set. Let $q_S : F(\beta, \nu) \rightarrow \mathbb{R}^l$ be a submersion that is κ -lined up with p_F . Let $U_S \subset q_S(F(\beta, \nu)) \subset \mathbb{R}^l$ be an open set that is diffeomorphic to an open ball, and let $\tilde{\nu}$ be a number in $(0, \nu]$. We say that (S, q_S, U_S) is **artificially l -framed subordinate to (F, p_F)** provided*

$$S = q_S^{-1}(U_S) \cap F(\beta, \tilde{\nu}). \quad (5.2.1)$$

A framed half space is an example of an artificially framed set (see Definition 4.18 and Figure 16). In the previous definition, the artificially framed set S has the same framing dimension as (F, p_F) . We also need this notion for smaller framing dimensions. This is accomplished via the following definition.

Definition 5.3 (see Figures 5 and 20). *Let (F, p_F) be an l -framed set and let (S, q_S, U_S) be an artificially l -framed subordinate to (F, p_F) . Let $L_S \subset \mathbb{R}^l$ be a k -dimensional affine subspace and $\mathfrak{s} \subset L_S$ diffeomorphic to an open ball. If U_S has the form*

$$U_S = \{w + u \mid w \in \mathfrak{s}, u \perp \mathfrak{s}, \text{ and } |u| < b_S\}$$

for some $b_S > 0$, then we say that S (or $(S, q_S, U_S, \mathfrak{s})$) is **artificially k -framed**.

Let $\pi_{\mathfrak{s}} : \mathbb{R}^l \rightarrow L_S = \mathbb{R}^k$ be orthogonal projection. To justify the name artificially k -framed, we note that after setting

$$p_S := \pi_{\mathfrak{s}} \circ q_S, \tag{5.3.1}$$

(S, p_S) becomes a trivial vector bundle. Thus an artificially k -framed set (S, q_S, \mathfrak{s}) is k -framed provided it has a fiber exhaustion function. This is a consequence of the next result.

Proposition 5.4 (see Figure 18 for the Euclidean analog). *Let (F, p_F, r_F) be a l -framed set. Suppose that $(S, q_S, U_S, \mathfrak{s})$ is an artificially k -framed set that is subordinate to F with $S = q_S^{-1}(U_S) \cap F(\beta, \tilde{\nu})$, and let*

$$r_{\mathfrak{s}} : U_S \rightarrow [a, b] \subset \mathbb{R}$$

be a fiber exhaustion function for $\pi_{\mathfrak{s}} : \mathbb{R}^l \rightarrow L_S$.

Given any $\tilde{a}, \tilde{b} \in (a, b)$ and $c \in (0, \tilde{\nu})$, there is a fiber exhaustion function $r : S \rightarrow \mathbb{R}$ for $p_S := \pi_{\mathfrak{s}} \circ q_S$ so that for all $\xi \in [\tilde{a}, \tilde{b}]$,

$$q_S^{-1}(r_{\mathfrak{s}}^{-1}(\xi)) \cap r_S^{-1}[0, c] \subset r^{-1}(d)$$

for some $d \in \mathbb{R}$.

This follows by combining the trivialization for S with the corresponding result for Euclidean space, which we state here.

Lemma 5.5. *Let $q : \mathbb{R}^n = \mathbb{R}^l \times \mathbb{R}^{n-l} \rightarrow \mathbb{R}^l$ and*

$$\pi : \mathbb{R}^l = \mathbb{R}^k \times \mathbb{R}^{l-k} \rightarrow \mathbb{R}^k$$

be orthogonal projections, and let

$$r_k : \mathbb{R}^k \times \mathbb{R}^{l-k} \rightarrow [0, \infty)$$

be any fiber exhaustion function for π . Given any $0 < \tilde{a} < \tilde{b}$ and any $c > 0$ there is a fiber exhaustion function $r : \mathbb{R}^n \rightarrow \mathbb{R}$ for $p := \pi \circ q : \mathbb{R}^n = \mathbb{R}^k \times \mathbb{R}^{l-k} \times \mathbb{R}^{n-l} \rightarrow \mathbb{R}^k$ so that for all $\xi \in [\tilde{a}, \tilde{b}]$,

$$q^{-1}(r_k^{-1}(\xi)) \cap B^{n-l}(0, c) \subset r^{-1}(d)$$

for some $d \in \mathbb{R}$.

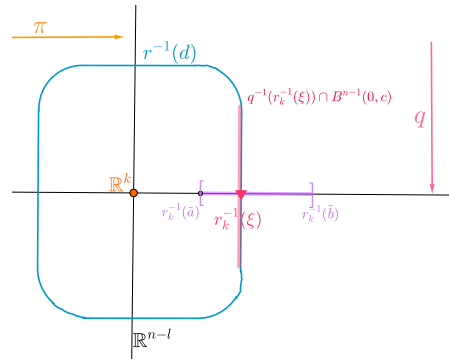

Figure 18. Depicts Lemma 5.5 in the case when $k = 0$.

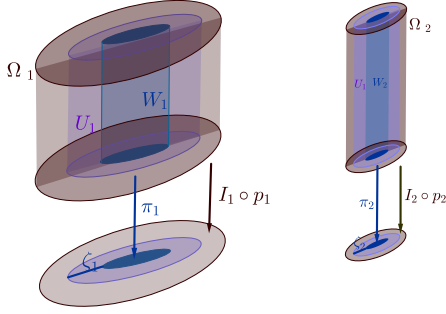

Figure 19. Suppose that π_i and p_i are κ_i -lined up, and we want to glue the submersions as in the Submersion Deformation Lemma. Since $\frac{\text{Diam}(\Omega_1)}{\zeta_1}$ is much smaller than $\frac{\text{Diam}(\Omega_2)}{\zeta_2}$, κ_1 is allowed to be much larger than κ_2 .

5.6. Creating Respect. In this subsection, we outline the tools that will be used to deform a framed cover to a respectful framed cover. The first step is to glue together submersions of neighboring framed sets. This is possible because of the κ -lined up condition and the following lemma, which is mostly a consequence of Lemma 7.4 in [35].

Lemma 5.7 (Submersion Deformation Lemma). *For every $C > 1$ and $n \in \mathbb{N}$, there are $\kappa_0, \varkappa_0 > 0$ with the following property. Let M be a Riemannian n -manifold. Let $W \subset U \subset \Omega \subset M$ be three nonempty, open, precompact sets so that*

$$\text{diam}(\Omega) \leq C \text{dist}(W, \Omega \setminus U), \quad (5.7.1)$$

and let $p, \pi : \Omega \rightarrow \mathbb{R}^k$ be κ -lined up, \varkappa -almost Riemannian submersions for some $\kappa \in (0, \kappa_0)$ and $\varkappa \in (0, \varkappa_0)$. Then there is an isometry $I : \mathbb{R}^k \rightarrow \mathbb{R}^k$ and a submersion $\psi : \Omega \rightarrow \mathbb{R}^k$ with the following properties.

1. $\psi|_W = \pi$ and $\psi|_{\Omega \setminus U} = I \circ p$.
2. $|d\psi - d\pi| < \kappa(1 + 2C)$ and $|d\psi - d(I \circ p)| < \kappa(1 + 2C)$.
3. For $\varkappa_1 := \varkappa + \kappa(1 + 2C)$, ψ is a \varkappa_1 -almost Riemannian submersion.
4. If F is a subset of Ω with $\pi_k \circ I \circ p|_F = \pi_k \circ \pi|_F$, then $\pi_k \circ \psi|_F = \pi_k \circ I \circ p|_F = \pi_k \circ \pi|_F$, where $\pi_k : \mathbb{R}^l \rightarrow \mathbb{R}^k$ is projection to the first k -factors.

Proof. We will show that for

$$\zeta := \text{dist}(W, \Omega \setminus U),$$

there is an isometry $I : \mathbb{R}^k \rightarrow \mathbb{R}^k$ so that

$$|d\pi - d(I \circ p)| + 2 \frac{|\pi - I \circ p|_{C^0}}{\zeta} < \kappa(1 + 2C). \quad (5.7.2)$$

Except for Part 3, the result follows from this by applying Lemma 7.4 in [35].

To prove (5.7.2), choose a point $w \in W$ and an isometry $I : \mathbb{R}^k \rightarrow \mathbb{R}^k$ so that

$$|d\pi - d(I \circ p)| < \kappa \text{ and } I \circ p(w) = \pi(w).$$

Then

$$|\pi - I \circ p|_{C^0} < \kappa \text{diam}(\Omega) \leq \kappa C \zeta,$$

so

$$\begin{aligned} |d\pi - d(I \circ p)| + 2 \frac{|\pi - I \circ p|_{C^0}}{\zeta} &< \kappa + 2 \frac{\kappa C \zeta}{\zeta} \\ &= \kappa(1 + 2C). \end{aligned} \quad (5.7.3)$$

With the exception of Part 3, this completes the proof. \square

Part 3 of the Submersion Deformation Lemma asserts that ψ is $\varkappa_1 = \varkappa + \kappa(1 + 2C)$ -almost Riemannian. Since π is \varkappa -almost Riemannian, this follows by combining the next lemma with the assertion of Part 2 of the Submersion Deformation Lemma that $|d\psi - d\pi| < \kappa(1 + 2C)$.

Lemma 5.8. *Let π be a \varkappa -almost Riemannian submersion. Suppose ψ is a C^1 -map that satisfies*

$$|d\pi - d\psi| < \delta.$$

Then ψ is a $(\varkappa + \delta)$ -almost Riemannian submersion, provided \varkappa and δ are sufficiently small.

Proof. For any unit w ,

$$|d\psi(w)| \leq |d\pi(w)| + \delta \leq 1 + \varkappa + \delta. \quad (5.8.1)$$

If x is π -horizontal and unit, then

$$||d\psi(x)| - 1| \leq ||d\pi(x)| - 1| + \delta < \varkappa + \delta. \quad (5.8.2)$$

So ψ is a submersion. Let x^h be the ψ -horizontal component of x . Then

$$|d\psi(x^h)| = |d\psi(x)|,$$

so by (5.8.2),

$$||d\psi(x^h)| - 1| \leq \delta + \varkappa.$$

Since $|x^h| \leq |x| = 1$, this gives us

$$\begin{aligned} |x^h| (1 - \delta - \varkappa) &\leq 1 - \delta - \varkappa \\ &\leq |d\psi(x^h)| \\ &\leq |x^h| (1 + \varkappa + \delta), \text{ by (5.8.1)}. \end{aligned}$$

Since the map $x \mapsto x^h$ is an isomorphism, the result follows. \square

After using the Submersion Deformation Lemma to line up our submersions, we will create fiber exhaustion functions so that (0.0.5) is satisfied. We accomplish this via the next two results.

Proposition 5.9. *Let M be a Riemannian n -manifold. Let $W \subset U \subset \Omega \subset M$ be three nonempty, open sets. Let $\lambda : \Omega \rightarrow [0, 1]$ be C^∞ so that $\lambda|_W = 0$ and $\lambda|_{\Omega \setminus U} = 1$. Let $p, \pi : \Omega \rightarrow \mathbb{R}$ be submersions so that $\pi \geq p$, $\angle(\nabla p, \nabla \pi) \leq \frac{11}{12}\pi$, and wherever $\nabla \lambda \neq 0$, $\max\{\angle(\nabla p, \nabla \lambda), \angle(\nabla \pi, \nabla \lambda)\} \leq \frac{11}{12}\pi$. Then there is a submersion $\psi : \Omega \rightarrow \mathbb{R}$ such that*

$$\psi|_W = p \text{ and } \psi|_{\Omega \setminus U} = \pi. \quad (5.9.1)$$

Proof. Set

$$\psi = (1 - \lambda)p + \lambda\pi.$$

Then ψ satisfies (5.9.1) and

$$\nabla \psi = (1 - \lambda)\nabla p + \lambda\nabla \pi + (\pi - p)\nabla \lambda.$$

Since all three summands on the right lie in a half space, $\nabla \psi$ is nowhere 0, and ψ is a submersion. \square

Lemma 5.10. *For $l, h \in \{0, 1, 2\}$ with $l < h$, let $(L, q_L, U_L, \mathfrak{l})$ and $(H, q_H, U_H, \mathfrak{h})$ be artificially l -framed and h -framed sets, respectively, which are subordinate to k -framed sets, where $h \leq k \leq 2$.*

Suppose that q_L and q_H are lined up on $(H \setminus H^-) \cap L$, and for $p_H := \pi_{\mathfrak{h}} \circ q_H$,

$$p_H^{-1}(p_H(H \cap L)) \Subset L \quad (5.10.1)$$

and

$$\mathfrak{l} \cap \bar{U}_H = \emptyset \quad (\text{see Figure 20}). \quad (5.10.2)$$

Then

1. The pair $\{(L, p_L), (H, p_H)\}$ satisfies the fiber containment condition (0.0.4).
2. There is a choice of fiber exhaustion function r_L for L so that $\{L, H\}$ is respectful.
3. The fiber exhaustion function r_L for L can be constructed as follows: Given any fiber exhaustion function $r_{\mathfrak{l}}$ for $\pi_{\mathfrak{l}} : U_L \rightarrow \text{span}(\mathfrak{l})$ whose

$$\text{gradient is horizontal for } \pi_{\mathfrak{h}} : U_H \rightarrow \text{span}(\mathfrak{h}) \quad (5.10.3)$$

on $q_H(H \cap L)$, any of the corresponding fiber exhaustion functions for L constructed from $r_{\mathfrak{l}}$ via Proposition 5.4 make $\{L, H\}$ respectful.

4. When $h = 2$, (5.10.3) is satisfied for all fiber exhaustion functions $r_{\mathfrak{l}}$ for $\pi_{\mathfrak{l}} : U_L \rightarrow \text{span}(\mathfrak{l})$.

Proof. For $x \in (H \setminus H^-) \cap L$, Hypothesis (5.10.1) together with $p_H = \pi_{\mathfrak{h}} \circ q_H$ gives us

$$q_H^{-1}(q_H(x)) \subset p_H^{-1}(p_H(x)) \subset L.$$

Combining this with the fact that q_H is lined up with q_L gives us

$$q_H^{-1}(q_H(x)) \subset q_L^{-1}(q_L(x)). \quad (5.10.4)$$

For each of the three cases $(l, h) \in \{(0, 1), (0, 2), (1, 2)\}$, we must show that (0.0.4) and (0.0.5) hold for $\{L, H\}$. In the two cases when $l = 0$, p_L has only one four-dimensional fiber, $p_L^{-1}(\mathfrak{l}) = L$, so the fiber containment condition (0.0.4) follows from Hypothesis (5.10.1). When $(l, h) = (1, 2)$, we have that $p_H = q_H$. Together with (5.10.4), this gives us that for all $x \in (H \setminus H^-) \cap L$,

$$p_H^{-1}(p_H(x)) = q_H^{-1}(q_H(x)) \subset q_L^{-1}(q_L(x)) \subset p_L^{-1}(p_L(x)). \quad (5.10.5)$$

So (0.0.4) holds in all three cases.

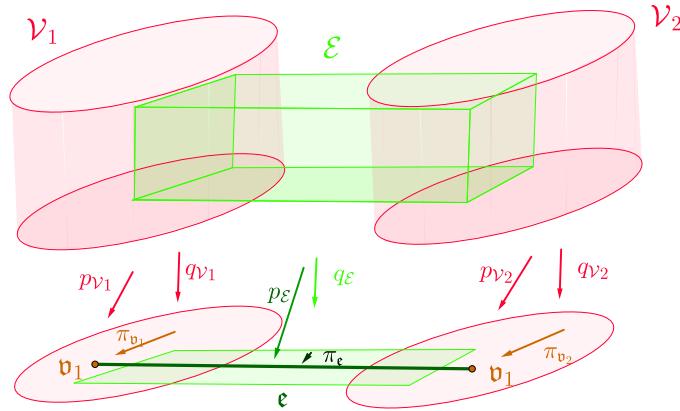

Figure 20. The green box \mathcal{E} is artificially 1-framed. The red cylinders, \mathcal{V}_1 and \mathcal{V}_2 , are artificially 0-framed. The red cylinders are taller than the green box, so (5.10.1) is satisfied. The vertices \mathbf{v}_1 and \mathbf{v}_2 are disjoint from the green rectangle, so (5.10.2) is satisfied.

To establish (0.0.5), suppose that L is subordinate to the 2-framed set $(F(\beta, \nu), p_F)$ and has the form

$$L = q_L^{-1}(U_L) \cap F(\beta, \tilde{\nu}) \text{ for } \tilde{\nu} < \nu.$$

Together with (5.10.1), this implies that there is a $c < \tilde{\nu}$ so that

$$q_H^{-1}(q_H(H \cap L)) \subset p_H^{-1}(p_H(H \cap L)) \subset F(\beta, c). \quad (5.10.6)$$

Suppose, for the moment, that we have a fiber exhaustion function r_l for (U_L, π_l) as in Part 3. Use r_l and (5.10.2) to apply Proposition 5.4 and conclude that there is a fiber exhaustion function r_L for (L, p_L) so that for all $x \in H \cap L$, there is a d so that

$$q_L^{-1}(r_l^{-1}(r_l(q_H(x)))) \cap F(\beta, c) \subset r^{-1}(d). \quad (5.10.7)$$

Since ∇r_l is horizontal for $\pi_l : U_L \rightarrow \text{span}(\mathfrak{h})$ on $q_H(H \cap L)$, for all $x \in H \cap L$,

$$\pi_{\mathfrak{h}}^{-1}(\pi_{\mathfrak{h}}(q_H(x))) \subset r_l^{-1}(r_l(q_H(x))).$$

Combining this with (5.10.4), (5.10.7), and $p_H = \pi_{\mathfrak{h}} \circ q_H$, we get that for all $x \in (H \setminus H^-) \cap L$,

$$p_H^{-1}(p_H(x)) = q_H^{-1}(\pi_{\mathfrak{h}}^{-1}(\pi_{\mathfrak{h}}(q_H(x)))) \cap F(\beta, c) \subset r^{-1}(d),$$

and (0.0.5) holds, provided we can show that in each of our three cases $(l, h) \in \{(0, 1), (0, 2), (1, 2)\}$, there is a fiber exhaustion function r_l for (U_L, π_l) as in Part 3. When $h = 2$, $\pi_{\mathfrak{h}} = \text{id}_{\mathbb{R}^2}$, so any fiber exhaustion function for π_l is horizontal for $\pi_{\mathfrak{h}}$. When $h = 1$, we construct r_l by combining (5.10.2) and Proposition 5.9. \square

5.11. Quantitative Fiber Disjointness. In this subsection, we establish two tools to verify the disjoint property of our ultimate framed cover. The first says that just as a Riemannian submersion has equidistant fibers, an almost Riemannian submersion has almost equidistant fibers.

Proposition 5.12. *Let*

$$\pi : M \rightarrow B$$

be a \varkappa -almost Riemannian submersion. For all $b_1, b_2 \in B$ and $x \in \pi^{-1}(b_1)$,

$$|\text{dist}(x, \pi^{-1}(b_2)) - \text{dist}(b_1, b_2)| \leq \varkappa \text{dist}(b_1, b_2). \quad (5.12.1)$$

Proof. Let γ be a minimal geodesic from x to $\pi^{-1}(b_2)$. Then

$$\begin{aligned} \text{dist}(x, \pi^{-1}(b_2)) &= \text{len}(\gamma) \\ &\geq (1 - \varkappa) \text{len}(\pi \circ \gamma) \\ &\geq (1 - \varkappa) \text{dist}(b_1, b_2). \end{aligned}$$

To prove the opposite inequality, let $\gamma : [0, l] \rightarrow B$ be a minimal geodesic from b_1 to b_2 with $|\gamma'(t)| \equiv 1$. Let $\tilde{\gamma}$ be a horizontal lift of γ starting at x . Then $\tilde{\gamma}(l) \in \pi^{-1}(b_2)$. Since $\tilde{\gamma}$ is everywhere horizontal,

$$|\tilde{\gamma}'(t)| - 1 \leq \varkappa,$$

so

$$|\text{len}(\tilde{\gamma}) - \text{len}(\gamma)| \leq \varkappa \text{len}(\gamma) = \varkappa \text{dist}(b_1, b_2).$$

Thus

$$\begin{aligned} \text{dist}(x, \pi^{-1}(b_2)) &\leq \text{len}(\tilde{\gamma}) \\ &\leq \text{len}(\gamma) + \varkappa \text{len}(\gamma) \\ &= (1 + \varkappa) \text{dist}(b_1, b_2), \end{aligned}$$

as desired. \square

Lemma 5.13. *For $i = 1, 2$, let $(F_i(5\beta_i), p_i)$ be (l, \varkappa) -framed sets with $\beta_2 \geq \beta_1$. For all $b_1, b_2 \in p_1(F_1(\beta_1) \cap F_2(\beta_2))$ and $x_1 \in p_1^{-1}(b_1) \cap F_1(\beta_1)$,*

1.

$$\text{dist}(x_1, p_2^{-1}(b_2) \cap F_2(5\beta)) \leq (1 + \varkappa) \text{dist}(b_1, b_2). \quad (5.13.1)$$

2. *Suppose that $\{(F_1(5\beta_1), p_1), (F_2(5\beta_2), p_2)\}$ is κ -lined up and fiber swallowing. If $I : \mathbb{R}^l \rightarrow \mathbb{R}^l$ is an isometry so that*

$$p_1(x_1) = I \circ p_2(x_1) \text{ and } |dp_1 - I \circ dp_2| < \kappa, \quad (5.13.2)$$

then for all $\tilde{x}_1 \in p_1^{-1}(b_1) \cap F_1(\beta_1)$,

$$|\text{dist}(b_1, b_2) - \text{dist}(\tilde{x}_1, (I \circ p_2)^{-1}(b_2) \cap F_2(5\beta_2))| \leq \varkappa \text{dist}(b_1, b_2) + 3\kappa\beta_1. \quad (5.13.3)$$

Proof. Let $\gamma : [0, 2l] \rightarrow B$ be a minimal geodesic from b_1 to b_2 with $|\gamma'(t)| \equiv 1$. Let $\tilde{\gamma}_1$ be a p_1 -horizontal lift of $\gamma|_{[0, l]}$ starting at x_1 , and let $\tilde{\gamma}_2$ be a p_2 -horizontal lift of $\gamma|_{[l, 2l]}$ starting at $\tilde{\gamma}_1(l)$. Set

$$\tilde{\gamma} = \tilde{\gamma}_1 * \tilde{\gamma}_2.$$

Then $\tilde{\gamma}(2l) \in p_2^{-1}(b_2) \cap F_2(5\beta)$. Since $\tilde{\gamma}_i$ is everywhere p_i -horizontal,

$$||\tilde{\gamma}'(t)| - 1| \leq \varkappa,$$

so

$$|\text{len}(\tilde{\gamma}) - \text{len}(\gamma)| \leq \varkappa \text{len}(\gamma) = \varkappa \text{dist}(b_1, b_2).$$

Thus

$$\begin{aligned} \text{dist}(x_1, p_2^{-1}(b_2) \cap F_2(5\beta)) &\leq \text{len}(\tilde{\gamma}) \\ &\leq \text{len}(\gamma) + \varkappa \text{len}(\gamma) \\ &= (1 + \varkappa) \text{dist}(b_1, b_2), \end{aligned}$$

as desired.

To prove Part 2, let $\tilde{b}_1 := I \circ p_2(\tilde{x}_1)$. By (5.13.2),

$$\text{dist}(b_1, \tilde{b}_1) = \text{dist}(p_1(\tilde{x}_1), I \circ p_2(\tilde{x}_1)) < 2\kappa\beta_1^+. \quad (5.13.4)$$

Applying Proposition 5.12 to \tilde{x}_1 and $I \circ p_2(b_2)$, we get

$$\begin{aligned} \text{dist}(\tilde{b}_1, b_2) &\leq \text{dist}(\tilde{x}_1, (I \circ p_2)^{-1}(b_2) \cap F_2(5\beta_1)) + \varkappa \text{dist}(\tilde{b}_1, b_2) \\ &\leq \text{dist}(\tilde{x}_1, (I \circ p_2)^{-1}(b_2) \cap F_2(5\beta_1)) + \varkappa \left(\text{dist}(b_1, b_2) + \text{dist}(b_1, \tilde{b}_1) \right) \\ &\leq \text{dist}(\tilde{x}_1, (I \circ p_2)^{-1}(b_2) \cap F_2(5\beta_1)) + \varkappa \left(\text{dist}(b_1, b_2) + 2\kappa\beta_1^+ \right), \end{aligned}$$

where we used (5.13.4) to get the last term in the last inequality. The previous two inequalities give us

$$\begin{aligned} \text{dist}(b_1, b_2) &\leq \text{dist}(b_1, \tilde{b}_1) + \text{dist}(\tilde{b}_1, b_2) \\ &\leq 2\kappa\beta_1^+ + \text{dist}(\tilde{x}_1, (I \circ p_2)^{-1}(b_2) \cap F_2(5\beta_1)) + \varkappa \text{dist}(b_1, b_2) + 2\varkappa\kappa\beta_1^+ \\ &\leq 3\kappa\beta_1 + \text{dist}(\tilde{x}_1, (I \circ p_2)^{-1}(b_2) \cap F_2(5\beta_1)) + \varkappa \text{dist}(b_1, b_2), \end{aligned}$$

which together with Part 1 gives us Part 2. \square

An application of the previous result gives us the following additional tool to create respectful framed collections.

Proposition 5.14. *Let $\{(A_i^+, q_i)\}_{i=1}^L$ be a family of artificially \varkappa -framed sets that are lined up and subordinate to a single 2-framed set $(F(\beta), p_F)$. If each q_i is κ -lined up with p_F , then*

1. *There is a submersion*

$$P : \cup_i A_i^+ \longrightarrow \mathbb{R}^2$$

so that for all i , P is lined up with q_i .

2. *If there is a $c > 0$ so that*

$$\min_i \{ \text{dist}(A_i^-, A_i^+ \setminus A_i) \} \geq c\beta \tag{5.14.1}$$

and κ and \varkappa are sufficiently small compared with c , then for all $x \in A_i^-$,

$$q_i^{-1}(q_i(x)) = P^{-1}(P(x)).$$

Proof. To prove Part 1, we argue by induction on i . For $i = 1$ we take $P_1 = q_1$. By hypothesis, P_1 is lined up with all q_i . For $l \leq L$, assume there is a submersion

$$P_l : \cup_{i=1}^l A_i^+ \longrightarrow \mathbb{R}^2$$

that is lined up with all q_i . Since P_l is lined up with q_{l+1} , there is a diffeomorphism $I_{l+1} : \mathbb{R}^2 \rightarrow \mathbb{R}^2$ such that $P_l = I_{l+1} \circ q_{l+1}$ on $A_{l+1}^+ \cap (\cup_{i=1}^l A_i^+)$. Setting $P_{l+1} = P_l$ on $\cup_{i=1}^l A_i^+$ and $P_{l+1} = I_{l+1} \circ q_{l+1}$ on A_{l+1}^+ defines a submersion P_{l+1} on $\cup_{i=1}^{l+1} A_i^+$ that is lined up with all q_i and Part 1 is proven.

To prove Part 2, notice that since $P|_{A_i^+}$ is lined up with q_i ,

$$q_i^{-1}(q_i(x)) = q_i^{-1}(q_i(x)) \cap A_i^+ = P^{-1}(P(x)) \cap A_i^+ \subset P^{-1}(P(x)).$$

The opposite containment follows unless for $j \neq k$ there are $x_j \in A_j^-$ and $x_k \in A_k^-$ so that $P(x_j) = P(x_k)$. Since $P|_{A_i^+}$ is lined up with q_i , this does not happen if there is an A_l with $x_j, x_k \in A_l^+$. If there is no such A_l , then since P is κ -lined up with p_F , and κ and \varkappa are small compared with c , (5.13.3) and (5.14.1) give us that $P(x_j) \neq P(x_k)$. \square

Part 1. Covering the Natural 1-Stratum

Let

$$\mathcal{K} = \mathcal{K}^0 \cup \mathcal{K}^1 \cup \mathcal{K}^2$$

be the framed cover of Lemma 4.19. In this part, we replace \mathcal{K} by a framed cover

$$\mathcal{A} = \mathcal{A}^0 \cup \mathcal{A}^1 \cup \mathcal{A}^2$$

whose collections of 0- and 1-framed sets satisfy Part 1 of the conclusion of Limit Lemma G.

To make the 1-framed sets disjoint, we refine \mathcal{K}^1 to a collection that consists of artificially 0- and 1-framed sets. To accomplish this, for each 1-framed set (K, p_K) in \mathcal{K}^1 , we take a finite subset $\{\mathbf{v}_1, \dots, \mathbf{v}_n\} \subset p_K(K^+) \subset \mathbb{R}$ and consider it as the vertices of a graph. We then take disjoint open intervals N_i around the \mathbf{v}_i and declare the subsets $p_K^{-1}(N_i) \subset K$ to be artificially 0-framed. We also choose a family of disjoint intervals $\{J_i\}$ between the N_i so that $\{N_i\} \cup \{J_i\}$ covers $p_K(K)$ and declare the subsets $p_K^{-1}(J_i) \subset K$ to be artificially 1-framed. As the open cover $\{p_K^{-1}(N_i)\} \cup \{p_K^{-1}(J_i)\}$ comes from a graph, we call it a cograph (see Figures 21, 22, and 23). Our declaration that the $p_K^{-1}(N_i)$ are 0-framed then yields a disjoint collection \mathcal{A}^0 of 0-framed sets and a disjoint collection \mathcal{A}^1 of 1-framed sets. In this part, we exploit these ideas to prove

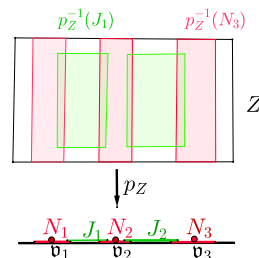

Figure 21. A graph cover and a local cograph

Covering Lemma 1. *Given $\kappa, \delta > 0$, there is a $\varkappa_0 > 0$ and for all $\varkappa \in (0, \varkappa_0)$, a respectful, \varkappa -framed cover $\mathcal{A} = \mathcal{A}^0 \cup \mathcal{A}^1 \cup \mathcal{A}^2$ of $X \setminus X_\delta^4$ with the following properties.*

1. *For $k = 0$ or 1 , the closures of the elements of \mathcal{A}^k are pairwise disjoint.*
2. *\mathcal{A}^2 is κ -lined up, vertically separated, and fiber swallowing.*

This part has three sections. In Section 6, we define cographs, explain why the existence of a certain type of cograph implies that Covering Lemma 1 holds, and assert in Lemma 6.11 that such a cograph exists. Section 7 develops the notion of geometric cograph, and in Section 8, we construct the cograph that proves Lemma 6.11.

6. COGRAPHS

In this section, we define cographs and discuss their basic properties. In Subsection 6.1, we define graph covers, which are collections of open subsets of \mathbb{R} that are precursors of cographs. In Subsection 6.3, we explain why the existence of a certain type of cograph implies that Covering Lemma 1 holds, and we assert in Lemma 6.11 that such a cograph exists.

6.1. Graph Covers. Recall that if \mathcal{T} is a simplicial complex, then we let \mathcal{T}_i be the collection of i -simplices of \mathcal{T} . We adopt the convention that all graphs \mathcal{T} whose vertex set \mathcal{T}_0 is a subset of \mathbb{R} have the property that vertices are connected by an edge only if they are consecutive. Let \mathcal{T} be such a graph. The starting point for the definition of cograph is a method to create a special type of open cover $\mathcal{O}(\mathcal{T})$ of $|\mathcal{T}|$.

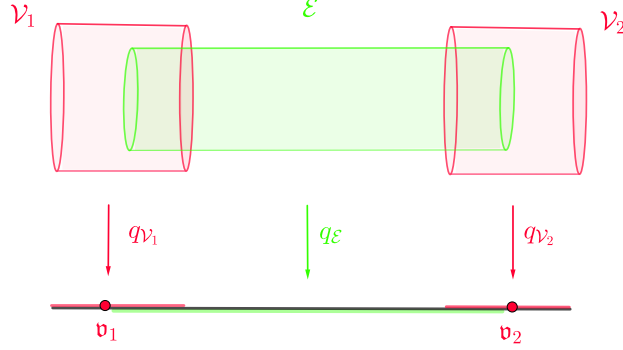

Figure 22. A cograph that corresponds to a graph with just two vertices v_1 and v_2 . The green cylinder is called a coedge. The red cylinders are called coverities. The 3 submersions $q_{\mathcal{V}_1}$, $q_{\mathcal{E}}$, and $q_{\mathcal{V}_2}$ are κ -lined up, so on this scale their fibers appear parallel.

Definition 6.2. Let $\mathcal{T} \subset \mathbb{R}$ be a graph and let $|\mathcal{T}| = \cup_{\sigma \in \mathcal{T}} |\sigma|$. A collection $\mathcal{O}(\mathcal{T})$ of open subsets of \mathbb{R} is called a **Graph Cover of \mathcal{T}** provided:

1. $\mathcal{O}(\mathcal{T})$ covers $|\mathcal{T}|$.
2. There is a one-to-one correspondence $g_{\mathcal{O}, \mathcal{T}} : \mathcal{T} \longrightarrow \mathcal{O}(\mathcal{T})$ so that for both $k = 0$ and $k = 1$, the collection $g_{\mathcal{O}, \mathcal{T}}(\mathcal{T}_k)$ consists of disjoint intervals.

We say that \mathcal{T} **generates** $\mathcal{O}(\mathcal{T})$.

6.3. What is a Cograph? In this subsection, we define the concept of a cograph. We start with the local notion.

Definition 6.4 (see Figures 21 and 22). Let F be a 1-framed set and \mathcal{V} and \mathcal{E} collections of pairwise disjoint open subsets of F^+ . Then

$$\mathcal{G} := \mathcal{V} \cup \mathcal{E}$$

is a **local cograph** subordinate to F provided

1. There is a graph \mathcal{T} with $p_F(F) \subset |\mathcal{T}| \subset p_F(F^+)$ with associated graph cover $\mathcal{O}(\mathcal{T})$.
2. There is a one-to-one correspondence between \mathcal{G} and a subset $K_{\mathcal{T}} \subset \mathcal{T}$. Each $S \in \mathcal{G}$ is generated by the corresponding $\mathfrak{s} \in K_{\mathcal{T}}$ as follows: There is a submersion $q_S : F \rightarrow \mathbb{R}$ so that $(S, q_S, U_S, \mathfrak{s})$ is an artificially k -framed set with $\mathfrak{s} \in \mathcal{T}_k \cap K_{\mathcal{T}}$, $U_S = g_{\mathcal{O}, \mathcal{T}}(\mathfrak{s})$, and

$$\begin{aligned} \text{if } \mathfrak{s} \in \mathcal{T}_0, & \text{ then } S = q_S^{-1}(U_S) \cap F(\beta, \beta^+) \in \mathcal{V}, \\ \text{if } \mathfrak{s} \in \mathcal{T}_1, & \text{ then } S = q_S^{-1}(U_S) \cap F(\beta, \beta) \in \mathcal{E}. \end{aligned} \tag{6.4.1}$$

For \mathcal{G} , \mathcal{T} , and $K_{\mathcal{T}}$ as above we say that $K_{\mathcal{T}}$ generates \mathcal{G} . In general, $K_{\mathcal{T}}$ will be a proper subset of \mathcal{T} . This is crucial to our plan to fit local cographs together with each other and with the natural 0 stratum (see e.g. Figure 24).

Definition 6.5 (see Figures 21, 22, and 23). Let $\mathcal{U} \equiv \{F_i(\beta_i)\}_{i=1}^l$ be a collection of $(1, \varkappa)$ -framed sets that are κ -lined up, vertically separated, and fiber swallowing. We say a collection

$$\mathcal{G} \equiv \mathcal{V} \cup \mathcal{E}$$

of open subsets of X is a **cograph subordinate to \mathcal{U}** provided

1. For each $i \in \{1, \dots, l\}$, there is a local cograph $\mathcal{G}_i \equiv \mathcal{V}_i \cup \mathcal{E}_i$ subordinate to F_i with $\mathcal{V} = \cup_i \mathcal{V}_i$, $\mathcal{E} = \cup_i \mathcal{E}_i$, and $\mathcal{G} = \cup_i \mathcal{G}_i$.
2. Each of the collections \mathcal{V} and \mathcal{E} is pairwise disjoint.
3. \mathcal{G} covers $\cup \mathcal{U}^-$.

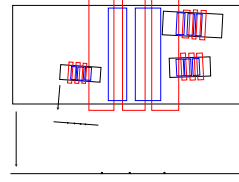

Figure 23. A cograph with corresponding local cographs

Definition 6.6. A cograph will be called **respectful** provided it is respectful as a framed collection (see Definition F). The elements of \mathcal{G} , \mathcal{V} , and \mathcal{E} are called *cosimplices*, *covertices*, and *coedges*, respectively.

Next we use the results of Subsection 5.6 to deform a cograph to a respectful cograph.

Proposition 6.7. Let $\mathcal{G} = \mathcal{V} \cup \mathcal{E}$ be a cograph. There are fiber exhaustion functions for the elements of \mathcal{V} so that \mathcal{G} is a respectful cograph.

Proof. Suppose that $V \in \mathcal{V}$ and $E \in \mathcal{E}$ intersect, and

$$q_V : V \longrightarrow \mathbb{R} \text{ and } q_E : E \longrightarrow \mathbb{R}$$

are the submersions that define V and E as artificially framed sets. Then q_V and q_E are ε -lined up on $V \cap E$ for some small $\varepsilon > 0$. So after post-composing q_E with an isometry I we get an almost Riemannian submersion $I \circ q_E : V \cap E^+ \longrightarrow \mathbb{R}$ whose gradients are within ε of those of q_V . Using this and Proposition 5.9, we get a deformation \tilde{q}_V of q_V that is lined up with q_E on $E \setminus E^-$. It follows from this and Lemma 5.10 that there is a fiber exhaustion function for V that makes the intersection of E and V respectful. \square

The gluing method of the previous proof also allows us to extend coedge submersions so that they respect the submersions of neighboring covertices.

Corollary 6.8. Let $\mathcal{G} = \mathcal{V} \cup \mathcal{E}$ be a cograph subordinate to \mathcal{U} . For $E \in \mathcal{E}$ let $\mathcal{V}(E)$ be the collection of covertices that intersect E , and let F_E be the element of \mathcal{U} so that E is subordinate to F_E . There is a submersion

$$q_E^{\text{ext}} : E \cup (\cup \mathcal{V}(E)) \cap F_E^+ \longrightarrow \mathbb{R}$$

so that

1. q_E^{ext} extends $q_E|_{E^-}$ and
2. For each $V \in \mathcal{V}(E)$, q_E^{ext} is lined up with q_V on $V \setminus E$.

Proof. For intersecting $V \in \mathcal{V}$ and $E \in \mathcal{E}$, let I and \tilde{q}_V be as in the proof of Proposition 6.7, and set

$$q_E^{\text{ext}} := \begin{cases} q_E & \text{on } E \\ I^{-1} \circ \tilde{q}_V & \text{on } (V \cup (E^+ \setminus E^-)) \cap F_E^+ \end{cases}$$

\square

We will see that the existence of the following type of cograph implies that Covering Lemma 1 holds.

Definition 6.9. Let $\mathcal{K} = \mathcal{K}^0 \cup \mathcal{K}^1 \cup \mathcal{K}^2$ be as in Lemma 4.19. Let $\Omega_0 := \cup \mathcal{K}^0$, and let $\mathcal{G} = \mathcal{V} \cup \mathcal{E}$ be a cograph subordinate to \mathcal{K}^1 . Then \mathcal{G} is **relative to** Ω_0 provided for all $F (\beta_F) \in \mathcal{K}^1$ with $F \cap \Omega_0 \neq \emptyset$,

1. If $(S, q_S) \in \mathcal{G}$ is an artificially framed set subordinate to F , then $q_S = p_F$.
2. $p_F \left(\bar{F} \cap (\bar{\Omega}^0)^- \right) = \{0\} \in [0, \beta_F] = p_F(F)$ generates a covertex of \mathcal{G} that is subordinate to F^+ . Let \mathcal{V}^0 be the collection of all such covertices.

Combining this definition with Part 2 of Lemma 4.19, we get

Corollary 6.10 (cf Figure 24). Let $\mathcal{G} = \mathcal{V} \cup \mathcal{E}$ be a cograph subordinate to \mathcal{K}^1 and relative to Ω_0 . Then

1. $\mathcal{V} \setminus \mathcal{V}^0$ is disjoint from \mathcal{K}^0 .
2. The collection \mathcal{E} of coedges of \mathcal{G} respects \mathcal{K}^0 .

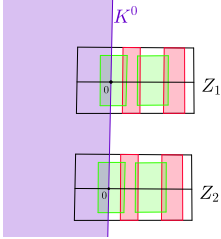

Figure 24. This depicts a cograph relative to Ω_0 with \mathcal{V} replaced with $\mathcal{V} \setminus \mathcal{V}^0$.

Combining Proposition 6.7 and Corollary 6.10, we see that Covering Lemma 1 holds provided we can construct a cograph $\mathcal{G} = \mathcal{V} \cup \mathcal{E}$ that is subordinate to \mathcal{K}^1 and relative to Ω_0 . Indeed, if $\mathcal{G} = \mathcal{V} \cup \mathcal{E}$ is the cograph, then the desired framed cover is

$$\mathcal{A}^0(\mathcal{G}) := \mathcal{K}^0 \cup (\mathcal{V} \setminus \mathcal{V}^0), \quad \mathcal{A}^1(\mathcal{G}) := \mathcal{E}, \quad \text{and} \quad \mathcal{A}^2 = \mathcal{K}^2. \quad (6.10.1)$$

Thus for the remainder of this part, our goal is to prove

Lemma 6.11. *There is a cograph \mathcal{G} that is subordinate to \mathcal{K}^1 and relative to Ω_0 .*

7. GEOMETRIC COGRAPHS

In this section, we impose geometric restrictions on our cographs. While Lemma 6.11 can probably be proven without these constraints, their presence will be crucial to our arguments in Part 2 of the paper. The main constraint is called η -geometric, where η is a positive number that will parameterize lower bounds for the distances between the vertices of the underlying graph, the horizontal thickness of the cosimplices, and the distances between the cosimplices of the same type. We define geometric graph covers and geometric cographs in Subsections 7.1 and 7.9, respectively.

7.1. Geometric Graph Covers. In this subsection, we define η -geometric graph covers and discuss their key properties.

Definition 7.2. Let \mathcal{T} be an abstract graph for which the vertex set \mathcal{T}_0 is a metric space. Given $\eta > 0$ and $\delta \in [0, \frac{1}{100}]$, we say that a graph \mathcal{T} is an **abstract** $(\eta, \delta\eta)$ -**geometric graph** provided its vertices are $\eta(1 - \delta)$ -separated and its edge lengths are all in $[\eta(1 - \delta), 2\eta(1 + \delta)]$. If $\mathcal{T}_0 \subset \mathbb{R}$, we drop the word *abstract* and simply say that \mathcal{T} is an $(\eta, \delta\eta)$ -geometric graph. If $\delta = 0$, we say that \mathcal{T} is η -**geometric**.

Definition 7.3 (see Figure 25). Let \mathcal{T} be an $(\eta, \delta\eta)$ -geometric graph. Let $\mathfrak{e} \in \mathcal{T}_1$ and let $\mathbf{v}_1, \mathbf{v}_2 \in \mathcal{T}_0$ be the boundary of \mathfrak{e} . For $\rho > 0$ set

$$\mathfrak{e}^{\rho\eta} = \mathfrak{e} \setminus \left(\overline{B(\mathbf{v}_1, 2\rho\eta)} \cup \overline{B(\mathbf{v}_2, 2\rho\eta)} \right).$$



Figure 25. The larger interval is ϵ , and the smaller is $\epsilon^{\rho\eta}$.

Definition 7.4 (see Figure 21). Let $\mathcal{O}(\mathcal{T})$ be a graph cover of an $(\eta, \delta\eta)$ -geometric graph \mathcal{T} . Given $\rho, d > 0$, we say that $\mathcal{O}(\mathcal{T})$ is $(\eta; \rho, d)$ -geometric provided

1. For all $\mathbf{v} \in \mathcal{T}_0$, $g_{\mathcal{O}, \mathcal{T}}(\mathbf{v}) = B(\mathbf{v}, 5\rho\eta)$.
2. For all $\mathbf{e} \in \mathcal{T}_1$, $g_{\mathcal{O}, \mathcal{T}}(\mathbf{e}) = \epsilon^{\rho\eta}$.
3. Each of the collections

$$\{g_{\mathcal{O}, \mathcal{T}}(\mathbf{v})\}_{\mathbf{v} \in \mathcal{T}_0} \text{ and } \{g_{\mathcal{O}, \mathcal{T}}(\mathbf{e})\}_{\mathbf{e} \in \mathcal{T}_1}$$

is $d\eta$ -separated.

The following is an immediate consequence of this definition.

Proposition 7.5. There are universal constants $\rho, d > 0$ so that any $(\eta, \delta\eta)$ -geometric graph has an $(\eta; \rho, d)$ -geometric graph cover $\mathcal{O}(\mathcal{T})$. Moreover, if $\mathcal{O}(\tilde{\mathcal{T}})$ is any $(\eta; \rho, d)$ -geometric graph cover of a subcomplex $\tilde{\mathcal{T}} \subset \mathcal{T}$, then $\mathcal{O}(\tilde{\mathcal{T}})$ extends to an $(\eta; \rho, d)$ -geometric graph cover of \mathcal{T} .

Since the constants ρ and d are universal, for brevity we will omit them from the notation and refer to these covers as η -graph covers. Thus an $(\eta, \delta\eta)$ -geometric graph \mathcal{T} determines an η -graph cover $\mathcal{O}(\mathcal{T})$. If, in addition, $|\mathcal{T}| \subset p_F(F^+)$, where F is 1-framed, then $\mathcal{O}(\mathcal{T})$ determines a local cograph via the following construction.

Definition 7.6 (see Figure 21). Let F be a 1-framed set, and let \mathcal{T} be an $(\eta, \delta\eta)$ -geometric graph \mathcal{T} in $p_F(F^+)$ with η -graph cover $\mathcal{O}(\mathcal{T})$. A cosimplex S that is subordinate to F and generated by a $U \in \mathcal{O}(\mathcal{T})$ via (6.4.1) is called a **standard local η -cosimplex associated to (F, \mathcal{T})** . A collection $\mathcal{G} = \mathcal{V} \cup \mathcal{E}$ of **standard local η -cosimplices** that are generated by simplices of \mathcal{T} is called a **standard local η -cograph**, provided the collection \mathcal{V} of covertices is disjoint and the collection \mathcal{E} of coedges is disjoint. Otherwise we call \mathcal{G} a **standard local precograph**.

The following are immediate corollaries of this definition and the definition of κ -lined up.

Corollary 7.7. Let \mathcal{T} be an η -geometric graph in $p_F(F^+)$, and let

$$|K_{\mathcal{T}}| := \cup_{\mathfrak{s} \in K_{\mathcal{T}}} |\mathfrak{s}|.$$

There is a respectful, standard local η -cograph $\mathcal{G}(\mathcal{T})$ associated to (F, \mathcal{T}) which is generated by $K_{\mathcal{T}}$ and whose cosimplices are all defined using the submersion p_F . Moreover, if $p_F(\bar{F}) \subset |K_{\mathcal{T}}|$, then $\mathcal{G}(\mathcal{T})$ covers F .

Corollary 7.8. Let $\mathcal{G} = \mathcal{V} \cup \mathcal{E}$ be a standard local η -precograph associated to $(F(\beta), \mathcal{T})$. If $\eta \geq \frac{\beta}{500}$ and κ and \varkappa are sufficiently small, then \mathcal{G} is a cograph.

7.9. Geometric Cographs. In this subsection, we define two constraints on cographs which we call η -**geometric** and **legal**.

Definition 7.10. Let $\{F_i(\beta_i)\}_{i=1}^L$ be a family of $(1, \varkappa)$ -framed sets that are κ -lined up, vertically separated, and fiber swallowing. For $l \in \{1, \dots, L\}$, let

$$\mathcal{G} = \mathcal{V} \cup \mathcal{E} = \bigcup_{i=1}^l \mathcal{G}_i = \bigcup_{i=1}^l (\mathcal{V}_i \cup \mathcal{E}_i)$$

be a cograph that is subordinate to $\{F_i(\beta_i)\}_{i=1}^l$. We say that \mathcal{G} is η -**geometric** provided for $i \in \{1, \dots, l\}$, the local cograph \mathcal{G}_i is at Gromov-Hausdorff distance $\leq \tau(\kappa\eta)$ from a standard local η -cograph.

For technical reasons that arise in Part 2 of this paper, we will need to further constrain some of our cographs as follows.

Definition 7.11. Let \mathcal{T} be an $(\eta, \delta\eta)$ -geometric graph. If the edges of \mathcal{T} have length strictly less than $(\sqrt{2} - \frac{1}{10})\eta$, then we say that \mathcal{T} is a **legal** η -geometric graph.

We say that an η -geometric cograph is **legal** if all of its generating graphs are legal.

The only significance of the constant $\frac{1}{10}$ in the definition above is that it yields a definitive value strictly less than $\sqrt{2}\eta$.

8. HOW TO CONSTRUCT COGRAPHS

In this section, we prove Lemma 6.11 and hence Covering Lemma 1. In fact, we prove the following more general result, which will assist in the project of sewing the cograph constructed here with the framed sets that we construct in Part 2.

Theorem 8.1. Let $\mathcal{A} = \{F_l(\beta_l^+)\}_{l=1}^L$ be a collection of $(1, \varkappa)$ -framed sets that are κ -lined up, vertically separated, fiber swallowing, and ordered so that $\beta_i \geq \beta_{i+1}$. There is an $\eta_L \in [\frac{\beta_L}{500}, \frac{\beta_L}{50}]$ and a legal η_L -cograph $\mathcal{G}^L = \mathcal{V}^L \cup \mathcal{E}^L$ subordinate to \mathcal{A} .

Furthermore, if $\mathcal{A} = \mathcal{K}^1$ where \mathcal{K}^1 is as in Lemma 4.19, then we can choose \mathcal{G}^L to be relative to Ω_0 .

The proof is by induction on l and involves two key tools—the Extension and Subdivision Lemmas. These lemmas are stated below as Lemmas 8.7 and 8.11 and proved in Subsections 8.3 and 8.10, respectively. The induction statement asserts, among other things, that there is a sequence of positive numbers $\{\eta_l\}_{l=1}^L$ and a cograph \mathcal{G}^l so that Theorem 8.1 holds with L replaced by l . The sequence of η_i comes from the following proposition.

Proposition 8.2. Let $\{\beta_i^+\}_{i=1}^M \subset (0, \infty)$ be ordered so that $\beta_i \geq \beta_{i+1}$. Given any $\eta_1 \in [\frac{\beta_1}{500}, \frac{\beta_1}{50}]$ there is a sequence $\{\eta_i\}_{i=1}^M$ so that

$$\eta_i \in \left[\frac{\beta_i}{500}, \frac{\beta_i}{50} \right]$$

and

$$\eta_{i-1} = 10^{k_i} \eta_i$$

for some $k_i = 0, 1, 2, 3, \dots$

Proof. For each $i \in \{2, 3, \dots, M\}$, we let $n(i)$ be the least nonnegative integer so that

$$\eta_i := \frac{\eta_1}{10^{n(i)}} \leq \frac{\beta_i}{50}. \quad (8.2.1)$$

It follows that $\eta_i \in \left[\frac{\beta_i}{500}, \frac{\beta_i}{50}\right]$. \square

To begin the proof of Theorem 8.1, we take any $\eta_1 \in \left[\frac{\beta_1}{500}, \frac{\beta_1}{50}\right]$ and let $\{\eta_i\}_{i=1}^L$ be a sequence that satisfies the conclusion of the proposition above. To anchor the induction, we then take an η_1 -geometric graph that covers $p_{F_1}(F_1)$ and apply Corollary 7.7 to get an associated standard local η_1 -cograph \mathcal{G}^1 that covers F_1 .

For an outline of the induction step, assume \mathcal{G}^{l-1} is η_{l-1} -geometric. In the event that $\eta_l < \eta_{l-1}$, we use the Subdivision Lemma to replace \mathcal{G}^{l-1} with an η_l -geometric cograph $\tilde{\mathcal{G}}^{l-1}$ subordinate to $\{F_i(\beta_i^+)\}_{i=1}^{l-1}$ (see Figure 26). We then use the Extension Lemma to extend $\tilde{\mathcal{G}}^{l-1}$ to an η_l -geometric cograph \mathcal{G}^l subordinate to $\{F_i(\beta_i^+)\}_{i=1}^l$. If $\eta_l = \eta_{l-1}$, the procedure is the same except that we skip the subdivision step.

Roughly, the Extension Lemma starts with an η_l -geometric cograph $\tilde{\mathcal{G}}^{l-1}$ subordinate to $\{F_i\}_{i=1}^{l-1}$ and extends it to an η_l -geometric cograph $\tilde{\mathcal{G}}^l$ subordinate to $\{F_i\}_{i=1}^{l-1} \cup \{F_l\}$. To do this extension, we project $\tilde{\mathcal{G}}^{l-1}$ to $p_{F_l}(F_l)$ using p_{F_l} . Since p_{F_l} is \varkappa -almost Riemannian and the sets in \mathcal{A} are κ -lined up, this yields an $(\eta_l, \delta\eta_l)$ -geometric graph $\mathcal{T}^{\text{pr},l}$, where the error, δ , depends on \varkappa and κ . Since the cardinality L of \mathcal{A} has no known relationship with \varkappa and κ , for our induction argument, we will need a new method to verify that the errors do not accumulate. This new technique will allow us to extend $\mathcal{T}^{\text{pr},l}$ to a graph $\mathcal{T}^l \subset p_{F_l}(F_l)$ for which the collection of new vertices is error free. We call this extension an **error correcting extension**, and in the Extension Lemma, we make the additional hypothesis and conclusion that $\tilde{\mathcal{G}}^{l-1}$ and $\tilde{\mathcal{G}}^l$ are **error correcting cographs**. This is a term that we define in the next subsection.

In Subsection 8.10, we state and prove the Subdivision Lemma, and we wrap up the proof of Theorem 8.1 in Subsection 8.14.

8.3. Error Correcting Cographs and the Extension Lemma. In this subsection, we define the term **error correcting cograph** and state and prove the **Extension Lemma**. We start with error correcting extensions of geometric graphs.

Definition 8.4. Let \mathcal{T} and $\tilde{\mathcal{T}}$ be $(\eta, \delta\eta)$ -geometric graphs with $\mathcal{T} \subset \tilde{\mathcal{T}}$ and $|\mathcal{T}|, |\tilde{\mathcal{T}}| \subset [a, b]$. We say that $\tilde{\mathcal{T}}$ is an **error correcting extension** of \mathcal{T} provided $\tilde{\mathcal{T}}_0$ is a subset of $[a, b]$ so that

$$[a, b] \subset B\left(\tilde{\mathcal{T}}_0, \eta\right) \quad \text{and} \quad \text{dist}(\mathbf{v}, \mathbf{w}) \geq \eta \quad (8.4.1)$$

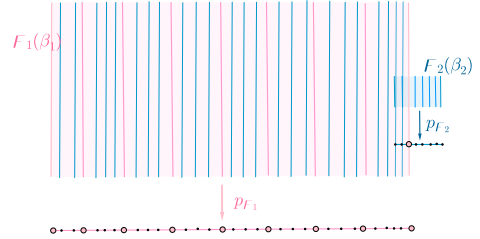

Figure 26. The pink and blue rectangles are 2-dimensional depictions of 1-framed sets. The pink subset of the interval is the vertex set of an $\frac{\beta_1}{8}$ -geometric graph in $p_{F_1}(F_1(\beta_1))$, but only one of its fibers intersects $F_2(\beta_2)$. Thus we add the blue points to the pink points to obtain a geometric graph that is at an appropriate scale for the blue set. If the picture were realistic, the sides of the pink rectangle would be 10 rather than 5 times longer than the sides of the blue rectangle (cf Figure 38 for the analogous construction within 2-framed sets in Part 2).

for all $\mathbf{v} \in \tilde{\mathcal{T}}_0$ and all $\mathbf{w} \in \tilde{\mathcal{T}}_0 \setminus \mathcal{T}_0$.

By extending \mathcal{T}_0 to a maximal subset of $[a, b]$ that satisfies (8.4.1), we get

Proposition 8.5. *Let \mathcal{T} be an $(\eta, \delta\eta)$ -geometric graph with $|\mathcal{T}| \subset [a, b]$. Then there is an error correcting extension $\tilde{\mathcal{T}}$ of \mathcal{T} .*

Before proceeding further we detail the process mentioned above wherein we project a geometric cograph to get an $(\eta, \delta\eta)$ -geometric graph. To do so, let $\mathcal{G} = \mathcal{V} \cup \mathcal{E}$ be an η -geometric cograph that is subordinate to $\{F_i(\beta_i^+)\}_{i=1}^{l-1}$. Call the set of vertex fibers VF, that is,

$$\text{VF} := \bigcup_{i=1}^{l-1} \{q_{\mathbf{v}}^{-1}(\mathbf{v}) \mid \mathbf{v} \in (K_{\mathcal{T}^i})_0\},$$

where $q_{\mathbf{v}}$ is the submersion that defines the covertex that corresponds to \mathbf{v} . Let

$$\mathcal{T}_0^{\text{pr}, l} := p_{F_l}(\text{VF}) \text{ (see, e.g., the pink dot in the blue interval in Figure 26).}$$

The elements of $\mathcal{T}_0^{\text{pr}, l}$ are not points. However, since our sets are κ -lined up, the elements of $\mathcal{T}_0^{\text{pr}, l}$ all have diameter less than $\tau(2\kappa\beta_l)$, so to avoid excess technicalities, we will treat the elements of $\mathcal{T}_0^{\text{pr}, l}$ as though they were points.

Let $\mathcal{T}^{\text{pr}, l}$ be the graph whose vertices are $\mathcal{T}_0^{\text{pr}, l}$ and in which two vertices are connected by an edge if and only if the corresponding covertices intersect a common coedge. We can now define the concept of an error correcting cograph.

Definition 8.6. *Let $\mathcal{A} = \{F_i\}_{i=1}^L$ be a collection of $(1, \varkappa)$ -framed sets that are κ -lined up, vertically separated, and fiber swallowing. For $l \in \{1, \dots, L\}$ and $k \geq l$, let $\mathcal{G} = \mathcal{V} \cup \mathcal{E}$ be a respectful, η_k -geometric cograph subordinate to $\{F_i\}_{i=1}^l$. We say that \mathcal{G} is **error correcting** provided*

1. For each local cograph \mathcal{G}_{j_0} , the associated graph \mathcal{T}^{j_0} is an error correcting extension of $\mathcal{T}^{\text{pr}, j_0}$.
2. The generating set $K_{\mathcal{T}^{j_0}}$ for \mathcal{G}_{j_0} is

$$K_{\mathcal{T}^{j_0}} = \mathcal{T}^{j_0} \setminus \mathcal{T}^{\text{pr}, j_0}.$$

With the definition of error correcting cographs in hand, we can state the Extension Lemma.

Lemma 8.7. *(Extension Lemma) Let $\mathcal{A} := \{F_j(\beta_j^+)\}_{j=1}^L$ be a collection of $(1, \varkappa)$ -framed sets that are κ -lined up, vertically separated, and fiber swallowing. For $l \in \{1, \dots, L\}$, let $\mathcal{G}^{l-1} = \mathcal{V}^{l-1} \cup \mathcal{E}^{l-1}$ be an error correcting, η_l -geometric cograph that is subordinate to $\{F_i(\beta_i^+)\}_{i=1}^{l-1}$. Then \mathcal{G}^{l-1} extends to an error correcting, η_l -geometric cograph $\mathcal{G}^l = \mathcal{V}^l \cup \mathcal{E}^l$ that is subordinate to $\{F_i(\beta_i^+)\}_{i=1}^{l-1} \cup \{F_l(\beta_l^+)\}$.*

Moreover, if $\mathcal{A} = \mathcal{K}^1$ and \mathcal{G}^{l-1} is relative to Ω_0 , then we can choose \mathcal{G}^l so that it is relative to Ω_0 .

To begin the proof, let $\text{VF}_i(\nu)$ be the intersection of VF with $F_i(\beta_i, \nu)$. Let VT_i be the abstract graph whose vertex set is $\text{VF}_i(\nu)$ and in which two vertices are connected by an edge if and only if the corresponding covertices intersect a common coedge.

Next we apply Lemma 5.13 and observe that for each $j_0 \in \{1, \dots, l\}$, $\text{VT}_{j_0}(\beta_l^+)$ is an abstract geometric graph with respect to the following metric: For any $q_{\mathbf{v}}^{-1}(\mathbf{v}), q_{\tilde{\mathbf{v}}}^{-1}(\tilde{\mathbf{v}}) \in \text{VT}_{j_0}(\beta_l^+)$, choose any point in $x_0 \in q_{\mathbf{v}}^{-1}(\mathbf{v}) \cap F_{j_0}(\beta_{j_0}, \beta_l)$ and define

$$\text{dist}(q_{\mathbf{v}}^{-1}(\mathbf{v}), q_{\tilde{\mathbf{v}}}^{-1}(\tilde{\mathbf{v}})) := \text{dist}(x_0, q_{\tilde{\mathbf{v}}}^{-1}(\tilde{\mathbf{v}}) \cap F_i(\beta_i, 5\beta_l)).$$

Of course this definition depends on the many possible choices of x_0 , but since the $q_{\mathbf{v}}$ are 3κ -lined up, \varkappa -almost Riemannian submersions, the fibers are almost equidistant. So regardless of these choices, Lemma 5.13 together with an induction argument and the fact that $\frac{\beta_l}{500} \leq \eta_l$ yields

Corollary 8.8. *If \mathcal{G} is an error correcting, η_l -geometric cograph that is subordinate to a collection $\{F_i^+\}_{i=1}^{l-1}$ of κ -lined up, vertically separated, fiber swallowing $(1, \varkappa)$ -framed sets, then for all $j_0 \in \{1, 2, 3, \dots, l-1\}$, $\text{VT}_{j_0}(\beta_l^+)$ is an abstract $(\eta_l, \delta\eta_l)$ -graph, for $\delta = \varkappa + 5,000\kappa$.*

We omit the proof since Lemma 12.12 in Part 2 is analogous and a complete proof is given. Combining Corollary 8.8 with Lemma 5.13, we get

Corollary 8.9. *Let $\mathcal{A} := \{F_j(\beta_j^+)\}_{j=1}^L$ be a collection of $(1, \varkappa)$ -framed sets that are κ -lined up, vertically separated, and fiber swallowing. For $l \in \{1, \dots, L\}$, if \mathcal{G} is an error correcting, η_l -geometric cograph that is subordinate to $\{F_i^+(\beta_i)\}_{i=1}^{l-1}$, then $\mathcal{T}^{\text{pr},l}$ is an $(\eta_l, 2\delta\eta_l)$ -geometric cograph where $\delta = \varkappa + 5,000\kappa$.*

Proof of the Extension Lemma (8.7). Since $\mathcal{G}^{l-1} = \mathcal{V}^{l-1} \cup \mathcal{E}^{l-1}$ is an error correcting, η_l -geometric cograph, Corollary 8.9 gives us that $\mathcal{T}^{\text{pr},l}$ is $(\eta_l, 2\delta\eta_l)$ -geometric, where $\delta = \varkappa + 5,000\kappa$. By Proposition 8.5, $\mathcal{T}^{\text{pr},l}$ has an error correcting extension to an $(\eta_l, 2\delta\eta_l)$ -geometric graph \mathcal{T}^l that covers $p_{F_l}(F_l)$.

Set

$$K_{\mathcal{T}^l} := \mathcal{T}^l \setminus \mathcal{T}^{\text{pr},l}. \quad (8.9.1)$$

By Corollary 7.7, there is a standard local cograph \mathcal{G}_l whose cosimplices are in one-to-one correspondence with $K_{\mathcal{T}^l}$ and are defined using the submersion p_{F_l} (see Definition 7.6). Since \mathcal{T}^l is an error correcting extension of $\mathcal{T}^{\text{pr},l}$, Lemma 5.13 gives us that

$$\begin{aligned} & \text{the intersection of } \mathcal{G}^{l-1} \cup \mathcal{G}_l \text{ with } F_l^+ \text{ is no more than } \tau(\kappa\eta_l) \text{ from a standard} \\ & \text{local cograph associated to the } \eta_l\text{-geometric graph } \mathcal{T}^l. \end{aligned} \quad (8.9.2)$$

To show that

$$\mathcal{G}^l := \mathcal{G}^{l-1} \cup \mathcal{G}_l = \mathcal{V}^{l-1} \cup \mathcal{V}_l \cup \mathcal{E}^{l-1} \cup \mathcal{E}_l$$

is a cograph, we combine the fact that \mathcal{G}^{l-1} is a cograph with the following additional arguments.

Proof of Property 1 of Definition 6.5: Since \mathcal{G}^{l-1} is a cograph and \mathcal{G}_l is a local cograph, Property 1 holds. \square

Proof of Property 2 of Definition 6.5: The collections \mathcal{V}^{l-1} and \mathcal{E}^{l-1} are disjoint, by hypothesis. So it suffices to show that the collections \mathcal{V}_l and \mathcal{E}_l are disjoint from each other and from \mathcal{V}^{l-1} and \mathcal{E}^{l-1} , respectively. Since each element of \mathcal{V}_l and \mathcal{E}_l is contained in F_l^+ , it is enough to consider the intersection of $\mathcal{G}^{l-1} \cup \mathcal{G}_l$ with F_l^+ .

Since $\eta_l \geq \frac{\beta_l}{500}$, (8.9.2) together with Corollary 7.8 gives us that the intersections of each of $\mathcal{V}^{l-1} \cup \mathcal{V}_l$ and $\mathcal{E}^{l-1} \cup \mathcal{E}_l$ with F_l^+ is a disjoint collection, and hence each of $\mathcal{V}^{l-1} \cup \mathcal{V}_l$ and $\mathcal{E}^{l-1} \cup \mathcal{E}_l$ is a disjoint collection. \square

Proof of Property 3 of Definition 6.5: By hypothesis, \mathcal{G}^{l-1} covers $\cup_{i=1}^{l-1} F_i(\beta_i^-)$. Since $|\mathcal{T}^l|$ covers $p_{F_l}(F_l)$, Corollary 7.7, (8.9.1), and (8.9.2) imply that $\mathcal{G}^l = \mathcal{G}^{l-1} \cup \mathcal{G}_l$ covers $F_l(\beta_l^-)$. \square

Thus \mathcal{G}^l is a cograph, which by construction, is η_l -geometric and error correcting. It remains to prove that if $\mathcal{A} = \mathcal{K}^1$ and \mathcal{G}^{l-1} is relative to Ω_0 , then we can choose \mathcal{G}^l to be relative to Ω_0 . If $F_l \cap \Omega_0 = \emptyset$, there is nothing to prove. Otherwise, by Parts 2 and 3 of Lemma 4.19, $F_l(\beta_l) \cap \bigcup_{i=1}^{l-1} F_i(\beta_i^+) = \emptyset$, and $p_F(\bar{F} \cap \bar{\Omega}_0^-) = \{0\}$. So our construction gives that \mathcal{G}^l is relative to Ω_0 provided we choose \mathcal{T}^l so that $0 \in \mathcal{T}_0^l$. This is possible since $F_l(\beta_l) \cap \bigcup_{i=1}^{l-1} F_i(\beta_i^+) = \emptyset$. \square

8.10. Subdividing Cographs. In this subsection, we prove the cograph subdivision lemma.

Lemma 8.11 (Subdivision Lemma). *Let $\mathcal{A} := \{F_j(\beta_j^+)\}_{j=1}^L$ be a collection of 1-framed sets that are κ -lined up, vertically separated, and fiber swallowing. Let*

$$\mathcal{G} := \mathcal{V} \cup \mathcal{E} = \cup_j \mathcal{G}_j = \bigcup_j \mathcal{V}_j \cup \mathcal{E}_j$$

be an error correcting, η_{l-1} -cograph that is subordinate to $\{F_j(\beta_j^+)\}_{j=1}^{l-1}$, where $l \in \{1, \dots, L\}$. Let \mathcal{T}_j be the graph that generates \mathcal{G}_j .

There is a subdivision $\mathcal{L}(\mathcal{T}_j)$ of \mathcal{T}_j that is legal and generates a local cograph $\mathcal{L}(\mathcal{G}_j)$ so that $\mathcal{L}(\mathcal{G}) := \cup_j \mathcal{L}(\mathcal{G}_j)$ is a legal, error correcting η_l -cograph subordinate to $\{F_j(\beta_j^+)\}_{j=1}^{l-1}$.

Furthermore, if $\mathcal{A} = \mathcal{K}^1$ and \mathcal{G} is relative to Ω_0 , then we can choose $\mathcal{L}(\mathcal{G})$ to be relative to Ω_0 .

When \mathcal{G} and $\mathcal{L}(\mathcal{G})$ are related as in the Cograph Subdivision Lemma, we will say that $\mathcal{L}(\mathcal{G})$ is a legal subdivision of \mathcal{G} . The proof of the Cograph Subdivision Lemma uses the following result from [36].

Lemma 8.12 (Lemma 3.6 and Corollary 4.25 of [36]). *Let \mathcal{T} be an $(\eta, \delta\eta)$ -geometric graph with $|\mathcal{T}| \subset [0, \beta]$. There is a legal $(\frac{\eta}{19}, \delta\frac{\eta}{10})$ -geometric graph $\mathcal{L}(\mathcal{T})$ that subdivides \mathcal{T} . Moreover, if $\tilde{\mathcal{T}}$ is an error correcting extension of \mathcal{T} , then we can choose legal subdivisions of \mathcal{T} and $\tilde{\mathcal{T}}$ so that $\mathcal{L}(\tilde{\mathcal{T}})$ is an error correcting extension of $\mathcal{L}(\mathcal{T})$.*

We also make use of the following notation.

Definition 8.13. Let $(F(\beta, \nu), p_F, r_F)$ be k -framed. We set

$$F^{v,-} := F(\beta, \nu^-) \quad \text{and} \quad F^{v,+} := F(\beta, \nu^+).$$

Proof of Lemma 8.11. The existence of the $\mathcal{L}(\mathcal{T}_j)$ follows from Lemma 8.12.

For each $E \in \mathcal{E}_j$ let \mathfrak{e}_E be the corresponding edge. Replace E with standard $\frac{\eta}{10}$ -geometric coedges and covertices that are subordinate to F_j and that correspond to the simplices of $\mathcal{L}(\mathcal{T}_j)$ that cover the interior of $|\mathfrak{e}_E|$. The submersion that defines them is q_E^{ext} , where q_E^{ext} is as in Corollary 6.8.

Given $V \in \mathcal{V}_j$, let \mathfrak{v}_V be the corresponding vertex. We replace $V \in \mathcal{V}_j$ with a standard $\frac{\eta}{10}$ -geometric covertex that corresponds to \mathfrak{v}_V and is subordinate to F_j . The submersion that defines it is q_V .

Call the resulting collection $\mathcal{L}(\mathcal{G})$. From the construction of $\mathcal{L}(\mathcal{G})$ and Lemma 8.12, we see that we can choose the $\mathcal{L}(\mathcal{T}_j)$ so that $\mathcal{L}(\mathcal{G})$ is error correcting. Since different fibers of the same submersion are disjoint, $\mathcal{L}(\mathcal{G})$ satisfies the required disjointness properties.

Notice that $\cup \mathcal{G}^{v,-} \subset \cup \mathcal{L}(\mathcal{G})$. So $\mathcal{L}(\mathcal{G})$ covers $\cup \mathcal{A}^-$ because $\cup \mathcal{A}^- \subset \cup \mathcal{G}^{v,-}$. Finally if $\mathcal{A} = \mathcal{K}^1$, and \mathcal{G} is relative to Ω^0 , then by construction, $\mathcal{L}(\mathcal{G})$ is relative to Ω_0 . \square

8.14. Proof of Theorem 8.1.

Proof of Theorem 8.1. For simplicity, we only detail the case when $\mathcal{A} = \mathcal{K}^1$. Apply the Cograph Extension Lemma (8.7) with $l = 1$ and $\mathcal{G}^0 = \emptyset$, to get an error correcting, η_1 -geometric cograph \mathcal{G}^1 that is subordinate to $F_1(\beta_1^+)$ and relative to Ω_0 .

For $k \in \{1, \dots, l-1\}$, assume there is an error correcting, η_{k-1} -geometric cograph \mathcal{G}^{k-1} subordinate to $\{F_j(\beta_j^+)\}_{j=1}^{k-1}$ which is relative to Ω_0 . Use Lemma 8.11 to subdivide \mathcal{G}^{k-1} to get an error correcting, η_k -geometric cograph $\tilde{\mathcal{G}}^{k-1}$ which is relative to Ω_0 .

By the Cograph Extension Lemma (8.7), $\tilde{\mathcal{G}}^{k-1}$ extends to the desired error correcting geometric cograph \mathcal{G}^k . By induction, this produces the framed cover that proves Theorem 8.1 and thus Covering Lemma 1. \square

Part 2. Covering the Natural 2-stratum

In this, part we establish the first conclusion of Limit Lemma G by proving

Covering Lemma 2. *Given $\delta > 0$ there is a $\varkappa > 0$ and a respectful, \varkappa -framed cover $\mathcal{B} = \mathcal{B}^0 \cup \mathcal{B}^1 \cup \mathcal{B}^2$ of $X \setminus X_\delta^4$ so that for $k = 0, 1$, or 2 , the closures of the elements of \mathcal{B}^k are pairwise disjoint.*

We establish the second conclusion of Limit Lemma G and finish the proof of Theorem A in the appendix. To explain our strategy to prove Covering Lemma 2, let

$$\mathcal{A} = \mathcal{A}^0 \cup \mathcal{A}^1 \cup \mathcal{A}^2$$

be as in Covering Lemma 1 with $\mathcal{A}^2 = \{F_j\}_{j=1}^{\tilde{L}}$. The goal is to replace \mathcal{A} with a respectful framed cover

$$\mathcal{B} = \mathcal{B}^0 \cup \mathcal{B}^1 \cup \mathcal{B}^2$$

so that each collection \mathcal{B}^i , $i = 0, 1$, or 2 , is a disjoint collection of i -framed sets. Since the collections \mathcal{A}^0 and \mathcal{A}^1 from Covering Lemma 1 are each disjoint and respectful, the focus is on separating the elements of \mathcal{A}^2 using additional 0- and 1-framed sets. In analogy with Part 1, these extra 0- and 1-framed sets are artificially framed subsets of the elements of \mathcal{A}^2 and form a combinatorial structure that we call a **cotriangulation**. Roughly speaking, cotriangulations are analogs of cographs, except the starting point is a triangulation in \mathbb{R}^2 rather than a graph in \mathbb{R} .

More specifically, for each 2-framed set $(A, p_A) \in \mathcal{A}^2$, we take a triangulation \mathcal{T} in $p_A(A^+) \subset \mathbb{R}^2$. We then construct an open cover of $|\mathcal{T}|$ which we call a **triangulation cover** (see Figure 27). The open sets of a triangulation cover are disjoint open balls around each vertex (the red balls in Figure 27), disjoint tubular neighborhoods of shrunken versions of the edges (the thin blue rectangles in Figure 27), and disjoint open sets that are shrunken versions of the faces (the light grey triangles in Figure 27). We then construct a collection of artificially 0-, 1-, and 2-framed subsets of A by taking p_A -preimages of the open sets in the triangulation cover. We call this collection a **cotriangulation**. We call its elements **cosimplices**, and we call the 0-, 1-, and 2-framed sets **coververtices**, **coedges**, and **cofaces**, respectively (see Figure 28). Together with an inductive argument, this will yield a cover of $\cup_{A \in \mathcal{A}^2} A^-$ with the desired disjointness properties.

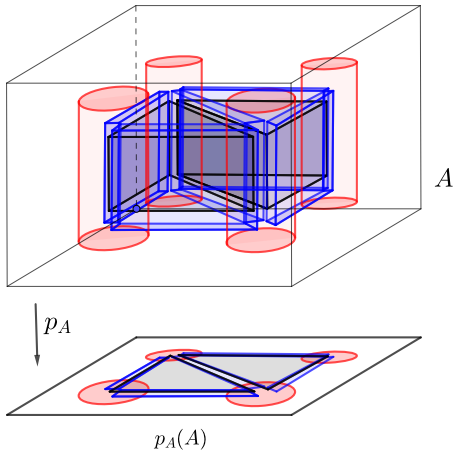

Figure 28. A cotriangulation in a 3-dimensional Alexandrov space. The red cylinders are the coververtices. The coedges are the thin blue boxes.

In this part, we combine these properties with an inductive argument to construct a cotriangulation that proves Covering Lemma 2.

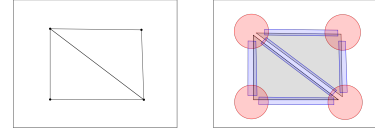

Figure 27. A triangulation with a corresponding triangulation cover

To create a framed cover that also is respectful, we will apply the Submersion Deformation Lemma (5.7). Doing this requires that our collections of cosimplices satisfy Inequality (5.7.1). In other words, the quantities κ and \varkappa need to be small compared with the constant C in Inequality (5.7.1). The constant C is determined by our cotriangulation, and yet in our construction we choose κ and \varkappa before constructing \mathcal{A}^2 . So, to construct a cotriangulation to which we can apply the Submersion Deformation Lemma, we impose a further constraint on the triangulations that generate our cotriangulation. The additional constraint is that our triangulations are what we call **CDGs**, which is short for **Chew-Delaunay-Gromov**. In [36], we prove that CDGs can be extended, subdivided, and have smallest angle $\geq \pi/6$. The relevant definitions and results are restated in Subsection 11.1.

Throughout Part 2, there is a strong analogy with Part 1, as indicated in the following table.

Part 1 concept	Part 2 analog
graph	triangulation
graph cover	triangulation cover, Definition 9.2
η -geometric graph	η -CDG triangulation, Definition 11.4
η -geometric graph cover	geometric triangulation cover, Definition 11.18
η -geometric cograph	geometric cotriangulation, Definition 11.25
error correcting cograph	error correcting cotriangulation, Definition 12.6

Besides the definition of a geometric cotriangulation, there are three main ingredients in the proof of Covering Lemma 2:

Result	Shows how to
Subdivision Lemma (12.17)	subdivide a geometric cotriangulation.
Lemma 11.27	deform a geometric cotriangulation to a respectful one.
Extension Lemma (12.7)	extend a geometric cotriangulation to an additional 2-framed set.

Part 2 is divided into four sections. In Section 9, we define cotriangulations and discuss some purely topological/set theoretic notions that are related to them. In Section 10, we show the cover from Covering Lemma 1 can be constructed in a way that will facilitate the meshing of our cotriangulation with the natural 0 and 1 strata. Section 11 develops the notion of geometric cotriangulations, and in Section 12, we construct the cotriangulation that proves Covering Lemma 2.

9. COTRIANGULATIONS

In Subsection 9.1, we define triangulation covers, which are precursors of cotriangulations, and in Subsection 9.3, we define cotriangulations.

9.1. Triangulation Covers. The starting point for the definition of cotriangulation is a method for creating an open cover $\mathcal{O}(\mathcal{T})$ from a triangulation \mathcal{T} in \mathbb{R}^2 .

Definition 9.2 (see Figure 27). *Let \mathcal{T} be a triangulation of a subset $|\mathcal{T}|$ of \mathbb{R}^2 . A collection of open sets $\mathcal{O}(\mathcal{T})$ is called a **triangulation cover** provided*

1. $\mathcal{O}(\mathcal{T})$ covers $|\mathcal{T}|$.
2. There is a one-to-one correspondence $g_{\mathcal{O},\mathcal{T}} : \mathcal{T} \rightarrow \mathcal{O}(\mathcal{T})$ so that for each $k \in \{0, 1, 2\}$, the collection $g_{\mathcal{O},\mathcal{T}}(\mathcal{T}_k)$ consists of disjoint open subsets of \mathbb{R}^2 .
3. For each vertex \mathbf{v} , $g_{\mathcal{O},\mathcal{T}}(\mathbf{v})$ is a neighborhood of \mathbf{v} that is diffeomorphic to a 2-ball.
4. For each 1-simplex \mathbf{e} , $g_{\mathcal{O},\mathcal{T}}(\mathbf{e})$ is a neighborhood of a proper open subset \mathbf{e}^- of \mathbf{e} so that \mathbf{e}^- is diffeomorphic to an interval, and $g_{\mathcal{O},\mathcal{T}}(\mathbf{e})$ is a trivial line bundle over \mathbf{e}^- .
5. For each 2-simplex \mathbf{f} , $g_{\mathcal{O},\mathcal{T}}(\mathbf{f})$ is a proper subset of \mathbf{f} that is diffeomorphic to a 2-ball.

We say that $\mathcal{O}(\mathcal{T})$ is **associated to \mathcal{T}** , and that \mathcal{T} **generates $\mathcal{O}(\mathcal{T})$** .

9.3. What is a Cotriangulation? In this subsection, we define a combinatorial structure associated to a collection \mathcal{A}^2 of 2-framed sets which we call a cotriangulation. We start with the local notion.

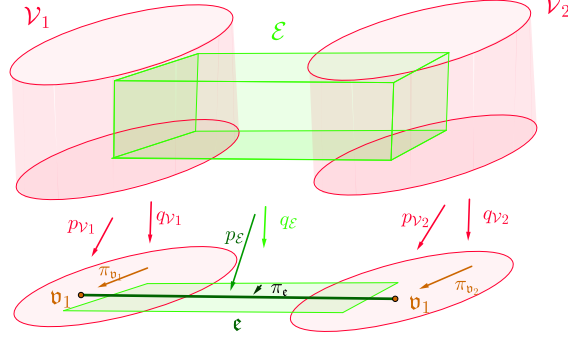

Figure 29. The green box \mathcal{E} corresponds to the edge ϵ and hence is called a coedge. The red cylinders \mathcal{V}_1 and \mathcal{V}_2 correspond to the vertices v_1 and v_2 , and hence are called covertices. These are two of the three types of open sets in a cotriangulation. The other type is cofaces (see Figure 30). All three sets are contained in a 2-framed set F (not pictured). The three submersions $q_{\mathcal{V}_1}$, $q_{\mathcal{E}}$, and $q_{\mathcal{V}_2}$ have images in \mathbb{R}^2 and are κ -lined up with p_F . By composing $q_{\mathcal{V}_1}$, $q_{\mathcal{E}}$, and $q_{\mathcal{V}_2}$ with the orthogonal projections π_{v_1} , π_{ϵ} , and π_{v_2} onto v_1 , ϵ , and v_2 , we see that \mathcal{V}_1 , \mathcal{E} , and \mathcal{V}_2 are artificially 0-, 1-, and 0-framed, respectively, in the 2-framed set F .

Definition 9.4 (see Figures 28, 29, 30, and 31). *Let F be a 2-framed set and \mathcal{V} , \mathcal{E} , and \mathcal{F} collections of pairwise disjoint open subsets of F^+ . Then*

$$\mathcal{S} \equiv \mathcal{V} \cup \mathcal{E} \cup \mathcal{F}$$

is a local cotriangulation subordinate to F provided

1. *There is a triangulation \mathcal{T} with $p_F(F) \subset |\mathcal{T}| \subset p_F(F^+)$ with associated triangulation cover $O(\mathcal{T})$.*
2. *There is a one-to-one correspondence between \mathcal{S} and a subset $K_{\mathcal{T}} \subset \mathcal{T}$. Each $S \in \mathcal{S}$ is generated by the corresponding $\mathfrak{s} \in K_{\mathcal{T}}$ as follows: There is a submersion $q_S : F \rightarrow \mathbb{R}^2$ so that $(S, q_S, U_S, \mathfrak{s})$ is an artificially k -framed set with $\mathfrak{s} \in \mathcal{T}_k \cap K_{\mathcal{T}}$, $U_S = g_{O, \mathcal{T}}(\mathfrak{s})$, and*

$$\begin{aligned} \text{if } \mathfrak{s} \in \mathcal{T}_0, & \text{ then } S = q_S^{-1}(U_S) \cap F(\beta, \beta^+) \in \mathcal{V}, \\ \text{if } \mathfrak{s} \in \mathcal{T}_1, & \text{ then } S = q_S^{-1}(U_S) \cap F(\beta, \beta) \in \mathcal{E}, \\ \text{if } \mathfrak{s} \in \mathcal{T}_2, & \text{ then } S = q_S^{-1}(U_S) \cap F(\beta, \beta^-) \in \mathcal{F}. \end{aligned} \tag{9.4.1}$$

For \mathcal{S} , \mathcal{T} , and $K_{\mathcal{T}}$ as above, we say that $K_{\mathcal{T}}$ generates \mathcal{S} . In general, $K_{\mathcal{T}}$ will be a proper subset of \mathcal{T} to allow local cotriangulations to fit together with each other and with the natural 0 and 1 strata (see Figure 34).

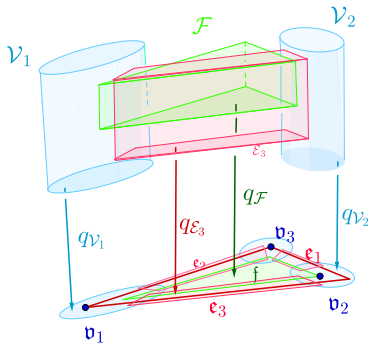

Figure 31. Pictured are \mathcal{V}_1 , \mathcal{E}_3 , \mathcal{F} , and \mathcal{V}_2 , which are four of the six open sets of a cotriangulation that correspond to a single 2-simplex f .

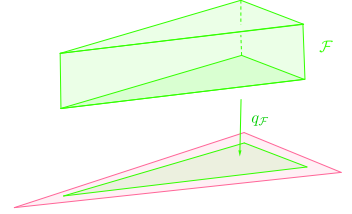

Figure 30. The green prism, \mathcal{F} , corresponds to the face, f , and hence is called a coface.

Definition 9.5 (see Figures 28, 29, 30, and 31). *Let $\mathcal{U} \equiv \{F_i(\beta_i)\}_{i=1}^l$ be a collection of $(2, \varkappa)$ -framed sets that are κ -lined up, vertically separated, and fiber swallowing. We say a collection*

$$\mathcal{S} \equiv \mathcal{V} \cup \mathcal{E} \cup \mathcal{F}$$

of open subsets of X is a cotriangulation subordinate to \mathcal{U} provided

1. For each i , there is a local cotriangulation

$$\mathcal{S}_i := \mathcal{V}_i \cup \mathcal{E}_i \cup \mathcal{F}_i$$

subordinate to F_i so that

$$\mathcal{V} = \cup_i \mathcal{V}_i, \quad \mathcal{E} = \cup_i \mathcal{E}_i, \quad \mathcal{F} = \cup_i \mathcal{F}_i, \quad \text{and} \quad \mathcal{S} = \cup_i \mathcal{S}_i.$$

2. Each of the collections \mathcal{V} , \mathcal{E} , and \mathcal{F} is pairwise disjoint.
3. \mathcal{S} covers $\cup \mathcal{U}^-$.

Definition 9.6. The elements of \mathcal{V} , \mathcal{E} , \mathcal{F} , and \mathcal{S} are called *covertices*, *coedges*, *cofaces*, and *cosimplices*, respectively.

Definition 9.7. We say a cotriangulation is **respectful** provided it is a respectful collection of framed sets (see Definition F).

At the end of the next section we show that Covering Lemma 2 holds provided there is a certain type of cotriangulation. We then state Lemma 10.8, which asserts that such a cotriangulation exists.

10. INTERFACE OF THE 2-FRAMED SETS WITH THE LOWER STRATA

Before proceeding further with the proof of Covering Lemma 2, we constrain the geometry of the 2-framed sets of Covering Lemma 1 and their intersections with the 0- and 1-framed sets of Covering Lemma 1. These constraints are stated in the next lemma.

Lemma 10.1 (see Figure 32). Let $\mathcal{K} = \mathcal{K}^0 \cup \mathcal{K}^1 \cup \mathcal{K}^2$ be the framed cover from Lemma 4.19, and let $\mathcal{G}^L := \mathcal{V}^L \cup \mathcal{E}^L$ be the η_L -geometric cograph subordinate to \mathcal{K}^1 that was constructed to prove Theorem 8.1. There is a framed cover

$$\mathcal{A} := \mathcal{A}^0 \cup \mathcal{A}^1 \cup \mathcal{A}^2$$

that has the following properties:

1. \mathcal{A} satisfies the conclusion of Covering Lemma 1.
2. $\mathcal{A}^0 := \mathcal{K}^0 \cup \mathcal{V}^L$, and $\mathcal{A}^1 := \mathcal{E}^L$.
3. For each $(F(\beta_F), p_F) \in \mathcal{A}^2$, $\beta_F < \frac{\eta_L}{50}$ and

$$p_F(\overline{F(\beta_F)}) = [0, \beta_F] \times [0, \beta_F]. \quad (10.1.1)$$

4. \mathcal{A}^2 thoroughly respects $\mathcal{A}^0 \cup \mathcal{A}^1$.
5. If $F(\beta_F) \in \mathcal{A}^2$ and $(K, r_K) \in \mathcal{K}^0$ satisfy $F(\beta_F) \cap K \neq \emptyset$, then

$$p_F(\overline{F \cap K^-}) = \{0\} \times [0, \beta_F],$$

and r_K is lined up with $\pi_1 \circ p_F$, where $\pi_1 : \mathbb{R}^2 \rightarrow \mathbb{R}$ is orthogonal projection to the first factor.

6. If $F \in \mathcal{A}^2$ and $(V, r_V) \in \mathcal{V}^L$ satisfy $F(\beta_F) \cap V \neq \emptyset$, then

$$p_F(\overline{F \cap V^-}) = [0, \beta_F] \times \{0\}, \quad (10.1.2)$$

r_V is lined up with $\pi_2 \circ p_F$, and q_V is lined up with $\pi_1 \circ p_F$ where $\pi_i : \mathbb{R}^2 \rightarrow \mathbb{R}$ is orthogonal projection to the i^{th} -factor.

7. If $F \in \mathcal{A}^2$ and $(E, p_E, r_E) \in \mathcal{E}^L$ satisfy $F(\beta_F) \cap E \neq \emptyset$, then

$$p_F(\overline{F \cap E^-}) = [0, \beta_F] \times \{0\}, \quad (10.1.3)$$

r_E is lined up with $\pi_2 \circ p_F$, and p_E is lined up with $\pi_1 \circ p_F$.

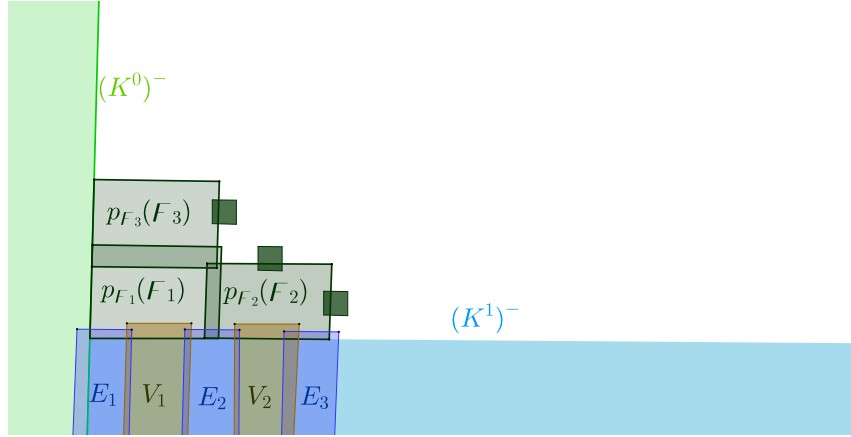

Figure 32. This depicts how elements F_1, F_2 , and F_3 of \mathcal{A}^2 intersect elements K^0 of \mathcal{K}^0 and K^1 of \mathcal{K}^1 , as described in Lemma 10.1. To be more precise, it is a picture of the image of the configuration under p_{F_1} , assuming that p_{F_1} is defined in a region this large. Pictured also are $\{V_1, V_2\}$ and $\{E_1, E_2, E_3\}$, which are part of a cograph subordinate to K^1 . The three dark green squares are images of elements of \mathcal{A}^2 that intersect neither $\cup \mathcal{K}^0$ nor $\cup \mathcal{K}^1$. The F pictured thoroughly respect K^0 . They also thoroughly respect the initial cograph described in Lemma 10.1. They do not, however, thoroughly respect the cograph depicted here, as it has been subdivided via Proposition 10.4.

The proof is a rehash of the ideas of the proof of Lemma 4.19, so we omit it.

We continue to call the natural 0-stratum Ω_0 and define the natural 1-stratum Ω_1 to be

$$\Omega_1 := \cup \mathcal{G}^L.$$

10.2. The Seam Between the Cotriangulation and the Lower Strata. Let \mathcal{G}^L , \mathcal{A} , and \mathcal{K} be the cograph and framed collections from the lemma above. When a 2-framed set $F \in \mathcal{A}^2$ intersects $\Omega_0 \cup \Omega_1$, we will need to understand how its cotriangulation intersects $\Omega_0 \cup \Omega_1$. By Part 5 of Lemma 10.1, if F intersects $K \in \mathcal{K}^0$, then p_F takes the intersection to the left hand edge of $p_F(F) = [0, \beta_F] \times [0, \beta_F]$, and by Parts 6, and 7 of Lemma 10.1 if F intersects $V \in \mathcal{V}^L$ or $E \in \mathcal{E}^L$, then p_F takes the intersection to the bottom edge of $p_F(F) = [0, \beta_F] \times [0, \beta_F]$. In this subsection, we construct vertex sets along these edges that later we will extend to triangulations in the $p_F(F) = [0, \beta_F] \times [0, \beta_F]$ (see Figures 33 and 34).

To fix notation, assume $\mathcal{A}^2 = \{F_i(\beta_i)\}_{i=1}^{\tilde{L}}$ is ordered so that $\beta_i \geq \beta_{i+1}$. Choose $\tilde{\eta}_1 \in [\frac{\beta_1}{500}, \frac{\beta_1}{50}]$ and let $\{\tilde{\eta}_i\}_{i=1}^{\tilde{L}}$ be the corresponding sequence from the conclusion of Proposition 8.2. We specify the “bottom” and “left” pieces of \mathcal{A}^2 to be

$$\begin{aligned} \mathcal{B} &:= \{F \in \mathcal{A}^2 \mid F \cap \Omega_1 \neq \emptyset\} \text{ and} \\ \mathcal{L} &:= \{F \in \mathcal{A}^2 \mid F \cap \Omega_0 \neq \emptyset\}. \end{aligned} \quad (10.2.4)$$

For $l \in \{1, 2, \dots, \tilde{L}\}$, set

$$\mathcal{B}_l := \{F_i\}_{i=1}^l \cap \mathcal{B} \text{ and } \mathcal{L}_l := \{F_i\}_{i=1}^l \cap \mathcal{L}. \quad (10.2.5)$$

Notice that for $l \in \{1, 2, \dots, \tilde{L}\}$,

$$\mathcal{A}_l := \{(F, \pi_2 \circ p_F) \mid F \in \mathcal{L}_l\}$$

is a collection of 1–framed sets which is κ –lined up, vertically separated, and fiber swallowing. So Theorem 8.1 and its proof give us

Corollary 10.3. *For each $l \in \{1, 2, \dots, \tilde{L}\}$, there is a legal, error correcting $\tilde{\eta}_l$ –cograph $\mathcal{L}\mathcal{G}^l$ subordinate to \mathcal{A}_l .*

For convenience, for each $(F_k(\beta_k), \pi_2 \circ p_{F_k}) \in \mathcal{A}_l$, we identify

$$(\pi_2 \circ p_{F_k})(F_k) = [0, \beta_k]$$

with $\{0\} \times [0, \beta_k]$, and we let $\mathcal{L}\mathcal{T}^k$ be the graph in $\{0\} \times [0, \beta_k]$ that generates the local cograph $\mathcal{L}\mathcal{G}_k^l \subset \mathcal{L}\mathcal{G}^l$ that is subordinate to F_k . Throughout the rest of Part 2, we denote the vertex set $(\mathcal{L}\mathcal{T}^k)_0$ by

$$L_k^l := (\mathcal{L}\mathcal{T}^k)_0 \subset \{0\} \times [0, \beta_k] = (\pi_2 \circ p_{F_k})(F_k). \quad (10.3.1)$$

These vertex sets will play a central role in the interface of our cotriangulation with the natural 0–stratum (see Figures 33 and 34).

If $K_{\mathcal{L}\mathcal{T}^k} \subset \mathcal{L}\mathcal{T}^k$ is the generating set for $\mathcal{L}\mathcal{G}_k^l$, and $\mathbf{v} \in (\mathcal{L}\mathcal{T}^k)_0 \cap K_{\mathcal{L}\mathcal{T}^k}$, we let

$$q_{\mathbf{v}}^l : F_k \longrightarrow [0, \beta_k]$$

be the submersion that defines the covertex of $\mathcal{L}\mathcal{G}^l$ that corresponds to \mathbf{v} . We then define $q_{\mathbf{v}} : F_k \longrightarrow \mathbb{R}^2$ by

$$q_{\mathbf{v}} = (\pi_1 \circ p_{F_k}, q_{\mathbf{v}}^l).$$

The vertex sets B_k^l in the next result will play an analogous role in the interface of our cotriangulation with the natural 1–stratum.

Proposition 10.4 (see the two brown x 's in Figure 33). *Let \mathcal{A} , \mathcal{K} , and \mathcal{G}^L be as in Lemma 10.1. If $\mathcal{A}^2 = \{F_i(\beta_i)\}_{i=1}^{\tilde{L}}$, there is a choice of $\tilde{\eta}_1 \in [\frac{\beta_1}{500}, \frac{\beta_1}{50}]$ so that if $\{\tilde{\eta}_i\}_{i=1}^{\tilde{L}}$ is the corresponding sequence from Proposition 8.2, then for each $l \in \{1, 2, \dots, \tilde{L}\}$, there is a legal, error correcting, $\tilde{\eta}_l$ –geometric cograph*

$$\tilde{\mathcal{G}}^l := \tilde{\mathcal{V}}^l \cup \tilde{\mathcal{E}}^l$$

that has the following properties:

1. The cograph $\tilde{\mathcal{G}}^l$ is a legal subdivision of \mathcal{G}^L .

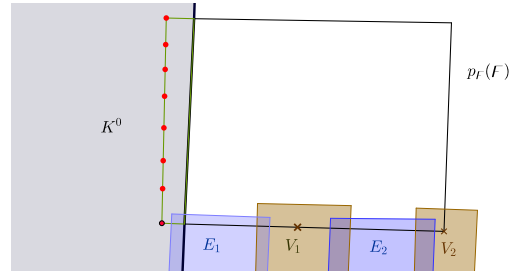

Figure 33. Here the 2–framed set F intersects the naturally 0–framed set K^0 as well as the cograph that covers the naturally 1–framed region. The vertex set from (10.3.1) consists of the red points on the left-hand edge. The vertex set from Proposition 10.4 consists of the two brown x 's on the bottom edge.

2. For each $F_k \in \mathcal{B}_l$, there is a subset B_k^l of $p_{F_k} \left(\overline{F_k \cap \Omega_1^-} \right) = [0, \beta_l] \times \{0\}$ with the property that for each element of $\mathbf{v} \in B_k^l$, there is a $V \in \tilde{\mathcal{V}}^l$ so that \mathbf{v} is the center of the interval $p_{F_k} \left(\partial \overline{V}^- \cap \overline{F_k} \right)$.
3. B_k^l is the vertex set of a legal $\tilde{\eta}_l$ -geometric graph in $[0, \beta_k] \times \{0\}$.
4. If $V \in \tilde{\mathcal{V}}^l$ and $F \in \mathcal{A}^2$ intersect, then $\overline{F \cap V}$ satisfies

$$p_F \left(\overline{F \cap V} \right) \subset I \times \left[0, \frac{\tilde{\eta}_l}{50} \right], \quad (10.4.1)$$

where $I \subset [0, \beta_F]$ is an interval.

5. If $E \in \tilde{\mathcal{E}}^l$ and $F \in \mathcal{A}^2$ intersect, then $\overline{F \cap E}$ satisfies

$$p_F \left(\overline{F \cap E} \right) \subset I \times \left[0, \frac{\tilde{\eta}_l}{100} \right], \quad (10.4.2)$$

where $I \subset [0, \beta_F]$ is an interval.

6. Let

$$\mathcal{A} \left(\tilde{\mathcal{G}}^l \right) := \mathcal{A}^0 \left(\tilde{\mathcal{G}}^l \right) \cup \mathcal{A}^1 \left(\tilde{\mathcal{G}}^l \right) \cup \mathcal{A}^2,$$

where

$$\mathcal{A}^0 \left(\tilde{\mathcal{G}}^l \right) := \mathcal{K}^0 \cup \tilde{\mathcal{V}}^l \text{ and } \mathcal{A}^1 \left(\tilde{\mathcal{G}}^l \right) := \tilde{\mathcal{E}}^l.$$

Then $\mathcal{A} \left(\tilde{\mathcal{G}}^l \right)$ is a framed cover that satisfies all of the conclusions of Lemma 10.1, except for Part 4 and (10.1.2) and (10.1.3).

Proof. Let $\mathcal{A}^2 = \{F_i(\beta_i)\}_{i=1}^{\tilde{L}}$, and let \mathcal{G}^L be the η_L -geometric cograph from Lemma 10.1. By Part 3 of Lemma 10.1, $\frac{\beta_1}{50} \leq \eta_L$. Let $k \geq 1$ be the smallest integer so that $\frac{\eta_L}{10^k} \in \left[\frac{\beta_1}{500}, \frac{\beta_1}{50} \right]$. Legally subdivide \mathcal{G}^L k times to get a legal, error correcting, $\tilde{\eta}_1$ -geometric cograph $\tilde{\mathcal{G}}^1$ with $\tilde{\eta}_1 := \frac{\eta_L}{10^k}$. Let $\{\tilde{\eta}_i\}_{i=1}^{\tilde{L}}$ be the corresponding sequence from Proposition 8.2. For each $l \in \{1, 2, \dots, \tilde{L}\}$, legally subdivide $\tilde{\mathcal{G}}^1$ to get $\tilde{\mathcal{G}}^l$. This gives us Part 1. Part 2 follows from the construction of $\tilde{\mathcal{G}}^l$ and Parts 6 and 7 of Lemma 10.1. Part 3 holds because the submersions that define the cosimplices of $\tilde{\mathcal{G}}^l$ are lined up, almost Riemannian submersions and because a legal subdivision of a legal cograph is legal.

Parts 4 and 5 follow from Parts 6 and 7 of Lemma 10.1 after adjusting the covertices and coedges so that (10.4.1) and (10.4.2) hold. To do this, we exploit the fact that a cosimplex is parameterized by its fiber exhaustion function. So each cosimplex can be shrunken by replacing it by a super level set of its fiber exhaustion function.

To prove Part 6, we note that all of the properties of Lemma 10.1 are preserved under subdivision except of course the three mentioned. \square

Remark. \mathcal{A}^2 is not likely to thoroughly respect $\mathcal{A}^0 \left(\tilde{\mathcal{G}}^l \right) \cup \mathcal{A}^1 \left(\tilde{\mathcal{G}}^l \right)$ as \mathcal{A}^2 is fixed and we have subdivided our original cograph \mathcal{G}^L to obtain $\tilde{\mathcal{G}}^l$ (see Figure 32).

Similarly, subdividing the cograph changes the width of the cosimplices, so (10.1.2) and (10.1.3) are replaced with the statements of Parts 4 and 5 of the result above.

10.5. Cotriangulations Relative to the Natural 0 and 1 Strata. The main results of this subsection are Proposition 10.7 and Lemma 10.8. The first result specifies a type of cotriangulation whose existence implies Covering Lemma 2. Lemma 10.8 asserts that this type of cotriangulation exists. The remainder of Part 2, after this subsection, is a proof of Lemma 10.8. Before stating Proposition 10.7, we specify some more terminology.

Let \mathcal{B}_l be as in 10.2.5. For $F \in \mathcal{B}_l$ set

$$F_{\text{bot}} := p_F^{-1} \left([0, \beta_F] \times \left[0, \frac{\tilde{\eta}_l}{50} \right] \right),$$

and

$$\mathcal{A}_{\text{bot}} := \{(F_{\text{bot}}, \pi_1 \circ p_F) \mid F \in \mathcal{B}_l\}.$$

Then \mathcal{A}_{bot} is a collection of 1-framed sets that is κ -lined up, vertically separated, and fiber swallowing. For $l \in \{1, 2, \dots, \tilde{L}\}$, let $\tilde{\mathcal{G}}^l$ be as in Proposition 10.4. Then

$$\mathcal{B}\tilde{\mathcal{G}}^l := \left\{ S \cap (\cup \mathcal{A}_{\text{bot}}) \mid S \in \tilde{\mathcal{G}}^l \right\} \quad (10.5.3)$$

is a legal, error correcting cograph that is subordinate to \mathcal{A}_{bot} .

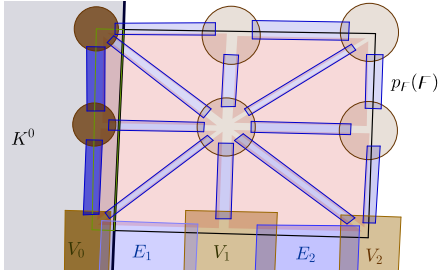

Figure 34. A triangulation cover that generates a cotriangulation relative to $\mathcal{L}\mathcal{G}^l \cup \mathcal{B}\tilde{\mathcal{G}}^l$. The projection of the cograph $\mathcal{L}\mathcal{G}^l$ lies along the left hand edge. The projection of the cograph $\mathcal{B}\tilde{\mathcal{G}}^l$ lies along the bottom edge.

Definition 10.6. For $k \leq l$, let $\mathcal{S} = \mathcal{V} \cup \mathcal{E} \cup \mathcal{F}$ be a cotriangulation subordinate to $\{F_i\}_{i=1}^k \subset \mathcal{A}^2$ which contains the intersection of $\mathcal{L}\mathcal{G}^l \cup \mathcal{B}\tilde{\mathcal{G}}^l$ with $\cup_{i=1}^k F_i$. Let $\mathcal{V}(\mathcal{L}\mathcal{G}^l \cup \mathcal{B}\tilde{\mathcal{G}}^l)$ and $\mathcal{E}(\mathcal{L}\mathcal{G}^l \cup \mathcal{B}\tilde{\mathcal{G}}^l)$ be the collections of covertices and coedges of $\mathcal{L}\mathcal{G}^l \cup \mathcal{B}\tilde{\mathcal{G}}^l$, respectively. We say

that \mathcal{S} is **relative to** $\mathcal{L}\mathcal{G}^l \cup \mathcal{B}\tilde{\mathcal{G}}^l$ provided

1. The collection of closures of

$$\mathcal{V}^{\text{in}} := \mathcal{V} \setminus \mathcal{V}(\mathcal{L}\mathcal{G}^l \cup \mathcal{B}\tilde{\mathcal{G}}^l)$$

is disjoint from the collection of closures of $\mathcal{A}^0(\tilde{\mathcal{G}}^l)$, and the collection of closures of

$$\mathcal{E}^{\text{in}} := \mathcal{E} \setminus \mathcal{E}(\mathcal{L}\mathcal{G}^l \cup \mathcal{B}\tilde{\mathcal{G}}^l)$$

is disjoint from the collection of closures of $\mathcal{A}^1(\tilde{\mathcal{G}}^l)$.

2. For each E in \mathcal{E}^{in} , if E intersects an element of $\mathcal{A}^0(\tilde{\mathcal{G}}^l) \cup \mathcal{A}^1(\tilde{\mathcal{G}}^l)$, then this intersection is contained in $\cup \mathcal{V}(\mathcal{L}\mathcal{G}^l \cup \mathcal{B}\tilde{\mathcal{G}}^l)$.
3. For each $F \in \mathcal{F}$, if F intersects $\cup (\mathcal{A}^0(\tilde{\mathcal{G}}^l) \cup \mathcal{A}^1(\tilde{\mathcal{G}}^l))$, then this intersection is contained in $\cup (\mathcal{L}\mathcal{G}^l \cup \mathcal{B}\tilde{\mathcal{G}}^l)$.
4. For $F \in \mathcal{F}$ as in Part 3, suppose that F is subordinate to $F_F \in \mathcal{A}^2$. Then along $F \cap (\cup (\mathcal{A}^0(\tilde{\mathcal{G}}^l) \cup \mathcal{A}^1(\tilde{\mathcal{G}}^l)))$, $p_F = q_F = p_{F_F}$.

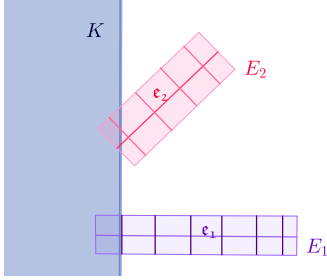

Figure 35. Pictured are the images of the coedges E_1 , E_2 and the naturally 0-framed set K under the submersion p_F of a naturally 2-framed set F (not pictured). The generating edge \mathbf{e}_1 of E_1 is parallel to the x -axis, and hence E_1 respects K . The generating edge \mathbf{e}_2 of E_2 is not parallel to the x -axis, and hence E_2 does not respect K .

Proposition 10.7. *For $l = \tilde{L}$, let $\mathcal{A}(\tilde{\mathcal{G}}^{\tilde{L}})$ be the framed cover from Part 6 of Proposition 10.4. Let $\mathcal{S} = \mathcal{V} \cup \mathcal{E} \cup \mathcal{F}$ be a respectful cotriangulation that is subordinate to \mathcal{A}^2 , relative to $\mathcal{L}\mathcal{G}^{\tilde{L}} \cup \mathcal{B}\tilde{\mathcal{G}}^{\tilde{L}}$, and that satisfies (10.6.1).*

Then there is a collection \mathcal{D}^0 of 0-framed sets which are deformations of the elements of $\mathcal{A}^0(\tilde{\mathcal{G}}^{\tilde{L}})$ so that Covering Lemma 2 holds with

$$\mathcal{B}^0 = \mathcal{V}^{\text{in}} \cup \mathcal{D}^0, \quad \mathcal{B}^1 = \mathcal{E}^{\text{in}} \cup \mathcal{A}^1(\tilde{\mathcal{G}}^{\tilde{L}}), \quad \text{and } \mathcal{B}^2 = \mathcal{F} \text{ (cf Figure 36).}$$

Proof. It follows from Part 1 of Definition 10.6 that we can replace $\mathcal{A}^0(\tilde{\mathcal{G}}^{\tilde{L}}) \cup \mathcal{A}^1(\tilde{\mathcal{G}}^{\tilde{L}})$ with an appropriate choice of $\mathcal{A}^0(\tilde{\mathcal{G}}^{\tilde{L}})^+ \cup \mathcal{A}^1(\tilde{\mathcal{G}}^{\tilde{L}})^+$ and

$$\mathcal{S} \text{ will still be relative to } \mathcal{L}\mathcal{G}^{\tilde{L}} \cup \mathcal{B}\tilde{\mathcal{G}}^{\tilde{L}}. \quad (10.7.1)$$

We must construct \mathcal{D}^0 and show that the resulting collection $\mathcal{B} := \mathcal{B}^0 \cup \mathcal{B}^1 \cup \mathcal{B}^2$ is respectful, covers $X \setminus X_\delta^4$, and has the required disjointness properties.

Respect: Since \mathcal{S} is respectful, we only need concern ourselves with how $\mathcal{E}^{\text{in}} \cup \mathcal{F}$ intersect the natural 0- and 1-strata. It follows from Parts 6 and 7 of Lemma 10.1, Parts 3 and 4 of Definition 10.6, and the construction of $\mathcal{B}\tilde{\mathcal{G}}^{\tilde{L}}$ that \mathcal{F} respects $\mathcal{A}^1(\tilde{\mathcal{G}}^{\tilde{L}})$. The main project is to construct a deformation \mathcal{D}^0 of $\mathcal{A}^0(\tilde{\mathcal{G}}^{\tilde{L}})$ so that \mathcal{E}^{in} respects \mathcal{D}^0 . To accomplish this, we deform \mathcal{K}^0 and $\mathcal{V}^0(\tilde{\mathcal{G}}^{\tilde{L}})$ separately. Except for notation, the two arguments are the same, so we only give the details for \mathcal{K}^0 .

Suppose that $K \in \mathcal{K}^0$ and $E \in \mathcal{E}^{\text{left}} \subset \mathcal{E}^{\text{in}}$ intersect. Let $r_K : K \rightarrow \mathbb{R}$ be the fiber exhaustion function for K , and let $q_E : E \rightarrow [0, \beta] \times [0, \beta] \subset \mathbb{R}^2$ and $p_E = \pi_{\mathbf{e}} \circ q_E : E \rightarrow \mathbf{e} \subset \mathbb{R}^2$ be the submersions that define E as a coedge.

For $k \leq l$, let $\mathcal{S} = \mathcal{V} \cup \mathcal{E} \cup \mathcal{F}$ be a cotriangulation subordinate to $\{F_i\}_{i=1}^k \subset \mathcal{A}^2$ and relative to $\mathcal{L}\mathcal{G}^l \cup \mathcal{B}\tilde{\mathcal{G}}^l$. Let $\mathcal{E}^{\text{left}}$ be the coedges of \mathcal{E}^{in} that intersect \mathcal{K}^0 and let \mathcal{E}^{bot} be the coedges of \mathcal{E}^{in} that intersect $\mathcal{V}(\tilde{\mathcal{G}}^{\tilde{L}})$. Suppose that $E^l \in \mathcal{E}^{\text{left}}$ and $E^b \in \mathcal{E}^{\text{bot}}$ are generated by the 1-simplices \mathbf{e}^l and \mathbf{e}^b , respectively. It follows from Parts 5 and 6 of Lemma 10.1 that \mathbf{e}^l intersects $\{0\} \times \mathbb{R}$, and \mathbf{e}^b intersects $\mathbb{R} \times \{0\}$. For the next result, we assume that for all $E^l \in \mathcal{E}^{\text{left}}$ and all $E^b \in \mathcal{E}^{\text{bot}}$,

$$\begin{aligned} \langle \mathbf{e}^l, \{0\} \times \mathbb{R} \rangle &> \left(\frac{\pi}{6}\right)^- \quad \text{and} \\ \langle \mathbf{e}^b, \mathbb{R} \times \{0\} \rangle &> \left(\frac{\pi}{6}\right)^-. \end{aligned} \quad (10.6.1)$$

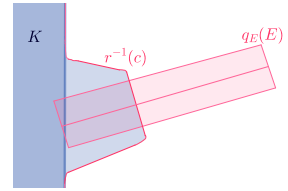

Figure 36. This coedge does not intersect the naturally 0-framed set K respectfully, but after modifying the fiber exhaustion function of K using Proposition 5.9, the intersection becomes respectful. To be more precise, we also replace K with $r^{-1}(-\infty, c)$.

Let $\tilde{p}_E = \pi_1 \circ p_E : E^l \rightarrow \mathbb{R}$, and suppose that E is subordinate to $F \in \mathcal{A}^2$. By Part 5 of Lemma 10.1, r_K is lined up with $\pi_1 \circ p_F$, so for simplicity we assume

$$r_K = \pi_1 \circ p_F.$$

This, together with (10.6.1), gives us that the angles between the gradients of \tilde{p}_E and $r_K = \pi_1 \circ p_F$ are $\leq \left(\frac{5\pi}{6}\right)^+$. Thus, after choosing the appropriate bump function $\tilde{\lambda} : \mathbb{R} \rightarrow \mathbb{R}$ and setting $\lambda := \tilde{\lambda} \circ \pi_1 \circ p_F$, we see that r_K , \tilde{p}_E , and λ satisfy the hypotheses of Proposition 5.9. Thus by Proposition 5.9, there is a deformation \tilde{r}_K of r_K with $\tilde{r}_K = r_K$ on $K \setminus E^+$ and $\tilde{r}_K = \tilde{p}_E$ on E . By redefining K to be the appropriate sublevel of \tilde{r}_K , we have that E respects K (cf Figure 36).

It remains to show that \mathcal{F} respects \mathcal{D}^0 . As before, we only give the details for our deformation of \mathcal{K}^0 . Except for notation, the argument for the deformation of $\mathcal{V}^0 \left(\tilde{\mathcal{G}}^{\tilde{L}}\right)$ is the same. From Parts 3 and 4 of Definition 10.6, we have that if $F \in \mathcal{F}$ intersects $K \in \mathcal{K}^0$, then along this intersection,

$$p_F = p_F,$$

where F is the element of \mathcal{A}^2 to which F is subordinate. Since $r_K = \pi_1 \circ p_F$, it follows that the fibers of p_F are contained in levels of r_K , so F respects K , and it remains to see that this property is not destroyed when we replace K with \tilde{K} .

Suppose that E is a coedge that intersects K and F . Since \mathcal{S} is respectful the fibers of p_F are contained in levels of p_E and hence also in the levels of $\tilde{p}_E = \pi_1 \circ p_E$. Since our bump function λ is $\tilde{\lambda} \circ \pi_1 \circ p_F$, we also have that the fibers of p_F are contained in levels of λ . Thus the fibers of p_F are contained in levels of

$$\tilde{r}_K = (1 - \lambda)\tilde{p}_E + \lambda r_K,$$

and \mathcal{B} is respectful.

To assist in the remainder of the proof, we note that the deformation outlined above can be performed while not affecting the existing properties of the $\mathcal{A}^0 \left(\tilde{\mathcal{G}}^{\tilde{L}}\right)$. Indeed, by (10.7.1) there is a choice of K^+ with $K \Subset K^+$ so that \mathcal{S} is also relative to $\mathcal{L}\mathcal{G}^l \cup \mathcal{B}\tilde{\mathcal{G}}^l$ even with K replaced by K^+ . Proposition 5.9 and the argument above allow us to construct \tilde{K} so that

$$K \subset \tilde{K} \subset K^+. \tag{10.7.2}$$

Covers: Since \mathcal{S} covers $(\mathcal{A}^2)^-$ and $\mathcal{A}^0 \left(\tilde{\mathcal{G}}^{\tilde{L}}\right) \cup \mathcal{A}^1 \left(\tilde{\mathcal{G}}^{\tilde{L}}\right)$ covers $\Omega_0 \cup \Omega_1$,

$$\mathcal{A}^0 \left(\tilde{\mathcal{G}}^{\tilde{L}}\right) \cup \mathcal{A}^1 \left(\tilde{\mathcal{G}}^{\tilde{L}}\right) \cup \mathcal{S}$$

covers $\Omega_0 \cup \Omega_1 \cup (\mathcal{A}^2)^-$. Since $\cup (\mathcal{V} \setminus \mathcal{V}^{\text{in}})$ and $\cup (\mathcal{E} \setminus \mathcal{E}^{\text{in}})$ are contained in $\Omega_0 \cup \Omega_1$,

$$\mathcal{A}^0 \left(\tilde{\mathcal{G}}^{\tilde{L}}\right) \cup \mathcal{A}^1 \left(\tilde{\mathcal{G}}^{\tilde{L}}\right) \cup \mathcal{V}^{\text{in}} \cup \mathcal{E}^{\text{in}} \cup \mathcal{F}$$

covers $\Omega_0 \cup \Omega_1 \cup (\mathcal{A}^2)^-$, and it follows from (10.7.2) that \mathcal{B} covers $X \setminus X_\delta^4$.

Disjointness: Since \mathcal{S} is a cotriangulation, \mathcal{V}^{in} , \mathcal{E}^{in} , and $\mathcal{B}^2 = \mathcal{F}$ are disjoint collections. By Part 6 of Proposition 10.4, $\mathcal{A}^0(\mathcal{G}^{\tilde{L}})$ and $\mathcal{A}^1(\mathcal{G}^{\tilde{L}})$ are each disjoint collections. By Part 1

of Definition 10.6, \mathcal{E}^{in} is disjoint from $\mathcal{A}^1(\mathcal{G}^{\bar{L}})$ and \mathcal{V}^{in} is disjoint from $\mathcal{A}^0(\mathcal{G}^{\bar{L}})$. So \mathcal{B}^1 is a disjoint collection, and using also (10.7.2) we have that \mathcal{B}^0 is a disjoint collection. \square

So our goal for the remainder of this part of the paper is to prove

Lemma 10.8. *There is a respectful cotriangulation $\mathcal{S} = \mathcal{V} \cup \mathcal{E} \cup \mathcal{F}$ that is subordinate to \mathcal{A}^2 , is relative to $\mathcal{L}\mathcal{G}^{\bar{L}} \cup \mathcal{B}\tilde{\mathcal{G}}^{\bar{L}}$, and satisfies (10.6.1).*

11. GEOMETRIC COTRIANGULATIONS

In spite of the fact that the concept of a cotriangulation is rather topological, we do not know how to prove Lemma 10.8 without imposing some further geometric restrictions on our cotriangulations. To do this, we will exploit a special fact about \mathbb{R}^2 , namely Chew's Theorem (11.5, below), which says that all angles of a special type of simplicial complex in \mathbb{R}^2 are $\geq \frac{\pi}{6}$. We call these special complexes CDGs.

The only significance of the number $\frac{\pi}{6}$ is that it is a universal lower bound for all angles of all CDGs. In the end, this will allow us to verify that our cotriangulations satisfy the geometric inequality in (5.7.1), and thus can be deformed to respectful cotriangulations.

In Subsection 11.1, we review the relevant results from [36] on Chew's Theorem and its consequences. In Subsection 11.15, we define the concept of a geometric triangulation cover and in Subsection 11.24 we define geometric cotriangulations. Roughly speaking, geometric cotriangulations are cotriangulations whose underlying triangulations are CDGs.

11.1. Chew's Theorem and Its Consequences. A CDG is a special type of triangulation in \mathbb{R}^2 . Roughly speaking it is a Delaunay triangulation of a Gromov set. In this subsection, we define CDGs and review their properties that were proven in [36]. We start with the definition of Gromov sets.

Definition 11.2. *Given $\eta > 0$, we say a subset A of a metric space X , is an η -Gromov set if and only if*

$$B(A, \eta) = X$$

and for distinct $a, b \in A$,

$$\text{dist}(a, b) \geq \eta.$$

Equivalently, A is η -separated and not properly contained in an η -separated subset of X .

The definitions of Delaunay triangulation and CDGs are:

Definition 11.3. *(see e.g. [13], Chapter 6 and Proposition 1.5 in [36]) A triangulation \mathcal{T} of a discrete point set S of \mathbb{R}^2 is called Delaunay if and only if for every edge e that bounds two faces, the sum of the opposite angles is $\leq \pi$. Equivalently, the circumdisk of each 2-simplex contains no points of S in its interior.*

Definition 11.4. *We call a simplicial complex \mathcal{T} in \mathbb{R}^2 an η -CDG, provided there is a Delaunay triangulation $\hat{\mathcal{T}}$ of an η -Gromov subset of \mathbb{R}^2 , and \mathcal{T} is a subcomplex of $\hat{\mathcal{T}}$.*

The algorithm on Pages 7-8 of [9] combined with the theorem on Page 9 and the corollary on Page 10 of [9] give the following.

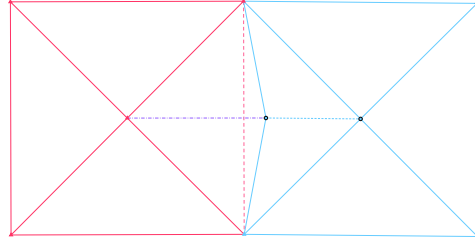

Figure 37. Assume the side lengths of these squares is just under 2. Then the red vertices are a 1-Gromov subset of the red square, and the red edges are a Delaunay triangulation of the red vertices. The blue vertices are an extension of the red ones to a 1-Gromov subset of the union of the two squares, but the dashed red edge fails the angle flip test and hence is not Delaunay for the extended configuration. The Delaunay triangulation of the extended set consists of all of the edges pictured except for the dashed red one.

Theorem 11.5. (*Chew’s Angle Theorem*) Let \mathcal{T} be an η -CDG. Then all angles of \mathcal{T} are $\geq \frac{\pi}{6}$ and the lengths of all edges of \mathcal{T} are in $[\eta, 2\eta]$.

(See [36] for an alternative exposition.) Next we discuss deforming the concept of a CDG to what we call almost CDGs. This begins with

Definition 11.6. Given $\eta, \delta > 0$, we say a subset A of a metric space X , is an $(\eta, \delta\eta)$ -Gromov set if and only if

$$B(A, \eta(1 + \delta)) = X$$

and for distinct $a, b \in A$,

$$\text{dist}(a, b) \geq \eta(1 - \delta).$$

To avoid technical difficulties near the boundaries of Delaunay triangulations of Gromov sets the definition of almost CDGs is phrased in terms of the following technical concept (cf Figure 37).

Definition. Let X be a metric space with $U, U_x \subset X$ open in X . Given $\eta > 0$ and $\delta \geq 0$, let A and A_x be $(\eta, \delta\eta)$ -Gromov subsets of the closures of U and U_x respectively. We say that A_x is a **buffer** of A provided:

1. The closed ball $D(U, 6\eta) \subset U_x$.
2. $A = A_x \cap \text{closure}(U)$.

A CDG passes the following test with $\varepsilon = 0$.

Definition 11.7. Let \mathcal{T} be a simplicial complex in \mathbb{R}^2 . Let e be an edge of \mathcal{T} which bounds two faces. We say that e passes the ε -angle Flip Test if and only if the sum of the angles opposite e is $\leq \pi + \varepsilon$.

We are ready for the definition of almost CDGs.

Definition 11.8. Given $\eta, \delta, \varepsilon > 0$, let \mathcal{T}_0 be an $(\eta, \delta\eta)$ -Gromov subset of the closure of an open set $U \subset \mathbb{R}^2$ with buffer $(\mathcal{T}_0)_x$. A triangulation \mathcal{T} of \mathcal{T}_0 is called an $(\eta, \delta\eta, \varepsilon)$ -CDG, provided \mathcal{T} is a subcomplex of a triangulation \mathcal{T}_x of $(\mathcal{T}_0)_x$, and each edge of \mathcal{T}_x passes the ε -angle flip test.

We will say \mathcal{T}_x is a **buffer** of \mathcal{T} . In [36] we observe

Proposition 11.9. (*Proposition 4.15 of [36]*) *Given $d, \theta > 0$, there are $\varepsilon, \delta > 0$ so that for every $(\eta, \delta\eta, \varepsilon)$ -CDG,*

1. *Every edge length of \mathcal{T} is in the interval $[\eta - d, 2\eta + d]$.*
2. *All angles of \mathcal{T} are $\geq \frac{\pi}{6} - \theta$.*

A given $S \subset \mathbb{R}^2$ can have more than one Delaunay triangulation, and hence sets S_i arbitrarily close to S need not have Delaunay triangulations that are close to an initially prescribed triangulation of S . The following three definitions are part of our strategy to deal with these issues.

Definition 11.10. ([13], page 74) *Given a discrete $S \subset \mathbb{R}^2$, a segment e between two points of S is in the Delaunay graph of S if and only if e is an edge of every Delaunay triangulation of S .*

Definition 11.11. *Given a discrete $S \subset \mathbb{R}^2$, $\xi > 0$, and a segment ab between two points a and b of S we say that ab is ξ -stable provided the following holds. For any embedding*

$$\begin{aligned} \iota & : S \longrightarrow \mathbb{R}^2 \text{ so that} \\ |\iota - \text{id}_S| & < \xi, \end{aligned}$$

the segment $\iota(a)\iota(b)$ is in the Delaunay graph of $\iota(S)$.

Definition 11.12. *We say that an $(\eta, \delta\eta, \varepsilon)$ -CDG is $\xi\eta$ -stable provided each of its boundary edges \mathcal{T} is $\xi\eta$ -stable.*

The definition of legal graph (Definition 7.11) is motivated by the following result.

Proposition 11.13. ([36], Proposition 3.3) *For $\eta > 0$, let S be an η -Gromov subset of \mathbb{R}^2 . If $a, b \in S$ satisfy $\text{dist}(a, b) < \sqrt{2}\eta$, then the segment ab between a and b is in Delaunay graph of S .*

We can now state the main result of the section, which is the following extension theorem for almost CDGs. It has the added feature that the extension is **error correcting** in the sense that the error estimates, ε and δ , for the new simplices is 0 (cf Definition 12.3, below).

Theorem 11.14 (Theorem 4.17, [36]). *There are $\varepsilon, \xi, \delta > 0$ with the following property. For $\beta \geq 50\eta$, let \mathcal{T} be a $\xi\eta$ -stable, $(\eta, \delta\eta, \varepsilon)$ -CDG in $[0, \beta] \times [0, \beta] \subset \mathbb{R}^2$. There is a $\xi\eta$ -stable, $(\eta, \delta\eta, \varepsilon)$ -CDG, $\tilde{\mathcal{T}}$, which extends \mathcal{T} and has the following properties.*

1. $[0, \beta] \times [0, \beta] \subset B(\tilde{\mathcal{T}}_0, \eta)$.
2. *The buffer of $\tilde{\mathcal{T}}$ extends the buffer of \mathcal{T} that is,*

$$(\mathcal{T}_x)_0 \subset (\tilde{\mathcal{T}}_x)_0.$$

3. $(\tilde{\mathcal{T}}_x)_0$ *is a subset of $[0, \beta + 6\eta] \times [0, \beta + 6\eta]$ so that*

$$\text{dist}\left(\left(\tilde{\mathcal{T}}_x\right)_0 \setminus (\mathcal{T}_x)_0, \mathcal{T}_0\right) \geq 3\eta,$$

$$[0, \beta + 6\eta] \times [0, \beta + 6\eta] \subset B\left(\left(\tilde{\mathcal{T}}_x\right)_0, \eta\right), \text{ and}$$

$$\text{dist}(v, w) \geq \eta,$$

for $v \in \left(\tilde{\mathcal{T}}_x\right)_0 \setminus (\mathcal{T}_x)_0$ and $w \in \left(\tilde{\mathcal{T}}_x\right)_0$.

4. $\tilde{\mathcal{T}}_x$ contains all legal subgraphs of \mathcal{T}_x .
5. Every edge of $\tilde{\mathcal{T}}$ that has a vertex in $\left(\tilde{\mathcal{T}}_0\right)_x \setminus \mathcal{T}_0$ is Delaunay, in the sense that it passes the ε -angle Flip Test with $\varepsilon = 0$.
6. Every edge with a vertex in $\left(\tilde{\mathcal{T}}_0\right)_x \setminus (\mathcal{T}_0)_x$ has length $\leq 2\eta$.

11.15. From Triangulations to Covers in Dimension 2. In this subsection, we define geometric triangulation covers and discuss their key properties (see Figure 27). We assume $\{\tilde{\eta}_l\}_{l=1}^{\tilde{L}}$ and $\mathcal{A}^2 = \{F_l\}_{l=1}^{\tilde{L}}$ are as in Proposition 10.4.

Definition 11.16 (see Figure 34). For $F_k \in \mathcal{A}^2$ and $k \leq l$, let \mathcal{T} be an $(\tilde{\eta}_l, \delta\tilde{\eta}_l)$ -CDG in $p_{F_k}(F_k^+)$, and let \mathcal{B}_l and \mathcal{L}_l be as in (10.2.5). We say that \mathcal{T} is an $\tilde{\eta}_l$ -geometric triangulation provided:

1. If $F_k \in \mathcal{L}_l$, then $\mathcal{T}_0 \cap \{\{0\} \times [0, \beta_l]\}$ is the set L_k^l from (10.3.1).
2. If $F_k \in \mathcal{B}_l$, then $\mathcal{T}_0 \cap \{[0, \beta_l] \times \{0\}\}$ is the set B_k^l from Part 2 of Proposition 10.4.
3. The boundary edges of \mathcal{T} are $\xi\tilde{\eta}_l$ -stable where ξ is as in Theorem 11.14.

Definition 11.17. Let \mathcal{T} be an $\tilde{\eta}_l$ -geometric triangulation.

For $\mathbf{e} \in (\mathcal{T}_x)_1$ and $\rho > 0$ set

$$\mathbf{e}^{\text{Shr}} := \mathbf{e} \setminus \left(\overline{B(\partial\mathbf{e}, 40\rho\tilde{\eta}_l)}\right) \text{ and}$$

$$\mathbf{e}^{\rho\tilde{\eta}_l} := \{p + v \mid p \in \mathbf{e}^{\text{Shr}}, v \perp \mathbf{e}, \text{ and } |v| < 2\rho\tilde{\eta}_l\}.$$

For $\mathbf{f} \in (\mathcal{T}_x)_2$, set

$$\mathbf{f}^{\rho\tilde{\eta}_l} := \{x \in \mathbf{f} \mid \text{dist}(x, \partial\mathbf{f}) > \rho\tilde{\eta}_l\}.$$

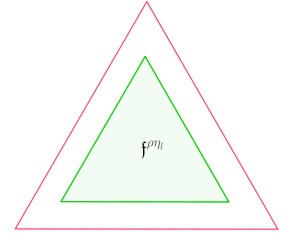

Definition 11.18 (see Figure 27). Let $\mathcal{O}(\mathcal{T})$ be a triangulation cover of an $\tilde{\eta}_l$ -geometric triangulation \mathcal{T} . Given $\rho, d > 0$ we say that $\mathcal{O}(\mathcal{T})$ is $(\tilde{\eta}_l; \rho, d)$ -geometric provided:

1. For all $\mathbf{v} \in \mathcal{T}_0$, $g_{\mathcal{O}, \mathcal{T}}(\mathbf{v}) = B(\mathbf{v}, 50\rho\tilde{\eta}_l)$.
2. For all $\mathbf{e} \in \mathcal{T}_1$, $g_{\mathcal{O}, \mathcal{T}}(\mathbf{e}) = \mathbf{e}^{\rho\tilde{\eta}_l}$.
3. For all $\mathbf{f} \in \mathcal{T}_2$, $g_{\mathcal{O}, \mathcal{T}}(\mathbf{f}) = \mathbf{f}^{\rho\tilde{\eta}_l}$.
4. Each of the three collections,

$$\{g_{\mathcal{O}, \mathcal{T}}(\mathbf{v})\}_{\mathbf{v} \in \mathcal{T}_0}, \{g_{\mathcal{O}, \mathcal{T}}(\mathbf{e})\}_{\mathbf{e} \in \mathcal{T}_1}, \text{ and } \{g_{\mathcal{O}, \mathcal{T}}(\mathbf{f})\}_{\mathbf{f} \in \mathcal{T}_2}$$

is $d\tilde{\eta}_l$ -separated.

Combining Proposition 11.9 with this definition gives us

Corollary 11.19. There exist universal constants $\rho, d > 0$ so that for any $\tilde{\eta}_l$ -geometric triangulation \mathcal{T} there is an $(\tilde{\eta}_l; \rho, d)$ -geometric triangulation cover $\mathcal{O}(\mathcal{T})$ of \mathcal{T} . Moreover, if $\mathcal{O}(\tilde{\mathcal{T}})$ is any $(\tilde{\eta}_l; \rho, d)$ -geometric triangulation cover of a subcomplex $\tilde{\mathcal{T}} \subset \mathcal{T}$, then $\mathcal{O}(\tilde{\mathcal{T}})$ extends to an $(\tilde{\eta}_l; \rho, d)$ -geometric triangulation cover of \mathcal{T} .

Since the constants ρ and d are universal, for brevity we will omit them from the notation and refer to these covers as $\tilde{\eta}_l$ -geometric triangulation covers. Next we record the following method of getting a cotriangulation from a triangulation, which is canonical up to a Gromov-Hausdorff error.

Definition 11.20 (see Figures 28 and 34). *For $k \leq l$, let \mathcal{T}^k be an $\tilde{\eta}_l$ -geometric triangulation in $p_{F_k}(F_k^+)$ with $\tilde{\eta}_l$ -geometric triangulation cover $\mathcal{O}(\mathcal{T})$. A cosimplex S that is subordinate to F^+ and generated by a $U \in \mathcal{O}(\mathcal{T})$ via (9.4.1) is called a **standard local $\tilde{\eta}_l$ -cosimplex associated to (F, \mathcal{T})** . A collection $\mathcal{S} = \mathcal{V} \cup \mathcal{E} \cup \mathcal{F}$ of **standard local $\tilde{\eta}_l$ -cosimplices** is called a **standard local $\tilde{\eta}_l$ -cotriangulation**, provided the collection \mathcal{V} of covertices is disjoint, the collection \mathcal{E} of coedges is disjoint, and the collection \mathcal{F} of cofaces is disjoint. Otherwise, we call \mathcal{S} a **standard local precotriangulation**.*

Definition 11.21. (cf Definition 11.8) *Let \mathcal{S}_k be a standard local cotriangulation associated to (F_k, \mathcal{T}^k) . An extension $(\mathcal{S}_k)_x$ of \mathcal{S}_k is called a **buffer** of \mathcal{S}_k provided $(\mathcal{S}_k)_x$ is a standard local cotriangulation associated to $(F_k^+, (\mathcal{T}^k)_x)$.*

The following corollaries follow by combining these definitions with the fact that $\tilde{\eta}_l \geq \frac{\beta_l}{500}$, and our global hypothesis that κ and \varkappa are sufficiently small.

Corollary 11.22. *Let \mathcal{T} be an $\tilde{\eta}_l$ -geometric triangulation in $p_{F_l}(F_l^+)$. Given any $K_{\mathcal{T}} \subset \mathcal{T}$, there is a respectful, standard local $\tilde{\eta}_l$ -cotriangulation $\mathcal{S}(\mathcal{T})$ associated to (F_l, \mathcal{T}) whose generating set is $K_{\mathcal{T}}$ and whose cosimplices are defined using the submersion p_{F_l} . Moreover, setting $|K_{\mathcal{T}}| := \cup_{s \in K_{\mathcal{T}}} |s|$, if*

$$p_{F_l}(F_l) \subset |K_{\mathcal{T}}|,$$

then $\mathcal{S}(\mathcal{T})$ covers F_l^- .

Corollary 11.23. *Let $\mathcal{S} = \mathcal{V} \cup \mathcal{E} \cup \mathcal{F}$ be a standard local $\tilde{\eta}_l$ -precotriangulation associated to $(F_l(\beta_l), \mathcal{T})$. Then \mathcal{S} is a cotriangulation, provided κ and \varkappa are sufficiently small. Moreover, if the cofaces $F \in \mathcal{F}$ that intersect $\cup \left(\mathcal{A}^0(\tilde{\mathcal{G}}^l) \cup \mathcal{A}^1(\tilde{\mathcal{G}}^l) \right)$ satisfy Part 4 of Definition 10.6, then \mathcal{S} is relative to $\mathcal{L}\mathcal{G}^l \cup \mathcal{B}\tilde{\mathcal{G}}^l$.*

11.24. Geometric Cotriangulations. In this subsection, we define geometric cotriangulations and establish some of their key properties. The most important is that we can use Lemmas 5.7 and 5.10 to deform many of them to respectful cotriangulations (see Lemma 11.27 below).

Definition 11.25 (Geometric Cotriangulations). *Let*

$$\mathcal{S} = \mathcal{V} \cup \mathcal{E} \cup \mathcal{F} = \bigcup_{i=1}^l \mathcal{S}_i = \bigcup_{i=1}^l (\mathcal{V}_i \cup \mathcal{E}_i \cup \mathcal{F}_i)$$

be a cotriangulation that is subordinate to $\{F_i(\beta_i)\}_{i=1}^l$. For $l \leq m$, we say that \mathcal{S} is $\tilde{\eta}_m$ -geometric provided for $k \in \{1, \dots, l\}$:

1. *There is a standard local cotriangulation whose Gromov-Hausdorff distance from \mathcal{S}_k is no more than $\tau(\kappa\tilde{\eta}_m)$.*

2. Let the triangulation \mathcal{T}^k that generates \mathcal{S}_k have buffer \mathcal{T}_x^k . Then \mathcal{T}_x^k generates a buffer $(\mathcal{S}_k)_x$ of \mathcal{S}_k which also has Gromov-Hausdorff distance at most $\tau(\kappa\tilde{\eta}_m)$ -from a standard local cotriangulation.

In the remainder of this subsection we let $\mathcal{S} = \mathcal{V} \cup \mathcal{E} \cup \mathcal{F}$ be an $\tilde{\eta}_l$ -geometric cotriangulation subordinate to $\{F_i(\beta_i)\}_{i=1}^l$ and explain why, with a few additional hypotheses, \mathcal{S} can be deformed to be respectful. To do this, we will deform the submersions of neighboring cosimplices so that they are lined up and then use the following corollary to Lemma 5.10 to obtain a respectful collection.

Corollary 11.26. *Suppose all pairs (L, q_L) , (H, q_H) of l -framed and h -framed sets with $l < h$ and $L \cap H \neq \emptyset$ in \mathcal{S} are lined up on $L \cap \{H \setminus H^-\}$. Then we can choose fiber exhaustion functions for the covertices and coedges of \mathcal{S} so that \mathcal{S} is a respectful framed collection.*

We can now state the main result of this subsection, which provides a criterion for when a geometric cotriangulation can be deformed to a respectful geometric cotriangulation.

Lemma 11.27. *There is a $C > 1$ with the following property. Let $\mathcal{S} = \cup_{i=1}^l \mathcal{S}_i$ be an $\tilde{\eta}_l$ -geometric cotriangulation that is subordinate to $\{F_i^+\}_{i=1}^l$. Set*

$$\mathcal{I} := \left\{ S \in \bigcup_{i=1}^{l-1} \mathcal{S}_i \mid S \cap (\cup \mathcal{S}_i) \neq \emptyset \right\}.$$

Suppose that $\bigcup_{i=1}^{l-1} \mathcal{S}_i$ is respectful and every cosimplex of \mathcal{S}_i is defined via the submersion p_{F_i} .

If \varkappa and κ are sufficiently small, then there is a respectful geometric cotriangulation $\tilde{\mathcal{S}} = \cup_{i=1}^l \tilde{\mathcal{S}}_i$ subordinate to $\{F_i(\beta_i^+)\}_{i=1}^l$ and a bijection

$$\begin{aligned} \mathcal{S} &\rightarrow \tilde{\mathcal{S}} \\ (S, q_S) &\mapsto (\tilde{S}, q_{\tilde{S}}) \end{aligned}$$

that have the following properties:

- a:** If $S \in \mathcal{S} \setminus \mathcal{I}$, then $(\tilde{S}, q_{\tilde{S}}) = (S, q_S)$.
- b:** For $S \in \mathcal{I}$, $q_{\tilde{S}} = q_S$ on $\{S \setminus \cup \mathcal{S}_i\}$.
- c:** For $S \in \mathcal{I}$ and any open $U \subset S$, if $q_S|_U$ is \varkappa -almost Riemannian and κ -lined up with p_{F_l} , then $q_{\tilde{S}}|_U$ is $\tilde{\varkappa}$ -almost Riemannian and $\tilde{\kappa}$ -lined with p_{F_l} , where

$$\tilde{\varkappa} := \varkappa + \kappa(1 + 2C) \quad \text{and} \quad \tilde{\kappa} := \kappa(2 + 2C). \quad (11.27.1)$$

Set

$$\mathcal{I}^l := \{S \cap F_l^+ \mid S \in \mathcal{I}\}.$$

Since the cosimplices of \mathcal{I}^l are lined up and subordinate to F_l^+ , it follows from Proposition 5.14 that there is a submersion

$$P : \cup \mathcal{I}^l \longrightarrow \mathbb{R}^2 \quad (11.27.2)$$

that is lined up with each of the submersions q_S that define the cosimplices of \mathcal{I}^l .

The definition of geometric cotriangulation and the hypothesis that $\{F_i(\beta_i)\}_{i=1}^l$ is vertically separated imply that there is a universal constant $C > 1$ so that (5.7.1) holds with $W = \cup \mathcal{I}^l \cap (\cup \mathcal{S}_i^-)$, $U = \cup \mathcal{I}^{l,+} \cap (\cup \mathcal{S}_i)$, and $\Omega := \cup \mathcal{I}^{l,+}$. Applying the Submersion Deformation Lemma we then get

Lemma 11.28. *If \varkappa and κ are sufficiently small then, there is a Riemannian submersion $\tilde{P} : \cup \mathcal{I}^{l,+} \rightarrow \mathbb{R}^2$ and a diffeomorphism $T_l : \mathbb{R}^2 \rightarrow \mathbb{R}^2$ so that*

$$\tilde{P} = \begin{cases} T_l \circ p_{F_l} & \text{on } \cup \mathcal{I}^l \cap (\cup \mathcal{S}_i^-) \\ P & \text{on } \cup \mathcal{I}^{l,+} \setminus \cup \mathcal{S}_i. \end{cases} \quad (11.28.1)$$

Moreover, for any open $U \subset \cup \mathcal{I}^{l,+}$, if $P|_U$ is \varkappa -almost Riemannian and κ -lined with p_{F_l} , then $\tilde{P}|_U$ is $\tilde{\varkappa}$ -almost Riemannian and $\tilde{\kappa}$ -lined with p_{F_l} , where $\tilde{\varkappa}$ and $\tilde{\kappa}$ are as in (11.27.1).

Proof of Lemma 11.27. Given $S \in \mathcal{I}$, there is a diffeomorphism $T_S : \mathbb{R}^2 \rightarrow \mathbb{R}^2$ so that on $S \cap F_l^+$, $q_S = T_S \circ P$, where P is as in (11.27.2). Set

$$\tilde{q}_S = \begin{cases} T_S \circ \tilde{P} & \text{on } F_l^+ \cap S \\ q_S & \text{on } S \setminus \cup \mathcal{S}_i, \end{cases} \quad (11.28.2)$$

where \tilde{P} is as in Lemma 11.28. Since the elements of \mathcal{S}_i are undeformed, it follows from (11.28.1) and (11.28.2) that \tilde{q}_S is lined up with each element of \mathcal{S}_i that intersects S . It also follows from (11.28.2) that the process of replacing each q_S with \tilde{q}_S does not alter the fact that the collection $\bigcup_{i=1}^{l-1} \mathcal{S}_i$ is lined up.

Conclusion a holds since we only deform the cosimplices of \mathcal{I} . Conclusion b holds since $\tilde{q}_S = q_S$ on $\{S \setminus \cup \mathcal{S}_i\}$. Conclusion c follows from the ‘‘moreover’’ conclusion of Lemma 11.28. \square

12. HOW TO CONSTRUCT COTRIANGULATIONS

In this section, we complete the proof of Covering Lemma 2. By Proposition 10.7 it suffices to prove Lemma 10.8.

Recall that $\mathcal{L}\mathcal{G}^l$ and $\mathcal{B}\tilde{\mathcal{G}}^l$ are the cographs from Corollary 10.3 and Equation (10.5.3). By Proposition 11.9 a geometric cotriangulation that is relative to $\mathcal{L}\mathcal{G}^{\tilde{L}} \cup \mathcal{B}\tilde{\mathcal{G}}^{\tilde{L}}$ automatically satisfies (10.6.1). Thus it suffices to prove

Lemma 12.1. *For each $l = 1, 2, \dots, \tilde{L}$, there is a respectful $\tilde{\eta}_l$ -geometric cotriangulation $\mathcal{S}^l = \mathcal{V}^l \cup \mathcal{E}^l \cup \mathcal{F}^l$ that is subordinate to $\{F_i(\beta_i^+)\}_{i=1}^l$ and relative to $\mathcal{L}\mathcal{G}^l \cup \mathcal{B}\tilde{\mathcal{G}}^l$.*

The proof is by induction. As in Part 1, the main ingredients of the proof are extension and subdivision lemmas. They are stated below as Lemmas 12.7 and 12.17.

The induction is anchored by taking an $\tilde{\eta}_1$ -CDG that covers $p_{F_1}(F_1)$ and contains $\mathcal{L}\mathcal{G}^1$ and $\mathcal{B}\tilde{\mathcal{G}}^1$ and then applying Corollary 11.22 to get an associated standard local $\tilde{\eta}_1$ -cotriangulation \mathcal{S}^1 that covers F_1^- .

For an outline of the induction step, assume that \mathcal{S}^{l-1} is a respectful $\tilde{\eta}_{l-1}$ -geometric cotriangulation subordinate to $\{F_i(\beta_i^+)\}_{i=1}^{l-1}$. In the event that $\tilde{\eta}_l < \tilde{\eta}_{l-1}$, we use the Subdivision Lemma to replace \mathcal{S}^{l-1} with an $\tilde{\eta}_l$ -geometric cotriangulation $\tilde{\mathcal{S}}^{l-1}$ subordinate to $\{F_i(\beta_i^+)\}_{i=1}^{l-1}$

(see Figure 38). We then use the Extension Lemma to extend $\tilde{\mathcal{S}}^{l-1}$ to an $\tilde{\eta}_l$ -geometric cotriangulation $\tilde{\mathcal{S}}^l$ subordinate to $\{F_i(\beta_i^+)\}_{i=1}^l$. If $\tilde{\eta}_l = \tilde{\eta}_{l-1}$, the procedure is the same except that we skip the subdivision step.

The first step in the proof of the Extension Lemma is to project $\tilde{\mathcal{S}}^{l-1}$ to F_l using p_{F_l} . This yields an $(\tilde{\eta}_l, \delta\tilde{\eta}_l, \varepsilon)$ -CDG, $\mathcal{T}^{\text{pr},l}$, where the errors, δ and ε depend on \varkappa and κ . Since the cardinality \tilde{L} of \mathcal{A}^2 has no known relationship with \varkappa and κ , we need a way to see that these errors do not accumulate to something significant. This is the role played by the as yet undefined term, **error correcting cotriangulation**. We define this term in the next subsection where we also state and prove the Extension Lemma. In Subsection 12.14, we state and prove the Subdivision Lemma, and in Subsection 12.19, we complete the proof of Lemma 12.1.

12.2. Error Correcting Cotriangulations and the Extension Lemma. In this subsection, we state and prove the Extension Lemma. Before doing this we define the term **error correcting cotriangulation**. This also requires several preliminary notions.

To start, notice that Theorem 11.14 accepts a ξ -stable $(\eta, \delta\eta, \varepsilon)$ -CDG as its input and extends it to a ξ -stable $(\eta, \delta\eta, \varepsilon)$ -CDG for which the new simplices are error free. This motivates

Definition 12.3. *If \mathcal{T} and $\tilde{\mathcal{T}}$ are related as in Theorem 11.14, then we will say that $\tilde{\mathcal{T}}$ is an **error correcting extension** of \mathcal{T} .*

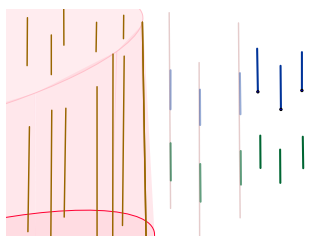

Figure 39. The Extension Process: The long brown segments are vertex fibers of the existing cotriangulation. The short segments are extensions of the brown vertex fibers to two different 2-framed sets. The vertical splitting depicted here is caused by a bifurcation of the 2-strained points (cf Figure 8). The long pink segments are part of the buffer of the existing, pink-brown, cotriangulation. Its presence is necessitated by technicalities involved with extending Delaunay triangulations of Gromov sets (cf Figure 37). For a more detailed, blown up version of this region see Figure 40.

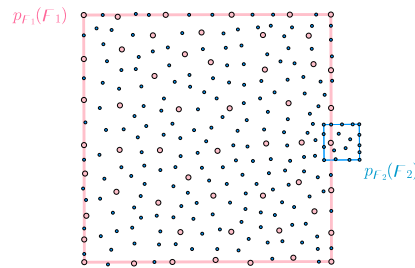

Figure 38. The pink and blue rectangles are the images of two 2-framed sets $F_1(\beta_1)$ and $F_2(\beta_1)$. The pink set is roughly a $\frac{\beta_1}{8}$ -Gromov subset of $p_{F_1}(F_1(\beta_1))$, but only it intersects $p_{F_2}(F_2(\beta_2))$ in one point. Thus we add the blue points to the pink points to obtain a Gromov subset that is at an appropriate scale for the blue set.

Before proceeding further we detail the process mentioned above wherein we project a geometric cotriangulation to get an almost CDG. To do so, for $k \geq l-1$, let $\mathcal{S} = \cup_{i=1}^{l-1} \mathcal{S}_i$ be an $\tilde{\eta}_k$ -geometric cotriangulation that is subordinate to $\{F_i(\beta_i^+)\}_{i=1}^{l-1} \subset \mathcal{A}^2$. For $\mathbf{v} \in (K_{\mathcal{T}^i})_0$, let $q_{\mathbf{v}}$ be the submersion that defines the covertex that corresponds to \mathbf{v} . We call the set of vertex fibers

$$\text{VF} := \bigcup_{i=1}^{l-1} \{q_{\mathbf{v}}^{-1}(\mathbf{v}) \mid \mathbf{v} \in (K_{\mathcal{T}^i})_0\}, \quad (12.3.1)$$

and define

$$\mathcal{T}_0^{\text{pr},l} := p_{F_l}(\text{VF}).$$

Strictly speaking, the elements of $\mathcal{T}_0^{\text{pr},l}$ are not points. So a triangulation of $\mathcal{T}_0^{\text{pr},l}$ is, technically, an abstract simplicial complex rather than a complex in \mathbb{R}^2 . However, since our 2-framed sets are κ -lined up, the elements of

$\mathcal{T}_0^{\text{pr},l}$ all have diameter less than $\tau(2\kappa\beta_l)$. To avoid excess technicalities we will treat the elements of $\mathcal{T}_0^{\text{pr},l}$ as though they were points, with no further comment.

Let $\mathcal{T}^{\text{pr},l}$ be the triangulation of $\mathcal{T}_0^{\text{pr},l}$ in which two vertices are connected by an edge if and only if the corresponding covertices intersect a common coedge. Define buffers $(K_{\mathcal{T}^i})_x$, VF_x , and $\mathcal{T}_x^{\text{pr},l}$ analogously. Before stating the definition of error correcting cotriangulation, we need two more notions.

Definition 12.4. *Let $S \in \mathcal{V} \cup \mathcal{E}$ be generated by $\mathfrak{s} \in \mathcal{K}_{\mathcal{T}^i} \subset \mathcal{T}^i$. If $\mathfrak{s} \in \partial\mathcal{T}^i$, then we say that S is a boundary cosimplex of \mathcal{S} , and we let $\partial\mathcal{V}$, $\partial\mathcal{E}$, and $\partial\mathcal{S}$ be the collection of all boundary covertices, coedges, and cosimplices, respectively.*

Definition 12.5. *Let $S \in \mathcal{S}_i \subset \mathcal{S}$. If q_S is $\tilde{\varkappa}$ -almost Riemannian and $\tilde{\kappa}$ -lined up with p_{F_i} , then we say that S is $(\tilde{\varkappa}, \tilde{\kappa})$ -deformed. For $U \subset S$, we say that q_S is undeformed on U if $q_S|_U$ and $p_{F_i}|_U$ are lined up. If q_S is undeformed on S , then we say that S is undeformed.*

Definition 12.6. (Error Correcting Cotriangulations) *For $k \geq l$, let*

$$\mathcal{S} = \mathcal{V} \cup \mathcal{E} \cup \mathcal{F} = \bigcup_{i=1}^l \mathcal{S}_i$$

be a respectful $\tilde{\eta}_k$ -geometric cotriangulation that is subordinate to $\{F_i(\beta_i)\}_{i=1}^l$. We say that \mathcal{S} is **error correcting** provided for each $j_0 \in \{1, 2, \dots, l\}$,

1. The triangulation \mathcal{T}^{j_0} associated to \mathcal{S}_{j_0} is an error correcting extension of $\mathcal{T}^{\text{pr},j_0}$.
2. The generating set $K_{\mathcal{T}^{j_0}}$ for \mathcal{S}_{j_0} is

$$K_{\mathcal{T}^{j_0}} = \mathcal{T}^{j_0} \setminus \mathcal{T}^{\text{pr},j_0}.$$

3. Every $S \in \mathcal{S} \setminus \partial\mathcal{S}$ is undeformed.
4. Every element of $E \in \partial\mathcal{E}$ is undeformed on $(E \setminus \cup \mathfrak{F}(E)^+)$, where $\mathfrak{F}(E)$ is the set of the cofaces $F \in \mathcal{F}$ that intersect E .
5. For every covertex of $V \in \partial(\mathcal{V})$, q_V is undeformed on $V \setminus (\cup \mathfrak{E}(V)^+ \cup \cup \mathfrak{F}(V)^+)$, where $\mathfrak{E}(V)$ and $\mathfrak{F}(V)$ are the sets of coedges and cofaces that intersect V .
6. For every covertex of $V \in \partial(\mathcal{V})$, q_V is at most (\varkappa_2, κ_2) -deformed everywhere and at most (\varkappa_1, κ_1) -deformed on $V \setminus (\cup \mathfrak{F}(V)^+)$, where

$$\begin{aligned} \varkappa_1 & : = \varkappa + \kappa(1 + 2C), \quad \kappa_1 := \kappa(2 + 2C), \\ \varkappa_2 & : = \varkappa_1 + \kappa_1(1 + 2C), \quad \kappa_2 := \kappa_1(2 + 2C) \end{aligned}$$

and C is the constant from Lemma 11.27.

We can now state the Extension Lemma.

Lemma 12.7. (Extension Lemma) *Let $\mathcal{S} = \mathcal{V} \cup \mathcal{E} \cup \mathcal{F}$ be an error correcting, $\tilde{\eta}_l$ -geometric cotriangulation which is subordinate to $\{F_i(\beta_i^+)\}_{i=1}^{l-1}$ and relative to $\mathcal{L}\mathcal{G}^l \cup \mathcal{B}\tilde{\mathcal{G}}^l$.*

Then \mathcal{S} extends to an error correcting, $\tilde{\eta}_l$ -geometric cotriangulation $\tilde{\mathcal{S}} = \tilde{\mathcal{V}} \cup \tilde{\mathcal{E}} \cup \tilde{\mathcal{F}}$ which is subordinate to $\{F_i(\beta_i^+)\}_{i=1}^{l-1} \cup \{F_l(\beta_l^+)\}$ and relative to $\mathcal{L}\mathcal{G}^l \cup \mathcal{B}\tilde{\mathcal{G}}^l$.

To begin the proof, define

$$\mathrm{VF}_i(\nu) := \{q_{\mathbf{v}}^{-1}(\mathbf{v}) \cap F_i(\beta_i, \nu) \mid q_{\mathbf{v}}^{-1}(\mathbf{v}) \in \mathrm{VF}\},$$

and let $\mathrm{VT}_i(\nu)$ be the simplicial complex whose vertex set is $\mathrm{VF}_i(\nu)$ and whose edge set is pairs of fibers in $\mathrm{VF}_i(\nu)$ whose corresponding covertices intersect a common coedge. Define buffers $\mathrm{VF}_i(\nu)_x$ and $\mathrm{VT}_i(\nu)_x$ analogously. The error correcting hypothesis implies that $\mathrm{VT}_i(\nu)$ is geometrically similar to a CDG. To formulate this precisely, we propose

Definition 12.8. *A simplicial complex is **metric** provided the vertex set \mathcal{T}_0 is a subset of a metric space X .*

Definition 12.9. *We say that a 2-dimensional simplicial complex is **surface-like** provided each edge e is contained in at most two 2-simplices.*

Definition 12.10. *Let \mathcal{T} be 2-dimensional simplicial complex which is metric and surface-like. Let e be an edge of \mathcal{T} which bounds two faces. We say that e passes the ε -**angle flip test** if and only if the sum of the comparison angles opposite e is $\leq \pi + \varepsilon$, where our comparison triangles are in \mathbb{R}^2 .*

Definition 12.11. *Let \mathcal{T} be 2-dimensional simplicial complex which is metric and surface-like. We say that \mathcal{T} is an **abstract** $(\eta, \delta\eta, \varepsilon)$ -**CDG** provided \mathcal{T}_0 is an $(\eta, \delta\eta)$ -Gromov subset of X and each edge passes the ε -angle flip test.*

Next we prove that for each $j_0 \in \{1, \dots, l\}$, $\mathrm{VT}_{j_0}(\beta_l^+)$ is an abstract CDG with respect to the following metric: For any $q_{\mathbf{v}}^{-1}(\mathbf{v}), q_{\tilde{\mathbf{v}}}^{-1}(\tilde{\mathbf{v}}) \in \mathrm{VT}_{j_0}(\beta_l^+)$, choose any point in $x_0 \in q_{\mathbf{v}}^{-1}(\mathbf{v}) \cap F_{j_0}(\beta_{j_0}, \beta_l)$ and define

$$\mathrm{dist}(q_{\mathbf{v}}^{-1}(\mathbf{v}), q_{\tilde{\mathbf{v}}}^{-1}(\tilde{\mathbf{v}})) := \mathrm{dist}(x_0, q_{\tilde{\mathbf{v}}}^{-1}(\tilde{\mathbf{v}}) \cap F_{j_0}(\beta_{j_0}, 5\beta_l)). \quad (12.11.1)$$

Of course this definition depends on the many possible choices of x_0 , but since the $q_{\mathbf{v}}$ are $3\kappa_2$ -lined up \varkappa_2 -almost Riemannian submersions, the fibers are almost equidistant. So regardless of these choices we have

Lemma 12.12. *If \mathcal{S} is an error correcting $\tilde{\eta}_l$ -geometric cotriangulation that is subordinate to $\{F_i^+\}_{i=1}^{l-1}$, then for all $j_0 \in \{1, 2, \dots, l-1\}$, $\mathrm{VT}_{j_0}(\beta_l^+)$ is an abstract $(\tilde{\eta}_l, \tilde{\eta}_l\delta, \tau(\delta))$ -CDG, for $\delta = 1 - \varkappa_2 - 5,000\kappa_2$.*

Remark. *The quantity $\tau(\delta)$ of the previous lemma is universal in the sense that it only depends on δ .*

Proof. It follows from the definition of error correcting cotriangulations and (5.13.1) that $\mathrm{VF}_{j_0}(\beta_l^+)$ is $\tilde{\eta}_l(1 + \varkappa_2)$ dense in $F_{j_0}(\beta_{j_0}, \beta_l^+)$. We will show that the vertex fibers $q_{\mathbf{v}_i}^{-1}(\mathbf{v}_i), q_{\mathbf{v}_j}^{-1}(\mathbf{v}_j)$ of the buffer $(\mathrm{VT}_{j_0}(\beta_l^+))_x$ of $\mathrm{VT}_{j_0}(\beta_l^+)$ are $(\tilde{\eta}_l(1 - \varkappa_2) - 9\kappa_2\beta_l^+)$ -separated, and if a pair is connected by an edge, then the distance between them lies in the interval

$$[\tilde{\eta}_l(1 - \varkappa_2) - 9\kappa_2\beta_l^+, 2\tilde{\eta}_l(1 + \varkappa_2)].$$

Since $\beta_l^+ \leq 501\tilde{\eta}_l$, it will then follow that our vertex fibers are $\delta\tilde{\eta}_l$ -separated, where $\delta = 1 - \varkappa_2 - 5,000\kappa_2$, and if a pair is connected by an edge, then the distance between them lies in the interval

$$[\tilde{\eta}_l(1 - \delta), 2\tilde{\eta}_l(1 + \varkappa_2)].$$

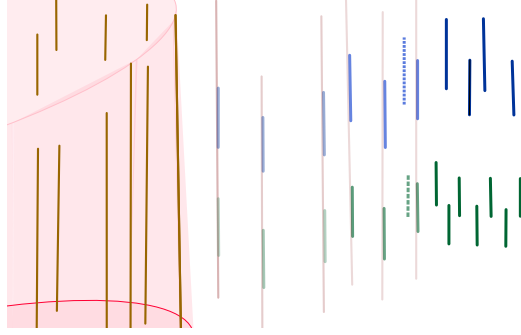

Figure 40. Buffer Blown Up: It follows from Part 3 of Theorem 11.14 that no new vertex fibers are added to the part of the buffer (light blue and light grey-green) that is within $3\tilde{\eta}_l$ of the existing cotriangulation. However, the buffer extends out to the $6\tilde{\eta}_l$ neighborhood. New vertex fibers (the broken segments) can be added that are further than $3\tilde{\eta}_l$ from the old cotriangulation, but are still in the buffer region. This would only happen if an old edge was originally almost length $2\tilde{\eta}_l$ and was lengthened by the lifting and projecting process. The codege set can also change in the buffer region.

By combining the definition of error correcting cotriangulation with Proposition 5.12 we see that both estimates hold when $j_0 = 1$. Assume that both statements hold for $j_0 \leq k-1 \leq l-2$.

Let $\mathcal{S} = \cup_{i=1}^{l-1} \mathcal{S}_i$ be the decomposition of \mathcal{S} into local cotriangulations. Suppose

$$\mathbf{v}_i \in (K_{\mathcal{T}^i})_x, \mathbf{v}_j \in (K_{\mathcal{T}^j})_x \text{ and } i \leq j \leq k. \quad (12.12.1)$$

If $j \leq k-1$, then by induction the required estimates hold.

Otherwise, $\mathbf{v}_j \in (K_{\mathcal{T}^k})_x \setminus (\mathcal{T}_x^{\text{pr},k})_0$ (cf Figure 39). Set $\tilde{\mathbf{v}}_i = p_{F_k}(q_{\mathbf{v}_i}^{-1}(\mathbf{v}_i))$. The definition of error correcting cotriangulation then gives us that $\text{dist}(\tilde{\mathbf{v}}_i, \mathbf{v}_j) \geq \tilde{\eta}_l$. Together with (5.13.3), this gives us that $q_{\mathbf{v}_i}^{-1}(\mathbf{v}_i)$ and $q_{\mathbf{v}_j}^{-1}(\mathbf{v}_j)$ are $(\tilde{\eta}_l(1 - \varkappa_2) - 9\kappa_2\beta_l^+)$ -separated with respect to the metric of (12.11.1). If, in addition, $q_{\mathbf{v}_i}^{-1}(\mathbf{v}_i)$ and $q_{\mathbf{v}_j}^{-1}(\mathbf{v}_j)$ are connected by an edge, then $\tilde{\mathbf{v}}_i$ and \mathbf{v}_j are connected by an edge of \mathcal{T}^k , which by Part 6 of Theorem 11.14 has length $\leq 2\tilde{\eta}_l$. So, as before, (5.13.1) gives us that $\text{dist}(q_{\mathbf{v}_i}^{-1}(\mathbf{v}_i), q_{\mathbf{v}_j}^{-1}(\mathbf{v}_j)) \leq 2\tilde{\eta}_l(1 + \varkappa_2)$.

It remains to prove that the edges of $\text{VT}_{j_0}(\beta_l^+)$ pass the $\tau(\delta)$ -comparison angle flip test. The proof is also by induction and the case $j_0 = 1$ is a consequence of Proposition 5.12. We take

$$\mathbf{v}_i \in K_{\mathcal{T}^i}, \mathbf{v}_j \in K_{\mathcal{T}^j} \text{ with } i \leq j \leq k$$

and assume that $q_{\mathbf{v}_i}^{-1}(\mathbf{v}_i)$ and $q_{\mathbf{v}_j}^{-1}(\mathbf{v}_j)$ are connected by an edge of $\text{VT}_k(\beta_l^+)$. By induction we may assume that $j = k$ and hence that $\mathbf{v}_j \in K_{\mathcal{T}^k} := \mathcal{T}^k \setminus \mathcal{T}^{\text{pr},k}$, so by Part 5 of Theorem 11.14, the edge $\tilde{\mathbf{v}}_i\mathbf{v}_j$ is Delaunay. This, together with Lemma 5.13, gives us that the edge between $q_{\mathbf{v}_i}^{-1}(\mathbf{v}_i)$ and $q_{\mathbf{v}_j}^{-1}(\mathbf{v}_j)$ passes the $\tau(\delta)$ -comparison angle flip test. So $\text{VT}_{j_0}(\beta_l^+)$ is an abstract $(\tilde{\eta}_l, \delta\tilde{\eta}_l, \tau(\delta))$ -CDG. \square

Combining the previous lemma with Lemma 5.13 yields

Corollary 12.13. *If \mathcal{S} is an error correcting $\tilde{\eta}_k$ -geometric cotriangulation that is subordinate to $\{F_i^+\}_{i=1}^{l-1}$, then $\mathcal{T}^{\text{pr},l}$ is an $(\tilde{\eta}_k, 2\delta\tilde{\eta}_k, 2\tau(\delta))$ -CDG, where δ and τ are as in the previous lemma.*

Proof of the Extension Lemma. For simplicity, we write η for $\tilde{\eta}_l$. Since $\mathcal{S} = \mathcal{V} \cup \mathcal{E} \cup \mathcal{F}$ is error correcting, Corollary 12.13 gives us that $\mathcal{T}^{\text{pr},l}$ is an $(\eta, 2\delta\eta, 2\tau(\delta))$ -CDG, where δ and τ are as in Corollary 12.13. By Theorem 11.14, $\mathcal{T}^{\text{pr},l}$ has an error correcting extension to an $(\eta, 2\delta\eta, 2\tau(\delta))$ -CDG \mathcal{T}^l which covers $[0, \beta_l] \times [0, \beta_l]$.

Set

$$K_{\mathcal{T}^l} = \mathcal{T}^l \setminus \mathcal{T}^{\text{pr},l}, \quad (12.13.1)$$

and let $\mathcal{S}_l = \mathcal{V}_l \cup \mathcal{E}_l \cup \mathcal{F}_l$ be the standard local cotriangulation whose cosimplices are in one-to-one correspondence with $K_{\mathcal{T}^l}$ and are defined using the submersion p_{F_l} (see Definition 11.20). Since \mathcal{T}^l is an error correcting extension of \mathcal{T}^{pr} , Lemma 5.13 gives us that

$$\begin{aligned} &\text{the intersection of } \mathcal{S} \cup \mathcal{S}_l \text{ with } F_l^+ \text{ is no more than } \tau(\kappa\eta) \text{ from a standard} \\ &\text{local cotriangulation associated to the } \eta\text{-geometric triangulation } \mathcal{T}^l. \end{aligned} \quad (12.13.2)$$

To show that

$$\widehat{\mathcal{S}} := \mathcal{S} \cup \mathcal{S}_l = \mathcal{V} \cup \mathcal{E} \cup \mathcal{F} \cup \mathcal{V}_l \cup \mathcal{E}_l \cup \mathcal{F}_l$$

is a cotriangulation, we combine the fact that \mathcal{S} is a cotriangulation with the following additional arguments.

Proof of Property 1 of Definition 9.5. Since \mathcal{S} is a cotriangulation and \mathcal{S}_l is a local cotriangulation, Property 1 holds \square

Proof of Property 2 of Definition 9.5. The collections \mathcal{V} , \mathcal{E} , and \mathcal{F} are disjoint, by hypothesis, so it suffices to show that the collections \mathcal{V}_l , \mathcal{E}_l , and \mathcal{F}_l of the newly defined coverities, coedges, and cofaces are disjoint from each other and from \mathcal{V} , \mathcal{E} , and \mathcal{F} , respectively. Since each element of \mathcal{V}_l , \mathcal{E}_l , and \mathcal{F}_l is contained in F_l^+ , it is enough to consider the intersection of $\mathcal{S} \cup \mathcal{S}_l$ with F_l^+ .

By combining (12.13.2) with Corollary 11.23, we see that the intersections of each of $\mathcal{V} \cup \mathcal{V}_l$, $\mathcal{E} \cup \mathcal{E}_l$, and $\mathcal{F} \cup \mathcal{F}_l$ with F_l^+ is a disjoint collection, and hence each of $\mathcal{V} \cup \mathcal{V}_l$, $\mathcal{E} \cup \mathcal{E}_l$, and $\mathcal{F} \cup \mathcal{F}_l$ is a disjoint collection. \square

Proof of Property 3 of Definition 9.5. By hypothesis, \mathcal{S} covers $\cup_{i=1}^{l-1} F_i(\beta_i^-)$. Since $|\mathcal{T}^l|$ covers $p_{F_l}(F_l(\beta_l))$, Corollary 11.22, (12.13.1), and (12.13.2) together imply that $\widehat{\mathcal{S}}$ covers $F_l(\beta_l^-)$. \square

Thus $\widehat{\mathcal{S}}$ is a cotriangulation. By construction, $\widehat{\mathcal{S}}$ is $\tilde{\eta}_l$ -geometric. Our original cotriangulation, \mathcal{S} , is relative to $\mathcal{L}\mathcal{G}^l \cup \mathcal{B}\tilde{\mathcal{G}}^l$, so it contains the intersection of $\mathcal{L}\mathcal{G}^l \cup \mathcal{B}\tilde{\mathcal{G}}^l$ with $\cup_{i=1}^{l-1} F_i(\beta_i^+)$. Since Part 4 of Theorem 11.14 guarantees that \mathcal{T}^l contains all legal subgraphs of $\mathcal{T}^{\text{pr},l}$, we can choose \mathcal{T}^l to contain the graphs that generate $\mathcal{L}\mathcal{G}^l \cup \mathcal{B}\tilde{\mathcal{G}}^l$. This, together with (12.13.2), Corollary 11.23, and the fact that the cosimplices of \mathcal{S}_l are defined using the submersion p_{F_l} gives us that $\widehat{\mathcal{S}}$ is relative to $\mathcal{L}\mathcal{G}^l \cup \mathcal{B}\tilde{\mathcal{G}}^l$.

Our original cotriangulation, \mathcal{S} , is respectful and every cosimplex of \mathcal{S}_l is defined via the submersion p_{F_l} . Together with the fact that \mathcal{S} is η -geometric and error correcting, this gives us that $\widehat{\mathcal{S}}$ satisfies the hypotheses of Lemma 11.27. So there is a deformation $\tilde{\mathcal{S}}$ of $\widehat{\mathcal{S}}$ which is a respectful η -geometric cotriangulation that is subordinate to $\{F_i(\beta_i^+)\}_{i=1}^l$.

Let $\mathcal{I} \subset \widehat{\mathcal{S}}$ be as in Lemma 11.27. Because \mathcal{S} is error correcting, $\mathcal{I} \subset \partial\widehat{\mathcal{S}}$. Combining this with the conclusion of Lemma 11.27, the fact that \mathcal{S} is error correcting, the construction of $\tilde{\mathcal{S}}$, and the fact that $\tilde{\mathcal{S}}$ is respectful and η -geometric, we see that $\tilde{\mathcal{S}}$ is error correcting. \square

12.14. Subdividing Error Correcting Cotriangulations. In this subsection, we explain how to subdivide error correcting cotriangulations. We start with the analogous result for CDGs from [36], which shows how to subdivide an $(\eta, \delta\eta, \varepsilon)$ -CDG in a manner that preserves the error correcting property.

Theorem 12.15. (Theorem 4.23, [36]) *Let \mathcal{T} be an $(\eta, \delta\eta, \varepsilon)$ -CDG in $[0, \beta] \times [0, \beta] \subset \mathbb{R}^2$. If $\tilde{\mathcal{T}}$ is an error correcting extension of \mathcal{T} , then there are subdivisions $\mathcal{L}(\mathcal{T})$, $\mathcal{L}(\tilde{\mathcal{T}})$ of \mathcal{T} and $\tilde{\mathcal{T}}$, respectively, so that*

1. $\mathcal{L}(\mathcal{T})$ and $\mathcal{L}(\tilde{\mathcal{T}})$ are $(\frac{\eta}{10}, \delta\frac{\eta}{10})$ -CDGs.
2. $\mathcal{L}(\tilde{\mathcal{T}})$ is an error correcting extension of $\mathcal{L}(\mathcal{T})$.
3. If $\tilde{G} \subset \tilde{\mathcal{T}}_1$ is a legal subgraph of the 1-skeleton of $\tilde{\mathcal{T}}$ and $\mathcal{L}(\tilde{G})$ is a legal $(\frac{\eta}{10}, \delta\frac{\eta}{10})$ -geometric subdivision of \tilde{G} , then we can choose $\mathcal{L}(\tilde{\mathcal{T}})$ so that it contains $\mathcal{L}(\tilde{G})$.

Let

$$\mathcal{S} = \cup_{i=1}^{l-1} \mathcal{S}_i = \mathcal{V} \cup \mathcal{E} \cup \mathcal{F}$$

be an error correcting, $\tilde{\eta}_{l-1}$ -geometric cotriangulation which is subordinate to $\{F_i(\beta_i^+)\}_{i=1}^{l-1}$ and relative to $\mathcal{L}\mathcal{G}^{l-1} \cup \mathcal{B}\tilde{\mathcal{G}}^{l-1}$. We will explain how to subdivide \mathcal{S} and obtain an error correcting, $\tilde{\eta}_l$ -cotriangulation which is subordinate to $\{F_i(\beta_i^+)\}_{i=1}^{l-1}$ and relative to $\mathcal{L}\mathcal{G}^l \cup \mathcal{B}\tilde{\mathcal{G}}^l$. We make use of the following corollary of Proposition 5.14.

Corollary 12.16. *Let $S \in \mathcal{E}_i \cup \mathcal{F}_i$, and let \mathcal{L}_S be the collection of lower framed cosimplicies that intersect S . There is a submersion*

$$q_S^{\text{ext}} : (S \cup \cup \mathcal{L}_S) \cap F_i \longrightarrow \mathbb{R}^2$$

so that

1. q_S^{ext} extends $q_S|_{S^-}$ and
2. For each $L \in \mathcal{L}_S$, q_S^{ext} is lined up with q_L on $L \setminus S$.

The Procedure:

Since \mathcal{S} is error correcting, for each k , \mathcal{T}^k is an error correcting extension of $\mathcal{T}^{\text{pr},k}$. Thus by Theorem 12.15, there are subdivisions $\mathcal{L}(\mathcal{T}^k)$ and $\mathcal{L}(\mathcal{T}^{\text{pr},k})$ of \mathcal{T}^k and $\mathcal{T}^{\text{pr},k}$, respectively, so that $\mathcal{L}(\mathcal{T}^k)$ is an error correcting extension of $\mathcal{L}(\mathcal{T}^{\text{pr},k})$ and each of $\mathcal{L}(\mathcal{T}^k)$ and $\mathcal{L}(\mathcal{T}^{\text{pr},k})$ is $\frac{\tilde{\eta}_{l-1}}{10}$ -geometric. Set

$$K_{\mathcal{L}(\mathcal{T}^k)} = \mathcal{L}(\mathcal{T}^k) \setminus \mathcal{L}(\mathcal{T}^{\text{pr},k}).$$

Each $\mathfrak{s} \in K_{\mathcal{L}(\mathcal{T}^k)}$ is contained in the interior of a unique $\mathfrak{t}(\mathfrak{s}) \in K_{\mathcal{T}^k}$. Let $S(\mathfrak{s})$ be the standard geometric $\frac{\tilde{\eta}_{l-1}}{10}$ -cosimplex that corresponds to \mathfrak{s} and is defined using the submersion $q_{\mathfrak{t}(\mathfrak{s})}^{\text{ext}}$ (cf Definition 11.20).

The Outcome:

Lemma 12.17. (Subdivision Lemma) *Let $\tilde{\mathcal{S}} = \tilde{\mathcal{V}} \cup \tilde{\mathcal{E}} \cup \tilde{\mathcal{F}}$ be the collection obtained by performing the above procedure $n(l) - n(l-1)$ times, where $n(l)$ is as in (8.2.1). Then $\tilde{\mathcal{S}}$ is an error correcting, $\tilde{\eta}_l$ -geometric cotriangulation that is relative to $\mathcal{L}\mathcal{G}^l \cup \mathcal{B}\tilde{\mathcal{G}}^l$.*

The definition of error correcting cotriangulation together with Lemma 5.13 gives us the following result.

Proposition 12.18. *For $k \geq l-1$, let \mathcal{S} be an error correcting η_k -geometric cotriangulation that is subordinate to $\{F_i(\beta_i)\}_{i=1}^{l-1}$. For $S, \hat{S} \in \mathcal{S}$, if $S \cap \hat{S} = \emptyset$, then $S^{v,+} \cap \hat{S}^{v,+} = \emptyset$. (See (8.13) for the definition of $S^{v,+}$.)*

Proof of Lemma 12.17. Notice that $\cup_{S \in \mathcal{S}} S^{v,-} \subset \cup \tilde{\mathcal{S}}$, so the fact that \mathcal{S} covers $\{F_i(\beta_i^-)\}_{i=1}^{l-1}$ gives us that $\tilde{\mathcal{S}}$ covers $\{F_i(\beta_i^-)\}_{i=1}^{l-1}$.

Write $\tilde{\mathcal{S}}$ for

$$\tilde{\mathcal{V}}, \tilde{\mathcal{E}}, \text{ or } \tilde{\mathcal{F}}.$$

Notice that for $\tilde{S} \in \tilde{\mathcal{S}}$, there is a unique $S \in \mathcal{S}$ so that $|\mathfrak{s}_{\tilde{S}}| \subset |\text{interior}(\mathfrak{s}_S)|$,

$$q_{\tilde{S}} = q_S^{\text{ext}}, \quad (12.18.1)$$

and $\tilde{S} \subset S^{v,+}$. For distinct $\tilde{S}_1, \tilde{S}_2 \in \tilde{\mathcal{S}}$, if $S_1 \cap S_2 = \emptyset$, then by Proposition 12.18, $S_1^{v,+} \cap S_2^{v,+} = \emptyset$. So

$$\tilde{S}_1 \cap \tilde{S}_2 \subset S_1^{v,+} \cap S_2^{v,+} = \emptyset. \quad (12.18.2)$$

Now suppose that for $\tilde{S}_1, \tilde{S}_2 \in \tilde{\mathcal{S}}$, $S_1 \cap S_2 \neq \emptyset$. Then $q_{S_1}^{\text{ext}}$ and $q_{S_2}^{\text{ext}}$ are lined up and $\mathfrak{s}_{\tilde{S}_1} \cap \mathfrak{s}_{\tilde{S}_2} = \emptyset$. This together with $q_{\tilde{S}_1} = q_{S_1}^{\text{ext}}$ and $q_{\tilde{S}_2} = q_{S_2}^{\text{ext}}$ gives us that $\tilde{S}_1 \cap \tilde{S}_2 = \emptyset$. Hence $\tilde{\mathcal{S}}$ is pairwise disjoint.

Since we defined the cosimplices of $\tilde{\mathcal{S}}$ to be geometrically standard using (12.18.1), $\tilde{\mathcal{S}}$ is an $\tilde{\eta}_l$ -geometric cotriangulation. Similarly, using the equation $q_{\tilde{S}} = q_S^{\text{ext}}$ and Lemma 5.10, we can choose fiber exhaustion functions for the cosimplices of $\tilde{\mathcal{S}}$ that make $\tilde{\mathcal{S}}$ respectful. Since \mathcal{S} is error correcting and $\tilde{\mathcal{S}}$ is respectful, it follows from Theorem 12.15 and the construction of $\tilde{\mathcal{S}}$ that $\tilde{\mathcal{S}}$ is error correcting. Our original cotriangulation \mathcal{S} is relative to $\mathcal{L}\mathcal{G}^{l-1} \cup \mathcal{B}\tilde{\mathcal{G}}^{l-1}$. It follows from Part 3 of Theorem 12.15 that we can choose $\tilde{\mathcal{S}}$ to contain $\mathcal{L}\mathcal{G}^l \cup \mathcal{B}\tilde{\mathcal{G}}^l$. This, together with the equation $q_{\tilde{S}} = q_S^{\text{ext}}$ and the fact that $\tilde{\mathcal{S}}$ is $\tilde{\eta}_l$ -geometric, gives us that $\tilde{\mathcal{S}}$ is relative to $\mathcal{L}\mathcal{G}^l \cup \mathcal{B}\tilde{\mathcal{G}}^l$. \square

12.19. Constructing the cotriangulation. In this subsection, we show how to combine the extension and subdivision lemmas to prove Lemma 12.1 and hence Covering Lemma 2.

Proof of Lemma 12.1. Apply the Extension Lemma with $l = 1$ and $\mathcal{S} = \emptyset$ to get an error correcting, $\tilde{\eta}_1$ -geometric cotriangulation \mathcal{S}^1 which is subordinate to $F_1(\beta_1^+)$ and relative to $\mathcal{L}\mathcal{G}^1 \cup \mathcal{B}\tilde{\mathcal{G}}^1$.

Assume, by induction that there is an error correcting, $\tilde{\eta}_{l-1}$ -geometric cotriangulation \mathcal{S}^{l-1} which is subordinate to $\{F_j(\beta_j^+)\}_{j=1}^{l-1}$ and relative to $\mathcal{L}\mathcal{G}^{l-1} \cup \mathcal{B}\tilde{\mathcal{G}}^{l-1}$. Use the Subdivision Lemma (12.17) to subdivide \mathcal{S}^{l-1} to get an error correcting, $\tilde{\eta}_l$ -geometric cotriangulation $\tilde{\mathcal{S}}^{l-1}$. By the Extension Lemma (12.7), $\tilde{\mathcal{S}}^{l-1}$ extends to a respectful, error correcting, geometric cotriangulation \mathcal{S}^l . \square

13. APPENDIX: THE DIFFEOMORPHISM OF THE TOP STRATUM

Part 2 of Limit Lemma G follows from the next result, which we prove in this section. To do so we make liberal use of the notion of stable submersions and their associated concepts as detailed in Definitions 2.1 and 2.2.

Theorem 13.1. *Let \mathcal{B} be as in Covering Lemma 2. There is an $\Omega \subset X_\delta^4$ so that \mathcal{B} respects Ω and is Ω -proper.*

We construct Ω as the union of the following four open sets:

$$\begin{aligned} O_0 & : = \bigcup_{B \in \mathcal{B}^0} B \setminus \bigcup_{B \in \mathcal{B}^0 \cup \mathcal{B}^1 \cup \mathcal{B}^2} \bar{B}^-, \\ O_1 & : = \bigcup_{B \in \mathcal{B}^1} B \setminus \bigcup_{B \in \mathcal{B}^1 \cup \mathcal{B}^2} \bar{B}^-, \\ O_2 & : = \bigcup_{B \in \mathcal{B}^2} B \setminus \bar{B}^-, \text{ and} \\ O_4 & : = X \setminus \bigcup_{B \in \mathcal{B}^0 \cup \mathcal{B}^1 \cup \mathcal{B}^2} \bar{B}^-. \end{aligned}$$

It follows from the Quantitatively Proper Corollary (3.14), (6.4.1), (9.4.1), and Covering Lemma 2 that for $i = 0, 1, 2$, or 4 , $O_i \in X_\delta^4$. Hence for

$$\Omega := O_0 \cup O_1 \cup O_2 \cup O_4,$$

we have $\Omega \in X_\delta^4$. It follows from the construction of Ω that \mathcal{B} is Ω -proper. It remains to show

Theorem 13.2. *There are open sets $\Omega_\alpha \subset M_\alpha$ that converge to $\Omega \subset X$, and for all but finitely many α, β , diffeomorphisms*

$$\Phi_{\beta, \alpha} : \Omega_\alpha \longrightarrow \Omega_\beta,$$

that have the following property.

For $k \in \{0, 1, 2\}$, all $B \in \mathcal{B}^k$, and all but finitely many α, β , there are approximations $B_\alpha, B_\beta \rightarrow B$ so that

$$\Phi_{\beta, \alpha}(B_\alpha \cap \Omega_\alpha) = B_\beta \cap \Omega_\beta. \quad (13.2.1)$$

Moreover, if $p : B \rightarrow \mathbb{R}^k$ and $r : B \rightarrow \mathbb{R}$ are the projection and fiber exhaustion function of B . Then there are approximations $p_\alpha : B_\alpha \rightarrow \mathbb{R}^k$ and $p_\beta : B_\beta \rightarrow \mathbb{R}^k$ of p and $r_\alpha : B_\alpha \rightarrow \mathbb{R}$ and $r_\beta : B_\beta \rightarrow \mathbb{R}$ of r so that

$$p_\beta \circ \Phi_{\beta, \alpha}|_{B_\alpha \cap \Omega_\alpha} = p_\alpha|_{B_\alpha \cap \Omega_\alpha} \text{ and } r_\beta \circ \Phi_{\beta, \alpha}|_{B_\alpha \cap \Omega_\alpha} = r_\alpha|_{B_\alpha \cap \Omega_\alpha}. \quad (13.2.2)$$

The existence of the Ω_α and the diffeomorphisms $\Phi_{\beta, \alpha} : \Omega_\alpha \rightarrow \Omega_\beta$ follows from Theorem 6.1 in [22]. It only remains to show that the $\Phi_{\beta, \alpha}$ can be chosen to satisfy (13.2.1) and (13.2.2). The argument is nearly identical to the proof of Proposition 6.4 in [35], so we will only outline it.

A key ingredient is Gromov's Covering Lemma ([35], [39]), whose statement makes use of the notion of the first order of a cover, which we review here.

Definition. We say that a collection of sets \mathcal{C} has first order $\leq \mathfrak{o}$ if and only if each $C \in \mathcal{C}$ intersects no more than $\mathfrak{o} - 1$ other members of \mathcal{C} .

Lemma 13.3. (Gromov's Covering Lemma) Let X be an n -dimensional Alexandrov space with curvature $\geq k$ for some $k \in \mathbb{R}$. There are positive constants $\mathfrak{o}(n, k)$ and $r_0(n, k)$ that satisfy the following property.

For all $r \in (0, r_0)$, any compact subset of $A \subset X$ contains a finite subset $\{a_i\}_{i \in I}$ so that

- $A \subset \cup_i B(a_i, r)$, and
- the first order of the cover $\{B(a_i, 3r)\}_i$ is $\leq \mathfrak{o}$.

In the Riemannian case, this follows from relative volume comparison, so one only needs the corresponding lower bound on Ricci curvature. Since relative volume comparison holds for rough volume in Alexandrov spaces ([3]), the proof in [39] yields, with minor modifications, Lemma 13.3.

Since Ω is precompact and every point of $\bar{\Omega}$ is $(4, \delta)$ -strained, there is an $r > 0$ and a finite open cover $\tilde{\mathcal{U}}^4 = \{\tilde{U}\}$ of Ω by $(4, \delta, r)$ -strained open sets \tilde{U} . Since \mathcal{B}^0 , \mathcal{B}^1 and \mathcal{B}^2 each consist of sets whose closures are pairwise disjoint, we choose the sets of $\tilde{\mathcal{U}}^4$ so that

- For $k \in \{0, 1, 2\}$, if $U \in \tilde{\mathcal{U}}^4$, then there is at most one $B \in \mathcal{B}^k$ so that $U \cap B^- \neq \emptyset$, and in this event,

$$U \subset B. \quad (13.3.1)$$

- For $k \in \{0, 1, 2\}$, if $U \in \tilde{\mathcal{U}}^4$, $(B, p_B, r_B) \in \mathcal{B}^k$, and $U \cap B^- \neq \emptyset$, let $\{(a_i, b_i)\}_{i=1}^{k+1}$ be the first $(k+1)$ -strainers of U , and define $p_U : U \rightarrow \mathbb{R}^{k+1}$ by $p_U(x) = (\text{dist}_{a_1}(x), \dots, \text{dist}_{a_{k+1}}(x))$. Then using (3.15.1), we choose $\{(a_i, b_i)\}_{i=1}^{k+1}$ so that

$$|dp_u - d(p_B, r_B)| < \tau(\delta). \quad (13.3.2)$$

Let 3ρ be a Lebesgue number for $\tilde{\mathcal{U}}^4$. Apply Lemma 13.3 to get a refinement $\mathcal{U}^4(3)$ of $\tilde{\mathcal{U}}^4$ that consists of 3ρ -balls and satisfies

- the corresponding collection $\mathcal{U}^4(1)$ of ρ -balls is also a cover of Ω , and
- the first order of $\mathcal{U}^4(3)$ is $\leq \mathfrak{o}$, where \mathfrak{o} is as in Lemma 13.3.

Next we exploit (13.3.2) to get local embeddings of each element $3U \in \mathcal{U}(3)$ that respect the projections of our handles. The result is stated in terms of the following definition.

Definition. Given $l, k \in \mathbb{N}$ with $k \leq l$, let $\pi_{k,l} : \mathbb{R}^l \rightarrow \mathbb{R}^k$ be orthogonal projection. Given two stable submersions

$$q : U \rightarrow \mathbb{R}^l \text{ and } p : U \rightarrow \mathbb{R}^k$$

we write $p \stackrel{s}{=} \pi_{k,l} \circ q$ if and only if for all but finitely many α , q_α and p_α can be chosen so that

$$p_\alpha = \pi_{k,l} \circ q_\alpha.$$

Proposition 13.4. For each $3U \in \mathcal{U}^4(3)$, there is a stable $\tau(\delta)$ -almost Riemannian embedding

$$\mu : 3U \rightarrow \mathbb{R}^4 \quad (13.4.1)$$

with the following property. For $k \in \{0, 1, 2\}$, if $3U \cap B^- \neq \emptyset$ for some $(B, p_B, r_B) \in \mathcal{B}^k$, then

$$3U \subset B, \text{ and} \tag{13.4.2}$$

$$\pi_{k+1} \circ \mu \stackrel{s}{=} (p_B, r_B), \tag{13.4.3}$$

where $p_B : B \rightarrow \mathbb{R}^k$ is the projection of B , $r_B : B \rightarrow \mathbb{R}$ is the fiber exhaustion function of B and $\pi_{k+1} : \mathbb{R}^4 \rightarrow \mathbb{R}^{k+1}$ is projection to the first $k+1$ factors.

Outline of Proof. The $k = 4$ version of Lemma 3.2 gives us the desired stable embeddings. The fact that the embeddings can be chosen to satisfy (13.4.3) follows from (13.3.2) and the Submersion Deformation Lemma (5.7). \square

Let $\mathcal{U}^{4,\alpha}(3) = \{3U_i^\alpha\}_{i=1}^L$ and $\mathcal{U}^{4,\beta}(3) = \{3U_i^\beta\}_{i=1}^L$ be collections of metric balls in M_α and M_β that approximate $\mathcal{U}^4(3)$. Let

$$\mu_i^\alpha : 3U_i^\alpha \rightarrow \mathbb{R}^4$$

be an embedding that approximates the embedding

$$\mu_i : 3U_i \rightarrow \mathbb{R}^4$$

from (13.4.1). For $j \in \{1, 2, \dots, L\}$, we get embeddings

$$\nu_j : 3U_j^\alpha \rightarrow 3U_j^\beta$$

by setting

$$\nu_j = \left(\mu_j^\beta\right)^{-1} \circ \mu_j^\alpha.$$

It remains to glue the ν_j together in a manner that respects the handles. This is accomplished via Theorem 5.3 of [35]. The idea, which also appears in the proof of Perelman's Stability Theorem ([21], [26]), is to use the Submersion Deformation Lemma (5.7) to inductively glue the ν_j . Since the first order of our cover is bounded from above by the a priori constant \mathfrak{o} , Part 2 of the Submersion Deformation Lemma (5.7) ensures that our glued embeddings stay close to all of our original embeddings. Since our original embeddings respect \mathcal{B} , Part 4 of Lemma 5.7 ensures that the glued embeddings respect \mathcal{B} .

REFERENCES

- [1] *American Institute of Mathematics Problem Lists: Nonnegative Curvature*, <http://aimpl.org/nsectcurvature/1/>.
- [2] R. Balmer and B. Kleiner, *Ricci flow and contractibility of spaces of metrics*, preprint. <https://arxiv.org/pdf/1909.08710.pdf>
- [3] Y. Burago, M. Gromov, and G. Perelman, *A.D. Alexandrov spaces with curvatures bounded from below*, I, *Uspechi Mat. Nauk.* **47** (1992), 3–51.
- [4] J. Cerf, *La stratification naturelle des espaces de fonctions différentiables réelles et le théorème de la pseudo-isotopie*, *Publ. Math. I.H.E.S.* **39** (1970), 5–173.
- [5] J. Cheeger, *Comparison and finiteness theorems for Riemannian manifolds*, Thesis, Princeton University, 1967.
- [6] J. Cheeger, *Finiteness theorems for Riemannian manifolds*, *Amer. J. Math.* **92** (1970) 61–74.
- [7] J. Cheeger, *Structure Theory and Convergence in Riemannian Geometry*, *Milan J. Math.* Vol. 78 (2010) 221–264.

- [8] J. Cheeger and A. Naber, *Regularity of Einstein manifolds and the codimension 4 conjecture*, Ann. of Math. (2) 182 (2015), no. 3, 1093–1165.
- [9] L.P. Chew, *Guaranteed-quality triangular meshes*, Tech. Rept. TR-89-983, Department of Computer Science, Cornell University, Ithaca, NY, 1989. <http://www.dtic.mil/dtic/tr/fulltext/u2/a210101.pdf>
- [10] R. Fintushel and R. Stern, *Knots, links, and 4-manifolds*, Invent. Math. 134 (1998), no. 2, 363–400.
- [11] R. Fintushel and R. Stern, *Six Lectures on Four 4-Manifolds*, <https://arxiv.org/pdf/dg-ga/9612014.pdf>
- [12] R. Friedman and J. Morgan. *On the diffeomorphism types of certain algebraic surfaces*, J. Differential Geom. 27, No. 2 (1988), 297–369.
- [13] B. Gärtner and M. Hoffmann, *Computational Geometry Lecture Notes HS 2013*. <http://www.ti.inf.ethz.ch/ew/courses/CG13/lecture/cg-2013.pdf>.
- [14] M. Gromov, *Metric Structures for Riemannian and Non-Riemannian Spaces*, Birkhäuser, 2001.
- [15] K. Grove and P. Petersen, *Bounding homotopy types by geometry*, Ann. of Math. **128** (1988), 195–206.
- [16] K. Grove, P. Petersen, and J-Y. Wu, *Geometric finiteness theorems via controlled topology*, Invent. math. 99,(1990) 205–213.
- [17] K. Grove and F. Wilhelm, *Hard and soft packing radius theorems*. Ann. of Math. **142** (1995), 213–237.
- [18] K. Grove and F. Wilhelm, *Metric constraints on exotic spheres via Alexandrov geometry*, J. Reine Angew. Math. **487** (1997), 201–217.
- [19] A. Hatcher, *A proof of the Smale Conjecture*, $\text{Diff}(S^3) \simeq O(4)$, Ann. of Math. **117**, (1983), 553–607.
- [20] V. Kapovitch, *Regularity of limits of noncollapsing sequences of manifolds*, Geom. Funct. Anal. 12 (2002), no. 1, 121–137.
- [21] V. Kapovitch, *Perelman’s stability theorem*. Surveys in differential geometry. **11** (2007), 103–136.
- [22] K. Kuwae, Y. Machigashira, and T. Shioya, *Sobolev spaces, Laplacian, and heat kernel on Alexandrov spaces*, Math. Z. 238 (2001), no. 2, 269–316.
- [23] Kirby, P., Siebenmann, L: *Foundational essays on topological manifolds, smoothings and triangulations*. Ann. Math. Stud. 88, Princeton University Press (1977)
- [24] I. Nikolaev, *Bounded curvature closure of the set of compact Riemannian manifolds*, Bull. Amer. Math. Soc. 24:1 (1991), 171–177.
- [25] Y. Otsu, K. Shiohama and T. Yamaguchi, *A new version of differentiable sphere theorem*. Invent. Math. **98** (1989), 219–228.
- [26] G. Perelman, *Alexandrov spaces with curvature bounded from below II*, preprint 1991.
- [27] G. Perelman, *Elementary Morse theory on Alexandrov spaces*, St. Petersburg Math. Journ. **5/1**, (1994), 207–214.
- [28] G. Perelman, *Construction of Manifolds of Positive Ricci Curvature with Big Volume and Large Betti Numbers*, Comparison Geometry MSRI publication **30** (1997) 149–155.
- [29] S. Peters, *Cheeger’s finiteness theorem for diffeomorphism classes of Riemannian manifolds*, J. Reine Angew. Math. **349** (1984) 77–82.
- [30] P. Petersen, *Comparison geometry problem list*, Riemannian geometry (Waterloo, ON, 1993), 87–115, Fields Inst. Monogr., 4, Amer. Math. Soc., Providence, RI, 1996.
- [31] P. Petersen, *Riemannian Geometry*, 3rd Ed., New York: Springer Verlag, 2016.
- [32] A. Petrunin, *Semiconcave functions in Alexandrov’s Geometry* Surv. in Diff. **11** (2007), 137–201.
- [33] C. Plaut, *Spaces of Wald-Berestovskii curvature bounded below*. J. Geom. Analysis. 6 (1996), no. 1, 113–134.
- [34] C. Pro, M. Sill, and F. Wilhelm, *The Diffeomorphism Type of Manifolds with Almost Maximal Volume*, Communications in Analysis and Geometry, Vol. 25, No. 1 (2017), pp. 243–267. <http://arxiv.org/abs/1201.0415>
- [35] C. Pro and F. Wilhelm, *Diffeomorphism stability and codimension three*, preprint. <https://arxiv.org/pdf/1606.01828v1.pdf>
- [36] C. Pro and F. Wilhelm, *Delaunay triangulations of Gromov sets*, preprint.
- [37] S. Smale, *Diffeomorphisms of the 2-sphere*, Proc. Amer. Math. Soc. **10**, (1959), 621–626.
- [38] F. Wilhelm, *On the filling radius of positively curved manifolds*, Inventiones Mathematicae 107 (1992), 653–668.

- [39] S. Zhu, *The Comparison Geometry of Ricci Curvature*, Comparison Geometry MSRI publication **30** (1997) 221-262.

DEPARTMENT OF MATHEMATICS, CALIFORNIA STATE UNIVERSITY, STANISLAUS
E-mail address: `cpro@csustan.edu`

DEPARTMENT OF MATHEMATICS, UNIVERSITY OF CALIFORNIA, RIVERSIDE
E-mail address: `fred@math.ucr.edu`
URL: <https://sites.google.com/site/frederickwilhelmjr/home>