

Motion by curvature and large deviations for an interface dynamics on \mathbb{Z}^2

B. Dagallier

CMAP, Ecole Polytechnique, I.P. Paris, 91128 Palaiseau, France

Abstract: We study large deviations for a Markov process on curves in \mathbb{Z}^2 mimicking the motion of an interface. Our dynamics can be tuned with a parameter β , which plays the role of an inverse temperature, and coincides at $\beta = \infty$ with the zero-temperature Ising model with Glauber dynamics, where curves correspond to the boundaries of droplets of one phase immersed in a sea of the other one. We prove that contours typically follow a motion by curvature with an influence of the parameter β , and establish large deviations bounds at all large enough $\beta < \infty$. The diffusion coefficient and mobility of the model are identified and correspond to those predicted in the literature.

1 Introduction

A basic paradigm in non-equilibrium statistical mechanics is the following. Consider a system with two coexisting pure phases separated by an interface, and undergoing a first-order phase transition with non-conserved order parameter. Then, macroscopically, the interface should evolve in time to reduce its surface tension, according to a motion by curvature. For microscopic models on a lattice, some trace of the lattice symmetries should remain at the macroscopic scale, and the resulting motion by curvature should be anisotropic. The following general behaviour, known as the Lifshitz law, is expected: if a droplet of linear size $N \gg 1$ of one phase is immersed in a sea of the other phase, then it should disappear in a time of order N^2 . (Anisotropic) motion by curvature should correspond to the limiting dynamics, when N is large, under diffusive rescaling of space and time. Phenomenological arguments in favour of this picture go back to Lifshitz [Lif62], and can be summarised as follows. Consider a model with surface tension $\tau = \tau(\nu)$, which depends on the local inwards normal ν to an interface. We work in two dimensions to keep things simple. The surface energy associated with a curve γ separating two phases reads

$$F(\gamma) = \int_{\gamma} \tau(\nu(s)) ds,$$

where s is the line abscissa on γ . The postulate, on phenomenological grounds, is that the local inwards normal speed v to the interface reads

$$v = \mu \frac{\delta F}{\delta \gamma}. \quad (1.1)$$

The quantity $\mu = \mu(\nu)$ is the mobility of the model, computed by Spohn in [Spo93] using linear response arguments. Let us relate (1.1) and motion by curvature. The change in energy induced by the motion

2020 *Mathematics subject classification.* 60F10, 82C22, 82C24

Key words: Large deviations, interface dynamics, motion by curvature, Ising model.

of a length ds in the normal direction ν is equal to $(\tau(\nu)/R(\nu))ds$, with $R(\nu)$ the radius of curvature at ν . As such,

$$v = \mu\tau k =: ak, \quad \text{with} \quad a(\nu) = \mu(\nu)\tau(\nu) \text{ the anisotropy and } k = 1/R \text{ the curvature.} \quad (1.2)$$

A closed curve satisfying (1.2) is said to evolve according to anisotropic motion by curvature. A set with boundary following this equation is known to shrink to a point in finite time for a wide range of anisotropies a , see e.g. [LST14a] and references therein.

Ideally, one would like to start from a microscopic model with short-range interactions, with at least two different phases initially segregated on a macroscopic scale, and derive motion by curvature (1.2) of the boundaries between the phases in the diffusive scaling. To this day however, results on microscopic models are scarce. Let us provide a (non-exhaustive) account of works on the subject.

The paper [Spo93], already cited, is a landmark in the rigorous study of interface motion starting from microscopic models. A major difficulty is to understand how to decouple, from the comparatively slower motion of the interface, the fast relaxation inside the bulk of each phase. Indeed, in a diffusive time scale and at least for models with local interactions, one expects the bulk to behave as if at equilibrium. In one dimension, motion by curvature has been proved for a number of interacting particle systems. It usually boils down to the heat equation in this case, and the Lifshitz law is related to freezing/melting problems, see [CS⁺96][CK08][CKG12], as well as [Lac14] and the monograph [CDMGP16].

In two dimensions, a landmark is the proof of anisotropic motion by curvature for the zero temperature Ising model with Glauber dynamics (or zero-temperature stochastic Ising model). The drift at time 0 was computed in [CL07] before the full motion by curvature (1.2) was proven in [LST14b]-[LST14a]. Their proof crucially relies on monotonicity of the Glauber dynamics.

More is known on another type of microscopic models for which some sort of a mean-field mesoscopic description can be achieved. This comprises the so-called Glauber+Kawasaki process [DMFL86] (see also [BBP18] for an account of works on the model), which has local evolution rules, and models with long range interactions such as the Ising model with Kac potentials [Com87][DMOPT93][DMOPT94][KS94]. For these models, studied in any dimension, the derivation takes place in two steps: first deriving a mean-field description of the dynamics, then rescaling space-time to derive motion by curvature. As a result, lattice symmetries are blurred and the resulting motion by curvature is isotropic. Note however the recent works [FT19][KFH⁺20], where a Glauber+Kawasaki dynamics is considered (respectively Glauber+Zero-range), in dimension two and above. In these works, the existence of an interface between regions at high-and low-density is established, and motion by curvature for this interface is obtained directly from the microscopic model, in a suitable scaling of the Glauber part of the dynamics.

A last category of models comprises the so-called effective interface models. By definition the bulk of each phase is disregarded. One associates an "interfacial" cost to the graph of a given function, seen as an interface between phases. These comprise the so Ginzburg-Landau model in any dimension, see [FS97], and more recently Lozenge-tiling dynamics in dimension three [LT18].

Another related line of investigation concerns large deviations of the interface dynamics around motion by curvature. Assuming Gaussian-like fluctuations around the mean behaviour (1.2), the rate function describing the cost of observing an abnormal trajectory $\gamma. = (\gamma_t)_{t \leq T}$ should read

$$I(\gamma.) = \int_0^T dt \int_{\gamma_t} \frac{(v - ak)^2}{2\mu} ds_t, \quad (1.3)$$

with s_t the line abscissa on γ_t . In the assumption of Gaussian fluctuations leading to (1.3), one of the difficulties is that it is not even clear how the noise should be incorporated into the deterministic equa-

tions describing the interface motion. Extensive work on this question has been carried out for some of the models listed above in recent years, notably in [BBP17b]-[BBP18] (see also the references there). In [BBP17b], the stochastic Allen-Cahn equation is considered. It is known that, in the diffusive (or sharp interface) limit, solutions to the Allen-Cahn equation satisfy motion by mean curvature in some sense, see [Ilm93] [ESS92] [BSS93]. In [BBP17a], regularity of solutions to the stochastic Allen-Cahn equation depending on how the noise is added are studied, and a large deviation upper-bound in the joint diffusive, small noise and vanishing regularisation limits is established in [BBP17b]. The associated rate function coincides with (1.3) in simple cases, e.g. for a droplet trajectory with smooth boundary. The authors however use tools from geometric measure theory, which enable them to consider very general trajectories that may feature nucleation events.

In [BBP18], upper bound large deviations for both Glauber+Kawasaki process and Ising model with Kac potentials are investigated. They prove that (1.3) is the correct rate function for smooth trajectories and discuss how to extend it to more general paths.

To the best of our knowledge however, no large deviations result for microscopic dynamics with local interactions have yet been published. In particular the question of large deviations for the zero temperature stochastic Ising model is still open.

In this work, we make a contribution in that direction. To do so, we study a microscopic modification of the zero-temperature Ising dynamics in terms of a parameter $\beta > 0$. At each $\beta > 0$, we consider contours evolving according to zero-temperature Ising rules, except for the parameter β , which plays the role of an inverse temperature acting on local portions of the contours. The model at each $\beta > 0$ has reversible dynamics and, contrary to the zero-temperature Ising case, the dynamics is not monotonous. The $\beta = \infty$ case corresponds to the zero-temperature Ising dynamics.

We implement in our framework the large deviation method initiated by Kipnis, Olla and Varadhan in [KOV89] (see also [KL99]). There are substantial difficulties as we are dealing with curves, i.e. one-dimensional objects, evolving in two-dimensional space. One of the advantages of the method is that we no longer rely on monotonicity of the dynamics as in [LST14a]. Monotonicity appears difficult to use for large deviations in any case, as atypical events, such as closeness to some atypical trajectory, are in general not monotonous. At each large enough $\beta > 0$, we prove that the dynamics approaches anisotropic motion by curvature in the large size limit, with a dependence on the parameter β . At the formal level, the $\beta = \infty$ case indeed corresponds to anisotropic motion by curvature in the sense of [LST14b]. We also obtain large deviations for the model. The large deviations results give upper- and lower-bounds, which coincide for smooth trajectories.

As opposed to the zero-temperature stochastic Ising model, an interesting feature of our model at finite β is that its dynamics is reversible. This enables us to connect our results with metastability for the Ising model initially at equilibrium in one phase, forced out of equilibrium with a small magnetic field of opposite sign [SS98]. We briefly discuss in Section 2.4 the existence of a threshold value of the volume of a droplet, depending on the strength of the magnetic field, below which droplets typically do not grow and above which they typically do. The speed at which the droplet grows is also easily estimated thanks to the large deviation results. The interested reader will find an up to date account of results on metastability in the Ising model in [GMV20], and may refer to the books [OV05]-[BDH16].

The rest of this article is structured as follows. In Section 2, we introduce the microscopic model and fix notations. The dynamics is introduced in details, while useful topological facts are collected in Appendix B. The main results of the paper are listed in Section 2.

In Section 3, we investigate some martingales used to obtain large deviations, and show how motion by

curvature emerges from the microscopic dynamics. Though computationally intensive, we have tried to use this section to showcase the main differences between dealing with a one-dimensional interface in two dimensions, and a purely one-dimensional system. A number of technical results and sub-exponential estimates are postponed to Section 6 and Appendices A-B. Section 6 is a collection of estimates that are genuinely particular to our model, concerning the dynamical behaviour of the poles, i.e. the sections of the contours on which the parameter β acts. Albeit very technical, the estimates on the poles are essential. We also explain there the connection between our dynamics and suitable one-dimensional exclusion and zero range processes as in [LST14b]. This connection is again used in Appendix A to prove an adaptation of the so-called replacement lemma to our model. An important estimate allowing the restriction of the contour dynamics to a nicer state space is also proven there, as well as some equilibrium estimates around the pole. Appendix B gathers useful topological properties and the proof of exponential tightness.

In Section 4, we obtain upper-bound large deviations for large enough $\beta > 0$. Finally, Section 5 deals with lower-bound large deviations, i.e. with hydrodynamic limits for tilted processes.

2 Model and results

2.1 The contour model

Consider the zero temperature, two-dimensional stochastic Ising model on $(\mathbb{Z}^*)^2$, that we now define, with \mathbb{Z}^* the dual graph of \mathbb{Z} . On configurations, i.e. elements σ of $\{-1, 1\}^{(\mathbb{Z}^*)^2}$, one defines a dynamics as follows: at rate 1, each vertex $x \in (\mathbb{Z}^*)^2$ is updated independently, and $\sigma(x)$ takes the same value as the majority of its neighbours. If it has exactly two neighbours of each sign, then with probability 1/2 it remains unchanged, and with probability 1/2 it is flipped. This dynamics is well defined for all time on any subset of $(\mathbb{Z}^*)^2$, and the so-called graphical construction of the dynamics (see [Mar99]) enables one to couple the dynamics starting from any initial configurations and with any boundary conditions. It is also monotonous: if $\sigma \leq \eta$, i.e. $\sigma(x) \leq \eta(x)$ for each $x \in (\mathbb{Z}^*)^2$, then $\sigma_t \leq \eta_t$ for all $t \geq 0$, with probability 1. It is however not reversible.

The hydrodynamical behaviour of this dynamics is proven in [LST14b]-[LST14a]. Informally, they prove the following. Start from a configuration with + everywhere except in an area of linear size N (a "droplet" of - spins), corresponding to the discretisation on $(\mathbb{Z}^*)^2$ of ND_0 , where $D_0 \subset [-1, 1]^2$ is a nice enough domain, say with smooth, simple boundary with a finite number of inflection points. Rescale space by $1/N$ and time by N^2 . Then, in the large N limit, with probability going to one, the rescaled droplet converges uniformly in time and in Hausdorff distance to the unique solution of an anisotropic motion by curvature starting from D_0 . This flow of sets $(D_t)_{t \geq 0}$ is defined as follows. It starts from D_0 and, until a time T_c after which $D_t = \emptyset, t \geq T_c$, the boundaries $(\gamma_t)_{t \geq 0}$ of the D_t satisfy (1.2):

$$\forall u \in \mathbb{T}, \forall t < T_c, \quad \partial_t \gamma(t, u) = a(\theta_t(u)) \partial_s^2 \gamma(t, u) = a(\theta_t(u)) k(t, u) \nu(t, u), \quad (2.1)$$

where $u \in \mathbb{T} \mapsto \gamma_t(u)$ is a parametrisation on the torus $\mathbb{T} = [0, 1)$ of each of the $\gamma_t, t < T_c$; k is the curvature, $\theta(u) = \theta_t(u)$ is the angle between the tangent vector at point $\gamma_t(u)$ and $e_1 = (1, 0)$, $\nu = \nu_t(u)$ is the inwards normal vector at point $\gamma_t(u)$. The $\pi/2$ -periodic anisotropy a is a factor reflecting the symmetries of the square lattice:

$$\forall \theta \in [0, 2\pi], \quad a(\theta) = \frac{1}{2(|\sin(\theta)| + |\cos(\theta)|)^2}. \quad (2.2)$$

Existence and uniqueness of such a flow is part of the results in [LST14b]-[LST14a]. The proof of the hydrodynamic limit relies strongly on monotonicity properties of the dynamics, which allow local comparison of the dynamics with nicer ones.

The contour dynamics

Take a spin configuration σ such that $\sigma_x = +$ for x outside a finite subset Λ^* of $(\mathbb{Z}^*)^2$. The boundaries between $-$ and $+$ spins form closed contours on edges of \mathbb{Z}^2 . In this picture, a spin $x \in \Lambda^*$ is identified with the square $x + [-1/2, 1/2]^2$, which we call a "block", and spin-flips correspond to adding or deleting blocks. At strictly positive temperature $\beta^{-1} > 0$, a contour of length L should occur with probability roughly proportional to $\exp[-\beta L]$. Let ν_β denote the associated probability measure:

$$\nu_\beta(\gamma) \propto e^{-\beta|\gamma|}.$$

At zero temperature however, in a fixed volume with e.g. all $+$ boundary conditions, the only possible configuration contains only $+$ spins.

We consider a model on closed paths on edges of $\Lambda_N = [-N, N]^2 \cap \mathbb{Z}^2$ for $N \in \mathbb{N}^*$. For simplicity, we only allow configurations with a single contour. We want to build a dynamics that is as close as possible to the zero-temperature Ising dynamics, but has ν_β as an invariant measure. One way to do this is to take the dynamical moves allowed in the stochastic Ising model, and add regrowth, β -dependent moves to obtain a reversible dynamics with respect to ν_β . Proximity to the zero-temperature Ising dynamics is ensured by allowing droplet regrowth only at small zones on the droplet (see Figure 2). We call this dynamics the contour dynamics. Importantly, and contrary to the stochastic Ising model, the contour dynamics is not monotonous. This is illustrated on Figure 3 below.

Additional constraints, e.g. boundary effects, will be placed on the dynamics and on the state space. We also restrict the study to specific droplet shapes for simplicity. We need however more notations to state these conditions. Let us now precisely define the contour model and dynamics; further heuristics can be found in Section 2.2. Take $N \in \mathbb{N}^*$, recall that $\Lambda_N = \mathbb{Z}^2 \cap [-N, N]^2$ and let $E_N = \{(x, y) : x, y \in \Lambda_N, \|x - y\|_1 = 1\}$ be the corresponding set of edges. Define first the state space X_r^N of the dynamics (see Figure 1), which depends on an additional parameter $r > 0$, independent of N .

- Elements of X_r^N , denoted by γ , are closed paths on edges in E_N .
- (*Four poles*). Each γ in X_r^N is contained in a unique rectangle of least area, call it \mathfrak{R} , which contains the extremal faces of γ , i.e. edges (x, y) where x, y are vertices of γ with one coordinate that is extremal. We impose that each extremal face of γ be connected. For $k \in \{N, E, S, W\} = \{1, 2, 3, 4\}$, we call P_k the pole number k , corresponding to the vertices of γ on face k of \mathfrak{R} . We also impose that the number $p_k = |P_k| - 1$ of edges with both extremities inside P_k be always greater than 2. Equivalently, p_k is the number of blocks with two corners in P_k .
- (*Monotonicity condition*). Denote by $L_1, R_1, \dots, L_4, R_4 \in \Lambda_N$ the leftmost and rightmost extremities of the poles P_1, \dots, P_4 when γ is travelled on clockwise. We impose that the part of γ between L_1 and R_2 is a south-east path, the part between L_2 and R_3 is a south-west path, the part between L_3 and R_4 is a north-west path and, finally, the part between L_4 and R_4 is a north-east path.
- (*Macroscopic droplet condition*). Further impose that if $\gamma \in X_r^N$, then $y_{\max} - y_{\min} \geq \lceil Nr \rceil$, $x_{\max} - x_{\min} \geq \lceil Nr \rceil$, where y_{\max} is the maximum ordinate of a point in γ , etc.

The last condition ensures that contours delimit macroscopic droplets. It is useful for technical reasons, see e.g. the proof of the Replacement lemma in Appendix A. We will always consider droplets larger

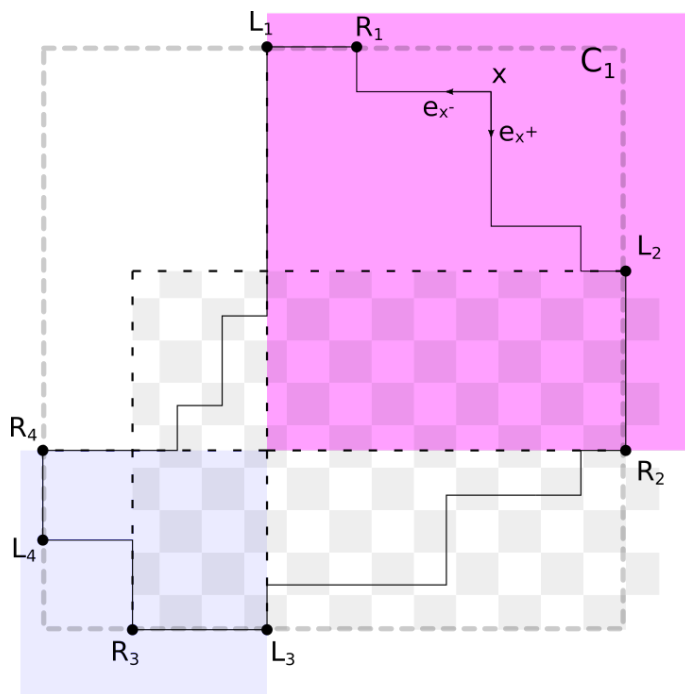

Figure 1: Example of a curve in X_r^N . The thick pale dashed line delimits the rectangle \mathfrak{R} . The quadrants are quarterplanes which depend on the curve. Here (part of) the first three quadrants are represented: C_1 is the dark shaded area, C_2 the checkered area and C_3 the light-shaded one. In this example, C_1 and C_3 have the same origin; this is not true in general. Note that C_1 and C_2 intersect. The vectors e_x^\pm are represented for a vertex x .

than what this condition allows for, so that the parameter r will play no role at the macroscopic level.

For $\gamma \in X_r^N$, call quadrants C_1, \dots, C_4 the quarter-planes delimited by portions of γ between consecutive (clockwise) poles. More precisely, define C_1 as the quarter plane delimited by the vertical line going through L_1 and the horizontal one going through R_2 . We similarly define C_2, C_3, C_4 , which may intersect (see Figure 1).

Let also $V(\gamma) \subset \Lambda_N$ be the set of all points encountered when travelling on γ . For $x \in V(\gamma)$, define an edge label $\xi_x \in \{0, 1\}$ to be 1 if the edge exiting from x when travelling clockwise on γ is vertical, and 0 if it is horizontal. Let e_x^+, e_x^- be the unitary vectors with origin x such that e_x^+ gives the direction of the edge exiting from x , and e_x^- points towards the vertex before x (see Figure 1).

We can now precisely define the contour dynamics. For each curve γ , the following moves are allowed, summed up in Figure 2.

- (*Single spin flips*). Suppose $x \in V(\gamma)$ is not in a pole of size 2, and the curve at x has a corner, i.e. e_{x+} and e_{x-} are orthogonal. Then, independently of the other vertices, add/remove a block of extremity x at rate $1/2$ whenever possible (i.e. when the curve after the flip remains simple, or equivalently the event described in Figure 4 does not occur).
- (*Shrinking the droplet*). Assume the pole P_k is made of only two blocks. Suppose e.g. that $k = 1$, the others are the same. If $y(P_1) - y(P_3) \geq \lceil Nr \rceil + 1$, then, with rate 1 and independently from the rest, delete both blocks with vertices in P_1 .

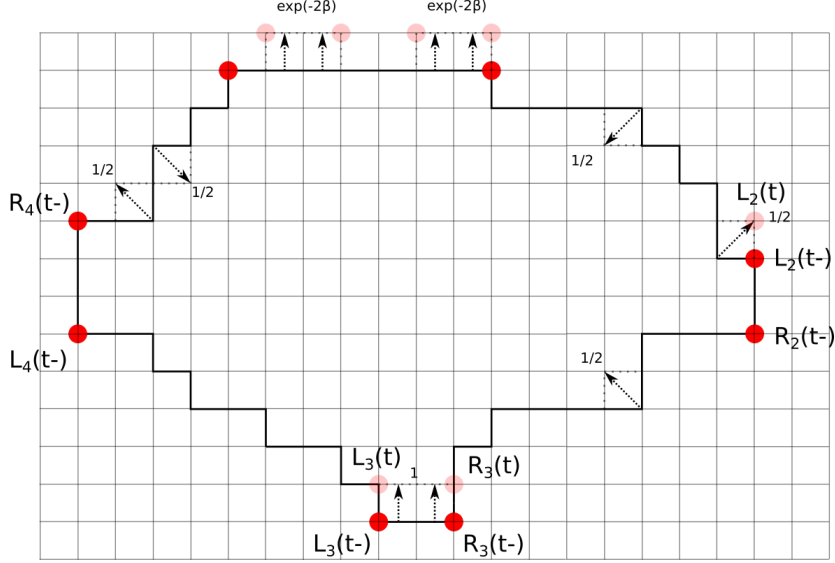

Figure 2: Some moves and associated jump rates for a typical contour configuration. Positions of L_k, R_k , $k \in \{1, \dots, 4\}$, the points that delimit the poles, i.e. the zones where regrowth can occur, are represented at time t_- in dark dots. Possible pole positions after a jump at time t are represented by light dots. L_1, R_1 are omitted for legibility. Dynamical moves amount to adding or deleting squares of side-length 1 ("blocks"). Just before the jump, at t_- , the pole $P_3(t_-)$ had length $p_3 = 2$ and both blocks are removed at the same time.



Figure 3: Two configurations equal everywhere except at the pole: the configuration represented by the black line has a pole of size 2. Initially, the droplet delimited by the black line contains the droplet in light colour. A possible update after which the inclusion does not hold is represented in dashed lines: the contour dynamics is not monotonous.

- (*Added regrowth term*). Suppose that $x \in V(\gamma)$ is in one of the poles, and such that $x + 2e_x^+$ is in the same pole (this is simply a way of enumerating elements of a given pole). If $x \notin \partial\Lambda_N$, then with rate $e^{-2\beta}$, independently from the rest, add two blocks on top of the segment $[x, x + 2e_x^+]$.

The set X_r^N is stable under the dynamics. Moreover, the dynamics was built to be reversible with respect to the measure $\nu_{r,\beta}^N$ on X_r^N , with:

$$\forall \gamma \in X_r^N, \quad \nu(\gamma) = \nu_{r,\beta}^N(\gamma) := e^{-\beta|\gamma|} / Z_{r,\beta}^N, \quad (2.3)$$

where $|\gamma|$ is the length of γ in 1-norm. When ambiguities may arise, $|\gamma|_1$ will denote the length in 1 norm and $|\gamma|_2$ the length in 2-norm. Note that the two coincide for $\gamma \in X_r^N$. The dynamics described above is not monotonous because of the regrowth part. The parameter $\beta > 0$ plays the role of an inverse

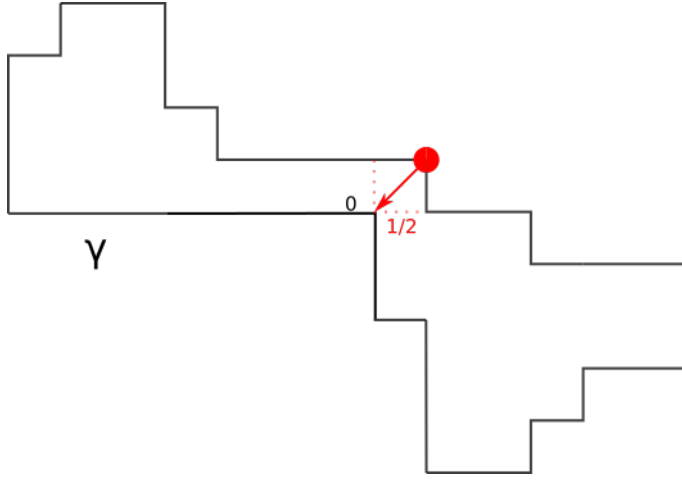

Figure 4: A configuration γ in X_r^N with a forbidden single-flip: the dot denotes a point that, if flipped, makes γ non-simple. The jump rate for such flips is a non-local function of the curve. Rescaled by N , γ converges in Hausdorff distance to a curve with self-intersections at points inside quadrants 1 and 3.

temperature, but only at the pole. The quantity $Z = Z_{r,\beta}^N$ is the partition function on X_r^N :

$$Z = Z_{r,\beta}^N = \sum_{\gamma \in X_r^N} e^{-\beta|\gamma|}. \quad (2.4)$$

In the following, we always assume that β is large enough to ensure that Z is bounded with N . In practice, $\beta > 3$ is enough except in Lemma 5.2, where we use $\beta > 64 \log 3$ for convenience (it is a technical condition that could be relaxed by considering curves in a larger square than $[-1, 1]^2$).

Let us write out the jump rates $c(\gamma, \gamma')$ associated with the contour dynamics, $\gamma, \gamma' \in X_r^N$. Reversibility with respect to $\nu_{r,\beta}^N$ means:

$$c(\gamma, \gamma') e^{-\beta|\gamma|} = c(\gamma', \gamma) e^{-\beta|\gamma'|}.$$

Single spin flips. Let $x \in V(\gamma)$. It is convenient to express the jump rate in terms of edges, and thus draw a parallel with the Symmetric Simple Exclusion Process (SSEP). Assume x is a corner of γ , i.e. a point where e_x^- and e_x^+ are orthogonal. Define a curve γ^x in which the block of diagonal $[x, x + e_x^- + e_x^+]$ is added/removed compared to γ . In terms of edges, this corresponds to exchanging $(x + e_x^-, x)$ and $(x, x + e_x^+)$, which leads to a change in γ whenever:

$$\xi_{x+e_x^-}(1 - \xi_x) + \xi_x(1 - \xi_{x+e_x^+}) = 1. \quad (2.5)$$

Note that if x is not a corner, $\gamma^x = \gamma$. If the case of Figure 4 occurs or x is in a pole of size 2, the flip is impossible and $\gamma^x \notin X_r^N$, otherwise $\gamma^x \in X_r^N$. Note also that the left-hand side in (2.5) is exactly the jump rate on an edge connecting two neighbouring sites in a SSEP. Define:

$$c(\gamma, \gamma^x) := \mathbf{1}_{\gamma^x \in X_r^N} c_x(\gamma), \quad c_x(\gamma) := \frac{1}{2} [\xi_{x+e_x^-}(1 - \xi_x) + \xi_x(1 - \xi_{x+e_x^+})]. \quad (2.6)$$

Double flips at the poles: if x is a point of pole P_{k_x} , $k_x \in \{1, \dots, 4\}$ such that $x + 2e_x^+ \in P_{k_x}$, and $x \notin \partial\Lambda_N$, let $\gamma^{+,x}$ be the curve γ on which two blocks with basis $[x, x + 2e_x^+]$ are added (see Figure 2).

Then $|\gamma^{+,x}| = |\gamma| + 2$, and we set:

$$c(\gamma, \gamma^{+,x}) = \mathbf{1}_{\substack{x, x+2e_x^+ \in P_k \\ x \notin \partial\Lambda_N}} e^{-2\beta}. \quad (2.7)$$

Finally, if the pole P_k of γ has size 2 and $x \in P_k$, we let $\gamma^{-,x}$ or $\gamma^{-,k}$ be the curve γ with this pole deleted and define the corresponding jump rate:

$$c(\gamma, \gamma^{-,x}) = \mathbf{1}_{p_k=2, \gamma^{-,x} \in X_r^N}. \quad (2.8)$$

Let V_r, H_r be the sets enforcing that poles can be shrunk, i.e. that opposite poles are at least at vertical or horizontal distance $\lceil Nr \rceil + 1$ (1 more than the minimum value for curves in X_r^N):

$$V_r = \{\gamma \in X_r : y(P_1) - y(P_3) \geq \lceil Nr \rceil + 1\} \quad (2.9)$$

$$H_r = \{\gamma \in X_r : x(P_2) - x(P_4) \geq \lceil Nr \rceil + 1\}. \quad (2.10)$$

Let also DP_r^k denote H_r or V_r depending on $k \in \{1, \dots, 4\}$.

The generator $\mathcal{L}_{r,\beta}$ corresponding to the contour dynamics acts on bounded function $f : X_r^N \mapsto \mathbb{R}$ as:

$$\begin{aligned} \mathcal{L}_{r,\beta} f(\gamma) &= \sum_{x \in V(\gamma)} c(\gamma, \gamma^x) [f(\gamma^x) - f(\gamma)] \\ &+ \sum_{k=1}^4 \sum_{x \in P_k(\gamma) : x+2e_x^+ \in P_k(\gamma)} \left[\mathbf{1}_{DP_r^k, p_k=2} [f(\gamma^{x,-}) - f(\gamma)] + e^{-2\beta} \mathbf{1}_{x \notin \partial\Lambda_N} [f(\gamma^{x,+}) - f(\gamma)] \right]. \end{aligned} \quad (2.11)$$

Recall that writing $x, x + 2e_x^+ \in P_k$ is just a way of enumerating vertices in P_k such that $\gamma^{+,x}$ can exist, and that $p_k = |P_k| - 1$ is the number of blocks in the pole P_k . It will be convenient later on to transform the first line a bit, and allow for fictitious single flips of a block of a pole of size 2. The first line is then recast as (recall (2.6)):

$$\sum_{x \in V(\gamma)} c_x(\gamma) [f(\gamma^x) - f(\gamma)] - \frac{1}{2} \sum_{k=1}^4 \mathbf{1}_{p_k=2} \sum_{x \in \{R_k, L_k\}} [f(\gamma^x) - f(\gamma)]. \quad (2.12)$$

Define the set \mathcal{C} of test functions:

$$\mathcal{C} = \{G \in C_c(\mathbb{R}_+ \times [-1, 1]^2) : \partial_t G, \partial_i G, \partial_i \partial_j G \in C(\mathbb{R}_+ \times [-1, 1]^2), (i, j) \in \{1, 2\}^2\}, \quad (2.13)$$

where the c subscript means compactly supported. Then $(\mathcal{C}, \|\cdot\|_\infty)$ is separable.

We shall later need to consider a larger class of dynamics. For $H \in \mathcal{C}$, define another (time-inhomogeneous) Markov chain with generator $\mathcal{L}_{r,\beta,H}$ by modifying the jump rates as follows (recall that Γ is the set with boundary γ):

$$\forall t \geq 0, \quad c^{H_t}(\gamma, \gamma') := c(\gamma, \gamma') \exp \left[\int_{\Gamma'/N} H_{t/N^2} - \int_{\Gamma/N} H_{t/N^2} \right]. \quad (2.14)$$

The probability measure associated with the speeded-up generator $N^2 \mathcal{L}_{r,\beta,H}$ will be denoted by $\mathbb{P}_{r,\beta,H}^N$, or simply $\mathbb{P}_{r,\beta}^N$ when $H \equiv 0$. The corresponding expectations are denoted by $\mathbb{E}_{r,\beta,H}^N, \mathbb{E}_{r,\beta}^N$ respectively, and the law of the process induced by $\mathbb{P}_{r,\beta,H}^N, \mathbb{P}_{r,\beta}^N$ is denoted by $\mathcal{Q}_{r,\beta,H}^N, \mathcal{Q}_{r,\beta}^N$.

Macroscopic and effective macroscopic state spaces. We define here the space of macroscopic curves. All microscopic curves, rescaled by N^{-1} , are elements of the set X of non-empty, connected

compact subsets of $[-1, 1]^2$ with perimeter bounded by 8. This set is compact for the topology associated with the Hausdorff distance d_H . It is of course much too large, and we work instead with an effective state space \mathcal{E}_r , which contains only curves with four poles satisfying a monotonicity condition similar to the one for X_r^N . In addition, we shall define \mathcal{E}_r to ensure that the constraints V_r, H_r defined in (2.9)-(2.10) are satisfied, and that any pathological curve, like the one of Figure 4, is discarded. Informally, one should think of \mathcal{E}_r as follows:

$$\mathcal{E}_r = X \cap \left\{ \Gamma \subset [-1, 1]^2 : \Gamma \text{ has four non-intersecting poles, satisfies a monotonicity condition and } \partial\Gamma \text{ is a simple curve} \right\}. \quad (2.15)$$

In practice, the definition of \mathcal{E}_r is more subtle, as we want it to be closed for the Hausdorff distance and we need to allow droplets with non-simple boundaries, corresponding to curves with poles standing atop vertical or horizontal lines. It is detailed in Appendix B.

Definition 2.1 (Initial condition and notations). *In the rest of this article, unless explicitly stated otherwise, parameters $r > 0$, $\beta > \log 3$, $H \in \mathcal{C}$ are fixed once and for all (or $\beta > 64 \log 3$ in Lemma 5.2, see (2.4)). A parameter $r_0 > r$ is also fixed and we consider, for $N \in \mathbb{N}^*$, the dynamics given by $\mathbb{P}_{r,\beta,H}^N$ that starts from some $\Gamma_0^N \in N\mathcal{E}_{r_0}$ satisfying:*

- $(N^{-1}\Gamma_0^N)_N$ converges in Hausdorff distance to a set $\Gamma_0 \in \mathcal{E}_{r_0}$, and each $N^{-1}\Gamma_0^N$ and Γ_0 are at a distance at least $d_0 = 1/2$ in 1-norm from the boundary of $[-1, 1]^2$. We call $\mathcal{E}_{r_0}(1/2) \subset \mathcal{E}_{r_0}$ the subset of such curves, and in general $\mathcal{E}_r(d) \subset \mathcal{E}_r$ is the set of droplets at 1-distance at least $d > 0$ from the domain boundaries.
- The boundary γ_0 of Γ_0 is a Jordan curve, nowhere flat or vertical.

Unless otherwise said, d is a fixed number in $(0, 1/4)$. Travelling on a curve in X_r^N is always done clockwise. Moreover, we set $P_5 := P_1$, $P_6 := P_2$. In this article, $O_G(\delta)$ always means: bounded by a constant depending on an object G times δ for $\delta > 0$ sufficiently small. The letter C is used to denote a constant that may change from line to line, and $C(G, \delta)$ means that the constant depends only on G, δ and a numerical factor.

Importantly, if $\gamma^N \in X_r^N$, we unambiguously write $\gamma^N \in N\mathcal{E}_r$ instead of $\Gamma^N \in N\mathcal{E}_r$, when $\gamma^N = \partial\Gamma^N$. We also sometimes treat $\mathbb{P}_{r,\beta}^N$ as a measure on trajectories taking values in $N^{-1}X_r^N$ instead of X_r^N . The letter Γ will always denote a "droplet", i.e. a compact subset of \mathbb{R}^2 , and the letter γ its boundary.

2.2 Heuristics

Before stating the results, let us give an idea of what the contour dynamics does, and describe how it relates to the Symmetric Simple Exclusion Process (SSEP). One should always have in mind this connection, which serves as a guideline for many intuitions and computations presented in this article.

Microscopic curves, i.e. elements of X_r^N , can by definition be split in four quadrants C^1, \dots, C^4 . Inside quadrant k , consider the reference frame \mathcal{R}_k obtained by rotating the canonical frame by $\pi/4$ plus a multiple of $\pi/2$:

$$\mathcal{R}_k = (O, e_{\pi/4 - k\pi/2}, e_{\pi/4 - (k-1)\pi/2}) \quad \text{for } k \in \{1, \dots, 4\}. \quad (2.16)$$

In quadrant $k \in \{1, \dots, 4\}$, the curve is given by the graph $\{(x^k, f^k(x^k))_{\mathcal{R}_k} : x^k \in I^k\}$ of a function $f^k : I^k \subset \mathbb{R} \rightarrow \mathbb{R}$, see Figure 5. Assimilate each vertical edge to a particle, each horizontal edge to an

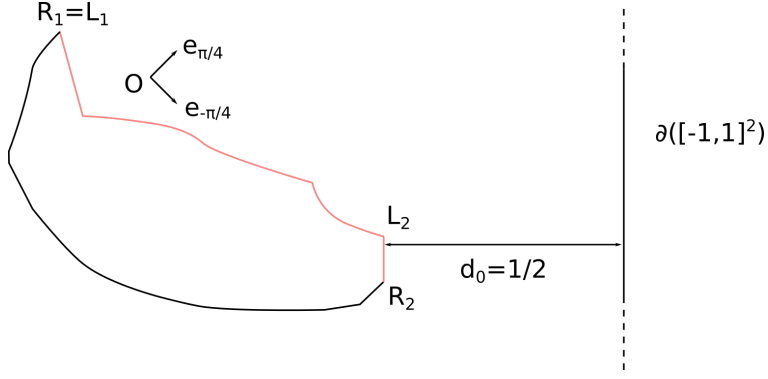

Figure 5: A possible initial condition Γ_0 . The reference frame $\mathcal{R}_1 = (O, e_{-\pi/4}, e_{\pi/4})$ is represented, and the graph of f^1 appears in light colour. The position of the origin O is not relevant.

empty site. Away from the poles, adding or removing a block is then possible whenever a corresponding particle can jump according to the exclusion rule (i.e. at most one particle per site), and the "occupation number" at a point $y = (x^k, f^k(x^k)) \in V(\gamma)$ reads

$$\xi_y = \frac{1 + (-1)^k (f^k(x^k + 2^{-1/2}) - f(x^k))}{2}. \quad (2.17)$$

This correspondence is detailed in the proof of Lemma 6.5, see Figure 9.

Consider now the macroscopic counterparts of elements of X_r^N : denote again by $(f^k(t, \cdot))_{t \geq 0}$ the family of functions representing quadrant $k \in \{1, \dots, 4\}$ of a macroscopic trajectory $(\gamma_t)_{t \geq 0}$ of curves taking values in \mathcal{E}_r (defined in Appendix B). Consider a parametrisation of each $\gamma_t, t \geq 0$ on the unit torus \mathbb{T} . Recall from (2.1) that the family $(\gamma_t)_{t \geq 0}$ is said to satisfy anisotropic motion by curvature until a time $T > 0$ if it solves:

$$\forall t < T, \forall u \in \mathbb{T}, \quad \partial_t \gamma(t, u) = a(\theta_t(u)) k(t, u) \nu(t, u). \quad (2.18)$$

In this equation, the time derivative is taken at fixed values of the parameter u , and $k(t, u)$ is the curvature of γ_t at $\gamma_t(u)$. The vector $\nu(t, u)$ is the inwards normal vector at $\gamma_t(u)$, $\theta_t(u)$ is the angle between the tangent vector T and e_1 and, finally, a is the anisotropy:

$$\forall \theta \in [0, 2\pi], \quad a(\theta) = \frac{1}{2(|\sin(\theta)| + |\cos(\theta)|)^2} = \frac{1}{2\|T(\theta)\|_1^2}. \quad (2.19)$$

One can check that, for each $x \in \mathbb{R}$ and $k \in \mathbb{Z}$, $a(\arctan(x) + \pi/4 + k\pi/2) = (1 + x^2)/2$. Elementary computations on a formal level then yield that, away from each pole, equation (2.18) translates into the heat equation on each quadrant:

$$\partial_t f^k = \frac{1}{4} \partial_{x^k}^2 f^k,$$

where the time derivative is taken at fixed value of the parameter x^k . This observation was already made by Spohn in [Spo93], and is used in the proof of the hydrodynamic limit in [LST14b]-[LST14a]. Assume that the poles of (γ_t) are fixed in time. Its four quadrants are then also fixed in time, hence each interval of definition I^k of f^k as well for $k \in \{1, \dots, 4\}$. Define $\rho^k = 1/2 + (-1)^k \partial_{x^k} f^k / 2$. The function $\rho^k : I^1 \rightarrow [0, 1]$ is the density of the equivalent SSEP on the first quadrant (compare with

(2.17)). Forgetting about boundary conditions for now, recall e.g. from [KL99] large deviations results for the density of a SSEP: trajectories occurring with probability of order e^{-N} are solutions, in a suitable sense, of

$$\partial_t \rho^k = \frac{1}{4} \partial_{x^k}^2 \rho^k - (1/2) \partial_{x^k} (\sigma(\rho^k) \partial_{x^k} H_k), \quad (2.20)$$

for some (possibly irregular) function $H_k : I^k \rightarrow \mathbb{R}$, and with $\sigma(\rho^k) = \rho^k(1 - \rho^k)$. By analogy with (2.20), interfaces occurring with probability of order e^{-N} should be solutions, inside each quadrant, to:

$$\partial_t f^k = \frac{1}{4} \partial_{x^k}^2 f^k + \sigma(f^k) \partial_{x^k} H_k, \quad (2.21)$$

with $\sigma(f^k) = \rho^k(1 - \rho^k) = (1 - (\partial_{x^k} f^k)^2)/4$. Recall that (2.21) is written under the assumption that I^k does not change with time. However, in the contour dynamics, poles move, as they are coupled together by the dynamics on each quadrant. Thus each interval $I^k, k \in \{1, \dots, 4\}$ depends on time, and it is not possible to define a single function H depending only on x^k , simultaneously in the four quadrants and for each time. This leads one to replace each of the $\partial_{x^k} H_k, k \in \{1, \dots, 4\}$ by a single function $H : \mathbb{R}^2 \rightarrow \mathbb{R}$. As a consequence, H now also depends on $f^k(x^k)$ inside each quadrant, and not just on x^k . The behaviour of (2.21) is still expected to be valid away from the poles, i.e. in the interior of $I^k(t)$ for each time, thus we expect that interfaces occurring with probability of order e^{-N} should satisfy:

$$\forall t > 0, \forall x \in \hat{I}^k(t), \quad \partial_t f^k = \frac{1}{4} \partial_{x^k}^2 f^k + \sqrt{2} \sigma(f^k) H((\cdot, f^k(\cdot))_{\mathcal{R}_k}). \quad (2.22)$$

The additional $\sqrt{2}$ factor compared to (2.21) comes from the derivative $\partial_{x^k} H$ that was removed. Let us obtain from (2.22) a parametrisation independent equation on the family (γ_t) . To do so, write for the tangent vector:

$$T(\theta) = \cos(\theta)e_1 + \sin(\theta)e_2 = [1 + (\partial_{x^k} f^k)^2]^{-1/2} (1, \partial_{x^k} f^k)_{\mathcal{R}_k}, \quad \theta = \theta(x^k) \in [0, 2\pi]. \quad (2.23)$$

If $v = (\|T\|_1)^{-1}$ and a is the anisotropy (2.19), then

$$a(\theta^k) = a(\pi/4 - k\pi/2 + \arctan(\partial_{x^k} f^k)) = \frac{1 + (\partial_{x^k} f^k)^2}{4}, \quad \frac{v(\theta^k)^2}{2} = a(\theta^k). \quad (2.24)$$

After some elementary computations, one finds that trajectories $(\gamma_t)_{t \geq 0}$ at scale e^{-N} , away from their poles, should look like solutions of an anisotropic motion by curvature with drift:

$$\nu \cdot \partial_t \gamma = ak - \mu H. \quad (2.25)$$

Recall that ν is the inwards normal vector, a is the anisotropy defined in (2.19), and μ is the mobility of the model, defined as:

$$\forall \theta \in [0, 2\pi], \quad \mu(\theta) = \frac{|\sin(2\theta)|}{2(|\sin(\theta)| + |\cos(\theta)|)} = \frac{|T(\theta) \cdot e_1| |T(\theta) \cdot e_2|}{\|T(\theta)\|_1}. \quad (2.26)$$

Indeed, e.g. in the first quadrant at time $t_0 \geq 0$, one has for each $x^1 \in I^1(t_0)$:

$$\mu(\theta(x^1)) = \sqrt{2} [1 + (\partial_{x^1} f^1)^2]^{1/2} \sigma(f^1(x^1)).$$

From (2.25), we see that the function H , that we introduced from considerations on the SSEP on each quadrant, plays the role of a magnetic field applied to \pm Ising spins (see [Spo93]), separated by an

interface corresponding to our contours γ .

It remains to somehow add in the contribution of the poles to that picture. It turns out (see Proposition 2.2) that due to the regrowth, β -dependent part of the microscopic dynamics, poles act as moving reservoirs which, at each time $t \geq 0$, fix the value of $\partial_{x^k} f^k(t, \cdot)$ in terms of β at the extremities of its interval of definition $I^k(t)$. We shall loosely refer to $\partial_{x^k} f^k$ as *the slope*. Equation (2.25) can then be interpreted as the coupling of four equations of the type (2.22) via Stefan-like boundary conditions at the poles, each of these equations being written in a domain $I^k(t)$, $k \in \{1, \dots, 4\}$ that depends on time. Understanding how this coupling works and how to deal with the motion of the poles without any monotonicity in the dynamics is the main challenge of this work.

2.3 Results

We now state our results, starting with the behaviour of the slope at the poles, in Proposition 2.2. This result is the most important specificity of our model. Define the microscopic averaged slope on either side of a pole as follows. For $\gamma \in N\mathcal{E}_r$, $k \in \mathbb{N}^*$ and $x \in V(\gamma)$, denote by $\xi_x^{+,k}$ the quantity:

$$\xi_x^{+,k} = \frac{1}{k+1} \sum_{\substack{y \in V(\gamma), y \geq x \\ \|x-y\|_1 \leq k}} \xi_y.$$

By $y \geq x$ we mean that y is encountered after x when travelling on γ clockwise ($N \gg k$). We define the other slope $\xi_x^{-,k}$ similarly by averaging over points that are before x on γ .

Proposition 2.2. *For $d > 0$, recall that $\mathcal{E}_r(d)$ is the subset of \mathcal{E}_r of curves at 1-distance at least d from the domain boundary $\partial([-1, 1]^2)$. Let $T_0 > 0$. Then, for any test function $G \in \mathcal{C}$ and $\delta > 0$, if $k \in \{1, 3\}$:*

$$\limsup_{\varepsilon \rightarrow 0} \limsup_{N \rightarrow \infty} \frac{1}{N} \log \mathbb{P}_{r,\beta}^N \left(\text{for a.e. } t \in [0, T_0], \gamma(t) \in N\mathcal{E}_r(d); \left| \int_0^{T_0} G(t, N^{-1}L_k(t)) (\xi_{L_k(t)}^{\pm, \varepsilon N} - e^{-\beta}) dt \right| \geq \delta \right) = -\infty.$$

If on the other hand $k \in \{2, 4\}$:

$$\limsup_{\varepsilon \rightarrow 0} \limsup_{N \rightarrow \infty} \frac{1}{N} \log \mathbb{P}_{r,\beta}^N \left(\text{for a.e. } t \in [0, T_0], \gamma(t) \in N\mathcal{E}_r(d); \left| \int_0^{T_0} G(t, N^{-1}L_k(t)) (1 - \xi_{L_k(t)}^{\pm, \varepsilon N} - e^{-\beta}) dt \right| \geq \delta \right) = -\infty.$$

This proposition shows that the slopes at the poles are fixed and form a cusp with angle of order $e^{-\beta}$. This is reminiscent of the SSEP in contact with reservoirs which fix the density at the points of contact [ELS90]. In our case, the exclusion dynamics on each quadrant are coupled by the fixed value of the slope.

Our second result justifies the definition of the "effective" state space \mathcal{E}_r : first, configurations starting inside the restricted configuration space $N\mathcal{E}_{r_0}$ take a time of order N^2 to exit this set. The arguments for this point are inspired by [CMST11]. Second, any trajectory that starts from Γ_0 , which is at distance $1/2$ from the domain boundary $\partial([-1, 1]^2)$, takes at least a diffusive time to first reach $\partial([-1, 1]^2)$. As in the proof of the large N behaviour for the zero-temperature stochastic Ising model in [LST14b], this proposition is crucial to be able to say anything about the typical behaviour of the contour process, meaning also about lower-bound large deviations.

Proposition 2.3. *Recall that $r, \beta, H, r_0, d_0 = 1/2$ are fixed as in Definition 2.1.*

1. *Let $r_1 \in (r, r_0)$ and define $\tau = \tau_{r_1, \beta, H}^N$ as the time for which the dynamics induced by $\mathbb{P}_{r, \beta, H}^N$ first leaves $N\mathcal{E}_{r_1}$. There are constants c_0, α that depend only on Γ_0, H, r_0, r_1 (but not on r, β) such that:*

$$\mathbb{P}_{r, \beta, H}^N(\tau < c_0) \leq \exp[-\alpha N]. \quad (2.27)$$

2. *Assume $\beta > 64 \log 3$. For each $d < 1/4$, there is a time $T_0 = T_0(\Gamma_0, d, d_0, \beta, H) \in (0, c_0]$, with c_0 as in (2.27), such that:*

$$\mathbb{P}_{r, \beta, H}^N\left(\forall t \in [0, T_0], \gamma_t \in \mathcal{E}_r; \int_0^{T_0} \mathbf{1}_{\text{dist}(\gamma_t, \partial([-1, 1]^2)) < d} dt > 0\right) = o_N(1). \quad (2.28)$$

Hydrodynamic limit

Next, we investigate the hydrodynamic limit of the contour process. This requires choosing a suitable topology on trajectories. In the proof of the hydrodynamic limit for the zero temperature stochastic Ising model in [LST14b]-[LST14a], the authors prove uniform convergence in time for the Hausdorff topology. The Hausdorff distance between sets appears as a natural distance to put on the state space: inside each quadrant, it is equivalent to weak convergence of the slopes, a topology in which hydrodynamics are known for the SSEP.

In the case of the contour model, the Skorokhod topology associated with the Hausdorff distance seems like a suitable choice. However, the regrowth part of the dynamics at the poles makes it very complicated to estimate the position of the poles at each time. We thus equip the set $D_H([0, T_0], \mathcal{E}_r)$ of càdlàg functions in Hausdorff distance with a weaker topology, without any point-like control at the pole, induced by the distance (2.29).

Let $T_0 > 0$ be a time given by Proposition 2.3. Recall that $X \supset N^{-1}X_r^N$ is the macroscopic state space and consider the distance:

$$\forall \Gamma, \Gamma' \in X^{[0, T_0]}, \quad d_E(\Gamma, \Gamma') = d_S^{L^1}(\Gamma, \Gamma') + \int_0^{T_0} d_H(\Gamma_t, \Gamma'_t) dt. \quad (2.29)$$

Above, $d_S^{L^1}$ is the Skorokhod distance associated with $L^1([-1, 1]^2)$ topology, and d_H is the Hausdorff distance on X . More is said on these objects in Appendix B.

For $d \in (0, d_0/2) = (0, 1/4)$, recall that $\mathcal{E}_r(d)$ is defined in Definition 2.1 as the subset of the effective state space \mathcal{E}_r with curves at 1-distance at least d from the domain boundary. A suitable set of trajectories for the contour dynamics will be $E([0, T_0], \mathcal{E}_r(d))$, defined as the completion of $D_H([0, T_0], \mathcal{E}_r(d))$ for the distance d_E . An explicit characterisation of elements in $E([0, T_0], \mathcal{E}_r(d))$ and topological properties are given in Appendix B.2.

The hydrodynamic limit result is the following: $\{Q_{r, \beta, H}^N : N \in \mathbb{N}^*\}$ has weak limit points supported on $E([0, T_0], \mathcal{E}_r(d))$, and any weak limit point concentrates onto weak solutions, in the sense defined below in (2.30), of

$$\partial_t \gamma \cdot \nu = a \partial_s^2 \gamma \cdot \nu - \mu H = ak - \mu H,$$

with ν the inwards normal vector, a the anisotropy (2.19), k the curvature and μ the mobility (2.26), and s the line abscissa.

Proposition 2.4. *The set $\{Q_{r,\beta,H}^N : N \in \mathbb{N}^*\}$ is relatively compact in $\mathcal{M}_1(E([0, T_0], X))$ equipped with the weak topology associated with d_E . Moreover, if $Q_{r,\beta,H}^*$ is one of its weak limit points, then it is concentrated on trajectories in $E([0, T_0], \mathcal{E}_r(d))$ satisfying: for any test function $G \in \mathcal{C}$ (see (2.13)),*

$$\begin{aligned} \int_{\Gamma_{T_0}} G_{T_0} - \int_{\Gamma_0} G_0 - \int_0^{T_0} \int_{\Gamma_\tau} \partial_\tau G_\tau d\tau &= \int_0^{T_0} \int_{\gamma_\tau \setminus P(\gamma_\tau)} \alpha(\theta(s_\tau)) \partial_{s_\tau} G(\tau, \gamma_\tau(s_\tau)) ds_\tau d\tau \\ &+ \int_0^{T_0} \int_{\gamma_\tau} \mu(\theta(s_\tau)) (HG)(\tau, \gamma_\tau(s_\tau)) ds_\tau d\tau - \sum_{k=1}^4 \int_0^{T_0} \left(\frac{1}{4} - \frac{e^{-\beta}}{2} \right) [G(\tau, L_k(\tau)) + G(\tau, R_k(\tau))] d\tau. \end{aligned} \quad (2.30)$$

Above, μ is the mobility of the model, defined in (2.26), and s_τ is the line abscissa on γ_τ , $\tau \in [0, T_0]$. For each $\theta \in [0, 2\pi] \setminus (\pi/2)\mathbb{Z}$, α is related to the anisotropy a by $\alpha'(\theta) = -a(\theta)$. One has:

$$\alpha(\theta) = \frac{a(\theta) \sin(2\theta) \cos(2\theta)}{2 |\sin(2\theta)|} = \frac{T(\theta) \cdot e_1 T(\theta) \cdot e_2}{4 \|T(\theta)\|_1} \left[\frac{1}{|T(\theta) \cdot e_2|} - \frac{1}{|T(\theta) \cdot e_1|} \right], \quad (2.31)$$

where $T(\theta) = \cos(\theta)e_1 + \sin(\theta)e_2$.

The proof relies on well-known martingale methods [KL99]. However, the fact that configurations are one-dimensional objects moving in a two-dimensional space introduces major difficulties. At the microscopic level, the main issue is that the vertices or edges of a curve cannot be labelled in a fixed reference frame.

Large deviations

We obtain upper-bound large deviations for the contour dynamics at finite $\beta > \log 3$. Assuming solutions of (2.30) to be unique, lower-bound large deviations also follow. Upper and lower bounds match for smooth trajectories. Specific to our model is, again, the control of the poles of the curves.

Let $T_0 > 0$ and consider r, β, H, d as in Definition 2.1. Given a trajectory $\Gamma \in E([0, T_0], \mathcal{E}_r(d))$ with boundaries $\gamma_t = \partial\Gamma_t$, $t \leq T_0$, define, recalling that L_k, R_k are the extremities of the pole P_k :

$$\begin{aligned} \ell_H^\beta(\Gamma) &= \langle \Gamma_{T_0}, H_{T_0} \rangle - \langle \Gamma_0, H_0 \rangle - \int_0^{T_0} \langle \Gamma_\tau, \partial_\tau H_\tau \rangle d\tau - \int_0^{T_0} d\tau \int_{\gamma_\tau \setminus P(\gamma_\tau)} \alpha(\theta(s_\tau)) \partial_{s_\tau} H(\tau, \gamma_\tau(s_\tau)) ds_\tau \\ &+ \left(\frac{1}{4} - \frac{e^{-\beta}}{2} \right) \int_0^{T_0} \sum_{k=1}^4 [H(\tau, L_k(\tau)) + H(\tau, R_k(\tau))] d\tau. \end{aligned} \quad (2.32)$$

Define also:

$$J_H^\beta(\Gamma) = \ell_H^\beta(\Gamma) - \frac{1}{2} \int_0^{T_0} \int_{\gamma_\tau} \mu(\theta(s_\tau)) H^2(\tau, \gamma_\tau(s_\tau)) ds_\tau d\tau, \quad \Gamma \in E([0, T_0], \mathcal{E}_r(d)) \quad (2.33)$$

where the mobility μ is defined in (2.26).

To build the rate function, we will have to restrict the state space to control the behaviour of the poles. Introduce thus the subset $E_{pp}([0, T_0], \mathcal{E}_r(d)) \subset E([0, T_0], \mathcal{E}_r(d))$ of trajectories with almost always point-like poles:

$$E_{pp}([0, T_0], \mathcal{E}_r(d)) = \left\{ \Gamma \in E([0, T_0], \mathcal{E}_r(d)) : \sum_{k=1}^4 \int_0^{T_0} |L_k(t) - R_k(t)| dt = 0 \right\}. \quad (2.34)$$

Recall that R_k (L_k) is the right (left) extrmity of pole $k \in \{1, \dots, 4\}$. Let us now define the rate function $I_\beta(\cdot | \Gamma_0)$:

$$I_\beta(\Gamma | \Gamma_0) = \begin{cases} \sup_{H \in \mathcal{C}} J_H^\beta(\Gamma) & \text{if } \Gamma \in E_{pp}([0, T_0], \mathcal{E}_r(d)), \\ +\infty & \text{otherwise,} \end{cases} \quad (2.35)$$

Remark 2.5. • Note that it is possible by Proposition 2.2 to enforce that only trajectories with slope $e^{-\beta}$ at the poles have finite rate function. One would expect this condition to already be present in (2.35), but the very weak topology at the poles makes it more complicated to see than e.g. for a SSEP with reservoirs, see [BLM09].

- If $\beta = \infty$ and Γ is a smooth trajectory in $C([0, T_0], \mathcal{E}_r(d))$ starting from Γ_0 (i.e. it has well defined, continuous normal speed and curvature at each time $t \in (0, T_0]$), then setting $\beta = \infty$ in (2.35) one obtains:

$$I_\infty(\Gamma|\Gamma_0) = \frac{1}{2} \int_0^{T_0} \int_{\gamma_t} \frac{(v - ak)^2}{\mu} ds_t dt.$$

As conjectured in (1.3), the rate function $I_\infty(\cdot|\Gamma_0)$ thus measures the quadratic cost of deviations from anisotropic mean-curvature motion. At $\beta < \infty$, the same picture holds except that trajectories with finite rate function are not smooth: they have kinks at the poles in the sense of Proposition 2.2. ■

In the proof of large deviations, trajectories associated with a smooth bias $H \in \mathcal{C}$ play a special role. Define the set of trajectories $\mathcal{A}_{T_0, r, \beta}^{\mathcal{C}} \subset E([0, T_0], \mathcal{E}_r)$ as follows:

$$\mathcal{A}_{T_0, r, \beta}^{\mathcal{C}} = \left\{ \Gamma \in E([0, T_0], \mathcal{E}_r(d)) : \text{there is a bias } H \in \mathcal{C} \text{ such that (2.30) has a unique solution in } E([0, T_0], \mathcal{E}_r(d)), \text{ which is continuous in time in Hausdorff topology, and this solution is } \Gamma \right\}. \quad (2.36)$$

Theorem 2.6. *Let $r < r_0$. For any $d \in (0, 1 - r)$, any closed set $F \subset E([0, T_0], \mathcal{E}_r(d))$ and any $\beta > \log 3$:*

$$\limsup_{N \rightarrow \infty} Q_{r, \beta}^N(F) \leq - \inf_F I_\beta(\cdot|\Gamma_0). \quad (2.37)$$

For any open set $O \subset E([0, T_0], \mathcal{E}_r(d))$ with $d \in [1/2, 1 - r)$ and any $\beta > 64 \log 3$,

$$\liminf_{N \rightarrow \infty} Q_{r, \beta}^N(O) \geq - \inf_{O \cap \mathcal{A}_{T_0, r, \beta}^{\mathcal{C}}} I_\beta(\cdot|\Gamma_0). \quad (2.38)$$

Remark 2.7. • The restriction to $d > 1/2$ and $\beta > 64 \log 3$ for the lower bound is purely technical. It is a consequence of item 2 in Proposition 2.3, and smaller d 's or smaller β 's could be considered without changing any proof, by enlarging the state space to droplets in $[-A, A]^2$, $A > 1$.

- We consider large deviation events on trajectories avoiding the domain boundary $\partial([-1, 1]^2)$ to avoid additional boundary conditions in (2.30).
- The choice of initial condition is for convenience only. We could also consider large deviations on the initial condition, with minor changes. ■

2.4 Comments on metastability

Before starting our study, we make some comments about metastability properties of the contour model. The reversibility introduced in the microscopic dynamics and the large deviation results of Theorem 2.6 give us a lot of information, as illustrated below.

Nucleation with a small magnetic field:

At equilibrium under $\nu_{r, \beta}^N$ (defined in (2.3)) with r small, contours are typically small as well. If a small

magnetic field h/N , $h > 0$ is added to the dynamics as in (2.14) with $H \equiv \beta h$, it remains reversible with respect to the measure ν_h defined by:

$$\forall \gamma \in X_r^N, \quad \nu_h(\gamma) = \nu_{r,\beta,h}^N(\gamma) = (Z_{r,\beta,h})^{-1} \exp \left[-\beta |\gamma| + 2\beta h \text{Vol}(\gamma)/N \right],$$

where $Z_{r,\beta,h} = \sum_{\gamma \in X_r^N} \exp[-\beta |\gamma| + \beta h \text{Vol}(\gamma)/N]$ is the associated partition function, and $\text{Vol}(\gamma)$ is the volume of the droplet that γ delimits. We can use the large deviations result (Theorem 2.6 above) to inquire about the typical volume above which a nucleated droplet can grow, as well as the shape that a droplet has while it grows or shrinks, depending on its size.

The surface tension $\tau_\beta = \tau_\beta(\theta)$, $\theta \in [0, 2\pi]$ of the contour model plays a key role in the nucleation. Away from the pole, it is equal, for each normal angle $\theta \notin (\pi/2)\mathbb{Z}$ and inverse temperature β , to the surface tension for the Ising model at first order in the large β limit, as given in [Spo93]:

$$\tau_\beta(\theta) = |\cos(\theta)| + |\sin(\theta)| + \beta^{-1} \left[|\sin(\theta)| \log \left[\frac{|\sin(\theta)|}{|\cos(\theta)| + |\sin(\theta)|} \right] + |\cos(\theta)| \log \left[\frac{|\cos(\theta)|}{|\cos(\theta)| + |\sin(\theta)|} \right] \right].$$

The results of Section 6, Proposition A.3 yield the value of the surface tension at the poles, i.e. for a normal angle $\theta \in (\pi/2)\mathbb{Z}$. It reads:

$$\forall k \in \mathbb{Z}, \quad \tau_\beta(k\pi/2) = 1 + \frac{1}{\beta} \log(1 - e^{-\beta}) < 1. \quad (2.39)$$

The parameter β introduces a discontinuity at the poles: for $k \in \mathbb{Z}$, $\lim_{\theta \rightarrow k\pi/2} \tau_\beta(\theta) = 1 \neq \tau_\beta(k\pi/2)$.

Speed of growth:

Another question of interest is the magnitude of the typical speed at which a big enough droplet grows to cover the whole space. The conjecture is that the microscopic speed V_{micro} reads

$$V_{\text{micro}} \sim CH, \quad (2.40)$$

see [SS98] for details, with H the amplitude of the magnetic field. This conjecture is easily verified in our case, where $H = h/N$ with a fixed $h > 0$. Indeed, we establish in Section 5, see particularly Lemma 5.5, that away from the poles droplets grow in volume with (inwards, macroscopic) normal speed:

$$v = ak - \mu h, \quad (2.41)$$

and the curvature should reasonably stay bounded as the droplet grows. The quantity a is the anisotropy defined in (2.19) and μ the mobility, see (2.26). As space is rescaled by $1/N$ and time by N^2 , one can relate microscopic and macroscopic speed by

$$v \sim (1/N) \times N^2 V_{\text{micro}} \quad \Rightarrow \quad V_{\text{micro}} \sim N^{-1} \sim H,$$

and (2.40) holds for the contour dynamics. The typical growth trajectory will satisfy (2.30).

3 Some relevant martingales

3.1 Motivations

To investigate rare events, we are going to consider a tilted probability measure, as in Chapter 10 of [KL99]. Fix a time $T_0 > 0$ throughout the rest of Section 3, and introduce a weak magnetic field $H \in \mathcal{C}$

(defined in (2.13)), so that for any Borel set $B \subset D_H([0, T_0], N^{-1}X_r^N)$ (the set of Hausdorff-càdlàg trajectories with values in $N^{-1}X_r^N$):

$$Q_{r,\beta}^N(B) = \mathbb{E}_{r,\beta}^N[\mathbf{1}_{\gamma \in B}] = \mathbb{E}_{r,\beta,H}^N[(D_{r,\beta,H}^N)^{-1}\mathbf{1}_{\gamma \in B}],$$

where $D_{r,\beta,H}^N = d\mathbb{P}_{r,\beta,H}^N/d\mathbb{P}_{r,\beta}^N$ is the Radon-Nikodym derivative until time T_0 , defined by:

$$N^{-1} \log D_{r,\beta,H}^N = \langle \Gamma_{T_0}, H_{T_0} \rangle - \langle \Gamma_0, H_0 \rangle - \int_0^{T_0} e^{-N\langle \Gamma_\tau, H_\tau \rangle} (\partial_\tau + N^2 \mathcal{L}_{r,\beta}) e^{N\langle \Gamma_\tau, H_\tau \rangle} d\tau. \quad (3.1)$$

Recall that, for a domain $\Gamma \in N^{-1}X_r^N$ and for $G : [-1, 1]^2 \rightarrow \mathbb{R}$, $\langle \Gamma, G \rangle = \int_\Gamma G$.

Obtaining lower-bound large deviations from that method requires computing hydrodynamic limits for all sequences of laws $(Q_{r,\beta,H}^N)_N$ with bias $H \in \mathcal{C}$. To do so, we investigate the behaviour of the projected processes $\langle \Gamma, G \rangle$, $\Gamma \in D_H([0, T_0], N^{-1}X_r^N)$, for a large class of test functions G (here, $G \in \mathcal{C}$), for which Ito's formula reads:

$$\forall t \leq T_0, \quad \langle \Gamma_t, H_t \rangle = \langle \Gamma_0, H_0 \rangle + \int_0^t (\partial_\tau + N^2 \mathcal{L}_{r,\beta,H}) \langle \Gamma_\tau, H_\tau \rangle d\tau + M_t^G, \quad (3.2)$$

where $(M_t^G)_{t \in [0, T_0]}$ is a martingale. It turns out that the computations of the action of the generator in (3.1) and in (3.2) are similar. Moreover, for the specific choice $G = H$, (3.2) is nearly identical to (3.1) to highest order in N . For this reason, as (3.2) is slightly more general, we detail the computation of M_t^G rather than that of $D_{r,\beta,H}^N$. The only non-trivial part is the computation of $N^2 \mathcal{L}_{r,\beta,H} \langle \Gamma, G \rangle$, which we now perform. For the rest of Section 3, we fix a test function $G \in \mathcal{C}$.

3.2 Computation of $N^2 \mathcal{L}_{r,\beta,H} \langle \Gamma, G \rangle$

We rewrite $N^2 \mathcal{L}_{r,\beta,H} \langle \Gamma, G \rangle$ as a term depending on the pole dynamics, plus another term that corresponds to the exclusion process on each quadrant of Γ . With particles corresponding to vertical edges, the exclusion term is rewritten in terms of local averages $\xi_x^{\varepsilon N}$ of the ξ 's, where for $\gamma \in X_r^N$ and $x \in V(\gamma)$, $\varepsilon > 0$ and $N \in \mathbb{N}^*$, the local density of vertical edges $\xi_x^{\varepsilon N}$ is defined as:

$$\xi_x^{\varepsilon N} = \frac{1}{2\varepsilon N + 1} \sum_{y \in B(x, \varepsilon N) \cap V(\gamma)} \xi_y. \quad (3.3)$$

The ball is taken with respect to $\|\cdot\|_1$, and we omit integer parts for ease of notation. In our case, it will be convenient to write $\xi_x^{\varepsilon N}$ as a function of the tangent vector at x . Recall that we always enumerate elements of $V(\gamma)$ *clockwise*, and define $t_x = e_x^+$ as the vector tangent to γ between x and $x + e_x^+$. In this case, the average tangent vector $t_x^{\varepsilon N}$ reads:

$$t_x^{\varepsilon N} = \frac{1}{2\varepsilon N + 1} \sum_{y \in B(x, \varepsilon N) \cap V(\gamma)} e_y^+ = \pm(1 - \xi_x^{\varepsilon N})e_1 + \pm \xi_x^{\varepsilon N} e_2. \quad (3.4)$$

In the following, we shall consider rescaled microscopic curves $\gamma \in N^{-1}X_r^N$, and we write $\xi_x, t_x^{\varepsilon N}$ for $x \in \gamma$ to denote $\xi_y, t_y^{\varepsilon N}$ with $y \in N\gamma \in X_r^N$, $y = Nx$.

The signs in (3.4) depend on the quadrant x belongs to. For instance, if $B(x, \varepsilon N)$ is included in the first quadrant,

$$t_x = (1 - \xi_x)e_1 - \xi_x e_2 \Rightarrow t_x^{\varepsilon N} = (1 - \xi_x^{\varepsilon N})e_1 - \xi_x^{\varepsilon N} e_2.$$

We stress the fact that due to the lattice structure, $\|t_x^{\varepsilon N}\|_1 = 1 \neq \|t_x^{\varepsilon N}\|_2$. This is where the anisotropy (2.2) in the macroscopic motion by curvature (2.18) comes from. Define consequently the norm and normalised tangent vector:

$$\forall x \in V(\gamma), \quad v_x^{\varepsilon N} := \|t_x^{\varepsilon N}\|_2, \quad T_x^{\varepsilon N} = t_x^{\varepsilon N} / v_x^{\varepsilon N}. \quad (3.5)$$

As $\|t_x^{\varepsilon N}\|_1 = 1$, we get:

$$v_x^{\varepsilon N} = \|t_x^{\varepsilon N}\|_2 = (\|T_x^{\varepsilon N}\|_1)^{-1}. \quad (3.6)$$

For $d \in (0, 1/4)$, recall from Definition 2.1 the definition of $N^{-1}X_r^N \cap \mathcal{E}_r(d)$, the set of (rescaled) microscopic curves in the effective state space \mathcal{E}_r which, in addition, are at distance at least d from $\partial([-1, 1]^2)$. Take a contour γ in that set and let $J \in C^2([-1, 1]^2)$. We are going to prove:

$$N^2 \mathcal{L}_{r,\beta,H} \langle \Gamma, J \rangle = \left[\text{line integral on } \gamma \text{ of a function of } t^{\varepsilon N} \text{ and } J, H \right] + o(1), \quad (3.7)$$

where $o(1)$ is shorthand for error terms in N, ε , and other parameters that will appear along the proof, whose time integral is small. The precise statement of (3.7) is given later on in Proposition 3.9; for now we give a microscopic expression of $N^2 \mathcal{L}_{r,\beta,H} \langle \Gamma, G \rangle$.

Proposition 3.1. *Fix a time $T_0 > 0$. For any $\delta > 0$, any $\varepsilon \in (0, 1)$ smaller than some $\varepsilon(\delta)$ and any $d \in (0, 1/4)$, there is a set $Z = Z(\delta, \varepsilon, d) \subset E([0, T_0], X)$ such that $Z^c \cap E([0, T_0], \mathcal{E}_r(d))$ has probability super-exponentially small when $N \rightarrow \infty, \varepsilon \rightarrow 0$. The set $E([0, T_0], \mathcal{E}_r(d))$ is defined in Appendix B.2. Moreover, for configurations in Z :*

$$\begin{aligned} \int_0^{T_0} N^2 \mathcal{L}_{r,\beta,H} \langle \Gamma_\tau, G_\tau \rangle d\tau &= - \left(\frac{1}{4} - \frac{e^{-\beta}}{2} \right) \int_0^{T_0} \sum_{k=1}^4 [G(\tau, L_k(\tau)) + G(\tau, R_k(\tau))] d\tau + O_{G,H}(\delta) \\ &+ O_{G,H} \left(\int_0^{T_0} d\tau \sum_{k=1}^4 \frac{p_k(\tau)}{N} \right) + \frac{1}{4N} \int_0^{T_0} d\tau \sum_{x \in V^\varepsilon(\gamma_\tau)} (v_x^{\varepsilon N})^2 [T_x^{\varepsilon N} \cdot m(x)] T_x^{\varepsilon N} \cdot \nabla G(\tau, x) d\tau \\ &+ \frac{1}{N} \int_0^{T_0} d\tau \sum_{x \in V(\gamma_\tau)} (v_x^{\varepsilon N})^2 |T_x^{\varepsilon N} \cdot e_1| |T_x^{\varepsilon N} \cdot e_2| (GH)(\tau, x). \end{aligned} \quad (3.8)$$

Recall that p_k is the number of edges in Pole $k \in \{1, \dots, 4\}$. The vector $T_x^{\varepsilon N}$ is defined in (3.5), and the quantity $m = (\pm 1, \pm 1)$ is a sign vector with value determined only by the quadrant, see Definition 3.6. For $\gamma \in X_r^N$, $V^\varepsilon(\gamma) \subset V(\gamma)$ is the subset of vertices at 1-distance at least εN from the poles.

The rest of Section 3 is devoted to the proof of Proposition 3.1 (and its statement in the continuous limit, Proposition 3.9). We write the different terms in (3.8) for fixed time whenever possible, in which case the time dependence on G and H is omitted.

Notation: in the rest of Section 3, we consider only rescaled microscopic curves in $N^{-1}X_r^N$, and fix $\gamma \in N^{-1}X_r^N \cap \mathcal{E}_r$. $\Gamma \subset [-1, 1]^2$ is the corresponding droplet: $\gamma = \partial\Gamma$. We still denote by $V(\gamma)$ the points of $N^{-1}\mathbb{Z}^2$ that γ passes through, and by $P_k(\gamma)$, $k \in \{1, \dots, 4\}$ the poles of γ . We write abusively $x, x + 2e_x^+ \in P_k(\gamma)$ for $x \in V(\gamma)$, instead of $x, x + 2e_x^+/N \in P_k(\gamma)$.

Proof of Proposition 3.1.

Recall from (2.14) the definition of the jump rates under the dynamics with bias H . We claim that, to

highest order in N , the bias does not change the jump rate at the pole. Indeed, if x is in a pole of γ and $t \in [0, T_0]$,

$$c^{H_t}(\gamma, \gamma^{\pm, x}) = c(\gamma, \gamma^{\pm, x})(1 + O_H(N^{-1})), \quad (3.9)$$

so that the bias changes the jump rate at pole $P_k(t)$, $k \in \{1, \dots, 4\}$ by at most $O_H(p_k(t)/N)$, with $p_k(t) = |P_k(t)|$. As proven later (in Section 6), the time integral of this quantity is of order $1/N$. To highest order in N , $N^2 \mathcal{L}_{r, \beta, H} \langle \Gamma, G \rangle$ thus reads, omitting the time dependence:

$$N^2 \mathcal{L}_{r, \beta, H} \langle \Gamma, G \rangle = \text{Bulk term} + \text{Pole terms},$$

with (recall (2.14) for the definition of the jump rates):

$$\text{Bulk term} = N^2 \sum_{x \in V(\gamma)} c_x^{H_t}(\gamma) [\langle \Gamma^x, G \rangle - \langle \Gamma, G \rangle], \quad (3.10)$$

and, by (2.11)-(2.12):

$$\begin{aligned} \text{Pole terms} &= N^2 \sum_{k=1}^4 \sum_{\substack{x \in P_k(\gamma) \\ x+2e_x^+ \in P_k(\gamma)}} \left[\mathbf{1}_{DP_r^k, p_k=2} [\langle \Gamma^{x,-}, G \rangle - \langle \Gamma, G \rangle] + e^{-2\beta} \mathbf{1}_{x \notin \partial([-1, 1]^2)} [\langle \Gamma^{x,+}, G \rangle - \langle \Gamma, G \rangle] \right] \\ &\quad - \frac{N^2}{2} \sum_{k=1}^4 \mathbf{1}_{p_k=2} \sum_{x \in \{R_k, L_k\}} [\langle \Gamma^x, G \rangle - \langle \Gamma, G \rangle] + O_H \left(\sum_{k=1}^4 \frac{p_k}{N} \right). \end{aligned} \quad (3.11)$$

DP_r^k is the set V_r or H_r , defined in (2.9)-(2.10), depending on the value of $k \in \{1, \dots, 4\}$. The second line in (3.11) corresponds to the rate $1/2$ jumps that delete only one of two blocks of a pole of size 2, that are forbidden by the dynamics. However, it is convenient to incorporate them in the Bulk term (3.10), hence the need to subtract them.

The notation $\sum_{x, x+2e_x^+ \in P_k}$ is a way of enumerating all $p_k - 1$ vertices in the pole P_k , $k \in \{1, \dots, 4\}$ such that two blocks can be placed atop $[x, x + 2e_x^+]$ or removed below $[x, x + 2e_x^+]$. Finally, the error term $O_H(\sum_{k=1}^4 p_k/N)$ is a consequence of (3.9); its time integral is of order $O_H(1/N)$ as proven in Section 6. To prove Proposition 3.9, we treat the Bulk and Pole terms separately.

- Section 3.2.1 deals with the Pole terms (3.11), which are a specificity of the contour dynamics. We state all useful results; proofs are postponed to Section 6.
- Section 3.2.2 contains all results on the Bulk term (3.10). We explain how to express them in terms of local averages of the tangent vector $t_x^{\varepsilon N}$, by tweaking the usual methods used e.g. for the exclusion process. This concludes the proof of Proposition 3.1. The Bulk term (3.10), which will correspond to the last two terms in (3.8), is then recast in terms of N -independent line-integrals. This is the content of Proposition 3.9, stated at the end of the section.

3.2.1 Pole terms

Fix $d \in (0, 1/4)$ and recall notations and the definition of $\mathcal{E}_r(d)$ from Definition 2.1; of $E([0, T_0], \mathcal{E}_r(d))$ from Appendix B.2. In this section, we compute the Pole terms (3.11), and obtain the following result:

Lemma 3.2. *For each $\delta > 0$, there is a set $Z_P = Z_P(d, \delta) \subset E([0, T_0], X)$, such that $(Z_P)^c \cap E([0, T_0], \mathcal{E}_r(d))$ has probability super-exponentially small under $\mathbb{P}_{r, \beta, H}^N$, and on Z_P :*

$$\int_0^{T_0} d\tau [Pole \text{ terms for } \gamma_\tau] = C(G)(o_N(1) + \delta) + \frac{e^{-\beta}}{2} \int_0^{T_0} d\tau [G(\tau, R_k(\tau)) + G(\tau, L_k(\tau))]. \quad (3.12)$$

Proof. Notice first that deleting a single block with extremity x means subtracting to $\langle \Gamma, G \rangle$ the contribution of G on a block of side-length $1/N$, i.e. $N^{-2}G(x/N) + O_G(N^{-3})$. Similarly, adding one block contributes $N^{-2}G(x/N) + O_G(N^{-3})$. As a result, $N^2 \sum_{x \in \{R_k, L_k\}} \langle \Gamma^x, G \rangle$ contributes $-G(L_k/N) - G(R_k/N)$ to highest order in N for each $k \in \{1, \dots, 4\}$, so that (3.11) reads:

$$\text{Pole terms} = \frac{1}{2} \sum_{k=1}^4 \mathbf{1}_{p_k=2} [G(L_k/N) + G(R_k/N)] \quad (3.13)$$

$$+ 2 \sum_{k=1}^4 \sum_{\substack{x \in P_k(\gamma) \\ x+2e_x^\pm \in P_k(\gamma)}} [e^{-2\beta} \mathbf{1}_{x \notin \partial([-1,1]^2)} - \mathbf{1}_{DP_r^k, p_k=2}] G(x/N) + O_{G,H} \left(N^{-1} \sum_{k=1}^4 p_k \right) \quad (3.14)$$

The claim of Lemma 3.2 is then a simple consequence of the following three lemmas, the proofs of which, postponed to Section 6, are one of the major technical difficulties of this article. In each of the lemmas, the condition $\{\forall \tau \in [0, T_0], \gamma_\tau \in \mathcal{E}_r\}$ (or $\mathcal{E}_r(d)$) is enforced to control the change of probability between $\mathbb{P}_{r,\beta,H}^N$ and $\mathbb{P}_{r,\beta}^N$, as will be seen in the computations of Section 3.2.2. Parameters r, β are chosen as in Definition 2.1.

Lemma 3.3. *For each pole $k \in \{1, \dots, 4\}$ and each $A > 1$,*

$$\limsup_{N \rightarrow \infty} \frac{1}{N} \log \mathbb{P}_{r,\beta,H}^N \left(\forall \tau \in [0, T_0], \gamma_\tau \in \mathcal{E}_r; \frac{1}{T_0} \int_0^{T_0} \mathbf{1}_{P_k(\gamma_\tau) \cap \partial([-1,1]^2) = \emptyset} e^{-2\beta} (p_k(\tau) - 1) d\tau > A \right) = -\infty.$$

For trajectories taking values in $\mathcal{E}_r(d) \subset \mathcal{E}_r$, this lemma implies that the time integral of the $\sum_{k=1}^4 p_k/N$ error term in (3.14) is of order $1/N$, hence vanishes to leading order in N as previously claimed.

Lemma 3.4. *Let $G \in C^{0,1}(\mathbb{R}_+ \times [-1, 1]^2)$ be compactly supported in time, recall the definition of DP_r^k from (2.9)-(2.10) and let W_t^G be defined, for $t \geq 0$, as:*

$$W_t^G = \sum_{k=1}^4 \sum_{\substack{x \in P_k(t) \\ x+2e_x^\pm \in P_k(t)}} [\mathbf{1}_{p_k(t)=2, DP_r^k} - \mathbf{1}_{P_k(t) \cap \partial([-1,1]^2) = \emptyset} e^{-2\beta}] G(t, x). \quad (3.15)$$

We write $G(t, x)$ instead of $G(t, x/N)$ as we work on rescaled microscopic curves. Then:

$$\forall \delta > 0, \quad \limsup_{N \rightarrow \infty} \frac{1}{N} \log \mathbb{P}_{r,\beta,H}^N \left(\forall \tau \in [0, T_0], \gamma_\tau \in \mathcal{E}_r; \left| \int_0^{T_0} W_\tau^G d\tau \right| > \delta \right) = -\infty. \quad (3.16)$$

Thanks to Lemma 3.4, the time integral of the first term in (3.14) vanishes to leading order in N . It remains to compute (3.13), i.e. the $\mathbf{1}_{p_k=2} \sum_{x \in \{R_k, L_k\}}$ term. Its value is in fact fixed by the dynamics in terms of β , and can be computed.

Lemma 3.5. *For each pole $k \in \{1, \dots, 4\}$, each $\delta > 0$ and each $G \in \mathcal{C}$,*

$$\limsup_{N \rightarrow \infty} \frac{1}{N} \log \mathbb{P}_{r,\beta,H}^N \left(\text{for a.e. } \tau \in [0, T_0], \gamma_\tau \in \mathcal{E}_r(d); \left| \int_0^{T_0} G(t, L_k(t)) (\mathbf{1}_{p_k(\tau)=2} - e^{-\beta}) dt \right| > \delta \right) = -\infty.$$

We now define the set Z_P mentioned in Lemma 3.2. For $A > 1$, define the set of trajectories with poles of size less than $Ae^{2\beta}$:

$$B_p^N = B_p^N(A, \beta) := \bigcap_{k=1}^4 \left\{ (\gamma_\tau^N)_{\tau \in [0, T_0]} \in E([0, T_0], N^{-1}X_r^N) : \right. \\ \left. \frac{1}{T_0} \int_0^{T_0} (p_k(\tau) - 1) e^{-2\beta} \mathbf{1}_{P_k(\gamma_\tau^N) \cap \partial([-1, 1]^2) = \emptyset} d\tau \leq A \right\}. \quad (3.17)$$

On this set, the error term $\int_0^{T_0} d\tau \sum_k p_k(\tau)/N$ is of order N^{-1} as claimed below (3.11). By Lemma 3.3, $(B_p^N)^c \cap E([0, T_0], \mathcal{E}_r)$ has probability super-exponentially small under $\mathbb{P}_{r, \beta, H}^N$. Define then $Z_P = Z_P(A = 2, \beta, \delta)$ as:

$$Z_P = B_p^N(2, \beta) \cap \left\{ \left| \int_0^{T_0} W_\tau^G d\tau \right| \leq \delta \right\} \cap \left\{ \sum_{k=1}^4 \left| \int_0^{T_0} G(t, L_k(t)) (\mathbf{1}_{p_k(\tau)=2} - e^{-\beta}) d\tau \right| \leq \delta \right\}. \quad (3.18)$$

On the subset of trajectories taking values in $N^{-1}X_r^N \cap \mathcal{E}_r(d)$ for almost every time, $(Z_P)^c$ has indeed probability super-exponentially small under $\mathbb{P}_{r, \beta, H}^N$. This completes the proof of Lemma 3.2. \square

3.2.2 Bulk terms

In this section, we focus on the Bulk term. The proof of Proposition 3.1 is completed, and discrete sums recast in terms of line integrals in Proposition 3.9. As the time dependence of H, G plays no role in the detail of the computations, we consider H, G as functions in $C^2([-1, 1]^2)$. We proceed in several steps.

Step 1: discrete Bulk terms.

Recall from (3.4) that the microscopic tangent vector $t_x^{\varepsilon N}$ has coordinates $\pm \xi_x^{\varepsilon N}$, $\pm(1 - \xi_x^{\varepsilon N})$ with signs that vary depending on the quadrant. It is useful to define a function m that contains information on how these signs vary.

Definition 3.6. Recall that γ is a curve in $N^{-1}X_r^N \cap \mathcal{E}_r$, and define a function $m(\gamma) : \gamma \setminus P(\gamma) \rightarrow \mathbb{R}^2$ as follows:

$$\forall x \in \gamma \setminus P(\gamma), \quad m(x) := m(\gamma, x) = -\sqrt{2} e_{\pi/4 - (k(x)-1)\pi/2}, \quad (3.19)$$

where $P(\gamma) = \cup_k P_k(\gamma)$ is the union of the poles of γ . In (3.19), $k(x) \in \{1, \dots, 4\}$ is the index of the quadrant of γ the point x belongs to. This means that $m(x) = (-1, -1)$ for x in the first quadrant, $m(x) = (-1, 1)$ in the second quadrant, etc.

Lemma 3.7. For fixed $\delta > 0$, and each ε small enough with respect to δ , there is a set $Z_B = Z_B(\delta, \varepsilon) \subset E([0, T_0], X)$, such that $(Z_B)^c \cap E([0, T_0], \mathcal{E}_r)$ has probability super-exponentially small when $N \rightarrow \infty$, $\varepsilon \rightarrow 0$, and on Z_B :

$$\int_0^{T_0} d\tau [\text{Bulk term for } \gamma_\tau] = -\frac{1}{4} \int_0^{T_0} d\tau \sum_{k=1}^4 [G(\tau, L_k(\gamma_\tau)) + G(\tau, R_k(\gamma_\tau))] + C_{G, H} (o_\delta(1) + o_N(1)) \\ + \frac{1}{N} \int_0^{T_0} d\tau \sum_{x \in V(\gamma_\tau)} |t_1 t_2| H(\tau, x) G(\tau, x) + \frac{1}{4N} \int_0^{T_0} d\tau \sum_{x \in V^\varepsilon(\gamma_\tau)} [t \cdot m(x)] t \cdot \nabla G(\tau, x). \quad (3.20)$$

In this formula, t, t_i are short for $t_x^{\varepsilon N}, t_x^{\varepsilon N} \cdot e_i$, $i \in \{1, 2\}$, with $t_x^{\varepsilon N}$ defined in (3.4). For $\gamma \in N^{-1}X_r^N$, the set $V^\varepsilon(\gamma) \subset V(\gamma)$ contains all points at 1-distance at least ε from the poles of γ .

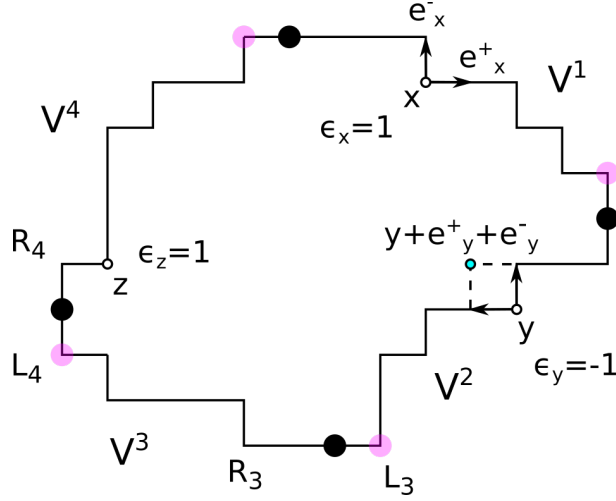

Figure 6: Definition of the V^k , $k \in \{1, \dots, 4\}$, represented for a curve in X_r^N (i.e. non rescaled by N^{-1}) for legibility. The black dots are the first vertices and the light dots the last vertices of each V^k . Three points are marked by empty circles, with the corresponding value of $\varepsilon(\gamma)$. The block that is deleted if y is flipped is represented, the two arrows correspond to e_y^+ and e_y^- .

Proof of Lemma 3.7. As for the Pole terms in Section 3.2.1, we work at fixed time and omit the time dependence. The letter γ still denotes a curve in $N^{-1}X_r^N \cap \mathcal{E}_r$. Let $x \in V(\gamma)$ not be in a pole of size 2. Recall that e_x^+, e_x^- are the unit vectors with origin x , pointing respectively towards the next and the previous point of $V(\gamma)$ when travelling clockwise. If x is flipped, then:

$$\begin{aligned} \int_{\Gamma^x} G - \int_{\Gamma} G &= \varepsilon_x(\gamma) \int_{[x, x+e_x^-/N] \times [x, x+e_x^+/N]} G = \frac{\varepsilon_x(\gamma)}{N^2} \int_{[0,1]^2} G\left(x + \frac{u}{N}e_x^- + \frac{v}{N}e_x^+\right) dudv \\ &= \frac{\varepsilon_x(\gamma)}{N^2} \left(G(x) + \frac{1}{2N}(\partial_{e_x^-} + \partial_{e_x^+})G(x) \right) + O(N^{-4}), \end{aligned}$$

which is the contribution of the integral of G over the block that is added or removed when flipping x . Above, $\varepsilon_x(\gamma)$ is 1 if flipping x means adding one block, and -1 if it means deleting one (see Figure 6). Recall from (2.6)-(2.14) that for $x \in V(\gamma)$ and $t \in [0, T_0]$,

$$c_x^{H_t}(\gamma) = c_x(\gamma)(1 + N\langle \Gamma^x, H_t \rangle - N\langle \Gamma, H_t \rangle + O_H(N^{-2})). \quad (3.21)$$

Since $\gamma \in \mathcal{E}_r$, the jump rate $c^{H_t}(\gamma, \gamma^x)$ is equal to $c_x^{H_t}(\gamma)$, i.e. it is local, see (2.6). The Bulk term (3.10) thus reads:

$$\begin{aligned} \text{Bulk term} &= \frac{1}{N} \sum_{x \in V(\gamma)} c_x(\gamma)(HG)(x) + \sum_{x \in V(\gamma)} c_x(\gamma)\varepsilon_x(\gamma)G(x) \\ &+ \frac{1}{2N} \sum_{x \in V(\gamma)} c_x(\gamma)\varepsilon_x(\gamma)(\partial_{e_x^-} + \partial_{e_x^+})G(x) + O_G(N^{-1}). \end{aligned} \quad (3.22)$$

At first sight, the second sum is of order N since $|V(\gamma)| \approx N$, whereas we want something of order 1. We split it along each quadrant and show that we can perform another integration by parts. To decompose the curves on each quadrant $C_k(\gamma)$, $k \in \{1, \dots, 4\}$, consider the subset V_k of $V(\gamma) \cap C_k(\gamma)$ composed of all vertices starting from the first vertex of P_k after L_k , and ending at L_{k+1} ($L_5 := L_1$), see

Figure 6. In that way, on each of the V_k , the computation of (3.22) is the same as for a SSEP. Indeed, with this definition of the V_k , for each k and $x \in V_k$, $\varepsilon_x(\gamma)$ and $c_x(\gamma)$ can be expressed in terms of the local "occupation numbers" $\xi_y, \|y - x\|_1 \leq N^{-1}$ only. For instance for $x \in V_1$:

$$2c_x(\gamma)\varepsilon_x(\gamma) = \xi_{x+e_x^-} - \xi_x. \quad (3.23)$$

With that splitting along the V_k , (3.22) becomes:

$$\text{Bulk term} := \frac{1}{N} \sum_{x \in V(\gamma)} c_x(\gamma)(HG)(x) + \sum_{k=1}^4 B_k + \sum_{k=1}^4 B'_k + O_G(N^{-1}), \quad (3.24)$$

where:

$$B_k = \sum_{x \in V_k} c_x(\gamma)\varepsilon_x(\gamma)G(x), \quad B'_k = \frac{1}{2N} \sum_{x \in V_k} c_x(\gamma)\varepsilon_x(\gamma)(\partial_{e_x^-} + \partial_{e_x^+})G(x). \quad (3.25)$$

1) B_k terms: using equation (3.23), B_1 reads:

$$\begin{aligned} B_1 &= \sum_{x \in V_1} c_x(\gamma)\varepsilon_x(\gamma)G(x) = \frac{1}{2} \sum_{x \in V_1} G(x)(\xi_{x+e_x^-} - \xi_x) \\ &= \frac{1}{4} \sum_{x \in V_1} G(x) [\xi_{x+e_x^-} - \xi_x + (1 - \xi_x) - (1 - \xi_{x+e_x^-})]. \end{aligned} \quad (3.26)$$

The passage from first to second line aims at making the expression symmetrical with respect to the transformation $\xi \leftarrow 1 - \xi$. The reason is that the contour model is symmetrical with respect to a global $\pi/2$ rotation, whereas the notation ξ_x is not: in terms of SSEP, ξ_x is one if there is a particle in quadrants 1 and 3, but is 1 if there is a hole instead in quadrants 2 and 4.

By definition, the first edge in V_1 , write it $(R_1 + 1, R_1 + 2)$, is always horizontal: $1 - \xi_{R_1+1} = 1$. On the other hand, V_1 ends at L_2 and $\xi_{L_2} = 1$ by definition of L_2 . Integrating (3.26) by parts, some of the boundary term thus vanish, whence:

$$B_1 = -\frac{1}{4}(G(L_1) + G(L_2)) + \frac{1}{4N} \sum_{x \in V_1} [\xi_x \partial_{e_x^+} G(x) - (1 - \xi_x) \partial_{e_x^+} G(x)] + O_G(N^{-1}). \quad (3.27)$$

On V_1 , $\xi_x e_x^+$ is either 0 if $\xi_x = 0$, or $-e_2$ if $\xi_x = 1$. Similarly, $(1 - \xi_x) e_x^+$ is either 0 or e_1 . In any case, the sign of $e_x^+ \cdot e_i$ is fixed in a given quadrant whenever $e_x^+ \cdot e_i \neq 0$. Thus, to obtain an expression for the B_k that does not explicitly depend on the quadrant, we keep in mind Figure 6 and define signs σ_1, σ_2 constant on a given quadrant:

$$\sigma_1 := \begin{cases} 1 & \text{if } x \in V_4 \cup V_1 \\ -1 & \text{if } x \in V_2 \cup V_3 \end{cases}, \quad \sigma_2 := \begin{cases} 1 & \text{if } x \in V_3 \cup V_4 \\ -1 & \text{if } x \in V_1 \cup V_2 \end{cases}. \quad (3.28)$$

The idea behind (3.28) is that (σ_1, σ_2) is "the direction of the tangent vector to a curve" in each quadrant. For instance, in the first quadrants, curves are south-east paths and $(\sigma_1, \sigma_2) = (1, -1)$, in quadrant 2 curves are south-west paths and $(\sigma_1, \sigma_2) = (-1, -1)$, etc. Compare with m in Definition 3.6, which gives "the direction of the inwards normal":

$$m = -(-\sigma_2, \sigma_1) = (\sigma_2, -\sigma_1). \quad (3.29)$$

Repeating the computations leading to (3.27) on the other quadrants V^k , one finds for the B_k :

$$\begin{aligned} \sum_{k=1}^4 B_k &= -\frac{1}{4} \sum_{k=1}^4 [G(L_k) + G(R_k)] + O_G \left(N^{-1} \sum_{k=1}^4 p_k \right) \\ &\quad + \frac{1}{4N} \sum_{x \in V(\gamma) \setminus P(\gamma)} \left(-\xi_x \sigma_1 \partial_2 + (1 - \xi_x) \sigma_2 \partial_1 \right) G(x). \end{aligned} \quad (3.30)$$

Equation (3.30) is now clearly composed of terms of order at most 1 in N . The error term is comprised of two contributions. On the one hand, summing the B_k yields a term $-(1/2) \sum_k G(L_k)$. It is more convenient to symmetrise this term and write it as $-(1/4) \sum_k [G(R_k) + G(L_k)]$, which creates an error bounded by $\|\nabla G\|_\infty \sum_k p_k / N$. On the other hand, the sum in (3.27) bore on the entirety of $V(\gamma)$, while in (3.30) all points in $P(\gamma)$ are removed. There are $\sum_k p_k$ such points, which are responsible for an error term bounded by $N^{-1} \sum_k p_k \|G\|_\infty$.

2) B'_k terms (defined in (3.25)): Notice that if $c_x(\gamma) \neq 0$, then $\varepsilon_x(\gamma)(\partial_{e_x^+} + \partial_{e_x^-})$ is the same whether a block is added or deleted at x . Moreover, it depends only on the $k \in \{1, \dots, 4\}$ such that $x \in V_k$, and:

$$\sum_{k=1}^4 B'_k = \frac{1}{2N} \sum_{x \in V(\gamma)} c_x(\gamma) \left(-\sigma_2 \partial_1 + \sigma_1 \partial_2 \right) G(x). \quad (3.31)$$

To conclude the proof of Lemma 3.7 from (3.24)-(3.30)-(3.31), it remains to replace ξ_x , $\xi_x(1 - \xi_{x+e_x^-})$ and $c_x(\gamma)$ by local averages on small macroscopic boxes. This is the content of the so-called Replacement lemma, stated below and proven in Appendix A.

Lemma 3.8 (Replacement lemma). *Consider a function ϕ on $N^{-1}X_r^N$ defined as follows:*

$$\forall \gamma' \in N^{-1}X_r^N, \forall x \in V(\gamma'), \quad \phi(\tau_x \gamma') = c_x(\gamma')$$

For $\varepsilon > 0$, recall from (3.3) the definition of $\xi_x^{\varepsilon N}$ and define a locally averaged version of ϕ :

$$\tilde{\phi}(\tau_x \gamma') = \xi_x^{\varepsilon N} (1 - \xi_x^{\varepsilon N}).$$

For and $F : \mathbb{R}_+ \times [-1, 1]^2$ bounded, define $W_{\varepsilon N}^{\phi, F}$ on $(\tau, \gamma') \in [0, T_0] \times N^{-1}X_r^N$ by:

$$W_{\varepsilon N}^{\phi, F}(\tau, \gamma') = \frac{1}{N} \sum_{x \in V(\gamma')} F(\tau, x) \left[\phi(\tau_x \gamma') - \tilde{\phi}(\tau_x \gamma') \right]. \quad (3.32)$$

Then, for each $\delta > 0$,

$$\limsup_{\varepsilon \rightarrow 0} \limsup_{N \rightarrow \infty} \frac{1}{N} \log \mathbb{P}_{r, \beta, H}^N \left(\forall \tau \in [0, T_0], \gamma_\tau \in \mathcal{E}_r; \left| \int_0^{T_0} W_{\varepsilon N}^{\phi, F}(\tau, \gamma_\tau) d\tau \right| > \delta \right) = -\infty.$$

Using Lemma 3.8, we conclude the proof of Lemma 3.7. Define:

$$B_F^i(\delta, \varepsilon) = \left\{ (\gamma_\tau)_{\tau \in [0, T_0]} \in E([0, T_0], \mathcal{E}_r) : \left| \int_0^{T_0} W_{\varepsilon N}^{\phi, F}(\tau, \gamma_\tau) d\tau \right| \leq \delta \right\}. \quad (3.33)$$

By Lemma 3.8, for each $\delta > 0$, $(B_F^i(\delta, \varepsilon))^c \cap E([0, T_0], \mathcal{E}_r)$ has probability super-exponentially small under $\mathbb{P}_{r, \beta, H}^N$ when N is large and ε small. Define then

$$\tilde{Z}_B := (\tilde{Z}_B)_{H, G}^N(\delta, \varepsilon) = B_{\nabla G}^1(\delta, \varepsilon) \cap B_{\nabla G}^2(\delta, \varepsilon) \cap B_{HG}^2(\delta, \varepsilon). \quad (3.34)$$

The computations leading to (3.24)-(3.30)-(3.31) are valid at each time for a trajectory γ taking values in $N^{-1}X_r^N \cap \mathcal{E}_r$. Recall from Lemma 3.7 that we are interested in time integrals of (3.24)-(3.30)-(3.31). By Lemma 3.8, for trajectories in \tilde{Z}_B , replacement of local quantities by averages in these equations yields an error term with time integral bounded by δ . To not burden the notations with a time dependence however, we continue to work with a curve $\gamma \in N^{-1}X_r^N \cap \mathcal{E}_r$ and formally replace local functions $\xi_x, e_x^+, c_x(\gamma)$ by their averages on an εN -neighbourhood, knowing that the procedure is legitimate when integrating in time, up to an error δ .

We start by applying Lemma 3.8 to the first term in (3.24). Recalling that $|t_x^{\varepsilon N} \cdot e_2| = \xi_x^{\varepsilon N} = 1 - |t_x^{\varepsilon N} \cdot e_1|$, we find:

$$\frac{1}{N} \sum_{x \in V(\gamma)} c_x(\gamma)(HG)(x) = \frac{1}{N} \sum_{x \in V(\gamma)} |t_x^{\varepsilon N} \cdot e_1| |t_x^{\varepsilon N} \cdot e_2| (HG)(x) + \text{error}. \quad (3.35)$$

Let us now turn to the B_k terms (3.30) and the B'_k terms (3.31). Lemma 3.8 applied to the sum in the second line of the B_k terms (3.30) yields:

$$\frac{1}{4N} \sum_{x \in V^\varepsilon(\gamma) \setminus P(\gamma)} \left[-|t_x^{\varepsilon N} \cdot e_2| \sigma_1 \partial_2 + |t_x^{\varepsilon N} \cdot e_1| \sigma_2 \partial_1 \right] G(x) + \text{error}. \quad (3.36)$$

Note that the sum in (3.36) was made to bear on $V^\varepsilon(\gamma)$ and not on $V(\gamma)$ as in (3.30). This simplifies the argument below, and is responsible for a $O_{G,H}(\varepsilon)$ error term.

Similarly, the sum in the B'_k terms (3.31) is transformed into:

$$\frac{1}{2N} \sum_{x \in V^\varepsilon(\gamma)} |t_x^{\varepsilon N} \cdot e_2| |t_x^{\varepsilon N} \cdot e_1| \left(-\sigma_2 \partial_1 + \sigma_1 \partial_2 \right) G(x) + \text{error}. \quad (3.37)$$

To conclude the proof of Lemma 3.7, it remains to prove that the contribution of (3.36) and (3.37) is, up to small errors in ε, N :

$$(3.36) + (3.37) = \frac{1}{4N} \sum_{x \in V^\varepsilon(\gamma)} [t \cdot m(x)] t \cdot \nabla G(x), \quad (3.38)$$

where the vector m is defined in Definition 3.6, and t is short for $t_x^{\varepsilon N}$; write also t_1, t_2 for $t_x^{\varepsilon N} \cdot e_1, t_x^{\varepsilon N} \cdot e_2$, $x \in V^\varepsilon(\gamma)$. To prove (3.38), write, not explicitly mentioning the error terms:

$$\begin{aligned} (3.36) + (3.37) &= \frac{1}{4N} \sum_{x \in V^\varepsilon(\gamma)} \left[(-|t_2| \sigma_1 + 2|t_1| |t_2| \sigma_1) \partial_2 + (|t_1| \sigma_2 - 2|t_1| |t_2| \sigma_2) \partial_1 \right] G(x) \\ &= \frac{1}{4N} \sum_{x \in V^\varepsilon(\gamma)} \left[\sigma_1 |t_2| (|t_1| - |t_2|) \partial_2 + \sigma_2 |t_1| (|t_1| - |t_2|) \partial_1 \right] G(x). \end{aligned} \quad (3.39)$$

To obtain the second line, we used that $|t_1| + |t_2| = 1$ by definition of t , see (3.4).

Recall from (3.28) the definition of (σ_1, σ_2) , and by the ensuing discussion and (3.29) the fact that $m = (\sigma_2, -\sigma_1)$, with m as in Definition 3.6. Recall moreover that $V^\varepsilon(\gamma) \subset V(\gamma)$ is the set of points at 1-distance more than ε to the poles to obtain:

$$\forall x \in V^\varepsilon(\gamma), \quad |t_1| = |t_x^{\varepsilon N} \cdot e_1| = \sigma_1 t_1, \quad |t_2| = \sigma_2 t_2.$$

This is because all points in $B_1(x, \varepsilon)$ are in the same quadrant for $x \in V^\varepsilon(\gamma)$, thus σ_1, σ_2 are constant on $B_1(x, \varepsilon)$. As a result, (3.39) becomes:

$$\begin{aligned}
(3.36) + (3.37) &= \frac{1}{4N} \sum_{x \in V^\varepsilon(\gamma)} \left[\sigma_1 \sigma_2 t_2 (\sigma_1 t_1 - \sigma_2 t_2) \partial_2 + \sigma_2 \sigma_1 t_1 (\sigma_1 t_1 - \sigma_2 t_2) \partial_1 \right] G(x) \\
&= \frac{1}{4N} \sum_{x \in V^\varepsilon(\gamma)} [\sigma_2 t_1 - \sigma_1 t_2] [t_1 \partial_1 + t_2 \partial_2] G(x) \\
&= \frac{1}{4N} \sum_{x \in V^\varepsilon(\gamma)} [t \cdot m(x)] t \cdot \nabla G(x).
\end{aligned} \tag{3.40}$$

Now properly integrating (3.24) in time and including all error terms in (3.30)-(3.31)-(3.35), one obtains the following expression of the Bulk term on \tilde{Z}_B (defined in (3.34)):

$$\begin{aligned}
\int_0^{T_0} [\text{Bulk term evaluated at } \gamma_\tau] d\tau &= O_{G,H}(\delta) + O_{G,H} \left(\int_0^{T_0} d\tau \sum_{k=1}^4 \frac{p_k(\tau)}{N} \right) \\
&+ \frac{1}{4N} \int_0^{T_0} d\tau \sum_{x \in V^\varepsilon(\gamma_\tau)} [t_x^{\varepsilon N} \cdot m(x)] t_x^{\varepsilon N} \cdot \nabla G(\tau, x) d\tau \\
&- \frac{1}{4} \int_0^{T_0} \sum_{k=1}^4 [G(\tau, L_k(\tau)) + G(\tau, R_k(\tau))] d\tau + \frac{1}{N} \int_0^{T_0} d\tau \sum_{x \in V(\gamma_\tau)} |t_x^{\varepsilon N} \cdot e_1| |t_x^{\varepsilon N} \cdot e_2| (GH)(\tau, x).
\end{aligned}$$

This is equation (3.20) in Lemma 3.7, up to the error term $\int_0^{T_0} \sum_k p_k/N$. We defined in (3.17) the set $B_p^N(2, \beta)$ in which it is of order N^{-1} , so that if the set Z_B in Lemma 3.7 is defined as:

$$Z_B := (\tilde{Z}_B)_{H,G}^N(\delta, \varepsilon) \cap B_p^N(2, \beta), \tag{3.41}$$

then, on this set, $\int_0^{T_0} p_k(t)/N = O(N^{-1})$, and Z_B satisfies

$$\limsup_{\varepsilon \rightarrow 0} \limsup_{N \rightarrow \infty} \frac{1}{N} \log \mathbb{P}_{r,\beta,H}^N(\forall \tau \in [0, T_0], \gamma_\tau \in \mathcal{E}_r; \gamma \notin Z_B) = -\infty.$$

This concludes the proof of Lemma 3.7. □

Let us summarise our results and conclude the proof of Proposition 3.1. We have shown the existence of two sets Z_P, Z_B of trajectories in (3.18)-(3.41), with $(Z_P)^c \cup (Z_B)^c \cap E([0, T], \mathcal{E}_r(d))$ having $\mathbb{P}_{r,\beta,H}^N$ -probability super-exponentially small. This yields the set Z in Proposition 3.1, setting:

$$Z = Z_{H,G}^N(A = 2, \beta, \delta, \varepsilon) = Z_P(2, \beta, \delta) \cap (Z_B)_{H,G}^N(2, \beta, \delta, \varepsilon). \tag{3.42}$$

In Section 3.2.1, all Pole terms (3.13)-(3.14) were computed, and shown to yield the $e^{-\beta}$ term contribution of the last line of (3.51). In Section 3.2.2, the other terms in (3.51) have been identified. Proposition 3.1 is thus proven. once one recalls the definitions (3.5) of $v^{\varepsilon N}, T^{\varepsilon N}$ and replaces $t^{\varepsilon N}$ by $v^{\varepsilon N} T^{\varepsilon N}$.

□
of Proposition 3.1.

Step 2: Replacement of the discrete sums by line integrals

In Proposition 3.1, discrete sums on all vertices of a contour in $N^{-1}X_r^N$ appear. In the large N limit for element of \mathcal{E}_r , the corresponding N -independent object should be some sort of line integral, thus depends on the contour. In comparison, in the exclusion process the domain on which configurations live is fixed. Correspondingly, only integrals on a fixed interval arise in the large N limit.

If $\gamma \in N^{-1}X_r^N \cap \mathcal{E}_r$ and s is the line abscissa on γ , for any continuous mapping $f : \gamma \rightarrow \mathbb{R}$:

$$\frac{1}{N} \sum_{x \in V(\gamma)} f(x) = \sum_{x \in V(\gamma)} f(x) [s(x + e_x^+/N) - s(x)] = \int_{\gamma} f ds. \quad (3.43)$$

In writing (3.43), information about the lattice structure was omitted, and the resulting functional on the right-hand side of (3.43) is not continuous on \mathcal{E}_r , not even if $f \equiv 1$. Indeed, take a sequence $\gamma_N \in N^{-1}X_r^N \cap \mathcal{E}_r$ converging to some $\gamma_{\infty} \in \mathcal{E}_r$. The left-hand side of (3.43) converges, for $f \equiv 1$, to the length of γ_{∞} in 1-norm, whereas the right-hand side evaluated at γ_{∞} is equal to the length in 2-norm, which is in general not the same.

The correct way to write the left-hand side of (3.43), that retains sufficient information on the lattice structure to yield a continuous functional on (a nice subset of) \mathcal{E}_r , is the following:

$$\frac{1}{N} \sum_{x \in V(\gamma)} f(x) = \frac{1}{N} \sum_{x \in V(\gamma)} f(x) \|T_x\|_1 = \int_{\gamma} f v^{-1} ds, \quad (3.44)$$

where T is the tangent vector normed by $\|T\| = 2$ and $v^{-1} = \|T\|_1$ is almost everywhere equal to 1 on $\gamma \in N^{-1}X_r^N \cap \mathcal{E}_r$, hence the equalities in (3.44). The proof of the continuity of the right-hand side of (3.44) in Hausdorff distance is not related to microscopic computations, so we postpone it to Proposition 4.1.

Let us however motivate the factor v^{-1} in (3.44), when e.g. v^{-2} would a priori also work. Take $\gamma^N \in N^{-1}X_r^N$ and $x \in V^{\varepsilon}(\gamma^N)$, i.e. x is at 1-distance at least ε from the poles. For definiteness take x in the first quadrant. By definition of X_r^N , see Figure 1, in the reference frame $\mathcal{R}_1 = (O, e_{-\pi/4}, e_{\pi/4})$, the curve $\gamma^N \cap B_1(x, \varepsilon)$ is the graph of a 1-Lipschitz function f^1 :

$$\gamma^N \cap B_1(x, \varepsilon) = \{(y, f^1(y))_{\mathcal{R}_1} : y \in u + [-\varepsilon/\sqrt{2}, \varepsilon/\sqrt{2}]\}, \quad u := x \cdot e_{-\pi/4}.$$

As a result, $t_x^{\varepsilon N}$ reads:

$$t_x^{\varepsilon N} = \frac{1}{\sqrt{2}\varepsilon} \int_{u-\varepsilon/\sqrt{2}}^{u+\varepsilon/\sqrt{2}} t(y) dy, \quad t(y) = \frac{\sqrt{2}}{2} (1, \partial_y f^1(y))_{\mathcal{R}_1} \quad (3.45)$$

where t is the tangent vector normed by $\|t\|_1 = 1$, defined almost everywhere for a Lipschitz curve. Since $\gamma^N \in N^{-1}X_r^N$, $\|t\|_2 = 1$ almost everywhere. Recall that, by definition:

$$t = vT, \quad \|t\|_1 = 1, \quad \|T\|_2 = 1, \quad v = \|t\|_2 = (\|T\|_1)^{-1}. \quad (3.46)$$

Expression (3.45) does not explicitly depend on N any more, thus can also be written for a curve $\gamma \in \mathcal{E}_r$. Define the set $\gamma(\varepsilon) \subset \gamma$ of points at 1-distance ε or more to the poles, and similarly write:

$$\forall k \in \{1, \dots, 4\}, \forall x \in \gamma(\varepsilon) \cap C_k(\gamma), \quad t^{\varepsilon}(x) = \frac{1}{\sqrt{2}\varepsilon} \int_{x \cdot e_{\pi/4 - k\pi/2 - \varepsilon/\sqrt{2}}}^{x \cdot e_{\pi/4 - k\pi/2 + \varepsilon/\sqrt{2}}} t(y) dy. \quad (3.47)$$

Recall that $C_k(\gamma)$ is quadrant k of γ , defined in Figure 1 or in Appendix B. The vector $t^\varepsilon(x)$ indeed satisfies $\|t^\varepsilon(x)\|_1 = 1$, and coincides with $t_x^{\varepsilon N}$ if $\gamma \in N^{-1}X_r^N$ and $x \in V(\gamma)$. Let us now change variables to obtain a line integral in (3.47). To do so, define $d_\varepsilon^\pm(\cdot) \geq 0$ as the functions of the line abscissa on γ that satisfy:

$$\forall s \leq |\gamma|_2, \quad \|\gamma(s \pm d_\varepsilon^\pm(s)) - \gamma(s)\|_1 = \varepsilon. \quad (3.48)$$

The quantity $|\gamma|_2$ is the usual Euclidean length of γ . Recall the notations $(x^k, f^k)_{\mathcal{R}_k}$ of Section 2.2 to write the portion in quadrant k of γ as the graph of the function f^k in the reference frame \mathcal{R}_k , $k \in \{1, \dots, 4\}$. With $x^k = x \cdot e_{\pi/4 - k\pi/2}$ if $x \in C_k(\gamma)$ and $dx^k = [1 + (\partial_{x^k} f^k)^2]^{-1/2} d\sigma$, (3.47) becomes, if $s(x)$ denotes the value of the line abscissa associated with x and $d\sigma$ is an integration with respect to line abscissa, and d_ε^\pm is short for $d_\varepsilon^\pm(s(x))$:

$$\forall k \in \{1, \dots, 4\}, \forall x \in \gamma(\varepsilon) \cap C_k(\gamma), \quad t^\varepsilon(x) = \frac{1}{\sqrt{2\varepsilon}} \int_{s(x)-d_\varepsilon^-}^{s(x)+d_\varepsilon^+} \frac{t(\sigma) d\sigma}{\sqrt{1 + (\partial_{x^k} f^k)^2}} = \frac{1}{2\varepsilon} \int_{s(x)-d_\varepsilon^-}^{s(x)+d_\varepsilon^+} T(\sigma) d\sigma, \quad (3.49)$$

where we used $t = vT$ which implies $\|t\|_2 = v$. In other words, the factor v^{-1} in (3.44) is exactly what is needed to pass from the parametrisation by 1-Lipschitz curves on each quadrants, inherited from the lattice structure, to a line integral formulation. Define now T^ε and v^ε from t^ε :

$$\forall s \leq |\gamma|_2, \quad T^\varepsilon(s) := t^\varepsilon(s) / \|t^\varepsilon(s)\|_2, \quad v^\varepsilon(s) := \|t^\varepsilon(s)\|_2 = \frac{1}{\|T^\varepsilon(s)\|_1}. \quad (3.50)$$

Using (3.49)-(3.50), it is straightforward to transform Proposition 3.1 into the following.

Proposition 3.9. *With the notations and the set Z defined in Proposition 3.1, trajectories in Z satisfy:*

$$\begin{aligned} \int_0^{T_0} N^2 \mathcal{L}_{r,\beta,H} \langle \Gamma_\tau, G_\tau \rangle d\tau &= \frac{1}{4} \int_0^{T_0} d\tau \int_{\gamma_\tau(\varepsilon)} \frac{(v^\varepsilon)^2}{v} [T^\varepsilon \cdot m(\gamma_\tau(s_\tau))] T^\varepsilon \cdot \nabla G(\tau, \gamma(s_\tau)) ds_\tau \\ &+ \frac{1}{2} \int_0^{T_0} d\tau \int_{\gamma_\tau(\varepsilon)} \frac{(v^\varepsilon)^2}{v} |T_1^\varepsilon| |T_2^\varepsilon| (HG)(\tau, \gamma_\tau(s_\tau)) ds_\tau + C(G, H)(\delta + o_N(1)) \\ &- \frac{1}{2} \int_0^{T_0} \sum_{k=1}^4 (1/2 - e^{-\beta}) [G(\tau, L_k(\Gamma_\tau)) + G(\tau, R_k(\Gamma_\tau))] d\tau, \end{aligned} \quad (3.51)$$

where s_τ is the line abscissa on γ_τ , $\gamma_\tau(\varepsilon)$ is the set of points in γ_τ at 1-distance at least ε from the poles and $m = (\pm 1, \pm 1)$ is the sign vector in Definition 3.6. The $T_i^\varepsilon, i \in \{1, 2\}$ stand for the components of T^ε defined in (3.50). Note that both v and v^ε appear in (3.51). There is a $v^\varepsilon T^\varepsilon$ for each t^ε in Lemma 3.7, while the v comes from the change of variable (3.44) to get a line integral from discrete sums.

Remark 3.10. • Note that the line integral on the second line of (3.51) bears on $\gamma_\tau(\varepsilon)$, whereas the corresponding sum in Proposition 3.1 bore on the whole of $V(\gamma_\tau)$. This change is purely for convenience and induces an error $O_{G,H}(\varepsilon) = C(G, H)o_\delta(1)$ independent of the curve.

- To connect (3.51) to the weak formulation (2.30) of anisotropic motion by curvature with drift, notice from (3.47) that $\lim_{\varepsilon \rightarrow 0} t^\varepsilon(x)$ converges to $t(x)$ for almost every point of a curve that is at 1-distance ε or more to the poles. As a result, $T^\varepsilon, v^\varepsilon$, defined in (3.50), converge a.e. to T, v on such portions of a curve, and:

$$\lim_{\varepsilon \rightarrow 0} \left[\frac{(v^\varepsilon)^2}{v} |T_1^\varepsilon T_2^\varepsilon| \right] (\theta) = (v |T_1 T_2|) (\theta) = \frac{\sin(2\theta)}{2(|\sin(\theta)| + |\cos(\theta)|)} \quad \text{for } \theta \in [0, 2\pi].$$

This quantity is precisely $\mu(\theta)$, see (2.26). In the same way, if $\theta \in [0, 2\pi] \setminus \frac{\pi}{2}\mathbb{Z}$:

$$\lim_{\varepsilon \rightarrow 0} \left[\frac{(v^\varepsilon)^2}{v} [T^\varepsilon \cdot m] \right] (\theta) T^\varepsilon(\theta) \cdot \nabla = [v[T \cdot m]] (\theta) T(\theta) \cdot \nabla = \alpha(\theta) \partial_s,$$

where α is defined in (2.31) and $\partial_s = \partial_T$ is the derivative with respect to line abscissa, almost everywhere well defined.

- In (3.51), the tangent vector at each point is averaged on a portion of 1-length ε of the curve. Away from the poles, this is a natural choice, well adapted to the underlying SSEP structure, see Section 2.2.

At the poles however, this requires the knowledge of the position of the pole, that is the position of a *point* whereas the droplets are *volumic* objects. Even more, the line integrals bear on $\gamma_\tau(\varepsilon)$, $\tau \in [0, T_0]$, the set of points at 1-distance ε from the poles of γ_τ , and the last line of (3.51) explicitly requires the knowledge of the $L_k, R_k, k \in \{1, \dots, 4\}$. If the droplet boundaries were less regular, such a requirement would not be reasonable.

Instead, as in the BV setting (see e.g. [EG15]), it would make sense to define a weaker notion of neighbourhood of the pole in terms of volume, replacing e.g. L_k, R_k by an average over all points of the droplet in an area of volume ε around pole $k \in \{1, \dots, 4\}$. This definition would then be relevant even with less regular droplets, and we use it in Section 4 to control the poles.

However, the formulation of Proposition 3.9 for $N^2 \mathcal{L}_{r,\beta,H} \langle \Gamma, G \rangle$ is useful for the following reason. When integrating by parts the α term in (2.30) assuming the corresponding curves to be smooth, the position of the pole actually arises as a boundary term. This fact is retained in our microscopic computations, where the L_k, R_k terms naturally come out. \blacksquare

4 Large deviation upper-bound and properties of the rate functions

In this section, we prove upper bound large deviations, i.e. the upper bound in Theorem 2.6. Many results presented below are well-known, so we only detail model-specific results. A time $T_0 > 0$ is fixed throughout the section. Parameters r, β are fixed according to Definition 2.1. The parameter r is omitted in the notations.

For $H \in \mathcal{C}$, the Radon-Nikodym derivative $D_{\beta,H}^N = d\mathbb{P}_{\beta,H}^N / d\mathbb{P}_\beta^N$ until time T_0 reads:

$$N^{-1} \log D_{\beta,H}^N((\Gamma_\tau)_{\tau \leq T_0}) = \langle \Gamma_{T_0}, H_{T_0} \rangle - \langle \Gamma_0, H_0 \rangle - \int_0^{T_0} e^{-N \langle \Gamma_\tau, H_\tau \rangle} (\partial_\tau + N^2 \mathcal{L}_\beta) e^{N \langle \Gamma_\tau, H_\tau \rangle} d\tau. \quad (4.1)$$

Recall from (3.42) the definition of $Z_{H,H}^N(A = 2, \beta, \delta, \varepsilon) =: Z$, the set of trajectories in which the computations of Section 3 can be performed, and from Definition 3.6 that of m . Refer to Appendix B.2 for properties of $E([0, T_0], \mathcal{E}_r(d))$, $d \in (0, 1)$. For a trajectory $(\Gamma_\tau)_{\tau \in [0, T_0]}$ in $Z \cap E([0, T_0], \mathcal{E}_r(d))$, the results of Proposition 3.9 apply with next to no change to (4.1), so that on Z , $D_{\beta,H}^N$ satisfies:

$$N^{-1} \log D_{\beta,H}^N(\Gamma) = J_{H,\varepsilon}^\beta(\Gamma) + C(H)(o_\delta(1) + o_N(1)), \quad (4.2)$$

where $J_{H,\varepsilon}^\beta$ is the functional defined on $E([0, T_0], \mathcal{E}_r)$ by $(\gamma_\tau = \partial \Gamma_\tau, \tau \in [0, T_0])$:

$$\forall \Gamma \in E([0, T_0], \mathcal{E}_r), \quad J_{H,\varepsilon}^\beta(\Gamma) = \ell_{H,\varepsilon}^\beta(\Gamma) - \frac{1}{2} \int_0^{T_0} \int_{\gamma_\tau(\varepsilon)} |T_1^\varepsilon T_2^\varepsilon| \frac{(v^\varepsilon)^2}{v} H^2(\tau, \gamma_\tau(s_\tau)) ds_\tau d\tau. \quad (4.3)$$

The functional $\ell_{H,\varepsilon}^\beta$ is defined as:

$$\begin{aligned} \forall \Gamma \in E([0, T_0], \mathcal{E}_r), \quad \ell_{H,\varepsilon}^\beta(\Gamma) &= \langle \Gamma_{T_0}, H_{T_0} \rangle - \langle \Gamma_0, H_0 \rangle - \int_0^{T_0} \langle \Gamma_\tau, \partial_\tau H_\tau \rangle d\tau \\ &\quad - \frac{1}{4} \int_0^{T_0} d\tau \int_{\gamma_\tau(\varepsilon)} \frac{(v^\varepsilon)^2}{v} [T^\varepsilon \cdot m(\gamma_\tau(s_\tau))] T^\varepsilon \cdot \nabla H(\tau, \gamma(s_\tau)) ds_\tau \\ &\quad + \left(\frac{1}{4} - \frac{e^{-\beta}}{2} \right) \int_0^{T_0} \sum_{k=1}^4 [H(\tau, L_k(\tau)) + H(\tau, R_k(\tau))] d\tau. \end{aligned} \quad (4.4)$$

Recall that, for $\tau \in [0, T_0]$, $\gamma_\tau(\varepsilon)$ is the set of points in γ_τ at 1-distance at least ε from the poles.

Formally taking the limit $\varepsilon \downarrow 0$, we claim that $J_{H,\varepsilon}^\beta, \ell_{H,\varepsilon}^\beta$ converge point-wise to J_H^β, ℓ_H^β respectively, defined in (2.33)-(2.32). Furthermore, the functionals $J_{H,\varepsilon}^\beta, \ell_{H,\varepsilon}^\beta$ are continuous on $E_{pp}([0, T_0], \mathcal{E}_r)$, the subset of $E([0, T_0], \mathcal{E}_r)$ with trajectories with almost always point-like poles. These claims, assumed for the moment, are established in Section 4.2.

4.1 Upper bound for open and compact sets

Fix $d, T_0 > 0$. In this section, we establish the upper-bounds in Theorem 2.6 for open and compact sets in $(E([0, T_0], \mathcal{E}_r(d)), d_E)$ (see Appendix B.2), with d_E the distance defined in (B.4). To do so, we admit the continuity of the functionals $(J_{H,\varepsilon}^\beta)_\varepsilon$ and their point-wise convergence to J_H^β on $E_{pp}([0, T_0], \mathcal{E}_r(d))$ (defined in (2.34)). This convergence is established in Section 4.2.

Let us start by listing the several sets with sub-exponential probability on which the dynamics will be restricted to obtain the upper bound of Theorem 2.6. Let $\mathcal{O} \subset E([0, T_0], \mathcal{E}_r(d))$ be an open set of trajectories. Recall that $\mathcal{E}_r(d)$ is the set of droplets at distance at least $d > 0$ from $\partial([-1, 1])^2$. Recall also from (3.42) the definition of the set Z , on which the pole size is microscopic and the Replacement lemma 3.8 holds, and define:

$$U^N = U^N(H, A = 2, \beta, \delta, \varepsilon) := \frac{1}{N} \log \mathbb{E}_{\beta, H}^N [(D_{\beta, H}^N)^{-1} \mathbf{1}_{\mathcal{O}} \mathbf{1}_{Z^c}] = \frac{1}{N} \log \mathbb{E}_\beta^N [\mathbf{1}_{\mathcal{O}} \mathbf{1}_{Z^c}]. \quad (4.5)$$

We argue in the proof of the Replacement lemma in Appendix A that, for any $\delta, d > 0$,

$$\inf_{\varepsilon > 0} \limsup_{N \rightarrow \infty} U^N = -\infty. \quad (4.6)$$

Let us now turn to the behaviour of the poles. It is proven in Section 6.2.4 that the time integrated slope around the pole is $e^{-\beta}$ up to a small error, with probability super-exponentially close to 1 (see Corollary 6.11). This is better stated in terms of volume below the pole (see the last item of Remark 3.10): for $\eta > 0$, define V_η as the volume of points with ordinate at most η below the north pole:

$$\forall \Gamma \in \mathcal{E}_r, \quad V_\eta(\Gamma) = |\{x \in \Gamma : y_{\max}(\Gamma) - x \cdot e_2 \geq \eta\}|. \quad (4.7)$$

Compared to the slope, the volume V_η is more robust to changes in the position of the pole: V_η is continuous on \mathcal{E}_r equipped with the Hausdorff distance d_H , since y_{\max} , the ordinate of the highest point of an element of \mathcal{E}_r , also is (and similarly for the volumes beneath the other three poles).

By Lemma B.14, for each $q, n \in \mathbb{N}^*$, there is $\eta(q, n) > 0$ such that, for any $\eta \leq \eta(q, n)$:

$$\limsup_{N \rightarrow \infty} \frac{1}{N} \log \mathbb{P}_{r, \beta, H}^N \left(\forall t \in [0, T_0], \Gamma_t \in \mathcal{E}_r(d); \frac{1}{T_0} \left| \int_0^{T_0} [V_\eta(\Gamma_t) - \eta^2(e^\beta - 1)] dt \right| > \frac{1}{n} \right) \leq -q. \quad (4.8)$$

Define thus the set $D_{q,n}$ where the portion below the pole is roughly triangular at all distances $k\eta(q, m)/m$ of the pole for each $1 \leq m \leq n, 1 \leq k \leq m$ and has volume controlled in terms of β :

$$D_{q,n} := \left\{ \forall m \in \{1, \dots, n\}, \forall k \in \{1, \dots, m\}, \frac{1}{T_0} \left| \int_0^{T_0} \left[V_{(k/m)\eta(q,m)}(\Gamma_t) - \left(\frac{k\eta(q, m)}{m} \right)^2 (e^\beta - 1) \right] dt \right| \leq \frac{1}{m} \right\} \\ \cap \{\text{similar event for the other three poles}\} \cap E([0, T_0], \mathcal{E}_r(d)). \quad (4.9)$$

Since V_η is continuous on \mathcal{E}_r , the set $D_{q,n}$ is closed in $E([0, T_0], \mathcal{E}_r(d))$. Moreover, by construction $D_{q,n} \subset D_{q,n'}$ if $n \leq n'$, and for each $q \geq 1$, the set D_q contains only trajectories in $E_{pp}([0, T_0], \mathcal{E}_r(d))$, where:

$$D_q := \bigcap_{n \geq 1} D_{q,n}. \quad (4.10)$$

Indeed, poles of trajectories in D_p are almost always point-like because the time averaged volume $T_0^{-1} \int_0^{T_0} V_\eta(t) dt$ beneath a pole must be of order η^2 for $\eta > 0$ by (4.9). Moreover, by (4.8):

$$\limsup_{N \rightarrow \infty} P_{q,n}^N := \limsup_{N \rightarrow \infty} \frac{1}{N} \log \mathbb{P}_{\beta, H}^N (D_{q,n}^c \cap E([0, T_0], \mathcal{E}_r(d))) \leq -q.$$

We are now equipped to obtain the upper bound large deviations. Recalling (4.2), one has:

$$N^{-1} \log Q_\beta^N(\mathcal{O}) \leq \max \left\{ N^{-1} \log \mathbb{E}_{\beta, H}^N [(D_{\beta, H}^N)^{-1} \mathbf{1}_{\mathcal{O}} \mathbf{1}_{Z \mathbf{1}_{D_{q,n}}}], U^N, P_{q,n}^N \right\} \\ \leq \max \left\{ C(H) o_\delta(1) + o_N(1) + \sup_{\Gamma \in \mathcal{O} \cap D_{q,n}} (-J_{H, \varepsilon}^\beta(\Gamma)), U^N, P_{q,n}^N \right\}.$$

Take first the limit in N :

$$\limsup_{N \rightarrow \infty} N^{-1} \log Q_\beta^N(\mathcal{O}) \leq \max \left\{ C(H) o_\delta(1) + \limsup_{N \rightarrow \infty} \sup_{\Gamma \in \mathcal{O} \cap D_{q,n}} (-J_{H, \varepsilon}^\beta(\Gamma)), \limsup_{N \rightarrow \infty} U^N, -q \right\}.$$

Minimising in n , since $(D_{q,n})_n$ is decreasing, it is not difficult to see that any trajectory not in D_q , defined in (4.10), is excluded from the supremum. This yields the following upper bound for open sets:

$$\limsup_{N \rightarrow \infty} N^{-1} \log Q_\beta^N(\mathcal{O}) \leq \max \left\{ C_H o_\delta(1) + \sup_{\Gamma \in \mathcal{O} \cap D_q} (-J_{H, \varepsilon}^\beta(\Gamma)), \limsup_{N \rightarrow \infty} U^N, -q \right\}.$$

Minimise over δ, ε , then over $H \in \mathcal{C}$ and $q \geq 1$ to find, using (4.6):

$$\limsup_{N \rightarrow \infty} N^{-1} \log Q_\beta^N(\mathcal{O}) \leq \inf_{q \geq 1} \inf_{H \in \mathcal{C}} \inf_{\delta, \varepsilon} \left\{ \sup_{\Gamma \in \mathcal{O} \cap D_q} (-J_{H, \varepsilon}^\beta(\Gamma)) + C(H) o_\delta(1) \right\}. \quad (4.11)$$

Upper bound for compact sets:

The point of restricting the supremum to trajectories in $D_q \subset E_p([0, T_0], \mathcal{E}_r(d))$ is that $J_{H, \varepsilon}^\beta$ is continuous on this set for each $H \in \mathcal{C}, \varepsilon > 0$, as proven in Proposition 4.1. We use this to first obtain a nicer bound on compact sets.

Let \mathcal{K} be a compact set in $E([0, T_0], \mathcal{E}_r(d))$. The error term $C(H) o_\delta(1)$ is independent of the trajectory, thus also continuous on D_q . Lemmas A.2.3.2 and A.2.3.3 in [KL99] thus apply to the continuous family $(-J_{H, \varepsilon}^\beta + C(H) o_\delta(1))_{H, \varepsilon, \delta}$ on the compact set $\mathcal{K} \cap D_q$ (D_q is closed) and we obtain:

$$\limsup_{N \rightarrow \infty} N^{-1} \log Q_\beta^N(\mathcal{K}) \leq \inf_{q \geq 1} \sup_{\Gamma \in \mathcal{K} \cap D_q} \inf_{H \in \mathcal{C}} \inf_{\varepsilon} (-J_{H, \varepsilon}^\beta(\Gamma)). \quad (4.12)$$

For each fixed $H \in \mathcal{C}$ and each $\Gamma \in D_p$, by Proposition 4.1,

$$-J_{H,\varepsilon}^\beta(\Gamma) = -J_H^\beta(\Gamma) + C(\Gamma, H)o_\varepsilon(1) \quad \text{where} \quad C(\Gamma, H)o_\varepsilon(1) \quad \text{can be taken positive.}$$

Equation (4.12) thus becomes:

$$\limsup_{N \rightarrow \infty} N^{-1} \log Q_\beta^N(\mathcal{K}) \leq \inf_{q \geq 1} \sup_{\Gamma \in \mathcal{K} \cap D_q} \inf_{H \in \mathcal{C}} (-J_H^\beta(\Gamma)) \leq -\inf_{\mathcal{K}} I_\beta(\cdot | \Gamma_0), \quad (4.13)$$

The last bound comes from the fact that $D_q \subset E_{pp}([0, T_0], \mathcal{E}_r(d))$ for each q . By definition of $I_\beta(\cdot | \Gamma_0)$ (see (2.35)), this is the desired upper bound for compact sets.

Upper bound for closed sets:

Upper bound large deviations follow from the exponential tightness of $(Q_{r,\beta}^N(\cdot, E([0, T_0], \mathcal{E}_r(d))))_N$ in $\mathcal{M}_1(E([0, T_0], \mathcal{E}_r(d)))$. Establishing tightness is quite technical, so we postpone it to Appendix B.3 and conclude here the proof of the upper bound in Theorem (2.6).

4.2 Properties of the rate function

In this section, continuity of the functional $J_{H,\varepsilon}^\beta$ is established on the set $E_{pp}([0, T_0], \mathcal{E}_r(d))$ of trajectories with almost always point-like poles (see (2.34)). A parameter $d > 0$ is fixed throughout the section. The functional $J_{H,\varepsilon}^\beta$ is defined in (4.3)-(4.4).

Proposition 4.1. *Let $H \in \mathcal{C}$ and $\varepsilon > 0$. The functional $J_{H,\varepsilon}^\beta$, defined in (4.3), is continuous on the set $E_{pp}([0, T_0], \mathcal{E}_r(d))$ of trajectories with almost always point-like poles, equipped with the distance d_E (see (2.29)). Moreover,*

$$\lim_{\varepsilon \rightarrow 0} J_{H,\varepsilon}^\beta(\Gamma) = J_H^\beta(\Gamma) \quad \text{pointwise on } E_{pp}([0, T_0], \mathcal{E}_r(d)). \quad (4.14)$$

The same holds for $J_{H,\varepsilon}$.

Before proving Proposition 4.1, let us state an intermediate result which explains the advantage of dealing with trajectories in $E_{pp}([0, T_0], \mathcal{E}_r(d))$ rather than in $E([0, T_0], \mathcal{E}_r(d))$.

Lemma 4.2 (Convergence of the poles). *For $n \in \mathbb{N}$, let $(\Gamma^n \in E([0, T_0], \mathcal{E}_r(d)))$ and assume that (Γ^n) converges to $\Gamma \in E_{pp}([0, T_0], \mathcal{E}_r(d))$ for the distance $\int_0^{T_0} d_H(\cdot, \cdot) dt \leq d_E$. Then $L_k(\Gamma_t^n) = R_k(\Gamma_t)$ for each $k \in \{1, \dots, 4\}$ and almost every time since Γ has almost always point-like poles, and:*

$$\forall k \in \{1, \dots, 4\}, \quad \lim_{n \rightarrow \infty} \int_0^{T_0} dt \|L_k(\Gamma_t^n) - L_k(\Gamma_t)\|_1 \vee \|R_k(\Gamma_t^n) - R_k(\Gamma_t)\|_1 dt = 0. \quad (4.15)$$

Proof. We deal with the north pole, the others are the same. For $\tilde{\Gamma} \in \mathcal{E}_r$, let $y_{\max}(\tilde{\Gamma})$ be the ordinate of its north pole. Notice that y_{\max} is 1-Lipschitz in Hausdorff distance. Since $L_1 \cdot e_2 = R_1 \cdot e_2 = y_{\max}$, we find:

$$\begin{aligned} & \int_0^{T_0} dt |L_1(\Gamma_t^n) \cdot e_2 - y_{\max}(\Gamma_t)| \vee |R_1(\Gamma_t^n) \cdot e_2 - y_{\max}(\Gamma_t)| dt \\ &= \int_0^{T_0} dt |y_{\max}(\Gamma_t^n) - y_{\max}(\Gamma_t)| dt \leq \int_0^{T_0} d_H(\Gamma_t^n, \Gamma_t) dt \xrightarrow{n \rightarrow \infty} 0. \end{aligned}$$

As for the second component of $L_1(\Gamma^n), R_1(\Gamma^n)$, the two functionals $R_1 \cdot e_1$ and $L_1 \cdot e_1$ are respectively upper and lower semi-continuous on \mathcal{E}_r . In particular, if for some $t \in [0, T_0]$ the droplet Γ_t has point-like poles and $d_H(\Gamma_t^n, \Gamma_t)$ vanishes, then:

$$L_1(\Gamma_t) \cdot e_1 \leq \liminf_{n \rightarrow \infty} L_1(\Gamma_t^n) \cdot e_1 \leq \limsup_{n \rightarrow \infty} R_1(\Gamma_t^n) \cdot e_1 \leq R_1(\Gamma_t) \cdot e_1 = L_1(\Gamma_t) \cdot e_1,$$

whence:

$$\lim_{n \rightarrow \infty} \int_0^{T_0} |L_1(\Gamma_\tau^n) \cdot e_1 - L_1(\Gamma_\tau) \cdot e_1| \vee |R_1(\Gamma_\tau^n) \cdot e_1 - R_1(\Gamma_\tau) \cdot e_1| d\tau = 0.$$

□

Proof of Proposition 4.1. In view of the expression (4.3)-(4.4) of $J_{H,\varepsilon}^\beta$, we need to study the continuity on $E_{pp}([0, T_0], \mathcal{E}_r(d))$ of the two terms

$$\left(\frac{1}{4} - \frac{e^{-\beta}}{2}\right) \sum_{k=1}^4 \int_0^{T_0} [H(\tau, R_k(\tau)) + H(\tau, L_k(\tau))] d\tau, \quad (4.16)$$

$$- \int_0^{T_0} \int_{\gamma_\tau(\varepsilon)} \frac{(v^\varepsilon)^2}{4v} [T^\varepsilon \cdot m] T^\varepsilon \cdot \nabla H ds_\tau d\tau - \frac{1}{2} \int_0^{T_0} \int_{\gamma_\tau(\varepsilon)} \frac{(v^\varepsilon)^2}{v} |T_1^\varepsilon T_2^\varepsilon| H^2 ds_\tau d\tau. \quad (4.17)$$

The functional in (4.16) has already been treated in Lemma 4.2: any trajectory in $E_{pp}([0, T_0], \mathcal{E}_r(d))$ is one of its points of continuity for $\int_0^{T_0} d_H dt \leq d_E$, hence for d_E .

Consider now (4.17). Clearly, to prove that Γ is a point of continuity of this functional, it is enough to prove that the integrand at each fixed time in (4.17), seen as a functional on (\mathcal{E}_r, d_H) , is continuous on the set $\mathcal{E}_r^{pp} \subset \mathcal{E}_r$ of droplets with point-like poles.

We prove it for the first term in (4.17), the second one is similar. For $H \in C^2([-1, 1]^2)$, consider the functional:

$$\forall \Gamma \in \mathcal{E}_r, \quad F_{H,\varepsilon}(\Gamma) = \int_{\gamma(\varepsilon)} \frac{(v^\varepsilon)^2}{4v} [T^\varepsilon \cdot m] T^\varepsilon \cdot \nabla H ds. \quad (4.18)$$

The definition of $T^\varepsilon, v^\varepsilon$ is given in (3.50), $v = \|T\|_1^{-1}$ with T the tangent vector normed by $\|T\|_2 = 1$, and m is the sign vector in Definition 3.6.

Let $\Gamma^n \in \mathcal{E}_r$, $n \in \mathbb{N}$ converge in Hausdorff distance to $\Gamma \in \mathcal{E}_r^{pp}$. The idea is to split the integral in (4.18) between each quadrant of Γ . On each quadrant, the integrand, expressed in terms of the equivalent SSEP, is easily shown to be continuous.

Let us first prove that we can consider the integrand on each quadrant of Γ separately. Recall from Section 2.2 the definition of the functions $f^k : I^k \rightarrow \mathbb{R}$, whose graph at each time in the reference frame \mathcal{R}_k , defined in (2.16), is the portion of γ in its quadrant k . Define similarly f_n^k for the $\gamma^n = \partial\Gamma^n$, $n \in \mathbb{N}$. For brevity, we write $T^{n,\varepsilon} = T^\varepsilon(\Gamma^n)$ and similarly $v^{n,\varepsilon}, m^n$ for $v^\varepsilon(\Gamma^n), m(\Gamma^n)$. Let $I_n^k = [a_n^k, b_n^k]$, $I^k = [a^k, b^k]$ be the intervals of definition of the functions $f_n^k(\cdot), f^k(\cdot)$ respectively, for $k \in \{1, \dots, 4\}$. As $\Gamma \in \mathcal{E}_r^{pp}$, $(L_k(\Gamma^n), (R_k(\Gamma^n)))$ converge to $L_k(\Gamma)$ as n is large by (the proof of) Lemma 4.2. As a result, $\lim_n \gamma_n(\varepsilon) = \gamma(\varepsilon)$ in Hausdorff distance, and:

$$\forall k \in \{1, \dots, 4\}, \quad \lim_{n \rightarrow \infty} a_n^k = a^k, \quad \lim_{n \rightarrow \infty} b_n^k = b^k. \quad (4.19)$$

Equation (4.19) enables us to consider the integrand in (4.18) on each quadrant of Γ separately. Indeed, fix $\eta \in (0, \varepsilon/\sqrt{2})$. For all n large enough and each k , (4.19) tells us that f_n^k is well defined on $[a^k + \eta, b^k - \eta]$, and in particular in the portion of $\gamma(\varepsilon)$ in quadrant k of Γ , i.e. for $x^k \in [a^k + \varepsilon/\sqrt{2}, b^k - \varepsilon/\sqrt{2}]$. As a result, $F_{H,\varepsilon}$ can be recast as follows: for each $\tilde{\Gamma} \in \mathcal{E}_r$,

$$F_{H,\varepsilon}(\tilde{\Gamma}) = \sum_{k=1}^4 \int_{\tilde{a}^k + \varepsilon/\sqrt{2}}^{\tilde{b}^k + \varepsilon/\sqrt{2}} \frac{(v^\varepsilon(x^k))^2}{2\sqrt{2}} [T^\varepsilon(x^k) \cdot m(x^k)] T^\varepsilon(x^k) \cdot \nabla H(\tau, (x^k, \tilde{f}^k(x^k)))_{\mathcal{R}_k} dx^k. \quad (4.20)$$

To write (4.21), we used the relation:

$$ds(x^k) = (1 + (\partial_{x^k} \tilde{f}^k)^2)^{1/2} dx^k = \sqrt{2v} dx^k,$$

where the last equality comes from Section 2.2, see (2.24). As a consequence of (4.20), continuity of $F_{H,\varepsilon}$ is proven as soon as, for each $k \in \{1, \dots, 4\}$:

$$\begin{aligned} \lim_{n \rightarrow \infty} \int_{a^k + \varepsilon/\sqrt{2}}^{b^k - \varepsilon/\sqrt{2}} \frac{(v^{n,\varepsilon}(x^k))^2}{2\sqrt{2}} [T^{n,\varepsilon}(x^k) \cdot m^n(x^k)] T^{n,\varepsilon}(x^k) \cdot \nabla H(\tau, (x^k, f_n^k(x^k)))_{\mathcal{R}_k} dx^k \\ = \int_{a^k + \varepsilon/\sqrt{2}}^{b^k - \varepsilon/\sqrt{2}} \frac{(v^\varepsilon(x^k))^2}{2\sqrt{2}} [T^\varepsilon(x^k) \cdot m(x^k)] T^\varepsilon(x^k) \cdot \nabla H(\tau, (x^k, f^k(x^k)))_{\mathcal{R}_k} dx^k. \end{aligned} \quad (4.21)$$

Note the replacement of a_n^k, b_n^k by a^k, b^k in the first line of (4.21), thanks to (4.19) and the fact that the integrand in (4.21) is bounded.

Fix $k \in \{1, \dots, 4\}$. On quadrant k , the integral in (4.21) has a much simpler expression in terms of the tangent vector $t^{n,\varepsilon}$ with 1-norm equal to 1, defined in (3.47). Indeed, recall from (3.50) that, for each $x^k \in I^k$,

$$v^{n,\varepsilon}(x^k) T^{n,\varepsilon}(x^k) = t^{n,\varepsilon}(x^k) = \left(\frac{\sqrt{2}}{2}, \frac{f_n^k(x^k + \varepsilon/\sqrt{2}) - f_n^k(x^k - \varepsilon/\sqrt{2})}{2\varepsilon/\sqrt{2}} \right) =: \frac{\sqrt{2}}{2} (1, \Delta_\varepsilon f_n^k(x^k))_{\mathcal{R}_k}. \quad (4.22)$$

Moreover, the function m , defined in Definition 3.6 is equal to a sign vector, determined only by the index of the quadrant. As a result, for n large enough, $m^n = m$ for each $x^k \in [a^k + \varepsilon/\sqrt{2}, b^k - \varepsilon/\sqrt{2}]$, $k \in \{1, \dots, 4\}$, and $v^{n,\varepsilon}[T^{n,\varepsilon} \cdot m^n](\theta^k)$ reads:

$$v^{n,\varepsilon}[T^{n,\varepsilon} \cdot m^n](\theta^k) = t^{n,\varepsilon}(x^k) \cdot m(x^k) = -\frac{f_n^k(x^k + \varepsilon/\sqrt{2}) - f_n^k(x^k - \varepsilon/\sqrt{2})}{2\varepsilon} = -\Delta_\varepsilon f_n^k(x^k).$$

The integral in (4.21) then becomes, for n large enough and with $\partial_{y^k} = \partial_{e_{\pi/4 - (k-1)\pi/2}}$ the partial derivative with respect to the second basis vector in \mathcal{R}_k :

$$-\frac{1}{4} \int_{a^k + \varepsilon/\sqrt{2}}^{b^k - \varepsilon/\sqrt{2}} \Delta_\varepsilon f_n^k(x^k) [\partial_{x^k} + \Delta_\varepsilon f_n^k(x^k) \partial_{y^k}] H((x^k, f_n^k(x^k)))_{\mathcal{R}_k} dx^k. \quad (4.23)$$

Observe that $x^k \mapsto \partial_{y^k} H((x^k, f_n^k(x^k)))$ is continuous, and that $\Delta_\varepsilon f_n^k(x^k)$ converges point-wise to $\Delta_\varepsilon f^k(x^k)$, defined as in (4.22). As the integrand in (4.23) is bounded, the dominated convergence theorem yields (4.21), hence the Hausdorff continuity of $F_{H,\varepsilon}$ and the d_E -continuity of the first term in (4.17). The second term in (4.18) is treated similarly.

We now turn to the point-wise convergence of $J_{H,\varepsilon}^\beta$ to J_H^β as $\varepsilon \downarrow 0$, i.e. the proof of (4.14). The fact that $T^\varepsilon \rightarrow T$ for almost every point of a curve and the dominated convergence theorem immediately give the result. This concludes the proof of Proposition 4.1. \square

5 Lower bound large deviations and hydrodynamic limits

In this section, we prove lower bound large deviations for the measures $\{Q_{r,\beta}^N : N \in \mathbb{N}^*\}$, i.e. the lower bound in Theorem 2.6. The method is expounded in [KL99]. It consists in first proving hydrodynamic limits for all the $\{Q_{r,\beta,H}^N : N \in \mathbb{N}^*\}$, $H \in \mathcal{C}$, which are shown to concentrate on solutions to anisotropic motion by curvature with drift in the sense of (2.30). This yields a lower-bound, that matches the upper-bound of Section 4 for smooth trajectories. In this article, we will not consider more general trajectories, as the analysis of solutions to (2.30) proves to be very difficult due to the motion of the poles.

5.1 Large deviation lower-bound

In this section, we explain how to obtain lower bound large deviations assuming the following points:

1. trajectories typically remain in the effective state space $\mathcal{E}_r(d)$ for some $d \in (0, 1/4]$, which is Proposition 2.3;
2. the hydrodynamic limit of the measures $\{Q_{r,\beta,H}^N : N \in \mathbb{N}^*\}$ can be characterised for each $H \in \mathcal{C}$ (this is Proposition 2.4), and we consider only those $H \in \mathcal{C}$ for which the weak formulation (2.30) of the anisotropic motion by curvature with drift has a unique solution, which is additionally continuous in time in Hausdorff topology.

With these two assumptions, one concludes on a lower-bound in the same way as in [KL99], Chapter 10, Section 5.

More precisely, let $H \in \mathcal{C}$, and let $\Gamma^H \in E([0, T_H], \bigcup_{r,d>0} \mathcal{E}_r(d))$ be a solution of (2.30). Assume that H is chosen such that Γ^H is the only solution, and is continuous in time in Hausdorff topology. Γ^H exists until a maximal time T_H , which is the first time Γ^H reaches $\partial([-1, 1]^2)$, or has either opposite quadrants touching each other, or two consecutive poles collapsing into a segment. For any $r \in (0, r_0)$, there is a time $T_r < T_H$ such that:

- Γ^H takes values in $\mathcal{E}_r(1/2)$ on $[0, T_r]$. This is a technical point related to the proof of item 2 of Proposition 2.3 in Section 5.2.
- For any $T_0 \leq T_r$, the measures $Q_{r,\beta,H}^N$, $N \in \mathbb{N}^*$ concentrate in the large N limit on $\delta_{(\Gamma^H)_{t \leq T_0}}$.

For each $T_0 \leq T_r$, recall from (2.36) the definition of the set $\mathcal{A}_{T_0,r,\beta}^{\mathcal{C}}$. Let $\mathcal{O} \subset E([0, T_0], \mathcal{E}_r(1/2))$ be an open set. Assume there is $H \in \mathcal{C}$ such that $\Gamma_{[[0, T_0]]}^H \in \mathcal{O} \cap \mathcal{A}_{T_0,r,\beta}^{\mathcal{C}}$. Then:

$$\liminf_{N \rightarrow \infty} N^{-1} \log Q_{r,\beta}^N(\mathcal{O}) \geq -I_\beta((\Gamma^H)_{t \leq T_0} | \Gamma_0) \quad \Rightarrow \quad \liminf_{N \rightarrow \infty} N^{-1} \log Q_{r,\beta}^N(\mathcal{O}) \geq - \inf_{\mathcal{O} \cap \mathcal{A}_{T_0,r,\beta}^{\mathcal{C}}} I_\beta(\cdot | \Gamma_0). \quad (5.1)$$

We now prove (5.1) under the assumptions listed at the beginning of this section. As in [KL99], the proof consists in a change of probability from $\mathbb{P}_{r,\beta}^N$ to a tilted measure $\mathbb{P}_{r,\beta,H}^N$, and in using Jensen inequality to bound from below $\log Q_{r,\beta,H}^N(\mathcal{O})$ by the entropy $\mathbb{E}_{r,\beta,H}^N[\log d\mathbb{P}_{r,\beta}^N/d\mathbb{P}_{r,\beta,H}^N]$.

The only difference in our case comes from the fact that the quantity $N^{-1}(\log d\mathbb{P}_{r,\beta}^N/d\mathbb{P}_{r,\beta,H}^N)$ is not bounded on $E([0, T_0], N^{-1}X_r^N)$. Indeed, from the proof of Proposition 3.1 (see in particular (3.14)) which, although stated for $\mathcal{L}_{r,\beta,H}\langle \Gamma, G \rangle$ for $G \in \mathcal{C}$, is easily adapted to $d\mathbb{P}_{r,\beta}^N/d\mathbb{P}_{r,\beta,H}^N(\Gamma)$, it must satisfy:

$$N^{-1}(\log d\mathbb{P}_{r,\beta}^N/d\mathbb{P}_{r,\beta,H}^N)(\Gamma) = \sum_{k=1}^4 \int_0^{T_0} [(p_k(\gamma_t) - 1)e^{-2\beta} \mathbf{1}_{P_k \cap \partial([-1,1]^2)} - \mathbf{1}_{p_k=2, DP_r^k}] dt + C(H)O_N(1), \quad (5.2)$$

and p_k can be of order N for each $k \in \{1, \dots, 4\}$. Above, DP_r^k is either V_r or H_r , defined in (2.9)-(2.10), depending on the value of $k \in \{1, \dots, 4\}$. This unbounded term is however easily controlled as we shall see. Proceeding as in [KL99], one obtains, for each H such that $(\Gamma^H)_{t \leq T_0} \in \mathcal{O}$ and each $\delta > 0$, each ε small enough as a function of δ :

$$\begin{aligned} N^{-1} \log Q_{r,\beta}^N(\mathcal{O}) &\geq \mathbb{E}_{r,\beta,H}^N \left[-J_{H,\varepsilon}^\beta \mathbf{1}_{Z \cap \mathcal{O}} \right] + O_H(\delta) + o_N(1) \\ &+ \mathbb{E}_{r,\beta,H}^N \left[\mathbf{1}_{\mathcal{O}} \mathbf{1}_{Z^c} 2 \sum_{k=1}^4 \int_0^{T_0} \left[(p_k(\gamma_\tau) - 1) e^{-2\beta} \mathbf{1}_{P_k \cap \partial([-1,1]^2)} - \mathbf{1}_{p_k(\gamma_\tau)=2, DP_r^k} \right] dt \right]. \end{aligned} \quad (5.3)$$

Recall that $J_{H,\varepsilon}^\beta$ is defined in (4.3), and Z is the set of (3.42), on which the Replacement lemma applies with error δ and the pole terms are controlled. The set $Z^c \cap \mathcal{O}$ has probability super-exponentially small in the large N , small ε limit. In particular, it has probability bounded by $e^{-c(\varepsilon)N}$ for some $c(\varepsilon) > 0$ under $\mathbb{P}_{r,\beta,H}^N$, for ε small enough uniformly on N large enough. This accounts for the $o_N(1)$ term in the first line, and shows that the expectation on the second line is $o_N(1)$ as well.

We now study the expectation in the first line of (5.3), and show that it is equal to $-J_{H,\varepsilon}^\beta(\Gamma^H)$. As an element (in fact, the only one by hypothesis) in the support of the hydrodynamic limit of $(Q_{r,\beta,H}^N)_N$, Γ^H must have almost always point-like poles on $[0, T_0]$. It is thus a point of continuity of $J_{H,\varepsilon}^\beta$ by Proposition 4.1. As such, for a fixed $\eta > 0$, one has:

$$\sup_{\Gamma \in B_{d_E}(\Gamma^H, \eta)} |J_{H,\varepsilon}^\beta(\Gamma) - J_{H,\varepsilon}^\beta(\Gamma^H)| = \omega_{\Gamma^H, H, \varepsilon}(\eta).$$

Above, $B_{d_E}(\Gamma^H, \eta)$ is the open ball with radius η centred on Γ^H , and $\omega_{\Gamma^H, H, \varepsilon}(\cdot)$ is the modulus of continuity of $J_{H,\varepsilon}^\beta$ at Γ^H , in which we stress the dependence on both Γ^H and H , and which vanishes at 0. The first expectation in (5.3) is then recast as follows:

$$\begin{aligned} \mathbb{E}_{r,\beta,H}^N \left[-J_{H,\varepsilon}^\beta \mathbf{1}_{Z \cap \mathcal{O}} \right] &= -J_{H,\varepsilon}^\beta(\Gamma^H) \mathbb{E}_{r,\beta,H}^N \left[\mathbf{1}_{Z \cap \mathcal{O} \cap B_{d_E}(\Gamma^H, \eta)} \right] + O_\eta(\omega_{\Gamma^H, H, \varepsilon}(\eta)) \\ &+ \mathbb{E}_{r,\beta,H}^N \left[\mathbf{1}_{Z \cap \mathcal{O} \cap B_{d_E}(\Gamma^H, \eta)^c} \left(-J_{H,\varepsilon}^\beta \right) \right]. \end{aligned}$$

The expectation in the first term converges to 1 for N large, while the last one vanishes as $J_{H,\varepsilon}^\beta$ is bounded and $Q_{r,\beta,H}^N(B_{d_E}(\Gamma^H, \eta)^c)$ vanishes. It remains to let η , then ε go down to 0 to obtain the left-hand side of (5.1). Taking the supremum of the resulting expression on all H such that Γ^H belongs to \mathcal{O} then yields the right-hand side of (5.1).

To conclude the proof of lower-bound large deviations, it remains to prove the two assumptions presented at the beginning of this section. This is the content of the next two sections. In Section 5.2, we prove that trajectories typically do not leave the good state space $\mathcal{E}_r(d)$ on $[0, \eta]$ for some $\eta > 0$ and $d \leq 1/4$. In Section 5.3, we prove that $(Q_{r,\beta,H}^N)_N$ concentrates on $[0, \eta]$ on δ_{Γ^H} . The trajectory Γ^H , defined at the beginning of this section, is the solution of (2.30), and assumed to be unique. In particular, Γ^H is continuous in time in Hausdorff topology. Since Γ^H is almost always in $\mathcal{E}_r(1/2)$ before time $T_r \geq T_0$, it is in $\mathcal{E}_r(1/2)$ on $[0, T_r]$ by continuity. If $T_0 \leq \eta$, then the lower bound is proven. Otherwise, the result until time T_0 follows by recursion, re-starting the dynamics at $\Gamma_\eta^H \in \mathcal{E}_r(1/2)$.

5.2 The droplet moves on a diffusive scale

In this section, we prove Proposition 2.3. First, we show that a configuration in \mathcal{E}_{r_0} cannot have left \mathcal{E}_{r_1} , for some $r_1 \in (r, r_0)$, before a time of order N^2 . The set \mathcal{E}_{r_0} is defined in (2.15). The techniques employed have the following two nice properties.

1. First, we obtain estimates depending only on the initial point and parameters of the model.
2. Second, we get quantitative estimates for all N large enough, in e^{-cN} for some parameter c . This is the best possible decay rate, as large deviations around the hydrodynamic limit occur at the e^{-N} scale.

Recall from Definition 2.1 the properties of the initial condition of the dynamics. Recall also that, for $r_1 \in (r, r_0)$ and $\beta > 0$, $\tau = \tau_{r_1, \beta, H}^N$ is the first time at which the dynamics with generator $N^2 \mathcal{L}_{r, \beta, H}^N$ starting from Γ_0^N leaves $N\mathcal{E}_{r_1}$. We prove the following.

Lemma 5.1 (Item 1 of Proposition 2.3). *For each $r_1 \in (r, r_0)$, there are constants $c_0, \alpha > 0$ which depend only on H, Γ_0, r_0, r_1 (and in particular not on r, β), and a numerical constant C such that:*

$$\mathbb{P}_{r, \beta, H}^N(\tau \leq c_0) \leq C e^{-\alpha N}. \quad (5.4)$$

Proof. We adapt the method used in [CMST11]. The idea is to show that exiting $N\mathcal{E}_{r_1}$, $r_1 < r_0$ from $N\mathcal{E}_{r_0}$ requires moving a deterministic volume of blocks of order N^2 , which must take a time of order N^2 when N is large.

Consider the first point, i.e. that for $r_1 \in (r, r_0)$, leaving $N\mathcal{E}_{r_1}$ when starting from $N\mathcal{E}_{r_0}$ requires moving at least ψN^2 blocks, for $\psi = \psi(\Gamma_0, r_0, r_1) > 0$. Recall that if $\gamma \in X_r^N$, Γ is the droplet it delimits. There are three ways of leaving the set $N\mathcal{E}_{r_1}$, defined in Appendix B:

- a) breaking V_{r_1} or H_{r_1} (defined in (2.9)-(2.10));
- b) having the difference in abscissa or in ordinate between two consecutive poles less than Nr_1 .
- c) having two points in opposite quadrants become closer than r_1 in 1-distance;

Notice that condition a) is necessarily realised after condition b), so we focus on conditions b) and c). The set \mathcal{E}_{r_1} is defined to contain pathological limits of elements of $N^{-1}X_r^N$ when N is large. However, the dynamics starts from a nice initial condition, i.e. with simple boundary, see Definition 2.1. The hitting time τ of conditions b) and c) is thus larger than the hitting time of the following simpler conditions (see Figure 7):

1. At τ^1 , the droplet first fails to contain the set $D := N^{-1}\{x \in \Gamma_0^N : d(x, \gamma_0^N) \geq N\varepsilon\}$; where $\varepsilon = \varepsilon(\Gamma_0, r_0, r_1)$ is small enough to ensure that the heights (north and south poles) and abscissas (west and east poles) of the poles of D differ from those of $N^{-1}\Gamma_0^N$ by at most $(r_0 - r_1)/10$.
2. At τ^2 , one of the poles has first moved sideways by at least $N(r_0 - r_1)/2$ compared to Γ_0^N .

Write \mathbb{P}_k for the probability associated with the dynamics that stops upon reaching τ^k , $k \in \{1, 2\}$. This (inhomogeneous) Markov chain has generator $N^2 \mathcal{L}_k$ equal to $N^2 \mathcal{L}_{r, \beta, H}$ (defined in (2.11)-(2.14)) for times below τ^k , and 0 strictly after. With the lower bound for τ provided by $\tau^1 \wedge \tau^2$ in conditions 1, 2 and Figure 7, we claim that there must be $\psi = \psi(\Gamma_0, r_0, r_1) > 0$ and functions G_1, G_2 , corresponding to indicator functions of suitable sets, such that, for $k \in \{1, 2\}$ and for the dynamics induced by \mathbb{P}_k :

$$\{\tau^k \leq t\} \subset \left\{ \int_{N^{-1}\Gamma_0^N} G_k - \int_{\Gamma_t^N} G_k \geq \psi \right\}. \quad (5.5)$$

The probability of the event on the right in (5.5) is estimated by the computations of Section 3 as long

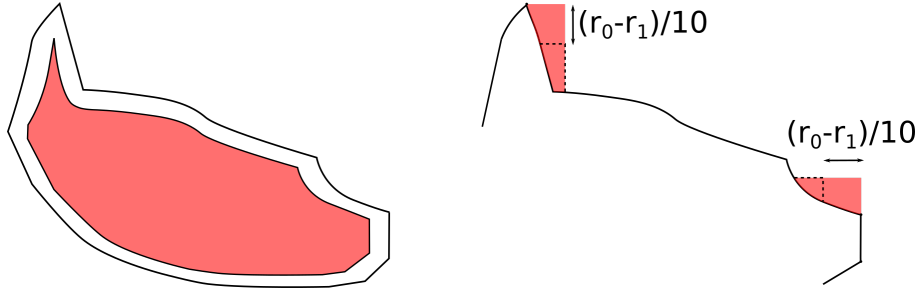

Figure 7: Initial condition/portion of the initial condition of the dynamics. Left figure: the shaded area is the set of points of Γ_0 at distance more than a suitable $\varepsilon > 0$ from the boundary (see item 1 for the choice of ε). τ^1 is the first time at which the boundary of the droplet touches the shaded area.

Right figure: The shaded areas, of smaller side of length $(r_0 - r_1)/2$, have to be filled for either the north or east pole to have moved sideways by $(r_0 - r_1)/2$. The dashed lines delimit areas which always stay below the poles before time τ^1 .

as G_1, G_2 are replaced by smooth approximations, as we now explain.

Estimating τ^1 :

Define G_1 as the indicator function of the ring between the two droplets on the left Figure of 7. For $\zeta > 0$ sufficiently small, let $G_1^\zeta \in [0, 1]$ be a C^2 approximation of G_1 equal to 0 when $G_1 = 0$, to 1 at 1-distance ζ or more to $\{G_1 = 0\}$, and going down smoothly to 0 as a function of the distance otherwise. Take then $\psi_1 = \psi_1(\Gamma_0, r_0, r_1)$ as the smallest volume to delete in order to reach D from $N^{-1}\Gamma_0^N$. Then for $t \geq 0$, up to dividing ψ_1 by 2, for all ζ small enough:

$$\mathbb{P}_{r,\beta,H}^N(\tau^1 \leq t) = \mathbb{P}_1(\tau^1 \leq t) \leq \mathbb{P}_1\left(\int_{N^{-1}\Gamma_0^N} G_1^\zeta - \int_{N^{-1}\Gamma_t^N} G_1^\zeta \geq \psi_1\right). \quad (5.6)$$

Note that this "volume" difference is always negative. By Chebychev exponential inequality, it is sufficient to estimate, for $t > 0$, the quantity $M_t^{1,\zeta} e^{A_t}$, where $(M_t^{1,\zeta})_{t \geq 0}$ is the \mathbb{P}_1 -martingale defined for an X_r^N -valued trajectory $\Gamma = (\Gamma_t^N)_{t \geq 0}$ by:

$$\forall t \geq 0, \quad M_t^{G_1^\zeta} = \exp\left[-N \int_{N^{-1}\Gamma_t^N} G_1^\zeta + N \int_{N^{-1}\Gamma_0^N} G_1^\zeta - A_t\right], \quad (5.7)$$

and $(A_t)_{t \geq 0}$ is the process:

$$\forall t \geq 0, \quad A_t = N^2 \int_0^t e^{N \int_{N^{-1}\Gamma_u^N} G_1^\zeta} \mathcal{L}_1 e^{-N \int_{N^{-1}\Gamma_u^N} G_1^\zeta} du. \quad (5.8)$$

Since $A_t = A_{t \wedge \tau^1}$ for $t \geq 0$, the droplets entering in the definition of (A_t) are all in $N\mathcal{E}_r$. The computations of Section 3 thus apply: recall the notation $\varepsilon_x = 1$ if a block is added corresponding to a vertex x , $\varepsilon_x = -1$

if it is removed. Then for each $t \geq 0$, with $\gamma^N = \partial\Gamma^N$:

$$\begin{aligned}
A_t &\leq \int_0^{t \wedge \tau^1} \left[NC(H) + N \sum_{x \in V(\gamma_u^N)} \varepsilon_x c_x(\Gamma_u^N) G_1^\zeta(x/N) \right. \\
&\quad \left. - 2N \sum_{k=1}^4 \sum_{\substack{x \in P_k(u) \\ x+2e_x^+ \in P_k(u)}} [e^{-2\beta} \mathbf{1}_{P_k(u) \cap \partial\Lambda_N = \emptyset} - \mathbf{1}_{p_k(u)=2, DP_r^k}] G_1^\zeta(x/N) \right] du \\
&\leq N(C(G_1^\zeta) + C(H))t.
\end{aligned} \tag{5.9}$$

To obtain the first inequality in (5.9), p_k was bounded by N for $k \in \{1, \dots, 4\}$. To obtain the second line, the crucial point is that the contribution of the sum on P_k , which may be of order N^2 , is negative ($G_1^\zeta \geq 0$), since it makes the droplet grow. Moreover, $\mathbf{1}_{p_k=2, DP_r^k}$ was bounded by 1. For $\zeta = (r_0 - r_1)/100$, $C(G_1^\zeta)$ depends only on Γ_0 and r_1 . The event DP_r^k corresponds to V_r or H_r , defined in (2.9)-(2.10), depending on the value of $k \in \{1, \dots, 4\}$. Equation (5.9) concludes the bound on τ^1 :

$$\mathbb{P}_{r,\beta,H}^N(\tau^1 \leq t) \leq e^{-\psi_1 N} e^{(C(H)+C(\Gamma_0, r_1))Nt} \mathbb{E}_1[M_t^{1,\zeta}] = e^{-\psi_1 N} e^{(C(H)+C(\Gamma_0, r_1))Nt}, \tag{5.10}$$

which decays exponentially fast to 0 as long as $t < \psi_1/(C(H) + C(\Gamma_0, r_1))$.

Estimating $\tau^1 \wedge \tau^2$:

Equation (5.9) cannot be used to estimate τ^2 directly. Indeed, τ^2 occurs only after the initial droplet has grown somewhere, which means that the poles may contribute. Define however G_2 as the indicator function of the zones delimited by the dashed lines in Figure 7 (in all quadrants, not just the first one as represented). Take then ψ_2 as the smallest volume of one of these dashed area. Then as stated in (5.5), for $t \geq 0$, under \mathbb{P}_2 , the dynamics stopped at τ_2 :

$$\{\tau^1 \wedge \tau^2 \leq t\} \subset \left\{ \tau^1 \geq t, \int_{N^{-1}\Gamma_0^N} G_2 - \int_{N^{-1}\Gamma_t^N} G_2 \geq \psi_2 \right\} \cup \{\tau^1 \leq t\}.$$

The argument is then the same as for the estimate of τ^1 , and we again obtain an exponential decay for sufficiently short time. Since $\tau \geq \tau^1 \wedge \tau^2$, this concludes the proof. \square

Let us now prove the second item in Proposition 2.3.

Lemma 5.2 (Item 2 in Proposition 2.3). *Let $c_0 > 0$ be given by Lemma 5.1. For this lemma only, take $\beta > 64 \log 3$. Then, for each $d \in (0, 1/4)$ and each $H \in \mathcal{C}$, there is a time $T_0 = T_0(\Gamma_0, d_0, d, \beta, H)$, $T_0 \leq c_0$ such that:*

$$\mathbb{P}_{r,\beta,H}^N \left(\int_0^{T_0} \mathbf{1}_{d_H(\Gamma_t, \partial([-1,1]^2)) < d} dt = 0 \right) \xrightarrow{N \rightarrow \infty} 1. \tag{5.11}$$

Proof. The idea is to use the structure of the invariant measure ν to estimate the cost of having one pole come close to the boundary. Let $\eta \leq c_0$, with c_0 given by Lemma 5.1. For short, let $(z_1, \dots, z_4) = (y_{\max}, x_{\max}, y_{\min}, x_{\min})$ be the extremal abscissas/ordinates of a droplet, and denote by z_k^0 , $k \in \{1, \dots, 4\}$ the corresponding values for the initial condition $N^{-1}\Gamma_0^N$ of Definition 2.1. Let also ℓ_0^N be the length in 1-norm of the boundary of $N^{-1}\Gamma_0^N$, which we recall is at distance at least $1/2$ from $\partial([-1, 1]^2)$ for each N . If $x \in \mathbb{R}$, define $x_+ = \max(x, 0)$.

Notice first that the lemma holds if we can prove that, for η small enough:

$$\mathbb{P}_{r,\beta,H}^N \left(\sup_{t \leq \eta} [(z_1 - z_1^0)_+ + (z_2 - z_2^0)_+ + (z_3^0 - z_3)_+ + (z_4^0 - z_4)_+] > 1/2 - d \right) = o_N(1). \tag{5.12}$$

Each of the term appearing in (5.12) is 0 unless the pole of the corresponding number has come closer to the boundary. The event in (5.12) is thus equal to (recall that lengths are in 1-norm):

$$\left\{ \sup_{t \leq \eta} [|\gamma(t)| - \ell_0^N] > 1/2 - d \right\}.$$

Let us estimate the probability of this event. As $\eta \leq c_0$, we need only do so under $\mathbb{P}_{r,\beta}^N$. Indeed, by Lemma 5.1:

$$\begin{aligned} \mathbb{P}_{r,\beta,H}^N \left(\sup_{t \leq \eta} [|\gamma(t)| - \ell_0^N] > 1/2 - d \right) &= \mathbb{P}_{r,\beta,H}^N \left(\forall t \in [0, \eta], \gamma_t \in \mathcal{E}_r; \sup_{t \leq \eta} [|\gamma(t)| - \ell_0^N] > 1/2 - d \right) + o_N(1) \\ &\leq e^{C(H)\eta N} \mathbb{P}_{r,\beta}^N \left(\sup_{t \leq \eta} [|\gamma(t)| - \ell_0^N] > 1/2 - d \right)^{1/2} + o_N(1). \end{aligned} \quad (5.13)$$

The second line comes from Cauchy-Schwarz inequality and the fact that, by (4.2)-(4.3)-(4.4):

$$\mathbb{E}_{r,\beta}^N \left[\mathbf{1}_{\{\forall t \in [0, \eta], \gamma_t \in \mathcal{E}_r\}} (d\mathbb{P}_{r,\beta,H}^N / d\mathbb{P}_{r,\beta}^N)_{[0, \eta]}^2 \right]^{1/2} \leq e^{C(H)\eta N}.$$

Change initial condition to obtain a probability starting from the invariant measure ν :

$$\mathbb{P}_{r,\beta}^N \left(\sup_{t \leq \eta} [|\gamma(t)| - \ell_0^N] > d_0 - d \right) \leq \nu(\Gamma_0^N)^{-1} \mathbb{P}_\nu \left(\sup_{t \leq \eta} [|\gamma(t)| - \ell_0^N] > d_0 - d \right).$$

Let \mathcal{N}_t be the number of updates in the dynamics up to time t . (\mathcal{N}_t) is a Poisson process of rate bounded by $20N^3$, which is a rough bound for the update rate of a curve under the contour dynamics. To use the fact that ν is invariant under the dynamics, split $[0, \eta]$ in, say, N^4 intervals of length ηN^{-4} . $\mathcal{N}_{\eta N^{-4}}$ is thus a Poisson random variable of rate $20\eta N^{-1}$, and for N large enough:

$$\mathbb{P}_{r,\beta,H}^N \left(\mathcal{N}_{\eta N^{-4}} \geq \frac{100N}{\log N} \right) \leq \exp[-100N] \quad \Rightarrow \quad \limsup_{N \rightarrow \infty} \frac{1}{N} \log \left[\nu(\Gamma_0^N)^{-1} \mathbb{P}_{r,\beta,H}^N \left(\mathcal{N}_{\eta N^{-4}} \geq \frac{100N}{\log N} \right) \right] < 0.$$

As a result, there is $c > 0$ such that:

$$\begin{aligned} \mathbb{P}_{r,\beta}^N \left(\sup_{t \leq \eta} [|\gamma(t)| - \ell_0^N] > 1/2 - d \right) &\leq \nu(\Gamma_0^N)^{-1} N^4 \mathbb{P}_\nu \left(\sup_{t \leq N^{-4}\eta} [|\gamma(t)| - \ell_0^N] > 1/2 - d \right) \\ &= \nu(\Gamma_0^N)^{-1} N^4 \nu \left(|\gamma| - \ell_0^N > 1/4 - d/2 \right) + O(e^{-cN}). \end{aligned}$$

Recalling (5.13), one obtains by definition of ν , for $\eta < c/C(H)$:

$$\mathbb{P}_{r,\beta,H}^N \left(\sup_{t \leq \eta} [|\gamma(t)| - \ell_0^N] > 1/2 - d \right) \leq e^{C(H)\eta N} N^4 e^{-\beta N(1/4-d/2)} 3^{8N} + o_N(1),$$

where 3^{8N} is a rough upper bound for the number of curves with length larger than $|\ell_0^N| + 1/4 - d/2$. As $d < 1/4$ and $\beta > 64 \log 3 > 8 \log 3 / (1/4 - d/2)$, there is $\eta = T_0 \leq c_0$ small enough satisfying the claim of the lemma. \square

Corollary 5.3 (Relative compactness of the sequence $\{Q_{r,\beta,H}^N : N \in \mathbb{N}^*\}$). *Let T_0 be chosen according to the previous lemma. Then $\{Q_{r,\beta,H}^N : N \in \mathbb{N}^*\}$ is relatively compact in $\mathcal{M}_1(E([0, T_0], X))$, and its weak limit points are supported in $E([0, T_0], \mathcal{E}_r(d))$.*

Proof. By Lemmas 5.1- 5.2, the first hypothesis of Corollary B.10 is satisfied. The second one proceeds from Appendix B.3. \square

5.3 Characterisation of limit points

Fix $H \in \mathcal{C}$ and let $T_0 > 0$ be a time given by Lemma 5.2. In this section, we prove Proposition 2.4, i.e. we prove that any weak limit point $Q_{r,\beta,H}^*$ of $(Q_{r,\beta,H}^N)_N$ in $\mathcal{M}_1(E([0, T_0], X))$ is concentrated on weak solutions (2.30) of anisotropic motion by curvature with drift in $E_{pp}([0, T_0], \mathcal{E}_r(d))$ (defined in (2.34)). We start by extending upper-bound large deviations to the sequence $(Q_{r,\beta,H}^N)_N$.

Lemma 5.4. *For the sequence $(Q_{r,\beta,H}^N)$, for any closed set $C \subset E([0, T_0], \mathcal{E}_r(d))$:*

$$\limsup_{N \rightarrow \infty} \frac{1}{N} \log Q_{r,\beta,H}^N(C) \leq - \sup_{q \geq 1} \inf_{C \cap D_q} \sup_{G, \varepsilon} [J_{G,\varepsilon} - J_{H,\varepsilon}] \leq - \inf_C I_{\beta,H}. \quad (5.14)$$

The set $D_q = \bigcap_{n \geq 1} D_{q,n}$ controls the neighbourhood of the poles, as defined in (4.9). The functional $I_{\beta,H}$ is $+\infty$ outside of $E_{pp}([0, T_0], \mathcal{E}_r(d))$, and is defined for $\Gamma \in E_{pp}([0, T_0], \mathcal{E}_r(d))$ as:

$$I_{\beta,H}(\Gamma) = \sup_{G \in \mathcal{C}} \{J_G^\beta(\Gamma) - J_H^\beta(\Gamma)\} = \sup_{F \in \mathcal{C}} \left\{ J_F^\beta(\Gamma) - \int_0^{T_0} d\tau \int_{\gamma_\tau} \mu F H ds_\tau \right\}. \quad (5.15)$$

Recall that μ is the mobility defined in (2.26), and that $E_{pp}([0, T_0], \mathcal{E}_r(d))$ is defined in (2.34).

Proof. Simply write:

$$Q_{r,\beta,H}^N(C) = \mathbb{E}_{r,\beta}^N \left[\frac{d\mathbb{P}_{r,\beta,H}^N}{d\mathbb{P}_{r,\beta}^N} \mathbf{1}_C \right],$$

and repeat the computations of Section 4 to obtain the large deviation upper bound (5.15) as well as the first expression of $I_{\beta,H}$. The second expression (5.15) is obtained by the change of functions $F = G - H$ and elementary computations. \square

It is a well-known fact that the only trajectories for which the rate function $I_{\beta,H}$ vanishes are solutions of (2.30), which corresponds to its first variation. Let us provide a quick proof. Consider $\Gamma \in E([0, T_0], \mathcal{E}_r(d))$ such that $I_{\beta,H}(\Gamma) = 0$, and take $\varepsilon > 0$ and $G \in \mathcal{C}$. Then $\Gamma \in E_{pp}([0, T_0], \mathcal{E}_r(d))$, and:

$$0 \geq J_{\pm\varepsilon G}^\beta - \pm\varepsilon \int_0^{T_0} d\tau \int_{\gamma_\tau} \mu H G ds_\tau = \pm\varepsilon \left(\ell_G^\beta - \int_0^{T_0} d\tau \int_{\gamma_\tau} \mu H G ds_\tau \right) - \frac{\varepsilon^2}{2} \int_0^{T_0} d\tau \int_{\gamma_\tau} \mu G^2 ds_\tau.$$

Taking ε small with G fixed, the term of order ε must vanish, and it is precisely (2.30) with test function G . As this is true for all $G \in \mathcal{C}$, Γ is a solution of (2.30). The converse is clearly true, since if Γ satisfies (2.30), then:

$$I_{\beta,H}(\Gamma) = \sup_{G \in \mathcal{C}} \left\{ -\frac{1}{2} \int_0^{T_0} d\tau \int_{\gamma_\tau} \mu G^2 ds_\tau \right\} = 0.$$

We now conclude on the proof of Proposition 2.4 through the following Lemma.

Lemma 5.5. *Recall from Section 5.1 the definition of $\Gamma_{|[0,T_0]}^H \in E([0, T_0], \mathcal{E}_r(d))$, still denoted by Γ^H , assumed to be the unique solution to (2.30) on $[0, T_0]$. Then $Q_{r,\beta,H}^*$ is supported on $\{I_{\beta,H} = 0\}$, thus:*

$$Q_{r,\beta,H}^* = \delta_{\Gamma^H}.$$

Proof. For ease of notation, we still denote by $(Q_{r,\beta,H}^N)_N$ a subsequence converging weakly to some limit point $Q_{r,\beta,H}^*$. The idea is to use the large deviation upper-bound of Lemma 5.4 to obtain the hydrodynamics limit. Although classical, this is made difficult in our case by the lack of lower semi-continuity of the functional $I_{\beta,H}$ defined in (5.15) and, in a related manner, by the fact that the set $E_{pp}([0, T_0], \mathcal{E}_r(d))$ on which it can be finite is not closed.

This justifies the introduction of the functional $\chi_{\cap_{n \geq 1} D_{q,n}} \sup_{G,\varepsilon} [J_{G,\varepsilon} - J_{H,\varepsilon}]$ in the middle term in (5.14), where $\chi_A(x) = 1$ if $x \in A$, $\chi_A(x) = +\infty$ if $x \notin A$. This functional is infinite outside the closed set $D_p = \cap_{n \geq 1} D_{q,n} \subset E_{pp}([0, T_0], \mathcal{E}_r(d))$ (defined in (4.9)), and lower semi-continuous by continuity of $J_{G,\varepsilon}(\cdot)$ on $E_{pp}([0, T_0], \mathcal{E}_r(d))$ for $G \in \mathcal{C}$.

Let $(K_\eta)_{\eta>0}$ be a family of compact sets in $E([0, T_0], \mathcal{E}_r(d))$, which exists by Corollary 5.3, such that:

$$\forall N \geq 1, \quad Q_{r,\beta,H}^N(K_\eta) \geq 1 - \eta \quad \Rightarrow \quad Q_{r,\beta,H}^*(K_\eta) \geq 1 - \eta.$$

Let $\varepsilon > 0$ and consider the open set $B(\varepsilon) := \{\Gamma : d_E(\Gamma, \{I_{\beta,H} = 0\}) < \varepsilon\}$. Let $B_c(\varepsilon)$ be its closure. The complementary of $B_c(\varepsilon)$ is open, thus:

$$Q_{r,\beta,H}^*(B_c(\varepsilon)^c) \leq \liminf_{N \rightarrow \infty} Q_{r,\beta,H}^N(B_c(\varepsilon)^c).$$

As $B_c(\varepsilon)^c \subset B(\varepsilon)^c$,

$$Q_{r,\beta,H}^N(B_c(\varepsilon)^c) \leq Q_{r,\beta,H}^N(B(\varepsilon)^c) \leq \eta + Q_{r,\beta,H}^N(B(\varepsilon)^c \cap K_\eta).$$

The set $K_\eta \cap B(\varepsilon)^c$ is compact, thus by Lemma 5.4:

$$\limsup_{N \rightarrow \infty} \frac{1}{N} \log Q_{r,\beta,H}^N(B(\varepsilon)^c \cap K_\eta) \leq - \sup_{q \geq 1} \inf_{K_\eta \cap B(\varepsilon)^c \cap D_q} \sup_{G,\varepsilon} [J_{G,\varepsilon} - J_{H,\varepsilon}] < 0. \quad (5.16)$$

Let us explain the strict inequality in (5.16). Suppose by contradiction that the right-hand side in (5.16) vanishes. The supremum on q can then be removed, so take $q = 1$ and let $\Gamma^n \in D_1 \cap K_\eta \cap B(\varepsilon)^c$, $n \in \mathbb{N}$ be a sequence such that:

$$\lim_{n \rightarrow \infty} \sup_{G,\varepsilon} [J_{G,\varepsilon} - J_{H,\varepsilon}](\Gamma^n) = 0.$$

As $D_1 \cap K_\eta \cap B(\varepsilon)^c$ is compact, (Γ^n) has a subsequence that converges to some Γ . By lower semi-continuity of $\sup_{G,\varepsilon} [J_{G,\varepsilon} - J_{H,\varepsilon}]$ on D_1 ,

$$\forall \varepsilon > 0, \forall G \in \mathcal{C}, \quad J_{G,\varepsilon}(\Gamma) - J_{H,\varepsilon}(\Gamma) \leq 0. \quad (5.17)$$

In particular, Γ is a solution of (2.30), thus it is in $\{I_{\beta,H} = 0\} \subset B(\varepsilon)$ by the discussion preceding the lemma, which is absurd. It follows that, for N large enough:

$$Q_{r,\beta,H}^N(B_c(\varepsilon)^c) \leq \eta + Q_{r,\beta,H}^N(B(\varepsilon)^c \cap K_\eta) \leq 2\eta \quad \Rightarrow \quad Q_{r,\beta,H}^*(B_c(\varepsilon)^c) \leq 3\eta.$$

As this holds for all $\eta > 0$, $Q_{r,\beta,H}^*$ is concentrated on $\{I_{\beta,H} = 0\}$, which by hypothesis is simply $\{\Gamma^H\}$. \square

6 Behaviour of the poles and $\mathbf{1}_{p_k=2}$ terms

In this section, we focus on the specificity of the contour dynamics: the behaviour of the poles. The main result is the proof of Proposition 2.2, which states that the regrowth, $e^{-2\beta}$ term in the generator (2.11) acts as a reservoir, injecting particles into the SSEP on each quadrant. This fixes the particle density around the poles, i.e. the tangent vector. It is shown to be discontinuous across the pole, and depends only on the value of β . The proof of these statements is carried out in Subsection 6.2. It makes crucial use of the irreducibility of the dynamics around the poles, which is the single added feature in the contour dynamics compared to the zero temperature stochastic Ising model.

Subsection 6.1 presents a useful bijection argument which yields an estimate of the pole size as well as local equilibrium at the poles. These two statements were used in Sections 3-4. Parameters $r < r_0$, $\beta > 0$, $H \in \mathcal{C}$ are fixed throughout the section according to Definition 2.1, as well as a time $T_0 > 0$. All proofs are done for the north pole $P := P_1$ with size $p := p_1 = |P_1| - 1$, the other poles are similar. We work with elements of X_r^N , rather than rescaled microscopic curves in $N^{-1}X_r^N$ as in Section 3. Throughout the section, $T_0 > 0$ is a fixed time.

6.1 Size of the poles and local equilibrium

In this section, we estimate (3.14), i.e. we estimate the pole size and the term

$$W_t^G(\gamma) := \sum_{\substack{x \in P \\ x+2e_x^+ \in P}} (\mathbf{1}_{p=2, V_r} - e^{-2\beta} \mathbf{1}_{x \notin \partial\Lambda_N}) G(t, x/N), \quad \gamma \in X_r^N, t \geq 0 \quad (6.1)$$

for any test function $G \in \mathcal{C}$. The condition V_r , defined in (2.9), states that the north pole of a curve is allowed to go down by the contour dynamics. Summing on $x \in P$ such that $x + 2e_x^+ \in P$ is just a way of enumerating the different positions at which one can add two blocks atop the pole. We prove:

Lemma 6.1. *Write P for the north pole of a curve in X_r^N . For each $A > 1$,*

$$\limsup_{N \rightarrow \infty} \frac{1}{N} \log \mathbb{P}_{r,\beta}^N \left(\frac{1}{T_0} \int_0^{T_0} \mathbf{1}_{P(\gamma_t) \cap \partial\Lambda_N = \emptyset} e^{-2\beta} (p_t - 1) dt \geq A \right) = -\infty. \quad (6.2)$$

Moreover, for each $\delta > 0$ and $G \in \mathcal{C}$,

$$\limsup_{N \rightarrow \infty} \frac{1}{N} \log \mathbb{P}_{r,\beta}^N \left(\left| \frac{1}{T_0} \int_0^{T_0} W_t^G dt \right| > \delta \right) = -\infty. \quad (6.3)$$

Equations (6.2)-(6.3) hold also under $\mathbb{P}_{r,\beta,H}^N$, with the additional condition $\{\forall t \in [0, T_0], \gamma_t \in N\mathcal{E}_r\}$.

The proof of Lemma 6.1 relies on a bijection argument to estimate the expectation of the terms between parentheses in (6.1) one in terms of the other and the Dirichlet form. It is stated in the following lemma.

Lemma 6.2. *Let f be a density with respect to the contour measure $\nu = \nu_{r,\beta}^N$, defined in (2.3), and denote by \mathbb{E}_{ν_f} the expectation under $f d\nu$. Then, for any $A \geq 2$,*

$$\left(\nu_f(p = 2, V_r, p' \geq A)^{1/2} - \mathbb{E}_{\nu_f} [(p-1)e^{-2\beta} \mathbf{1}_{x \notin \partial\Lambda_N} \mathbf{1}_{p \geq A}]^{1/2} \right)^2 \leq 2D_N(f), \quad (6.4)$$

where $D_N(f) = -\mathbb{E}_{\nu} [f^{1/2} \mathcal{L}_{r,\beta} f^{1/2}]$ is the Dirichlet form of the contour dynamics, and $p' = p'(\gamma)$ for $\gamma \in X_r^N$ is the number of blocks one level below the pole in the droplet Γ such that $\gamma = \partial\Gamma$. Equation (6.4) also holds with $p' \leq A, p \leq A$ instead of $p' \geq A, p \geq A$ respectively in the probability and in the expectation.

Proof. We prove the result with $A = 2$ (i.e. without constraint), the general case is similar. Fix a density f and define the two sets $I_r, V_r(2)$ as:

$$I_r = \{\gamma \in X_r^N : P(\gamma) \cap \partial\Lambda_N = \emptyset\}, \quad V_r(2) = V_r \cap \{p = 2\}, \quad (6.5)$$

with V_r defined in (2.9). Define U on X_r^N as follows:

$$\forall \gamma \in X_r^N, \quad U(\gamma) = \mathbf{1}_{I_r}(\gamma)e^{-2\beta}(p(\gamma) - 1). \quad (6.6)$$

Let us prove that $\nu_f(V_r(2))$ and $\mathbb{E}_{\nu_f}[U]$ are comparable, up to an error that can be expressed in terms of the Dirichlet form $D_N(f)$.

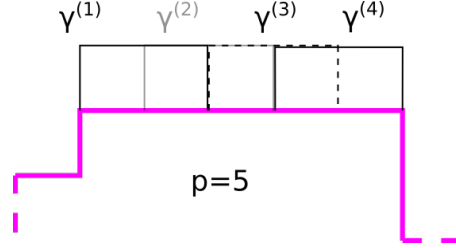

Figure 8: Neighbourhood of the north pole of a curve $\gamma \in I_r$ (thick line) and the $\gamma^{(k)}$, $k \leq p - 1 = 4$. $\gamma^{(3)}$ is the curve γ to which the two blocks delimited by dashed lines are added. Conversely, any of the $\gamma^{(k)}$, $k \leq 4$ is in $V_r(2)$, and deleting the two blocks constituting their poles yields γ .

To each $\gamma \in I_r$ (defined in (6.5)), it is dynamically allowed to add two blocks above the north pole. Denote by $\gamma^{(1)}, \dots, \gamma^{(p-1)}$ the $p(\gamma) - 1$ corresponding curves, where $\gamma^{(k)}$ is identical to γ except that two blocks sitting on the edges $k, k + 1$ are added, counting the edges from the left extremity of the pole (see Figure 8). Note that the $\gamma^{(k)}$ correspond to the $\gamma^{+,x}$ with $x, x + 2e_x^+ \in P$ defined above (2.7). Conversely, the size 2 pole of each curve $\gamma' \in V_r(2)$ can be deleted, to obtain a curve $\gamma = (\gamma')^{-,1} \in I_r$ with the notations of Section 2. The curve γ has length $|\gamma| = |\gamma'| - 2$. The same curve $\gamma \in I_r$ occurs $p - 1 := p(\gamma) - 1$ times when enumerating elements of $V_r(2)$ and deleting their pole, thus:

$$\begin{aligned} \nu_f(V_r(2)) &= \sum_{\gamma' \in V_r(2)} \nu(\gamma')f(\gamma') = \sum_{\gamma' \in V_r(2)} \sum_{\gamma \in I_r} \mathbf{1}_{\{\exists k \leq p-1: \gamma' = \gamma^{(k)}\}} \nu(\gamma)e^{-2\beta} f(\gamma^{(k)}) \\ &= \sum_{\gamma \in I_r} \nu(\gamma)e^{-2\beta} \sum_{k=1}^{p-1} f(\gamma^{(k)}). \end{aligned}$$

Add and subtract the quantities needed to bound the second line by the Dirichlet form $D_N(f)$:

$$\begin{aligned} \nu_f(V_r(2)) &= \sum_{\gamma \in I_r} \nu(\gamma)e^{-2\beta} \sum_{k=1}^{p-1} [f(\gamma^{(k)}) + f(\gamma) - 2f^{1/2}(\gamma)f^{1/2}(\gamma^{(k)})] \\ &\quad - \sum_{\gamma \in I_r} \nu(\gamma)e^{-2\beta} \left[(p-1)f(\gamma) - 2 \sum_{k=1}^{p-1} f^{1/2}(\gamma)f^{1/2}(\gamma^{(k)}) \right]. \end{aligned} \quad (6.7)$$

To estimate the second line of (6.7), apply Cauchy-Schwarz inequality to the sum $\sum_{k=1}^{p-1}$ to obtain:

$$\nu_f(V_r(2)) \leq 2D_N(f) - \mathbb{E}_{\nu_f}[e^{-2\beta}(p-1)\mathbf{1}_{I_r}] + 2 \sum_{\gamma \in I_r} \nu(\gamma)e^{-2\beta}(p-1)^{1/2} f^{1/2}(\gamma) \left[\sum_{k=1}^{p-1} f(\gamma^{(k)}) \right]^{1/2}.$$

Recall the definition of U from (6.6) and again use Cauchy-Schwarz on the sum on the curves in I_r to find:

$$\begin{aligned}\nu_f(V_r(2)) &\leq 2D_N(f) - \mathbb{E}_{\nu_f}[U] + 2 \left[\sum_{\gamma \in I_r} \nu(\gamma) e^{-2\beta} (p-1) f(\gamma) \right]^{1/2} \left[\sum_{\gamma \in I_r} \nu(\gamma) e^{-2\beta} \sum_{k=1}^{p-1} f(\gamma^{(k)}) \right]^{1/2} \\ &= 2D_N(f) - \mathbb{E}_{\nu_f}[U] + 2\mathbb{E}_{\nu_f}[U]^{1/2} \nu_f(V_r(2))^{1/2}.\end{aligned}$$

Putting things together yields the claim of the lemma:

$$\left[\nu_f(V_r(2))^{1/2} - \mathbb{E}_{\nu_f}[U]^{1/2} \right]^2 \leq 2D_N(f). \quad (6.8)$$

□

Proof of Lemma 6.1. We now explain how to obtain Lemma 6.1 from (6.4). We need to do three things:

1. bound from above the probabilities appearing in the claim by an expression involving (6.4);
2. prove that (6.3) holds for W^G , with $G \in \mathcal{C}$. The first point only gives the result for $\mathbf{1}_{p=2, V_r} - U$, which corresponds to W^1 ;
3. and prove the result under $\mathbb{P}_{r,\beta,H}^N$ up to adding the condition $\{\forall t \leq T_0, \gamma_t \in N\mathcal{E}_r\}$.

The first and third points are classical and easily adapted to the present case. Since they are used repeatedly in the article, we present them here once and for all. The second point requires some care because the function $G \in \mathcal{C}$ may change sign, which breaks the upper-bounds in the proof of Lemma 6.2.

Let us explain the general idea for the first point using (6.2) as an example. We wish to estimate:

$$\mathbb{P}_{r,\beta}^N \left(\frac{1}{T_0} \int_0^{T_0} e^{-2\beta} \mathbf{1}_{I_r}(\gamma_t) (p(\gamma_t) - 1) dt \geq A \right),$$

where I_r is defined in (6.5). We do so using Feynman-Kac formula. Let $a > 0$, and apply the exponential Chebychev inequality to obtain

$$\begin{aligned}\frac{1}{N} \log \mathbb{P}_{r,\beta}^N \left(\frac{1}{T_0} \int_0^{T_0} e^{-2\beta} \mathbf{1}_{I_r}(\gamma_t) (p(\gamma_t) - 1) dt \geq A \right) \\ \leq -aAT_0 + \frac{1}{N} \log \mathbb{E}_{r,\beta}^N \left[\exp \left[aN \int_0^{T_0} \mathbf{1}_{\gamma_t \in I_r} e^{-2\beta} (p_t - 1) dt \right] \right].\end{aligned} \quad (6.9)$$

Consider the generator $N^2 \mathcal{L}_{r,\beta} + aNU$, with U defined in (6.6). This generator is self-adjoint for the contour measure $\nu = \nu_{r,\beta}^N$ (2.3), and Feynman-Kac inequality plus a representation theorem for the largest eigenvalue of a symmetric operator yield that, at equilibrium:

$$\mathbb{E}_\nu \left[\exp \left[aN \int_0^{T_0} U(\gamma_t) dt \right] \right] \leq \exp \int_0^{T_0} dt \sup_{f \geq 0: \mathbb{E}_\nu[f]=1} \left\{ aN \mathbb{E}_{\nu_f}[U] - N^2 D_N(f) \right\}. \quad (6.10)$$

One can bound $\mathbb{P}_{r,\beta}^N$ from above by the probability \mathbb{P}_ν starting under the equilibrium measure ν :

$$\mathbb{P}_{r,\beta}^N(\cdot) \leq Z_{r,\beta} e^{\beta|\gamma_0|} \mathbb{P}_\nu(\cdot) \leq e^{C\beta N} \mathbb{P}_\nu(\cdot), \quad (6.11)$$

for some constant $C \leq 8$. Using (6.10)-(6.11), (6.9) becomes:

$$\frac{1}{N} \log \mathbb{P}_{r,\beta}^N \left(\frac{1}{T_0} \int_0^{T_0} U(\gamma_t) dt \geq A \right) \leq -aAT_0 + C\beta + T_0 \sup_{\substack{f \geq 0, \\ \int f d\nu = 1}} \left\{ a\mathbb{E}_{\nu_f}[U] - ND_N(f) \right\}. \quad (6.12)$$

At this point, we can use Lemma 6.2 to estimate the supremum in the right-hand side of (6.12). U may be unbounded as a function of N , but the bound $\mathbb{E}_{\nu_f}[U] \leq 1 + (2D_N(f))^{1/2}$ provided by Lemma 6.2 and elementary computations show that the supremum is positive only for densities f with $D_N(f) \leq C(a)/N$. For such densities, (6.4) yields:

$$\mathbb{E}_{\nu_f}[U] \leq \nu_f(V_r(2)) + C(a)O(N^{-1/2}) \leq 1 + C(a)O(N^{-1/2}).$$

Inject this result in (6.12), take the lim sup in N , then have a increase to infinity to conclude the proof of (6.2). Equation (6.3) in the $G \equiv 1$ case follows similarly, using the identity $x - y = (\sqrt{x} - \sqrt{y})(\sqrt{x} + \sqrt{y})$ valid for $x, y \geq 0$. Indeed, for W^1 , the quantity in the supremum in (6.12) is now $a\mathbb{E}_{\nu_f}[W^1] - ND_N(f)$, where by definition:

$$W^1 = \sum_{\substack{x \in P \\ x+2e_x^+ \in P}} [\mathbf{1}_{p=2, V_r} - e^{-2\beta} \mathbf{1}_{I_r}] = \mathbf{1}_{p=2, V_r} - (p-1)e^{-2\beta} \mathbf{1}_{I_r} = \mathbf{1}_{V_r(2)} - U.$$

As a result, $\mathbb{E}_{\nu_f}[W^1]$ can be bounded from above as follows:

$$\begin{aligned} |\mathbb{E}_{\nu_f}[W^1]| &= \left| \nu_f(V_r(2))^{1/2} - \mathbb{E}_{\nu_f}[U]^{1/2} \right| \left[\nu_f(V_r(2))^{1/2} + \mathbb{E}_{\nu_f}[U]^{1/2} \right] \\ &\leq (2D_N(f))^{1/2} [2 + (2D_N(f))^{1/2}]. \end{aligned} \quad (6.13)$$

Elementary computations again yield that the supremum in (6.12) with W^1 instead of U is positive only for $D_N(f) \leq C(a)/N^2$. This concludes the proof of the first point.

Let us now deal with the second point, i.e. proving (6.3) for any G and not just $G \equiv 1$. As G may not have constant sign, one cannot directly use the bounds in the proof of Lemma 6.2. However, if G is positive, it is not complicated to repeat the bijection argument of Lemma 6.2 to obtain, for each $t \leq T_0$:

$$\left[\mathbb{E}_{\nu_f} \left[e^{-2\beta} \mathbf{1}_{I_r} \sum_{\substack{x \in P \\ x+2e_x^+ \in P}} G(t, x/N) \right]^{1/2} - \mathbb{E}_{\nu_f} \left[\mathbf{1}_{V_r(2)} \sum_{\substack{x \in P \\ x+2e_x^+ \in P}} G(t, x/N) \right]^{1/2} \right]^2 \leq C(G)D_N(f) + O_G(N^{-1}). \quad (6.14)$$

Recall that the summation on $x \in P$ such that $x + 2e_x^+ \in P$ is just a way of enumerating all places where two blocks can appear atop the pole. For general $G \in \mathcal{C}$, the result follows by splitting G into its positive and negative parts $G = G^+ - G^-$, and estimating the contribution of G^+, G^- by (6.14).

We now prove the third point, i.e. establish (6.2) and (6.3) under $\mathbb{P}_{r,\beta,H}^N$ assuming trajectories take values in $N\mathcal{E}_r$. The point of this additional condition is the following. According to Section 3 (see (3.14) for the first term and (3.22)-(3.30) for the second one), for each $N\mathcal{E}_r$ -valued trajectory $\gamma = (\gamma_t)_{t \leq T_0}$,

$$\frac{1}{N} \log D_{r,\beta,H}^N(\gamma) = \sum_{k=1}^4 \int_0^{T_0} [(p_k(\gamma_t) - 1)e^{-2\beta} \mathbf{1}_{P_k \cap \partial\Lambda_N = \emptyset} - \mathbf{1}_{p_k=2, DP_r^k}] dt + C(H)T_0O_N(1), \quad (6.15)$$

where $D_{r,\beta,H}^N = d\mathbb{P}_{r,\beta,H}^N/d\mathbb{P}_{r,\beta}^N$ until time T_0 , and DP_r^k is defined in (2.9)-(2.10). Let χ denote any of the two events appearing in (6.2)-(6.3). In the proof of the first point, we saw for the north pole:

$$\mathbb{E}_{r,\beta}^N \left[\exp \left[NC(H) \int_0^{T_0} (p(\gamma_t) - 1) e^{-2\beta} \mathbf{1}_{I_r}(\gamma_t) dt \right] \right] \leq T_0 + T_0 O_H(N^{-1/2}).$$

This immediately generalises to the other three poles. As a result, using (6.15):

$$\begin{aligned} \frac{1}{N} \log \mathbb{P}_{r,\beta,H}^N(\forall t \in [0, T_0], \gamma_t \in N\mathcal{E}_r; \chi) &= \frac{1}{N} \log \mathbb{E}_{r,\beta}^N [\mathbf{1}_{\forall t \in [0, T_0], \gamma_t \in N\mathcal{E}_r} \mathbf{1}_\chi D_{r,\beta,H}^N] \\ &\leq \frac{1}{2N} \log \mathbb{P}_{r,\beta}^N(\chi) + C(H)T_0 + \frac{1}{2N} \log \mathbb{E}_{r,\beta}^N \left[\exp \left[2NC(H) \int_0^{T_0} (p(\gamma_t) - 1) e^{-2\beta} \mathbf{1}_{I_r}(\gamma_t) dt \right] \right]. \end{aligned}$$

The last term is bounded: taking N to infinity proves item 3. \square

6.2 Convergence of the $\mathbf{1}_{p=2}$ term at fixed β and slope around the poles

This section is devoted to the proof of Proposition 2.2: poles act as reservoirs that fix to $e^{-\beta}$ the averaged slopes $\xi_{L_1}^{\pm, \varepsilon^N}$, $1 - \xi_{L_1}^{\pm, \varepsilon^N}$ at the poles. We prove this statement in several steps. First, we explain how to use the effective state space \mathcal{E}_r (or $\mathcal{E}_r(d)$) to obtain a local dynamics from the contour dynamics, which is non-local due to boundary conditions in the definition of X_r^N , see Section 6.2.1. This is a key technical argument to be able to compare the contour dynamics to simpler 1-dimensional ones.

We then prove that the $\mathbf{1}_{p=2}$ term fixes the slope around the poles, in the sense that the time integrals of $\mathbf{1}_{p=2}$ and $\xi_{L_1}^{\pm, \varepsilon^N}$ are close, see Section 6.2.2. This should not come as a surprise if one remembers that, in a Symmetric Simple Exclusion Process (SSEP) with reservoirs, the density close to the reservoirs is fixed. The time average of $\mathbf{1}_{p=2}$ is then proven to be equal to $e^{-\beta}$ in Section 6.2.4. Preliminary microscopic estimates, crucial to Section 6.2 and thereby of central importance to the paper, are carried out in Section 6.2.3.

6.2.1 Turning the contour dynamics into a local dynamics

To compare the non-local (due to boundary effects in the definition of X_r^N) 2-dimensional contour dynamics to a local, 1-dimensional dynamics (in the present case the SSEP and a kind of zero range process introduced in Section 6.2.4), we need to explain how to remove the non-local constraints. For moves away from the poles (addition/deletion of a single block), the only non-local constraint is that opposite quadrants of an element of X_r^N cannot cross. For deletion or regrowth at the poles, one has to make sure neither to touch $\partial\Lambda_N$ nor to shrink droplets too much, see the definition of X_r^N in Section 2.1.

In the "good" state space $N\mathcal{E}_r(d)$, all dynamical moves are local; this is why we introduced it in the first place. The idea is then to prove that, under the condition $\{\forall t \in [0, T_0], \gamma_t \in N\mathcal{E}_r(d)\}$, for $d > 0$ henceforth fixed, one can turn the contour dynamics into a local dynamics inside $N\mathcal{E}_r(d)$. This is the content of the following lemma. Since the proof is quite general, we postpone it to Appendix A.2.

Lemma 6.3 (Projection onto a local dynamics in the effective state space $N\mathcal{E}_r(d)$). *Let $\psi : [0, T_0] \times X_r^N \rightarrow \mathbb{R}$ be bounded. Then, for some $C > 0$:*

$$\begin{aligned} \frac{1}{N} \log \mathbb{E}_{r,\beta}^N \left[\mathbf{1}_{\{\forall t \in [0, T_0], \gamma_t \in N\mathcal{E}_r(d)\}} \exp \left[N \int_0^{T_0} \psi(t, \gamma_t) dt \right] \right] \\ \leq C\beta + \int_0^{T_0} \sup_{f \geq 0: \nu_f(N\mathcal{E}_r(d))=1} \left\{ \mathbb{E}_{\nu_f} [\psi(t, \cdot)] - ND_N(f) \right\} dt. \end{aligned} \quad (6.16)$$

The result is also valid with the weaker condition $\{\forall t \in [0, T_0], \gamma_t \in N\mathcal{E}_r\}$ provided D_N is replaced by D_N^S , the Dirichlet form of all SSEP jumps, i.e. D_N without the regrowth/deletion jumps at the poles corresponding to line 2 of (2.11).

Remark 6.4. Equation (6.16) looks like a standard Feynman-Kac estimate. Note however that the supremum in (6.16) is on densities with full support in $N\mathcal{E}_r(d)$. In general, if f is a ν -density, there is no way to control $D_N(f)$ by $D_N(f\mathbf{1}_{N\mathcal{E}_r(d)})$. Indeed, if $\tilde{f} = f\mathbf{1}_{N\mathcal{E}_r(d)}$, $D_N(\tilde{f})$ contains terms of the form:

$$\sum_{\substack{\gamma \in N\mathcal{E}_r(d) \\ \gamma' \notin N\mathcal{E}_r(d)}} [\nu(\gamma)c(\gamma, \gamma')f(\gamma) + \nu(\gamma')c(\gamma', \gamma)f(\gamma)],$$

which have a priori no reason to be comparable to differences $[f(\gamma)^{1/2} - f(\gamma')^{1/2}]^2$.

Note also that Lemma 6.3 is not a statement about the contour dynamics conditioned to stay inside $N\mathcal{E}_r(d)$, but about the full dynamics. This is an important point: the jump rates of a conditioned dynamics would be non-local, whereas we really need locality to later project the dynamics onto 1-dimensional particle dynamics. \blacksquare

6.2.2 The $\mathbf{1}_{p=2}$ term coincides with the slope around the pole

The argument presented here is the same as for a SSEP with a reservoir. Indeed, informally, one can think of the contour dynamics as four SSEP connected by four point-like reservoirs, as explained in the proof of Lemma 6.5 below. As poles move, the lengths of these SSEP change; however this does not change the average density around the pole much. The key observation is the fact that $\mathbf{1}_{p=2}$ coincides with the occupation number of the closest site to the reservoir in these SSEP.

Lemma 6.5. *Recall the notations of Proposition 2.2. For each $\delta > 0$ and each $G \in \mathcal{C}$, the slope on each side of the pole satisfies a one block estimate:*

$$\limsup_{k \rightarrow \infty} \limsup_{N \rightarrow \infty} \frac{1}{N} \log \mathbb{P}_{r,\beta}^N \left(\forall t \in [0, T_0], \gamma_t \in N\mathcal{E}_r; \left| \frac{1}{T_0} \int_0^{T_0} G(t, L_1(t)/N) (\mathbf{1}_{p=2} - \xi_{L_1+2e_1}^{\pm, k}) dt \right| \geq \delta \right) = -\infty, \quad (6.17)$$

and a two block estimate:

$$\limsup_{\varepsilon \rightarrow 0} \limsup_{N \rightarrow \infty} \frac{1}{N} \log \mathbb{P}_{r,\beta}^N \left(\forall t \in [0, T_0], \gamma_t \in N\mathcal{E}_r; \left| \frac{1}{T_0} \int_0^{T_0} G(t, L_1(t)/N) (\mathbf{1}_{p=2} - \xi_{L_1+2e_1}^{\pm, \varepsilon N}) dt \right| \geq \delta \right) = -\infty. \quad (6.18)$$

Both estimates are valid under $\mathbb{P}_{r,\beta,H}^N$, with the same proof as for Lemma 6.1.

The proof of Lemma 6.5 is used to showcase the connection between the contour dynamics and the SSEP at the microscopic level, that is used numerous times in this article.

Proof. The proof relies on the key observation that the quantity $\mathbf{1}_{p=2}$ can be controlled by the edges of the poles:

$$\mathbf{1}_{p=2} = \xi_{L_1+2e_1} = \xi_{R_1-3}, \quad (6.19)$$

where we abuse notations and denote by $R_1 - 3$ the vertex at distance three from R_1 anticlockwise. In other words, $\mathbf{1}_{p=2}$ can be thought of as the occupation number of the closest site to a reservoir in a

SSEP, in which case (6.17)-(6.18) are well-known (see [ELS90]). We first prove (6.17). Building on the observation (6.19), define ϕ as the function:

$$\forall \gamma \in X_r^N, \quad \phi(\gamma) = \xi_{L_1+2e_1} - \xi_{L_1+2e_1}^{+,k}. \quad (6.20)$$

Let us slightly rewrite the probability in (6.17): it is enough to estimate, for each $a > 0$, the quantity:

$$\begin{aligned} & \mathbb{P}_{r,\beta}^N \left(\forall t \in [0, T_0], \gamma_t \in N\mathcal{E}_r; \exp \left[aN \int_0^{T_0} G(t, L_1(t)/N) \phi(\gamma_t) dt \right] \geq \exp[aNT_0\delta] \right) \\ & \leq e^{-aNT_0\delta} \mathbb{E}_{r,\beta}^N \left[\mathbf{1}_{\{\forall t \in [0, T_0], \gamma_t \in N\mathcal{E}_r\}} \exp \left[aN \int_0^{T_0} \mathbf{1}_{N\mathcal{E}_r} G(t, L_1(t)/N) \phi(\gamma_t) dt \right] \right]. \end{aligned} \quad (6.21)$$

Let $D_N^S \leq D_N$ be the Dirichlet form of the contour dynamics without the regrowth/deletion terms, i.e. without the jumps of line 2 of (2.11). Apply Lemma 6.3 to $\psi = aG\phi$ to obtain that (6.21) is bounded from above by:

$$-a\delta T_0 + C\beta + \left| \int_0^{T_0} dt \sup_{f \geq 0: \nu_f(N\mathcal{E}_r)=1} \left\{ a\mathbb{E}_{\nu_f} [G(t, L_1/N)\phi] - ND_N^S(f) \right\} \right|. \quad (6.22)$$

Let us now compare the contour dynamics around the north pole to a SSEP. Fix $t \in [0, T_0]$ and a ν -density f with support in $N\mathcal{E}_r$. Denote by (E_f) the expectation in the supremum in (6.22). We first take care of the dependence on L_1 in G , by splitting (E_f) depending on where L_1 lies in Λ_N . Let $M(x) \subset X_r^N$ be all curves with $L_1 + 2e_1 = x \in \Lambda_N$. Then, up to an error $O_G(N^{-1})$ uniform in f :

$$\mathbb{E}_{\nu_f} [G(t, L_1/N)\phi] = \sum_{x \in \Lambda_N} G(t, x/N) \left[\sum_{\gamma \in M(x)} \nu(\gamma) f(\gamma) \phi(\gamma) \right]. \quad (6.23)$$

In the following, for $\gamma \in M(x)$, we refer to the edge $(x, x + e_x^+)$ as edge 1, to the one following it as edge 2, etc, up to edge k , and write $\xi_1(\gamma), \dots, \xi_k(\gamma)$ for the corresponding values of the edge labels (as usual, curves are travelled on clockwise). Notice that all these edges are in the same quadrant (in fact quadrant 1), as we work with curves in $N\mathcal{E}_r$. Indeed, all four quadrants of curves in $N\mathcal{E}_r$ are macroscopic, thus contain much more than k edges, see the definition of \mathcal{E}_r in Appendix B. Configurations in $\{0, 1\}^k =: \Omega_k$, are denoted by the letter ξ . ϕ depends only on the k first edges, so that the expectation in (6.23) reads:

$$\mathbb{E}_{\nu_f} [G(t, L_1/N)\phi] = \sum_{x \in \Lambda_N} \nu_f(M(x)) G(t, x) \frac{1}{|\Omega_k|} \sum_{\xi \in \Omega_k} f_{k,x}(\xi) \phi(\xi), \quad (6.24)$$

where $|\Omega_k| = 2^k$ and if $\xi(\gamma)$ denotes the collection $\xi_1(\gamma), \dots, \xi_k(\gamma)$ for a given $\gamma \in X_r^N$,

$$\forall \xi \in \Omega_k, \quad f_{k,x}(\xi) = \frac{1}{\nu_f(M(x))} \sum_{\gamma \in M(x): \xi(\gamma)=\xi} |\Omega_k| \nu(\gamma) f(\gamma). \quad (6.25)$$

Note that we need only consider points x and densities f with $\nu_f(M(x)) > 0$. This ensures that $f_{k,x}$ is unambiguously defined. Moreover, $f_{k,x}$ is a density for the uniform measure on Ω_k .

Let us do the same operations on the Dirichlet form D_N^S , in order to bound it from below by that of the SSEP on configurations with k sites. Recall the definition of the bulk jump rates of the contour dynamics in (2.6). The mapping to go from part of a curve $\gamma \in N\mathcal{E}_r$ to an associated SSEP configuration $\xi(\gamma) \in \Omega_k$ is represented on Figure 9 for the first quadrant. The idea is to take the portion of γ in quadrant k ,

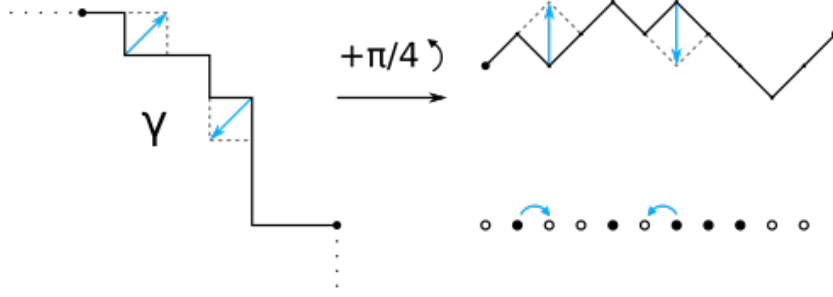

Figure 9: On the left, a portion of the interface delimited by the two black dots. On the right, the corresponding path and simple exclusion particle configuration. The mapping is possible if the left-extremity of the interface as well as its length are fixed.

turn it clockwise by $k\pi/4$, and put a particle at site j whenever the resulting path goes down between $j\sqrt{2}$ and $(j+1)\sqrt{2}$, or no particle if it goes up.

Define thus D_k^S , the Dirichlet form associated with the SSEP on Ω_k : for any density g for the uniform measure U_k on $\Omega_k = \{0, 1\}^k$,

$$D_k^S(g) = \frac{1}{2|\Omega_k|} \sum_{\xi \in \Omega_k} \sum_{\substack{1 \leq u \leq v \leq k \\ |u-v|=1}} \frac{1}{2} [\xi_u(1-\xi_v) + \xi_v(1-\xi_u)] [g^{1/2}(\xi^{u,v}) - g^{1/2}(\xi)]^2.$$

Recalling the definition of $D_N^S(g)$ from Lemma 6.3, a simple upper-bound and convexity yield:

$$\begin{aligned} D_N^S(f) &\geq \frac{1}{2} \sum_{x \in \Lambda_N} \sum_{\gamma \in M(x)} \nu(\gamma) \sum_{y \in V(\gamma): (y, y+e_y^+) \in \{1, \dots, k\}} c(\gamma, \gamma^{y+e_y^+}) [f^{1/2}(\gamma^{y+e_y^+}) - f^{1/2}(\gamma)]^{1/2} \\ &\geq \sum_{x \in \Lambda_N} \nu_f(M(x)) D_k^S(f_{k,x}). \end{aligned} \quad (6.26)$$

The reason, as emphasised in Lemma 6.3, is that the jump rate $c(\gamma, \gamma')$ for all non-vanishing terms in $D_N^S(f)$ is local, in particular all $\gamma^x, x \in V(\gamma)$ are well-defined (i.e. elements of X_r^N) for these jumps. As a result of (6.24)-(6.26), at time $t \in [0, T_0]$ the supremum in (6.22) can be bounded from above by:

$$\begin{aligned} &\sup_{f \geq 0: \nu_f(N\mathcal{E}_r)=1} \left\{ \sum_{x \in \Lambda_N} \nu_f(M(x)) \left[aG(t, x/N) \mathbb{E}_{U_k} [f_{k,x}\phi] - ND_k^S(f_{k,x}) \right] \right\} \\ &\leq \sup_{f \geq 0: \nu_f(N\mathcal{E}_r)=1} \left\{ \sum_{x \in \Lambda_N} \nu_f(M(x)) \sup_{g \geq 0: \mathbb{E}_{U_k}[g]=1} \left\{ aG(t, x/N) \mathbb{E}_{U_k} [g\phi] - ND_k^S(g) \right\} \right\} \\ &\leq \sup_{f \geq 0: \nu_f(N\mathcal{E}_r)=1} \left\{ \sum_{x \in \Lambda_N} \nu_f(M(x)) a|G(t, x/N)| \right\} \sup_{\substack{g \geq 0: \mathbb{E}_{U_k}[g]=1 \\ D_k^S(g) \leq C(a)/N}} |\mathbb{E}_{U_k} [g\phi]|. \end{aligned} \quad (6.27)$$

The conclusion of the proof then follows, since the problem is reduced to a one-block estimate for a SSEP of size k (see [KL99], Chapter 5): the expectation in (6.27) satisfies

$$\limsup_{N \rightarrow \infty} \sup_{\substack{g \geq 0: \mathbb{E}_{U_k}[g]=1 \\ D_k^S(g) \leq C(a)/N}} |\mathbb{E}_{U_k} [g\phi]| = O(k^{-1}).$$

As the first term in the right-hand side of (6.27) is bounded by $a\|G\|_\infty$, the proof of the one block estimate (6.17) is concluded. The two block estimate (6.18) is proven similarly. \square

Now that we know that the time integral of $\mathbf{1}_{p=2}$ and of the slope at the poles are close, it remains to compute their common value. This is the goal of the next two sections.

6.2.3 A compactness result

This section presents microscopic estimates used to control the pole terms. Although technical, it presents the most important result of the article, a control of the value of the $\mathbf{1}_{p=2}$ term, in the sense that the whole large deviation analysis relies on this control.

To compute the time integral of $\mathbf{1}_{p=2}$, we need to zoom in on the dynamics around the pole. As used in the proof of the hydrodynamic limit in [LST14a], in a suitable frame around the pole (the definition of which is one of the difficulties), the height-function describing the interface in time can be interpreted as a kind of two-species zero-range process, in our case with a moving reservoir in the middle. Leaving for later a detailed description of the mapping to the zero-range process and the frame around the pole (see Figure 12), we will have to estimate expectations of the form:

$$\mathbb{E}_{\nu_f}[\mathbf{1}_{p=2}] = \mathbb{E}_{\mu}[\tilde{f}\mathbf{1}_{\eta_{L_1+2e_1} \neq 0}],$$

where f is a density for ν , \tilde{f} its marginal against μ . The measure μ is the marginal of ν on a well-chosen portion of the curve around the pole, in which the interface is described in terms of a particle number η taking values in \mathbb{Z} , corresponding to the height difference between two consecutive columns. \tilde{f} is the marginal of f in this proper frame. To show that the expectation of the right-hand side reduces to an estimate at equilibrium under μ up to a small error term, a compactness argument is typically used to prove that particles do not condensate macroscopically at a single site, as in [KL99], Chapter 5. In our cases, this compactness argument is provided by the following lemmas.

The first estimate concerns the $\mathbf{1}_{p=2}$ term, which as shown in Section 6.2.2 coincides with the slope around each pole. We prove that poles are typically not flat.

Lemma 6.6 (Upper bound on the slope). *For $\gamma \in X_r^N$, $\gamma = \partial\Gamma$, let $p'(\gamma)$ be the number of blocks in Γ composing the level below the north pole. If $C > 0$ and $A \geq 2$ is an integer:*

$$\limsup_{N \rightarrow \infty} \sup_{f: D_N(f) \leq C/N} \nu_f(V_r(2), p' \geq A) \leq \frac{1}{\log A}, \quad (6.28)$$

with $V_r(2) = \{p = 2, V_r\}$, and V_r defined in (2.9). In particular:

$$\limsup_{N \rightarrow \infty} \sup_{f: D_N(f) \leq C/N} \nu_f(V_r(2)) \leq \frac{2}{\beta}. \quad (6.29)$$

Proof. Fix a density f with $D_N(f) \leq C/N$. Notice that $p' \geq p$, the number of blocks in the pole, by definition of X_r^N . The idea is to estimate $\nu_f(p = 2, V_r, p' \geq A)$ for $A \geq 2$ in terms of $\nu_f(p = A, V_r)$, using the fact that:

$$\sum_{B \geq 2} \nu_f(p = B, V_r) \leq 1. \quad (6.30)$$

To do so, we use a bijection argument similar to the one in Lemma 6.2. Fix $A \geq 2$, take γ in $\{p = 2, V_r, p' \geq A\}$, and turn it into an element $F(\gamma)$ of $\{p = A, V_r\}$ as follows. Add as many blocks as possible to the left of the north pole of γ at the height of the pole. If $A - 2$ such blocks can be added, an element of $\{p = A, V_r\}$ has been created. If $B < A - 2$ blocks only can fit to the left of the pole, add

the remaining $A - 2 - B$ blocks to the right of the pole.

This procedure is nearly bijective in the following sense. Label the columns corresponding to blocks of the level below the pole from 1 to p' , starting from the left.

- If the pole of $\gamma \in \{p = 2, V_r, p' \geq A\}$ is above the blocks with labels $k, k + 1$ with $1 \leq k \leq A - 1$, which we write $P = \{k, k + 1\}$, then the procedure described above yields the same $F(\gamma) \in \{p = A, V_r\}$ for each k , and this $F(\gamma)$ is the curve with a pole composed of the blocks $1, \dots, A$. Let $\{P = \{1, \dots, A\}\}$ refer to the set of such $F(\gamma)$.
- If instead the pole of γ starts at column $k \geq A$, which we write $P \geq A$, then the resulting curve $F(\gamma)$ has a pole starting at $k - (A - 2) > 1$, and it is bijectively mapped into γ by inverting the above procedure.

In terms of the mapping F , the previous two cases can be rewritten as:

$$\forall k \leq A - 1, \quad F(\{p = 2, V_r, p' \geq A, P = \{k, k + 1\}\}) = \{V_r, p = A, P = \{1, \dots, A\}\}$$

and:

$$F(\{p = 2, V_r, p' \geq A, P \geq A\}) = \{P \geq 2, V_r, p = A\}.$$

Notice moreover that the mapping F leaves the equilibrium measure ν invariant, since the length of $\gamma \in X_r^N$ and $F(\gamma)$ are the same. Overall, writing also $\{P \leq k\}$ for the event that the pole starts at or before column k , we obtain for the equilibrium measure ν :

$$\begin{aligned} \nu(V_r(2), p' \geq A) &= \nu(P \leq A - 1, p = 2, V_r, p' \geq A) + \nu(P \geq A, p = 2, V_r, p' \geq A) \\ &= (A - 1)\nu(P = \{1, \dots, A\}, V_r) + \nu(P \geq 2, p = A, V_r) \leq (A - 1)\nu(p = A, V_r). \end{aligned} \quad (6.31)$$

Let us prove that, up to an error that vanishes for N large, (6.31) holds also under ν_f for any ν -density f with $D_N(f) \leq C/N$. The idea is that the mapping F described above for $\gamma \in \{V_r(2), p' \geq A\}$ requires a number of moves that is independent of N , so $f(\gamma)$ and $f(F(\gamma))$ are close.

We prove it for the $\{P = \{1, \dots, A\}, V_r\}$ term in (6.31), the $P \geq 2$ term is similar. We proceed as in Lemma 6.2.

$$\begin{aligned} (A - 1)\nu_f(P = \{1, \dots, A\}, V_r) &= (A - 1) \sum_{\gamma' \in F(\{P \leq A - 1, p = 2, V_r, p' \geq A\})} \nu(\gamma') f(\gamma') \\ &= \sum_{\gamma' \in F(\{P \leq A - 1, p = 2, V_r, p' \geq A\})} \nu(\gamma') f(\gamma') \sum_{\gamma \in V_r(2), P \leq A - 1, p' \geq A} \mathbf{1}_{F(\gamma) = \gamma'} \\ &= \sum_{\gamma \in V_r(2), P \leq A - 1, p' \geq A} \nu(\gamma) f(F(\gamma)). \end{aligned} \quad (6.32)$$

The second line comes from the fact that F maps exactly $A - 1$ elements of $\{P \leq A - 1, p = 2, V_r, p' \geq A\}$ onto the same curve in $\{P = \{1, \dots, A\}, V_r\}$. The third line uses the fact that F does not change the measure ν . The notation $V_r(2)$ stands for $V_r \cap \{p = 2\}$. One has:

$$\begin{aligned} (6.32) &= \sum_{\gamma \in V_r(2), P \leq A - 1, p' \geq A} \nu(\gamma) [f^{1/2}(F(\gamma)) - f^{1/2}(\gamma)]^2 - \sum_{\gamma \in V_r(2), P \leq A - 1, p' \geq A} \nu_f(\gamma) \\ &\quad + 2 \sum_{\gamma \in V_r(2), P \leq A - 1, p' \geq A} \nu(\gamma) f^{1/2}(\gamma) f^{1/2}(F(\gamma)). \end{aligned}$$

Applying Cauchy-Schwarz inequality yields:

$$\begin{aligned} & [(A-1)^{1/2}\nu_f(P = \{1, \dots, A\}, V_r)^{1/2} - \nu_f(P \leq A-1, V_r(2), p' \geq A)^{1/2}]^2 \\ & \leq \sum_{\gamma \in V_r(2), P \leq A-1, p' \geq A} \nu(\gamma) [f^{1/2}(F(\gamma)) - f^{1/2}(\gamma)]^2. \end{aligned} \quad (6.33)$$

It remains to bound the right-hand side of (6.33) from above in terms of the Dirichlet form. Decompose the passage from γ to $F(\gamma)$ in single-block flips: $\gamma = \gamma_0 \rightarrow \gamma_1 \rightarrow \dots \rightarrow \gamma_{A-2} = F(\gamma)$, and apply Cauchy-Schwarz inequality to find:

$$\sum_{\gamma \in V_r(2), P \leq A-1, p' \geq A} \nu(\gamma) [f^{1/2}(F(\gamma)) - f^{1/2}(\gamma)]^2 \leq (A-2) \sum_{\gamma \in V_r(2), P \leq A-1, p' \geq A} \nu(\gamma) \sum_{k=1}^{A-2} [f^{1/2}(\gamma_{k+1}) - f^{1/2}(\gamma_k)]^2.$$

Each move above is authorised in the contour dynamics, at rate $1/2$. A given curve corresponding to one of the γ_k can occur at most $A-1$ times in all paths $\gamma \rightarrow F(\gamma)$ for $\gamma \in \{V_r(2), P \leq A-1\}$. As a result, and since $\nu(\gamma_k) = \nu(\gamma)$ for all $k \leq A-2$:

$$[(A-1)^{1/2}\nu_f(P = \{1, \dots, A\}, V_r)^{1/2} - \nu_f(P \leq A-1, V_r(2), p' \geq A)^{1/2}]^2 \leq 4(A-1)^2 D_N(f). \quad (6.34)$$

Similar computations give the same kind of bound for the second term in (6.31) under ν_f :

$$[\nu_f(1 \notin P, p = A, V_r)^{1/2} - \nu_f(P \geq A, V_r(2))^{1/2}]^2 \leq 4(A-1) D_N(f). \quad (6.35)$$

Let us use (6.34)-(6.35), to prove that (6.31) still holds under ν_f with a small error in N (recall that $D_N(f) \leq C/N$). Equation (6.34) yields:

$$\begin{aligned} \nu_f(V_r(2), P \leq A-1, p' \geq A) & \leq (A-1)\nu_f(P = \{1, \dots, A\}, V_r) + C(A)[D_N(f)^{1/2} + D_N(f)] \\ & \leq (A-1)\nu_f(P = \{1, \dots, A\}, V_r) + C(A)N^{-1/2}, \end{aligned}$$

where the constant $C(A) > 0$ changes between inequalities. Similarly, (6.35) yields:

$$\nu_f(P \geq A, V_r(2)) \leq \nu_f(P \geq 2, p = A, V_r) + C(A)N^{-1/2} \leq (A-1)\nu_f(P \geq 2, p = A, V_r) + C(A)N^{-1/2},$$

whence the following counterpart of (6.31) for ν_f :

$$\nu_f(V_r(2), p' \geq A) = \nu_f(V_r(2), P \leq A-1) + \nu_f(P \geq A, V_r(2)) \leq (A-1)\nu_f(p = A, V_r) + C(A)N^{-1/2}. \quad (6.36)$$

Equation (6.36) is sufficient to conclude the proof of the upper bound in (6.29). Indeed, fix $B \geq 2$ and apply (6.36) to each $A \in \{2, \dots, B\}$ to obtain (recall that $V_r(2) = V_r \cap \{p = 2\}$):

$$1 \geq \sum_{A=2}^B \nu_f(p = A, V_r) \geq \sum_{A=2}^B \frac{1}{A-1} \nu_f(V_r(2), p' \geq A) + O(N^{-1/2}). \quad (6.37)$$

For $\ell \geq 2$, let $H_\ell = \sum_{k=2}^\ell (k-1)^{-1}$, $H_1 := 0$ and integrate the right-hand side of (6.37) by parts to find:

$$1 \geq \nu_f(p = 2, V_r, p' \geq B)H_B + \sum_{A=2}^{B-1} H_A \nu_f(V_r(2), p' = A) + O(N^{-1/2}).$$

Equation (6.28) follows:

$$\limsup_{N \rightarrow \infty} \nu_f(p = 2, V_r, p' \geq B) \leq H_B^{-1} \leq \frac{1}{\log B}. \quad (6.38)$$

From (6.38) we conclude the proof of Lemma 6.6 using again the correspondence of Lemma 6.2:

$$\begin{aligned} \nu_f(V_r(2)) &= \nu_f(p = 2, V_r) = \nu_f(p = 2, V_r, p' \geq e^\beta) + \nu_f(p = 2, V_r, p' \leq e^\beta - 1) \\ &\leq \frac{1}{\beta} + \mathbb{E}_{\nu_f}[e^{-2\beta}(p-1)\mathbf{1}_{I_r, p \leq e^\beta - 1}] + O(N^{-1/2}) \\ &\leq \frac{1}{\beta} + e^{-\beta}(1 - e^{-\beta} + O(N^{-1/2})) \leq \frac{2}{\beta} + O(N^{-1/2}), \end{aligned}$$

with I_r defined in (6.5). □

Next, we use Lemma 6.6 to bound the width of the droplet at a given depth below the pole, and its depth at a given width to either side of the pole.

For $\gamma \in X_r^N \cap N\mathcal{E}_r$ and $k \geq 1$, the line $y = y_{\max}(\gamma) - k$ contains a certain number of horizontal edges in γ , where y_{\max} is the ordinate of the highest points in γ . Let $\ell(k)$ be the number of these edges to the right of L_1 , and $\ell(-k)$ the number to the left of L_1 . Define also $\ell(0) = p(\gamma) - 2$. For N large enough, because $\gamma \in N\mathcal{E}_r$ each of the $\ell(i)$, $|i| \leq k$ are well defined and the corresponding edges are in quadrant 4 ($i \leq 0$) or quadrant 1 ($i \geq 0$) (see Figure 10).

Lemma 6.7 (Width of a curve at depth k below the north pole). *For $k \in \mathbb{N}^*$, $C > 0$, $A \geq 2$,*

$$\forall |i| \leq k, \quad \limsup_{N \rightarrow \infty} \sup_{f: D_N(f) \leq C/N} \nu_f(N\mathcal{E}_r(d), \ell(i) \geq A) \leq \frac{e^{2\beta}}{(A+1)\log(A+2)}. \quad (6.39)$$

As a result, the numbers $w_k^+ = 2 + \sum_{i=0}^k \ell(i)$ and $w_k^- = \sum_{i=1}^k \ell(-i)$ of blocks with centres at height $y_{\max}(\gamma) - k - 1/2$ in a droplet $\Gamma \in N\mathcal{E}_r$, respectively to the right/to the left of L_1 , satisfy:

$$\limsup_{N \rightarrow \infty} \sup_{f: D_N(f) \leq C/N} \nu_f(N\mathcal{E}_r(d), w_k^\pm \geq k^2) \leq \frac{3e^{2\beta}}{\log k}. \quad (6.40)$$

Proof. Equation (6.40) follows from (6.39) by a union bound. Let us prove (6.40) by recursion on $|i| \leq k$. For $\ell(0)$, recall from Lemma 6.2 that, uniformly on ν -densities f with $D_N(f) \leq C/N$:

$$\begin{aligned} \nu_f(p = 2, V_r, p' \geq A+2) &= \mathbb{E}_{\nu_f}[(p-1)\mathbf{1}_{I_r} e^{-2\beta} \mathbf{1}_{p \geq A+2}] + o_N(1) \\ &= \mathbb{E}_{\nu_f}[(\ell(0)+1)\mathbf{1}_{I_r} e^{-2\beta} \mathbf{1}_{\ell(0) \geq A}] + o_N(1), \end{aligned} \quad (6.41)$$

V_r is defined in (2.9) and I_r in (6.5). In view of the following:

$$(A+1)\nu_f(N\mathcal{E}_r(d), \ell(0) \geq A) \leq e^{2\beta} \mathbb{E}_{\nu_f}[(\ell(0)+1)\mathbf{1}_{I_r} e^{-2\beta} \mathbf{1}_{\ell(0) \geq A}],$$

Equation (6.39) follows for $i = 0$ via (6.41):

$$(A+1)\nu_f(N\mathcal{E}_r(d), \ell(0) \geq A) \stackrel{(6.39)}{\leq} e^{2\beta} \nu_f(p = 2, V_r, p' \geq A+2) + o_N(1) \stackrel{(6.38)}{\leq} \frac{e^{2\beta}}{\log(A+2)} + o_N(1).$$

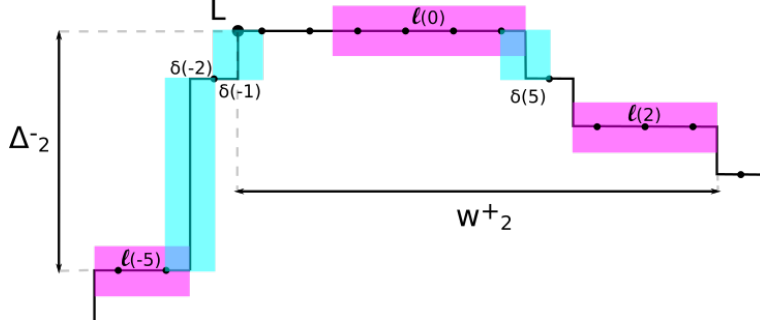

Figure 10: Definition of the $\delta(\pm i), \ell(\pm i), \Delta_k^\pm, w_k^\pm$. The small black dots mark the centre of each column, the shaded areas are blocks in columns/lines constituting one of the pictured $\ell(\pm i), \delta(\pm i)$. Here, $\ell(-2) = \delta(-3) = 0$.

Now assume the result holds for $|i| < k$. To show it for e.g. $i + 1$, we are going to prove:

$$\nu_f(N\mathcal{E}_r(d), \ell(i + 1) \geq A) = \nu_f(N\mathcal{E}_r(d), \ell(i + 1) \geq 0, \ell(i) \geq A) + O(D_N(f)^{1/2} + D_N(f)). \quad (6.42)$$

The argument is very similar to the one used in the proof of Lemma 6.6. Consider the event $\{\ell(i+1) \geq A\}$ and a curve γ in this event. This time, instead of adding blocks to the pole, we add A blocks to line i below the pole of γ (see Figure 10 for a representation of $\ell(i)$) to obtain a curve $F(\gamma)$. By this procedure, $\{\ell(i + 1) \geq A\}$ is sent onto $\{\ell(i) \geq A\}$, and both γ and $F(\gamma)$ have the same ν -measure.

The procedure $\gamma \rightarrow F(\gamma)$ requires A SSEP moves, corresponding to flipping blocks of line i one after the other. None of these break any constraints involved in the definition of $N\mathcal{E}_r(d)$, so that in fact:

$$F(\{N\mathcal{E}_r(d), \ell(i + 1) \geq A\}) = \{N\mathcal{E}_r(d), \ell(i) \geq A\}.$$

Moreover, each curve in the chain $\gamma_1 = \gamma \rightarrow \dots \rightarrow \gamma_f = F(\gamma)$ appears at most $A + 1$ times when effecting the procedure for all curves in $\{N\mathcal{E}_r(d), \ell(i + 1) \geq A\}$. The difference of the square roots of the two probabilities appearing in (6.42) is thus bounded by $C(A)D_N(f)$, which completes the proof of (6.42), thus of Lemma 6.7. \square

Lemma 6.7 gives a bound on the width of a curve below its pole. Let us now show that, at distance $k \geq 1$ to the right or to the left of the north pole, the height cannot be too big as a function of k . To do so, for $k \in \mathbb{N}^*$ and $|i| \leq k$, define $\delta(i)$ as the absolute value of the height difference between columns i and $i + 1$, fixing $\delta_0 = 0$ to be the height difference of the columns with left extremities L_1 and $L_1 + e_1$ respectively (see Figure 10). Note the different choice in labels of the δ 's compared to the ℓ 's to mark the symmetry between quadrants 1 and 4.

Lemma 6.8 (Height of a column at fixed distance to the pole). *For $k \in \mathbb{N}^*$ and each $C > 0, A \geq 1$,*

$$\forall 1 \leq i, j \leq k, \quad \limsup_{N \rightarrow \infty} \sup_{f: D_N(f) \leq C/N} \nu_f(N\mathcal{E}_r(d), \delta(i) \geq A, \delta(-j) \geq A) \leq e^{-2\beta(A-1)}. \quad (6.43)$$

Let $\Delta_k^\pm = \sum_{i=1}^k \delta(\pm i)$ be the heights that a curve has gone down after k horizontal steps on either side of L_1 . Then ($\beta > 1$):

$$\limsup_{N \rightarrow \infty} \sup_{f: D_N(f) \leq C/N} \nu_f(N\mathcal{E}_r(d), \Delta_k^+ \geq k(1 + \log k), \Delta_k^- \geq k(1 + \log k)) \leq \frac{1}{k^{2\beta-2}} = o_k(1). \quad (6.44)$$

Proof. Equation (6.44) follows from (6.43) by a union bound. To prove (6.43), we first treat the case $i = j = 1$. $\{\delta(1) \geq A, \delta(-1) \geq A\}$ is the event that the north pole is atop a column of width 2 and height at least A . With $\gamma \in \{\delta(1) \geq A, \delta(-1) \geq A\}$ associate a curve $G(\gamma) \in \{\delta(1) \geq 1, \delta(-1) \geq 1\}$ in which the north pole has been shrunk $A - 1$ times. $G(\gamma)$ has length $|\gamma| - 2(A - 1)$, thus has higher equilibrium probability. In fact, up to boundary effects in the definition of X_r^N , G is a bijection between the above sets, and:

$$\nu(\delta(1) \geq A, \delta(-1) \geq A) \simeq e^{-2\beta(A-1)} \nu(\delta(1) \geq 1, \delta(-1) \geq 1). \quad (6.45)$$

Equation 6.45 is not an equality because of boundary conditions. Indeed, elements of X_r^N must satisfy $y_{\max} - y_{\min} \geq \lceil Nr \rceil$, with y_{\min} the ordinate of the south pole of a curve, and be subsets of Λ_N . As a result, G is a mapping from X_r^N onto itself provided we write:

$$\{\delta(\pm 1) \geq A, y_{\max} - y_{\min} \geq \lceil Nr \rceil + A - 1\} \xrightarrow{G} \{\delta(\pm 1) \geq 1, y_{\max} \leq N - (A - 1)\}. \quad (6.46)$$

The condition on the first set ensures that deleting $A - 1$ levels of the north pole of one of its element γ still yields a curve $G(\gamma) \in X_r^N$. Conversely, the height of the north pole of $G(\gamma)$ cannot be higher than $N - (A - 1)$, otherwise the original curve γ would have a north pole outside of Λ_N .

The mapping G written as in (6.46) is bijective, and one has:

$$\nu(\delta(\pm 1) \geq A, y_{\max} - y_{\min} \geq \lceil Nr \rceil + A - 1) = e^{-2\beta(A-1)} \nu(\delta(\pm 1) \geq 1, y_{\max} \leq N - (A - 1)). \quad (6.47)$$

In the same way as in Lemma 6.6, (6.47) holds under ν_f for any ν -density f up to a term bounded by $C(A)(D_N(f)^{1/2} + D_N(f))$, quantifying the cost of deleting $A - 1$ lines of the pole of a curve one by one. As a result, if f is a ν -density with $D_N(f) \leq C/N$:

$$\nu_f(\delta(\pm 1) \geq A, y_{\max} - y_{\min} \geq \lceil Nr \rceil + A - 1) \leq e^{-2\beta(A-1)} + O(N^{-1/2}). \quad (6.48)$$

The dependence in A in the error term is not kept, as we choose it independent of N . Each curve involved in these strings of dynamical moves appears at most A times in all the strings of all the curves, hence an error bounded by $C(A)D_N(f)^{1/2}$. As curves in $N\mathcal{E}_r(d)$ satisfy $y_{\min} - y_{\max} \geq 2Nr \geq \lceil Nr \rceil + A - 1$ (opposite poles must be at distance at least $2Nr$), (6.43) holds for $i = j = 1$.

To prove (6.43) for each $(i, j) \in \{1, \dots, k\}$, let us first prove it for $j = 1, i > 1$. One has:

$$\nu_f(N\mathcal{E}_r(d), \delta(i) \geq A, \delta(-1) \geq A) = \nu_f(N\mathcal{E}_r(d), \delta(i-1) \geq A, \delta(-1) \geq A) + o_N(1). \quad (6.49)$$

Indeed, as in Lemma 6.7, a curve with $\delta(i) \geq A$ is transformed into one with $\delta(i-1) \geq A$ by deleting A blocks in column $i - 1$. These SSEP moves do not change the length of the curve, nor do they affect whether a curve is in $N\mathcal{E}_r(d)$ for N large enough, since all blocks involved in the moves are at distance of order Nr to the other quadrants or any pole other than the north pole. Iterating (6.49) from i to 1 and using (6.48) yields (6.43) for the couple $(i, -1)$. Now if $j \neq 1$, the same argument applies to go from $-j$ to -1 . This concludes the proof of (6.43). \square

6.2.4 Value of the slope at the pole

We now have all prerequisites to prove that the motion of the north pole imposes a particle density of $e^{-\beta}$ on each side, as stated in Lemma 6.9. Its proof crucially makes use of the fact that the contour dynamics around the pole is irreducible. This is due to the $e^{-2\beta}$ regrowth jumps allowed in the contour dynamics which means, in particular, that it is not true for the zero temperature stochastic Ising model.

Lemma 6.9. For each $\delta > 0$ and test function $G \in \mathcal{C}$,

$$\limsup_{N \rightarrow \infty} \frac{1}{N} \log \mathbb{P}_{r,\beta}^N \left(\text{for a.e. } t \in [0, T_0], \gamma_t \in N\mathcal{E}_r(d); \left| \frac{1}{T_0} \int_0^{T_0} G(t, L_1(t)/N) (\mathbf{1}_{p=2} - e^{-\beta}) dt \right| \geq \delta \right) = -\infty. \quad (6.50)$$

The claim is also valid under $\mathbb{P}_{r,\beta,H}^N$.

Proof. The proof only deals with $G \equiv 1$ and $H \equiv 0$. Generalisations to $\mathbb{P}_{r,\beta,H}^N$ follow as in the proof of Lemma 6.5, and we explain how to include a test function G in Remark 6.10. Integer parts are systematically omitted.

The proof is structured as follows. We first use Lemma 6.3 to project the dynamics inside $N\mathcal{E}_r(d)$. The compactness results provided by Section 6.2.3 are then incorporated to the probability in (6.50). This enables us to define a proper frame around the pole. After conditioning to this frame, the quantity to estimate in (6.50) can be retrieved from an equilibrium computation, which is the last step of the proof.

Let $\phi = \mathbf{1}_{p=2} - e^{-\beta}$. By Markov inequality and Lemma 6.3, the left-hand side of (6.50) without the limits is bounded from above, for each $a > 0$ by:

$$-a\delta T_0 + C\beta + T_0 \left| \sup_{f \geq 0: \nu_f(N\mathcal{E}_r(d))=1} \left\{ a\mathbb{E}_{\nu_f}[\phi] - ND_N(f) \right\} \right|. \quad (6.51)$$

Step 1: definition of a suitable frame around the pole

The first step consists in writing the expectation in (6.51) as a quantity that depends only on the dynamics around the pole. The idea is to compare the contour dynamics to a zero-range process with two species of particles. The number of particles is given by the height difference between consecutive columns around the pole. The type of particle is determined by the sign of the height difference. This process is irreducible and its invariant measure can be made explicit. More is said on this dynamics below, see also Figure 12. To make such a comparison, we define a frame around the pole without fixing its position, contrary to what was done e.g. in Lemma 6.5. This is done as follows.

Fix an integer k , which will be the typical size of the frame around the pole, and consider the following partition of $X_r^N \cap N\mathcal{E}_r(d)$. For any curve γ , let $h_k(\gamma)$ be the smallest integer such that the number of blocks in Γ (the droplet delimited by γ) with centre at height $y = y_{\max} - h_k(\gamma) - 1/2$ is strictly larger than k (see Figure 11):

$$h_k(\gamma) = \min \{y \in \mathbb{N} : N_y(\gamma) > k\}, \quad (6.52)$$

where:

$$N_y(\gamma) = \#\{\text{blocks in } \Gamma \text{ with centre at height } y_{\max}(\gamma) - y - 1/2\}.$$

Let $x_k(\gamma), y_k(\gamma)$ denote the extremal vertices of the last level of Γ with width smaller than k , and let $\ell_k(\gamma) := \|y_k(\gamma) - x_k(\gamma)\|_1$ be this width, see Figure 11. For fixed $k \in \mathbb{N}^*$ and $2 \leq \ell \leq k$, consider the set:

$$M_\ell = \{\gamma \in X_r^N : \ell_k(\gamma) = \ell\}. \quad (6.53)$$

Then $(M_\ell)_{2 \leq \ell \leq k}$ is a disjoint family, which partitions $X_r^N \cap N\mathcal{E}_r(d)$. This second point comes from the fact that curves in $N\mathcal{E}_r(d)$ have width at least $Nr \geq k$ at some level on each side of L_1 for N large enough. The expectation in (6.51) thus reads, for each ν -density f supported on $N\mathcal{E}_r(d)$:

$$\mathbb{E}_{\nu_f}[\phi] = \sum_{2 \leq \ell \leq k} \mathbb{E}_{\nu_f}[\mathbf{1}_{M_\ell} \phi]. \quad (6.54)$$

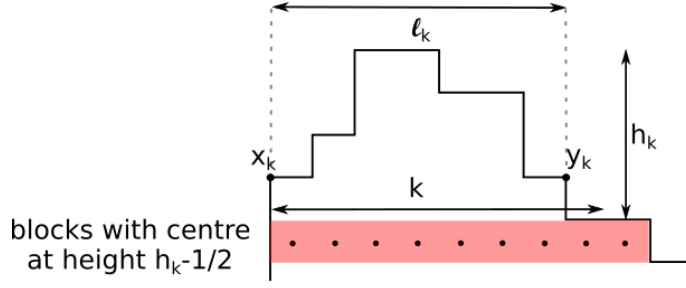

Figure 11: Definition of h_k , ℓ_k and x_k , y_k for a given curve. The first level of blocks with width strictly larger than k corresponds to the filled area, unchanged by the ZRP dynamics. In this case there are $k + 1$ such blocks, with centres indicated by black dots. The width ℓ_k of the last level of width smaller than k is equal here to $k - 1$. The portion of the curve affected by the ZRP dynamics is delimited by dashed lines and the segment $[x_k, y_k]$.

At this point, the splitting of curves in the different M_ℓ in (6.54) suffers from two flaws. On the one hand, the width ℓ , which will correspond to the number of sites in a ZRP, may not be large. This makes a local equilibrium argument impossible to apply. On the other hand, the pole may be macroscopically higher than the points $x_k(\gamma)$, $y_k(\gamma)$. In other words, we must control both the height $h_k(\gamma)$ below the pole and the width $\ell_k(\gamma)$ in terms of k . Lemmas 6.7-6.8 enable such a control, as we now explain.

Consider first the height $h_k(\gamma)$, defined in (6.52). Then either $h_k(\gamma) = 0$, which corresponds to having a pole size $p(\gamma) \geq k$, or $h_k(\gamma) > 1$ and the level at height $h_k(\gamma) - 1$ below the pole has width strictly smaller than k , thus has width smaller than k on both sides of L_1 . Recalling from Lemma 6.8 that $\Delta_k^\pm(\gamma)$ is the depth at horizontal distance k on either side of the pole, we find:

$$h_k(\gamma) \leq \min \{ \Delta_k^+(\gamma), \Delta_k^-(\gamma) \}.$$

Lemma 6.8 then yields, for each $C > 0$:

$$\limsup_{N \rightarrow \infty} \sup_{f: D_N(f) \leq C/N} \nu_f(N\mathcal{E}_r(d), h_k \geq k(1 + \log k)) = o_k(1). \quad (6.55)$$

We now turn to the width $\ell_k = \ell_k(\gamma)$ of the level at height h_k below the pole. Recalling the definition of the widths w^\pm from Lemma 6.7, notice first the identity:

$$\forall \gamma \in X_r^N \cap N\mathcal{E}_r(d), \quad \ell_k(\gamma) = w_{h_k(\gamma)}^+ + w_{h_k(\gamma)}^-. \quad (6.56)$$

Let $a_k > 0$ to be chosen later, fix $C > 0$ and a ν -density f with $D_N(f) \leq C/N$. According to (6.56), one has for instance:

$$\nu_f(N\mathcal{E}_r(d), \ell_k \leq a_k) \leq \nu_f(N\mathcal{E}_r(d), w_{h_k}^- \leq a_k). \quad (6.57)$$

If at level h_k below the pole one has gone left less than a_k times, then one must be below h_k once reaching a distance a_k to the left of the pole, i.e.:

$$w_{h_k}^- \leq a_k \quad \Rightarrow \quad \Delta_{a_k}^- \geq h_k. \quad (6.58)$$

Let us provide a lower bound on h_k , then choose a_k such that the probability of the right-hand side of (6.57) is small. For $b_k > 0$, analogously to (6.58), one has:

$$h_k \leq b_k \quad \Rightarrow \quad w_{b_k+1}^- + w_{b_k+1}^+ > k.$$

By Lemma 6.7, for $b_k = \sqrt{k/2} - 1$:

$$\begin{aligned} \limsup_{N \rightarrow \infty} \sup_{f \geq 0: D_N(f) \leq C/N} \nu_f(N\mathcal{E}_r(d), h_k \leq b_k) \\ \leq \limsup_{N \rightarrow \infty} \sup_{f \geq 0: D_N(f) \leq C/N} \nu_f(N\mathcal{E}_r(d), w_{b_k+1}^\pm \geq k) = o_k(1). \end{aligned} \quad (6.59)$$

As a result, (6.58) implies:

$$\begin{aligned} \limsup_{N \rightarrow \infty} \sup_{f \geq 0: D_N(f) \leq C/N} \nu_f(N\mathcal{E}_r(d), w_{h_k}^- \leq a_k) \\ \leq \limsup_{N \rightarrow \infty} \sup_{f \geq 0: D_N(f) \leq C/N} \nu_f(N\mathcal{E}_r(d), \Delta_{a_k}^- \geq h_k \geq b_k + 1) + o_k(1), \end{aligned} \quad (6.60)$$

where the error term is bounded from above by (6.59). It remains to choose a_k as a function of $b_k + 1 = \sqrt{k/2}$ such that the right-hand side of (6.60) vanishes for large k . By Lemma 6.8, it suffices to take a_k such that $a_k(1 + \log(a_k)) = b_k + 1 = k^{1/2}$, e.g.:

$$a_k = (1/4)k^{1/2} / \log k =: \ell_{\min}(k).$$

With this choice of $a_k = \ell_{\min}(k)$, (6.60) and (6.57) finally yield the desired control on ℓ_k :

$$\limsup_{N \rightarrow \infty} \sup_{f \geq 0: D_N(f) \leq C/N} \nu_f(N\mathcal{E}_r(d), \ell_k \leq \ell_{\min}(k)) = o_k(1). \quad (6.61)$$

We now use equations (6.55)-(6.61) to restrict admissible configurations around the pole, thus concluding the definition of the frame around the pole. Define $h_{\max}(k) := k(1 + \log k)$ and recall that $\ell_{\min}(k) := (1/4)k^{1/2} / \log k$. By the discussion of the previous paragraph, and as $\phi = \mathbf{1}_{p=2} - e^{-\beta}$ is bounded, (6.51) is bounded from above by:

$$-a\delta T_0 + C\beta + T_0 \left| \sup_{f \geq 0: \nu_f(N\mathcal{E}_r(d))=1} \left\{ a \sum_{\ell_{\min}(k) \leq \ell \leq k} \mathbb{E}_{\nu_f} [\mathbf{1}_{M_\ell} \mathbf{1}_{h_k \leq h_{\max}(k)} \phi] - \frac{N}{2} D_N(f) \right\} \right| + \omega_{N,k}, \quad (6.62)$$

where $\omega_{N,k}$ satisfies by (6.55)-(6.61):

$$\limsup_{N \rightarrow \infty} \omega_{N,k} \leq a \|\phi\|_\infty \limsup_{N \rightarrow \infty} \sup_{f: D_N(f) \leq 2\|\phi\|_\infty a/N} \nu_f(N\mathcal{E}_r(d), h_k > h_{\max}(k) \text{ or } \ell_k < \ell_{\min}(k)) = o_k(1).$$

It is thus sufficient to estimate the supremum in (6.62).

Step 2: conditioning and mapping to a two-species zero-range process

We now study the expectation in (6.62) in detail on a given M_ℓ , defined in (6.53), and obtain a local description of the contour dynamics around the pole. We claim that to configurations in M_ℓ corresponds a unique particle configuration in $\Omega_\ell = \mathbb{Z}^{\ell+1}$. The mapping goes as follows. If $\gamma \in M_\ell$, define, for $0 \leq j \leq \ell$, a particle number η_j corresponding to the height increment at column j , with column 0 the one centred on $x_k(\gamma)$, as:

$$\eta_j = \varepsilon_j \sum_{\substack{z \in \Lambda_N: z \cdot e_1 = x(\gamma) \cdot e_1 + j \\ z \cdot e_2 \geq y_{\max}(\gamma) - h_k(\gamma)}} \xi_z, \quad \varepsilon_j = \begin{cases} 1 & \text{if } j \leq L_1 \cdot e_1, \\ -1 & \text{if } j > L_1 \cdot e_1. \end{cases}$$

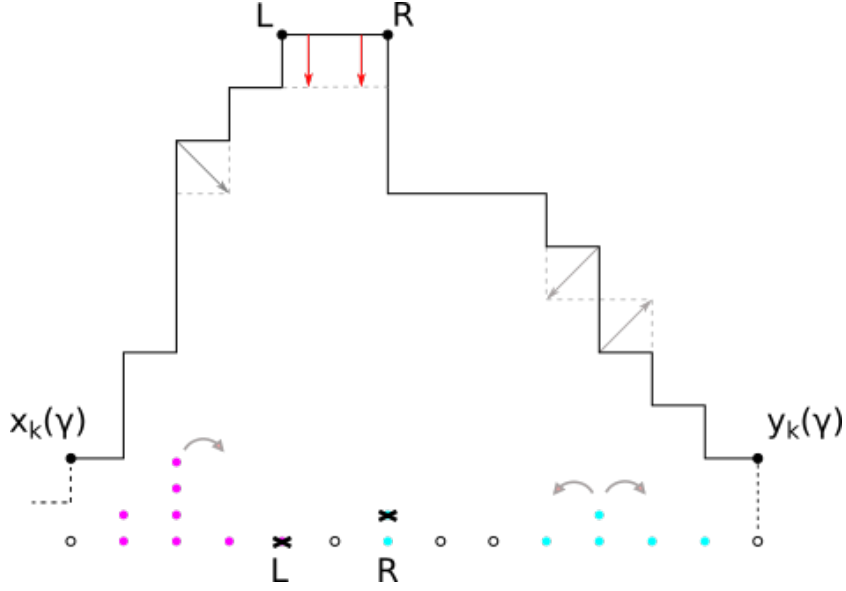

Figure 12: Portion of the interface of a curve around the north pole, and associated path and particle configurations. Particles are in dark dots, antiparticles in light dots, and empty sites are white with a dark contour. The grey arrows on the particle configuration correspond to jumps allowed by the contour dynamics that conserve the particle number. A move reducing the length of the curve, materialised on the curve by the vertical arrows, corresponds to a particle-antiparticle pair annihilation, represented by the black crosses. No particle creation is represented here.

If $\eta_j < 0$ for some j , we say that there are $|\eta_j|$ antiparticles at site j . The constraint $z \cdot e_2 \geq y_{\max}(\gamma) - h(\gamma)$ guarantees that only the vertical edges above the level of $x_k(\gamma), y_k(\gamma)$ are counted as particles. We let $\eta(\gamma)$ denote the unique particle configuration in Ω_ℓ associated with $\gamma \in M_\ell$ (see Figure 12).

In the particle language, h_k corresponds to the number of particles or antiparticles. The event $\{h_k \leq h_{\max}(k)\}$ can thus be recast, for each ℓ , as the event:

$$W^\ell = \{\rho^\ell \leq C_\ell\}, \quad \text{where} \quad \rho^\ell = \frac{1}{\ell+1} \sum_{j=0}^{\ell} |\eta_j|, \quad C_\ell = C_{\ell,k} = \frac{2}{\ell+1} h_{\max}(k) = \frac{2k(1 + \log k)}{\ell+1}. \quad (6.63)$$

Let $\ell \in \{\ell_{\min}(k), \dots, k\}$, f be a ν -density supported on $N\mathcal{E}_r(d)$ with $\nu_f(M_\ell) > 0$, and define:

$$\forall \eta \in \Omega_\ell, \quad \bar{f}_\ell(\eta) = \frac{1}{\nu_f(M_\ell)} \sum_{\gamma \in M_\ell: \eta = \eta(\gamma)} Z_{r,\beta}^{-1} f(\gamma) e^{-\beta|\gamma| + \beta|\eta| + \beta\ell}. \quad (6.64)$$

Define also the probability measure $\bar{\mu}_\ell$:

$$\forall \eta \in \Omega_\ell, \quad \bar{\mu}_\ell(\eta) = \bar{Z}_\ell^{-1} \exp \left[-\beta\ell - \beta \sum_{j=0}^{\ell} |\eta_j| \right], \quad (6.65)$$

where \bar{Z}_ℓ is a normalisation factor, and $\sum_{j=0}^{\ell} |\eta_j| + \ell$ is the length of the path which corresponds to the particle configuration η . Though we could factor it out as it is common to all η , the $e^{-\beta\ell}$ factor in the definition of $\bar{\mu}_\ell$ will be convenient later on. The expectation in (6.62) is recast in terms of particle configurations as follows:

$$\mathbb{E}_{\nu_f} [\mathbf{1}_{M_\ell} \mathbf{1}_{h_k \leq h_{\max}(k)} \phi] = \nu_f(M_\ell) \mathbb{E}_{\bar{\mu}_\ell} [\bar{f}_\ell \mathbf{1}_{W_\ell} \phi], \quad (6.66)$$

so that we know how to estimate the supremum in (6.51) as soon as we can estimate:

$$\sup_{f \geq 0: \nu_f(N\mathcal{E}_r(d))=1} \left\{ \sum_k^{\ell=\ell_{\min}(k)} a \nu_f(M_\ell) \mathbb{E}_{\bar{\mu}_\ell} [\bar{f}_\ell \mathbf{1}_{W_\ell} \phi] - \frac{N}{2} D_N(f) \right\}, \quad \phi = \mathbf{1}_{p=2} - e^{-\beta}. \quad (6.67)$$

Step 3: Local equilibrium

We now prove that estimating the supremum in (6.67) reduces to an equilibrium computation. At this stage, the technique is the same as in [KL99]. Denote by \bar{D}_ℓ the reduced Dirichlet form on Ω_ℓ , defined as follows. For $\eta \in \Omega_\ell$, let $P(\eta)$ denote the pole of η , that is the subset $\{L, \dots, R\}$ of $\{0, \dots, \ell\}$ such that η_L is the last η_j that is strictly positive or $L = 0$ if there are none, η_R the first to be strictly negative or $R = \ell$ if none exist. Let also $p = |P(\eta)| - 1$. For any $\bar{\mu}_\ell$ -density g , define:

$$\bar{D}_\ell(g) = \frac{1}{2} \sum_{\eta, \eta' \in \Omega_\ell} \bar{\mu}_\ell(\eta) c(\eta, \eta') [g^{1/2}(\eta') - g^{1/2}(\eta)]^2. \quad (6.68)$$

Importantly, the positions of the extremal sites $0, \ell$ (corresponding for curves γ compatible with a given configuration to the points $x_k(\gamma), y_k(\gamma)$) are unchanged by the dynamics. This is because the ZRP dynamics only acts on the portion of γ above $x_k(\gamma), y_k(\gamma)$. In particular, the first level of γ with width strictly larger than k , which defines the position of $x_k(\gamma), y_k(\gamma)$, is never modified.

In (6.68), we abuse notations and still write $c(\cdot, \cdot)$ for the jump rates of the ZRP moves corresponding to moves on the contour dynamics. This is legitimate, since if f is a ν -density supported on $N\mathcal{E}_r(d)$, any jump featured in $\bar{D}_\ell(\bar{f}_\ell)$ is an allowed jump for D_N with the same rate by definition of $N\mathcal{E}_r(d)$. Convexity then yields:

$$D_N(f) \geq \sum_{\ell=\ell_{\min}(k)}^k \nu_f(M_\ell) \bar{D}_\ell(\bar{f}_\ell). \quad (6.69)$$

Reinjecting (6.69) into the supremum in (6.67), we see that it is enough to estimate:

$$\sup_{f \geq 0: \nu_f(N\mathcal{E}_r(d))=1} \left\{ \sum_{\ell=\ell_{\min}(k)}^k \nu_f(M_\ell) \left[a \mathbb{E}_{\bar{\mu}_\ell} [\bar{f}_\ell \mathbf{1}_{W_\ell} \phi] - \frac{N}{2} \bar{D}_\ell(\bar{f}_\ell) \right] \right\}. \quad (6.70)$$

We are nearly done with conditioning to a frame where we can compute the expectation in (6.70). The remaining step is to reduce the state space $\Omega_\ell = \mathbb{Z}^{\ell+1}$ to something that is compact. By definition of $\bar{f}_\ell, \bar{\mu}_\ell, \bar{D}_\ell$ in (6.64)-(6.65)-(6.68) respectively, the process is painless: it is enough to delete all jumps that increase the number of particles above what is authorised by W_ℓ (defined in (6.71)). Indeed, define μ_ℓ as a measure on W_ℓ as follows:

$$\forall \eta \in W_\ell = \left\{ \rho^\ell \leq C_\ell =: \frac{2h_{\max}(k)}{\ell+1} \right\}, \quad \mu_\ell(\eta) := Z_\ell^{-1} \exp \left[-\beta \ell - \beta \sum_{j=0}^{\ell} |\eta_j| \right] = \frac{\bar{Z}_\ell}{Z_\ell} \bar{\mu}_\ell(\eta), \quad (6.71)$$

where Z_ℓ is a normalisation factor on W_ℓ . The marginal \bar{f}_ℓ is correspondingly modified into a μ_ℓ -density f_ℓ :

$$\forall \eta \in W_\ell, \quad f_\ell(\eta) := \frac{Z_\ell}{\bar{Z}_\ell \mathbb{E}_{\bar{\mu}_\ell} [\bar{f}_\ell \mathbf{1}_{W_\ell}]} \bar{f}_\ell(\eta).$$

Finally, the Dirichlet form D_ℓ for the reduced dynamics (written here in compact form) reads, for any μ_ℓ -density g :

$$D_\ell(g) = \sum_{\eta, \eta' \in W_\ell} c(\eta, \eta') [g^{1/2}(\eta') - g^{1/2}(\eta)]^2. \quad (6.72)$$

Since we simply restricted allowed jumps, one has $\bar{D}_\ell(\bar{f}_\ell) \geq D_\ell(f_\ell)\mathbb{E}_{\bar{\mu}_\ell}[\bar{f}_\ell \mathbf{1}_{W_\ell}]$. Under μ_ℓ , the quantity (6.70) to estimate is then bounded from above by:

$$\begin{aligned} & \sup_{f \geq 0: \nu_f(N\mathcal{E}_r(d))=1} \left\{ \sum_{\ell=\ell_{\min}(k)}^k \nu_f(M_\ell)\mathbb{E}_{\bar{\mu}_\ell}[\bar{f}_\ell \mathbf{1}_{W_\ell}] \left[a\mathbb{E}_{\mu_\ell}[f_\ell \phi] - \frac{N}{2}D_\ell(f_\ell) \right] \right\} \\ & \leq a \sup_{f \geq 0: \nu_f(N\mathcal{E}_r(d))=1} \left\{ \sum_{\ell=\ell_{\min}(k)}^k \nu_f(M_\ell)\mathbb{E}_{\bar{\mu}_\ell}[\bar{f}_\ell \mathbf{1}_{W_\ell}] \left[\sup_{\substack{g \geq 0: \mathbb{E}_{\mu_\ell}[g]=1 \\ D_\ell(g) \leq 2a\|\phi\|_\infty/N}} \mathbb{E}_{\mu_\ell}[g\phi] \right] \right\}, \end{aligned} \quad (6.73)$$

The proof of Lemma 6.9 will therefore be concluded if we can prove that, for fixed k and N large, the supremum on g in the right-hand side of (6.73) is bounded by $o_k(1)$ uniformly in $\ell \leq \ell_{\max}(k)$.

Fix $\ell \in \{k, \dots, \ell_{\max}(k)\}$. As W_ℓ is compact, the supremum on g in (6.73) is achieved by a density g_ℓ^N for each N . Up to taking a subsequence, by lower semi-continuity of D_ℓ and continuity of the expectation in (6.73) w.r.t weak convergence, we can take the large N limit and restrict ourselves to studying:

$$\sup_{g^\infty: D_\ell(g^\infty)=0} \mathbb{E}_{\mu_\ell}[g^\infty \phi].$$

By definition of D_ℓ , the corresponding dynamics is irreducible on W_ℓ . This is the major difference between the contour dynamics and the 0-temperature stochastic Ising model, which motivated the introduction of the temperature-like parameter β to allow for regrowth. Irreducibility means that any g^∞ satisfying $D_\ell(g^\infty) = 0$ is constant equal to 1, and we are left with the estimate of:

$$\mathbb{E}_{\mu_\ell}[\phi] \quad \text{with} \quad \phi = \mathbf{1}_{p=2} - e^{-\beta}. \quad (6.74)$$

Step 4: equilibrium large deviations and surface tension

The expectation (6.74) is taken under the equilibrium measure of the zero-range dynamics. Properties of the measure μ_ℓ are analysed in Appendix A.3. In particular, it is proven there that:

$$\lim_{k \rightarrow \infty} \sup_{\ell_{\min}(k) \leq \ell \leq k} \mathbb{E}_{\mu_\ell}[\phi] = 0. \quad (6.75)$$

Equation (6.75) concludes the proof of Lemma 6.9 with $G \equiv 1$. □

Remark 6.10. Lemma 6.9 holds for any test function $G \in \mathcal{C}$ and not just $G \equiv 1$: for each $\delta > 0$,

$$\limsup_{\varepsilon \rightarrow 0} \limsup_{N \rightarrow \infty} \frac{1}{N} \log \mathbb{P}_{r,\beta}^N \left(\forall t \in [0, T_0], \gamma_t \in N\mathcal{E}_r(d); \left| \frac{1}{T_0} \int_0^{T_0} G(t, L_1(t)) (\mathbf{1}_{p=2} - e^{-\beta}) dt \right| \geq \delta \right) = -\infty.$$

This is proven in the same way as Lemma 6.9, except that curves are further conditioned by fixing the point $x_k(\gamma)$, which is the left extremity of the interval $\{0, \dots, \ell = \|y_k(\gamma) - x_k(\gamma)\|_1\}$ for a curve γ . The expectation in (6.62) becomes, for each $t \leq T_0$ and ν -density f supported in $N\mathcal{E}_r(d)$:

$$\begin{aligned} & \sum_{\ell_{\min}(k) \leq \ell \leq k} \mathbb{E}_{\nu_f} [\mathbf{1}_{M_\ell} \mathbf{1}_{h_k \leq h_{\max}(k)} \phi G(t, L_1/N)] \\ & = \sum_{\ell_{\min}(k) \leq \ell \leq k} \sum_{x \in \Lambda_N} \mathbb{E}_{\nu_f} [\mathbf{1}_{M_\ell} \mathbf{1}_{h_k \leq h_{\max}(k)} \mathbf{1}_{x(\gamma)=x} \phi G(t, x/N)] + o_N(1), \end{aligned}$$

with an error term uniform in f . Indeed, the difference between $G(t, L_1/N)$ and $G(x/N)$ is bounded by $N^{-1}(h_{\max}(k) + k)\|\nabla G\|_\infty = o_N(1)$ thanks to the conditions $\ell_k \leq k$, $h_k \leq h_{\max}(k)$.

The position of $x_k(\gamma)$ is unchanged by the ZRP dynamics, see the discussion following (6.68). As such, the rest of the arguments in the proof of Lemma 6.9 go through unchanged, except that one has to rewrite everything with x fixed, e.g. to consider $M_{\ell,x} = M_\ell \cap \{x_k(\gamma) = x\}$ instead of M_ℓ everywhere, and to correspondingly change f_ℓ into $f_{\ell,x}$. The Dirichlet form D_ℓ in (6.68), however, does not depend on x , as in the proof of Lemma 6.5: the ZRP dynamics acts on the local gradients of curves, not on their absolute position. \blacksquare

The method of proof of Lemma 6.9 can be used to obtain tighter estimates on the slope at the poles. An example is given in the following corollary, used in Appendix B.3 to obtain exponential tightness.

Corollary 6.11 (One and two block estimates for deviations from the average). *For each $\delta, \eta > 0$:*

$$\limsup_{n \rightarrow \infty} \limsup_{N \rightarrow \infty} \frac{1}{N} \log \mathbb{P}_{r,\beta}^N \left(\text{for a.e. } t \in [0, T_0], \Gamma_t \in \mathcal{E}_r(d); \frac{1}{T_0} \int_0^{T_0} \mathbf{1}_{|\xi_{L_1}^{\pm,n} - e^{-\beta}| \geq \delta} dt > \eta \right) = -\infty. \quad (6.76)$$

and:

$$\limsup_{n \rightarrow \infty} \limsup_{\varepsilon \rightarrow 0} \limsup_{N \rightarrow \infty} \frac{1}{N} \log \mathbb{P}_{r,\beta}^N \left(\text{for a.e. } t \in [0, T_0], \Gamma_t \in \mathcal{E}_r(d); \frac{1}{T_0} \int_0^{T_0} \mathbf{1}_{|\xi_{L_1}^{\pm,n} - \xi_{L_1}^{\pm,\varepsilon N}| \geq \delta} dt > \eta \right) \leq -\infty. \quad (6.77)$$

Remark 6.12. Note that $\mathbf{1}_{|\xi_{L_1}^{\pm,n} - e^{-\beta}| \geq \delta}$ is simply a cylindrical function, which has average $o_n(1)$ under the invariant measure ν . Corollary 6.11 thus says no more than the usual replacement lemmas. \blacksquare

Proof. Equation (6.77) is a two block estimate which uses only the SSEP part of the dynamics. The method of proof has already been explained in Lemma 6.5.

Consider instead (6.76). The apparent difference with Lemma 6.9 is that, e.g. for $\xi^{+,n}$, we need to focus on a frame around the pole which, in addition, has at least n edges to the right of the pole. However, this has already been proven to be possible: by (6.59), the event $h_k \geq \sqrt{k/2} - 1$ is typical under ν_f for any f with $D_N(f) \leq C/N$, $C > 0$.

To ensure that there are at least n edges on either side of the pole with probability going to 1 in the large n limit, it remains to choose k such that $(k/2)^{1/2} - 1 \geq n$, i.e. any $k \geq 2(n+1)^2$ works. It is convenient to take k independent from n and have k go to infinity before n . The proof of (6.76) is then reduced, as in Lemma 6.9, to an elementary (though more intricate) equilibrium computation under the measure μ_ℓ , defined in (6.71). \square

A Replacement lemma and projection of the dynamics

A.1 Replacement lemma

In this section, we prove the Replacement Lemma 3.8. Let us first introduce some notations. For each $\varepsilon > 0$ and $x \in [-1, 1]^2$, denote by $B(x, \varepsilon N)$ the subset of Λ_N of points at distance less than εN to x in 1-norm. For $\gamma \in X_r^N$ and $x \in V(\gamma)$, define

$$\phi(\tau_x \gamma) = c_x(\gamma) = \xi_{x+e_x^-} (1 - \xi_x) / 2 + \xi_x (1 - \xi_{x+e_x^-}) / 2.$$

Recall from (3.3) that $\xi_x^{\varepsilon N}$ is the quantity

$$\xi_x^{\varepsilon N} = \frac{1}{2\varepsilon N + 1} \sum_{y \in V(\gamma) \cap B(x, \varepsilon N)} \xi_y,$$

and define, as in Lemma 3.8, the local average of ϕ :

$$\tilde{\phi}(\tau_x \gamma) = \xi_x^{\varepsilon N} (1 - \xi_x^{\varepsilon N}).$$

Let $G \in C(\mathbb{R}_+ \times [-1, 1]^2)$ be a bounded function. By Chebychev exponential inequality and Lemma 6.3, Lemma 3.8 holds if, uniformly on $t > 0$ and for each $a > 0$:

$$\limsup_{\varepsilon \rightarrow 0} \limsup_{N \rightarrow \infty} \sup_{f \geq 0: \nu_f(N\mathcal{E}_r)=1} \left\{ \mathbb{E}_{\nu_f} \left[a \left\{ \frac{1}{|\gamma|} \sum_{x \in V(\gamma)} G(t, x/N) \left[\phi(\tau_x \gamma) - \tilde{\phi}(\xi_x^{\varepsilon N}) \right] \right\}^2 \right] - ND_N^S(f) \right\} = 0. \quad (\text{A.1})$$

Recall that D_N^S is the Dirichlet form of the contour dynamics without the pole terms.

Following [ELS90] and as $\gamma \in X_r^N$ implies $|\gamma| \geq Nr$, it is sufficient to prove the following two estimates.

Lemma A.1. *(One and two block estimates)*

Fix $d > 0$. Let $\varepsilon > 0, k \in \mathbb{N}^*$, and let $(V_j)_{1 \leq j \leq J}$ denote a partition of $\{-\varepsilon N, \dots, \varepsilon N\}$ in J intervals of length k , except maybe the last one that is of size at most $2k$, such that $\max V_j = \min V_{j+1} - 1$ for $j \leq J - 1$. For $\gamma \in X_r^N$, $x \in V(\gamma)$ and $1 \leq j \leq J$, let $V_j(x)$ be the set of vertices in $B(x, \varepsilon N) \cap V(\gamma)$, whose positions relative to x correspond to elements of V_j . Define also:

$$A(\phi, V_j(x)) = \frac{1}{|V_j(x)|} \sum_{y \in V_j(x)} \phi(\tau_y \gamma), \quad \xi^{V_j(x)} = \frac{1}{|V_j(x)|} \sum_{y \in V_j(x)} \xi_y.$$

Then (one block estimate):

$$\limsup_{k \rightarrow \infty} \limsup_{\varepsilon \rightarrow 0} \limsup_{N \rightarrow \infty} \sup_{1 \leq j \leq J} \sup_{f \geq 0: \nu_f(N\mathcal{E}_r)=1} \left\{ a \int d\nu(\gamma) f(\gamma) \frac{1}{|\gamma|} \sum_{x \in V(\gamma)} \left| A(\phi, V_j(x)) - \tilde{\phi}(\xi^{V_j(x)}) \right|^2 - ND_N^S(f) \right\} = 0, \quad (\text{A.2})$$

and (two block estimate):

$$\limsup_{k \rightarrow \infty} \limsup_{\varepsilon \rightarrow 0} \limsup_{N \rightarrow \infty} \sup_{1 \leq b, c \leq J} \sup_{f \geq 0: \nu_f(N\mathcal{E}_r)=1} \left\{ a \int d\nu(\gamma) f(\gamma) \frac{1}{|\gamma|} \sum_{x \in V(\gamma)} \left| A(\phi, V_b(x)) - A(\phi, V_c(x)) \right|^2 - ND_N^S(f) \right\} = 0. \quad (\text{A.3})$$

Proof. All distances are in 1-norm. In this proof as in the proof of Lemma 6.5, it would be sufficient to look at densities supported in $N\mathcal{E}_r$ and not $N\mathcal{E}_r(d)$. We work with $N\mathcal{E}_r(d)$ to provide a unified picture. Fix $\phi \in \{\phi_1, \phi_2\}$ and let $R \in \{0, 1\}$ be its range, i.e. $\phi(\tau_x \gamma)$ depends only on $B(x, R) \cap V(\gamma)$ for $\gamma \in X_r^N, x \in V(\gamma)$. The proof of (A.2)-(A.3) consists in showing that the one and two block estimates for the contour dynamics amount to the same estimates for the SSEP, which are well known [ELS90]. We do it for (A.2), (A.3) is similar. The first step is to discard all points in the sum in (A.2) that are close to the poles, so that the pole dynamics can be neglected.

Define thus, for $u > 0$, the set $W^u(\gamma)$, which contains all points of $V(\gamma)$ at distance at least u from each $L_i, i \in \{1, \dots, 4\}$ (compare with $V^u(\gamma)$, defined in Section 3, which contains points at 1-distance at least u from the poles, and not just their left extremities). For $\gamma \in X_r^N$, as $|\gamma| \geq Nr$,

$$\frac{1}{|\gamma|} \sum_{x \in V(\gamma)} \left| A(\phi, V_j(x)) - \tilde{\phi}(\xi^{V_j(x)}) \right|^2 \leq \frac{1}{Nr} \sum_{x \in W^{\varepsilon N + R + 3}(\gamma)} \left| A(\phi, V_j(x)) - \tilde{\phi}(\xi_x^{V_j(x)}) \right|^2 + Cr^{-1} \|\phi\|_{\infty} \varepsilon. \quad (\text{A.4})$$

The second term in the right-hand side of (A.4) vanishes for ε small, and we now estimate the sum. Let us split the summand in (A.2) between each quadrant. Inside each quadrant, the arguments of Lemma 6.5 will apply to compare the dynamics to a SSEP.

Denote by M_i the set of all maximal self avoiding paths in the i direction (corresponding to quadrant i), for $i \in \{SE, SW, NW, NE\} = \{1, 2, 3, 4\}$ (S means south, E east, etc.), defined as follows. For $\gamma \in X_r^N$, let γ_i denote the part of γ that comprises all vertices between $L_i + 2e_{L_i}^+$ and the vertex before L_{i+1} , these two vertices included (with $L_{4+1} := L_1$). M_i is then defined as the set of all γ_i for $\gamma \in X_r^N$.

With this construction, if in addition $\gamma \in N\mathcal{E}_r \subset N\mathcal{E}_r(d)$, if $\gamma \setminus \gamma_i$ is fixed, then so are the poles and the single-flip (i.e. SSEP) part of the contour dynamics on γ_i is just the corner-flip dynamics as described in the proof of Lemma 6.5: jump rates are local due to being in $N\mathcal{E}_r$, and no single-flip inside γ_i could shrink a pole of size 2 due to the way the extremities of γ_i are defined.

Define μ_i as the marginal of ν (defined in (2.3)) on M_i :

$$\forall \rho \in M_i, \quad \mu_i(\rho) = \frac{e^{-\beta|\rho|}}{Z_i}, \quad Z_i = \sum_{\rho \in M_i} e^{-\beta|\rho|}.$$

Let f be a ν -density supported on $N\mathcal{E}_r(d)$. Define the corresponding μ_i -marginal f_i :

$$\forall \rho \in M_i, \quad f_i(\rho) = \frac{1}{\mu_i(\rho)} \sum_{\gamma \in X_r^N} \mathbf{1}_{\gamma_i=\rho} f(\gamma) \nu(\gamma).$$

In terms of the M_i , the Dirichlet form $D_N^S(f)$ is bounded from below by convexity according to:

$$D_N^S(f) \geq \frac{1}{2} \sum_{i=1}^4 \sum_{\rho \in M_i} \mu_i(\rho) \sum_{x \in V(\rho)} c_x(\rho) [f_i^{1/2}(\rho^{x, x+e_x^-}) - f_i^{1/2}(\rho)]^2 =: \sum_{i=1}^4 D_i^S(f_i), \quad (\text{A.5})$$

where for $i \in \{1, \dots, 4\}$ and a μ_i -density h , the Dirichlet form $D_i^S(h)$ corresponding to the SSEP dynamics in quadrant i is given by:

$$D_i^S(h) = \sum_{\rho \in M_i} \mu_i(\rho) \sum_{x \in V(\rho)} c_x(\rho) [h^{1/2}(\rho^{x, x+e_x^-}) - h^{1/2}(\rho)]^2.$$

Indeed, the jump rates in (A.5) are functions of $\rho \in M_i$ only, $i \in \{1, \dots, 4\}$, since f is supported on $N\mathcal{E}_r(d)$. Let us now see how to use this decomposition of the curves into quadrants to estimate the sum appearing in the right-hand side of (A.4). For short, define Φ_j for $1 \leq j \leq J$ by:

$$\Phi_j(\tau_x \gamma) = \left| A(\phi, V_j(x)) - \tilde{\phi}(\xi^{V_j(x)}) \right|^2.$$

Note that Φ_j only depends on the edge configuration in a neighbourhood of a curve around x , not on the absolute position of x as a point of Λ_N . We thus only need to keep track of the label of x in a well chosen parametrisation of γ . We have:

$$(E) := \frac{1}{N_r} \sum_{\gamma \in X_r^N \cap N\mathcal{E}_r(d)} \nu(\gamma) f(\gamma) \sum_{x \in W^{\varepsilon N+R+3}(\gamma)} \Phi_j(\tau_x \gamma) \leq \frac{1}{N_r} \sum_{i=1}^4 \sum_{\rho \in M_i} \mu_i(\rho) f_i(\rho) \sum_{x \in W^{\varepsilon N+R}(\rho)} \Phi_j(\tau_x \rho).$$

So far, we proved that the one block-estimate (A.2) holds as soon as, for each $j \in \{1, \dots, J\}$:

$$\sup_{f \geq 0: \nu_f(N\mathcal{E}_r)=1} \left\{ \sum_{i=1}^4 \left[a \sum_{\rho \in M_i} \mu_i(\rho) f_i(\rho) \sum_{x \in W^{\varepsilon N+R}(\rho)} \Phi_j(\tau_x \rho) - N D_i^S(f_i) \right] \right\} \leq 0. \quad (\text{A.6})$$

The estimate for each quadrant i is similar, so we only do it for $i = 1$. Further split paths in M_1 according to their number of vertices. Let $M_1(n)$ be the subset of M_1 of paths with $n + 1$ vertices. All such paths have the same μ_i -measure, thus the marginal of μ_i on $M_1(n)$ is the uniform measure U_n on paths with $n + 1$ vertices or, equivalently, by the correspondence expounded in Section 6.2.2 (see Figure 9), of SSEP configurations with n sites. Define $f_{1,n}$ as the corresponding U_n -marginal of f_1 on $M_1(n)$:

$$\forall \rho \in M_1(n), \quad f_{1,n}(\rho) = \mathbb{E}_{\mu_1} [f_1 \mathbf{1}_{M_1(n)}]^{-1} f_1(\rho) \mu_1(\rho) |M_1(n)| \quad \text{provided} \quad \mathbb{E}_{\mu_1} [f_1 M_1(n)] > 0. \quad (\text{A.7})$$

It is a density for U_n , so that by convexity of the Dirichlet form we have:

$$\sum_{n=2\varepsilon N+2R}^{4N} \mathbb{E}_{\mu_1} [f_1 \mathbf{1}_{M_1(n)}] D_{1,n}(f_{1,n}) \leq D_1(f_1),$$

where $D_{1,n}$ is the Dirichlet form associated with the corner-flip dynamics on $M_1(n)$. The lower bound on n comes from the fact that, for any $\rho \in M_1(n)$ with $n < 2\varepsilon N + 2R$, $W^{\varepsilon N+R}(\rho)$ is empty. The upper bound comes from the finite length of a quadrant for a curve in $\Lambda_N = [-N, N]^2 \cap \mathbb{Z}^2$. Again by convexity,

$$D_N^S(f) \geq \sum_{n=2\varepsilon N+2R}^{4N} \mathbb{E}_{\mu_1} [f_1 \mathbf{1}_{M_1(n)}] D_{1,n}(f_{1,n}). \quad (\text{A.8})$$

With this decomposition, the term between brackets in (A.6) is bounded from above, for each $i \in \{1, \dots, 4\}$, by:

$$\begin{aligned} & \frac{1}{Nr} \sum_{n=2\varepsilon N+2R}^{4N} \mathbb{E}_{\mu_i} [f_i \mathbf{1}_{M_i(n)}] \frac{1}{|M_i(n)|} \sum_{\rho \in M_i(n)} f_{i,n}(\rho) \sum_{x=\varepsilon N+R+1}^{n-\varepsilon N-R} \Phi_j(\tau_x \rho) \\ &= \frac{1}{Nr} \sum_{n=2\varepsilon N+2R}^{4N} \mathbb{E}_{\mu_i} [f_i \mathbf{1}_{M_i(n)}] \frac{1}{|M_i(n)|} \sum_{\sigma \in \Omega_n} g_{i,n}(\sigma) \sum_{x=\varepsilon N+R+1}^{n-\varepsilon N-R} \Phi_j(\tau_x \sigma). \end{aligned} \quad (\text{A.9})$$

In the last line, Ω_n is the set of SSEP configurations on n sites, and $g_{i,n}$ is defined for $\sigma \in \Omega_n$ by $g_{i,n}(\sigma) = g_{i,n}(\rho(\sigma))$, with $\rho(\sigma)$ the unique path in $M_i(n)$ corresponding to the configuration σ , as pictured in Figure 9. In view of (A.6)-(A.8)-(A.9), to prove the one block estimate (A.2), it is sufficient to prove that, uniformly on $j \in \{1, \dots, J\}$:

$$\limsup_{N \rightarrow \infty} \sup_{n \in \{2\varepsilon N+2R, \dots, 4N\}} \sup_{g \geq 0: \mathbb{E}_{U_n}[g]=1} \left\{ \frac{1}{N} \mathbb{E}_{U_n} \left[g \sum_{x=\varepsilon N+R+1}^{n-\varepsilon N-R} \Phi_j(\tau_x \cdot) \right] - N D_n^S(g) \right\} \leq 0. \quad (\text{A.10})$$

The notation D_n^S , already used in Section 6, stands for the Dirichlet form associated with a SSEP on n sites. We are left with a usual one block estimate for a SSEP of size n , proven e.g. in [ELS90]. There, the size n of the SSEP becomes irrelevant due to conditioning on a neighbourhood of size k of x , hence the proof of (A.2). The two block estimate (A.3) is proven similarly. \square

A.2 Projection of the contour dynamics in the good state space

In this section, we prove Lemma 6.3, which states that the contour dynamics can be projected to the effective state space $N\mathcal{E}_r(d)$. We state and prove a more general result.

Let $(X_t)_{t \geq 0}$ be a continuous time Markov chain on a finite state space E , reversible with respect to a

measure ν . If $x_0 \in E$, let $\mathbb{P}_{x_0}^X, \mathbb{E}_{x_0}^X$ be the associated probability and expectation. The jump rates of the chain are denoted $c(x, y)$, $(x, y) \in E^2$, with associated Dirichlet form D :

$$\forall f : E \rightarrow \mathbb{R}, \quad D(f) = \frac{1}{2} \sum_{(x,y) \in E^2} \nu(x) c(x, y) [f(y) - f(x)]^2. \quad (\text{A.11})$$

Lemma A.2. *Let $A \subset E$ and $x_0 \in A$. Let also $T_0 > 0$ and $\psi : [0, T_0] \times E \rightarrow \mathbb{R}$ be bounded. Then:*

$$\mathbb{E}_{x_0}^X \left[\mathbf{1}_{\{\forall t \in [0, T_0], X_t \in A\}} \exp \left[\int_0^{T_0} \psi(t, X_t) dt \right] \right] \leq \frac{1}{\nu(x_0)} \exp \left[\int_0^{T_0} dt \sup_{f \geq 0: \nu(f \mathbf{1}_A) = 1} \left\{ \nu_f(\psi(t, \cdot)) - D(f) \right\} \right]. \quad (\text{A.12})$$

Proof. Let $(Y_t)_{t \geq 0}$ be the Markov chain X restricted to live inside A for all time. Write $\mathbb{P}_x^Y, \mathbb{E}_x^Y, x \in A$ the associated probability and expectation. On $\{\forall t \in [0, T_0], X_t \in A\}$, the two measures $\mathbb{P}_{x_0}^X$ and $\mathbb{P}_{x_0}^Y$ are equivalent, and the Radon-Nikodym derivative between $\mathbb{P}_{x_0}^Y$ and $\mathbb{P}_{x_0}^X$ up to time T_0 on a trajectory $(X_t)_{t \leq T_0}$ taking values in A reads:

$$\begin{aligned} \frac{d\mathbb{P}_{x_0}^X}{d\mathbb{P}_{x_0}^Y}((X_t)_{t \leq T_0}) &= \exp \left[\int_0^{T_0} \left[\sum_{y \in A} c(X_t, y) - \sum_{y \in E} c(X_t, y) \right] dt - \sum_{t \leq T_0} \log \left(\frac{c(X_{t-}, X_t)}{c(X_{t-}, X_t)} \right) \right] \\ &= \exp \left[- \int_0^{T_0} \sum_{y \notin A} c(X_t, y) dt \right]. \end{aligned}$$

Letting $Q_A(x) = \sum_{y \notin A} c(x, y)$ denote the flux coming out of A from x , we find:

$$\mathbb{E}_{x_0}^X \left[\mathbf{1}_{\{\forall t \in [0, T_0], X_t \in A\}} \exp \left[\int_0^{T_0} \psi(t, X_t) dt \right] \right] = \mathbb{E}_{x_0}^Y \left[\exp \left[\int_0^{T_0} \left\{ \psi(t, Y_t) - Q_A(Y_t) \right\} dt \right] \right]. \quad (\text{A.13})$$

By reversibility of X with respect to ν , the chain Y is still reversible with respect to $\nu(\cdot \cap A)$:

$$\forall x, y \in A, \quad c(x, y)\nu(x) = c(y, x)\nu(y).$$

Let us thus apply Feynman-Kac formula after changing the initial condition to $\nu(\cdot \cap A)$:

$$\mathbb{E}_{x_0}^Y \left[\exp \left[\int_0^{T_0} \left\{ \psi(t, Y_t) - Q_A(Y_t) \right\} dt \right] \right] \leq \frac{1}{\nu(x_0)} \mathbb{E}_{\nu(\cdot \cap A)}^Y \left[\exp \left[\int_0^{T_0} \left\{ \psi(t, Y_t) - Q_A(Y_t) \right\} dt \right] \right].$$

Consequently:

$$\begin{aligned} &\log \mathbb{E}_{x_0}^Y \left[\exp \left[\int_0^{T_0} \left\{ \phi(t, Y_t) - Q_A(Y_t) \right\} dt \right] \right] \\ &\leq -\log \nu(x_0) + \log \int_0^{T_0} \sup_{f \geq 0: \nu(f \mathbf{1}_A) = 1} \left\{ \nu \left(f [\psi(t, \cdot) - Q_A] \right) - D_A(f^{1/2}) \right\}. \end{aligned} \quad (\text{A.14})$$

Above, D_A is the Dirichlet form of the dynamics restricted to A (compare with (A.11)):

$$\forall g : E \rightarrow \mathbb{R}, \quad D_A(g) = \frac{1}{2} \sum_{(x,y) \in A^2} \nu(x) c(x, y) [g(x) - g(y)]^2.$$

This is nearly the statement of Lemma 6.3, except that there the upper-bound involves the original dynamics (in the present case, X) rather than the dynamics restricted to A . To obtain the desired bound, let us write out $D(f^{1/2})$, defined in (A.11), for a ν -density f with $\nu(f\mathbf{1}_A) = 1$:

$$\begin{aligned} D(f^{1/2}) &= \frac{1}{2} \sum_{(x,y) \in A^2} \nu(x)c(x,y) [f^{1/2}(y) - f^{1/2}(x)]^2 \\ &\quad + \frac{1}{2} \sum_{x \in A, y \notin A} \nu(x)c(x,y)f(x) + \frac{1}{2} \sum_{x \notin A, y \in A} \nu(x)c(x,y)f(y). \end{aligned} \quad (\text{A.15})$$

The first line is precisely $D_A(f^{1/2})$. By reversibility, each term on the second line of (A.15) is identical and equal to $\nu(fQ_A/2)$:

$$\nu(fQ_A) = \sum_{x \in A, y \notin A} \nu(x)c(x,y)f(x) = \sum_{x \in A, y \notin A} \nu(y)c(y,x)f(x) = \sum_{x \notin A, y \in A} \nu(x)c(x,y)f(y).$$

As a result, (A.15) becomes:

$$D(f^{1/2}) = D_A(f^{1/2}) + \nu(fQ_A).$$

Inject this equality in the bound (A.14) to find:

$$\begin{aligned} \log \mathbb{E}_{x_0}^Y \left[\exp \left[\int_0^{T_0} \left\{ \phi(t, Y_t) - Q_A(Y_t) \right\} dt \right] \right] \\ \leq -\log \nu(x_0) + \log \int_0^{T_0} \sup_{f \geq 0: \nu(f\mathbf{1}_A)=1} \left\{ \nu(f\psi(t, \cdot)) - D(f^{1/2}) \right\}, \end{aligned}$$

which is Lemma A.2 for $\psi \leftarrow N\psi$, $A = N\mathcal{E}_r(d)$ and with a dynamics accelerated by N^2 . \square

A.3 Equilibrium estimates at the pole

In this section, we investigate the equilibrium measure μ_ℓ (see (6.71)) of the zero-range process at the poles. We prove:

Proposition A.3. *The surface tension of the contour model around the pole is given by*

$$\tau(P) = -\lim_{\ell \rightarrow \infty} \frac{1}{\beta\ell} \log Z_\ell = 1 + \frac{1}{\beta} \log(1 - e^{-\beta}). \quad (\text{A.16})$$

Moreover, the sequence $(\mu_\ell)_\ell$ satisfies a large deviation principle for the top height of a path (equivalently: the number of particles or of antiparticles) with good, convex rate function given by:

$$\forall u \geq 0, \quad C(u) = 2\beta u - 2u \log(1 + 1/(2u)) - \log(1 + 2u) - \log(1 - e^{-\beta}). \quad (\text{A.17})$$

In particular,

$$\lim_{k \rightarrow \infty} \sup_{\ell_{\min}(k) \leq \ell \leq k} \mathbb{E}_{\mu_\ell}[\phi] = 0, \quad \phi = \mathbf{1}_{p=2} - e^{-\beta}. \quad (\text{A.18})$$

Proof. We speak alternately of paths or of particle/antiparticle configurations in the proof depending on what is easier to use, the height of a path corresponding to $\sum_{x \leq L_1} \eta_x = -\sum_{x > L_1} \eta_x$.

Let us first study the probability to observe a given height under μ_ℓ . There are exactly $\binom{2q+\ell-2}{2q}$ configurations with height $q \in \mathbb{N}$. To see it, notice that this is the number of north-east path of length $2q + \ell - 2$ with $2q$ vertical edges. To each such path ρ , one can associate a unique up-down path of length $2q + \ell$ as follows (see also Figure 13)

- Travelling on the path ρ from its origin, stop at the first point X at height q and cut the path there, in two parts $\rho_{\leq X}$ and $\rho_{> X}$.
- Add two horizontal edges to $\rho_{\leq X}$ immediately after X , call ρ_{X+2} the resulting path.
- Change $\rho_{> X}$ into its symmetrical $\tilde{\rho}_{> X}$ with respect to the horizontal, i.e. change every upwards edge into a downwards one, leaving the horizontal edges unchanged. Stitch the last edge of ρ_{X+2} to the first of $\tilde{\rho}_{> X}$ to obtain an up-down path of height q and length $2q + \ell$.

One easily checks that this mapping is a bijection, whence:

$$\forall q \leq h_{\max}(k) = k(1 + \log k), \quad \mu_\ell \left(\sum_{j \leq L_1} \eta_j = q \right) = \binom{2q + \ell - 2}{2q} e^{-2\beta q - \beta \ell} / Z_\ell. \quad (\text{A.19})$$

Let us investigate the dependence of this quantity in $q < h_{\max}(k)$:

$$\mu_\ell \left(\sum_{j \leq L_1} \eta_j = q + 1 \right) / \mu_\ell \left(\sum_{j \leq L_1} \eta_j = q \right) = e^{-2\beta} \frac{(2q + \ell)(2q + \ell - 1)}{(2q + 2)(2q + 1)}. \quad (\text{A.20})$$

This quantity increases until some value q_c of q , given by

$$q_c = \frac{1}{2}(e^\beta - 1)^{-1} \ell + o(\ell) =: u_c \ell + o(\ell). \quad (\text{A.21})$$

In particular, due to the logarithm in (A.16), only the maximum value of $\binom{2q + \ell - 2}{2q} e^{-2\beta q - \beta \ell}$ will matter to compute $\tau(P)$. One thus needs only consider heights of order ℓ in the large ℓ limit. For fixed $u > 0$, elementary computations give:

$$\frac{1}{\ell} \log \left[\binom{2\lfloor \ell u \rfloor + \ell - 2}{2\lfloor \ell u \rfloor} e^{-2\beta \lfloor \ell u \rfloor - \beta \ell} \right] = -\beta - 2\beta u + 2u \log(1 + 1/(2u)) + \log(1 + 2u) + o_\ell(1). \quad (\text{A.22})$$

Define the function $D(\cdot)$ on \mathbb{R}_+^* by;

$$\forall u \geq 0, \quad D(u) = \beta + 2\beta u - 2u \log(1 + 1/(2u)) - \log(1 + 2u) \geq 0. \quad (\text{A.23})$$

From (A.22) and with $u_c = \frac{1}{2}(e^\beta - 1)^{-1}$, we obtain for $\tau(P)$:

$$\tau(P) = \lim_{\ell \rightarrow \infty} \frac{1}{\beta \ell} \log Z_\ell = \frac{D(u_c)}{\beta} = 1 + \frac{1}{\beta} \log(1 - e^{-\beta}). \quad (\text{A.24})$$

We now turn to the large deviation principle for the height of a path. From (A.22) and (A.24), we obtain

$$\frac{1}{\ell} \log \mu_\ell \left(\sum_{j \leq L_1} \eta_j = \lfloor \ell u \rfloor \right) = -(D(u) - D(u_c)) + o_\ell(1), \quad (\text{A.25})$$

Define the rate function $C(\cdot)$ on \mathbb{R}_+^* by

$$\forall u \geq 0, \quad C(u) = D(u) - D(u_c) \geq 0. \quad (\text{A.26})$$

The function C is C^∞ on \mathbb{R}_+^* , and satisfies:

$$C(u_c) = 0 = C'(u_c), \quad C''(u) = \frac{2}{u + 2u^2} > 0 \text{ for each } u > 0,$$

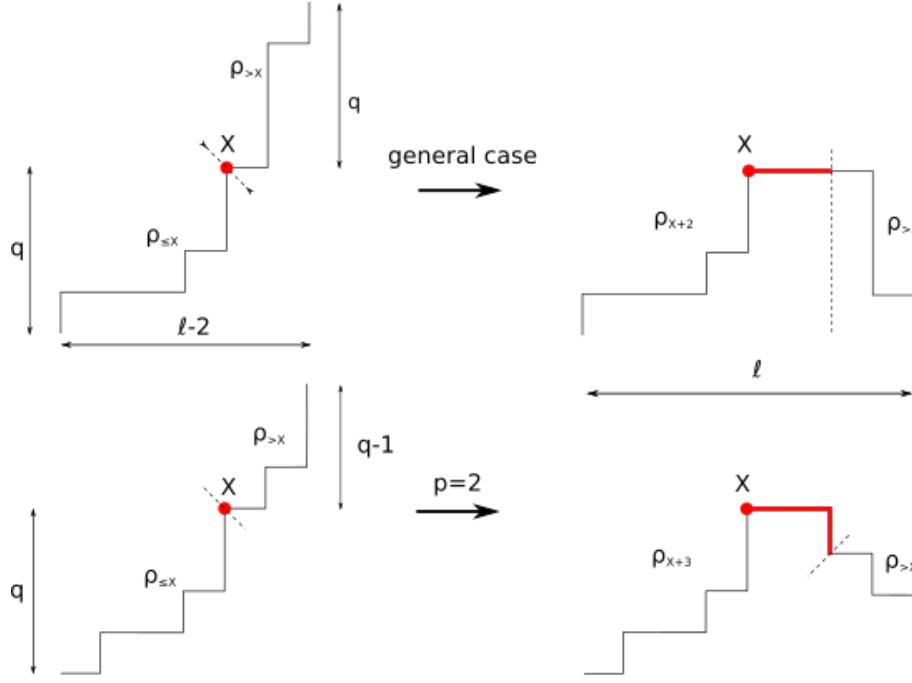

Figure 13: Bijection argument to count the number of paths with length ℓ and height q (top figure), and with additionally $p = 2$ (bottom figure). Dashed lines delimit portions of the paths, the red dot is the place at which the initial north-east path is split, and the red, thick lines on the right-hand side are the edges added to the initial path to obtain an up-down configuration with height q and length $\ell + 2q$.

so that C is strictly convex, and a good rate function. The large deviation principle follows from (A.25).

It remains to prove (A.18). This follows from the large deviations principle (A.25) and the following observation. Constructing a path with $p = 2$ and height $q \in \mathbb{N}^*$ is done by building a north-east path of length $2q - 1 + \ell - 2$ with $2q - 1$ vertical edges, then cutting it as described previously and taking the symmetric part of the path after the first point X at height q . The only difference is that one now sticks not just two horizontal edges after X , but two horizontal edges followed by a vertical one hanging from below, before stitching back the two parts of the path (see Figure 13). There are thus $\binom{2q+\ell-3}{2q-1}$ configurations with $p = 2$ and height $q \in \mathbb{N}^*$, and:

$$\mu_\ell\left(p = 2, \sum_{j \leq L_1} \eta_j = q\right) = Z_\ell^{-1} e^{-\beta\ell - 2\beta q} \binom{2q + \ell - 3}{2q - 1} = \frac{2q}{2q + \ell - 2} \mu_\ell\left(\sum_{j \leq L_1} \eta_j = q\right). \quad (\text{A.27})$$

From (A.27), using $(\ell + 1)\rho^\ell = 2 \sum_{j \leq L_1} \eta_j$, the expectation in (A.18) reads, for each $\ell \in \{k, \dots, \ell_{\max}(k) = (k(1 + \log k))^2\}$:

$$\mathbb{E}_{\mu_\ell}[\phi] = -e^{-\beta} + \sum_{q \geq 1} \mu_\ell\left(p = 2, \sum_{j \leq L_1} \eta_j = q\right) \stackrel{(\text{A.27})}{=} \mathbb{E}_{\mu_\ell} \left[\frac{2 \sum_{j \leq L_1} \eta_j}{2 \sum_{j \leq L_1} \eta_j + \ell - 2} - e^{-\beta} \right]. \quad (\text{A.28})$$

Let $\zeta > 0$. The integrand in (A.28) is bounded and, for all ℓ large enough,

$$\frac{1}{\ell} \log \mu_\ell \left(\frac{1}{\ell} \sum_{j \leq L_1} \eta_j \notin [u_c - \zeta, u_c + \zeta] \right) \leq -C(u_c + \zeta)/2 < 0. \quad (\text{A.29})$$

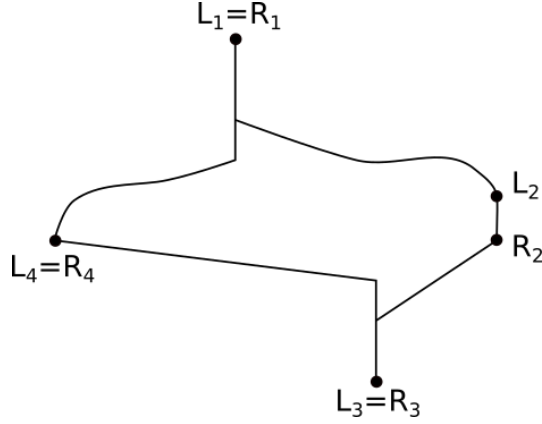

Figure 14: Example of a droplet in \mathcal{E}_r . Though microscopic curves are Jordan curves, their limits in Hausdorff distance may have self-intersections. Taking curves in \mathcal{E}_r ensures that these self-intersections only occur at the pole, this is condition 5 in Definition B.1 below.

As a result, since $2u_c/(2u_c + 1) = e^{-\beta}$, the expectation in (A.28) is recast as follows:

$$\begin{aligned} \mathbb{E}_{\mu_\ell}[\phi] &= \mathbb{E}_{\mu_\ell} \left[\left(\frac{2^{\ell-1} \sum_{j \leq L_1} \eta_j}{2^{\ell-1} \sum_{j \leq L_1} \eta_j + 1} - e^{-\beta} \right) \mathbf{1}_{u_c - \zeta \leq \ell^{-1} \sum_{j \leq L_1} \eta_j \leq u_c + \zeta} \right] + O(\ell^{-1}) \\ &= O(\zeta) + O(\ell^{-1}). \end{aligned}$$

The $O(\zeta)$ is independent of ℓ , which proves (A.18). □

B Topology results

At the microscopic level, curves are defined in terms of their poles and four monotonous paths, one on each quadrant. The position of the poles in particular plays a big role in the dynamics and appears in the large deviations functional, see Section 4. At the macroscopic level however, the decomposition in poles and quadrants is not very convenient to work with, see Figure 14, as we need to deal with droplets with complicated boundaries. In this section, we define a suitable effective state space and a good topology on trajectories, at the cost of model-specific considerations. Exponential tightness of the laws of the contour dynamics is also shown in Appendix B.3.

B.1 Definition of \mathcal{E}_r and topological properties

In this section, we define the effective state space \mathcal{E}_r , prove that it is closed in Hausdorff topology and establish some topological facts used in the body of the article. Recall that X is the set of non-empty compact and connected subsets of $[-1, 1]^2$. This set is compact for the topology associated with the Hausdorff distance d_H .

Definition B.1. *For $r > 0$, define the space $\mathcal{E}_r \subset X$ as follows. The first three points mirror the conditions placed on elements of X_r^N .*

1. (Four poles). *If R is the rectangle with least area containing Γ , then $R \cap \partial\Gamma$ is composed of at most four segments $[L_k, R_k]$, $k \in \{1, \dots, 4\}$, one on each side of R . These segments are not necessarily*

disjoint and possibly reduced to a point. Fix $[L_1, R_1]$ to be the segment with highest ordinate and call it the north pole. The others are respectively the east, south and west poles, where by convention $\partial\Gamma$ is travelled on clockwise. Define then the first quadrant as the quarter-space delimited by the vertical axis passing through $L_1(\Gamma)$, and the horizontal axis through $R_2(\Gamma)$. The other quadrants are defined similarly; note that they can intersect (see Figure 1).

2. (Monotonicity condition). The boundary of Γ between L_k and R_{k+1} can be described as the graph of a 1-Lipschitz function in the reference frame $\mathcal{R}_k = (O, e_{\pi/4-k\pi/2}, e_{\pi/4-(k-1)\pi/2})$ (if $k = 4$, $\mathcal{R}_{k+1} := \mathcal{R}_1$).
3. (The droplet is not reduced to a point). One has $y_{\max} - y_{\min} \geq r$, $x_{\max} - x_{\min} \geq r$, where these quantities respectively denote the highest/lowest ordinate/abscissa of points in Γ .

The last two conditions respectively ensure room in each quadrant by removing droplets that have two different poles that coalesce, and exclude droplets with self-intersections in their bulk (recall Figure 4).

4. (Distinguishable poles). For each $k \in \{1, \dots, 4\}$:

$$|(L_k - R_{k+1}) \cdot e_1| \geq r, \quad |(L_k - R_{k+1}) \cdot e_2| \geq r. \quad (\text{B.1})$$

5. (Simple boundary away from the poles). Any two points of the boundary that are not in a pole and belong to opposite quadrants (i.e. quadrants 1 and 3 or 2 and 4) are at 1-distance at least r .

Remark B.2. • Note that condition 4 is redundant with condition 3. We keep both, however, as they have very different interpretations from the point of view of the dynamics.

- One can convince oneself by geometrical considerations that condition 5 ensures droplets have volume at least $(r\sqrt{2})^2/4 = r^2/2$. In fact, if $\Gamma \in \mathcal{E}_r$ and $x \in \partial\Gamma$ is e.g. in the first quadrant and satisfies $x \cdot e_1 \geq L_1(\Gamma) \cdot e_1 + r$ and $x \cdot e_2 \geq R_2(\Gamma) \cdot e_2 + r$ (a neighbourhood around x intersects neither quadrant 2 nor 4), then (see Figure 15):

$$|B_1(x, r) \cap \Gamma| \geq \frac{r^2}{2}, \quad B_1(x, r) = \{y \in \mathbb{R}^2 : \|y - x\|_1 < r\}. \quad (\text{B.2})$$

■

Lemma B.3. Conditions 1 and 2 on the one hand, and conditions 1 and 2 with any condition from 3 to 5 in Definition B.1 on the other hand define a closed subset of X . As a result, the set \mathcal{E}_r is closed for the Hausdorff topology, hence compact.

Proof. Let $\Gamma^n \in \mathcal{E}_r, n \in \mathbb{N}$ converge in Hausdorff distance to $\Gamma \in X$. The first three items boil down to the fact that $y_{\max}, x_{\max}, y_{\min}$ and x_{\min} are continuous in Hausdorff distance; as well as the observation that a uniform limit of 1-Lipschitz functions is 1-Lipschitz.

4. (Distinguishable poles). Let us prove the result for the first quadrant, the others are similar. By continuity of y_{\max} , all limit points of $(L_1(\Gamma^n))$ are inside $P_1(\Gamma)$, i.e. to the right of $L_1(\Gamma)$. By continuity of x_{\max} , $(R_2(\Gamma^n) \cdot e_1) = (x_{\max}(\Gamma^n))$ converges to $R_2(\Gamma) \cdot e_1$. The function $\Gamma' \mapsto [R_2(\Gamma') - L_1(\Gamma')] \cdot e_1$ is thus upper semi-continuous, i.e. "quadrants grow in the limit", which is the desired result. The same is true of $\Gamma' \mapsto [L_1(\Gamma') - R_2(\Gamma')] \cdot e_2$.

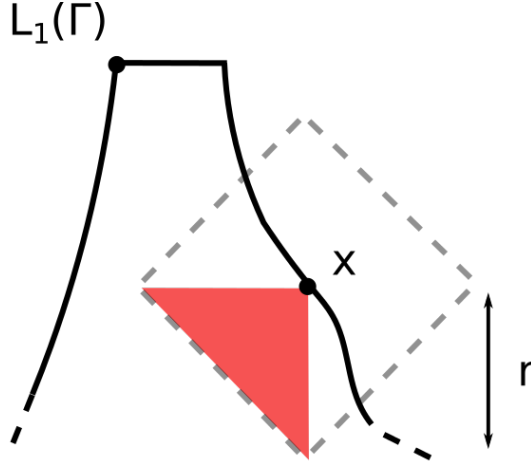

Figure 15: For a point x of the boundary of a droplet $\Gamma \in \mathcal{E}_r$ that is at vertical and horizontal distance at least r from the pole, at least one fourth of the ball $B_1(x, r)$ is contained in Γ (shaded area).

5. (*Simple boundary away from the poles*). For definiteness, take a point x of $\partial\Gamma$ in the first quadrant and assume $x \notin P_1 \cup P_2$, i.e. $x \cdot e_2 < y_{\max}(\Gamma)$ and $x \cdot e_1 < x_{\max}(\Gamma)$. Take also $y \in C_3(\Gamma) \cap \partial\Gamma \setminus (P_3 \cup P_4)$. For n large enough, x, y cannot be in a pole of Γ^n by continuity of $y_{\max}, \dots, x_{\min}$. By upper semi-continuity of the size of quadrants for the inclusion (see item 4), $d(x, C_1(\Gamma^n) \setminus P^n)$ and $d(y, C_3(\Gamma^n) \setminus P^n)$ vanish for large n , thus:

$$d(x, y) \geq d(C_1(\Gamma^n) \setminus P^n, C_3(\Gamma^n) \setminus P^n) - d(x, C_1(\Gamma^n) \setminus P^n) - d(y, C_3(\Gamma^n) \setminus P^n) \geq r + o_n(1).$$

□

Recall from Definition 2.1 that for $d > 0$, $\mathcal{E}_r(d) \subset \mathcal{E}_r$ is composed of droplets at 1-distance at least d from the domain boundaries $\partial([-1, 1]^2)$. By continuity of $y_{\max}, \dots, x_{\min}$, this set is also compact in Hausdorff topology.

Elements of \mathcal{E}_r have very constrained boundaries. A difference in Hausdorff distance between two sets translates into a difference in volume or in the position of the poles. The following two lemmas give explicit control of the Hausdorff distance that are useful in Section B.2.

Definition B.4. For $k \in \{1, \dots, 4\}$, define $z_k, w_k : \mathcal{E}_r \rightarrow \mathbb{R}$ as the coordinates of the left-most point L_k of pole k of a droplet:

$$z_1 = y_{\max}, \quad z_2 = x_{\max}, \quad z_3 = y_{\min}, \quad z_4 = x_{\min}$$

and the w_k are the other four coordinates. A droplet $\Gamma \in \mathcal{E}_r$ can be described in terms of the position $(z_k, w_k)_{k \in \{1, \dots, 4\}}$ of its four poles, and the largest droplet $\Gamma' \subset \Gamma$ with simple boundary such that $\Gamma = \Gamma'$ up to a set of volume 0. In other words, Γ' is the closure of the interior of Γ . Define:

$$\mathcal{F}_r = \{\Gamma' : \Gamma \in \mathcal{E}_r\}.$$

One can check that \mathcal{F}_r satisfies items 1, 2, 3 and 5 in Definition B.1.

Lemma B.5. Let $\Gamma_1, \Gamma_2 \in \mathcal{E}_r$. Let $k \in \{1, \dots, 4\}$. Then:

$$d_H(\Gamma_1, \Gamma_2) \geq |z_k(\Gamma_1) - z_k(\Gamma_2)|.$$

Moreover, if $\alpha > 0$ and $q > 1/\alpha$,

$$\begin{cases} |w_k(\Gamma_1) - w_k(\Gamma_2)| \geq \alpha \\ \forall i \in \{1, 2\}, \quad |z_k(\Gamma_i) - z_k(\Gamma'_i)| \geq 1/q \end{cases} \Rightarrow d_H(\Gamma_1, \Gamma_2) \geq 1/q. \quad (\text{B.3})$$

Proof. Fix $k = 1$ for definiteness. Only (B.3) requires a proof. Assume its left-hand side holds and, without loss of generality, take $k = 1$ and assume that $y_{\max}(\Gamma_1) \geq y_{\max}(\Gamma_2)$. Then both droplets have a line of length at least $1/q$ below their north pole. These lines have abscissas differing at least by $\alpha > 1/q$, which means a fortiori that they are at 1-distance at least $1/q$. Consequently, if $\varepsilon \in (0, 1/q)$, $\text{dist}_1(P_1(\Gamma_1), (\Gamma_2)^{(1/q-\varepsilon)}) > 0$, where $\Gamma_i^{(\varepsilon)}$ is the ε -fattening of Γ_i for $i \in \{1, 2\}$:

$$\Gamma_i^{(\varepsilon)} = \bigcup_{x \in \Gamma_i} B_1(x, \varepsilon), \quad B_1(x, \varepsilon) = \{y \in \mathbb{R}^2 : \|y - x\|_1 < \varepsilon\} \text{ for } x \in \mathbb{R}^2.$$

This implies $d_H(\Gamma_1, \Gamma_2) \geq 1/q - \varepsilon$ and the result. \square

The next lemma gives some sort of a converse statement.

Lemma B.6. *Let $\Gamma_1, \Gamma_2 \in \mathcal{E}_r$ and $\varepsilon \in (0, r)$. Then:*

$$d_H(\Gamma_1, \Gamma_2) \geq \varepsilon \Rightarrow d^{L^1}(\Gamma_1, \Gamma_2) \geq \varepsilon^2/8 \quad \text{or} \quad \max_{1 \leq k, \ell \leq 4} \{\|L_k(\Gamma_1) - L_k(\Gamma_2)\|_1, \|R_\ell(\Gamma_1) - R_\ell(\Gamma_2)\|_1\} \geq \varepsilon/2.$$

Proof. Without loss of generality, assume that $a := d_H(\Gamma_1, \Gamma_2) = \sup_{x \in \Gamma_1} \text{dist}_1(x, \Gamma_2)$, and let $x \in \partial\Gamma_1$ realise that supremum: x is at least as far away from Γ_2 in 1-distance as any other point of Γ_1 , and no point of Γ_2 is at 1-distance strictly less than a from x .

There are two cases to consider: either x is close to a pole and the ball $B_1(x, a) \cap \Gamma_1$ has a small volume, or x is sufficiently far from the poles to ensure that $B_1(x, a) \cap \Gamma_1$ is of order a^2 . The latter will lead to a difference in volume between Γ_1 and Γ_2 , while the former implies that poles cannot be too close. It is convenient to slightly reformulate this dichotomy.

- Suppose Γ_1 has a non-simple boundary, i.e. $\Gamma_1 \neq \Gamma'_1$ with Γ'_1 as in Definition B.4. Suppose further that $x \notin \Gamma'_1$. Then, by definition of \mathcal{E}_r , Γ_1 has at least one pole, say pole $k \in \{1, \dots, 4\}$, that is point-like. By definition of x , $x = L_k(\Gamma_1)$ ($= R_k(\Gamma_1)$). In particular, $L_k(\Gamma_2)$ is a distance at least a from x :

$$\|L_k(\Gamma_1) - L_k(\Gamma_2)\|_1 \geq a.$$

- Assume now that $\Gamma_1 = \Gamma'_1$, or that $\Gamma_1 \neq \Gamma'_1$ and $x \in \Gamma'_1$. Without loss of generality, take x in the first quadrant of Γ_1 . By definition of x and the monotonicity condition on elements of \mathcal{E}_r , any point of Γ_2 at 1-distance a from x must be in quadrant 1 of Γ_2 (including poles 1 and 2). Suppose first that $[x - L_1(\Gamma_1)] \cdot e_1 > a/2 \wedge r$ and $[x - L_2(\Gamma_1)] \cdot e_2 > a/2 \wedge r$, i.e. the ball $B_1(x, a/2 \wedge r) \cap \partial\Gamma_1$ only contains points to the right of $L_1(\Gamma_1)$ and above $L_2(\Gamma_1)$. Then, by Remark (B.2),

$$|B_1(x, a/2 \wedge r) \cap \Gamma_1| \geq \frac{1}{2}(a/2 \wedge r)^2 \Rightarrow |B_1(x, a) \cap \Gamma_1| \geq \frac{1}{2}(a/2 \wedge r)^2.$$

Suppose instead that $[x - L_1(\Gamma_1)] \cdot e_1 \leq a/2 \wedge r$: x is close to the left extremity of the first quadrant. Let us prove that, necessarily, $L_1(\Gamma_1)$ and $L_1(\Gamma_2)$ are then at 1-distance at least $a/2 \wedge r$.

Define Q_1 as the highest point of $\partial\Gamma'_1$ (defined in Definition B.4) with abscissa $L_1(\Gamma_1) \cdot e_1$ and

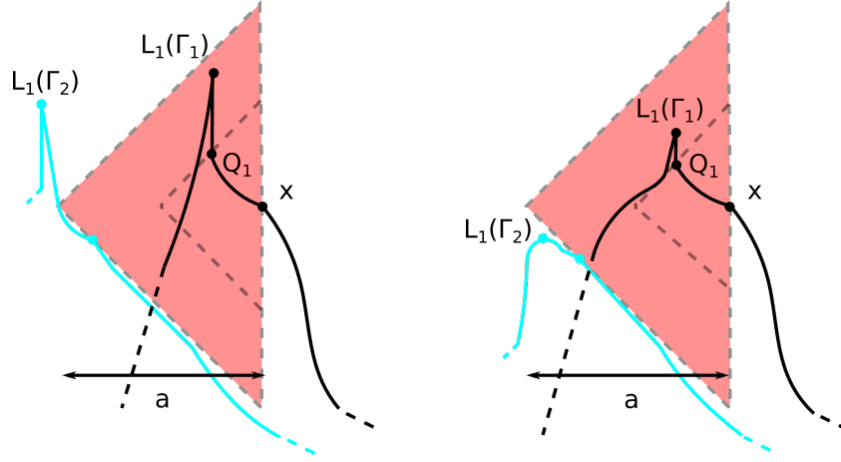

Figure 16: An example where $[x - L_1(\Gamma_1)] \cdot e_1 \leq a/2 \wedge r$ with $a/2 \leq r$. The shaded area delimited by light dashed lines is the left half of $B_1(x, a)$. The darker dashed lines mark the left half of $B_1(x, a/2)$. $\partial\Gamma_1$ is in solid black lines, $\partial\Gamma_2$ in solid light lines. Left figure: $L_2(\Gamma_1)$ is left of $B_1(x, a)$, hence $[L_1(\Gamma_1) - L_1(\Gamma_2)] \cdot e_1 \geq a/2$. Right figure: $L_2(\Gamma_1)$ is below $B_1(x, a)$, hence $\|L_1(\Gamma_1) - L_1(\Gamma_2)\|_1 \geq \|Q_1 - L_1(\Gamma_2)\|_1 \geq a/2$.

intersecting the boundary of $B_1(x, a/2)$, see Figure 16. As $\Gamma_2 \cap \mathring{B}_1(x, a) = \emptyset$ by definition of x , $L_1(\Gamma_2)$ must be either to the left of $B_1(x, a)$, or below it. If it is to the left, then the abscissas of $L_1(\Gamma_1)$ and of $L_2(\Gamma_1)$ must differ by at least $a/2 \wedge r$, i.e.: $[L_1(\Gamma_1) - L_2(\Gamma_1)] \cdot e_1 \geq a/2 \wedge r$. If it is below $B_1(x, a)$, then $\|Q_1 - L_1(\Gamma_2)\|_1 \geq a/2 \wedge r$, which by definition of Q_1 implies $\|L_1(\Gamma_1) - L_1(\Gamma_2)\|_1 \geq a/2 \wedge r$. Both cases are illustrated on Figure 16; they both yield:

$$\|L_1(\Gamma_1) - L_1(\Gamma_2)\|_1 \geq a/2 \wedge r.$$

Condition $[x - L_2(\Gamma_1)] \cdot e_2 \leq a/2 \wedge r$ is treated similarly, this time with $R_2(\Gamma_1), R_2(\Gamma_2)$, thus:

$$\max \{ \|L_1(\Gamma_1) - L_1(\Gamma_2)\|_1, \|R_2(\Gamma_1) - R_2(\Gamma_2)\|_1 \} \geq a/2 \wedge r.$$

□

B.2 The set $E([0, T_0], \mathcal{E}_r(d))$

For $T_0 > 0$, the set $E([0, T_0], \mathcal{E}_r(d))$ was defined in Section 2.3 as the completion of $D_H([0, T_0], \mathcal{E}_r(d))$ for the distance d_E (see (B.4)), where $D_H([0, T_0], \mathcal{E}_r(d))$ is the set of $\mathcal{E}_r(d)$ -valued trajectories that are càdlàg in Hausdorff distance d_H . The distance d_E was defined as:

$$d_E = d_S^{L^1} + \int_0^{T_0} d_H dt, \quad (\text{B.4})$$

with $d_S^{L^1}$ the Skorokhod distance associated with convergence in the $L^1([-1, 1]^2)$ topology. This topology is metricised by the distance d^{L^1} , defined on the set X of non-empty compact subsets of $[-1, 1]^2$ by:

$$\forall \Gamma, \Gamma' \in X, \quad d^{L^1}(\Gamma, \Gamma') = \int_{[-1, 1]^2} |\mathbf{1}_\Gamma - \mathbf{1}_{\Gamma'}| dx. \quad (\text{B.5})$$

For properties of the Skorokhod topology, we refer the reader to [EK09].

In this section, we study $(E([0, T_0], \mathcal{E}_r(d)), d_E)$ for $d \geq 0$. The case $d = 0$ corresponds to $E([0, T_0], \mathcal{E}_r)$.

We prove separability, completeness and characterise its relatively compact subsets. The starting point is the following explicit characterisation of $E([0, T_0], \mathcal{E}_r(d))$. Recall from Definition B.4 that $\mathcal{F}_r \subset X$ is the set of droplets with simple boundary, that can be obtained by removing all portions of volume 0 from a droplet in \mathcal{E}_r . Then:

$$E([0, T_0], \mathcal{E}_r(d)) = \left\{ \Gamma \in D_{L^1}([0, T_0], \mathcal{F}_r) : \text{for a.e. } t \in [0, T_0], \Gamma_t \in \mathcal{E}_r(d) \right\}, \quad (\text{B.6})$$

where $\mathcal{E}_r(d) \subset \mathcal{E}_r$ is the set of droplets at 1-distance at least d from the domain boundaries $\partial([-1, 1]^2)$.

B.2.1 Completeness and separability of $E([0, T_0], \mathcal{E}_r(d))$

In this section, we prove that $E([0, T_0], \mathcal{E}_r(d))$ as defined in (B.6) is separable, and that it is indeed the completion, for the distance d_E , of the set $D_H([0, T_0], \mathcal{E}_r(d))$ of $\mathcal{E}_r(d)$ -valued Hausdorff-càdlàg trajectories. Let us first prove that $(E([0, T_0], \mathcal{E}_r(d)), d_E)$ is complete.

Lemma B.7. *The space $(E([0, T_0], \mathcal{E}_r(d)), d_E)$ is complete.*

Proof. Consider a Cauchy sequence $\Gamma_n \in E([0, T_0], \mathcal{E}_r(d)), n \in \mathbb{N}$ for d_E . It is a Cauchy sequence for $d_S^{L^1}$ in $D_{L^1}([0, T_0], \mathcal{F}_r)$. The set \mathcal{F}_r is closed, in L^1 topology, in the set of non-empty droplets with measure-theoretic perimeter bounded by 8. This set is compact, assimilating droplets to BV functions with bounded measure-theoretic perimeter, see Theorem 5.5 in [EG15]. There is thus a trajectory Γ^0 in $D_{L^1}([0, T_0], \mathcal{F}_r)$ with $d_S^{L^1}$ distance to Γ_n vanishing with n . More precisely, consider the sequence (Γ'_n) constructed from (Γ_n) as in Definition B.4. As $\Gamma_n(t)$ and $\Gamma'_n(t)$ are equal almost everywhere in \mathbb{R}^2 for each $t \in [0, T_0]$ and each n , (Γ'_n) converges in $D_{L^1}([0, T_0], \mathcal{F}_r)$ to a limit $\Gamma'_\infty = \Gamma^0$.

Γ'_∞ corresponds to the limiting trajectory of the "bulk" of the Γ_n , i.e. without the poles. We still need to figure out what the limiting poles should be, which we do using the $\int_0^{T_0} d_H dt$ part of d_E . Recall the definitions of z_k, w_k from Definition B.4. For each $k \in \{1, \dots, 4\}$, $(z_k(\Gamma_n))$ is a Cauchy sequence in $L^1([0, T_0], [-1+d, 1-d])$. It thus converges to some limit $z_k^\infty \in L^1([0, T_0], [-1+d, 1-d])$. Moreover, for each n , $z_k(\Gamma_n(t)) \geq z_k(\Gamma'_n(t))$ almost surely and, by convergence in $d_S^{L^1}$ of Γ'_n to Γ'_∞ ,

$$\liminf_{n \rightarrow \infty} z_{1,2}(\Gamma'_n) \geq z_{1,2}(\Gamma'_\infty), \quad \limsup_{n \rightarrow \infty} z_{3,4}(\Gamma'_n) \leq z_{3,4}(\Gamma'_\infty) \quad \text{almost surely.}$$

As a result, $z_{1,2}^\infty(t) \geq z_{1,2}(\Gamma'_\infty(t))$ and $z_{3,4}^\infty(t) \leq z_{3,4}(\Gamma'_\infty(t))$ for almost every $t \in [0, T_0]$, as desired since the z_k are supposed to play the role of the extremal coordinates of the "real" limiting trajectory of the sequence $(\Gamma_n)_n$.

It remains to control the w_k , defined in Definition B.4. Indeed, at present, if on some subset $U \subset [0, T_0]$ of strictly positive measure Γ'_∞ has a flat pole k for some $k \in \{1, \dots, 4\}$, and if $z_k > z_k(\Gamma'_\infty)$ for almost every time in U , then we need to determine where on this flat zone we should add the line $[z_k(\Gamma'_\infty), z_k]$ to construct a limiting trajectory Γ_∞ for d_E .

For $k \in \{1, \dots, 4\}$, define $I_k \subset [0, T_0]$ as the set of times t for which pole k of $\Gamma'_\infty(t)$ is extended, i.e. $|P_k(\Gamma'_\infty(t))| > 0$. If $t \notin I_k$, then there is exactly one point at which the change of monotonicity at pole k in the boundary of $\Gamma'_\infty(t)$ occurs. This means that $w_k(\Gamma_n(t))$ converges to $w_k(\Gamma'_\infty(t))$ for almost every $t \notin I_k$.

To deal with what happens inside I_k , take $k = 1$ for simplicity, so that $z_1 = y_{\max}$. Split I_1 into $J_0 \cup J_>$, where J_0 is the largest subset of I_1 such that $z_1^\infty = y_{\max}(\Gamma'_\infty)$ a.s.. $J_>$ is the largest subset of I_1 on

which $z_1^\infty > y_{\max}(\Gamma'_\infty)$ a.s.. For $t \in J_0$, we need not ask where the north pole should be located, since it coincides with the north pole of $\Gamma'_\infty(t)$ almost surely. The set $J_>$ instead requires more work. Fix $\varepsilon > 0$. For all n, p large enough in terms of ε , the Cauchy condition implies:

$$\int_0^{T_0} \mathbf{1}_{J_>} d_H(\Gamma_n(t), \Gamma_p(t)) dt \leq \varepsilon. \quad (\text{B.7})$$

As $\mathbf{1}_{z_1^\infty \geq y_{\max}(\Gamma'_\infty) + 1/q}$ converges pointwise to $\mathbf{1}_{z_1^\infty > y_{\max}(\Gamma'_\infty)}$ for large q , the integral in (B.7) can be made to bear only on times where z_1^∞ is at least $1/q$ above $z_1(\Gamma'_\infty)$ almost surely. Call $J_>^q \subset J_>$ the largest subset for which this holds. By the monotone convergence theorem, for each $\delta > 0$ and q larger than some $q(\delta)$:

$$\int_0^{T_0} \mathbf{1}_{J_>^q} d_H(\Gamma_n(t), \Gamma_p(t)) dt \leq \varepsilon \quad \text{and} \quad |J_>^q| - |J_>| \leq \delta. \quad (\text{B.8})$$

Fix $\delta > 0$ and such a q . By definition of z_1^∞ , for all n larger than some $n(q)$, $y_{\max}(\Gamma_n(t)) \geq y_{\max}(\Gamma'_\infty(t)) + 1/(2q)$ for almost every $t \in J_>^q$. Impose also that $y_{\max}(\Gamma_n(t)) > y_{\max}(\Gamma'_n(t)) + 1/(2q)$ a.e. in $J_>^q$. Invoking Lemma B.5 yields that, for each $\alpha > 0$, up to increasing q and $n(q)$, for each $n, p \geq n(q)$,

$$\int_0^{T_0} \mathbf{1}_{J_>^q} \mathbf{1}_{|w_1(\Gamma_n(t)) - w_1(\Gamma_p(t))| \geq \alpha} \leq q \int_0^{T_0} d_H(\Gamma_n(t), \Gamma_p(t)) dt \leq 2q\varepsilon.$$

Summarising, for each $\delta > 0$, choosing α such that $2\alpha T_0 \leq \delta/3$, $q > \alpha^{-1}$ such that $|J_>| - |J_>^q| \leq \delta/3$ and ε to have $4\varepsilon q \leq \delta/3$; one has for all n, p large enough:

$$\int_0^{T_0} \mathbf{1}_{J_>} |w_1(\Gamma_n(t)) - w_1(\Gamma_p(t))| dt \leq \delta.$$

Define \tilde{w}_n to be $w_1(\Gamma_n)$ on $J_>$, 0 elsewhere. Then (\tilde{w}_n) is a Cauchy sequence in $L^1([0, T_0], [-1+d, 1-d])$, hence converges to some \tilde{w}_∞ and we can define:

$$\text{for almost every } t \in [0, T_0], \quad w_1^\infty(t) = \begin{cases} \tilde{w}_\infty(t) & \text{if } t \in J_> \\ L_1(\Gamma'_\infty(t)) \cdot e_1 & \text{otherwise.} \end{cases} \quad (\text{B.9})$$

Functions $w_2^\infty, w_3^\infty, w_4^\infty$ are defined similarly for the other poles. Finally, let Γ_∞ be such that $(\Gamma_\infty)' = \Gamma_\infty$ and, for almost every $t \in [0, T_0]$:

$$\begin{aligned} \Gamma_\infty(t) &= \Gamma'_\infty(t) \cup \bigcup_{i \in \{1,3\}} \{w_i(t)e_1 + ue_2 : u \in [z_i(\Gamma'_\infty(t)), z_i(t)]\} \\ &\cup \bigcup_{i \in \{2,4\}} \{ue_1 + w_i(t)e_2 : u \in [z_i(\Gamma'_\infty(t)), z_i(t)]\}. \end{aligned} \quad (\text{B.10})$$

By construction, Γ_∞ belongs to $E([0, T_0], \mathcal{E}_r(d))$, and $\lim_{n \rightarrow \infty} d_E(\Gamma_n, \Gamma_\infty) = 0$ by Lemma B.6, which concludes the proof. \square

Characterisation (B.6) of $E([0, T_0], \mathcal{E}_r(d))$ also yields that $D_H([0, T_0], \mathcal{E}_r(d))$, the set of Hausdorff-càdlàg $\mathcal{E}_r(d)$ -valued droplet trajectories on $[0, T_0]$, is dense in $E([0, T_0], \mathcal{E}_r(d))$ for d_E . Indeed, convergence of the volume is clear and for each $\Gamma \in E([0, T_0], \mathcal{E}_r(d))$, one can find real càdlàg functions, corresponding to the 8 coordinates of the poles, that converge in $L^1([0, T_0], [-1+d, 1-d])$ to the $w_k(\Gamma), z_k(\Gamma)$, $k \in \{1, \dots, 4\}$. $E([0, T_0], \mathcal{E}_r(d))$ is thus indeed the completion of $D_H([0, T_0], \mathcal{E}_r(d))$ for d_E . As this set is separable for the Skorokhod topology associated with d_H , we obtain:

Lemma B.8. *The space $(E([0, T_0], \mathcal{E}_r(d)), d_E)$ is separable.*

B.2.2 Compact sets in $E([0, T_0], \mathcal{E}_r(d))$ and exponential tightness

In the following subsection, we prove exponential tightness, for each bias $H \in \mathcal{C}$, of the laws $(Q_{r,\beta,H}^N)_N$ restricted to trajectories in $E([0, T_0], \mathcal{E}_r(d))$. To do so, we need a sufficient condition for a subset of $E([0, T_0], \mathcal{E}_r(d))$ to be compact. This is the object of this section.

Proposition B.9 (Compact sets for d_E). *The following equivalence holds:*

(i) $K \subset E([0, T_0], \mathcal{E}_r(d))$ is relatively compact for the topology induced by d_E .

(ii) If $\omega^{L^1}(\Gamma)$ is the Skorokhod modulus of continuity associated with volume convergence for a trajectory $\Gamma \in E([0, T_0], \mathcal{E}_r(d))$ (see [EK09]), then:

$$\limsup_{\eta \rightarrow 0} \sup_{h \leq \eta} \sup_{\Gamma \in K} \left\{ \omega_h^{L^1}(\Gamma) + \int_0^{T_0-h} d_H(\Gamma_t, \Gamma_{t+h}) dt \right\} = 0. \quad (\text{B.11})$$

Proof. The proof uses notations and results from the proof of Lemma B.7. We only give details for (ii) \Rightarrow (i) as we do not need the converse implication, which follows from total boundedness of relatively compact sets and the fact that (B.11) is true for singletons thanks to Lemma B.6.

(ii) \Rightarrow (i). According to the characterisation of relatively compact sets in the Skorokhod topology in [EK09], K is relatively compact in $d_S^{L^1}$. Take $\{\Gamma^n, n \in \mathbb{N}\} \subset K$ and let Γ'_∞ be a limit point in $d_S^{L^1}$ of a subsequence that we still write $(\Gamma^n)_n$. As in the proof of Lemma B.7, we can take $\Gamma'_\infty \in D_{L^1}([0, T_0], \mathcal{F}_r)$ such that $\partial \Gamma'_t$ is a simple curve at all times $t \in [0, T_0]$. Recall that $\mathcal{F}_r \subset \mathcal{E}_r$ is the set of droplets for which items 1, 2, 3 and 5 in Definition B.1 hold.

Let us now prove that some subsequence of the (Γ^n) has converging z_k^n, w_k^n , writing $z_k^n = z_k(\Gamma^n)$ and similarly for w_k^n . z_k, w_k are defined in Definition B.4 and correspond to the coordinates of the left extremity L_k of pole $k \in \{1, \dots, 4\}$. The proof is very similar to that of the completeness of $E([0, T_0], \mathcal{E}_r(d))$ for d_E in Lemma B.7. There, we had for each $\varepsilon > 0$ and some $N(\varepsilon) \in \mathbb{N}$:

$$\sup_{n \geq N(\varepsilon)} \sup_{p \in \mathbb{N}} \int_0^{T_0} d_H(\Gamma^n(t), \Gamma^{n+p}(t)) dt \leq \varepsilon.$$

Compare with:

$$\sup_{h \leq \eta} \sup_{n \in \mathbb{N}} \int_0^{T_0-h} d_H(\Gamma^n(t), \Gamma^n(t+h)) dt \leq \varepsilon. \quad (\text{B.12})$$

Here as well, Lemma B.5 yields that (B.12) holds with $(z_k^n), (w_k^n)$ replacing d_H on $[0, T_0 - h]$. By the Kolmogorov-Riesz theorem (Theorem 4.26 in [Bre10]), this implies the relative compactness of the sequences $(z_k^n), (w_k^n)$ in $L^1([0, T_0], [-1+d, 1-d])$. A trajectory Γ_∞ to which (Γ^n) converges in d_E up to a subsequence is then built as in Lemma B.7. This concludes the proof of (ii) \Rightarrow (i). \square

We now conclude the proof of tightness, and exponential tightness on trajectories restricted to $E([0, T_0], \mathcal{E}_r(d))$. This step is classical, but requires some care in our case as some estimates hold only for $\mathcal{E}_r(d)$ -valued trajectories and not on the whole state space.

Corollary B.10 (Sufficient condition for the tightness of $(Q_{r,\beta,H}^N)_N$). *Let $T_0 > 0$. Assume that, for each $H \in \mathcal{C}$,*

$$\limsup_{N \rightarrow \infty} \mathbb{P}_{r,\beta,H}^N(E([0, T_0], \mathcal{E}_r(d))^c) = o_N(1), \quad (\text{B.13})$$

so that trajectories are typically almost always in $\mathcal{E}_r(d)$ on $[0, T_0]$. Assume further that, for each $G \in C^2([-1, 1]^2)$ and each $\varepsilon > 0$,

$$\begin{aligned} \limsup_{\eta \rightarrow 0} \limsup_{N \rightarrow \infty} \frac{1}{N} \log \mathbb{P}_{r,\beta}^N \left(E([0, T_0], \mathcal{E}_r(d)), \left\{ \sup_{|s-t| \leq \eta} |\langle \Gamma_t, G \rangle - \langle \Gamma_s, G \rangle| \right. \right. \\ \left. \left. + \sup_{h \leq \eta} \sum_{k=1}^4 \int_0^{T_0-h} [\|L_k(\Gamma_t) - L_k(\Gamma_{t+h})\|_1 + \|R_k(\Gamma_t) - R_k(\Gamma_{t+h})\|_1] dt \geq \varepsilon \right\} \right) = -\infty. \end{aligned} \quad (\text{B.14})$$

Then for each $H \in \mathcal{C}$ and $q \in \mathbb{N}^*$, there are compact sets $K_q = K_q(H)$ such that:

$$\sup_N Q_{r,\beta,H}^N((K_q)^c) \leq \frac{2}{q}, \quad \sup_N \frac{1}{N} \log Q_{r,\beta,H}^N(E([0, T_0], \mathcal{E}_r(d)) \cap (K_q)^c) \leq -q.$$

In particular, $\{Q_{r,\beta,H}^N : N \in \mathbb{N}^*\}$ is relatively compact as a family of measures on trajectories up to time T_0 , and its weak limit points are supported in $E([0, T_0], \mathcal{E}_r(d))$.

Proof. As (B.14) also holds under $\mathbb{P}_{r,\beta,H}^N$ for any $H \in \mathcal{C}$, we prove the corollary only for $H \equiv 0$.

Consider a sequence $G_\ell \in C^2([-1, 1]^2)$, $\ell \geq 1$, dense for the uniform norm. According to (B.14), for each $q, n \in \mathbb{N}^*$, there is $\eta = \eta(q, \ell, n)$ and $N_0 = N_0(\eta)$ such that:

$$\begin{aligned} \sup_{N \geq N(\eta)} \frac{1}{N} \log \mathbb{P}_{r,\beta}^N \left(E([0, T_0], \mathcal{E}_r(d)), \left\{ \sup_{|s-t| \leq \eta} |\langle \Gamma_t, G_\ell \rangle - \langle \Gamma_s, G_\ell \rangle| \right. \right. \\ \left. \left. + \sup_{h \leq \eta} \sum_{k=1}^4 \int_0^{T_0-h} [\|L_k(\Gamma_t) - L_k(\Gamma_{t+h})\|_1 + \|R_k(\Gamma_t) - R_k(\Gamma_{t+h})\|_1] dt \geq \frac{1}{n} \right\} \right) \leq -qn\ell. \end{aligned} \quad (\text{B.15})$$

By (B.13), consider also $N_1 = N_1(q, \ell, n)$ such that:

$$\sup_{N \geq N_1} \mathbb{P}_{r,\beta}^N(E([0, T_0], \mathcal{E}_r(d))^c) \leq \frac{1}{q2^{\ell+n}}.$$

Let $N_2 = \max\{N_0, N_1\}$. For $N \leq N_2$, L_k, R_k , $k \in \{1, \dots, 4\}$ are càdlàg functions in Hausdorff distance on $N^{-1}X_r^N$. As a result, (B.15) holds for $N \leq N_2$ as well up to choosing $\eta' = \eta'(q, \ell, n) \leq \eta$, hence for all N in \mathbb{N}^* . For $G \in C^2([-1, 1]^2)$, let thus $\omega_\theta^{L^1}(\langle \Gamma, G \rangle)$ be the Skorokhod modulus of continuity associated with the trajectory $(\langle \Gamma_t, G \rangle)_t$ (see [EK09]); it satisfies:

$$\forall \theta > 0, \quad \omega_\theta^{L^1}(\langle \Gamma, G \rangle) \leq \sup_{|s-t| \leq \theta} |\langle \Gamma_t, G \rangle - \langle \Gamma_s, G \rangle|.$$

Define then $K_q = \bar{U}_q$, with U_q as follows:

$$U_q := \bigcap_{\ell, n \in \mathbb{N}^*} \left\{ \omega_{\eta'}^{L^1}(\langle \Gamma, G_\ell \rangle) + \sup_{h \leq \eta'} \sum_{k=1}^4 \int_0^{T_0-h} [\|L_k(\Gamma_t) - L_k(\Gamma_{t+h})\|_1 + \|R_k(\Gamma_t) - R_k(\Gamma_{t+h})\|_1] dt \geq \frac{1}{n} \right\}.$$

By Proposition B.9 and Lemma B.6, K_q is compact, and it satisfies by construction:

$$\sup_{N \in \mathbb{N}^*} \frac{1}{N} \log Q_{r,\beta}^N(E([0, T_0], \mathcal{E}_r(d)) \cap (K_q)^c) \leq -q.$$

This concludes the proof of exponential tightness inside $E([0, T_0], \mathcal{E}_r(d))$. Moreover, also by construction and since $e^{-Nq\ell n} \leq 2^{-\ell-n}/q$ for each $N \geq 1$,

$$\sup_N Q_{r,\beta}^N((K_q)^c) \leq 2/q.$$

By Prohorov's theorem (Theorem 2.2. p104 in [EK09]), $(Q_{r,\beta}^N)_N$ is relatively compact, and its weak limit points are concentrated on $E([0, T_0], \mathcal{E}_r(d))$ by (B.13). This concludes the proof. \square

B.3 Proof of the sufficient condition for exponential tightness

In this section, we provide the proof of the sub-exponential estimate in Corollary B.10, i.e. the proof of (B.14). The first step is to control the volume variations of a droplet, in Section B.3.1.

Next, we prove that the (time integrated) volume beneath each pole has a fixed value in terms of β , imposed by the reservoir-like behaviour of the poles. This estimate is used in Section B.3.3 to obtain a control on the motion of the poles. Parameters r, β, H are fixed throughout as in Definition 2.1.

B.3.1 Estimate in $L^1([-1, 1]^2)$ topology

In this section, we prove exponential tightness in volume, i.e. in $L^1([-1, 1]^2)$ topology, with the metric d^{L^1} defined in (B.5). Equivalently, d^{L^1} is characterised as follows.

Lemma B.11. *Let $(G_\ell)_{\ell \geq 1}$ be a family of functions of $C^2([-1, 1]^2, \mathbb{R})$, dense for the uniform $\sup_{[-1, 1]^2} |\cdot|$. Then d^{L^1} is topologically equivalent to the distance \tilde{d}^{L^1} defined as follows:*

$$\forall \Gamma, \Gamma' \in X, \quad \tilde{d}^{L^1}(\Gamma, \Gamma') = \sum_{\ell \geq 1} \frac{1}{2^\ell} \frac{|\langle \Gamma, G_\ell \rangle - \langle \Gamma', G_\ell \rangle|}{1 + |\langle \Gamma, G_\ell \rangle - \langle \Gamma', G_\ell \rangle|}.$$

In the sequel, \tilde{d}^{L^1} and d^{L^1} are identified.

Lemma B.12. *Let $T_0 > 0$ and $G \in C^2([-1, 1]^2)$. Then:*

$$\forall \varepsilon > 0, \quad \limsup_{\delta \rightarrow 0} \limsup_{N \rightarrow \infty} \frac{1}{N} \log \mathbb{P}_{r, \beta}^N \left(\text{for a.e. } t \leq T_0, \Gamma_t \in \mathcal{E}_r; \sup_{|t-s| \leq \delta} \left| \int_{\Gamma_t} G - \int_{\Gamma_s} G \right| > \varepsilon \right) = -\infty. \quad (\text{B.16})$$

Proof. Compared to Chapter 10 in [KL99], the only subtleties to prove (B.16) are in the introduction of the condition $\{\text{for a.e. } t \leq T_0, \Gamma_t \in \mathcal{E}_r\}$ to be able to use the computations of Section 3, and in the control of the poles. As this does not present any particular difficulty, the proof is omitted. \square

B.3.2 Precise control of the slope and volume around the poles

In this section, we prove that the volume below the pole is fixed by their reservoir-like behaviour induced by the dynamics. This relies on a microscopic estimate of the slope at the pole, obtained in Section 6.2.4 in Corollary 6.11.

Lemma B.13 (Control of the deviations of the width at distance $\alpha > 0$ below the pole). *For $\alpha > 0$ and $\Gamma \in \mathcal{E}_r$, let $g^+(\alpha) = g^+(\alpha)(\Gamma)$ be the width of the horizontal segment of Γ at height $y_{\max}(\Gamma) - \alpha$ to the right of $L_1(\Gamma)$. Define similarly $g^-(\alpha)$ to the left of $L_1(\Gamma)$. For each $\delta, \eta > 0$:*

$$\limsup_{\alpha \rightarrow 0} \limsup_{N \rightarrow \infty} \frac{1}{N} \log \mathbb{P}_{r, \beta}^N \left(\text{for a.e. } t \in [0, T_0], \Gamma_t \in \mathcal{E}_r(d); \frac{1}{T_0} \int_0^{T_0} \mathbf{1}_{|\alpha^{-1}g^\pm(\alpha) - (e^\beta - 1)| \geq \delta} dt > \eta \right) = -\infty. \quad (\text{B.17})$$

Proof. Take $\zeta^1, \zeta^2 > 0$ to be determined later, and $\theta > 0$ which will be small. We prove the result for g^+ , g^- is similar. By Corollary 6.11, it is sufficient to prove:

$$\limsup_{\zeta^1, \zeta^2 \rightarrow 0} \limsup_{\alpha \rightarrow 0} \limsup_{N \rightarrow \infty} \frac{1}{N} \log \mathbb{P}_{r, \beta}^N \left(\text{for a.e. } t \in [0, T_0], \Gamma_t \in \mathcal{E}_r(d); \frac{1}{T_0} \int_0^{T_0} \mathbf{1}_{|\alpha^{-1}g^+(\alpha) - (e^\beta - 1)| \geq \delta} \mathbf{1}_{|\xi^+, \zeta^1 N - e^{-\beta}| \leq \theta} \mathbf{1}_{|\xi^+, \zeta^2 N - e^{-\beta}| \leq \theta} dt > \eta/3 \right) = -\infty.$$

Consider the event bearing on $\xi^{+, \zeta^{1N}}$: it enforces

$$\xi^{+, \zeta^{1N}} \in [e^{-\beta} - \theta, e^{-\beta} + \theta].$$

Choose ζ^1 such that $(e^{-\beta} - \theta)\zeta^1 = \alpha$. Then $\zeta^1 \xi^{+, \zeta^{1N}} \geq \alpha$ means that, by definition, $g^+(\alpha)$ must be smaller than $\zeta^1(1 - \xi^{+, \zeta^{1N}})$:

$$\xi^{+, \zeta^{1N}} \in [e^{-\beta} - \theta, e^{-\beta} + \theta] \text{ and } (e^{-\beta} - \theta)\zeta^1 = \alpha \quad \Rightarrow \quad \alpha^{-1}g^+(\alpha) \leq \frac{1 - e^{-\beta} + \theta}{e^{-\beta} - \theta} = e^\beta - 1 + O(\theta),$$

where $O(\theta)$ is a positive function. Similarly, choose ζ^2 such that $(e^{-\beta} + \theta)\zeta^2 = \alpha$. Then:

$$\xi^{+, \zeta^{2N}} \in [e^{-\beta} - \theta, e^{-\beta} + \theta] \text{ and } (e^{-\beta} + \theta)\zeta^2 = \alpha \quad \Rightarrow \quad \alpha^{-1}g^+(\alpha) \geq \frac{1 - e^{-\beta} - \theta}{e^{-\beta} + \theta} = e^\beta - 1 - O(\theta).$$

$O(\theta)$ is again a positive function. Taking θ small enough to contradict $|\alpha^{-1}g^+(\alpha) - (e^\beta - 1)| \geq \delta$ concludes the proof. \square

Lemma B.14 (Control of the deviations of the volume at distance $\alpha > 0$ below the pole). *For $\Gamma \in \mathcal{E}_r$, let $V^\alpha = V^\alpha(\Gamma)$ be defined as:*

$$V^\alpha(\Gamma) = \alpha^{-2} |\{x \in \Gamma : x \cdot e_2 \geq y_{\max}(\Gamma) - \alpha\}|.$$

Then for each $\delta, \eta > 0$:

$$\limsup_{\alpha \rightarrow 0} \limsup_{N \rightarrow \infty} \frac{1}{N} \log \mathbb{P}_{r, \beta}^N \left(\text{for a.e. } t \in [0, T_0], \Gamma_t \in \mathcal{E}_r(d); \frac{1}{T_0} \int_0^{T_0} \mathbf{1}_{|V^\alpha - (e^\beta - 1)| > \delta} dt > \eta \right) = -\infty. \quad (\text{B.18})$$

Proof. Fix $k \in \mathbb{N}^*$ and $\theta > 0$ to be chosen later. By Lemma B.13, it is sufficient to prove:

$$\limsup_{\alpha \rightarrow 0} \limsup_{N \rightarrow \infty} \frac{1}{N} \log \mathbb{P}_{r, \beta}^N \left(\text{for a.e. } t \in [0, T_0], \Gamma_t \in \mathcal{E}_r(d); \right. \quad (\text{B.19})$$

$$\left. \frac{1}{T_0} \int_0^{T_0} \mathbf{1}_{|V^\alpha - (e^\beta - 1)| > \delta} \mathbf{1}_{\forall j \in \{1, \dots, k\}, \left| \frac{j}{j\alpha} g^\pm(j\alpha/k) - (e^\beta - 1) \right| \leq \theta} dt > \eta/2 \right) = -\infty.$$

By definition of $g^\pm(\alpha)$ for $\alpha > 0$ (see Lemma B.13), for $\Gamma \in \mathcal{E}_r$ the quantity $V^\alpha(\Gamma)$ satisfies:

$$V^\alpha(\Gamma) = \alpha^{-2} \int_0^\alpha (g^+(u) + g^-(u)) du.$$

As microscopic curves have 1-Lipschitz boundaries, on the event that $(k/j\alpha)g^\pm(j\alpha/k) \in [e^\beta + 1 - \theta, e^\beta - 1 - \theta]$ for each $1 \leq j \leq k$, one obtains the following bound for V^α :

$$\alpha^2 V^\alpha(\Gamma) = |\{x \in \Gamma : y(x) \geq y_{\max} - \alpha\}| \geq 2 \sum_{j=1}^{k-1} \frac{j}{k\alpha} (e^\beta + 1 - \theta) \times \frac{\alpha}{k} = \frac{k-1}{k} (e^\beta - 1 - \theta) \alpha^2.$$

Similarly,

$$\alpha^2 V^\alpha(\Gamma) \leq 2 \sum_{j=1}^k \frac{j}{k\alpha} (e^\beta - 1 + \theta) \times \frac{\alpha}{k} = \frac{k+1}{k} (e^\beta - 1 + \theta) \alpha^2.$$

To conclude the proof, it remains to take k, θ such that the indicator functions appearing in (B.19) bear on incompatible events. This is achieved provided:

$$\frac{k-1}{k} (e^\beta - 1 - \theta) \geq e^\beta - 1 - \delta \quad \text{and} \quad \frac{k+1}{k} (e^\beta - 1 + \theta) \leq e^\beta - 1 + \delta.$$

\square

B.3.3 Tightness in $L^1([0, T_0])$ distance for the motion of the poles

In this section, we prove exponential tightness for the motion of the poles assuming trajectories live in $\mathcal{E}_r(d)$ for almost every time. As argued in Appendix B.2.2, it is sufficient to find a compact set of $L^1([0, T_0], [-1 + d, 1 - d]^2)$ in which the trajectories of the poles concentrate at scale e^{-N} . We proceed coordinates by coordinates of the L_k , $k \in \{1, \dots, 4\}$. This will also work for the R_k since they are microscopically close to the L_k by Lemma 6.1. According to the Kolmogorov-Riesz compactness theorem (Theorem 4.26 in [Bre10]), a set $K \subset L^1([0, T_0], [-1 + d, 1 - d])$ is relatively compact if and only if:

$$\sup_{h \leq \eta} \sup_{f \in K} \int_0^{T_0-h} |f(t+h) - f(t)| dt = o_\eta(1). \quad (\text{B.20})$$

To prove exponential tightness for the poles, we thus only have to prove that (B.20) holds for each of the eight coordinates of the L_k , $k \in \{1, \dots, 4\}$. We prove it for the motion of $y(L_1) = y_{\max}$ in the following lemma. The proof for the other seven coordinates is similar.

Lemma B.15 (Tightness in L^1 distance for y_{\max}). *Let $\varepsilon > 0$. Then:*

$$\limsup_{\eta \rightarrow 0} \limsup_{N \rightarrow \infty} \frac{1}{N} \log \mathbb{P}_{r, \beta}^N \left(\text{for a.e. } t \in [0, T_0], \Gamma_t \in \mathcal{E}_r(d); \sup_{h \leq \eta} \frac{1}{T_0} \int_0^{T_0-h} |y_{\max}(t+h) - y_{\max}(t)| dt > \varepsilon \right) = -\infty. \quad (\text{B.21})$$

Proof. For each $t \in [0, T_0]$ and $h \leq \eta$, write $\Delta_h(t) = |y_{\max}(t+h) - y_{\max}(t)|$ for brevity. Since y_{\max} is bounded by 2, (B.21) is proven as soon as

$$\limsup_{\eta \rightarrow 0} \limsup_{N \rightarrow \infty} \frac{1}{N} \log \mathbb{P}_{r, \beta}^N \left(\text{for a.e. } t \in [0, T_0], \Gamma_t \in \mathcal{E}_r(d); \sup_{h \leq \eta} \frac{1}{T_0} \int_0^{T_0-h} \mathbf{1}_{\Delta_h(t) \geq \varepsilon/2} dt > \varepsilon/4 \right) = -\infty.$$

Fix $\delta > 0$ that will be chosen small enough in the following. Define, for $\alpha > 0$ and $t \in [0, T_0]$, the quantity $\Delta V^\alpha(t)$ as follows (recall Lemma B.14):

$$\Delta V^\alpha(t) = |V^\alpha(\Gamma_t) - (e^\beta - 1)|.$$

Lemma B.14 tells us:

$$\limsup_{\alpha \rightarrow 0} \limsup_{N \rightarrow \infty} \frac{1}{N} \log \mathbb{P}_{r, \beta}^N \left(\text{for a.e. } t \in [0, T_0], \Gamma_t \in \mathcal{E}_r(d); \frac{1}{T_0} \int_0^{T_0} \mathbf{1}_{\Delta V^\alpha(t) > \delta} dt > \varepsilon/12 \right) = -\infty.$$

Notice in addition that:

$$\left\{ \sup_{h \leq \eta} \frac{1}{T_0} \int_0^{T_0-h} \mathbf{1}_{\Delta V^\alpha(t+h) > \delta} dt > \varepsilon/12 \right\} \subset \left\{ \frac{1}{T_0} \int_0^{T_0} \mathbf{1}_{\Delta V^\alpha(t) > \delta} dt > \varepsilon/12 \right\}.$$

As a result, (B.21) holds as soon as:

$$\limsup_{\alpha \rightarrow 0} \limsup_{\eta \rightarrow 0} \limsup_{N \rightarrow \infty} \frac{1}{N} \log \mathbb{P}_{r, \beta}^N \left(\text{for a.e. } t \in [0, T_0], \Gamma_t \in \mathcal{E}_r(d); \sup_{h \leq \eta} \lambda \left[\Delta_h(t) \geq \varepsilon/2, |\Delta V^\alpha(t)| \leq \delta, |\Delta V^\alpha(t+h)| \leq \delta \right] > \varepsilon/12 \right) = -\infty, \quad (\text{B.22})$$

where λ is T_0^{-1} times the Lebesgue measure on $[0, T_0]$. By Lemma B.12 on exponential tightness in $d_S^{L^1}$ topology, (B.22) is proven as soon as the following holds:

$$\limsup_{\alpha \rightarrow 0} \limsup_{\eta \rightarrow 0} \limsup_{N \rightarrow \infty} \frac{1}{N} \log \mathbb{P}_{r, \beta}^N \left(\text{for a.e. } t \in [0, T_0], \Gamma_t \in \mathcal{E}_r(d); \sup_{\substack{(s, t) \in [0, T_0]^2 \\ |s-t| \leq \eta}} d^{L^1}(\Gamma_s, \Gamma_t) < \alpha^2(e^\beta - 1)/2; \right. \\ \left. \sup_{h \leq \eta} \lambda \left[\Delta_h(t) \geq \varepsilon/2, |\Delta V^\alpha(t)| \leq \delta, |\Delta V^\alpha(t+h)| \leq \delta \right] > \varepsilon/12 \right) = -\infty, \quad (\text{B.23})$$

Take $\delta < (e^\beta - 1)/2$ and an arbitrary $\alpha \in (0, \varepsilon/2]$. For any trajectory $(\Gamma_t)_{t \in [0, T_0]}$ in the event inside the probability in (B.23), there must be $t \in [0, T_0]$ and $h < \eta$ such that, simultaneously:

- The north poles of Γ_t, Γ_{t+h} are at vertical distance at least $\varepsilon/2$, so that either $\{x \in \Gamma_t : x \cdot e_2 \geq y_{\max}(\Gamma_t) - \alpha\} \cap \Gamma_{t+h} = \emptyset$ or $\{x \in \Gamma_{t+h} : x \cdot e_2 \geq y_{\max}(\Gamma_{t+h}) - \alpha\} \cap \Gamma_t = \emptyset$.
- Recall that $V^\alpha(t) = \alpha^{-2} |\{x \in \Gamma_t : x \cdot e_2 \geq y_{\max}(\Gamma_t) - \alpha\}|$. $V^\alpha(\Gamma_t)$ and $V^\alpha(\Gamma_{t+h})$ are both at least $e^\beta - 1 - \delta > (e^\beta - 1)/2$ so that, by the first point, the difference in volume between Γ_t and Γ_{t+h} is at least $\alpha^2(e^\beta - 1)/2$;
- yet, $d^{L^1}(\Gamma_t, \Gamma_{t+h}) < \alpha^2(e^\beta - 1)/2$, which is incompatible with point 2. This concludes the proof. \square

Remark B.16. The proof for y_{\min} , x_{\min} and x_{\max} is identical to the above. For the w_k , i.e. $L_1 \cdot e_1, L_2 \cdot e_2, L_3 \cdot e_1$ and $L_4 \cdot e_2$, slight modifications are required: in addition to the indicator functions on the volumes $\Delta V^\alpha(t) < \delta$, $\Delta V^\alpha(t+h) < \delta$, one has to introduce the events $\{g_\alpha^\pm(t+h) < \delta\}, \{g_\alpha^\pm(t) < \delta\}$, where g_α^\pm , the width of the level at distance α beneath the pole, is defined in Lemma B.13.

The idea is that if α is taken small enough as a function of ε and β (in practice, $(e^\beta - 1)^{-1}\varepsilon/2$ times a numerical constant), then the horizontal distance between $L_1(t) \cdot e_1$ and $L_1(t+h) \cdot e_1$ is going to be at least $\min\{g_\alpha^+(t+h) + g_\alpha^-(t), g_\alpha^+(t) + g_\alpha^-(t+h)\}$.

As a result, the set of points above $y_{\max}(\Gamma_t) - \alpha$ in Γ_t and the set of points above $y_{\max}(\Gamma_{t+h}) - \alpha$ in Γ_{t+h} are disjoint. Thanks to the indicator functions on the volumes ΔV^α , this implies a difference in volume, which is again impossible for η small enough. \blacksquare

Acknowledgement

The author would like to thank his Ph.D. advisor Thierry Bodineau for continuous help and discussions on the content of this article.

References

- [BBP17a] Lorenzo Bertini, Paolo Buttà, and Adriano Pisante. Stochastic Allen–Cahn equation with mobility. *Nonlinear Differential Equations and Applications*, 24(5):54, 2017.
- [BBP17b] Lorenzo Bertini, Paolo Buttà, and Adriano Pisante. Stochastic Allen–Cahn approximation of the mean curvature flow: large deviations upper bound. *Archive for Rational Mechanics and Analysis*, 224(2):659–707, 2017.

- [BBP18] Lorenzo Bertini, Paolo Buttà, and Adriano Pisante. On large deviations of interface motions for statistical mechanics models. In *Annales Henri Poincaré*, pages 1–37. Springer, 2018.
- [BDH16] Anton Bovier and Frank Den Hollander. *Metastability: a potential-theoretic approach*, volume 351. Springer, 2016.
- [BLM09] Lorenzo Bertini, Claudio Landim, and Mustapha Mourragui. Dynamical large deviations for the boundary driven weakly asymmetric exclusion process. *The Annals of Probability*, 37(6):2357–2403, nov 2009.
- [Bre10] Haim Brezis. *Functional analysis, Sobolev spaces and partial differential equations*. Springer Science & Business Media, 2010.
- [BSS93] Guy Barles, H Mete Soner, and Panagiotis E Souganidis. Front propagation and phase field theory. *SIAM Journal on Control and Optimization*, 31(2):439–469, 1993.
- [CDMGP16] Gioia Carinci, Anna De Masi, Cristian Giardinà, and Errico Presutti. *Free boundary problems in PDEs and particle systems*. Springer, 2016.
- [CK08] Lincoln Chayes and Inwon C Kim. A two-sided contracting Stefan problem. *Communications in Partial Differential Equations*, 33(12):2225–2256, 2008.
- [CKG12] Lincoln Chayes, Inwon C Kim, and Changfeng Gui. The supercooled Stefan problem in one dimension. *Communications on Pure & Applied Analysis*, 11(2), 2012.
- [CL07] Raphaël Cerf and Sana Louhichi. The initial drift of a 2d droplet at zero temperature. *Probability Theory and Related Fields*, 137(3-4):379–428, 2007.
- [CMST11] Pietro Caputo, Fabio Martinelli, François Simenhaus, and Fabio Lucio Toninelli. “Zero” temperature stochastic 3D Ising model and dimer covering fluctuations: a first step towards interface mean curvature motion. *Communications on Pure and Applied Mathematics*, 64(6):778–831, 2011.
- [Com87] Francis Comets. Nucleation for a long range magnetic model. In *Annales de l’IHP Probabilités et statistiques*, volume 23, pages 135–178, 1987.
- [CS⁺96] L Chayes, G Swindle, et al. Hydrodynamic limits for one-dimensional particle systems with moving boundaries. *The Annals of Probability*, 24(2):559–598, 1996.
- [DMFL86] Anna De Masi, Pablo Augusto Ferrari, and Joel L Lebowitz. Reaction-diffusion equations for interacting particle systems. *Journal of statistical physics*, 44(3-4):589–644, 1986.
- [DMOPT93] Anna De Masi, E Orlandi, E Presutti, and L Triolo. Motion by curvature by scaling nonlocal evolution equations. *Journal of statistical physics*, 73(3-4):543–570, 1993.
- [DMOPT94] Anna De Masi, Enza Orlandi, Errico Presutti, and Livio Triolo. Glauber evolution with Kac potentials. i. mesoscopic and macroscopic limits, interface dynamics. *Nonlinearity*, 7(3):633, 1994.
- [EG15] Lawrence C Evans and Ronald F Gariepy. *Measure theory and fine properties of functions*. Chapman and Hall/CRC, 2015.

- [EK09] Stewart N Ethier and Thomas G Kurtz. *Markov processes: characterization and convergence*, volume 282. John Wiley & Sons, 2009.
- [ELS90] Gregory Eyink, Joel L Lebowitz, and Herbert Spohn. Hydrodynamics of stationary non-equilibrium states for some stochastic lattice gas models. *Communications in mathematical physics*, 132(1):253–283, 1990.
- [ESS92] Lawrence C Evans, H Mete Soner, and Panagiotis E Souganidis. Phase transitions and generalized motion by mean curvature. *Communications on Pure and Applied Mathematics*, 45(9):1097–1123, 1992.
- [FS97] Tadahisa Funaki and Herbert Spohn. Motion by mean curvature from the Ginzburg-Landau interface model. *Communications in Mathematical Physics*, 185(1):1–36, 1997.
- [FT19] Tadahisa Funaki and Kenkichi Tsunoda. Motion by mean curvature from Glauber-Kawasaki dynamics. *Journal of Statistical Physics*, 177(2):183–208, 2019.
- [GMV20] Alexandre Gaudillière, Paolo Milanesi, and Maria Eulália Vares. Asymptotic exponential law for the transition time to equilibrium of the metastable kinetic Ising model with vanishing magnetic field. *Journal of Statistical Physics*, pages 1–46, 2020.
- [Ilm93] Tom Ilmanen. Convergence of the Allen-Cahn equation to brakke’s motion by mean curvature. *J. Differential Geometry*, 38(2):417–461, 1993.
- [KFH⁺20] Perla El Kettani, Tadahisa Funaki, Danielle Hilhorst, Hyunjoon Park, and Sunder Sethuraman. Mean curvature interface limit from Glauber+Zero-range interacting particles. *arXiv preprint arXiv:2004.05276*, 2020.
- [KL99] Claude Kipnis and Claudio Landim. *Scaling Limits of Interacting Particle Systems*. Springer Berlin Heidelberg, 1999.
- [KOV89] C Kipnis, S Olla, and SRS Varadhan. Hydrodynamics and large deviation for simple exclusion processes. *Communications on Pure and Applied Mathematics*, 42(2):115–137, 1989.
- [KS94] Markos A Katsoulakis and Panagiotis E Souganidis. Interacting particle systems and generalized evolution of fronts. *Archive for rational mechanics and analysis*, 127(2):133–157, 1994.
- [Lac14] Hubert Lacoïn. The scaling limit of polymer pinning dynamics and a one dimensional Stefan freezing problem. *Communications in Mathematical Physics*, 331(1):21–66, 2014.
- [Lif62] I.M. Lifshitz. Kinetics of ordering during second-order phase transitions. *Sov. Phys. JETP*, 15:939, 1962.
- [LST14a] Hubert Lacoïn, François Simenhaus, and Fabio Lucio Toninelli. The heat equation shrinks Ising droplets to points. *Communications on Pure and Applied Mathematics*, 68(9):1640–1681, jul 2014.
- [LST14b] Hubert Lacoïn, François Simenhaus, and Fabio Lucio Toninelli. Zero-temperature 2D stochastic Ising model and anisotropic curve-shortening flow. *Journal of the European Mathematical Society*, 16(12):2557–2615, 2014.

- [LT18] Benoît Laslier and Fabio Lucio Toninelli. Lozenge tiling dynamics and convergence to the hydrodynamic equation. *Communications in Mathematical Physics*, 358(3):1117–1149, 2018.
- [Mar99] Fabio Martinelli. Lectures on Glauber dynamics for discrete spin models. In *Lecture Notes in Mathematics*, pages 93–191. Springer Berlin Heidelberg, 1999.
- [OV05] Enzo Olivieri and Maria Eulália Vares. *Large deviations and metastability*, volume 100. Cambridge University Press, 2005.
- [Spo93] Herbert Spohn. Interface motion in models with stochastic dynamics. *Journal of Statistical Physics*, 71(5-6):1081–1132, jun 1993.
- [SS98] Roberto H Schonmann and Senya B Shlosman. Wulff droplets and the metastable relaxation of kinetic Ising models. *Communications in mathematical physics*, 194(2):389–462, 1998.