

Intrinsic Quality Factor Extraction of Multi-Port Cavity with Arbitrary Coupling

D. Frolov*

Fermi National Accelerator Laboratory, Batavia, IL 60510, United States

(Dated: September 1, 2022)

Many techniques used to measure intrinsic quality factors in superconducting accelerator cavities employ scalar methods of error correction. While these methods are approximate by definition they also demand for critically coupled cavity and matched test fixture. In this paper we derive exact analytic solutions for Q_0 based on vector S-parameters for arbitrary coupled cavity and non-ideal test fixture. We show that by using vector ratios of forward and scattered waves instead of scalar power balance method it is possible to precisely calculate Q_0 when cavity is not critically coupled to the RF source. Furthermore we explore general case when input and output ports of the cavity are not matched to Z_0 and when the test ports of the RF system itself are not matched to Z_0 . The analysis is expanded for a multi-port cavity and fundamental accuracy limitations of the obtained expressions for Q_0 are evaluated.

Keywords: superconducting RF, vertical test stand, cavity quality factor, coupling

I. INTRODUCTION

In superconducting RF accelerator field (SRF) intrinsic quality factor Q_0 of a cavity is the key parameter. Practical and theoretical developments in material science, aimed to improve cavity performance through surface physics understanding completely rely on Q_0 measurement, therefore it is critically important to ensure measurement accuracy and repeatability.

Determination of intrinsic quality factor and accelerating gradient is based on the analysis of the r.f. power that is reflected from the cavity, dissipated in the cavity and transmitted through it. For example, Fermilab and JLab are using procedure [1] for Q_0 measurement in vertical test stand (VTS). This procedure is based on methods of scalar network analysis (based on power measurement), however these methods are approximate by definition because exact wave distribution in the RF structures can be described only with complex numbers (vectors). Therefore such scalar methods can contain significant errors because features of r.f. networks with distributed parameters are not taken into account. Accuracy of procedure [1] was studied in [2], however vector errors were not taken into account.

Much more accurate methods of vector network analysis (based on magnitude and phase measurements) can be used for Q_0 measurement in VTS. Several ideas of such measurements with elements of vector correction have been proposed earlier. In [3], [4] authors used heuristic approach to demonstrate errors caused by the mismatches in VTS RF system and their dependence on phase shifts in cavity input transmission line. Much earlier at CERN [5] contribution of test fixture non-idealities to Q_0 error in scalar form was demonstrated.

Recently in [6] authors successfully used variable delay line installed between cavity and incident power source to characterize vector errors - a relatively time consuming manual method, used in special types of vector network analyzers (VNA) based on six-port reflectometers [7]. And in [8] authors used another method - cavity in a self excited loop connected to a commercial vector network analyzer to obtain vector data.

These experiments prove that vector correction for Q_0 measurement in VTS is practically possible, however accuracy limits are not understood well. In fact, all previous studies were done for single port or two-port cavities, do not have complete r.f. system models developed and only partially use the advantages of vector measurements: effects of field probe load mismatch are not studied, multiport cavities are not studied, there are no general equations for vector error correction specifically for multiport SRF cavities with arbitrary coupling, and therefore technical requirements for vector error corrected VTS do not exist yet.

In this paper we derive general equations of vector error correction for multiport cavities with arbitrary coupling and study their fundamental accuracy limitations.

II. INITIAL EQUATIONS

We will use lumped-element cavity model (a) and its impedance equivalent (b) shown in fig. 1 to derive port couplings and Q_0 first for two port cavity, and then for multiport cavity. Model (a) contains RF source impedance R_1 , input coupler in form of an equivalent transformer with ratio $1 : n_1$, cavity shunt resistance R_0 , equivalent L-C circuit, output coupler (field probe) with ratio $n_2 : 1$ and field probe load impedance R_2 .

The intrinsic Q_0 and loaded Q_L quality factors of

* Correspondence email address: dfrolov@fnal.gov

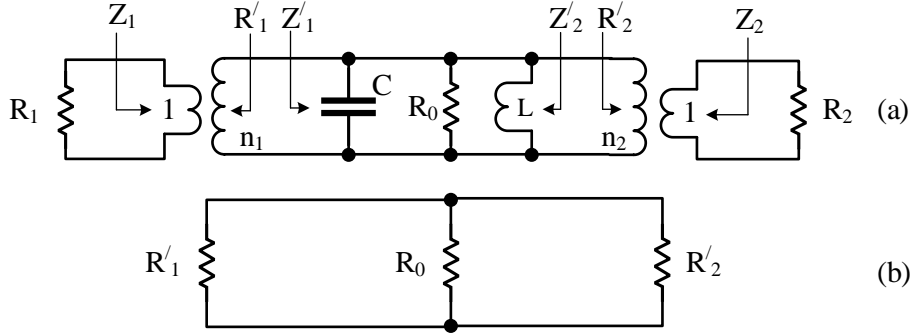

Figure 1. (a)- Lumped element two-port cavity model. (b)- equivalent circuit of model.

parallel L-C circuit are defined as (1).

$$\frac{1}{Q_0} = \frac{1}{R_0} \sqrt{\frac{L}{C}}, \quad \frac{1}{Q_L} = \left| \frac{1}{R_L} \right| \sqrt{\frac{L}{C}}. \quad (1)$$

From which Q_0 can be expressed as (2).

$$Q_0 = Q_L \left| \frac{R_0}{R_L} \right|. \quad (2)$$

Load impedance R_L can be found from equivalent circuit of the model fig. 1 (b) as (3).

$$\frac{1}{R_L} = \frac{1}{R_0} + \frac{1}{R'_1} + \frac{1}{R'_2}. \quad (3)$$

By substituting (3) into (2) and replacing impedance ratios with (4) intrinsic quality factor Q_0 can be written in form (5).

$$\beta_1 \equiv R_0/R'_1, \quad \beta_2 \equiv R_0/R'_2. \quad (4)$$

$$Q_0 = Q_L |1 + \beta_1 + \beta_2|. \quad (5)$$

By continuing this reasoning one can easily show fairness of expression (6) for a cavity with n number of ports.

$$Q_0 = Q_L \left| 1 + \sum_n \beta_n \right|. \quad (6)$$

The loaded quality factor Q_L is trivial and can be measured from the 3 dB bandwidth of cavity or from decay fit. In previous studies [3] authors considered systematic errors in Q_L measurement as deviation of Q_L measured with mismatched load R_1 from the ideal case with matched load. However, we find that more natural approach coming from the definition of the loaded

quality factor is to consider that Q_L is always measured correctly, because it is determined by the the actual *load*, that is not necessary matched. Therefore Q_L error doesn't depend on RF system mismatches, but errors exist in β_n measurements, so the goal is to find general definitions of β_n for arbitrary Z_n and R_n .

We will start with two-port cavity and then expand results for multipoint cavity. Here the notation is used where coefficients β'_1 of cavity input port, β'_2 of output port, α_1 of the RF source, α_2 of field probe load express their corresponding couplings to the transmission line with impedance Z_0 . For exact calculations these coupling coefficients *must* be complex numbers, since impedances Z_1 , Z_2 and R_1 , R_2 may not be purely resistive in general. Those skilled in the art may notice that in some SRF papers [1], [2] absolute value $|\beta'_1|$ is also known as β^* - the overall input coupling coefficient [9]. For model fig. 1(a) the following equations are valid:

$$R'_1 = R_1 \cdot n_1^2, \quad R'_2 = R_2 \cdot n_2^2, \quad (7)$$

$$n_1^2 = Z'_1/Z_1, \quad n_2^2 = Z'_2/Z_2, \quad (8)$$

$$\beta'_1 \equiv Z_1/Z_0, \quad \beta'_2 \equiv Z_2/Z_0, \quad (9)$$

$$\alpha_1 \equiv R_1/Z_0, \quad \alpha_2 \equiv R_2/Z_0. \quad (10)$$

By substituting expressions (8), (9), (10) into (7) one will find ratios (11).

$$\frac{R'_1}{Z'_1} = \frac{\alpha_1}{\beta'_1}, \quad \frac{R'_2}{Z'_2} = \frac{\alpha_2}{\beta'_2}. \quad (11)$$

From equivalent circuit in fig. 1(a) Z'_1 and Z'_2 can be found in form (12). By substituting (12) into (11) and

replacing R_1' and R_2' with R_0/β_1 , R_0/β_2 using (4) we finally find pair of linear equations (13).

$$\frac{1}{Z_1'} = \frac{1}{R_0} + \frac{1}{R_2'}, \quad \frac{1}{Z_2'} = \frac{1}{R_0} + \frac{1}{R_1'}. \quad (12)$$

$$\frac{\alpha_1}{\beta_1'}\beta_1 - \beta_2 = 1, \quad \frac{\alpha_2}{\beta_2'}\beta_2 - \beta_1 = 1. \quad (13)$$

Solution to this system can be easily found in form (14) where $\gamma_n = \alpha_n/\beta_n'$.

$$\beta_1 = \frac{\gamma_2 + 1}{\gamma_1\gamma_2 - 1}, \quad \beta_2 = \frac{\gamma_1 + 1}{\gamma_1\gamma_2 - 1}. \quad (14)$$

Addition of more ports to the cavity is equivalent to addition of more resistors in parallel to circuit in fig. 1(b), more $1/R'$ fractions to equation (3), and hence increasing total number of equations. By continuing the above reasoning one can show that for N-port cavity (13) will turn into system of N equations with equation number n in form (15).

$$\gamma_n\beta_n - \sum_{i=1}^N \beta_i + \beta_n = 1 \quad (15)$$

Therefore general definition of coupling β_n for N-port cavity with arbitrary Z_n and R_n can be written in matrix form (16).

$$\begin{pmatrix} \beta_1 \\ \beta_2 \\ \vdots \\ \beta_N \end{pmatrix} = \begin{pmatrix} \gamma_1 & -1 & \dots & -1 \\ -1 & \gamma_2 & \dots & -1 \\ \vdots & \vdots & \ddots & \vdots \\ -1 & -1 & \dots & \gamma_N \end{pmatrix}^{-1} \begin{pmatrix} 1 \\ 1 \\ \vdots \\ 1 \end{pmatrix} \quad (16)$$

For one-port cavity $\beta_1 = \beta_1'/\alpha$ is quite simple and in agreement with previous work [5], however for two-port cavity $\beta_1 = \frac{\beta_1'(\alpha_2 + \beta_2')}{\alpha_1\alpha_2 - \beta_1'\beta_2'}$ is more complicated and complexity increases with number of ports.

General solution (16), expression (6) and definition of γ_n lead to a conclusion that for cavity with any number of ports information about loaded quality factor Q_L , reflection coefficients from the cavity ports and test ports is sufficient to determine Q_0 .

III. Q_0 EXTRACTION FROM S-PARAMETERS

A. Exact solution

We express coupling to the transmission line with impedance Z_0 using complex reflection coefficients of the cavity ports Γ_n (corresponding to

impedances $Z_1 \dots Z_n$) and test ports L_n (corresponding to impedances $R_1 \dots R_n$) in fig. 1(a), so coefficients (9, 10) can be reformulated in form (17).

$$\alpha_n = 1 + L_n/(1 - L_n), \quad (17)$$

$$\beta_n' = 1 + \Gamma_n/(1 - \Gamma_n).$$

Hence, coupling ratio γ_n in the solution (16) can be expressed in form (18).

$$\gamma_n = \frac{(1 + L_n)(1 - \Gamma_n)}{(1 - L_n)(1 + \Gamma_n)}. \quad (18)$$

Using this notation, we find how Q_0 of two-port cavity can be extracted purely from S-parameters.

Input reflection coefficient Γ_1 of a two-port network terminated with load with reflection L_2 can be written as (19) by applying Mason's theorem [10] to flow graph in fig. 2.

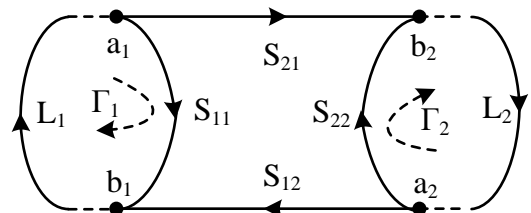

Figure 2. Flow graph of two-port cavity with source reflection L_1 and field probe load reflection L_2

$$\Gamma_1 = S_{11} + \frac{S_{21}S_{12}L_2}{1 - S_{22}L_2} \quad (19)$$

By analogy, reverse reflection coefficient Γ_2 can be written as (20).

$$\Gamma_2 = S_{22} + \frac{S_{12}S_{21}L_1}{1 - S_{11}L_1} \quad (20)$$

Hence, by substituting (19), (20) into (18) and using (14), (6), we find equation for Q_0 of two-port cavity extracted purely from cavity and test ports' S-parameters (21).

$$\begin{aligned}
Q_0 &= Q_L |1 + \beta_1 + \beta_2|, \\
\beta_1 &= \frac{(L_1 - 1)(S_{11} - L_2 S_{22} - B_2 + C_2 + 1)}{S_{11} - L_2 - L_1 + S_{22} + D}, \\
\beta_2 &= \frac{(L_2 - 1)(S_{22} - L_1 S_{11} - B_1 + C_1 + 1)}{S_{11} - L_2 - L_1 + S_{22} + D}, \quad (21)
\end{aligned}$$

where:

$$\begin{aligned}
B_n &= L_n S_{11} S_{22}, \\
C_n &= L_n S_{12} S_{21}, \\
D &= L_1 L_2 S_{11} + L_1 L_2 S_{22} - B_1 + C_1 - B_2 + C_2.
\end{aligned}$$

Equation (21) can be applied to measure Q_0 directly with VNA, coefficients L_1 and L_2 will correspond to ESF and ELF complex error factors according to the 12-term error model [11], [12], [13], [14] and can be extracted from the VNA calibration data or measured directly by connecting test ports of the VNA one to one.

It can be seen, that exact Q_0 solution (21) for 2-port cavity is quite bulky, and becomes significantly complicated if cavity has more ports, however using general definitions (16), (18) and Mason's theorem from the flow-graph theory one can find such exact solution for cavity with any amount of ports and arbitrary coupling, based only on the information about S-parameters, which can be directly measured with a multi-port VNA.

If VNA has high quality test cables and fixtures, we can approximate $L_1 \approx 0$, $L_2 \approx 0$ and then (21) will reduce to (22).

$$Q_0 \approx Q_L \left| \frac{-2}{S_{11} + S_{22}} \right| \quad (22)$$

The above found equations can be used both for room temperature and superconducting cavities. Our experience with ultra-high quality superconducting cavities [15] with Q_0 approaching 10^{12} have shown that inside dilution refrigerator, for example, cavity detuning due to microphonics is negligible, so phase locked loop is not required and S-parameters can be measured directly by moving calibration standards into cryogenic environment as it has been demonstrated in [16]. This is why using the above obtained equations can be extremely useful for material characterization and quantum information applications.

B. First order approximation

Accelerator cavities have specific features that significantly complicate usage of (21) for calculations. To achieve operating accelerating gradients of tens of megavolts per meter such cavities are tested at high levels of

input power, where usually only one input port is near critical coupling ($\beta \approx 1$) to the RF source. The output ports are usually significantly undercoupled ($\beta \ll 1$) and used as electric field probes. Under such conditions direct determination of cavity S-parameters becomes impossible because reflection measurements from the undercoupled ports demand for enormous power from the RF source to achieve high gradient of electric field in the cavity. Measurements at low power levels don't give accurate results for Q_0 because cavity parameters highly depend on gradient.

For many years different facilities used scalar power balance method to extract cavity ports' couplings and measure Q_0 . This method requires critical coupling of input coupler which in practice is frequently violated and causes significant errors, as shown in previous studies [3], [4]. By using vector parameters instead it is possible to achieve ultimate accuracy of cavity measurements in wide range of couplings.

On the example of our two-port cavity model we analyze what fundamental limitations on Q_0 accuracy are imposed by the lack of information about S_{22} . For the reasons explained above, when testing accelerating cavity it is possible to physically measure only ratios $R_{11} = b_1/a_1$ and $T_{21} = b_2/a_1$ of incident a_1 , transmitted b_2 and reflected b_1 waves of flow graph in fig. 2. By applying Mason's theorem to the flow graph, these ratios can be expressed as pair of linear equations (23).

$$\begin{aligned}
R_{11} &= \frac{S_{21} L_2 S_{12} + S_{11} (1 - L_2 S_{22})}{1 - (S_{21} L_2 S_{12} L_1 + S_{11} L_1 + L_2 S_{22}) + S_{11} L_1 L_2 S_{22}}, \\
T_{21} &= \frac{S_{21}}{1 - (S_{21} L_2 S_{12} L_1 + S_{11} L_1 + L_2 S_{22}) + S_{11} L_1 L_2 S_{22}}. \quad (23)
\end{aligned}$$

Such system (23) has four unknowns S_{11} , S_{21} , S_{12} , S_{22} and cannot be solved in general. It is physically possible, however, to design RF system in such way, that reflection coefficient L_2 will be negligibly small and since $L_2 \ll S_{22} < 1$ pair (23) will reduce to (24).

$$\lim_{L_2 \rightarrow 0} R_{11} = \frac{S_{11}}{1 - S_{11} L_1}, \quad \lim_{L_2 \rightarrow 0} T_{21} = \frac{S_{21}}{1 - S_{11} L_1}. \quad (24)$$

From (24) one can find cavity S_{11} and S_{21} in form of first order approximation (25) which will be valid only when $L_2 \rightarrow 0$. For N-port cavity, with $n = 2 \dots N$ under condition that $L_n \rightarrow 0$ it can be shown that transmission from first port to port n is expressed as (26).

$$S_{11} = \frac{R_{11}}{1 + L_1 R_{11}}, \quad S_{21} = \frac{T_{21}}{1 + L_1 R_{11}}. \quad (25)$$

$$S_{n,1} = \frac{T_{n,1}}{1 + L_1 R_{11}} \quad (26)$$

In situation when S_{22} can not be measured, the only way to find β_2 is to use power balance method. This can be done using definition (4). Since R_0 and R_2' are connected in parallel, voltage across them is the same and therefore impedance ratio R_0/R_2' is equal to inverse power ratio dissipated in these impedances. Assuming lossless coupler and perfectly matched R_2 , coupling coefficient β_2 can be defined as (27).

$$\beta_2 = \frac{R_0}{R_2'} = \frac{P_{R_2'}}{P_{R_0}} = \frac{P_{R_2}}{P_{R_0}} \quad (27)$$

Values P_{R_2} and P_{R_0} can be found using S-parameters and some incident power level P_i in form (28).

$$\begin{aligned} P_{R_2} &= P_i S_{21}^2, \\ P_{R_0} &= P_i - P_i S_{11}^2 - P_i S_{21}^2. \end{aligned} \quad (28)$$

Using (28) and (27) β_2 can be extracted purely out of cavity S-parameters (29).

$$\beta_2 = \frac{S_{21}^2}{1 - S_{11}^2 - S_{21}^2} \quad (29)$$

Coupling β_1 can be then found from one of the equations (13) in form (30).

$$\beta_1 = \frac{\beta_1'}{\alpha_1} (1 + \beta_2) \quad (30)$$

Since we assumed $L_2 = 0$, equation (19) will reduce to $\Gamma_1 = S_{11}$. By substituting this $\Gamma_1 = S_{11}$ and L_1 into (17) we find β_1' and α_1 . Coupling β_1 can be then expressed using only S-parameters and source reflection L_1 in form (31).

$$\beta_1 = \frac{S_{21}^2 (L_1 - 1)(S_{11} + 1)}{(L_1 + 1)(S_{11} - 1)(1 - S_{11}^2 - S_{21}^2)} \quad (31)$$

Finally, Q_0 can be found then in form (32).

$$Q_0 = Q_L \left| 1 + \frac{2S_{21}^2 (L_1 S_{11} - 1)}{(L_1 + 1)(S_{11} - 1)(1 - S_{11}^2 - S_{21}^2)} \right| \quad (32)$$

By continue this reasoning for N-port cavity one can show fairness of expression (33) for β_1 which follows from the equation (15); and show fairness of expression (34) for $n > 1$ which follows from the power balance.

$$\beta_1 = \frac{\beta_1'}{\alpha_1} \left(1 + \sum_{n=2}^N \beta_n \right) \quad (33)$$

$$\beta_n = \frac{S_{n,1}^2}{1 - \sum_{i=1}^N S_{i,1}^2}, \quad (n > 1) \quad (34)$$

Therefore for multiport cavity with arbitrary cavity and test ports coupling Q_0 can be extracted purely from S-parameters (35).

$$Q_0 = Q_L \left| 1 + \frac{(L_1 - 1)(S_{11} + 1)}{(L_1 + 1)(S_{11} - 1)} \Sigma_1 + \Sigma_1 \right|, \quad (35)$$

where:

$$\Sigma_1 = 1 + \sum_{n=2}^N \frac{S_{n,1}^2}{1 - \Sigma_2}, \quad \Sigma_2 = \sum_{i=1}^N S_{i,1}^2.$$

C. Second order approximation

When not only load match but also the RF source match are assumed perfect $L_1 = 0$, $\alpha_1 = 1$ equations (25), (33), (35) reduce to second order approximation (36), (37), (38).

$$S_{11} = R_{11}, \quad S_{21} = T_{21}. \quad (36)$$

$$\beta_1 = \beta_1' (1 + \beta_2 + \dots + \beta_n) \quad (37)$$

$$Q_0 = Q_L \left| 1 + \frac{(S_{11} + 1)}{(1 - S_{11})} \Sigma_1 + \Sigma_1 \right| \quad (38)$$

Because of its simplicity, many SRF facilities are using second order approximation, which of course leads to big errors if cavity is not critically coupled ($S_{11} \neq 0$). It is practically hard to make $L_1 = 0$, which is usually port reflection of high power circulator and can change significantly with temperature. Such measurements are typically done with power meters and lack of information about phase of S_{11} requires introducing additional coefficient $C_\beta = \pm 1$ before S_{11} in (38) to determine if cavity is undercoupled or overcoupled.

IV. Q_0 ACCURACY ASSESSMENT

Schappert [3] have pointed out that even in the critically coupled cavity, error in the loaded quality factor measurement due to source mismatch can reach 20% and higher. Our calculations show that in fact loaded quality factor error doesn't depend on mismatches but

coupling coefficients β_n contain such mismatch errors, which eventually lead to errors in Q_0 determination. Study of β_n errors therefore presents practical interest.

For exact solution (21) accuracy is mostly determined by the residual errors E_{xx} of S-parameters and reflection coefficients. These errors depend on the specific VNA and calibration kit being used and should be evaluated for each particular measurement using special metrological techniques (see p.178 in [11]). Such measurements using (21) provide ultimate accuracy limited by the VNA and results are traceable to national standards. Next we will show how approximations deviate from the results obtained with (21).

A. First order approximation

The first order approximation equations (23) demand for $L_2 \rightarrow 0$, this assumption allows to extract value of β_2 using power balance method. Therefore, reflection coefficient L_2 influences on the errors of β_2 and β_1 measurement that *cannot* be corrected. This error can be analytically evaluated using exact solution (21) for β_2 and β_1 in form of expressions (39) that depend only on S_{xx} and L_1, L_2 ; fractional error of β_2 with typical parameters of critically coupled two-port cavity $S_{11} = 0.01$ ($\beta_1 = 1.02$), $S_{22} = -0.818$ ($\beta_2 = 0.1$) is evaluated in fig. 3 and fractional error of β_1 it is evaluated in fig. 4.

$$\begin{aligned} \Delta\beta_2 &= \beta_2 \Big|_{L_2=0} - \beta_2 \Big|_{L_2 \neq 0}, \\ \Delta\beta_1 &= \beta_1 \Big|_{L_2=0} - \beta_1 \Big|_{L_2 \neq 0}. \end{aligned} \quad (39)$$

Assuming error of Q_L measurement is negligible, using definition (5), fractional error of Q_0 measurement for two-port cavity can be found in form (40). Behavior of this error is shown in fig. 5.

$$\frac{\Delta Q_0}{Q_0} = \frac{\Delta\beta_1 + \Delta\beta_2}{1 + \beta_1 + \beta_2} \quad (40)$$

It is practically very difficult to reach $L_2 = -30$ dB, in fact in most cases -25 dB is the best reflection one can achieve in a broadband loads used for vertical tests of SRF cavities. Therefore, fig. 4 and fig. 3 lead to important result: for critically coupled cavity and matched source $L_1 = 0$ practically achievable accuracy in power balance method is around 8...12% for β_2 and 4...8% for β_1 (since $S_{21} < 0.5$ typically), so Q_0 error can not be better than 5% using first order approximation for near critically coupled cavity ($\beta_1 = 1.02$), for wider range of couplings accuracy will depend on the residual errors of the test fixture.

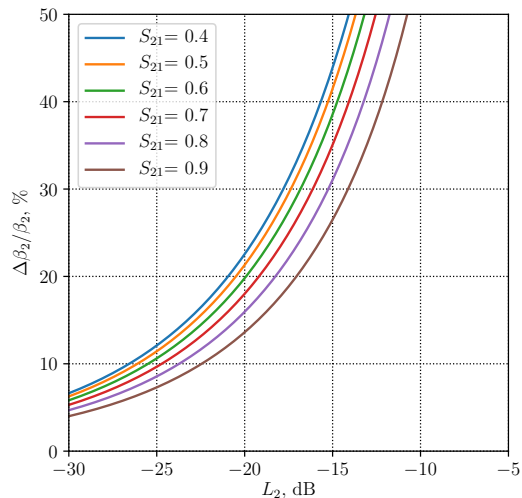

Figure 3. First order approximation error of β_2 measurement vs load L_2 reflection with various values of transmission coefficient S_{21} .

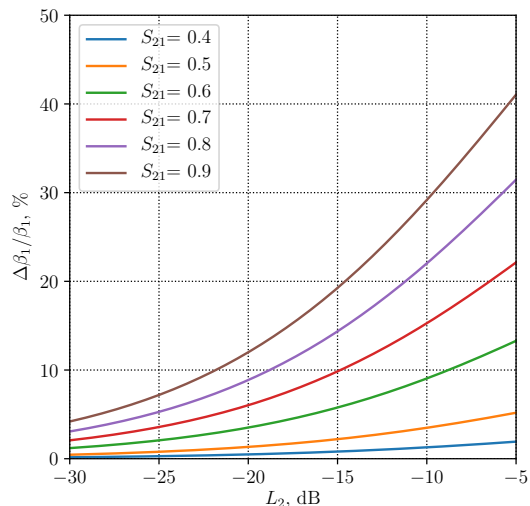

Figure 4. First order approximation error of β_1 measurement vs load L_2 reflection with various values of transmission coefficient S_{21} .

B. Second order approximation

For second order approximation reflection coefficient L_2 and L_1 influence the errors of β_2 and β_1 measurement that cannot be corrected. However L_2 can be made relatively small, so we study influence of L_1 on the error.

Using equations (21) and (41) we evaluate Q_0 accuracy for the case when cavity is undercoupled or overcoupled, and RF source has some mismatch ($L_1 \neq 0$). Based on the results from the previous section we will

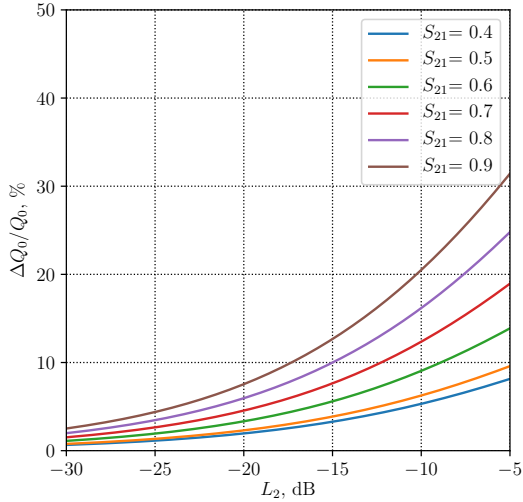

Figure 5. First order approximation error of Q_0 measurement of critically coupled cavity vs load L_2 reflection with various values of transmission coefficient S_{21} .

fix $L_2 = -25$ dB, $S_{21} = S_{12} = -8$ dB, $S_{22} = -1.7$ dB. These values give the following result shown in fig. 6.

It can be seen that even with critical coupling ($S_{11} = 0$) of the cavity input port, error of Q_0 measurement exceeds 10 %, which is higher than previous estimations because [2] assumed $L_1 = L_2 = 0$ and [3] assumed $L_2 = 0$. In fact, second order approximation assumption that $L_1 = 0$ and $L_2 = 0$ in majority cases is not valid. When L_2 and especially L_1 differ from zero, error depends on the type of cavity coupling (undercoupled for negative S_{11} , overcoupled for positive S_{21}). The behavior when for undercoupled mode error is lower than for overcoupled is in agreement with previous results [3].

However, coupling seen by the test port (output of the directional coupler in the test setup) depends on the phase of the reflected signal and without vector calibration doesn't depend on type of cavity coupling. Therefore, if cavity is not critically coupled, Q_0 error will depend on distance between test port (RF reflectometer) and cavity input port. This is demonstrated in fig. 7 where S_{11} is multiplied by $\exp(j2\pi L/\lambda)$, where L is distance and λ is wavelength at 1.3 GHz. This vector error cannot be corrected with scalar test setup based on powermeters, a full featured vector receiver should be used instead.

$$\begin{aligned} \Delta\beta_2 &= \beta_2 \Big|_{L_1=L_2=0} - \beta_2 \Big|_{L_2=-25 \text{ dB}, L_1 \neq 0}, \\ \Delta\beta_1 &= \beta_1 \Big|_{L_1=L_2=0} - \beta_1 \Big|_{L_2=-25 \text{ dB}, L_1 \neq 0}. \end{aligned} \quad (41)$$

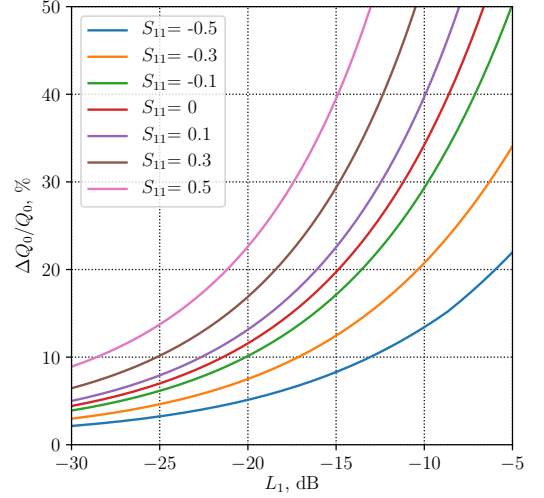

Figure 6. Second order approximation error of Q_0 measurement cavity with $S_{21} = 0.4$, $L_2 = -25$ dB and various input couplings S_{11} vs load L_1 reflection.

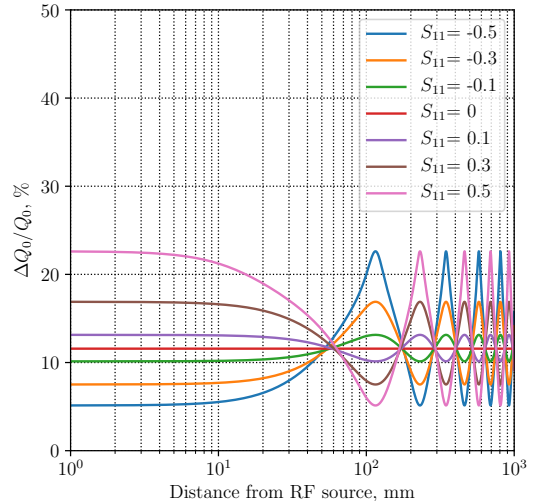

Figure 7. Second order scalar approximation error of Q_0 measurement cavity with $S_{21} = 0.4$, $L_2 = -25$ dB, $L_1 = -20$ dB, and various input couplings S_{11} vs distance from the RF source.

V. DISCUSSION

Developments in SRF material science depend on accuracy of cavity testing. While for critically coupled cavity measured with traditional approach (second order approximation) result contains stable systematic bias, even small deviations from critical coupling will cause oscillation of this bias. This means that the same cavity can give >20 % span in measured quality factor if tested in the same Dewar but with different cables.

It is even more evident that span will be observed in cavities tested at different facilities. Traditionally such errors are avoided by using variable coupler, which can be slow and should be custom-made for each new type of cavity. But research and development process requires rapid testing of multiple cavities of different types. In such conditions vector error correction using first order approximation obtained in this paper provides the fastest and most accurate way of cavity testing. The engineering challenge for such correction is measurement of cavity S-parameters in presence of phase locked loop, wide range of power levels and cryogenic cable vector calibrations. Such system is currently under development at Fermilab.

VI. CONCLUSION

In this paper we derived Q_0 equations for cavities with any amount of ports, arbitrary coupling and load mismatch for each port. These equations can be used both for normal conducting cavities and superconducting cavities. Exact analytic solution is found for Q_0 based purely on S-parameters and load reflections, that could be directly measured with VNA. This solution shows that for accelerator cavities tested using power balance method Q_0 accuracy is fundamentally limited by the load reflection that cannot be corrected without cavity measurement in the reverse direction. Therefore we formally described two approximations of the exact Q_0 solution, first when load reflection is assumed

perfect, and second when also RF source reflection is assumed perfect that allow to find cavity parameters without reverse measurement. The ultimate Q_0 accuracy provided by exact solution can not be achieved for superconducting accelerating cavity because of technical limitations, however rather low error $\approx 5\%$ can be achieved using first order approximation, instead of scalar second order approximation currently used in majority of SRF facilities that can give $>10\%$ error even with critically coupled cavity and much higher for undercoupled or overcoupled cavities.

As a result we find first order approximation as preferred method for SRF cavities. Practical implementation of this method will require replacement of scalar RF system based on power meters with full-featured vector receivers and vector calibration system. Such RF system and its calibration is subject for separate discussion.

ACKNOWLEDGMENTS

Author would like to acknowledge R. Pilipenko for help in understanding features of existing VTS system at Fermilab and A. Romanenko for the support of this work, as well as A. Babenko for discussion of microwave measurements and error models. This manuscript has been authored by Fermi Research Alliance, LLC under Contract No. DE-AC02-07CH11359 with the U.S. Department of Energy, Office of Science, Office of High Energy Physics.

-
- [1] Tom Powers, *Theory and Practice of Cavity RF Test Systems*, (Proceedings of the 12th International Workshop on RF Superconductivity, Cornell University, Ithaca, New York, 2005)
 - [2] O. Melnychuk, A. Grassellino and A. Romanenko *Error Analysis of Intrinsic Quality Factor Measurement in Superconducting Radio Frequency Resonators*, (Review of Scientific Instruments **85**, 124705 (2014))
 - [3] W. Schappert, et al. *Systematic Uncertainties in RF-Based Measurement of Superconducting Cavity Quality Factors*, (Proceedings of SRF2015, Whistler, Canada, 2015, pp. 814-818)
 - [4] J.P.Holzbauer, et al. *Systematic uncertainties in RF-based measurement of superconducting cavity quality factors*, (Nuclear Instruments and Methods in Physics Research Section A: Accelerators, Spectrometers, Detectors and Associated Equipment, Volume 830, 11 September 2016, Pages 22-29)
 - [5] E. Haebel *Pulsed Superconducting Cavity Measurements in The Presence of a Source Mismatch Error*, (CERN/EF/RF 88-2, 1 September 1988)
 - [6] J.P.Holzbauer, et al. *Improved RF measurements of SRF cavity quality factors*, (Nuclear Instruments and Methods in Physics Research Section A: Accelerators, Spectrometers, Detectors and Associated Equipment, Volume 913, 1 January 2019, Pages 7-14)
 - [7] Cletus A. Hoer *A Network Analyzer Incorporating Two Six-Port Reflectometers*, (IEEE Transactions on Microwave Theory and Techniques, Vol. MTT-25, No. 12 December, 1977)
 - [8] Vitaliy A. Goryashko, et al *A Method for High-Precision Characterization of the Q-Slope of Superconducting RF Cavities*, (IEEE Transactions on Microwave Theory and Techniques, Vol. 64, No. 11 November, 2016)
 - [9] F. F. Mende, I. N. Bondarenko, and A. V. Trubitsyn, *Superconducting and Refrigerated Resonant Systems, [in Russian]* (Naukova Dumka, Kiev, 1976, p.146)
 - [10] Stephen F. Adam *Microwave Theory And Applications*, (Hewlett-Packard, 1969, p.105)
 - [11] Joel P. Dunsmore *Handbook of Microwave Measurements: with advanced VNA techniques*, (John Wiley & Sons, 2012, p.126, p.178)
 - [12] Michael Hiebel *Fundamentals of Vector Network Analysis*, (Rohde & Schwarz, Fifth edition 2011, p.114)
 - [13] Roger B. Marks *Formulations of the Basic Vector Net-*

- work Analyzer Error Model including Switch Terms*, (50th ARFTG Conference Digest, 4-5 December, Portland, Oregon, 1997)
- [14] W. Kruppa, K.F. Sodomsky *An Explicit Solution for the Scattering Parameters of a Linear Two-Port Measured with an Imperfect Test Set*, (IEEE Transactions on Microwave Theory and Techniques, Vol. 19, Issue 1 January, 1971)
- [15] A. Romanenko et al *Three-Dimensional Superconducting Resonators at $T < 20$ mK with Photon Lifetimes up to $\tau = 2$ seconds*, (Phys. Rev. Applied 13, 034032 – Published 12 March 2020)
- [16] Leonardo Ranzani et al. *Two-port microwave calibration at millikelvin temperatures*, (Review of Scientific Instruments **84**, 034704 (2013))