

Quality Guided Sketch-to-Photo Image Synthesis

Uche Osahor Hadi Kazemi Ali Dabouei Nasser Nasrabadi
West Virginia University

{uo0002, hakazemi, ad0046}@mix.wvu.edu, nasser.nasrabadi@mail.wvu.edu

Abstract

Facial sketches drawn by artists are widely used for visual identification applications and mostly by law enforcement agencies, but the quality of these sketches depend on the ability of the artist to clearly replicate all the key facial features that could aid in capturing the true identity of a subject. Recent works have attempted to synthesize these sketches into plausible visual images to improve visual recognition and identification. However, synthesizing photo-realistic images from sketches proves to be an even more challenging task, especially for sensitive applications such as suspect identification. In this work, we propose a novel approach that adopts a generative adversarial network that synthesizes a single sketch into multiple synthetic images with unique attributes like hair color, sex, etc. We incorporate a hybrid discriminator which performs attribute classification of multiple target attributes, a quality guided encoder that minimizes the perceptual dissimilarity of the latent space embedding of the synthesized and real image at different layers in the network and an identity preserving network that maintains the identity of the synthesised image throughout the training process. Our approach is aimed at improving the visual appeal of the synthesised images while incorporating multiple attribute assignment to the generator without compromising the identity of the synthesised image. We synthesised sketches using XDOG filter for the CelebA, WVU Multi-modal and CelebA-HQ datasets and from an auxiliary generator trained on sketches from CUHK, IIT-D and FERET datasets. Our results are impressive compared to current state of the art.

1. Introduction

Facial sketches drawn by forensic artists aimed at replicating images dictated verbally are a popular practice for law enforcement agencies, these sketches are meant to represent the true features of the individual of interest. Unfortunately, we cant strictly depend on these sketches as the only means for biometric identification.

Sketches can be seen as images that contain minimal

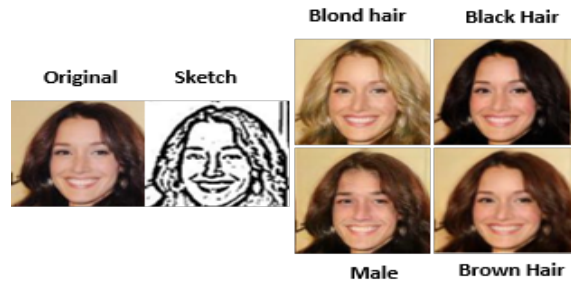

Figure 1: Samples of synthesised images with unique attributes. While training the model, a sketch is conditioned to randomly selected attributes. The final outcome is a group of synthesised RGB images with unique attributes such as male, blond, black and brown hair respectively.

pixel information bounded by edges that could be translated into photo-realistic images with significant features and pixel content [5]. Edge information from such sketches might contain key structural information that aid in providing high quality visual rendition, which is crucial in classifying images as valuable or not. In general, an image could be interpreted as bounded pixels comprising of content and style. Thus, we could either derive sketches manually; from an expert, novice, or through a computer algorithm [22]. However, sketches have no standard style template regardless of the mode from which they are drawn or crafted, and as a result, it becomes pretty difficult to translate sketches to images seamlessly [29]. In the sphere of image translation, images can generally be translated from Image to Image (I2I), Sketch to Image (S2I), Edge to Image (E2I), etc. In general, most of the techniques rely on disentangling the image into content and style powered by frameworks that adapt a cycled consistency of conditional generative models [16, 3, 43, 26]. However, the tendency to obtain rich pixel content with perceptual quality and discriminative information is still a daunting task, especially for models that move from strictly edge strokes to photo-realistic images.

Scientists and engineers have focused their prowess on developing various solutions that are aimed at translating images from one domain to another, such solutions could be

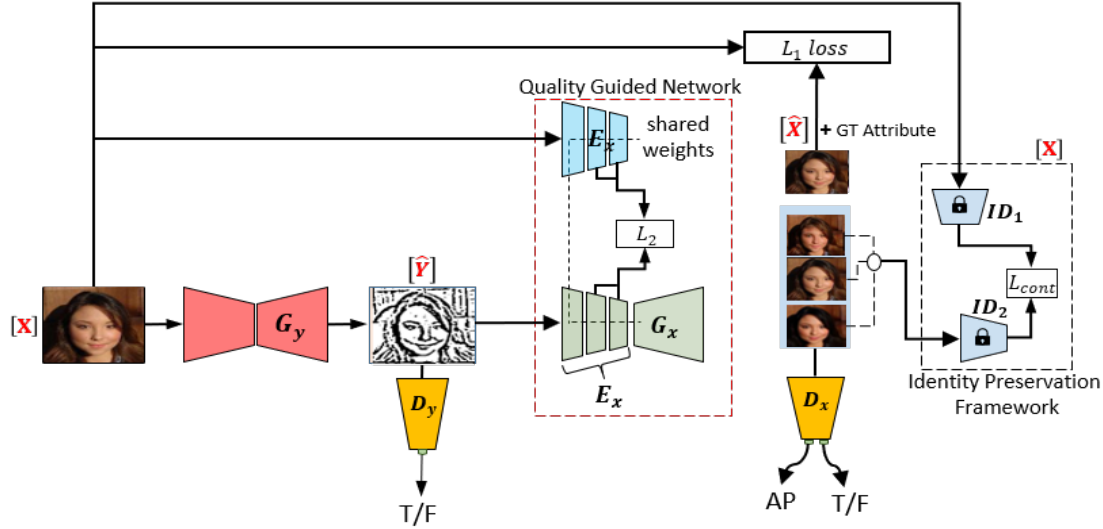

Figure 2: The structure shows the generator and a quality-guided encoder E_x configuration (i.e, green: G_y , G_x and light blue: E_x) with a 256×256 8-channel input X , representing a 3-channel RGB image + 5-channel attribute labels. At user specified points along the feature extraction pipeline of E_x and G_x , the dissimilarity in feature maps are minimized by an L_2 loss. The hybrid discriminator (yellow: D_y and D_x) extracts features into the last layer where True/False predictions are made and attribute classification on the 256×256 3-channel is executed to ensure multi-domain adaptation. An identity preserving network comprising of two deep encoders with frozen weights ID_1 and ID_2 computes a contrastive loss L_{cont} on real and synthesised fake images.

related to image colorization, style transfer, multi-domain attribute learning and joint optimization [7, 46, 23, 10, 36]. These aforementioned techniques utilize models that are either supervised or unsupervised, whose inputs are fed with either conditioned or unconditioned variables.

Deep Convolutional Neural Networks (DCNN) have evolved into a powerful tool that has made significant advancements in the machine learning and computer vision community and has become valuable in designing machine learning models used to solve image translation problems [35, 37]. Their combination with generative models including generative adversarial networks (GANs) [16, 19, 41, 6], variational auto-encoders [21], and auto-regressive models [28] have also achieved significant performance in learning and modeling various data distributions.

Our proposed model synthesizes sketches to produce high-resolution images with a multi-attribute allocating generator that learns to generate images of the same identity but with different target attributes as shown in Figure 1. The final model is a GAN network that transitions from sketches to visually convincing images. To improve quality as compared to state of the art, we introduced a quality-guided network that minimizes the perceptual dissimilarity of the latent space embedding of the synthesized and real image at different sections in the network and an identity preserving network that maintains the biometric identity. [34].

- We adopt a single generator for the task of sketch-to-photo synthesis which generates a group of unique attribute guided images of the same subject without compromising the identity of the subject [9]. We also incorporated a verifier that maintains the identity of each subject regardless of the attribute guided image.
- We develop a single hybrid discriminator that predicts and distinguishes real and synthesized photos according to the set of desired attributes.
- We adopt a quality-guided encoder which minimises the dissimilarity of the projected latent space of any pair of real and fake images to improve quality.

2. Related Work

Generative Adversarial Networks. Adversarial networks [11] have shown great possibilities in the image generation sphere. The main idea behind GANs is to develop an adaptive loss function that improves simultaneously with the generator model. This loss function is formalized by a trainable discriminator which aims to distinguish between the real and generated samples. During the training process, the generator learns to produce more realistic samples in order to fool the discriminator. Recent works showcase

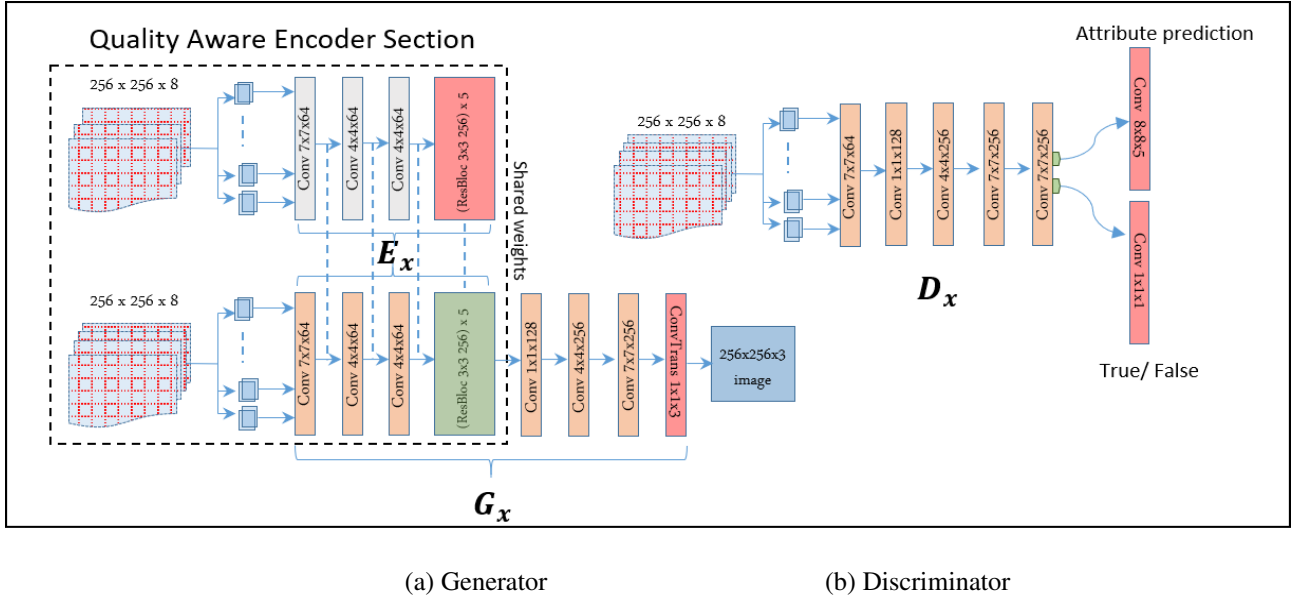

Figure 3: The proposed architecture is an approach to synthesize realistic images from sketches. (a) The structure shows the generator configuration with a $256 \times 256 \times 8$ -channel input representing a 3-channel RGB image + 5-channel attribute labels coupled with the quality guided encoder E_x . At user specified points along the feature extraction pipeline, feature and the corresponding features from G_x interact to minimise an L_2 dissimilarity loss. (b) The hybrid discriminator extracts features into the last layer where True/False predictions are made and attribute classification is executed to ensure multi-domain adaptation.

the inclusion of conditional constraints [42, 39] while training GANs on images, text, videos and 3D objects and a medley of the aforementioned concepts. Despite the proven capacity of GANs in learning data distributions, they suffer from two major issues, namely the unstable training and mode collapse.

Sketch to image synthesis (S2I). Sketch to image synthesis can be classified into indirect retrieval and direct synthesis. Indirect image retrieval techniques attempt to solve the sketch to image problem by trying to reduce the domain gap between sketches and photos. However, this approach becomes problematic especially when considering unaligned dataset pairs. Few techniques [31] have incorporated GAN into S2I synthesis by applying dense sketches and color stroke as inputs. However, complications arise for the GAN architecture due to its inability to accurately assign colors within the boundaries of the object in the image frame. Sketchy-GAN [5] proposed a GAN-based end-to-end trainable S2I approach by augmenting a sketch database of paired photos and their corresponding edge maps.

Sketch-based image retrieval. Most image retrieval methods [8, 13] use bag of words representations and edge detection to build invariant features across both domains (sketch and RGB images). However this approach failed to form rich pixel image retrieval and also failed to map from badly drawn sketches to photo boundaries. Zhu *et*

al. [47] attempted to solve this problem by treating the image retrieval as a search in the learned feature embedding space. Their approach showed significant progress by registering more realistic fine-grained images and instance-level retrieval.

Image to image translation (I2I). Isola *et al.* [16] proposed the first framework for I2I based on conditional GANs. Recent works have also attempted to learn image translation with little to no supervision. Some concepts enforce the translation to preserve important properties of the source domain data. The cycle consistency approach is based on the rationale that if an image can be mapped back to its original source, the network is forced to produce more fine grained images with better quality. Huang *et al.* [15] explored the latent space such that corresponding images in two different domains are mapped to the same latent code; a key struggle for the I2I translation problem is the diversity in translated outputs. Some works tried to solve the problem by simultaneously generating multiple outputs from the conditioned input variables. However, the outputs were limited to a few discrete outputs.

2.1. Preliminaries

GANs are generative models that learn the statistical distribution of training data [11], which permits the synthesis of data samples from random noise z to an output image \hat{x} .

Such networks can also be translated in a conditional state that depends on an input image x . The generator model $G(z \sim q(z|x))$ is trained to generate images which are non-distinguishable from their real samples by a discriminator network D . Simultaneously, the discriminator is learning to identify the fake synthesized images by the generator. The objective function is given as:

$$\min_G \max_D V(D, G) = \mathbb{E}_{x \sim p_{data}(x)} [\log D(z|x)] + \mathbb{E}_{z \sim p_{data}(z)} [\log(1 - D(G(z|x)))] \quad (1)$$

3. Multi-Domain Sketch-to-Image Translation

We established a mapping function between two domains, $\{x_i\}_{i=1}^n \in \mathcal{X}$ for images and $\{y_i\}_{i=1}^n \in \mathcal{Y}$ for sketches, where $X = \{x_i\}_{i=1}^n$ and $Y = \{y_i\}_{i=1}^n$. Our objective function contains an adversarial loss which moves the distribution $P(x_i)$ toward the distribution of the target domain $P(y_i)$, an attribute classification loss is integrated into the discriminator to identify attributes of interest and a cyclic constrain that maps a target to their original domain $G_x(x) = P(x_i \rightarrow \hat{y}_j | x_i)$ and $G_y(y) = P(\hat{y}_j \rightarrow \hat{x}_i | y_j)$ is implemented, where \hat{x}_i and \hat{y}_i represent reconstructed fake images in each respective domain (\mathcal{X}, \mathcal{Y}).

To improve the quality of synthesised images, we introduced a quality-guided network that extracts feature maps from specific layers ϕ_i of the encoding section of generator G_x for both real and synthesized pairs and computed an L_2 loss to minimize the dissimilarity. We also fused the latent feature maps extracted from the VGG-16 pretrained model for both the synthesised images $\{\phi_i(\hat{x}), \phi_j(\hat{y})\}$ and their corresponding original image $\{\phi_i(x), \phi_j(y)\}$ to compute the content and style loss between the pair of fake and real images. Identity preservation is achieved for the model with a contrastive loss computation over the real and synthesised image pair using the DeepFace pretrained model, this is to ensure that the synthesised images preserve their verification integrity while training. The resultant architecture is a DCNN structure that aids the network produce quality images [45, 14], as shown in Figure 2. With this approach, we eased the burden on the generator and scaled the problem into smaller tasks; making it easier for each intermediate section of the model to identify small challenges like edge detection, color balance, global and local feature learning, yet minimizing computation time.

Figure 3 illustrates the internal structure of the generator and hybrid-discriminator. Adversarial losses [11] were applied to the mapping function $G_y(x) : \mathcal{X} \rightarrow \mathcal{Y}$. The generator G_y is trained to synthesize images $G_y(x)$.

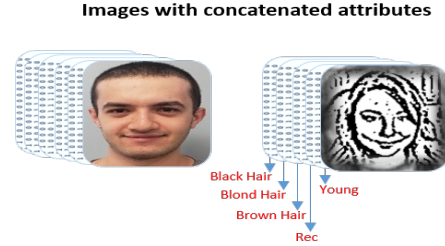

Figure 4: The input template are an attribute concatenation representation for all the training data for both RGB images and sketches. We spatially replicate the labels into image layers and concatenate them with the input images, forming a total of 5 channels for attributes [black hair, blond hair, brown hair, young and rec (ground-truth label)] + 3 channels for sketch and RGB images, respectively.

The objective function is defined as:

$$\mathcal{L}_{adv}(G, D, X, Y) = \sum_{i=0}^{m-1} \{ \mathbb{E}_{y \sim p_{data}(y)} [\log D_i(y)] + \mathbb{E}_{x \sim p_{data}(x)} [\log(1 - D_i(G_i(x)))] + \sum_{i=0}^{m-1} \mathbb{E}_{x \sim p_{data}(x)} [\log D_i(x)] + \mathbb{E}_{y \sim p_{data}(y)} [\log(1 - D_i(G_i(y)))] \} \quad (2)$$

3.1. Quality guided network

Image quality is crucial for sketch to image synthesis, but most GAN networks fail to improve the quality of images due to GANs tendency to only capture a subset of the variation and deep features found in the training data [18]. Hence, applying statistical computations on mini batches has become crucial for improving the overall GAN performance as shown in Figure 5, we use this approach towards improving the quality and variation of the data. The encoder network E_x is initialized to share weights with the encoding section of the sketch to image generator G_x , we use this technique to ensure that the discriminator guides the performance of E_x at different resolution stages to improve overall image quality in G_x . For each minibatch, we compute the standard deviation for each feature, which we average over all the features and spatial locations [20], we then project the resolved scalar solution as an extra channel towards the end layers of the discriminator D_x . For the intermediate layers of the quality aware network, we fade in new layers smoothly as we transition between layers per minibatch. To ensure the network maintains stability, we locally normalize the feature vector in each pixel to unit length in the generator after each convolution layer. The expression is given as:

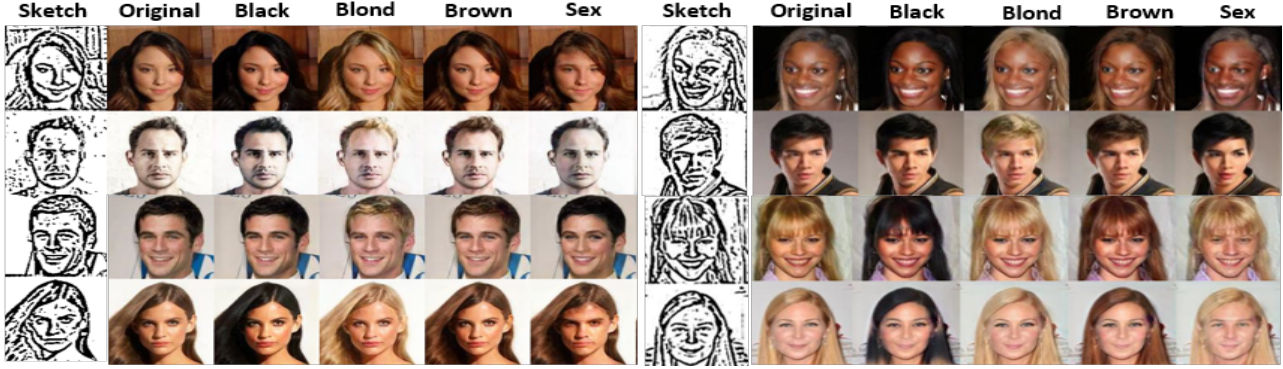

Figure 5: A spectrum of synthesised Images with different target attributes.

$$b_{xy} = \frac{a_{x,y}}{\sqrt{\frac{1}{N} \sum_{j=0}^{N-1} (a_{x,y})^2 + \epsilon}}, \quad (3)$$

where $\epsilon = 10^8$ N is the number of feature maps, $a_{x,y}$ and $b_{x,y}$ are normalized feature vectors in pixel(x, y), respectively. Finally, an L_2 loss is computed for each of the corresponding layers E_x and the encoding section of G_x .

3.2. Identity preservation

To design a robust sketch to image synthesis model, the identity of individual subjects must be consistent with zero tolerance for identity mismatching [32], which is obviously crucial for applications such as forensic analysis. Due to the degree of sensitivity of face verification, We incorporated a pretrained DeepFace verification model, sensitive to the identity features of a face trained with millions of faces. We choose the DeepFace model [34] because it depends on DCNNs to directly optimize the embedding which is preferable to other techniques that use an intermediate bottleneck layer. We applied the contrastive loss [12] from the features extracted from the DeepFace model for pairs of real and synthesised images to maintain the hidden relationship between the original image and the synthesised target image in a common latent embedding space. The contrastive loss ensures that the semantic similar pairs of real and synthesised images share a common embedding while dissimilar images (impostor pairs) are pushed apart.

The contrastive loss is expressed as:

$$\begin{aligned} \mathcal{L}_{cont}(\varphi_i(x_i), \varphi_j(y_i), Y) &= (1 - Y) \frac{1}{2} (D_\varphi)^2 \\ &+ (Y) \frac{1}{2} (\max(0, m - D_\varphi))^2, \end{aligned} \quad (4)$$

where y_i and x_i represent the synthesised and real image respectively. The variable Y is a binary label, which is equal to 0 if y_i and x_i belong to the same class, and equal to 1 if y_i and x_i belong to a different class. $\varphi(\cdot)$ denotes the

encoding functions of the encoder that transforms y_i and x_i respectively into a common latent embedding subspace. The value m is the contrastive margin and is used to tighten the constraint. D_φ denotes the Euclidean distance between the outputs of the functions $\varphi_i(x_i), \varphi_j(y_i)$.

$$D_\varphi = \|\varphi_i(x_i) - \varphi_j(y_i)\|_2, \quad (5)$$

If $Y = 0$ (genuine pair), the contrastive loss becomes:

$$\mathcal{L}_{cont}(\varphi_i(x_i), \varphi_j(y_i), Y) = \frac{1}{2} \|\varphi_i(x_i) - \varphi_j(y_i)\|_2^2, \quad (6)$$

and if $Y = 1$ impostor pair, the contrastive loss is given as:

$$\begin{aligned} \mathcal{L}_{cont}(\varphi_i(x_i), \varphi_j(y_i), c(i, j)) &= \\ \frac{1}{2} \max\left(0, m - \|\varphi_i(x_i) - \varphi_j(y_i)\|_2\right), \end{aligned} \quad (7)$$

The total loss is given as:

$$\begin{aligned} \mathcal{L}_{cont}(\varphi_i(x_i), \varphi_j(y_i)) &= \\ \frac{1}{N^2} \sum_{i=1}^i \sum_{j=1}^j \left\{ \|\varphi_i(x_i) - \varphi_j(y_i)\|_2^2 \right\}. \end{aligned} \quad (8)$$

3.3. Style transfer loss

The style transfer loss comprises of the content and style loss, the content loss is derived from the interaction of an image to the layers of a convolutional neural network trained on object recognition such as VGG-16. When these images interact with the layers, they form representations that are sensitive to content but invariant to precise appearance [10]. The content loss function is a good alternative to solely using L_1 or L_2 losses, as it gives better and sharper high quality reconstruction images [38]. The content loss is computed for both real and synthesized images using a pretrained VGG-16 network. We extract the high-level features

of all the layers of VGG-16 weighted at different scales. The L_1 distance between these features of real and synthesised images are used to guide the generators G_x and G_y . The content loss is given as:

$$\mathcal{L}_{cnt}(\phi_i(x_i), \phi_j(y_i)) = \frac{1}{C_p H_p W_p} \sum_{c=1}^C \sum_{h=1}^H \sum_{w=1}^W \|\phi_i(x_i)_{c,w,h} - \phi_j(y_i)_{c,w,h}\|_1, \quad (9)$$

The style content is obtained from a feature space designed to extract texture information from the layers of a DCNN. The style contents are basically correlations between the different filter responses comprising of the expectation over the entire spatial space of the feature maps. These are obtained by taking the gram matrix $G^\phi(\cdot)$ to be the $C_j \times C_j$ matrix whose elements are given by:

$$G^\phi_i(x)_{c,c'} = \frac{1}{C_p H_p W_p} \sum_{h=1}^H \sum_{w=1}^W (\phi_i(x_i)_{c,w,h})(\phi_i(x_i)_{c',w,h}), \quad (10)$$

where $\phi(\cdot)$ represents an output of a layer in the VGG-16 layers, where C_p , W_p and H_p represent the layer dimensions.

The style reconstruction loss for both images is thus an L_1 loss of each computed gram matrix:

$$G^{\phi}_{i,j}(x, y)_{c,c'} = \|G^{\phi}_i(x)_{c,c'} - G^{\phi}_j(y)_{c,c'}\|_1. \quad (11)$$

3.4. Attribute classification loss

To ensure a robust sketch-to-image translation process, the desired attributes c'_i were concatenated to each image x_i [19]. This combined input is used to train the generator, making it possible to produce images conditioned on any preassigned target domain attributes c' . We achieve this by permuting the assigned target label generation process with respect to the original ground attributes c of the image, this is to ensure that the generated labels are unique from the original. The auxiliary attribute classifier within the discriminator is responsible for injecting the attribute property to the sketch for the image generation process. Figure 4 illustrates the visual representation of the attribute integration process. The combined constraints compute domain classification losses for both real and fake images. We optimize the discriminatory power of our network to optimize D for real images and G for fake images.

The combined losses are expressed as:

$$\mathcal{L}_{cls}^r = \mathbb{E}_{x,c}[-\log D_{cls}(c|x)], \quad (12)$$

$$\mathcal{L}_{cls}^f = \mathbb{E}_{x,c'}[-\log D_{cls}(c'|G(x, c))]. \quad (13)$$

3.5. Reconstruction loss

Adversarial networks are capable of learning mappings between the source and the target domain. Hence, It is possible to reproduce inconsistent images that do not share the same property as the desired output. In this regard, utilizing strictly adversarial losses is not a sufficient approach to arrive at a desired output. Hence, it becomes imperative to ensure that the learned mapping of the network be cycle-consistent. Cycle consistency loss postulates that for an arbitrary input image x from its domain \mathcal{X} an image \hat{x} can be reconstructed; $x \rightarrow G_y(x) \rightarrow G_x(G_y(x)) = \hat{x}$. Likewise, an image y from a different domain \mathcal{Y} can satisfy the same principle backwards as $y \rightarrow G_x(y) \rightarrow G_y(G_x(y)) = \hat{y}$. These collective approaches adapt the transitivity rule which is developed as cyclic consistency. A reconstruction loss which hinges on the cyclic consistency [16] and the perceptual appeal [17], obtained by extracting VGG-16 layers ϕ_i , is applied as an L_1 loss between a real image and its corresponding reconstructed version (fake image). Its general equation is given as:

$$\mathcal{L}_{rec} = \frac{1}{N^2} \sum_{i=1}^i \sum_{j=1}^j \left\{ \|\phi_i(x) - \phi_i(\hat{x})\|_1 + \|\phi_j(y) - \phi_j(\hat{y})\|_1 \right\}. \quad (14)$$

3.6. Our complete objective function

The final objective of our model is the combination of all the aforementioned loss functions using dedicated Lagrangian coefficients as:

$$\begin{aligned} \mathcal{L}_{GAN}(G_{X,Y}, D_{X,Y}) &= \mathcal{L}_{adv}(G_x, D_x, X, Y) \\ &+ \mathcal{L}_{adv}(G_y, D_y, X, Y) \\ &+ \lambda_1 \mathcal{L}_{rec}(G_x, G_y, \phi, X, Y) \\ &+ \lambda_2 \mathcal{L}_{cont}(G_x, G_y, \varphi, X, Y) \\ &+ \lambda_3 \mathcal{L}_{cls}^r(G_x, G_y, D_x, X, Y) \\ &+ \lambda_4 \mathcal{L}_{feat}^f(G_x, G_y, D_x, X, Y) \\ &+ \lambda_5 \mathcal{L}_{cnt}(G_x, G_y, \phi, X, Y) \\ &+ \lambda_6 \mathcal{L}_{id}^f(G_x, G_y, D_x, X, Y), \end{aligned} \quad (15)$$

where each λ_i scales the corresponding objective to achieve better results. G_x and G_y are the generators, responsible for synthesising images for their respective domains; $\{x_i\}_{i=1}^n \in \mathcal{X}$ for images and $\{y_i\}_{i=1}^n \in \mathcal{Y}$ for sketches. Discriminators D_x and D_y critic the images in domain \mathcal{X} and \mathcal{Y} , respectively. ϕ represents the overall feature maps we concatenate to the images before computing the reconstruction loss. Our objective function basically aims to solve the min-max game:

$$G_X^*, G_Y^* = \arg \min_{(G_x, G_y)} \max_{(D_x, D_y)} \mathcal{L}_{GAN}(G_x, G_y, D_x, D_y). \quad (16)$$

4. Training

The models were trained using an Adam optimizer, with $\beta_1 = 0.5$ and $\beta_2 = 0.999$. We used a batch sizes ranging between 8 and 16 for all experiments on CelebA [27], WVU Multi-modal [1] and CelebA-HQ [24] for RGB images and from an auxiliary generator trained on sketches from CUHK [25], IIT-D [2] and FERET [30] datasets and a learning rate of 10^{-5} for the first 10 epochs which linearly decayed to 0 over the next 10 epochs. We trained the entire model on three NVIDIA Titan X Pascal GPUs.

To train our proposed sketch-to-photo GAN synthesizer, we prioritize our objective to synthesize images from sketches by conditioning each sketch image with a uniquely generated attribute label to form a new channel depth (i.e., 8-channels) as the input channels to the sketch-to-image generator and discriminator (see Figure 3). The input image which now comprises of 8 channels at the input is fed into the discriminator, our hybrid discriminator improves the attribute learning scheme by steering the model towards producing photo-realistic images from the sketches in the dataset. Our novel quality guided encoder E_x learns the quality features of all the real images at different user specified stages along its encoding network. Its corresponding encoding stage at the generator G_x (with shared weights) is linked via an L_2 loss to guide image syntheses towards more quality refined images.

4.1. Dataset description

We synthesised sketches using XDOG filter for the CelebA, WVU Multi-modal datasets and from an auxiliary generator trained for sketches from CUHK, IIT-D and FERET datasets. The CelebFaces Attributes (CelebA) is a large scale dataset of 202,599 celebrity face images, each annotated with 40 attributes and 10,177 identities. We randomly select 2,000 images as the test set and use all the remaining images as the training data. We generate five domains using the following attributes: hair color (black, blond, brown), age (young/old). The WVU Multi modal dataset contains 3453 high resolution color frontal images of 1200 subjects. The FERET dataset consists of over 14,126 images for 1199 different persons, with a variety in face poses, facial expressions, and lighting conditions. The total number of frontal and near frontal face images, whose pose angle lies between -45 and $+45$, is 5,786 images (3,816 male images and 1,970 female images). IIT-D sketch dataset contains 238 viewed pairs, 140 semi-forensic pairs, and 190 forensic pairs, while CUHK Face Sketch dataset (contains 311 pairs).

Table 1: A quantitative comparison of the GAN-metric performance for Pix2Pix, cCycle-GAN, C-GAN, HFs2P and ours. Our proposed approach shows an improvement overall.

Metric	Models		
	FID ↓	IS ↑	SSIM ↑
Pix2Pix[16]	72.18	$1.35 \pm .03$	$0.67 \pm .01$
HFs2p[4]	60.21	$1.48 \pm .03$	$0.79 \pm .01$
C-GAN[47]	67.13	$2.79 \pm .01$	$0.74 \pm .04$
cCycle-GAN[19]	45.39	$3.40 \pm .07$	$0.83 \pm .07$
Ours	37.46	$3.63 \pm .01$	$0.89 \pm .06$

4.2. Evaluation

To evaluate the performance of our approach, we compared a set of images against a gallery of mugshots utilizing a synthesised image probe. The gallery comprises of WVU Multi-Modal, CUHK, FERET, IIT-D and CelebA-HQ datasets. The purpose of this experiment is to assess the verification performance of the proposed method with a relatively large number of subject candidates, Figures (6, 7, 8 and 9) show CMC curves for CelebA, CUHK and IIT-D datasets, respectively.

We compare our method with several state of the art sketch to image synthesis methods as shown in Figures (7, 8 and 9). To evaluate the performance of the synthesized images, we implemented a face verifier called DeepFace [34], pre-trained on a VGG based network [33]. A similar protocol implemented in [19] was used.

4.3. Qualitative assessment

Ablation analysis on our loss functions were implemented to test the independent efficacy on the model in general. By multiplying the adversarial loss by a degrading values of λ_i , we observed a considerable effect on the entire performance of the model, as λ_1 arrived at zero, the generative potential of the network dwindled accordingly. We also evaluated the cycle loss in only one direction; GAN and forward cycle loss or GAN and backward cycle loss and found out that it often incurs training instability and causes mode collapse. Due to the fact that the attributes are concatenated at the generator’s end, it was inferred that increasing our weights affects the discriminative power of the network especially for the attribute generation for target images. Table 1 and 2 show the computed Frchet Inception Distance (FID), Feature Similarity index FSIM, null-space linear discriminant analysis (NLDA), Inception Score (IS) and the Structural Similarity (SSIM) index. Table 3 gives a score assessment of the ablation study for the GAN performance metric used.

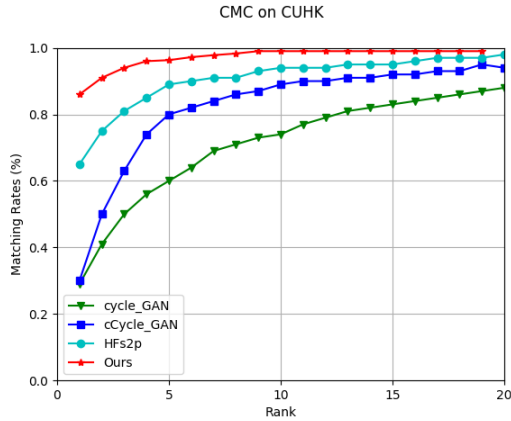

Figure 6: CMC curves of our framework against cycleGAN, cCycleGAN, HF2P algorithm for the CUHK dataset.

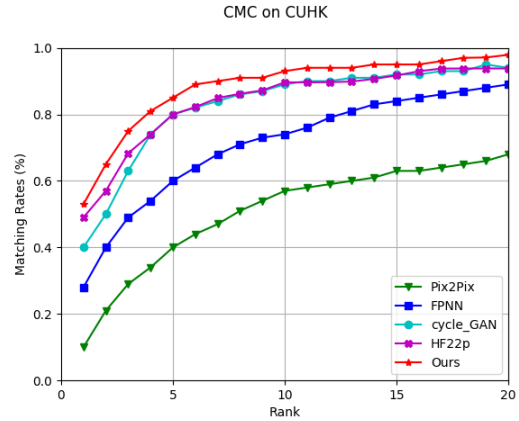

Figure 8: CMC curves of our framework against Pix2Pix, cycleGAN, HF2P and FPNN algorithm for the CUHK dataset.

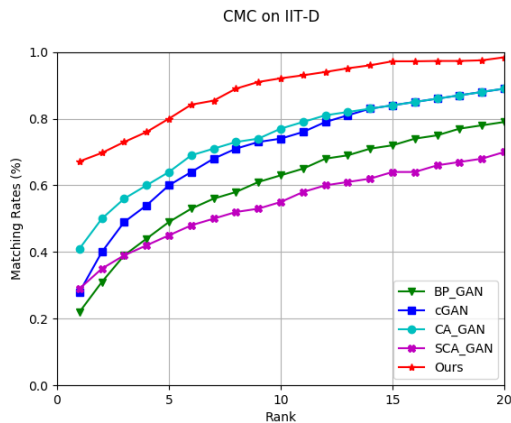

Figure 7: CMC curves of our framework against bpGAN, caGAN, scAGAN and cGAN algorithm for the CelebA dataset.

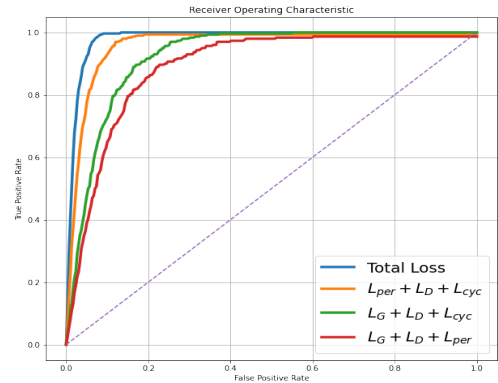

Figure 9: We show the ROC curves showing the importance of different loss functions for ablation study.

Table 2: A quantitative comparison of the GAN-metric performance for BP-GAN, CA-GAN, SCA-GAN, C-GAN and ours. Our proposed approach shows an improvement overall.

Metric	Models		
	FID ↓	FSIM ↑	NLDA ↑
BP-GAN[40]	86.1	69.13	93.1
C-GAN[47]	43.2	71.1	95.5
CA-GAN[44]	36.1	71.3	95.8
SCA-GAN[44]	34.2	71.6	95.7
Ours	34.1	72.8	97.0

5. Conclusion

In this paper, we proposed a novel sketch-to-image translation model using a hybrid discriminator and a multi-stage generator. Our model shows that the perceptual appeal of sketches can be achieved with the network reconfiguration

Table 3: A description of the ablation study conducted on the sketch-photo-synthesizer network. The various key components that make up the framework were altered to identify their respective impact on the GAN metric performance (i.e, FID, SSIM and IS).

Loss	Model Resolution			Metric		
	256 x 256	128 x 128	64 x 64	FID ↓	IS ↑	SSIM ↑
\mathcal{L}_G	✓	✗	✓	37.46	5.48	0.738
\mathcal{L}_D	✗	✓	✓	31.86	2.06	0.791
\mathcal{L}_{cyc}	✓	✗	✓	33.73	5.91	0.808
\mathcal{L}_{per}	✓	✗	✓	35.34	6.32	0.896

of the generator and discriminator processes. The breaking down of the functionality of the network into smaller subsets helped to improve the training process and hence led to better results under short periods. Our verification results indeed confirm that sketch-to-image translation problems would find lots of applications in industry.

References

- [1] Multimodal Dataset biometric dataset collection, biom-data. <https://biic.wvu.edu/data-sets/multimodal-dataset>. Accessed: 2020-03-02.
- [2] Himanshu S. Bhatt, Samarth Bharadwaj, Richa Singh, and Mayank Vatsa. On matching sketches with digital face images. *2010 Fourth IEEE International Conference on Biometrics: Theory, Applications and Systems (BTAS)*, pages 1–7, 2010.
- [3] Yang Cao, Changhu Wang, Liqing Zhang, and Lei Zhang. Edgel index for large-scale sketch-based image search. pages 761–768, 07 2011.
- [4] Wentao Chao, Liang Chang, Xuguang Wang, Jian Cheng, Xiaoming Deng, and Fuqing Duan. High-fidelity face sketch-to-photo synthesis using generative adversarial network. *2019 IEEE International Conference on Image Processing (ICIP)*, pages 4699–4703, 2019.
- [5] Wengling Chen. Sketchygan: Towards diverse and realistic sketch to image synthesis. pages 9416–9425, 06 2018.
- [6] A. Dabouei, H. Kazemi, S. M. Iranmanesh, J. Dawson, and N. M. Nasrabadi. Fingerprint distortion rectification using deep convolutional neural networks. In *2018 International Conference on Biometrics (ICB)*, pages 1–8, Feb 2018.
- [7] Chao Dong, Chen Change Loy, Kaiming He, and Xiaoou Tang. Lecture notes in computer science. 09 2014.
- [8] Mathias Eitz, James Hays, and Marc Alexa. How do humans sketch objects? *ACM Trans. Graph.*, 31(4):44:1–44:10, July 2012.
- [9] Yuke Fang, Weihong Deng, Junping Du, and Jiani Hu. Identity-aware cyclegan for face photo-sketch synthesis and recognition. *Pattern Recognition*, 102:107249, 2020.
- [10] Leon Gatys, Alexander Ecker, and Matthias Bethge. Image style transfer using convolutional neural networks. pages 2414–2423, 06 2016.
- [11] Ian Goodfellow, Jean Pouget-Abadie, Mehdi Mirza, Bing Xu, David Warde-Farley, Sherjil Ozair, Aaron Courville, and Yoshua Bengio. Generative adversarial nets. In Z. Ghahramani, M. Welling, C. Cortes, N. D. Lawrence, and K. Q. Weinberger, editors, *Advances in Neural Information Processing Systems 27*, pages 2672–2680. Curran Associates, Inc., 2014.
- [12] Raia Hadsell, Sumit Chopra, and Yann LeCun. Dimensionality reduction by learning an invariant mapping. *2006 IEEE Computer Society Conference on Computer Vision and Pattern Recognition (CVPR’06)*, 2:1735–1742, 2006.
- [13] Martin Heusel, Hubert Ramsauer, Thomas Unterthiner, Bernhard Nessler, and Sepp Hochreiter. Gans trained by a two time-scale update rule converge to a local nash equilibrium. In *Proceedings of the 31st International Conference on Neural Information Processing Systems, NIPS’17*, pages 6629–6640, USA, 2017. Curran Associates Inc.
- [14] Mingming Hu and Jingtao Guo. Facial attribute-controlled sketch-to-image translation with generative adversarial networks. *EURASIP Journal on Image and Video Processing*, 2020:1–13, 2020.
- [15] Xun Huang, Ming-Yu Liu, Serge Belongie, and Jan Kautz. Multimodal unsupervised image-to-image translation. *arXiv preprint arXiv:1804.04732*, 2018.
- [16] P. Isola, J. Zhu, T. Zhou, and A. A. Efros. Image-to-image translation with conditional adversarial networks. In *2017 IEEE Conference on Computer Vision and Pattern Recognition (CVPR)*, pages 5967–5976, July 2017.
- [17] Justin Johnson, Alexandre Alahi, and Fei-Fei Li. Perceptual losses for real-time style transfer and super-resolution. *CoRR*, abs/1603.08155, 2016.
- [18] Tero Karras, Timo Aila, Samuli Laine, and Jaakko Lehtinen. Progressive growing of gans for improved quality, stability, and variation. *ArXiv*, abs/1710.10196, 2017.
- [19] H. Kazemi, M. Iranmanesh, A. Dabouei, S. Soleymani, and N. M. Nasrabadi. Facial attributes guided deep sketch-to-photo synthesis. In *2018 IEEE Winter Applications of Computer Vision Workshops (WACVW)*, pages 1–8, March 2018.
- [20] Diederik P. Kingma, Tim Salimans, and Max Welling. Improved variational inference with inverse autoregressive flow. *ArXiv*, abs/1606.04934, 2017.
- [21] Diederik P Kingma and Max Welling. Auto-encoding variational bayes. *arXiv preprint arXiv:1312.6114*, 2013.
- [22] B. Klare, Z. Li, and A. K. Jain. Matching forensic sketches to mug shot photos. *IEEE Transactions on Pattern Analysis and Machine Intelligence*, 33(3):639–646, 2011.
- [23] Pierre-Yves Laffont, Zhile Ren, Xiaofeng Tao, Chao Qian, and James Hays. Transient attributes for high-level understanding and editing of outdoor scenes. *ACM Trans. Graph.*, 33:149:1–149:11, 07 2014.
- [24] Cheng-Han Lee, Ziwei Liu, Lingyun Wu, and Ping Luo. Maskgan: Towards diverse and interactive facial image manipulation. *arXiv preprint arXiv:1907.11922*, 2019.
- [25] Wei Li, Rui Zhao, and Xiaogang Wang. Human reidentification with transferred metric learning. In *ACCV*, 2012.
- [26] Jianxin Lin, Yingce Xia, Tao Qin, Zhibo Chen, and Tie-Yan Liu. Conditional image-to-image translation. pages 5524–5532, 06 2018.
- [27] Ziwei Liu, Ping Luo, Xiaogang Wang, and Xiaoou Tang. Deep learning face attributes in the wild. In *Proceedings of International Conference on Computer Vision (ICCV)*, December 2015.
- [28] Aaron van den Oord, Nal Kalchbrenner, and Koray Kavukcuoglu. Pixel recurrent neural networks. *arXiv preprint arXiv:1601.06759*, 2016.
- [29] Taesung Park, Ming-Yu Liu, Ting-Chun Wang, and Jun-Yan Zhu. Gagan: semantic image synthesis with spatially adaptive normalization. pages 1–1, 07 2019.
- [30] P. Jonathon Phillips, Harry Wechsler, Jeffrey Huang, and Patrick J. Rauss. The feret database and evaluation procedure for face-recognition algorithms. *Image Vis. Comput.*, 16:295–306, 1998.
- [31] Patsorn Sangkloy, Jingwan Lu, Chen Fang, Fisher Yu, and James Hays. Scribbler: Controlling deep image synthesis with sketch and color. In *The IEEE Conference on Computer Vision and Pattern Recognition (CVPR)*, July 2017.
- [32] Yujun Shen, Bolei Zhou, Ping Luo, and Xiaoou Tang. Facefeat-gan: a two-stage approach for identity-preserving face synthesis. *CoRR*, abs/1812.01288, 2018.

- [33] K. Simonyan and A. Zisserman. Very deep convolutional networks for large-scale image recognition. *CoRR*, abs/1409.1556, 2014.
- [34] Yaniv Taigman, Ming Yang, Marc’ Aurelio Ranzato, and Lior Wolf. Deepface: Closing the gap to human-level performance in face verification. *2014 IEEE Conference on Computer Vision and Pattern Recognition*, pages 1701–1708, 2014.
- [35] V. Talreja, S. Soleymani, M. C. Valenti, and N. M. Nasrabadi. Learning to authenticate with deep multibiometric hashing and neural network decoding. In *ICC 2019 - 2019 IEEE International Conference on Communications (ICC)*, pages 1–7, May 2019.
- [36] Veeru Talreja, Fariborz Taherkhani, Matthew C. Valenti, and Nasser M. Nasrabadi. Using deep cross modal hashing and error correcting codes for improving the efficiency of attribute guided facial image retrieval. *2018 IEEE Global Conference on Signal and Information Processing (GlobalSIP)*, pages 564–568, 2018.
- [37] Veeru Talreja, Matthew C. Valenti, and Nasser M. Nasrabadi. Multibiometric secure system based on deep learning. *2017 IEEE Global Conference on Signal and Information Processing (GlobalSIP)*, pages 298–302, 2017.
- [38] Joshua B. Tenenbaum and William T. Freeman. Separating style and content with bilinear models. *Neural Computation*, 12:1247–1283, 2000.
- [39] Oriol Vinyals, Charles Blundell, Timothy Lillicrap, Daan Wierstra, et al. Matching networks for one shot learning. In *Advances in neural information processing systems*, pages 3630–3638, 2016.
- [40] Nannan Wang, Wenjin Zha, Jie Li, and Xinbo Gao. Back projection: An effective postprocessing method for gan-based face sketch synthesis. *Pattern Recognit. Lett.*, 107:59–65, 2017.
- [41] Xiaolong Wang and Abhinav Gupta. Generative image modeling using style and structure adversarial networks. volume 9908, pages 318–335, 10 2016.
- [42] Xinchen Yan, Jimei Yang, Kihyuk Sohn, and Honglak Lee. Attribute2image: Conditional image generation from visual attributes. In *European Conference on Computer Vision*, pages 776–791. Springer, 2016.
- [43] Sheng You, Ning You, and Minxue Pan. Pi-rec: Progressive image reconstruction network with edge and color domain. *arXiv preprint arXiv:1903.10146*, 2019.
- [44] Jun Yu, Xingxin Xu, Fei Gao, Shengjie Shi, Meng Wang, Dacheng Tao, and Qingming Huang. Towards realistic face photo-sketch synthesis via composition-aided gans. 2017.
- [45] Han Zhang, Tao Xu, and Hongsheng Li. Stackgan: Text to photo-realistic image synthesis with stacked generative adversarial networks. pages 5908–5916, 10 2017.
- [46] Richard Zhang, Phillip Isola, and Alexei Efros. Colorful image colorization. volume 9907, pages 649–666, 10 2016.
- [47] Jun-Yan Zhu, Taesung Park, Phillip Isola, and Alexei A Efros. Unpaired image-to-image translation using cycle-consistent adversarial networks. In *Computer Vision (ICCV), 2017 IEEE International Conference on*, 2017.