

State Observation of Power Systems Equipped with Phasor Measurement Units: The Case of Fourth Order Flux-Decay Model

Alexey Bobtsov, *Senior Member, IEEE*, Romeo Ortega, *Life Fellow, IEEE*, Nikolay Nikolaev, *Member, IEEE*, Johannes Schiffer, *Member, IEEE*, and M. Nicolai L. Lorenz-Meyer

Abstract—The problem of effective use of Phasor Measurement Units (PMUs) to enhance power systems awareness and security is a topic of key interest. The central question to solve is how to use this new measurements to reconstruct the *state* of the system. In this paper we provide the first solution to the problem of (globally convergent) state estimation of multimachine power systems equipped with PMUs and described by the *fourth order flux-decay model*. This work is a significant extension of our previous result, where this problem was solved for the simpler third order model, for which it is possible to recover *algebraically* part of the unknown state. Unfortunately, this property is lost in the more accurate fourth order model, significantly complicating the state observation task. The design of the observer relies on two recent developments proposed by the authors, a parameter estimation based approach to the problem of state estimation and the use of the Dynamic Regressor Extension and Mixing (DREM) technique to estimate these parameters. The use of DREM allows us to overcome the problem of lack of persistent excitation that stymies the application of standard parameter estimation designs. Simulation results illustrate the latter fact and show the improved performance of the proposed observer with respect to a locally stable gradient-descent based observer.

Index Terms—Dynamic state estimation, power system operation, phasor measurements, synchronous generator.

I. INTRODUCTION

POWER systems are experiencing major changes and challenges, such as an increasing amount of power-electronics-interfaced equipment, growing transit power flows and fluctuating (renewable) generation, see [21]. Therefore power systems are operated under more and more stressed conditions and, thus, closer to their stability limits as ever before. In addition, as detailed in [10], their dynamics become faster, more uncertain and also more volatile. Hence, fast and accurate monitoring of the system states is crucial in order to ensure a stable and reliable system operation, see [23]. This, however, implies that the conventional monitoring approaches based on steady-state assumptions are no longer appropriate

and instead novel *state observers*¹ tools have to be developed, see [23], [19].

By recognizing this need, the design of state observers has become a very active research area in the past years. The interest has been further accelerated by the growing deployment of PMUs, see [20]. The vast majority of the reported results on this matter rely on the use of *linear* systems-based theories, *e.g.*, the use of Kalman filters, whose performance is assessed only via simulations, see [6], [14], [22], [23]. As thoroughly discussed in [8], this approach suffers from several major drawbacks.

Recently [8], the authors provided a globally convergent solution to the state observation problem for the case when the generators are modelled by the classical *third order flux-decay model*. Instrumental for the solution of the problem was the observation that, for this model, it is possible to recover *algebraically* part of the unknown state. It is widely recognized [9], [19], [22] that to improve the precision of the model, it is necessary to include additional dynamic effects, leading to a fourth order model. Unfortunately, for this case, the algebraic reconstruction of part of the state is *impossible*, significantly complicating the state observation task.

In this paper we provide the first solution to the state observation problem for multimachine power systems described by the fourth order model. The design of the observer relies on two recent developments proposed by the authors, a generalization of the Parameter Estimation-based Observer (GPEBO) [12], and the use of the DREM technique [1] to estimate these parameters. GPEBO was used in [13] for the design of observers for bio-chemical reactors and the simplest problem of state estimation of third-order power systems with *measurement* of the rotor angle. The latter, practically restrictive assumption, is removed here significantly widening the applicability of the result. Thanks to the use of DREM it is possible to overcome the problem of lack of persistent excitation that stymies the application of standard observer designs. Simulation results, presented in Section VI, illustrate the latter fact and shows the improved performance of the proposed observer with respect to a locally stable gradient-descent based observer.

Throughout the paper we restrict ourselves to the study of a single generator. As shown in [8], thanks to the incorporation

A. A. Bobtsov and N. Nikolaev are with ITMO University, 197101, Saint Petersburg, Russian Federation (e-mail: bobtsov@mail.ru, nanikolaev@itmo.ru)

R. Ortega is with CNRS L2S, 91192 Gif-sur-Yvette, France (e-mail: ortega@lss.supelec.fr) and with ITMO University

M. N. L. Lorenz-Meyer and J. Schiffer are with Brandenburg University of Technology Cottbus-Senftenberg, 03046 Cottbus, Germany (e-mail: lorenz-meyer, schiffer@b-tu.de)

Manuscript received March 19, 2020.

¹In the power systems community, to distinguish it from the steady-state case, the qualifier “dynamic” is added to the state observation problem, and it is sometimes called “dynamic state estimation”.

of the PMUs, for the purposes of observer design it is possible to treat multimachine systems as a set of decentralized single machines, hence our result can be extended in a straightforward way to the multimachine case. In the interest of brevity we omit the details of this generalization, and refer the interested reader to [8, Section II] for the details.

II. MATHEMATICAL MODEL AND PROBLEM FORMULATION

We consider the well-known fourth-order model of the single machine system given by [6, eq. (1)], see also [16, Chapter 5.4] and [9, Chapter 11.1.7.1],

$$\dot{x}_1 = x_2 \quad (1a)$$

$$\dot{x}_2 = -a_0 x_2 + b_0(u_1 - y_5) \quad (1b)$$

$$\dot{x}_3 = -a_2 x_3 + b_2 y_2 \sin(x_1 - y_1) \quad (1c)$$

$$\dot{x}_4 = -a_1 x_4 + b_1 y_2 \cos(x_1 - y_1) + c_1 u_2, \quad (1d)$$

where the *unknown* state and input variables are defined as

$$x := [x_1 \ x_2 \ x_3 \ x_4]^\top = [\delta \ \omega \ E'_d \ E'_q]^\top$$

$$u := [u_1 \ u_2]^\top = [P_m \ E_f]^\top,$$

with δ the rotor angle, ω the shaft speed, E'_d and E'_q the direct and quadrature axis internal voltages, respectively, P_m the mechanical power and E_f the field voltage, and we defined the positive constants

$$a_0 := \frac{\omega_0 D}{2H}, \quad b_0 := \frac{\omega_0}{2H}$$

$$a_1 := \frac{1}{T_{d0'}} \frac{x_d}{x'_d}, \quad b_1 := \frac{1}{T_{d0'}} \frac{(x_d - x'_d)}{x'_d}, \quad c_1 := \frac{1}{T_{d0'}}$$

$$a_2 := \frac{1}{T_{q0'}} \frac{x_q}{x'_q}, \quad b_2 := \frac{1}{T_{q0'}} \frac{(x_q - x'_q)}{x'_q}.$$

All variables and constants are defined in Table 1 in the Appendix. The PMU *measurements* are

$$y := [y_1 \ y_2 \ y_3 \ y_4 \ y_5 \ y_6]^\top =$$

$$[\theta_t \ V_t \ \phi_t \ I_t \ P_t \ Q_t]^\top, \quad (2)$$

where

$$y_4^2 = \frac{1}{x_q'^2} (x_3^2 + x_4^2 + y_2^2) \quad (3a)$$

$$- 2y_2 [x_4 \cos(x_1 - y_1) + x_3 \sin(x_1 - y_1)]$$

$$y_5 = \frac{y_2}{x_q'} [x_4 \sin(x_1 - y_1) - x_3 \cos(x_1 - y_1)] \quad (3b)$$

$$y_6 = \frac{y_2}{x_q'} [x_4 \cos(x_1 - y_1) + x_3 \sin(x_1 - y_1) - y_2] \quad (3c)$$

We underscore the presence of the terminal bus voltage $y_2 = V_t$ that, in a multimachine scenario, captures the effect of the interconnection among the machines, see [8, Section II] for details.

To formulate the observer problem we make the following assumptions on systems prior knowledge and the available measurements.

Assumption 1. The signals u are *measurable* and the electrical subsystem parameters $(a_1, a_2, b_1, b_2, c_1)$ are *known*.²

Problem Formulation: Consider the SMIB power system (1) with measurable outputs (2), (3), verifying Assumption 1. Design an observer

$$\dot{\chi} = F(\chi, u, y)$$

$$\hat{x} := H(\chi, u, y)$$

such that $\lim_{t \rightarrow \infty} \tilde{x}(t) = 0$, where we, generically, define the estimation *errors* $(\tilde{\cdot}) := (\hat{\cdot}) - (\cdot)$.

Remark 1. The model (1a)-(1d) is obtained making the standard assumption that the *stator resistance is zero*. Moreover, the expressions in (3b) and (3c) are obtained by neglecting transient saliency, thus assuming that the direct- and quadrature-axis transient reactances, x'_d and x'_q , respectively, are *equal*.

Remark 2. The expression for y_4 given in (3a) can be derived using the direct- and quadrature-axis currents I_d and I_q , respectively, defined as

$$I_d := \frac{1}{x'_d} [x_4 - y_2 \cos(x_1 - y_1)]$$

$$I_q := \frac{1}{x'_q} [-x_3 + y_2 \sin(x_1 - y_1)],$$

with $x'_d = x'_q$.

III. 3RD AND 4TH ORDER MODELS: A FUNDAMENTAL DIFFERENCE

As indicated in Section I, in [8] we present a globally convergent solution to the state observation problem for the case when the generators are modeled by the classical *third order* flux-decay model given by³

$$\dot{x}_1 = x_2$$

$$\dot{x}_2 = -a_1 x_2 + a_2 [P_m - YV x_3 \sin(x_1)]$$

$$\dot{x}_3 = -a_3 x_3 + a_4 V \cos(x_1) + E_f,$$

where the *unknown* state is defined as

$$x := [x_1 \ x_2 \ x_3]^\top = [\delta - \theta_t \ \omega \ E'_q]^\top,$$

with $Y > 0$ is the susceptance of the network admittance, and V is the terminal voltage. All other parameters of the model a_i , $i = 1, 4$, are constant. The *measurements*, which are provided via PMUs, are defined as

$$y_1 = V$$

$$y_2 = YV x_3 \sin(x_1)$$

$$y_3 = YV x_3 \cos(x_1) - YV^2$$

$$y_4^2 = Y^2 [x_3^2 + V^2 - 2V x_3 \cos(x_1)], \quad (4)$$

$$y_5 = f_t, \quad (5)$$

²As usual in observer problems [3] we assume that u is bounded and such that all state trajectories are *bounded*.

³To avoid cluttering, and with some abuse of notation, we keep the same symbols for the 3rd and the 4th order models.

where $y_1 > 0$ is the terminal voltage, y_2 is the active power, y_3 is the reactive power, y_4 is the terminal current and y_5 the terminal voltage frequency.

In [8] it was shown that it is possible to algebraically reconstruct the states x_1 and x_3 from the measurements y as follows.

Proposition 1. [8] The states x_1 and x_3 can be determined uniquely from the PMU measurements (4) via

$$x_3 = \sqrt{\frac{y_4^2 + 2Y y_3}{Y^2} + y_1^2}$$

$$x_1 = \arcsin\left(\frac{y_2}{Y_i y_1 x_3}\right).$$

This result is essential for the solution of the state observation problem, which now reduces to the observation of x_2 . We will show now that, unfortunately, this fundamental property of the state-to-output map⁴ is lost for the 4th order model (2). To prove this fact we first observe that y_1 and y_2 are *unrelated* with x . Therefore, we propose the following definitions

$$z := \begin{bmatrix} x_q'^2 y_4^2 - y_2^2 \\ \frac{x_q' y_5}{y_2} \\ \frac{x_q' y_6}{y_2} + y_2 \end{bmatrix} \in \mathcal{B} \subset \mathbb{R}^3, \quad v := \begin{bmatrix} x_1 - y_1 \\ x_3 \\ x_4 \end{bmatrix} \in \mathcal{A} \subset \mathbb{R}^3,$$

and look at the parameterized (in y_2) mapping $M_{y_2} : \mathcal{A} \mapsto \mathcal{B}$

$$z = M_{y_2}(v) = \begin{bmatrix} v_2^2 + v_3^2 - 2y_2[v_2 \cos(v_1) + v_3 \sin(v_1)] \\ v_2 \sin(v_1) - v_3 \cos(v_1) \\ v_2 \cos(v_1) + v_3 \sin(v_1) \end{bmatrix}$$

The task is to check whether M_{y_2} is *injective*. This is equivalent to the existence of a mapping $M_{y_2}^I : \mathcal{B} \mapsto \mathcal{A}$ such that

$$M_{y_2}^I(M_{y_2}(v)) = v.$$

We make now the second observation, namely, that $v_2^2 + v_3^2$ is measurable. Hence, we can define an alternative mapping $N_{y_2} : v \rightarrow z_N$

$$z_N := z - \begin{bmatrix} v_2^2 + v_3^2 \\ 0 \\ 0 \end{bmatrix} = N_{y_2}(v)$$

$$= \begin{bmatrix} -2y_2[v_2 \cos(v_1) + v_3 \sin(v_1)] \\ v_2 \sin(v_1) - v_3 \cos(v_1) \\ v_2 \cos(v_1) + v_3 \sin(v_1) \end{bmatrix}$$

We are in position to prove our claim of non-injectivity of the state-to-output map (2).

Lemma 1. The mapping $(x_1, x_3, x_4) \mapsto (y_4, y_5, y_6)$ is non-injective.

Proof. In view of the discussion above, to prove the claim it suffices to show that

$$\det\{\nabla N_{y_2}(v)\} = 0.$$

Some simple calculations yield

⁴We mean here the mapping $(x_1, x_3, x_4) \mapsto y$.

$$\nabla N_{y_2}(v) = \begin{bmatrix} n_{11}(v) & -2y_2 \cos(v_1) & -2y_2 \sin(v_1) \\ n_{21}(v) & \sin(v_1) & -\cos(v_1) \\ n_{31}(v) & \cos(v_1) & \sin(v_1) \end{bmatrix},$$

where

$$n_{11}(v) = 2y_2[v_2 \sin(v_1) - v_3 \cos(v_1)],$$

$$n_{21}(v) = v_2 \cos(v_1) + v_3 \sin(v_1),$$

$$n_{31}(v) = -v_2 \sin(v_1) + v_3 \cos(v_1).$$

It is easy to see that

$$\nabla N_{y_2}(v) \begin{bmatrix} 1 \\ -v_3 \\ v_2 \end{bmatrix} = 0,$$

completing the proof. $\square\square\square$

IV. REPARAMETERIZATION OF THE ELECTRICAL DYNAMICS

In this section we propose a reparameterization of the electrical dynamics which is *linear* in x_3 and x_4 . Moreover, we define three state-to-output mappings that will be used for the observer design.

Lemma 2. Consider the SMIB model (1) with PMU measurements (2) and (3).

C1 There exists a matrix of measurable signals $\mathcal{M} \in \mathbb{R}^{2 \times 2}$ such that

$$\begin{bmatrix} \dot{x}_3 \\ \dot{x}_4 \end{bmatrix} = \mathcal{M} \begin{bmatrix} x_3 \\ x_4 \end{bmatrix} + \begin{bmatrix} 0 \\ c_1 u_2 \end{bmatrix}. \quad (6)$$

C2 There exists a measurable signal $Y = \begin{bmatrix} Y_1 \\ Y_2 \\ Y_3 \end{bmatrix} \in \mathbb{R}^3$ such that

$$Y = \begin{bmatrix} x_3^2 + x_4^2 \\ e^{Jx_1} \begin{bmatrix} x_3 \\ x_4 \end{bmatrix} \end{bmatrix}, \quad (7)$$

$$\text{with } J := \begin{bmatrix} 0 & -1 \\ 1 & 0 \end{bmatrix}.$$

Proof. To avoid cluttering, let us define the measurable signal

$$z_0 := y_6 + \frac{y_2^2}{x_q'}. \quad (8)$$

From (3b) and (3c) we get after some simple calculations

$$y_5 x_4 + z_0 x_3 = \frac{y_2}{x_q'} (x_3^2 + x_4^2) \sin(x_1 - y_1)$$

$$z_0 x_4 - y_5 x_3 = \frac{y_2}{x_q'} (x_3^2 + x_4^2) \cos(x_1 - y_1). \quad (9)$$

Note also that from (3) we have

$$x_3^2 + x_4^2 = (x_q')^2 y_4^2 + 2x_q' y_6 + y_2^2 = Y_1, \quad (10)$$

where we notice that Y_1 is bounded away from zero. Replacing (10) in (9) and rearranging terms we get

$$\begin{aligned} y_2 \sin(x_1 - y_1) &= \frac{x'_q}{Y_1} (y_5 x_4 + z_0 x_3) \\ y_2 \cos(x_1 - y_1) &= \frac{x'_q}{Y_1} (z_0 x_3 - y_5 x_3). \end{aligned}$$

Replacing the latter equations in (1c) and (1d) and defining the matrix

$$\mathcal{M} := \begin{bmatrix} -a_2 + \frac{b_2 x'_q}{Y_1} z_0 & \frac{b_2 x'_q}{Y_1} y_5 \\ -\frac{b_1 x'_q}{Y_1} y_5 & -a_1 + \frac{b_1 x'_q}{Y_1} z_0 \end{bmatrix}. \quad (11)$$

completes the proof of claim **C1**.

We proceed now to complete the proof of the claim **C2**—notice that (10) is the first identity in (7). From (3b) and (3c) we get

$$\begin{aligned} \begin{bmatrix} -\frac{x'_q}{y_2} y_5 \\ \frac{x'_q}{y_2} y_6 + y_2 \end{bmatrix} &= \begin{bmatrix} \cos(x_1 - y_1) & -\sin(x_1 - y_1) \\ \sin(x_1 - y_1) & \cos(x_1 - y_1) \end{bmatrix} \begin{bmatrix} x_3 \\ x_4 \end{bmatrix} \\ &= e^{J(x_1 - y_1)} \begin{bmatrix} x_3 \\ x_4 \end{bmatrix}. \end{aligned}$$

The proof is completed defining

$$\begin{bmatrix} Y_2 \\ Y_3 \end{bmatrix} := e^{J y_1} \begin{bmatrix} -\frac{x'_q}{y_2} y_5 \\ \frac{x'_q}{y_2} y_6 + y_2 \end{bmatrix}. \quad (12)$$

□□□

Remark 3. From (6) and the first component in (7), that is $Y_1 = x_3^2 + x_4^2$, we see that we are dealing with a subsystem with linear dynamics but *nonlinear* state-output map. To the best of our knowledge [2, Chapter 5], [3, Chapter 3] there is no systematic way to design state observers for this class of systems. In Subsection V-B we present a gradient-descent based scheme [18] for which some local stability properties can be established.

V. PROPOSED STATE OBSERVER

A corollary of the claim **C2** is that there are two possibilities to reconstruct the states (x_1, x_3, x_4) . The first option is to find an observer for x_1 and get (x_3, x_4) from the components Y_2 and Y_3 of (7). Alternatively, we can estimate (x_3, x_4) and—as shown in the proposition below—obtain x_1 from simple trigonometric relations. The state x_2 can be reconstructed with the I&I observer of [8, Lemma 1].

Although the first approach looks simpler, the design of an observer for x_1 is still an open problem. Therefore, in this section we take the second route and design a GPEBO observer [13] for the states (x_3, x_4) . To enhance readability we divide the presentation of the observer in two parts, first—in the spirit of PEBO [12] that translates the problem of state observation into one of parameter estimation—the derivation of a *nonlinear regression equation* required for the parameter estimation is given. Then, we invoke DREM [1] to carry out the latter task with weak excitation requirements.

A. Derivation of the regression equation for parameter estimation

Lemma 3. Consider the electrical dynamics (6) and the output map (7). Define the dynamic extension

$$\dot{\xi} = A(t)\xi + \begin{bmatrix} 0 \\ c_1 u_2 \end{bmatrix} \quad (13a)$$

$$\dot{\Phi} = A(t)\Phi, \quad \Phi(0) = I_2, \quad (13b)$$

where we defined the time-varying matrix⁵

$$A(t) := \begin{bmatrix} -a_2 + \frac{b_2 x'_q}{Y_1(t)} z_0(t) & \frac{b_2 x'_q}{Y_1(t)} y_5(t) \\ -\frac{b_1 x'_q}{Y_1(t)} y_5(t) & -a_1 + \frac{b_1 x'_q}{Y_1(t)} z_0(t) \end{bmatrix}. \quad (14)$$

P1 There exists a constant vector $\theta \in \mathbb{R}^2$ such that

$$\begin{bmatrix} x_3 \\ x_4 \end{bmatrix} = \xi + \Phi\theta. \quad (15)$$

P2 There exists measurable signals $y_E \in \mathbb{R}$ and $\psi \in \mathbb{R}^5$ such that

$$y_E = \psi^\top \Theta, \quad (16)$$

where we defined the constant vector

$$\Theta := \text{col}(\theta_1, \theta_2, \theta_1 \theta_2, \theta_1^2, \theta_2^2). \quad (17)$$

P3 Define the observer

$$\begin{bmatrix} \hat{x}_1 \\ \hat{x}_3 \\ \hat{x}_4 \end{bmatrix} = \begin{bmatrix} \arcsin\left(\frac{1}{Y_1} [Y_3 \quad -Y_2] (\xi + \Phi\hat{\theta})\right) \\ \xi + \Phi\hat{\theta} \end{bmatrix}, \quad (18)$$

where $\hat{\theta}$ is an estimate of the parameter θ . The following implication is true

$$\lim_{t \rightarrow \infty} \tilde{\theta}(t) = 0 \Rightarrow \lim_{t \rightarrow \infty} \begin{bmatrix} \tilde{x}_1(t) \\ \tilde{x}_3(t) \\ \tilde{x}_4(t) \end{bmatrix} = 0. \quad (19)$$

Proof. Define the error signal

$$\epsilon := \begin{bmatrix} x_3 \\ x_4 \end{bmatrix} - \xi \quad (20)$$

and taking into account (6), (11), (13a) and (14) we obtain an LTV system $\dot{\epsilon} = A(t)\epsilon$. Now, from (13b) we see that Φ is the *state transition matrix* of the ϵ system. Consequently, there exists a *constant* vector $\theta \in \mathbb{R}^2$ such that

$$\epsilon = \Phi\theta,$$

namely $\theta = \epsilon(0)$. We now have the following chain of implications

$$\begin{aligned} \epsilon = \Phi\theta &\Leftrightarrow \begin{bmatrix} x_3 \\ x_4 \end{bmatrix} = \xi + \Phi\theta && (\Leftarrow (20)) \\ &\Rightarrow x_3^2 + x_4^2 = |\xi + \Phi\theta|^2 && (\Leftarrow |\cdot|^2) \\ &\Leftrightarrow Y_1 = |\xi + \Phi\theta|^2 && (\Leftarrow (7)). \end{aligned}$$

Notice that the right hand side of the first equivalence above proves property **P1**. The proof of the property **P2** follows

⁵That is, the evaluation of the matrix \mathcal{M} , given in (11), along the trajectories of the system outputs.

developing the right hand side square above, rearranging terms and defining

$$y_E := Y_1 - |\xi|^2$$

$$\psi := \begin{bmatrix} 2(\Phi_{11}\xi_1 + \Phi_{21}\xi_2) \\ 2(\Phi_{12}\xi_1 + \Phi_{22}\xi_2) \\ 2(\Phi_{11}\Phi_{12} + \Phi_{21}\Phi_{22}) \\ \Phi_{11}^2 + \Phi_{21}^2 \\ \Phi_{12}^2 + \Phi_{22}^2 \end{bmatrix}.$$

The proof of the implication for the errors $\text{col}(\tilde{x}_3, \tilde{x}_4)$ is obvious from (15) and the definition of $\text{col}(\hat{x}_3, \hat{x}_4)$ in (18). To prove the claim for \tilde{x}_1 notice that using (7) and the definition of e^{Jx_1} , we get

$$x_3Y_3 - x_4Y_2 = (x_3^2 + x_4^2) \sin(x_1) \\ = Y_1 \sin(x_1),$$

from which we obtain

$$x_1 = \arcsin\left(\frac{x_3Y_3 - x_4Y_2}{Y_1}\right).$$

□□□

B. DREM parameter estimator

In view of the implication (19) the remaining task to complete the observer design is to generate a consistent estimate for θ . Towards this end, we dispose of the regressor equation (16) that, unfortunately, is *nonlinear* in the unknown parameters θ . Treating Θ as the unknown vector, it is possible to obtain an *overparameterized linear* regression to which we can directly apply a classical gradient descent estimator, that is

$$\dot{\hat{\Theta}} = -\Gamma\psi(\psi^\top \hat{\Theta} - y_E), \quad \Gamma > 0. \quad (21)$$

However, this approach has the following fundamental shortcoming. It is well-known [15, Theorem 2.5.1] that a necessary and sufficient conditions for global (exponential) convergence of the gradient estimator is that the regressor ψ satisfies a stringent *persistent excitation* requirement [15, Equation 2.5.3], which is not possible to satisfy in normal operation of the power system because of the overparameterization. To avoid this difficulty we propose here to use a DREM estimator that has the unique feature of generating 5 new, one-dimensional linear regression equations to *independently* estimate each of the parameters. This feature allows, on one hand, to estimate *only* the parameters θ and, on the other hand, to relax the excitation assumptions that guarantee its convergence. This fact is illustrated in the simulations of Section V. For further details on DREM the interested reader is referred to [1].

The first step to apply DREM to (16) is to introduce a *linear, single-input 5-output, bounded-input bounded-output (BIBO)-stable* operator \mathcal{H} and define the vector $Y_E \in \mathbb{R}^5$ and the matrix $\Psi \in \mathbb{R}^{q \times q}$ as

$$Y_E := \mathcal{H}[y_E] \\ \Psi := \mathcal{H}[\psi^\top]. \quad (22)$$

Clearly, because of linearity and BIBO stability, these signals satisfy

$$Y_E = \Psi\Theta. \quad (23)$$

At this point the key step of regressor “mixing” of the DREM procedure is used to obtain a set of 5 *scalar* equations as follows. First, recall that, for any (possibly singular) $q \times q$ matrix M we have $\text{adj}\{M\}M = \det\{M\}I_q$, where $\text{adj}\{\cdot\}$ is the adjunct (also called “adjugate”) matrix. Now, multiplying from the left the vector equation (23) by the *adjunct matrix* of Ψ , we get

$$\mathcal{Y}_i = \Delta\Theta_i, \quad i \in \{1, 2, \dots, 5\} \quad (24)$$

where we have defined the signals

$$\Delta := \det\{\Psi\} \in \mathbb{R} \\ \mathcal{Y} := \text{adj}\{\Psi\}Y_E \in \mathbb{R}^5. \quad (25)$$

The availability of the scalar LREs (24) is the main feature of DREM that distinguishes it with respect to all other estimators and allows us to obtain significantly stronger results. Indeed, in DREM we propose the gradient-descent estimators⁶

$$\dot{\hat{\Theta}}_i = \gamma_i \Delta (\mathcal{Y}_i - \Delta \hat{\Theta}_i),$$

with $\gamma_i > 0$, which gives rise to the scalar error equations

$$\dot{\tilde{\Theta}}_i = -\gamma_i \Delta^2 \tilde{\Theta}_i,$$

whose explicit solution is

$$\tilde{\Theta}_i(t) = e^{-\gamma_i \int_0^t \Delta^2(s) ds} \tilde{\Theta}_i(0). \quad (26)$$

From direct inspection of (26) we conclude that following *equivalence* holds

$$\lim_{t \rightarrow \infty} \tilde{\Theta}_i(t) = 0 \Leftrightarrow \Delta(t) \notin \mathcal{L}_2,$$

and convergence can be made *arbitrarily fast* simply increasing γ_i .

Remark 4. It is clear from the definition of Θ in (17) that we are only interested in the first and second components of this vector.

Remark 5. In [25] it was observed that, using Cramer’s rule, the computation of the adjunct matrix $\text{adj}\{\Psi^T\}$ can be avoided. Indeed, the elements of the vector Y can be computed as

$$\mathcal{Y}_i = \det\{\Psi_{Y_i}^T\} \quad (27)$$

where the matrix Ψ_{Y_i} is obtained replacing the i -th row of Ψ by the vector Y .

⁶In the sequel, the quantifier $i \in \{1, 2, \dots, 5\}$ is omitted for brevity.

C. Main stability result

We are now in position to present the main result of this paper, a *globally convergent* observer for the state of the SMIB power system (1) with measurable outputs (2), with the required excitation conditions been rather weak. As indicated before, the state x_2 can be reconstructed with the I&I observer of [8, Lemma 1] and is omitted for brevity.

Proposition 2. Consider the SMIB power system (1), (2) verifying Assumption 1. Fix a stable transfer matrix⁷

$$\mathcal{H}(s) = \begin{bmatrix} 1 \\ \frac{d_2}{s+d_2} \\ \vdots \\ \frac{d_5}{s+d_5} \end{bmatrix}, \quad d_i > 0, \quad d_i \neq d_j, \quad \forall i \neq j. \quad (28)$$

Let the state observer be defined by (7), (8), (13), (14), (18), (20), (22), (25) together with the parameter estimators

$$\dot{\hat{\theta}}_k = -\gamma_k \Delta (\Delta \hat{\theta}_k - \mathcal{Y}_k), \quad \gamma_k > 0, \quad k = 1, 2. \quad (29)$$

If $\Delta \notin \mathcal{L}_2$ then

$$\lim_{t \rightarrow \infty} \begin{bmatrix} \tilde{x}_1(t) \\ \tilde{x}_3(t) \\ \tilde{x}_4(t) \end{bmatrix} = 0,$$

with all signals bounded.

Proof. Given the derivations of Subsection V-B we get the parameter estimator error equations

$$\dot{\tilde{\theta}}_k = -\gamma_k \Delta^2 \tilde{\theta}_k, \quad k = 1, 2.$$

Clearly, with the standing assumption on Δ , we have that $\tilde{\theta}(t) \rightarrow 0$. The proof is completed invoking (19). $\square \square \square$

Remark 6. Although the construction of DREM allows for the use of general, LTV, BIBO-stable operators \mathcal{H} , for the sake of simplicity we consider here the use of simple LTI filters. Moreover, we take the first element of the matrix to be the identity.

VI. SIMULATION RESULTS

In this section we present some simulations that illustrate the performance of the observer of the states (x_3, x_4) of Proposition 1, which combines GPEBO with DREM. For the sake of comparison we also show the simulation results of GPEBO with the overparameterized parameter estimator (21) and a simple *state* observer directly derived from optimization considerations.

A. Single Machine Infinite Bus

We simulated the system (1) with the parameters $a_0 = 13.2893$, $a_1 = 0.268$, $a_2 = 7.7462$, $b_0 = 6.6447$, $b_1 = 0.1564$, $b_2 = 4.5204$, $c_1 = 0.1116$, obtained from Table I with $u_1 = u_2 = 0.1$. The systems initial conditions were set to $x(0) = \text{col}(0.1, 0.2, 0.4, 0.3)$. The initial conditions of *all* the states of the three observers were set to zero.

⁷The latter condition on the constants d_i is necessary to avoid the possibility of Ψ been singular.

Symbol	Description	Value	Unit
D	Damping factor	2	pu
H	Inertia constant	23.64	sec
k	Tuning parameter	80	-
T'_{d0}	Direct-axis transient open-circuit time constant	8.96	sec
x_d	Direct-axis reactance	0.146	pu
x'_d	Direct-axis transient reactance	0.0608	pu
Y	Stator admittance	16.45	pu
ω_s	Nominal synchronous speed	314.16	rad/sec

TABLE I: Parameters for the SMIB system (1).

1) *GPEBO+DREM of Proposition 1:* The parameters of the transfer matrix (28) were chosen as $d_2 = 2$, $d_3 = 4$, $d_4 = 6$, $d_5 = 8$.

Figures 1 and 2 show the transients of x_3 and x_4 and their observed values \hat{x}_3 and \hat{x}_4 with the adaptation gains $\gamma_1 = \gamma_2 =: \gamma$ and different values for γ . As expected, increasing γ speeds-up the convergence generating some mild overshoots in \hat{x}_3 .

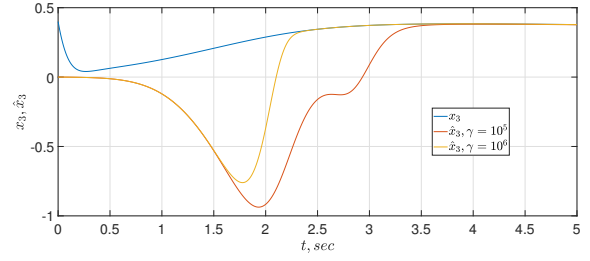

Fig. 1: Transients of x_3 and \hat{x}_3 of GPEBO+DREM for different values of γ

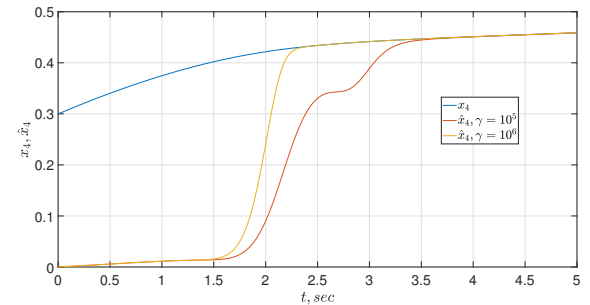

Fig. 2: Transients of x_4 and \hat{x}_4 of GPEBO+DREM for different values of γ

2) *GPEBO with overparameterized estimator (21):* In this subsection we show that the standard gradient estimator (21) for the overparameterized regression is inadequate. Define the vector

$$e := \begin{bmatrix} \Theta_1 \Theta_2 - \Theta_3 \\ \Theta_1 - \Theta_4^2 \\ \Theta_2 - \Theta_5^2 \end{bmatrix}. \quad (30)$$

From the definition of the vector Θ in (17) we have that $e \equiv 0$. Figures 3 and 4 show the transients of the estimated vector \hat{e} with the adaptation gains $\Gamma = 10^6 I_5$ and $\Gamma = 10^8 I_5$, which does not converge to zero—proving that the parameters do

not converge to their true values. Several different values of Γ were tried, observing always an erroneous behavior.

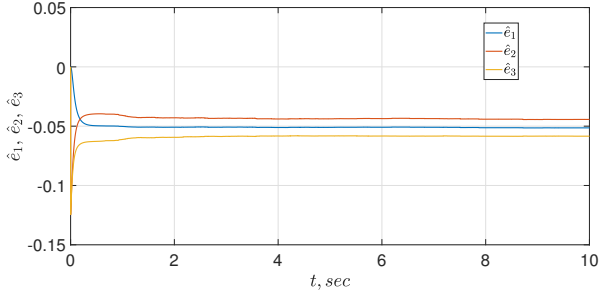

Fig. 3: Transients of \hat{e} for $\Gamma = 10^6 I_5$ of the overparameterized estimator (21)

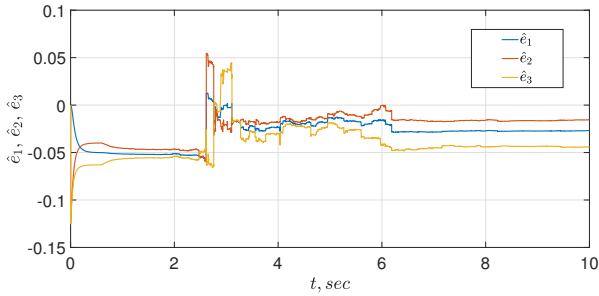

Fig. 4: Transients of \hat{e} for $\Gamma = 10^8 I_5$ of the overparameterized estimator (21)

3) *Gradient-descent state estimation algorithm:* In this subsection we propose to design gradient-descent algorithms, directly for observation of the *states* (x_3, x_4), proceeding from the state-to-output map (10). The gradient descent-based approach to state observation was, apparently, first proposed in [17], and has been pursued recently by several researchers [4], [5], [7], [11], [18].

The construction proceeds as follows. Given the criterion

$$\mathcal{T}(x_3, x_4) := \frac{1}{4} [Y_1 - (x_3^2 + x_4^2)]^2,$$

with Y_1 given in (10), propose an observer

$$\begin{bmatrix} \dot{\hat{x}}_3 \\ \dot{\hat{x}}_4 \end{bmatrix} = -\Gamma \nabla \mathcal{T}(\hat{x}_3, \hat{x}_4) + \left(A(t) \begin{bmatrix} \hat{x}_3 \\ \hat{x}_4 \end{bmatrix} + \begin{bmatrix} 0 \\ c_1 u_2 \end{bmatrix} \right)$$

with $\Gamma \in \mathbb{R}^{2 \times 2}$ positive definite. That is,

$$\begin{bmatrix} \dot{\hat{x}}_3 \\ \dot{\hat{x}}_4 \end{bmatrix} = \Gamma [Y_1 - (\hat{x}_3^2 + \hat{x}_4^2)] \begin{bmatrix} \hat{x}_3 \\ \hat{x}_4 \end{bmatrix} + \left(A(t) \begin{bmatrix} \hat{x}_3 \\ \hat{x}_4 \end{bmatrix} + \begin{bmatrix} 0 \\ c_1 u_2 \end{bmatrix} \right) \quad (31)$$

The local stability properties of this observer can be studied using the Taylor-expansion based analysis proposed in [18].

Figures 5 and 6 show the transients of x_3 and x_4 and their observed values \hat{x}_3 and \hat{x}_4 with $\Gamma = \gamma I$ and different values of γ . Interestingly, the state estimation errors converge to zero, even for large initial conditions errors. However, the transient behavior is significantly slower than the one of GPEBO+DREM—notice the difference in time scales.

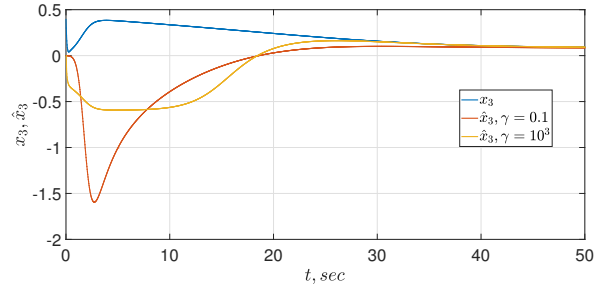

Fig. 5: Transients of x_3 and \hat{x}_3 of the gradient descent observer for different values of Γ

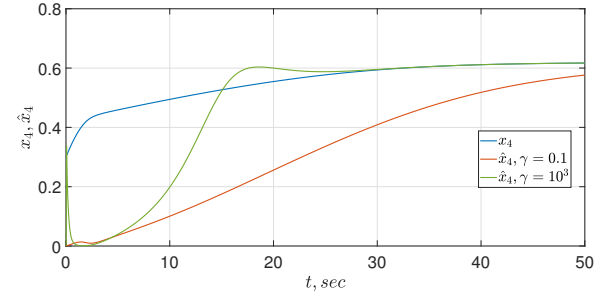

Fig. 6: Transients of x_4 and \hat{x}_4 of the gradient descent observer for different values of Γ

B. Multi-Machine Power System

We simulated the well-known New England IEEE 39 bus system shown in Figure 7, with the parameters provided in [26]. All synchronous generators are represented by the fourth-order flux-decay model (1) and are equipped with automatic voltage regulators and power system stabilizers according to [26]. To monitor the system, we assume that a PMU is installed at the terminal bus of generators 6.

As a test case we used minor load variations in the system. The resulting frequency variations are within 60 ± 0.020 [Hz] and hence consistent with those during regular operation of transmission grids [27].

1) *GPEBO+DREM and algebraic observer of Proposition 2:* The parameters of the transfer matrix (28) were chosen as $d_2 = 2$, $d_3 = 4$, $d_4 = 6$, $d_5 = 8$. Different values were chosen for the adaptation gains $\gamma_i = \gamma$, $i = 1, \dots, 5$. In Figure 8 the simulation results for x_1, x_2, x_3 and the state estimation of the observer of Proposition 2 are shown. As seen from the figure consistent estimation of the state variables is achieved.

2) *GPEBO with overparameterized estimator (21):* The overparameterized estimator was simulated using different values for the adaptation gain $\Gamma = \gamma I_5$. The elements of error vector defined in (30) are given in Figure 9, showing that convergence is not achieved.

3) *Gradient-descent state estimation algorithm (31):* In Figure 10 the simulation results for the gradient-descent state estimation algorithm introduced in (31) are shown using different values for the gain $\Gamma = \gamma I_2$. As seen from the figure the transient behavior is very good, mainly due to the

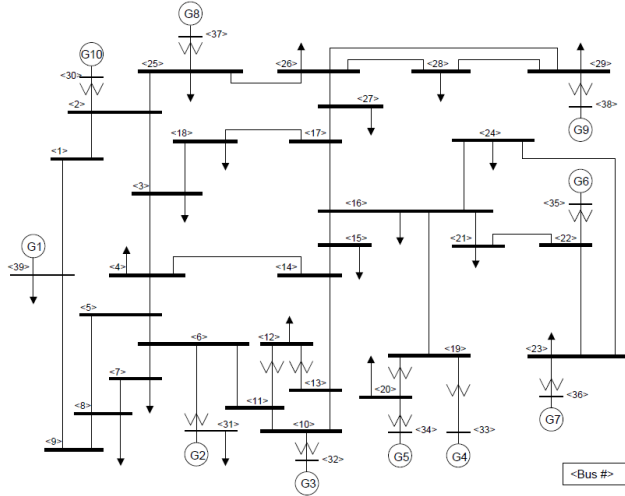

Fig. 7: New England IEEE 39 bus system (figure taken from [26]).

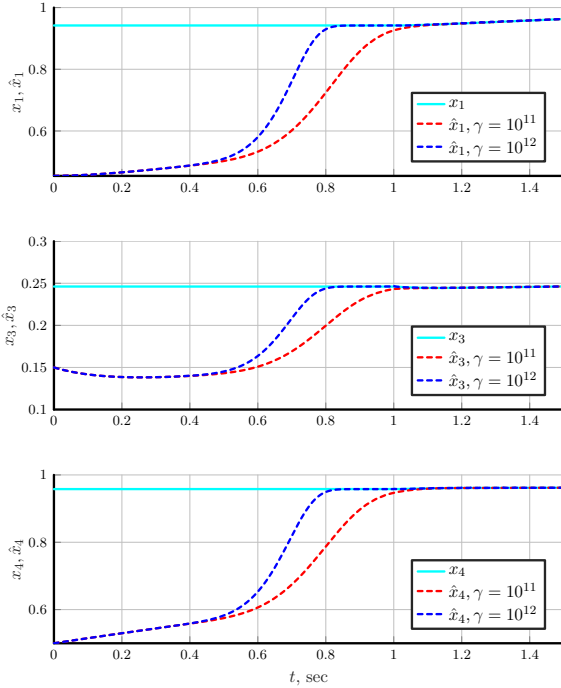

Fig. 8: Transients of the GPEBO+DREM observer, with different values of γ , for generator 6 in the presence of load variations.

rapid change of the state variables x_3 and x_4 that provide the required excitation to estimate the gradient.

VII. CONCLUSION AND FUTURE RESEARCH

We have proposed a globally convergent observer for the state estimation, from PMU measurements, of multimachine power systems described by the widely popular fourth order model (1). It is shown that we can concentrate on the observation of the states (x_3, x_4) and compute x_1 from an explicit algebraic equation.

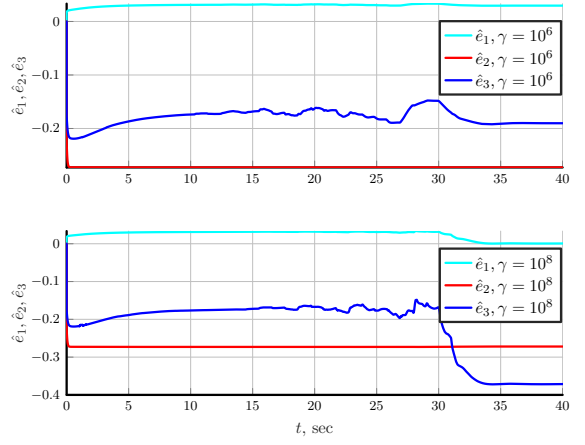

Fig. 9: Transients of the error vector (30) of the overparameterized estimator (21) for generator 6 in the presence of load variations.

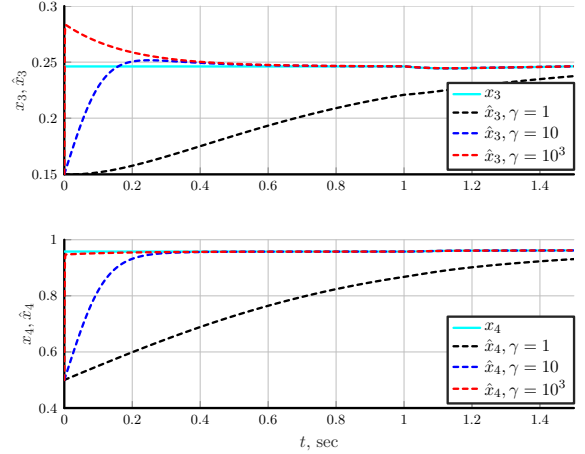

Fig. 10: Transients of the gradient descent observer (31) of generator 6 in the presence of load variations.

For the observation of (x_3, x_4) we have also proposed a gradient-descent based observer that, in spite of the lack of a global convergence proof, performs quite well in a realistic multimachine scenario. A topic of current research is to assess the convergence properties of this observer—beyond the local analysis based on linearization of [18].

Another interesting possibility motivated by (7) is to design a gradient-descent observer for (x_1, x_3, x_4) fixing a cost function

$$\mathcal{T}_N(x_1, x_3, x_4) := \left\| Y - \begin{bmatrix} x_3^2 + x_4^2 \\ e^{Jx_1} \begin{bmatrix} x_3 \\ x_4 \end{bmatrix} \end{bmatrix} \right\|^2,$$

and going in the direction of descent of the gradient—with respect to (x_1, x_3, x_4) —of this cost function. We hope to be able to report this result in the near future.

ACKNOWLEDGMENT

This paper is partially supported by the Ministry of Science and Higher Education of Russian Federation, passport of

goszadanie no. 2019-0898, and by Government of Russian Federation (Grant 08-08).

REFERENCES

- [1] S. Aranovskiy, A. Bobtsov, R. Ortega, A. Pyrkin, Performance enhancement of parameter estimators via dynamic regressor extension and mixing, *IEEE Trans. Automatic Control*, Vol. 62, pp 3546-3550, 2017.
- [2] A. Astolfi, D. Karagiannis and R. Ortega, *Nonlinear and Adaptive Control with Applications*, Springer-Verlag, Berlin, Communications and Control Engineering, 2008.
- [3] P. Bernard, *Observer Design for Nonlinear Systems*, Springer, Vol. 479, 2019.
- [4] P. Bernard and L. Praly, Convergence of gradient observer for rotor position and magnet flux estimation of permanent magnet synchronous motors, *Automatica*, Vol. 94, pp. 88-93, 2018.
- [5] F. Forte, L. Marconi and A. R. Teel, Robust nonlinear regulation: Continuous-time internal models and hybrid identifiers, *IEEE Trans. Automatic Control*, Vol. 62, No. 7, pp. 3136-3151, July 2017.
- [6] E. Ghahremani and I. Kamwa, Dynamic state estimation in power systems by applying the extended Kalman filter with unknown inputs to phasor measurements, *IEEE Transactions on Power Systems*, Vol. 26, No. 4, pp. 2556-2566, 2011
- [7] C. Lageman, J. Trunpf and R. Mahony, Gradient-like observers for invariant dynamics on a Lie group, *IEEE Trans. Automatic Control*, Vol. 55, No. 2, pp. 367-377, 2010.
- [8] M. N. L. Lorenz-Meyer, A. Bobtsov, R. Ortega, J. Schiffer and N. Nikolaev: PMU-Based Decentralized Mixed Algebraic and Dynamic State Observation in Multi-Machine Power Systems, *IEEE Trans. on Power Systems*, (submitted).
- [9] J. Machowski, J. W. Bialek, J. Bumby, *Power System Dynamics: Stability and Control*, John Wiley & Sons, 2008.
- [10] F. Milano, F. Dörfler, G. Hug, D. Hill and G. Verbič, Foundations and challenges of low-inertia systems, *2018 Power Systems Computation Conference (PSCC)*, pp. 1-25, 2018.
- [11] R. Ortega, L. Praly, A. Astolfi, J. Lee and K. Nam, Estimation of rotor position and speed of permanent magnet synchronous motors with guaranteed stability, *IEEE Trans. Control Systems Technology*, Vol. 19, pp. 601-614, 2011.
- [12] R. Ortega, A. Bobtsov, A. Pyrkin and A. Aranovskiy, A parameter estimation approach to state observation of nonlinear systems, *Systems and Control Letters*, Vol. 85, pp 84-94, 2015.
- [13] R. Ortega, A. Bobtsov, N. Nikolayev, J. Schiffer and D. Dochain, Generalized parameter estimation-based observers: application to power systems and chemical-biological reactors, *Automatica*, (submitted). arXiv:2003.10952
- [14] A. Paul, G. Joos and I. Kamwa, Dynamic state estimation of full power plant model from terminal phasor measurements, *2018 IEEE/PES Transmission and Distribution Conference and Exposition (T&D)*, pp. 1-5, 2018.
- [15] S. Sastry and M. Bodson, *Adaptive Control: Stability, Convergence and Robustness*, Prentice-Hall, New Jersey, 1989.
- [16] P. Sauer, M. A. Pai and J. Chow, *Power Systems Dynamics and Stability*, Wiley, 2017.
- [17] K. Shimizu, S. Suzuki and H. Nukumi, A state estimator of nonlinear systems by steepest-descent method, *Proc. of SICE 17th*, DST Symp., 1994.
- [18] K. Shimizu, Nonlinear state observers by gradient-descent method, *Proc. of the 2000 IEEE International Conference on Control Applications*, Anchorage, Alaska, USA, September 25-27, 2000.
- [19] A. Singh and B. Pal, *Dynamic Estimation and Control of Power Systems*, Academic Press, 2018.
- [20] V. Terzija, et al., Wide-area monitoring, protection, and control of future electric power networks, *Proceedings of the IEEE*, Vol. 99, No. 1, pp. 80-93, 2010,
- [21] W. Winter, K. Elkington, G. Bareux and J. Kostevc, Pushing the Limits: Europe's New Grid: Innovative Tools to Combat Transmission Bottlenecks and Reduced Inertia, *IEEE Power and Energy Magazine*, Vol. 13, No. 1, pp. 60-74, 2015.
- [22] T. Weckesser, H. Johansson and J. Ostergaard, Impact of model detail of synchronous machines on real-time transient stability assessment, *2013 IREP Symposium-Bulk Power System Dynamics and Control IX (IREP)*, Rethymnon, Greece, August 25-30, 2013
- [23] J. Zhao, A Gomez-Exposito, M. Netto, L. Mili, A. Abur, V. Terzija, I. Kamwa, B. Pal, A. K. Singh, J. Qi, Z. Huang and A. P. Sakis Meliopoulos, Power system dynamic state estimation: motivations, definitions, methodologies and future work, [IEEE Task Force on Power System Dynamic State and Parameter Estimation], *IEEE Trans. on Power Systems*, (Early access.)
- [24] H. Kopka and P. W. Daly, *A Guide to L^AT_EX*, 3rd ed. Harlow, England: Addison-Wesley, 1999.
- [25] M. Korotina, A. Aranovskiy, R. Ushirobira, A. Vedyakov, On parameter tuning and convergence properties of the drem procedure, To appear in Proc. European Control Conf. 2020 .
- [26] Canizares, C and Fernandes, T and Gerdali Jr, E and Gérin-Lajoie, L and Gibbard, M and Hiskens, I and Kersulis, J and Kuiava, R and Lima, L and Marco, F and others, Benchmark systems for small signal stability analysis and control, *IEEE PES*, 2015.
- [27] T. Weissbach, Verbesserung des Kraftwerks-und Netzregelverhaltens bezüglich handelsseitiger Fahrplanänderungen, Ph.D. dissertation, University of Stuttgart, 2009.



Alexey Bobtsov (SM'10) received the M.S. degree in electrical engineering from ITMO University, St. Petersburg, Russia in 1996, received his PhD in 1999 and the degree of Doctor of Science (habilitation thesis) in 2007 from the same University. From November 1999 to December 2000 he served as Assistant Lecturer of Department of Automation and Remote Control. From December 2000 to May 2007 Dr. Bobtsov served as Associate Professor of Department of Control Systems and Informatics. In May 2007 Dr. Bobtsov was appointed as Professor of Department of Control Systems and Informatics. In September 2008 he was elected as the Dean of Computer Technologies and Control Faculty. He is currently the Dean of School of Computer Science and Control at ITMO University. He is a Senior Member of IEEE since 2010. He is a Member of International Public Association Academy of Navigation and Motion Control. He is coauthor of more than 300 journal and conference papers, 5 patents, 15 books and textbooks. His research interests are in fields of nonlinear and adaptive control, control of oscillatory and chaotic systems and computer-aided control systems design with applications to mechanical and robotic systems.

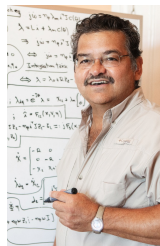

Romeo Ortega (S'81, M'85, SM'98, F'99, LF'20) was born in Mexico. He obtained his BSc in Electrical and Mechanical Engineering from the National University of Mexico, Master of Engineering from Polytechnical Institute of Leningrad, USSR, and the Docteur D'Etat from the Polytechnical Institute of Grenoble, France in 1974, 1978 and 1984 respectively. He then joined the National University of Mexico, where he worked until 1989. He was a Visiting Professor at the University of Illinois in 1987-88 and at the McGill University in 1991-1992, and a Fellow of the Japan Society for Promotion of Science in 1990-1991. He has been a member of the French National Researcher Council (CNRS) since June 1992. Currently he is in the Laboratoire de Signaux et Systemes (CENTRALE-SUPELEC) in Gif-sur-Yvette. His research interests are in the fields of nonlinear and adaptive control, with special emphasis on applications. Dr Ortega has published three books and more than 350 scientific papers in international journals, with an h-index of 83. He has supervised 35 PhD thesis. He has served as chairman in several IFAC and IEEE committees and participated in various editorial boards. Currently, he is Editor in Chief of Int. J. on Adaptive Control and Signal Processing.



Nikolay Nikolaev received the M.S. degree in electrical engineering from ITMO University, St. Petersburg, Russia in 2003, received his PhD in 2006 from the same University. From 2002 until 2013 he worked as Engineer of Department of Control Systems Design for Power Plants at JSC Kirovsky Zavod (Kirov Plant). From 2013 he is an Assistant Professor in Department of Control Systems and Robotics from ITMO University. He is a Member of IEEE since 2006. His research interests are in fields of nonlinear and adaptive control.



Johannes Schiffer received the Diploma degree in engineering cybernetics from the University of Stuttgart, Germany, in 2009 and the Ph.D. degree (Dr.-Ing.) in electrical engineering from Technische Universität (TU) Berlin, Germany, in 2015. He currently holds the chair of Control Systems and Network Control Technology at Brandenburgische Technische Universität Cottbus-Senftenberg, Germany, where he also serves as Deputy of Research. Prior to that, he has held appointments as Lecturer (Assistant Professor) at the School of Electronic and

Electrical Engineering, University of Leeds, U.K. and as Research Associate in the Control Systems Group and at the Chair of Sustainable Electric Networks and Sources of Energy both at TU Berlin. In 2017 he and his co-workers received the Automatica Paper Prize over the years 2014-2016. His current research interests include distributed control and analysis of complex networks with application to microgrids and power systems.



M. Nicolai L. Lorenz-Meyer received his M.Sc. in Engineering Science from the Technical University of Berlin in 2019 and his B.Eng. in Business Administration and Engineering for Environment and Sustainability from the Beuth University of Applied Sciences and the Berlin School of Economics and Law in 2016. He is currently pursuing the Ph.D. degree with the the chair of Control Systems and Network Control Technology at the Brandenburg University of Technology Cottbus-Senftenberg, Germany. His current research interests include the

development of control theory-based methods for on-line dynamics security assessment in power systems.