

B-RIGIDITY OF THE PROPERTY TO BE AN ALMOST POGORELOV POLYTOPE

NIKOLAI EROKHOVETS

ABSTRACT. Toric topology assigns to each n -dimensional combinatorial simple convex polytope P with m facets an $(m+n)$ -dimensional moment-angle manifold \mathcal{Z}_P with an action of a compact torus T^m such that \mathcal{Z}_P/T^m is a convex polytope of combinatorial type P . We study the notion of B -rigidity. A property of a polytope P is called B -rigid, if an isomorphism of graded rings $H^*(\mathcal{Z}_P, \mathbb{Z}) = H^*(\mathcal{Z}_Q, \mathbb{Z})$ for simple n -polytope Q implies that it also has this property. We study families of 3-dimensional polytopes defined by their cyclic k -edge-connectivity. These families include flag polytopes and Pogorelov polytopes, that is polytopes realizable as bounded right-angled polytopes in Lobachevsky space \mathbb{L}^3 . Pogorelov polytopes include fullerenes – simple polytopes with only pentagonal and hexagonal faces. It is known that the properties to be flag and Pogorelov polytope are B -rigid. We focus on almost Pogorelov polytopes, which are strongly cyclically 4-edge-connected polytopes. They correspond to right-angled polytopes of finite volume in \mathbb{L}^3 . There is a subfamily of ideal almost Pogorelov polytopes corresponding to ideal right-angled polytopes. We prove that the properties to be an almost Pogorelov polytope and an ideal almost Pogorelov polytope are B -rigid. As a corollary we obtain that 3-dimensional associahedron As^3 and permutohedron Pe^3 are B -rigid. We generalize methods known for Pogorelov polytopes. We obtain results on B -rigidity of subsets in $H^*(\mathcal{Z}_P, \mathbb{Z})$ and prove an analog of the so-called separable circuit condition (SCC). As an example we consider the ring $H^*(\mathcal{Z}_{As^3}, \mathbb{Z})$.

INTRODUCTION

Consider a unit circle $S^1 \subset \mathbb{C}$ and a unit disk $D^2 \subset \mathbb{C}$. Toric topology (see [BP15]) assigns to each simple convex n -polytope P with m faces F_1, \dots, F_m an $(m+n)$ -dimensional *moment-angle manifold* \mathcal{Z}_P with an action of a compact m -dimensional torus $T^m = (S^1)^m$ such that $\mathcal{Z}_P/T^m = P$. One of the ways to define the space \mathcal{Z}_P is

$$\mathcal{Z}_P = P^n \times T^m / \sim, \text{ where } (p_1, t_1) \sim (p_2, t_2) \text{ if and only if } p_1 = p_2, \text{ and } t_1 t_2^{-1} \in T^{G(p_1)}.$$

Here for any point $p \in P$ the face $G(p)$ is defined as $G(p) = \bigcap_{F_i \ni p} F_i$, and for the face $G \subset P$ the subgroup $T^G \subset T^m$ is defined as

$$T^G = \{(t_1, \dots, t_m) \in T^m : t_i = 1 \text{ for } F_i \not\supset G\}.$$

2010 *Mathematics Subject Classification.* 05C40, 05C75, 05C76, 13F55, 52B05, 52B10, 52B70, 57R19, 57R91

Key words and phrases. Three-dimensional polytope, toric topology, almost Pogorelov polytope, B -rigidity, cyclic k -edge-connectivity, fullerene, right-angled polytope.

The research was supported by the RFBR grant No 18-51-50005.

We have $T^G \simeq T^{\dim G}$. It can be shown that the space \mathcal{Z}_P depends only on combinatorial type of P and has a smooth structure such that the action of T^m obtained from its action on the second factor, is smooth.

Definition 0.1. A simple n -polytope is called *B-rigid*, if for any simple n -polytope Q an isomorphism of graded rings $H^*(\mathcal{Z}_P, \mathbb{Z}) \simeq H^*(\mathcal{Z}_Q, \mathbb{Z})$ implies that P and Q are combinatorially equivalent.

We study families of simple 3-polytopes defined by the condition of a *cyclic edge k -connectivity* (*ck-connectivity*). A *k -belt* is a cyclic sequence of k faces with the property that faces are adjacent if and only if they follow each other, and no three faces have a common vertex. A simple polytope different from the *simplex* Δ^3 is *ck-connected*, if it has no l -belts for $l < k$, and is *strongly ck-connected* (*c^*k -connected*), if in addition any its k -belt surrounds a face (to be short we say that it is *trivial*). By definition Δ^3 is *c^*3 -connected* but not *$c4$ -connected*.

All simple polytopes (family \mathcal{P}_s) are *$c3$ -connected*. We obtain a chain of nested families:

$$\mathcal{P}_s \supset \mathcal{P}_{aflag} \supset \mathcal{P}_{flag} \supset \mathcal{P}_{aPog} \supset \mathcal{P}_{Pog} \supset \mathcal{P}_{Pog^*}$$

The family of *$c4$ -connected* polytopes coincides with the family \mathcal{P}_{flag} of *flag* polytopes defined by the property that any set of pairwise adjacent faces has a non-empty intersection. Each face of a flag polytope is surrounded by a belt. The Euler formula implies that any simple polytope has a 3-, 4- or 5-gonal face. Hence it can not be more than *c^*5 -connected*.

The family of *c^*3 -connected* polytopes we call *almost flag* polytopes and denote \mathcal{P}_{aflag} .

Results by A.V. Pogorelov [P67] and E.M. Andreev [A70a] imply that *$c5$ -connected* polytopes (family \mathcal{P}_{Pog}) are exactly polytopes realizable in the Lobachevsky space \mathbb{L}^3 as bounded polytopes with right dihedral angles. Moreover, the realization is unique up to isometries. These polytopes were called *Pogorelov polytopes*, since the paper [P67] is devoted to exactly this class of polytopes. The paper [A70a] implies that flag polytopes are exactly polytopes realizable in \mathbb{L}^3 as polytopes with equal non-obtuse dihedral angles. An example of Pogorelov polytopes is given by *k -barrels* B_k , $k \geq 5$, (*Löbell polytopes* in terminology of A.Yu. Vesnin [V17]), see Fig. 1a). Results by T. Döslić (1998, 2003) imply that the family \mathcal{P}_{Pog} contains *fullerenes*, that is simple polytopes with only pentagonal and hexagonal faces. Mathematical fullerenes model spherical carbon atoms. In 1996 R. Curl, H. Kroto, and R. Smalley obtained the Nobel Prize in chemistry “for their discovery of fullerenes”. They synthesized *Buckminsterfullerene* C_{60} (see Fig. 1b), which has the form of the truncated icosahedron (and also of a soccer ball). W.P. Thurston [T02] built a parametrisation of the fullerene family, which implies that the number of fullerenes with n carbon atoms grows like n^9 when n tends to infinity.

The family \mathcal{P}_{aPog} of *c^*4 -connected* polytopes we call *almost Pogorelov* polytopes, and the family \mathcal{P}_{Pog^*} of *c^*5 -connected* polytopes – *strongly Pogorelov*. G. D. Birkhoff (1913) reduced the 4-colour problem to the task to colour in 4 colours faces of polytopes of the family, which turned out to be the family \mathcal{P}_{Pog^*} .

T. E. Panov remarked that results by E. M. Andreev [A70a, A70b] should imply that almost Pogorelov polytopes correspond to right-angled polytopes of finite volume in \mathbb{L}^3 . Such polytopes may have 4-valent vertices on the absolute, while all proper vertices have valency 3. It was proved

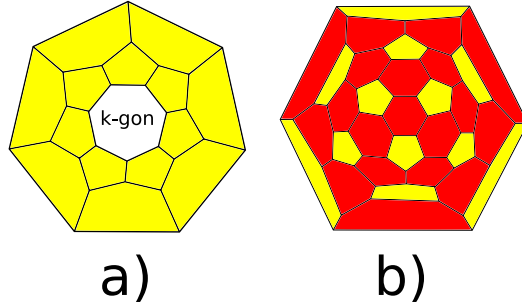

FIGURE 1. a) k -barrel B_k ; b) fullerene C_{60}

in [E19] that cutting of 4-valent vertices defines a bijection between classes of combinatorial equivalence of right-angled polytopes of finite volume in \mathbb{L}^3 and almost Pogorelov polytopes different from the cube I^3 and the pentagonal prism $M_5 \times I$.

In the paper [V87] A. Yu. Vesnin introduced a construction of a 3-dimensional compact hyperbolic manifold $R(P, \Lambda)$ corresponding to a mapping Λ_2 of the set of faces of a polytope $P \in \mathcal{P}_{Pog}$ to $\mathbb{Z}_2^3 = (\mathbb{Z}/2\mathbb{Z})^3$ such that for any vertex the images of the faces containing it form a basis. The manifold is obtained by gluing 8 copies of the polytope along faces. The existence of a mapping follows from the 4 colour theorem. In toric topology such manifolds are obtained as *small covers* over right-angled polytopes. For a mapping Λ of the set of faces $\{F_1, \dots, F_m\}$ to \mathbb{Z}^3 such that for any vertex the images of faces containing it form a basis in \mathbb{Z}^n toric topology associates a $2n$ -dimensional smooth *quasitoric manifold* $M(P, \Lambda)$ with an action of T^n such that $M(P, \Lambda)/T^n = P$.

In [FMW15] F. Fan, J. Ma and X. Wang proved that any Pogorelov polytope is B -rigid.

In [BEMPP17] the following result was proved

Theorem 0.2 ([BEMPP17]). *For polytopes $P, P' \in \mathcal{P}_{Pog}$ with functions Λ_2, Λ , and Λ'_2, Λ' the manifolds $M(P, \Lambda)$ and $M(P', \Lambda')$ are diffeomorphic if and only if their cohomology rings over \mathbb{Z} are isomorphic as graded rings, and if and only if there is a combinatorial equivalence φ between P and P' and a change of coordinates $A \in Gl_3(\mathbb{Z})$ such that for any face F of P we have $\Lambda'(\varphi(F)) = \pm A\Lambda(F)$. The manifolds $R(P, \Lambda_2)$ and $R(P', \Lambda'_2)$ are diffeomorphic if and only if their cohomology rings over \mathbb{Z}_2 are isomorphic as graded rings, and if and only if there is a combinatorial equivalence φ between P and P' and a change of coordinates $A_2 \in Gl_3(\mathbb{Z}_2)$ such that for any face F of P we have $\Lambda'_2(\varphi(F)) = \pm A_2\Lambda_2(F)$.*

In this paper we develop methods from [FMW15] (see also [BE17S]) known for Pogorelov polytopes to almost Pogorelov polytopes.

The cube and the pentagonal prism belong to \mathcal{P}_{aPog} . All the other polytopes from \mathcal{P}_{aPog} have no adjacent quadrangles. The simplest polytope of this type is the 3-dimensional *Stasheff polytope* (or *associahedron*) As^3 (see Fig. 2), which is the cube with three pairwise disjoint orthogonal edges cut. Result by D. Barnette [B74] imply that a simple polytope belongs to $\mathcal{P}_{aPog} \setminus \{I^3, M_5 \times I\}$ if and only if it can be obtained from As^3 by a sequence of cuttings off edges not lying in quadrangles and pairs of adjacent edges of at least hexagonal faces. On Fig.

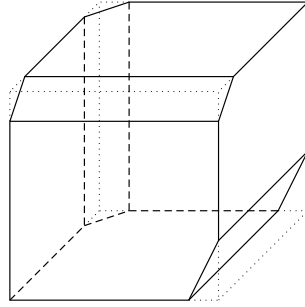

FIGURE 2. A 3-dimensional associahedron (Stasheff polytope) As^3 as a truncated cube

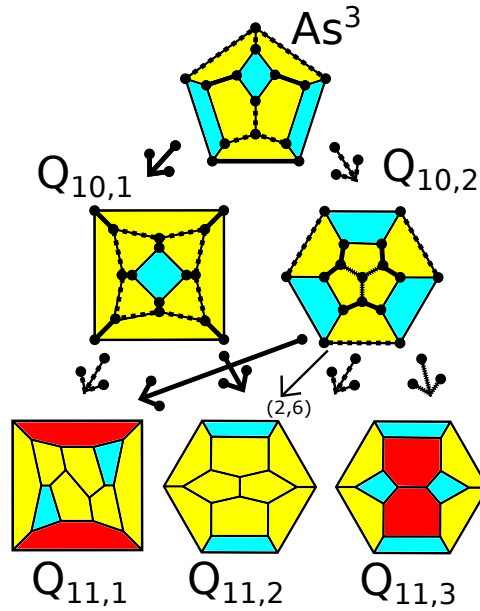

FIGURE 3. Almost Pogorelov polytopes with at most 11 faces

3 we draw fall possible ways to construct almost Pogorelov polytopes with at most $m = 11$ facets.

A polytope in \mathbb{L}^3 is called *ideal*, if all its vertices lie on the absolute. An ideal polytope has a finite volume. We will call almost Pogorelov polytope corresponding to ideal right-angled polytopes *ideal almost Pogorelov polytopes*. It is known (see more details in [E19]) that graphs of ideal right-angled 3-polytopes are exactly *medial graphs* of simple 3-polytopes. Vertices of a medial graph correspond to edges of a polytope, and edges – to pairs of edges adjacent in a face. A medial graph of the k -pyramid is known as k -antiprism, see Fig. 4.

An operation of an *edge-twist* is drawn on Fig. 5. Two edges on the left lie in the same face and are disjoint. Let us call an edge-twist *restricted*, if both edges are adjacent to an edge of the

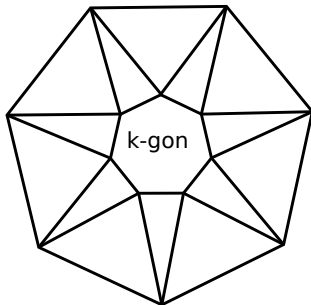

FIGURE 4. A k -antiprism.

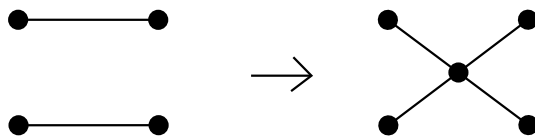

FIGURE 5. An edge-twist.

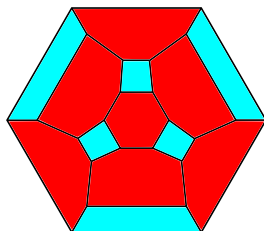

FIGURE 6. Three-dimensional permutohedron Pe^3

same face. It follows from [V17, BGGMTW05, E19], that a polytope is realizable as an ideal right-angled polytope if and only if either it is a k -antiprism, $k \geq 3$, or it can be obtained from the 4-antiprism by a sequence of restricted edge-twists.

Thus, the simplest ideal right-angled polytope is a 3-antiprism, which coincides with the octahedron. The corresponding ideal almost Pogorelov polytope is known as 3-dimensional permutohedron, see Fig. 6. This is a unique ideal almost Pogorelov polytope with minimal number of faces (14 faces).

Main result of the paper is the fact that the properties to be an almost Pogorelov polytope and ideal almost Pogorelov polytopes are B -rigid (Theorem 3.11 and Corollary 3.13). This implies that polytopes of these families with $m \leq 11$ and $m \leq 18$ respectively, in particular As^3 and Pe^3 , are B -rigid (Corollaries 3.12 and 3.14).

We prove the analog of the so-called separable circuit condition (SCC), which plays a crucial role in toric topology of Pogorelov polytopes. SCC: for any Pogorelov polytope P and any three different facets $\{F_i, F_j, F_k\}$ with $F_i \cap F_j = \emptyset$ there exist $l \geq 5$ and an l -belt \mathcal{B}_l such that $F_i, F_j \in \mathcal{B}_l$, $F_k \notin \mathcal{B}_l$, and F_k does not intersect at least one of the two connected

components of $\mathcal{B}_l \setminus \{F_i, F_j\}$. We prove (Lemma 3.17) that for an almost Pogorelov polytope P for three pairwise different facets $\{F_i, F_j, F_k\}$ such that $F_i \cap F_j = \emptyset$ there exists an l -belt ($l \geq 4$) \mathcal{B}_l such that $F_i, F_j \in \mathcal{B}_l$, $F_k \notin \mathcal{B}_l$, and F_k does not intersect at least one of the two connected components of $\mathcal{B}_l \setminus \{F_i, F_j\}$ if and only if F_k does not intersect quadrangles among the faces F_i and F_j .

In Proposition 2.2 we simplify a criterion for a simple 3-polytope to be flag, namely $\text{rk } H^4(\mathcal{Z}_P) = \frac{(m-2)(m-4)(m-6)}{3}$.

For almost Pogorelov polytopes we prove B -rigidity (see Definition 2.1) of the set of elements corresponding to 4-belts (Lemma 3.4) and of cosets corresponding to pairs of disjoint faces lying in 4-belts (Lemma 3.5).

As an example, in Section 4 we consider the ring $H^*(\mathcal{Z}_P, \mathbb{Z})$ for $P = As^3$ and prove (Proposition 4.3) that the other crucial tool for Pogorelov polytopes – an annihilator lemma – is not valid for almost Pogorelov polytopes. We prove an analog of this lemma (Lemma 2.4) and study the arising notion of good and bad pairs of disjoint faces.

1. COHOMOLOGY RING OF THE MOMENT-ANGLE MANIFOLD OF A SIMPLE THREE-POLYTOPE

Details on cohomology of a moment-angle manifolds see in [BP15, BE17S]. If not specified, we study cohomology over \mathbb{Z} and omit the coefficient ring.

$H^*(\mathcal{Z}_P)$ is a multigraded ring with grading $\mathbb{Z} \times \mathbb{Z}^m$. Nonzero elements exist only in components $(-i, 2j_1, \dots, 2j_m)$ with $i \geq 0$ and $j_1, \dots, j_m \in \{0, 1\}$. We denote these components $H^{-i, 2\omega}(\mathcal{Z}_P) \subset H^{2|\omega| - i}(\mathcal{Z}_P)$, where $\omega = \{j: y_j = 1\}$. In particular, the mapping

$$H^{-i, 2\omega_1}(\mathcal{Z}_P) \otimes H^{-j, 2\omega_2}(\mathcal{Z}_P) \rightarrow H^{-(i+j), 2(\omega_1 \cup \omega_2)}(\mathcal{Z}_P)$$

is zero if $\omega_1 \cap \omega_2 \neq \emptyset$.

For any simple n -polytope P with m facets F_1, \dots, F_m and any subset $\omega \subset [m]$ denote $P_\omega = \bigcup_{i \in \omega} F_i$. We have

$$H^{-i, 2\omega}(\mathcal{Z}_P) \simeq \tilde{H}^{|\omega| - i - 1}(P_\omega),$$

where by definition $\tilde{H}^{-1}(\emptyset) = \mathbb{Z}$.

For any simple 3-polytope P with m facets and any subset $\omega \subset [m]$ the set P_ω is 2-dimensional manifold, perhaps with a boundary. Each its connected component is a sphere with holes. In particular, its boundary is a disjoint union of simple edge-cycles. We have

$$\tilde{H}^{|\omega| - i - 1}(P_\omega) = \begin{cases} \tilde{H}^{-1}(\emptyset) = \mathbb{Z}, & \text{if } \omega = \emptyset, \text{ and } i = 0. \text{ Then } 2|\omega| - i = 0; \\ \tilde{H}^0(P_\omega), & \text{if } |\omega| = i + 1, \text{ that is } 2|\omega| - i = i + 2 = |\omega| - 1; \\ \tilde{H}^1(P_\omega), & \text{if } |\omega| = i + 2, \text{ that is } 2|\omega| - i = i + 4 = |\omega| - 2; \\ \tilde{H}^2(\partial P) = \mathbb{Z}, & \text{if } m = |\omega| = i + 3. \text{ Then } 2|\omega| - i = m + 3; \\ 0, & \text{in all other cases.} \end{cases}$$

In particular, P has no torsion. Also we have a multigraded Poincare duality, which means that the bilinear form

$$H^{-i,2\omega}(\mathcal{Z}_P) \times H^{m-3-i,2([m]\setminus\omega)}(\mathcal{Z}_P) \rightarrow H^{m-3,2[m]}(\mathcal{Z}_P) = \mathbb{Z}$$

has in some basis matrix with determinant ± 1 . In particular, for a basis $\{e_\alpha\}$ in $H^{-i,2\omega}(\mathcal{Z}_P)$ there is a dual basis $\{e_\beta^*\}$ in $H^{m-3-i,2([m]\setminus\omega)}(\mathcal{Z}_P)$ such that $e_\alpha \cdot e_\beta^* = \delta_{\alpha,\beta}$.

We have

$$\begin{aligned} H^0(\mathcal{Z}_P) &= \tilde{H}^{-1}(\emptyset) = \mathbb{Z} = \tilde{H}^2(\partial P) = H^{m+3}(\mathcal{Z}_P); \\ H^1(\mathcal{Z}_P) &= H^2(\mathcal{Z}_P) = 0 = H^{m+1}(\mathcal{Z}_P) = H^{m+2}(\mathcal{Z}_P); \\ H^k(\mathcal{Z}_P) &= \bigoplus_{|\omega|=k-1} \tilde{H}^0(P_\omega) \oplus \bigoplus_{|\omega|=k-2} \tilde{H}^1(P_\omega); \end{aligned}$$

If $\omega_1 \cap \omega_2 = \emptyset$, we have the multiplication

$$\tilde{H}^{k_1}(P_{\omega_1}) \otimes \tilde{H}^{k_2}(P_{\omega_2}) \rightarrow \tilde{H}^{k_1+k_2+1}(P_{\omega_1 \sqcup \omega_2})$$

In particular, for 3-polytopes nontrivial multiplication occurs only for

- (1) $k_i = -1$, $\omega_i = \emptyset$, for some i . We have $\tilde{H}^{-1}(P_\emptyset) \otimes \tilde{H}^k(P_\omega) \rightarrow \tilde{H}^k(P_\omega)$. This trivial case corresponds to multiplication by 1 in $H^*(\mathcal{Z}_P)$;
- (2) $k_i = 0$, $k_{2-i} = 1$, $\omega_{2-i} = [m] \setminus \omega_i$ for some i . We have $\tilde{H}^0(P_\omega) \otimes \tilde{H}^1(P_{[m]\setminus\omega}) \rightarrow \tilde{H}^2(\partial P)$. This case corresponds to the Poincare duality pairing.
- (3) $k_1 = k_2 = 0$. We have the mapping $\tilde{H}^0(P_{\omega_1}) \otimes \tilde{H}^0(P_{\omega_2}) \rightarrow \tilde{H}^1(P_{\omega_1 \sqcup \omega_2})$.

The explicit way to describe multiplication comes from the Poincare-Lefschets duality

$$H^i(P_\omega) \simeq H_{n-1-i}(P_\omega, \partial P_\omega).$$

Denote by $\hat{H}_i(P_\omega, \partial P_\omega)$ the subgroup corresponding to $\tilde{H}^{n-i}(P_\omega)$ under isomorphism. Then up to a sign the multiplication is induced by intersection of faces. In particular, the multiplication $\tilde{H}^0(P_{\omega_1}) \otimes \tilde{H}^0(P_{\omega_2}) \rightarrow \tilde{H}^1(P_{\omega_1 \sqcup \omega_2})$ corresponds to

$$\hat{H}_2(P_{\omega_1}, \partial P_{\omega_1}) \otimes \hat{H}_2(P_{\omega_2}, \partial P_{\omega_2}) \rightarrow \hat{H}_1(P_{\omega_1 \sqcup \omega_2}, \partial P_{\omega_1 \sqcup \omega_2}),$$

where for a connected component in P_{ω_1} and a connected component in P_{ω_2} the result is a disjoint set of edge paths on $P_{\omega_1 \sqcup \omega_2}$ with each end lying on the boundary $\partial P_{\omega_1 \sqcup \omega_2}$.

Remark 1. Moreover, if the product is nonzero, it is represented by a collection of oriented paths, each connecting two different boundary components of $P_{\omega_1 \sqcup \omega_2}$, where for each boundary component there are at most two paths having end on it, and if there are two paths, then one finishes and the other starts on the component. Also there is necessarily at least one component with exactly one end on it. Thus, the product can be chosen as a generator in $\hat{H}_1(P_{\omega_1 \sqcup \omega_2}, \partial P_{\omega_1 \sqcup \omega_2})$.

2. COHOMOLOGICAL RIGIDITY

Definition 2.1. Let \mathfrak{P} be some set of 3-polytopes.

We call a property of simple polytopes *B-rigid* in \mathfrak{P} if for any polytope $P \in \mathfrak{P}$ with this property the isomorphism of graded rings $H^*(\mathcal{Z}_P) \simeq H^*(\mathcal{Z}_Q)$, $Q \in \mathfrak{P}$ implies that Q also has this property.

We call a set $\mathfrak{S}_P \subset H^*(\mathcal{Z}_P)$ defined for any polytope $P \in \mathfrak{P}$ of polytopes *B-rigid* in \mathfrak{P} if for any isomorphism φ of graded rings $H^*(\mathcal{Z}_P) \simeq H^*(\mathcal{Z}_Q)$, $P, Q \in \mathfrak{P}$ we have $\varphi(\mathfrak{S}_P) = \mathfrak{S}_Q$. Similarly a collection of such sets is *B-rigid* in \mathfrak{P} , if each set from the collection for P is mapped bijectively to some set from the collection for Q .

We call a polytope *B-rigid* in \mathfrak{P} , if any isomorphism of graded rings $H^*(\mathcal{Z}_P) \simeq H^*(\mathcal{Z}_Q)$, $Q \in \mathfrak{P}$, implies that Q is combinatorially equivalent to P .

B-rigidity in the class of all simple 3-polytope we call simply *B-rigidity*.

In [FW15] it was proved that the property to be flag polytope is *B-rigid*. Namely, it was proved that it is equivalent to the fact that the ring $\tilde{H}^*(\mathcal{Z}_P)/([\mathcal{Z}_P])$ is a (nonzero) indecomposable ring. Also they proved that for flag 3-polytopes we have

$$\tilde{H}^1(P_\omega) = \bigoplus_{\omega_1 \sqcup \omega_2} \tilde{H}^0(P_{\omega_1}) \cdot \tilde{H}^0(P_{\omega_2}).$$

Their result was based on the fact that for any flag 3-polytope and any three different facets $\{F_i, F_j, F_k\}$ with $F_i \cap F_j = \emptyset$ there exist $l \geq 4$ and an l -belt \mathcal{B}_l such that $F_i, F_j \in \mathcal{B}_l$ and $F_k \notin \mathcal{B}_l$. In fact, this fact is characteristic for a polytope $P \neq \Delta^3$ to be flag. Indeed, if P has a 3-belt, then for the faces F_i and F_j lying in different connected components of the complement to this belt there are no k -belts containing F_i and F_j .

On the base of these facts in [BE17S] and [BEMPP17] a simple characterization of flag polytopes was given: a simple 3-polytope $P \neq \Delta^3$ is flag if and only if

$$H^{m-2}(\mathcal{Z}_P) \subset (\tilde{H}^*(\mathcal{Z}_P))^2.$$

Moreover, it turned out that there is another criterion when a 3-simple polytope is flag.

Proposition 2.2. *A simple 3-polytope with m faces is flag if and only if*

$$\text{rk } H^4(\mathcal{Z}_P) = \frac{(m-2)(m-4)(m-6)}{3}.$$

Proof. Indeed, [BP15, Theorem 4.6.2] states that for a simple n -polytope

$$(1-t^2)^{m-n}(h_0 + h_1 t^2 + \dots + h_n t^{2n}) = \sum_{-i, 2j} (-1)^i \beta^{-i, 2j} t^{2j},$$

where $h_0 + h_1 t + \dots + h_n t^n = (t-1)^n + f_{n-1}(t-1)^{n-1} + \dots + f_0$.

In particular, for 3-polytopes we have

$$(1 - t^2)^h(1 + ht^2 + ht^4 + t^6) = 1 - \beta^{-1,4}t^4 + \sum_{j=3}^h (-1)^{j-1}(\beta^{-(j-1),2j} - \beta^{-(j-2),2j})t^{2j} + (-1)^{h-1}\beta^{-(h-1),2(h+1)}t^{2(h+1)} + (-1)^ht^{2(h+3)},$$

where $h = m - 3$.

Then

$$(1 - ht^2 + \frac{h(h-1)}{2}t^4 - \frac{h(h-1)(h-2)}{6}t^6 + \dots)(1 + ht^2 + ht^4 + t^6) = 1 - \beta^{-1,4}t^4 + (\beta^{-2,6} - \beta^{-1,6})t^6 + \dots$$

For any simple 3-polytope P we have:

- $\text{rk } H^3(\mathcal{Z}_P) = \beta^{-1,4} = |N_2(P)| = \frac{h(h-1)}{2}$;
- $\beta^{-1,6}$ – the number of 3-belts;
- $\beta^{-2,6} - \beta^{-1,6} = \frac{(h^2-1)(h-3)}{3}$.

Then

$$\text{rk } H^4(\mathcal{Z}_P) = \beta^4 = \beta^{-2,6} = \beta^{-1,6} + \frac{(h^2-1)(h-3)}{3} = \text{the number of 3-belts} + \frac{(h^2-1)(h-3)}{3}$$

□

It is easy to see that a polytope has no 4-belts if and only if the multiplication

$$H^3(\mathcal{Z}_P) \otimes H^3(\mathcal{Z}_P) \rightarrow H^6(\mathcal{Z}_P)$$

is trivial. Thus, the property to be Pogorelov polytope is also B -rigid.

In [FW15] (details see also in [BE17S]) it was proved that any Pogorelov polytope is B -rigid.

The proof consisted of several steps. Denote

$$N_2(P) = \{\{i, j\} \subset [m]: F_i \cap F_j = \emptyset\}.$$

First it was proved that the set of elements

$$\{\pm\tilde{\omega}: \omega \in N_2(P)\} \subset H^3(\mathcal{Z}_P)$$

corresponding to sets $\omega \in N_2(P)$ is B -rigid in the class of Pogorelov polytopes. The proof was based on the so-called separable circuit condition (SCC): for any Pogorelov polytope P and any three different facets $\{F_i, F_j, F_k\}$ with $F_i \cap F_j = \emptyset$ there exist $l \geq 5$ and an l -belt \mathcal{B}_l such that $F_i, F_j \in \mathcal{B}_l, F_k \notin \mathcal{B}_l$, and F_k does not intersect at least one of the two connected components of $\mathcal{B}_l \setminus \{F_i, F_j\}$. In fact, this fact is characteristic for a polytope $P \neq \Delta^3$ to be Pogorelov. Indeed, if P has a 4-belt, then for the faces F_i and F_j lying in different connected components of the complement to this belt and F_k lying on the belt any k -belt containing F_i and F_j intersects F_k by both components. Later, in Lemma 3.17 we will prove an analog of SCC for almost Pogorelov polytopes.

Now let us give some details of the proof, which we will need in what follows.

Definition 2.3. An *annihilator* of an element r in a ring R is defined as

$$\text{Ann}_R(r) = \{s \in R: rs = 0\}$$

Since the group $H^*(\mathcal{Z}_P)$ has no torsion, we have the isomorphism $H^*(\mathcal{Z}_P, \mathbb{Q}) \simeq H^*(\mathcal{Z}_P) \otimes \mathbb{Q}$ and the embedding $H^*(\mathcal{Z}_P) \subset H^*(\mathcal{Z}_P) \otimes \mathbb{Q}$. For polytopes P and Q the isomorphism $H^*(\mathcal{Z}_P) \simeq H^*(\mathcal{Z}_Q)$ implies the isomorphism over \mathbb{Q} . For the cohomology over \mathbb{Q} all theorems about structure of $H^*(\mathcal{Z}_P, \mathbb{Q})$ are still valid.

It was proved that for a Pogorelov polytope P and an element α in $H = H^*(\mathcal{Z}_P, \mathbb{Q})$:

$$\alpha = \sum_{\omega \in N_2(P)} r_\omega \tilde{\omega} \quad \text{with } |\{\omega: r_\omega \neq 0\}| \geq 2$$

we have

$$\dim \text{Ann}_H(\alpha) < \dim \text{Ann}_H(\tilde{\omega}), \text{ if } r_\omega \neq 0.$$

Let us prove a stronger statement valid for all simple 3-polytopes.

Lemma 2.4. *Let P be a simple 3-polytope and $\alpha \in H$*

$$\alpha = \sum_{\omega \in N_2(P)} r_\omega \tilde{\omega} \quad \text{with } |\{\omega: r_\omega \neq 0\}| \geq 2.$$

Then for any $\omega = \{p, q\}$ with $r_\omega \neq 0$ we have

- (1) $\dim \text{Ann}_H(\alpha) \leq \dim \text{Ann}_H(\tilde{\omega})$;
- (2) $\dim \text{Ann}_H(\alpha) < \dim \text{Ann}_H(\tilde{\omega})$, if there is $\omega' = \{s, t\}$ with $r_{\omega'} \neq 0$ admitting an l -belt \mathcal{B}_l containing F_s and F_t such that either F_p or F_q does not belong to \mathcal{B}_l and does not intersect at least one of the two connected components of $\mathcal{B}_l \setminus \{F_s, F_t\}$.

Proof. Choose a complementary subspace C_ω to $\text{Ann}_H(\tilde{\omega})$ in H as a direct sum of complements $C_{\omega, \tau}$ to $\text{Ann}_H(\tilde{\omega}) \cap \widehat{H}_*(P_\tau, \partial P_\tau)$ in $\widehat{H}_*(P_\tau, \partial P_\tau)$ for all $\tau \subset [m] \setminus \omega$. Then for any $\beta \in C_\omega \setminus \{0\}$ we have $\beta \tilde{\omega} \neq 0$, which is equivalent to the fact that $\beta = \sum \beta_\tau$, $\beta_\tau \in C_{\omega, \tau}$, $\tau \subset [m] \setminus \omega$, with $\beta_{\tau_\beta} \tilde{\omega} \neq 0$ for some $\tau_\beta \subset [m] \setminus \omega$. Moreover for any $\omega' \neq \omega$ with $r_{\omega'} \neq 0$ and $\tau \subset [m] \setminus \omega$, $\tau \neq \tau_\beta$, we have $\tau_\beta \sqcup \omega \notin \{\tau \cup \omega', \tau_\beta \cup \omega', \tau \sqcup \omega\}$; hence $(\beta \cdot \alpha)_{\tau_\beta \sqcup \omega} = r_\omega \beta_{\tau_\beta} \cdot \tilde{\omega} \neq 0$, and $\beta \alpha \neq 0$. Then C_ω forms a direct sum with $\text{Ann}(\alpha)$, and $\dim \text{Ann}_H(\alpha) \leq \dim \text{Ann}_H(\tilde{\omega})$.

Now consider some $\omega' \neq \omega$, $|\omega'| = 2$, $r_{\omega'} \neq 0$, satisfying additional condition of the lemma say for F_q . Then there is an l -belt \mathcal{B}_l such that $F_s, F_t \in \mathcal{B}_l$, $F_q \notin \mathcal{B}_l$, and F_q does not intersect one of the two connected components B_1 and B_2 of $\mathcal{B}_l \setminus \{F_s, F_t\}$, say B_1 . Take $\xi = [\sum_{i: F_i \subset B_1} F_i] \in \widehat{H}_2(P_\tau, \partial P_\tau)$, $\tau = \{i: F_i \in \mathcal{B}_l \setminus \{F_s, F_t\}\}$, and $[F_s] \in \widehat{H}_2(P_{\omega'}, \partial P_{\omega'})$. Then $\xi \cdot [F_s]$ is a generator in $H_1(\mathcal{B}_l, \partial \mathcal{B}_l) \simeq \mathbb{Z}$. On the other hand, take $[F_q] \in \widehat{H}_2(P_\omega, \partial P_\omega)$. Then either $F_p \in \mathcal{B}_l \setminus \{F_s, F_t\}$, and $\xi \cdot \tilde{\omega} = 0$, since $\tau \cap \omega \neq \emptyset$, or $F_p \notin \mathcal{B}_l \setminus \{F_s, F_t\}$, and $\pm \xi \cdot \tilde{\omega} = \xi \cdot [F_q] = 0$, since F_q does not intersect B_1 . In both cases $\xi \in \text{Ann}(\tilde{\omega})$ and $\xi \cdot \tilde{\omega}' \neq 0$. Then $\xi \cdot \alpha \neq 0$, since $\tau \sqcup \omega' \neq \tau \sqcup \omega_1$ for $\omega_1 \neq \omega'$. Consider any $\beta = \sum_{\tau \subset [m] \setminus \omega} \beta_\tau \in C_\omega \setminus \{0\}$. We have $(\beta \cdot \alpha)_{\tau_\beta \sqcup \omega} \neq 0$. If $(\xi \cdot \alpha)_{\tau_\beta \sqcup \omega} \neq 0$, then since ξ is a homogeneous element, $(\xi \cdot \alpha)_{\tau_\beta \sqcup \omega} = r_{\omega_1} \xi \cdot \tilde{\omega}_1$ for $\omega_1 = (\tau_\beta \sqcup \omega) \setminus \tau = \{q, r\}$, $r \in [m]$. We have $\xi \cdot \tilde{\omega}_1 = \pm \xi \cdot [F_q] = 0$, since F_q does not intersect B_1 . A contradiction. Thus,

$((\xi + \beta) \cdot \alpha)_{\tau_\beta \perp \omega} = (\beta \cdot \alpha)_{\tau_\beta \perp \omega} \neq 0$; hence $(\xi + \beta) \cdot \alpha \neq 0$, and the space $\langle \xi \rangle \oplus C_\omega$ forms a direct sum with $\text{Ann}_H(\alpha)$. This finishes the proof. \square

Remark 2. In Proposition 4.3 we show that for the 3-dimensional associahedron, which is the simplest almost Pogorelov polytope without adjacent quadrangles, there is an example when $\dim \text{Ann}_H(\alpha) = \dim \text{Ann}_H(\tilde{\omega})$.

Corollary 2.5. *Let P be a simple 3-polytope, and $\omega \in N_2(P)$ such that*

$$\dim \text{Ann}_H(\alpha) < \dim \text{Ann}_H(\tilde{\omega})$$

for any $\alpha = \lambda_\omega \omega + \sum_{\omega' \in N_2(P) \setminus \{\omega\}} \lambda_{\omega'} \tilde{\omega}'$ with $\lambda_\omega \neq 0$ and $\lambda_{\omega'} \neq 0$ at least for one ω' , then for any isomorphism of graded rings $\varphi: H^*(\mathcal{Z}_P) \rightarrow H^*(\mathcal{Z}_Q)$ for a simple 3-polytope Q we have $\varphi(\tilde{\omega}) = \pm \tilde{\omega}'$ for some $\omega' \in N_2(Q)$.

Proof. Indeed, we have

$$\varphi(\tilde{\omega}) = \sum_{\omega'' \in N_2(Q)} \lambda_{\omega''} \tilde{\omega}''.$$

Then at least for one ω'' with $\lambda_{\omega''} \neq 0$ we have

$$\varphi^{-1}(\omega'') = \mu_\omega \tilde{\omega} + \sum_{\omega' \in N_2(P) \setminus \{\omega\}} \mu_{\omega'} \tilde{\omega}' \text{ with } \mu_\omega \neq 0.$$

If $\mu_{\omega'} \neq 0$, then by Lemma 2.4 we have in cohomology over \mathbb{Q} :

$$\dim \text{Ann}_{H(P)}(\tilde{\omega}) > \dim \text{Ann}_{H(P)}(\varphi^{-1}(\tilde{\omega}'')) = \dim \text{Ann}_{H(Q)}(\tilde{\omega}'') \geq \dim \text{Ann}_{H(Q)}(\varphi(\tilde{\omega})).$$

A contradiction. Hence $\mu_{\omega'} = 0$ for all ω' , and $\varphi(\tilde{\omega}) = \pm \tilde{\omega}''$. \square

Definition 2.6. Let P be a simple 3-polytope. We will call an element $\omega' = \{s, t\} \in N_2(P)$ *good* for an element $\omega = \{p, q\} \in N_2(P)$, if there is an l -belt \mathcal{B}_l containing F_s and F_t such that either F_p or F_q does not belong to \mathcal{B}_l and does not intersect at least one of the two connected components of $\mathcal{B}_l \setminus \{F_s, F_t\}$. Otherwise, we call ω' *bad* for ω .

Corollary 2.7. *Let P be a simple 3-polytope. If any $\omega' \in N_2(P) \setminus \{\omega\}$ is good for an element $\omega \in N_2(P)$, then for any isomorphism of graded rings $\varphi: H^*(\mathcal{Z}_P) \rightarrow H^*(\mathcal{Z}_Q)$ for a simple 3-polytope Q we have $\varphi(\tilde{\omega}) = \pm \tilde{\omega}'$ for some $\omega' \in N_2(Q)$.*

Corollary 2.8. *Let P be a simple 3-polytope and $\omega \in N_2(P)$. Then for any isomorphism of graded rings $\varphi: H^*(\mathcal{Z}_P) \rightarrow H^*(\mathcal{Z}_Q)$ for a simple 3-polytope Q we have $\varphi(\tilde{\omega}) = \sum_{\omega'' \in N_2(Q)} \lambda_{\omega''} \tilde{\omega}''$,*

where there is $\omega'' \in N_2(Q)$ such that $\lambda_{\omega''} \neq 0$ and all the other elements in $N_2(Q)$ with nonzero coefficients are bad for ω'' . Moreover, this is valid for any $\omega'' \in N_2(Q)$ such that $\lambda_{\omega''} \neq 0$ and $\varphi^{-1}(\tilde{\omega}'')$ has a nonzero coefficient at $\tilde{\omega}$.

Proof. Indeed, let

$$\varphi(\tilde{\omega}) = \sum_{\omega'' \in N_2(Q)} \lambda_{\omega''} \tilde{\omega}''.$$

Then at least for one ω'' with $\lambda_{\omega''} \neq 0$ we have

$$\varphi^{-1}(\omega'') = \mu_{\omega} \tilde{\omega} + \sum_{\omega' \in N_2(P) \setminus \{\omega\}} \mu_{\omega'} \tilde{\omega}' \text{ with } \mu_{\omega} \neq 0.$$

If $\lambda_{\omega_1''} \neq 0$, and ω_1'' is good for ω'' , then by Lemma 2.4 we have in cohomology over \mathbb{Q} :

$$\dim \text{Ann}_{H(P)}(\tilde{\omega}) \geq \dim \text{Ann}_{H(P)}(\varphi^{-1}(\tilde{\omega}'')) = \dim \text{Ann}_{H(Q)}(\tilde{\omega}'') > \dim \text{Ann}_{H(Q)}(\varphi(\tilde{\omega})).$$

A contradiction. Hence $\lambda_{\omega_1''} = 0$ for all elements $\omega_1'' \in N_2(Q)$, which are good for ω'' . Moreover, by a similar argument, $\mu_{\omega'} = 0$ for all elements, which are good for ω . \square

On the second it was proved that the set

$$\{\pm \tilde{\mathcal{B}}_k : \mathcal{B}_k - k\text{-belt}\} \subset H^{k+2}(\mathcal{Z}_P)$$

is B -rigid in the class of Pogorelov polytopes. Here \mathcal{B}_k is the element in $H^{k+2}(\mathcal{Z}_P)$ corresponding to the generator in $\tilde{H}^1(P_{\omega(\mathcal{B}_k)}) \simeq \mathbb{Z}$, where $\omega(\mathcal{B}_k) = \{i \in [m] : F_i \in \mathcal{B}_k\}$.

Also from the arguments in [FMW15] it follows (see the detailed proof in [BE17S]) that for any simple 3-polytope P the subgroup $\mathcal{B}_k \subset H^{k+2}(\mathcal{Z}_P)$, $4 \leq k \leq m-2$, generated by the elements $\{\tilde{\mathcal{B}}_k : \mathcal{B}_k - k\text{-belt}\}$ is B -rigid.

Then it was proved that the set of elements

$$\{\pm \tilde{\mathcal{B}}_k : \mathcal{B}_k - k\text{-belt around a face}\} \subset H^{k+2}(\mathcal{Z}_P)$$

is B -rigid in the class of Pogorelov polytopes.

This induces a bijection between the sets of faces of polytopes.

Then it was proved that if facets F_i and F_j are adjacent, then their images are also adjacent. This finishes the proof of B -rigidity of any Pogorelov polytope.

3. COHOMOLOGICAL RIGIDITY OF THE PROPERTY TO BE AN ALMOST POGORELOV POLYTOPE

Our aim is to prove that the property to be an almost Pogorelov polytope is B -rigid. We will follow the line introduced in previous section.

First the cube and the pentagonal prism are the only flag polytopes with $m = 6$ and $m = 7$ respectively. Hence, they are B -rigid.

Now consider all the other almost Pogorelov polytopes. They have no adjacent quadrangles, since a pair of adjacent quadrangles should be surrounded by a non-trivial 4-belt.

The image of the mapping $H^3(\mathcal{Z}_P) \otimes H^3(\mathcal{Z}_P) \rightarrow H^6(\mathcal{Z}_P)$ is the subgroup \mathcal{B}_4 generated by the elements $\tilde{\mathcal{B}}_4$ corresponding to 4-belts.

There is a B -rigid subgroup $A \subset H^3(\mathcal{Z}_P)$ of the form

$$A_3 = \{x \in H^3(\mathcal{Z}_P) : x \cdot y = 0 \text{ for all } y \in H^3(\mathcal{Z}_P)\}.$$

It is generated by elements $\tilde{\omega}$ such that the set $\omega \in N_2(P)$ does not belong to $\omega(\mathcal{B}_4)$ for any 4-belt \mathcal{B}_4 . Denote this set $N_2^0(P)$.

A_3 is a direct summand in $H^3(\mathcal{Z}_P)$, therefore the quotient group $\mathbf{H}_3 = H^3(\mathcal{Z}_P)/A_3$ is also a free abelian group. We have the mapping $\mathbf{H}_3 \otimes \mathbf{H}_3 \rightarrow H^6(\mathcal{Z}_P)$.

Since A_3 is a direct summand in $H^3(\mathcal{Z}_P)$, $\mathbf{H}_3 \otimes \mathbb{Q} \simeq H^3(\mathcal{Z}_P, \mathbb{Q})/(A_3 \otimes \mathbb{Q})$ and there is an embedding $\mathbf{H}_3 \subset \mathbf{H}_3 \otimes \mathbb{Q}$.

Lemma 3.1. *We have $2 \operatorname{rk} \mathbf{B}_4 \geq \operatorname{rk} \mathbf{H}_3$, and the equality holds if and only if each set $\omega \in N_2(P)$ can be included in at most one set $\omega(\mathcal{B}_4)$.*

Proof. Each element \tilde{B}_4 can be represented uniquely up to a change of order as a product of two elements $\tilde{\omega}_1 \cdot \tilde{\omega}_2$, $\omega_i \in N_2(P)$. On the other hand, an element $\tilde{\omega}$ can be a factor of several elements, corresponding to 4-belts, if the facets F_p, F_q can be included into several 4-belts, where $\omega = \{p, q\}$. Let us calculate the number of pairs (ω, \mathcal{B}_4) , where $\omega \in N_2(P)$ and $\omega \subset \omega(\mathcal{B}_4)$. On the one hand, it is equal to $2 \operatorname{rk} \mathbf{B}_4$, on the other hand, it is at least the number of elements in $N_2(P)$ that can be included into a 4-belt, and the equality holds if and only if each this element can be included in exactly one set $\omega(\mathcal{B}_4)$. \square

Lemma 3.2. *Let P be a flag 3-polytope. If $2 \operatorname{rk} \mathbf{B}_4 = \operatorname{rk} \mathbf{H}_3$, then P has no adjacent quadrangles.*

Proof. If P is the cube I^3 , then $\operatorname{rk} \mathbf{B}_4 = \operatorname{rk} \mathbf{H}_3 = 3$. Else if P has two adjacent quadrangles, then these quadrangles are surrounded by a 4-belt such that the two facets intersecting both these quadrangles are included into two 4-belts surrounding the quadrangles. \square

Lemma 3.3. *The set of subgroups $G(\mathcal{B}_4) \subset \mathbf{H}_3$ of rank 2 generated by elements $[\tilde{\omega}] = \tilde{\omega} + A_3$ and $[\tilde{\omega}'] = \tilde{\omega}' + A_3$, where $\omega \sqcup \omega' = \omega(\mathcal{B}_4)$ is B-rigid in the class of flag 3-polytopes with $2 \operatorname{rk} \mathbf{B}_4 = \operatorname{rk} \mathbf{H}_3$.*

Proof. The elements $\{[\tilde{\omega}]\}$, where $\omega \in N_2(P)$ are subsets of $\omega(\mathcal{B}_4)$ for 4-belts form a basis in \mathbf{H}_3 . Take an element

$$\alpha = \lambda_1[\tilde{\omega}_1] + \lambda'_1[\tilde{\omega}'_1] + \cdots + \lambda_k[\tilde{\omega}_k] + \lambda'_k[\tilde{\omega}'_k],$$

where $\mathcal{B}_{4,1}, \dots, \mathcal{B}_{4,k}$ are all 4-belts, and $\omega_i \sqcup \omega'_i = \omega(\mathcal{B}_{4,i})$. We have $[\tilde{\omega}_i] \cdot [\tilde{\omega}'_i] = \widetilde{\mathcal{B}_{4,i}}$.

As mentioned above we have an embedding $H^*(\mathcal{Z}_P) \subset H^*(\mathbb{Z}) \otimes \mathbb{Q} = H^*(\mathcal{Z}_P, \mathbb{Q})$. Images of these subgroups are 2-dimensional linear subspaces in $\mathbf{H}_3 \otimes \mathbb{Q}$. For the element $\alpha \in \mathbf{H}_3 \otimes \mathbb{Q}$ define a linear subspace

$$A(\alpha) = \{\beta \in \mathbf{H}_3 \otimes \mathbb{Q} : \alpha \cdot \beta = 0\}$$

We have

$$\beta = \mu_1[\tilde{\omega}_1] + \mu'_1[\tilde{\omega}'_1] + \cdots + \mu_k[\tilde{\omega}_k] + \mu'_k[\tilde{\omega}'_k],$$

and

$$\alpha \cdot \beta = \sum_{i=1}^k (\lambda_i \mu'_i - \lambda'_i \mu_i) \widetilde{\mathcal{B}_{4,i}}.$$

Thus, $\beta \in A(\alpha)$ if and only if $\lambda_i \mu'_i - \lambda'_i \mu_i = 0$ for all $i = 1, \dots, k$. Thus, $\dim A(\alpha) = \dim \mathbf{H}_3 \otimes \mathbb{Q} - l$, where l is the number of i with $(\lambda_i, \lambda'_i) \neq (0, 0)$. Thus, maximal dimension is for $\alpha \in \langle [\tilde{\omega}_i], [\tilde{\omega}'_i] \rangle$ for some i . Hence, the collection of these subspaces is B -rigid over \mathbb{Q} , and the collection of the corresponding subgroups is B -rigid. \square

Corollary 3.4. *The set of elements*

$$\{\pm \widetilde{\mathcal{B}}_4: \mathcal{B}_4 \text{ is a 4-belt}\} \subset H^6(\mathcal{Z}_P)$$

is B -rigid in the class of flag 3-polytopes with $2 \operatorname{rk} \mathbf{B}_4 = \operatorname{rk} \mathbf{H}_3$.

Proof. Indeed, $\widetilde{\mathcal{B}}_{4,i}$ is a generator of the image of the bilinear mapping

$$\langle [\tilde{\omega}_i], [\tilde{\omega}'_i] \rangle \times \langle [\tilde{\omega}_i], [\tilde{\omega}'_i] \rangle \rightarrow H^6(\mathcal{Z}_P).$$

\square

Lemma 3.5. *The set of elements:*

$$\{\pm[\tilde{\omega}]: \omega \in N_2(P), \omega \subset \omega(\mathcal{B}_4) \text{ for some 4-belt } \mathcal{B}_4\} \subset \mathbf{H}_3$$

is B -rigid in the class of flag 3-polytopes with $2 \operatorname{rk} \mathbf{B}_4 = \operatorname{rk} \mathbf{H}_3$.

Proof. Consider the 4-belt $\mathcal{B}_{4,i}$ corresponding to the pair $\omega_i, \omega'_i \in N_2(P)$. Let $\omega_i = \{p, q\}$, $\omega'_i = \{s, t\}$. Consider the belt \mathcal{B}_l around the face F_p . It contains both F_s and F_t . Let B_1 and B_2 be the connected components of $\mathcal{B}_l \setminus \{F_s, F_t\}$. They lie in different connected components of $\partial P \setminus \{\mathcal{B}_{4,i}\}$. Let F_q intersect some face $F_a \in B_1$ and some face $F_b \in B_2$. Then (F_p, F_a, F_q, F_b) is a 4-belt. It is different from $\mathcal{B}_{4,i}$ and contains F_p and F_q . A contradiction to Lemma 3.1.

Now let $\varphi: H^*(\mathcal{Z}_P) \rightarrow H^*(\mathcal{Z}_Q)$ be an isomorphism of graded rings for flag polytopes P and Q with $2 \operatorname{rk} \mathbf{B}_4 = \operatorname{rk} \mathbf{H}_3$. By Lemma 3.3

$$\varphi(\tilde{\omega}_i) = \lambda_j \tilde{\omega}_j + \lambda'_j \tilde{\omega}'_j + \sum_{\tilde{\omega} \in A_3(Q)} \mu_\omega \tilde{\omega}$$

for some $j \in \{1, \dots, k\}$. Since $\varphi^{-1}(A_3(Q)) \subset A_3(P)$, for at least one of the elements $\tilde{\omega}_j$ and $\tilde{\omega}'_j$ with nonzero coefficient, say for $\tilde{\omega}_j$, its preimage contains $\tilde{\omega}_i$ with a nonzero coefficient:

$$\varphi^{-1}(\tilde{\omega}_j) = \tau_i \tilde{\omega}_i + \tau'_i \tilde{\omega}'_i + \sum_{\tilde{\omega} \in A_3(P)} \eta_\omega \tilde{\omega}, \quad \tau_i \neq 0.$$

If $\tau'_i \neq 0$, then by Lemma 2.4 we have in cohomology over \mathbb{Q} :

$$\dim \operatorname{Ann}_{H(P)}(\tilde{\omega}_i) > \dim \operatorname{Ann}_{H(P)}(\varphi^{-1}(\tilde{\omega}_j)) = \dim \operatorname{Ann}_{H(Q)}(\tilde{\omega}_j) \geq \dim \operatorname{Ann}_{H(Q)}(\varphi(\tilde{\omega}_i)).$$

A contradiction. Hence $\tau'_i = 0$ and for the mapping $\hat{\varphi}: \mathbf{H}_3(P) \rightarrow \mathbf{H}_3(Q)$ we have: $\hat{\varphi}^{-1}([\tilde{\omega}_j]) = \tau_i [\tilde{\omega}_i]$. Then $\tau_i = \pm 1$ and $\hat{\varphi}([\tilde{\omega}_i]) = \pm [\tilde{\omega}_j]$. This finishes the proof. \square

Lemma 3.6. *Let P be a flag 3-polytope. If $\widehat{H}_1(P_\omega, \partial P_\omega) \neq 0$, then $|\omega| \geq 4$. Moreover, if $|\omega| = 4$, then $\omega = \omega(\mathcal{B}_4)$ for some 4-belt.*

If $2 \operatorname{rk} \mathbf{B}_4 = \operatorname{rk} \mathbf{H}_3$, and $|\omega| = 5$, then $\widehat{H}_1(P_\omega, \partial P_\omega) \neq 0$ if and only if P_ω has one of the 4 types drawn on Fig. 7.

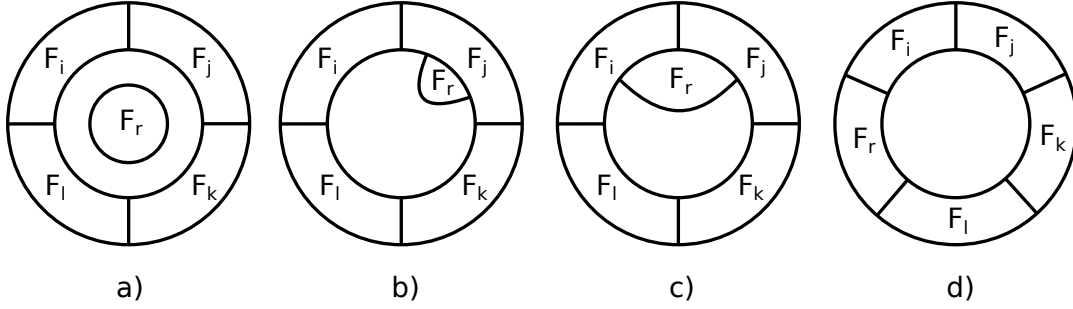

FIGURE 7. a) 4-belt (F_i, F_j, F_k, F_l) disjoint from F_r ; b) 4-belt (F_i, F_j, F_k, F_l) , and F_r intersects only F_j ; c) 4-belt (F_i, F_j, F_k, F_l) and F_r intersects only F_i and F_j ; d) 5-belt $(F_i, F_j, F_k, F_l, F_r)$.

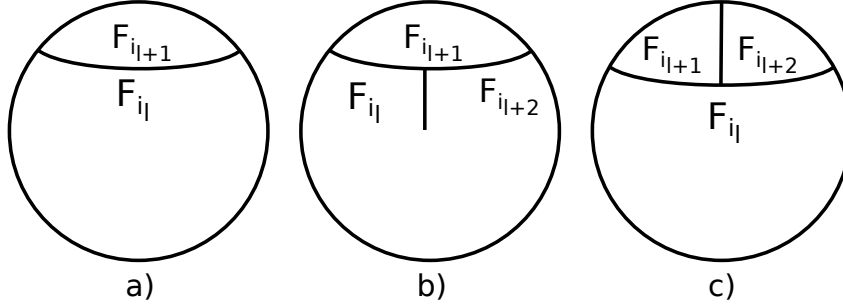

FIGURE 8. a) $F_{i_l} = F_{i_{l+2}}$; b) $F_{i_l} \cap F_{i_{l+2}}$ is an edge, c) $F_{i_l} = F_{i_{l+3}}$

Proof. As we mentioned above, P_ω is a disjoint union of spheres with holes. If $\widehat{H}_1(P_\omega, \partial P_\omega) \neq 0$, then one sphere $P_{\omega'}$, $\omega' \subset \omega$, has at least two holes. This is impossible for $|\omega'| = 1$ or 2 . Hence, $|\omega'| \geq 3$. Consider the boundary component γ of $P_{\omega'}$. Walking along this simple (that is passing through each vertex at most one time) edge-cycle we obtain a cyclic sequence of faces $\mathcal{L} = (F_{i_1}, \dots, F_{i_p})$, where the index i_l lies in $\mathbb{Z}_p = \mathbb{Z}/p\mathbb{Z}$. If $p = 1$, then $P_{\omega'}$ consists of one face and is contractible. If $p = 2$, then $P_{\omega'}$ consists of two adjacent faces and also is contractible. If $p = 3$, then F_{i_1} , F_{i_2} and F_{i_3} are different pairwise adjacent faces. Since P has no 3-belts, they have a common vertex and $P_{\omega'}$ consists of these three faces and is contractible. Thus, $p \geq 4$.

We have $F_{i_l} \neq F_{i_{l+1}}$ for any l . If $F_{i_l} = F_{i_{l+2}}$ for some l , then we have the configuration on Fig. 8a), and $P_{\omega'}$ is homeomorphic to $P_{\omega' \setminus \{i_{l+1}\}}$. If $F_{i_l} \cap F_{i_{l+1}}$ is an edge, then we have the configuration on Fig. 8b), and $P_{\omega'}$ is homeomorphic to $P_{\omega' \setminus \{i_{l+1}\}}$. If $F_{i_l} = F_{i_{l+2}}$, then F_{i_l} , $F_{i_{l+1}}$, $F_{i_{l+2}}$ are three different pairwise adjacent faces. Since P has no 3-belts, the edge $F_{i_{l+1}} \cap F_{i_{l+2}}$ intersects F_{i_l} , and we have the configuration on Fig. 8c). In this case $P_{\omega'}$ is homeomorphic to $P_{\omega' \setminus \{i_{l+1}, i_{l+2}\}}$.

If $|\omega'| = 3$, then $F_{i_l} \neq F_{i_{l+1}}$, $F_{i_l} \neq F_{i_{l+2}}$, $F_{i_l} \neq F_{i_{l+3}}$ for all l by the previous argument. A contradiction. Hence, $|\omega| \geq |\omega'| \geq 4$.

If $|\omega'| = 4$, then $F_{i_l} \neq F_{i_{l+1}}$, $F_{i_l} \neq F_{i_{l+2}}$, $F_{i_l} \cap F_{i_{l+2}} = \emptyset$, $F_{i_l} \neq F_{i_{l+3}}$ for all l by the previous argument. If $p = 4$, then \mathcal{L} is a 4-belt and $\omega = \omega' = \omega(\mathcal{L})$. Let $p \geq 5$. Then $F_{i_1} = F_{i_5} \neq F_{i_6}$, in particular, $p \geq 6$. But F_{i_6} is separated from $F_{i_2}, F_{i_3}, F_{i_4}$ by the face F_{i_1} , which is a contradiction. Thus, $p = 4$.

Let $|\omega| = 5$ and $2 \operatorname{rk} \mathbf{B}_4 = \operatorname{rk} \mathbf{H}_3$. If $\omega' \neq \omega$, then $\omega' = \omega(\mathcal{B}_4)$ for some 4-belt, and P_ω has the structure drawn on Fig. 7a). Now let $\omega' = \omega$. If $F_{i_l} = F_{i_{l+2}}$ for some l , then by the previous argument P_ω has the structure drawn on Fig. 7b). If $F_{i_l} \cap F_{i_{l+2}}$ is an edge for some l , then P_ω has the structure drawn on Fig. 7c). If $F_{i_l} = F_{i_{l+3}}$, then P_ω is contractible, which is a contradiction. Now assume that $F_{i_l} \neq F_{i_{l+1}}$, $F_{i_l} \neq F_{i_{l+2}}$, $F_{i_l} \cap F_{i_{l+2}} = \emptyset$, $F_{i_l} \neq F_{i_{l+3}}$ for all l . If $F_{i_l} \cap F_{i_{l+3}}$ is an edge for some l , then $\mathcal{B}_4 = (F_{i_l}, F_{i_{l+1}}, F_{i_{l+2}}, F_{i_{l+3}})$ is a 4-belt. Let $i = \omega \setminus \{i_l, i_{l+1}, i_{l+2}, i_{l+3}\}$. The face F_i lies in one of the connected components of the complement to this belt in ∂P . If F_i intersects two opposite faces of the belt, say F_{i_l} and $F_{i_{l+2}}$, then it should also intersect $F_{i_{l+1}}$ and $F_{i_{l+3}}$ for otherwise the pair $\{F_{i_l}, F_{i_{l+2}}\}$ can be included into two 4-belts, which contradicts the condition $2 \operatorname{rk} \mathbf{B}_4 = \operatorname{rk} \mathbf{H}_3$. Since P is flag, this means, that \mathcal{B}_4 is a belt around F_i and P_ω is contractible. Thus, F_i intersects at most two faces and they should be successive in the belt. We obtain the cases b) and c) of Fig. 7 again. Now consider the case when $F_{i_l} \cap F_{i_{l+3}} = \emptyset$ for all l . Then $p \geq 5$, $F_{i_l} \neq F_{i_{l+4}}$ and $\omega = \{i_l, i_{l+1}, i_{l+2}, i_{l+3}, i_{l+4}\}$ for any l . If $p = 5$, then \mathcal{L} is a 5-belt (Fig. 7d). Else $F_{i_l} = F_{i_{l+5}}$, in particular, $p \geq 7$. Then $F_{i_{l+6}}$ is separated from $F_{i_{l+1}}, F_{i_{l+2}}, F_{i_{l+3}}, F_{i_{l+4}}$ by F_{i_l} , which is a contradiction. Thus, $p = 5$. Now we considered all the possible cases and the proof is finished. \square

Corollary 3.7. *Let P be a flag 3-polytope with $2 \operatorname{rk} \mathbf{B}_4 = \operatorname{rk} \mathbf{H}_3$. Then the image I_7 of the mapping*

$$H^3(\mathcal{Z}_P) \otimes H^4(\mathcal{Z}_P) \rightarrow H^7(\mathcal{Z}_P)$$

is a free abelian group with the basis corresponding to element $\widetilde{\mathcal{B}}_5$, where \mathcal{B} is a 5-belt, and generators of the groups $\widehat{H}_1(P_\omega, \partial P_\omega) \simeq \mathbb{Z}$ for P_ω drawn on Fig. 7 a)-c).

Lemma 3.8. *Let P be a flag 3-polytope. Then for $k \geq 5$ any its k -belt \mathcal{B} different from the belt surrounding the base of a k -gonal prism, contains a pair of non-adjacent faces that can not be included to any 4-belt.*

Proof. Let $\mathcal{B} = (F_{i_1}, F_{i_2}, \dots, F_{i_k})$ and C_1 and C_2 be components of its complement in ∂P . Let any pair of non-successive faces of \mathcal{B} can be included into a 4-belt. Then there is a 4-belt $(F_{i_1}, F_{p_1}, F_{i_3}, F_{q_1})$. At least one of the faces F_{p_1} and F_{q_1} , say F_{p_1} is different from F_{i_2} , hence lies in $\overline{C_1}$ or $\overline{C_2}$, say $\overline{C_1}$. There is a 4-belt $(F_{i_2}, F_{p_2}, F_{i_4}, F_{q_2})$. As before F_{p_2} lies in $\overline{C_1}$ or $\overline{C_2}$. If F_{p_2} lies in $\overline{C_1}$, then $F_{p_1} = F_{p_2}$, since no other faces in $\overline{C_1}$ different from F_{p_1} can intersect both F_{i_2} and F_{i_4} (this follows from the Jordan curve theorem, since the set $F_{i_2} \cap \overline{C_1}$ lies inside the disk bounded by a simple piecewise linear curve lying inside $F_{i_1} \cup F_{i_2} \cup F_{i_3} \cup F_{p_1}$, and $F_{i_4} \cap \overline{C_1}$ lies outside this curve (see Fig. 9a)). Thus, F_{p_1} is adjacent to $F_{i_1}, F_{i_2}, F_{i_3}$, and F_{i_4} . Since P is flag, we obtain configuration drawn on Fig. 9b). Then $F_{q_1}, F_{q_2} \subset \overline{C_2}$. Thus, $F_{q_1} = F_{q_2}$ by the same argument, and we obtain the same picture as for F_{p_1} . There is a 4-belt $(F_{i_3}, F_{p_3}, F_{i_5}, F_{q_3})$. The face F_{i_3} intersects only faces $F_{i_2}, F_{i_4}, F_{p_1}$, and F_{q_1} . Since $F_{i_2} \cap F_{i_5} = \emptyset$, we have $\{F_{p_3}, F_{q_3}\} = \{F_{p_1}, F_{q_1}\}$, and we can assume that $F_{p_3} = F_{p_1}$, and $F_{q_3} = F_{q_1}$. Repeating this argument, we obtain that

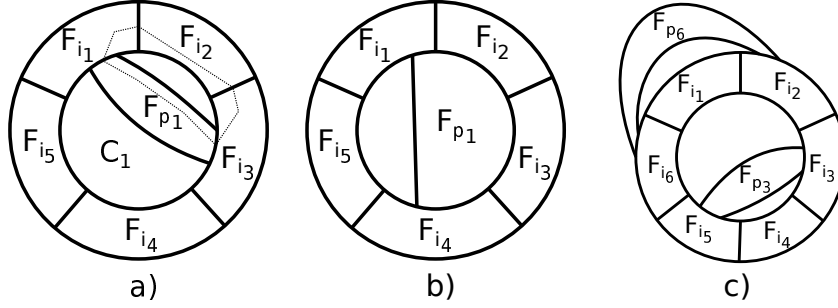

FIGURE 9. Configuration of faces near the belt

$F_{p_i} = F_{p_1}$, $F_{q_i} = F_{q_1}$ for all i , and \mathcal{B} is the belt around the base of a k -gonal prism, which is a contradiction.

Thus, $F_{p_2} \subset \overline{C_2}$, $F_{q_2} \subset F_{i_2} \cup \overline{C_2}$, and $F_{q_1} \subset F_{i_1} \cup \overline{C_1}$. Moreover, if $q_1 = F_{i_2}$, then $F_{p_1} \cap F_{i_2} = \emptyset$. Else $F_{p_1}, F_{q_1} \subset \overline{C_1}$, and at least one of these faces do not intersect F_{i_2} . Without loss of generality we can assume that $F_{p_1} \cap F_{i_2} = \emptyset$. Similarly $F_{p_2} \cap F_{i_3} = \emptyset$. Repeating the argument, we obtain $F_{p_3} \subset \overline{C_1}$, $F_{q_3} \subset F_{i_3} \cup \overline{C_1}$, $F_{p_3} \cap F_{i_4} = \emptyset$, and so on. If k is odd, then $F_{p_k} \subset \overline{C_1}$, $F_{q_k} \subset F_{i_k} \cup \overline{C_1}$, and $F_{p_1} \subset F_{i_1} \cup \overline{C_2}$, which is a contradiction. If k is even, then $k \geq 6$. Consider the 4-belt $(F_{i_1}, F_s, F_{i_4}, F_t)$. Both faces F_s and F_t do not belong to \mathcal{B} , since they intersect both F_{i_1} and F_{i_4} . But in $\overline{C_1}$ there are no faces intersecting both F_{i_1} and F_{i_4} , because $F_{p_3} \cap F_{i_4} = \emptyset$. Similarly in $\overline{C_2}$ there are no faces intersecting both F_{i_1} and F_{i_4} , because $F_{p_k} \cap F_{i_1} = \emptyset$. A contradiction. This finishes the proof. \square

Corollary 3.9. *Let P be a flag 3-polytope with $2 \text{rk } \mathbf{B}_4 = \text{rk } \mathbf{H}_3$. Then the image A_7 of the mapping*

$$A_3 \otimes H^4(\mathcal{Z}_P) \rightarrow H^7(\mathcal{Z}_P)$$

is a free abelian group \mathbf{B}_5 with the basis corresponding to element $\widetilde{\mathcal{B}}_5$, where \mathcal{B} is a 5-belt.

Proof. Indeed, Lemma 3.8 implies, that $\mathbf{B}_5 \subset A_7$. Let $x \in A_7$. Then

$$x = \left(\sum_{\omega \in N_2^0(P)} \lambda_\omega \widetilde{\omega} \right) \cdot \left(\sum_{\tau \subset [m]: |\tau|=3} y_\tau \right) = \sum_{\eta \subset [m]: |\eta|=5} z_\eta,$$

where y_τ corresponds to an element in $\widehat{H}_2(P_\tau, \partial P_\tau) \neq 0$, and z_η corresponds to an element in $\widehat{H}_1(P_\eta, \partial P_\eta) \neq 0$ such that for some $\omega \in N_2^0(P)$ we have $\omega \subset \eta$ and $\widehat{H}_2(P_{\eta \setminus \omega}, \partial P_{\eta \setminus \omega}) \neq 0$. By Lemma 3.6 P_η should have structure drawn on Fig. 7a)-d). For cases a)-c) for any $\omega \in N_2^0(P)$, $\omega \subset \eta$ the set $P_{\eta \setminus \omega}$ is contractible. Thus, each η has the form $\omega(\mathcal{B}_5)$ for some 5-belt, and $z_\eta = \mu_\eta \widetilde{\mathcal{B}}_5$. Hence, $A_7 \subset \mathbf{B}_5$, and this finishes the proof. \square

Let \varkappa_0 be the number of trivial 4-belts, and \varkappa_1 be the number of non-trivial 4-belts, and $\mathbf{H}_7 = H^7(\mathcal{Z}_P)/A_7$.

Corollary 3.10. *Let P be a flag simple 3-polytope with $2 \operatorname{rk} \mathbf{B}_4 = \operatorname{rk} \mathbf{H}_3$. Then group \mathbf{H}_7 is a free abelian group of rank $(m-5)\varkappa_0 + (m-4)\varkappa_1 \geq (m-5)\operatorname{rk} \mathbf{B}_4$.*

Proof. For any 4-belt $\mathcal{B} = (F_i, F_j, F_k, F_l)$ and any face $F_r \notin \mathcal{B}_4$ if F_r intersects opposite faces of the belt, say F_i and F_k , then $F_r \cap F_j \neq \emptyset$, for otherwise (F_i, F_j, F_k, F_r) is a 4-belt, and $F_r \cap F_l \neq \emptyset$ for the same reason. Since P is flag, this implies that \mathcal{B} surrounds F_r . Otherwise F_r intersects at most two faces, and they should be subsequent. Then $\mathcal{B} \cup F_r$ has the form drawn on Fig. 7a)-c). For a trivial belt we have $m-5$ such faces F_r , and for a non-trivial belt we have $m-4$ such faces. This finishes the proof. \square

Theorem 3.11. *A simple 3-polytope P is an almost Pogorelov polytope different from the cube and the pentagonal prism if and only if*

$$\operatorname{rk} H^4(\mathcal{Z}_P) = \frac{(m-2)(m-4)(m-6)}{3}, 2 \operatorname{rk} \mathbf{B}_4 = \operatorname{rk} \mathbf{H}_3, \text{ and } \operatorname{rk} \mathbf{H}_7 = (m-5)\operatorname{rk} \mathbf{B}_4.$$

In particular, the property to be an almost Pogorelov polytope is B-rigid.

Proof. Corollary 3.10 implies that if the conditions of the theorem hold, then every 4-belt of P is trivial, hence P is an almost Pogorelov polytope. Lemma 3.2 implies that P has no adjacent quadrangles. Hence P is different from the pentagonal prism.

Now let P be an almost Pogorelov polytope different from the cube and the pentagonal prism. It has no adjacent quadrangles, for otherwise these quadrangles should be surrounded by a nontrivial 4-belt. Consider a pair of non-adjacent faces F_i and F_k that can be included into a 4-belt (F_i, F_j, F_k, F_l) . The belt surrounds some quadrangle F_r . Let F_i and F_k be included to the other 4-belt (F_i, F_p, F_k, F_q) . This belt surrounds some other quadrangle $F_t \neq F_r$. Then (F_i, F_r, F_k, F_t) is a 4-belt. It surrounds some quadrangle adjacent to both F_t and F_r . A contradiction. Thus, any pair of non-adjacent faces of P can be included in at most one 4-belt, and $2 \operatorname{rk} \mathbf{B}_4 = \operatorname{rk} \mathbf{H}_3$ by Lemma 3.1. Then $\operatorname{rk} \mathbf{H}_7 = (m-5)\operatorname{rk} \mathbf{B}_4$ by Corollary 3.10. This finishes the proof. \square

Corollary 3.12. *Any almost Pogorelov polytope with at most 11 facets is B-rigid.*

Proof. Indeed, as we mentioned above for $m=6$ the cube, and for $m=7$ the pentagonal prism is a unique flag 3-polytope. For $m=8$ there are no almost Pogorelov polytopes. For $m=9$ the associahedron As^3 is a unique almost Pogorelov polytope. For $m=10$ and 11 different almost Pogorelov polytopes have different number of quadrangles, which is equal to $\operatorname{rk} \mathbf{B}_4$. \square

Corollary 3.13. *A simple 3-polytope P is an ideal almost Pogorelov polytope if and only if*

$$\operatorname{rk} H^3(\mathcal{Z}_P) = \frac{(m-2)(m-4)(m-6)}{3}, 2 \operatorname{rk} \mathbf{B}_4 = \operatorname{rk} \mathbf{H}_3 = m-2, \text{ and } \operatorname{rk} \mathbf{H}_7 = \frac{(m-5)(m-2)}{2}.$$

In particular, the property to be an ideal almost Pogorelov polytope is B-rigid.

Proof. Indeed, due to Theorem 3.11 a flag simple 3-polytope P is an almost Pogorelov polytope different from the cube and the pentagonal prism if and only if $2 \operatorname{rk} \mathbf{B}_4 = \operatorname{rk} \mathbf{H}_3$ and $\operatorname{rk} \mathbf{H}_7 = (m-5)\operatorname{rk} \mathbf{B}_4$. It is an ideal almost Pogorelov polytope if and only if quadrangles (which are pairwise disjoint) cover all its vertices. This is equivalent to the fact that the number of vertices

f_0 is equal to $4p_4$, where $p_4 = \text{rk } \mathbf{B}_4$ is the number of quadrangles. Indeed, calculating the number of pairs (a quadrangle, its vertex), we obtain that it is equal to $4p_4$, since quadrangles of an almost Pogorelov polytope different from the cube and the pentagonal prism are disjoint. On the other hand, it is at most f_0 , since any vertex lies on at most one quadrangle. The equality holds if and only if any vertex belongs to some quadrangle. For a simple 3-polytope we have $f_0 = 2(m - 2)$. This finishes the proof. \square

Corollary 3.14. *The 3-dimensional permutohedron Pe^3 is B-rigid. Moreover, any ideal almost Pogorelov polytope with $m \leq 18$ is B-rigid.*

Proof. Indeed, Pe^3 is a unique ideal almost Pogorelov polytope with minimal number of quadrangles (equal to 6, equivalently, minimal number of faces $m = 14$). As we proved above for ideal almost Pogorelov polytopes $m = 2p_4 + 2$. For $m = 16$ and $m = 18$ there are unique ideal almost Pogorelov polytopes with m facets. First of the them corresponds to the 4-antiprism, and the second corresponds to a polytope obtained from it by an edge-twist. \square

Lemma 3.15. *The sets of elements:*

$$\{\pm[\tilde{\omega}]: \omega \in N_2(P), \omega \subset \omega(\mathcal{B}_4) \text{ for a trivial 4-belt } \mathcal{B}_4\} \subset \mathbf{H}_3$$

and

$$\{\pm\widetilde{\mathcal{B}}_4: \mathcal{B}_4 \text{ is a trivial 4-belt}\} \subset H^6(\mathcal{Z}_P)$$

are B-rigid in the class of flag 3-polytopes with $2 \text{rk } \mathbf{B}_4 = \text{rk } \mathbf{H}_3$.

Proof. Indeed, the set $\omega \in N_2(P) \setminus N_2^0(P)$ corresponds to a trivial 4-belt if and only if the free abelian subgroup $\mathbf{H}_3 \cdot [\tilde{\omega}] \subset \mathbf{H}_7$ has rank $(m - 5)$, and the element $\widetilde{\mathcal{B}}_4$ corresponds to a trivial belt if and only if it is divisible by such an element $[\tilde{\omega}] \in \mathbf{H}_3$. \square

Definition 3.16. A k -path, $k \geq 1$, (or a *thick path*) is a sequence $(F_{i_1}, \dots, F_{i_k})$ of faces such that subsequent faces are adjacent. A k -path is called *simple*, if all its faces are distinct. By definition a *length* of a k -path is equal to k . For any two faces in P there is a thick path connecting them. The shortest thick path between faces is simple.

A 1-loop is a face. By a k -loop, $k \geq 2$, we call a closed $(k + 1)$ -path $(F_{i_1}, \dots, F_{i_{k+1}}): F_{i_{k+1}} = F_{i_1}$. We denote the k -loop simply $(F_{i_1}, \dots, F_{i_k})$. A k -loop is called *simple*, if all its faces are distinct. For convenience we assume that the parameter j in the index i_j of a k -loop belongs to $\mathbb{Z}_k = \mathbb{Z}/k\mathbb{Z}$, that is $i_k = i_0, i_{k+1} = i_1$ and so on.

For a thick path, a k -loop or a k -belt \mathcal{L} denote by $|\mathcal{L}|$ the union of its faces.

Lemma 3.17. *Let P be an almost Pogorelov polytope. Then for three pairwise different facets $\{F_i, F_j, F_k\}$ such that $F_i \cap F_j = \emptyset$ there exists an l -belt ($l \geq 4$) \mathcal{B}_l such that $F_i, F_j \in \mathcal{B}_l, F_k \notin \mathcal{B}_l$, and F_k does not intersect at least one of the two connected components of $|\mathcal{B}_l| \setminus (F_i \cup F_j)$ if and only if F_k does not intersect quadrangles among the faces F_i and F_j .*

Proof. If F_i is a quadrangle adjacent to F_k , then any l -belt \mathcal{B}_l containing F_i and not containing F_k in the closure of each connected component $|\mathcal{B}_l| \setminus (F_i \cup F_j)$ contains a face from the 4-belt around F_i adjacent to F_k . Hence, F_k intersects both connected components.

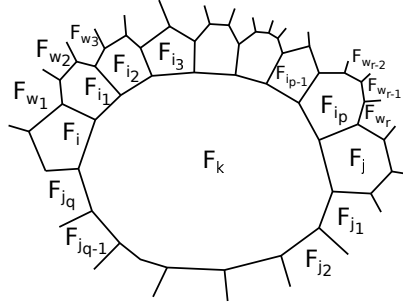

FIGURE 10. Case 1

Now let F_k do not intersect quadrangles among the faces F_i and F_j .

Since P is flag, there is an s -belt $\mathcal{B}_1 = (F_i, F_{i_1}, \dots, F_{i_p}, F_j, F_{j_1}, \dots, F_{j_q})$, with $F_k \notin \mathcal{B}_1$, $s = p + q + 2$, and $p, q \geq 1$. The complement $\partial P \setminus |\mathcal{B}_1|$ consists of two connected components C_1 and C_2 , both homeomorphic to disks. Without loss of generality assume that $F_k \subset \overline{C_1}$. Then either $\overline{C_1} = F_k$, or $\partial C_1 \cap F_k$ consists of finite set of disjoint edge-segments $\gamma_1, \dots, \gamma_d$.

In the first case \mathcal{B}_1 surrounds F_k , and F_i and F_j are adjacent to F_k . Consider all facets $\{F_{w_1}, \dots, F_{w_r}\}$ in $\overline{C_2}$ adjacent to facets in $\{F_{i_1}, \dots, F_{i_p}\}$ (see Fig. 10), in the order we meet them while walking round ∂C_2 from $\overline{C_2} \cap F_i$ to $\overline{C_2} \cap F_j$. Then $F_{w_a} \cap F_{j_b} = \emptyset$ for any a, b , for otherwise $(F_k, F_{j_b}, F_{w_a}, F_{i_c})$ is a 4-belt for any i_c with $F_{i_c} \cap F_{w_a} \neq \emptyset$, since $F_k \cap F_{w_a} = \emptyset$ and $F_{j_b} \cap F_{i_c} = \emptyset$. This belt should surround a quadrangle from \mathcal{B}_1 intersecting both F_{j_b} and F_{i_c} . This quadrangle can be only F_i or F_j , which is a contradiction. We have a thick path $(F_i, F_{w_1}, \dots, F_{w_r}, F_j)$. Consider the shortest thick path of the form $(F_i, F_{w_{s_1}}, \dots, F_{w_{s_t}}, F_j)$. If two facets of this path intersect, then they are successive, else there is a shorter thick path. Thus we have the belt $\mathcal{B}_l = (F_i, F_{w_{s_1}}, \dots, F_{w_{s_t}}, F_j, F_{j_1}, \dots, F_{j_q})$ with faces of the segment $(F_{w_{s_1}}, \dots, F_{w_{s_t}})$ not intersecting F_k .

In the second case we can assume that $F_i \cap F_k = \emptyset$ or $F_j \cap F_k = \emptyset$, say $F_i \cap F_k \neq \emptyset$, for otherwise we can take the belt \mathcal{B}'_1 around F_k . Let $\gamma_a = (F_k \cap F_{u_{a,1}}, \dots, F_k \cap F_{u_{a,l_a}})$. Denote by \mathcal{U}_a the thick path $(F_{u_{a,1}}, \dots, F_{u_{a,l_a}})$, and by \mathcal{S}_a the segment $(F_{s_{a,1}}, \dots, F_{s_{a,t_a}})$ of \mathcal{B}_1 between \mathcal{U}_a and \mathcal{U}_{a+1} . Then $\mathcal{B}_1 = (\mathcal{U}_1, \mathcal{S}_1, \mathcal{U}_2, \dots, \mathcal{U}_d, \mathcal{S}_d)$.

Consider the thick path $\Pi_a = (F_{w_{a,1}}, \dots, F_{w_{a,r_a}}) \subset \overline{C_2}$ arising while walking round ∂C_2 along edges $\partial C_2 \cap F_{u_{a,j}}$ (see Fig. 11). Then $\Pi_a \cap \Pi_b = \emptyset$ for $a \neq b$, else $(F_w, F_{u_{a,j_1}}, F_k, F_{u_{b,j_2}})$ is a 4-belt for any $F_w \in \Pi_a \cap \Pi_b$ such that $F_w \cap F_{u_{a,j_1}} \neq \emptyset$, $F_w \cap F_{u_{b,j_2}} \neq \emptyset$. This belt surrounds a quadrangle F_x adjacent to F_k . If $F_x \subset \overline{C_1}$, then $F_x \cap F_w = \emptyset$, which is a contradiction. Otherwise, $F_x \in \mathcal{B}_1$, and the faces $F_{u_{a,j_1}}$ and $F_{u_{b,j_2}}$ are adjacent to it in the belt. Then $a = b$ (since P is flag), which is a contradiction. Also $F_{w_{a,j_1}} \neq F_{w_{a,j_2}}$ for $j_1 \neq j_2$. This is true for facets adjacent to the same facet $F_{u_{a,i}}$. Let $F_{w_{a,j_1}} = F_{w_{a,j_2}}$. If the facets are adjacent to the successive facets $F_{u_{a,i}}$ and $F_{u_{a,i+1}}$, then the flagness condition implies that $j_1 = j_2$ and $F_{w_{a,j_1}}$ is the facet in $\overline{C_2}$ intersecting $F_{u_{a,i}} \cap F_{u_{a,i+1}}$. If the facets are adjacent to non-successive facets $F_{u_{a,i}}$ and $F_{u_{a,j}}$, then $(F_{w_{a,j_1}}, F_{u_{a,i}}, F_k, F_{u_{a,j}})$ is a 4-belt around a quadrangle F_x . If $F_x \subset \overline{C_1}$, then

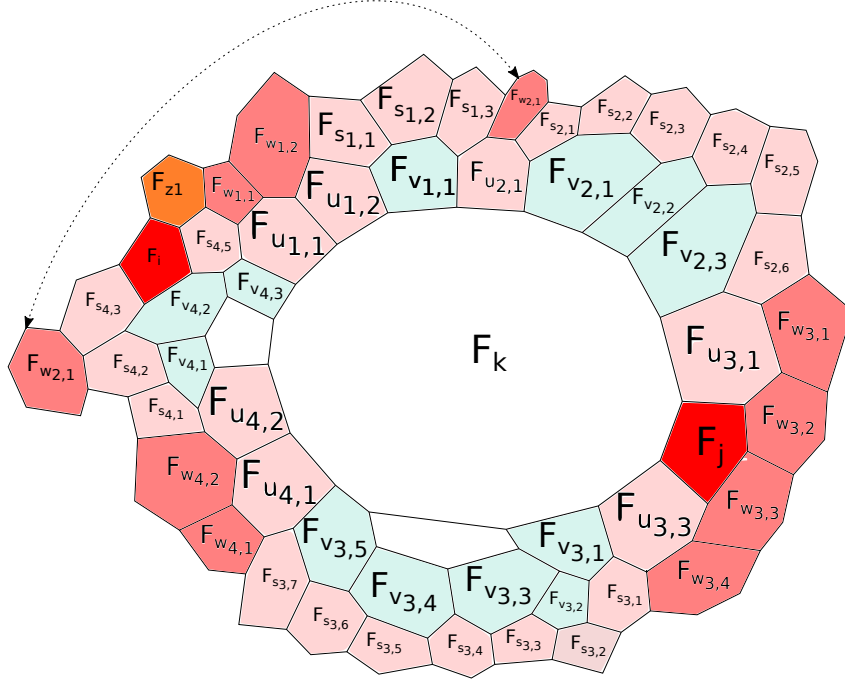

FIGURE 11. Case 2

$F_x \cap F_{w_{a,j_1}} = \emptyset$. Otherwise, $F_x \in \mathcal{B}_1$, and the faces $F_{u_{a,i}}$ and $F_{u_{a,j}}$ are adjacent to it in the belt. Without loss of generality we can assume that $F_x = F_{u_{a,i+1}}$, and $j = i + 2$. Then $j_1 = j_2$, and $F_{w_{a,j_1}}$ is a unique facet in $\overline{C_2}$ intersecting $F_{u_{a,i+1}}$. A contradiction.

Now consider the thick path $\mathcal{V}_b = (F_{v_{b,1}}, \dots, F_{v_{b,c_b}})$ arising while walking round ∂C_1 along edges $\partial C_1 \cap F_{s_{b,j}}$ (see Fig. 11). Then $|\mathcal{V}_a| \cap |\mathcal{V}_b| = \emptyset$ for $a \neq b$, and $|\Pi_a| \cap |\mathcal{V}_b| = \emptyset$ for any a, b , since interiors of the corresponding facets lie in different connected components of $\partial P \setminus (|\mathcal{B}_1| \cup F_k)$.

Now we will deform the segments $\mathcal{I} = (F_{i_1}, \dots, F_{i_p})$ and $\mathcal{J} = (F_{j_1}, \dots, F_{j_q})$ of the belt \mathcal{B}_1 to obtain a new belt $(F_i, \mathcal{I}', F_j, \mathcal{J}')$ with \mathcal{I}' not intersecting F_k . First substitute the thick path Π_a for each segment $\mathcal{U}_a \subset \mathcal{I}$ and the thick path \mathcal{V}_b for each segment $\mathcal{S}_b \subset \mathcal{J}$. Since $F_{s_{a,t_a}} \cap F_{w_{a+1,1}} \neq \emptyset$, $F_{w_{a,r_a}} \cap F_{s_{a,1}} \neq \emptyset$, $F_{v_{a,c_a}} \cap F_{u_{a+1,1}} \neq \emptyset$, and $F_{u_{a,l_a}} \cap F_{s_{a,1}} \neq \emptyset$ for any a and $a + 1$ considered mod d , we obtain a loop $\mathcal{L}_1 = (F_i, \mathcal{I}_1, F_j, \mathcal{J}_1)$ instead of \mathcal{B}_1 .

Since $F_i \cap F_k = \emptyset$, we have $F_i = F_{s_{a_i, f_i}}$ for some a_i, f_i . If $F_j = F_{s_{a_j, f_j}}$ for some a_j, f_j , then we can assume that $a_i \neq a_j$, else the facets in \mathcal{I} or \mathcal{J} already do not intersect F_k , and \mathcal{B}_1 is the belt we need. If $F_j = F_{u_{a_j, f_j}}$ for some a_j and some $f_j > 1$, then substitute the thick path $(F_{w_{a_j,1}}, \dots, F_{w_{a_j, g_j}})$, where g_j – the first integer with $F_{w_{a_j, g_j}} \cap F_j \neq \emptyset$ (then $F_j \cap F_{u_{a_j, f_j-1}} \cap F_{w_{a_j, g_j}}$ is a vertex), for the segment $(F_{u_{a_j,1}}, \dots, F_{u_{a_j, f_j-1}})$ to obtain a loop $\mathcal{L}_2 = (F_i, \mathcal{I}_2, F_j, \mathcal{J}_1)$ (else set $\mathcal{I}_2 = \mathcal{I}_1$ and $\mathcal{L}_2 = \mathcal{L}_1$) with facets in \mathcal{I}_2 not intersecting F_k . If $1 < f_j < l_{a_j}$, then $F_{w_{a_j, g_j}} \cap$

$F_{u_{a_j, f_j+1}} = \emptyset$, for otherwise $(F_k, F_{u_{a_j, f_j-1}}, F_{w_{a_j, g_j}}, F_{u_{a_j, f_j+1}})$ is a 4-belt around the quadrangle F_j . Then $F_{w_{a, l}} \cap F_{u_{a_j, r}} = \emptyset$ for any $r \in \{f_j + 1, \dots, l_{a_j}\}$ and a, l , such that either $a \neq a_j$, or $a = a_j$, and $l \in \{1, \dots, g_j\}$. Hence facets of the segment $(F_{u_{a_j, f_j+1}}, \dots, F_{u_{a_j, l_{a_j}}})$ do not intersect facets in \mathcal{I}_2 .

Now a facet $F_{i'_a}$ of \mathcal{I}_2 can intersect a facet $F_{j'_b}$ of \mathcal{J}_1 only if $F_{i'_a} = F_{w_{c, h}}$ for some c, h , and $F_{j'_b} = F_{s_{a_i, l}}$ for $l < f_i$, or $F_{j'_b} = F_{s_{a_j, l}}$ for $F_j = F_{s_{a_j, f_j}}$ and $l > f_j$. In the first case take the smallest l for all c, h , and the correspondent facet $F_{w_{c, h}}$. Consider the facet $F_{u_{b, g}} = F_{i_e} \in \mathcal{I}$ with $F_{u_{b, g}} \cap F_{w_{c, h}} \neq \emptyset$. Then $\mathcal{L}' = (F_{s_{a_i, l}}, F_{s_{a_i, l+1}}, \dots, F_i, F_{i_1}, \dots, F_{i_e}, F_{w_{c, h}})$ is a simple loop. If $f_i < t_{a_i}$, then consider the thick path $\mathcal{Z}_1 = (F_{z_{1,1}}, \dots, F_{z_{1, y_1}})$ arising while walking in $\overline{C_2}$ along ∂C_2 from the facet $F_{z_{1,1}}$ intersecting $F_i \cap F_{i_1}$ by the vertex, to the facet $F_{z_{1, y_1}}$ preceding $F_{w_{a_i+1, 1}}$. Consider the thick path $\mathcal{X}_1 = (F_{v_{a_i, 1}}, \dots, F_{v_{a_i, x_1}})$ with x_1 being the first integer with $F_{v_{a_i, x_1}} \cap F_i \neq \emptyset$. Consider the simple curve $\eta \subset \partial P$ consisting of segments connecting the midpoints of the successive edges of intersection of the successive facets of \mathcal{L}' . It divides ∂P into two connected components \mathcal{E}_1 and \mathcal{E}_2 with $\mathcal{J}_1 \setminus (F_{s_{a_i, l}}, \dots, F_{s_{a_i, f_i-1}})$ lying in one connected component, say \mathcal{E}_1 , and \mathcal{Z}_1 – in $\mathcal{E}_2 \cup F_{w_{c, h}}$. Now substitute \mathcal{X}_1 for the segment $(F_{s_{a_i, l}}, \dots, F_{s_{a_i, f_i-1}})$ of \mathcal{J}_1 . If $f_i < t_{a_i}$ substitute \mathcal{Z}_1 for the segment $(F_{s_{a_i, f_i+1}}, \dots, F_{s_{a_i, t_{a_i}}})$ of \mathcal{I}_2 to obtain a new loop $(F_i, \mathcal{I}_3, F_j, \mathcal{J}_2)$ with facets in \mathcal{I}_3 not intersecting F_k . A facet $F_{i''_a}$ in \mathcal{I}_3 can intersect a facet $F_{j''_b}$ in \mathcal{J}_2 only if $F_{i''_a} = F_{w_{c', h'}}$ for some c', h' , $F_j = F_{s_{a_j, f_j}}$, and $F_{j''_b} = F_{s_{a_j, l}}$ for $l > f_j$. The thick path \mathcal{Z}_1 lies in $\mathcal{E}_2 \cup F_{w_{c, h}}$ and the segment $(F_j = F_{s_{a_j, f_j}}, \dots, F_{s_{a_j, t_{a_j}}})$ lies in \mathcal{E}_1 ; hence intersections of facets in \mathcal{I}_3 with facets in \mathcal{J}_2 are also intersections of the same facets in \mathcal{I}_2 and \mathcal{J}_1 , and $F_{w_{c', h'}}$ is either $F_{w_{c, h}}$, or lies in \mathcal{E}_1 . We can apply the same argument for \mathcal{S}_{a_j} as for \mathcal{S}_{a_i} to obtain a new loop $\mathcal{L}_4 = (F_i, \mathcal{I}_4, F_j, \mathcal{J}_3)$ with facets in \mathcal{I}_4 not intersecting F_k and facets in \mathcal{J}_3 . Then take the shortest thick path from F_i to F_j in $F_i \cup \mathcal{I}_4 \cup F_j$ and the shortest thick path from F_j to F_i in $F_j \cup \mathcal{J}_3 \cup F_i$ to obtain the belt we need. \square

Corollary 3.18. *Let P be an almost Pogorelov polytope different from the cube and the pentagonal prism, and $\omega = \{p, q\} \in N_2(P)$. Then an element $\omega' = \{s, t\} \in N_2(P) \setminus \{\omega\}$ is bad for ω if and only if at least one of the faces F_s and F_t is a quadrangle, and either F_p and F_q are opposite faces of the 4-belt around this face, or exactly one of the faces F_p and F_q belongs to this belt, and the other face among F_s and F_t is either the other face among F_p and F_q , or is a quadrangle adjacent to it. In particular,*

- (1) *If F_p and F_q are not adjacent to quadrangles, then any element $\omega' \in N_2(P) \setminus \{\omega\}$ is good for ω . In particular, this is valid, if both F_p and F_q are quadrangles.*
- (2) *If F_p is a quadrangle and F_q is adjacent to quadrangles, then $\omega' \in N_2(P) \setminus \{\omega'\}$ is bad for ω if and only if $\omega' = \{p, r\}$, where F_r is a quadrangle adjacent to F_q .*
- (3) *If each of the faces F_p and F_q is adjacent to quadrangles, and F_p and F_q do not belong to any 4-belt, then $\omega' = \{s, t\} \in N_2(P) \setminus \{\omega\}$ is bad for ω if and only if either one of the faces F_s and F_t is F_p or F_q and the other face is a quadrangle adjacent to the other*

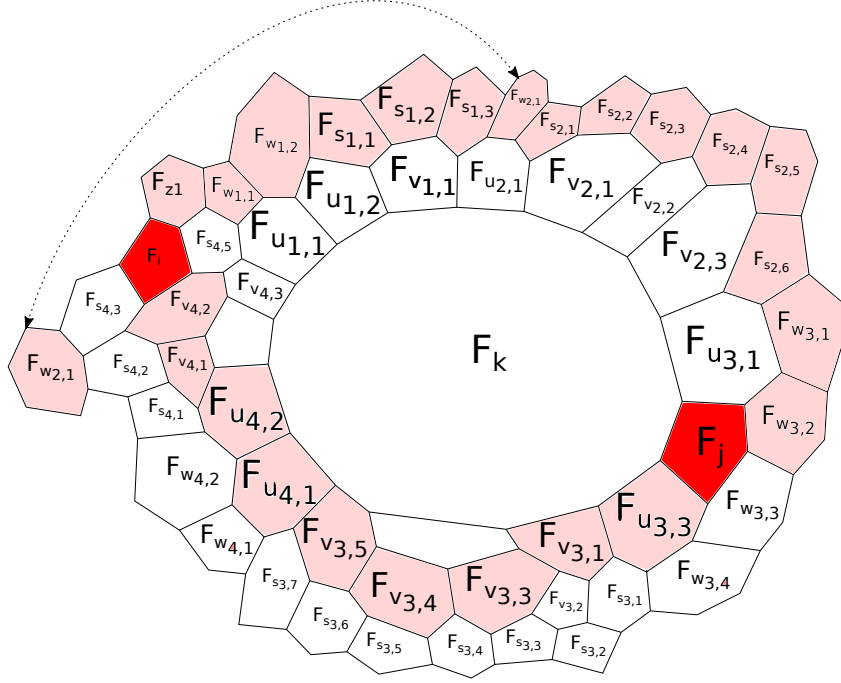

FIGURE 12. Modified belt

face, or both F_s and F_t are quadrangles, and one of them is adjacent to exactly F_p , and the other – to exactly F_q .

- (4) If the faces F_p and F_q belong to a 4-belt around the face F_r , then $\omega' = \{s, t\} \in N_2(P) \setminus \{\omega\}$ is bad for ω if and only if either $\omega' = \{r, s\}$, or one of the faces F_s and F_t is F_p or F_q and the other face is a quadrangle adjacent to the other face, or both F_s and F_t are quadrangles, and one of them is adjacent to exactly F_p , and the other – to exactly F_q .

Proof. Without loss of generality assume that $q \notin \omega'$. If ω' is bad for ω , then by Lemma 3.17 one of the faces F_s and F_t , say F_s , is a quadrangle adjacent to F_q . Then $F_p \neq F_s$. If $F_p \neq F_t$, then either F_p is adjacent to F_s , or F_t is a quadrangle adjacent to F_p .

On the other hand, let F_s be a quadrangle adjacent to F_q . Then $F_p \neq F_s$. If either $F_p = F_t$, or $F_p \neq F_t$ and F_p is adjacent to F_s , or F_t is a quadrangle adjacent to F_p , then ω' is bad for ω . \square

Corollary 3.19. *Let P be an almost Pogorelov polytope different from the cube and the pentagonal prism, and $\omega = \{p, q\} \in N_2(P)$ such that F_p and F_q are not adjacent to quadrangles. Then for any isomorphism of graded rings $\varphi: H^*(Z_P) \rightarrow H^*(Z_Q)$ for a simple 3-polytope Q we have $\varphi(\tilde{\omega}) = \pm \tilde{\omega}'$ for some $\omega' \in N_2(Q)$*

Proof. This follows directly from Corollary 2.7. \square

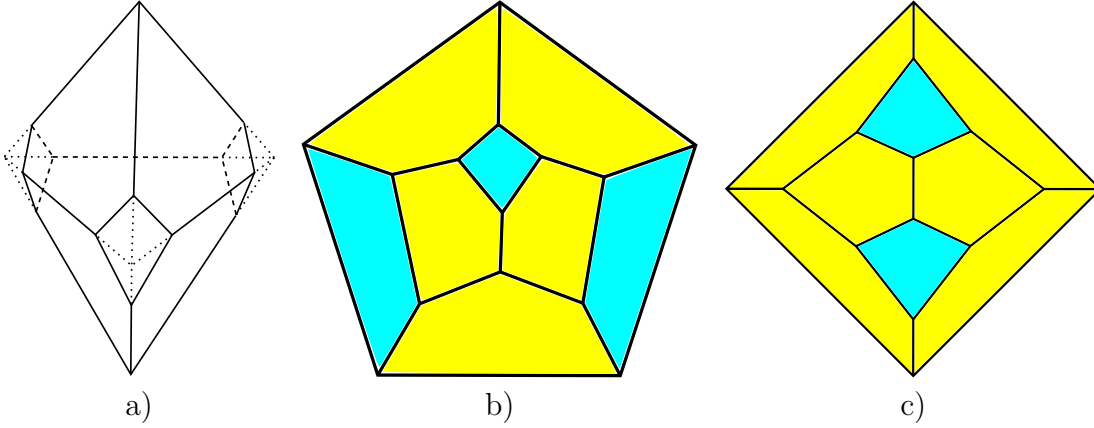

FIGURE 13. a) a 3-dimensional associahedron (Stasheff polytope) As^3 as a truncated bipyramid; b) its Schlegel diagram based at pentagon; c) its Schlegel diagram based at quadrangle

4. COHOMOLOGY RING OF THE MOMENT-ANGLE MANIFOLD OF THE THREE-DIMENSIONAL ASSOCIAHEDRON

For the associahedron As^3 we have the following picture. The group of symmetries of As^3 acts transitively on quadrangles (3 quadrangles), and pentagons (6 pentagons).

There are three equivalence classes of edges:

- (1) common edges of quadrangles and pentagon (12 edges);
- (2) common edges of pentagons connecting two vertices of quadrangles (3 edges);
- (3) common edges of pentagons containing common vertices of 3 pentagons (6 edges).

There are two equivalence classes of vertices:

- (1) vertices of quadrangles (12 vertices);
- (2) common vertices of 3 pentagons (2 vertices).

We have the following subsets P_ω of facets with $\tilde{H}^0(P_\omega) \neq 0$. The complementary subsets $P_{[m]\setminus\omega}$ are exactly subsets with $\tilde{H}^1(P_{[m]\setminus\omega}) \neq 0$. We have $|\omega| \geq 2$.

- (1) For $|\omega| = 2$ the sets $\omega = \{i, j\}$ correspond to pairs of non-adjacent facets F_i, F_j , $F_i \cap F_j = \emptyset$. We have 3 types of pairs encoded by numbers k_1, k_2 , of edges of facets: 4-4 (3 pairs, all equivalent); 4-5 (6 pairs, all equivalent); 5-5 (6 pairs, all equivalent); In total we have $\mathbb{Z}^{15} = H^3(\mathcal{Z}_P)$. By the Poincare duality $H^9(\mathcal{Z}_P) \simeq \mathbb{Z}^{15}$. The generators correspond to generators in $\tilde{H}^1(P_{[m]\setminus\omega})$ for the complementary subsets.
- (2) For $|\omega| = 3$ the sets $\omega = \{i, j, k\}$ correspond to either triples of disjoint facets or to pairs of disjoint sets: a facet and a pair of adjacent faces; For the first type we have only one set 4-4-4. This corresponds to $\mathbb{Z}^2 \subset H^4(\mathcal{Z}_P)$. For the second type we have cases: 4-45 (for each quadrangle 4 pairs 45, in total 12 pairs, all equivalent); 4-55 (for each quadrangle one pair, in total 3 pairs, all equivalent); 5-45 (for each pentagon two pairs,

in total 12 pairs, all equivalent); 5 – 55 (for each pentagon one pair, in total 6 pairs, all equivalent). This corresponds to $\mathbb{Z}^{33} \subset H^4(\mathcal{Z}_P)$. In total, since no two faces can give nonzero contribution to $H^4(\mathcal{Z}_P)$, we have $H^4(\mathcal{Z}_P) = \mathbb{Z}^2 \oplus \mathbb{Z}^{33} = \mathbb{Z}^{35}$. By the Poincare duality $H^8(\mathcal{Z}_P) \simeq \mathbb{Z}^2 \oplus \mathbb{Z}^{33} = \mathbb{Z}^{35}$. Here the summand \mathbb{Z}^2 corresponds to the complement to three disjoint quadrangles, which is a sphere with two holes. The generators in \mathbb{Z}^{33} correspond to generators in $\tilde{H}^1(P_{[m]\setminus\omega})$ for the complementary subsets.

- (3) Let $|\omega| = 4$. 4 can be expressed as a sum of positive integers in the following ways: $4 = 1 + 1 + 1 + 1$; $4 = 1 + 1 + 1 + 2$; $4 = 1 + 3$; $4 = 2 + 2$. First let us mention that if one of the connected components of P_ω consists of one facet, then either there are only two components, or there are three components each consisting of a single quadrangle. Thus, we can have only $1 + 3$ or $2 + 2$. For the first case we may have $4 - 445$ (two for each quadrangle, all equivalent, in total 6), $4 - 455$ (two for each quadrangle, all equivalent, in total 6), or $5 - 455$ (one for each pentagon, all equivalent, in total 6). For the second case we may have only $45 - 45$ (all equivalent, in total 6). Since P has no 3-belts, we have $H^5(\mathcal{Z}_P) \simeq \mathbb{Z}^{24}$. By the Poincare duality $H^7(\mathcal{Z}_P) \simeq \mathbb{Z}^{24}$. The generators correspond to generators in $\tilde{H}^1(P_{[m]\setminus\omega})$ for the complementary subsets.
- (4) For $\omega = 5$ we have $5 = 1 + 4 = 2 + 3$. For the first case we have $4 - 4455$ (one for each triangle, all equivalent, in total 3). The case $2 + 3$ is impossible, since for any pair of adjacent faces the set of faces not adjacent to both of them has cardinality at most 2. We have $\mathbb{Z}^3 \subset H^6(\mathcal{Z}_P)$. The complementary subsets are 4-belts and correspond to generators in $\tilde{H}^1(P_{[m]\setminus\omega})$, and we obtain a complementary summand $\mathbb{Z}^3 \subset H^6(\mathcal{Z}_P)$ such that $H^6(\mathcal{Z}_P) = \mathbb{Z}^3 \oplus \mathbb{Z}^3$.

We have the following table

TABLE 1. Additive structure of cohomology of \mathcal{Z}_P for $P = As^3$

k	0	1	2	3	4	5	6	7	8	9	10	11	12
$H^k(\mathcal{Z}_P)$	\mathbb{Z}	0	0	\mathbb{Z}^{15}	\mathbb{Z}^{35}	\mathbb{Z}^{24}	\mathbb{Z}^6	\mathbb{Z}^{24}	\mathbb{Z}^{35}	\mathbb{Z}^{15}	0	0	\mathbb{Z}

For each additive generator $\beta \in H^k(\mathcal{Z}_P)$ described on Fig. 15 (we call them *canonical generators*) we describe all the ways (up to a sign and a combinatorial symmetry) how its dual element $\beta^* \in H^{m+3-k}(\mathcal{Z}_P)$ can be decomposed in terms of the canonical generators. Also we denote the number of combinatorial symmetric decompositions.

On Fig. 16 we describe all the ways (with multiplicities arising from combinatorial symmetries) how the fundamental class can be decomposed as a product of the canonical generators.

Up to signs in the multiplication of generators this gives the full description of the ring $H^*(\mathcal{Z}_P, \mathbb{Z})$ for $P = As^3$.

For an element $\tilde{\omega}$, $\omega = \{F_p, F_q\}$, $F_p \cap F_q = \emptyset$, the complementary subspace in $H^*(\mathcal{Z}_P, \mathbb{Q})$ to $\text{Ann}_H(\tilde{\omega})$ is generated by the element $\tilde{\omega}^* \in H^m(\mathcal{Z}_P, \mathbb{Q})$ dual to $\tilde{\omega}$, and the canonical generators dividing $\tilde{\omega}^*$. In particular,

- (1) If F_p and F_q are both quadrangles, then $\text{codim Ann}_H(\tilde{\omega}) = 5$;

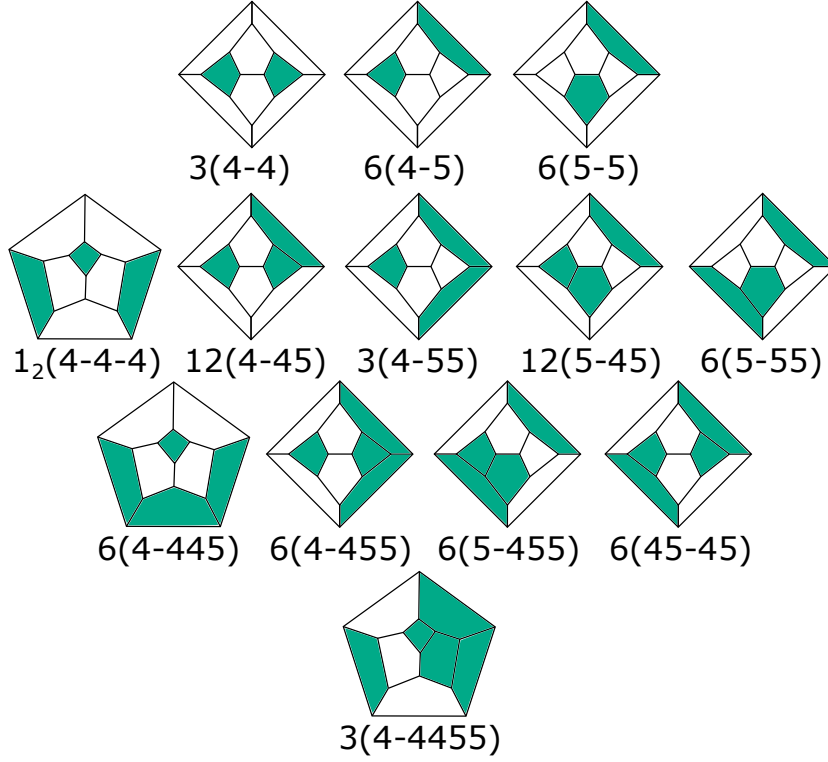
FIGURE 14. Collections P_ω giving classes in $\tilde{H}^0(P_\omega)$

- (2) If F_p is a quadrangle, and F_q is a pentagon, then $\text{codim Ann}_H(\tilde{\omega}) = 9$;
- (3) If F_p and F_q are both pentagons, then $\text{codim Ann}_H(\tilde{\omega}) = 21$.

Also

- (1) If F_p and F_q are both quadrangles, then any element $\omega' \in N_2(P) \setminus \{\omega\}$ is good for ω ;
- (2) If F_p is a quadrangle, and F_q is a pentagon, then an element $\omega' \in N_2(P) \setminus \{\omega\}$ is bad for ω if and only if $\omega' = \{p, r\}$, where F_r is a quadrangle adjacent to F_q . There are two such pairs;
- (3) If F_p and F_q are both pentagons, then they are both adjacent to a unique quadrangle F_r . Then an element $\omega' = \{s, t\} \in N_2(P) \setminus \{\omega\}$ is bad for ω if and only if either $\omega' = \{F_r, F_u\}$, where $F_u \cap F_r = \emptyset$, or $\omega' = \{p, v\}$, where $F_v \neq F_r$ is a quadrangle adjacent to F_q , or $\omega' = \{q, w\}$, where $F_w \neq F_r$ is a quadrangle adjacent to F_p , or $\omega' = \{v, w\}$. In general, there are 7 bad elements.

Corollary 4.1. *The set of elements $\{\pm\tilde{\omega}\}$ corresponding to pairs of quadrangles in As^3 is mapped to itself under each automorphism of a graded ring $H^*(\mathcal{Z}_P)$.*

Corollary 4.2. *Under each automorphism of a graded ring $H^*(\mathcal{Z}_P)$ for $P = As^3$ each element $\tilde{\omega}$, where $\omega = \{p, q\}$, F_p is a quadrangle, and F_q is a pentagon, is mapped to the element $\pm\tilde{\omega}' + \lambda_1\tilde{\omega}'_1 + \lambda_2\tilde{\omega}'_2$, where ω' has the same type as ω , and ω'_1, ω'_2 are bad for ω' .*

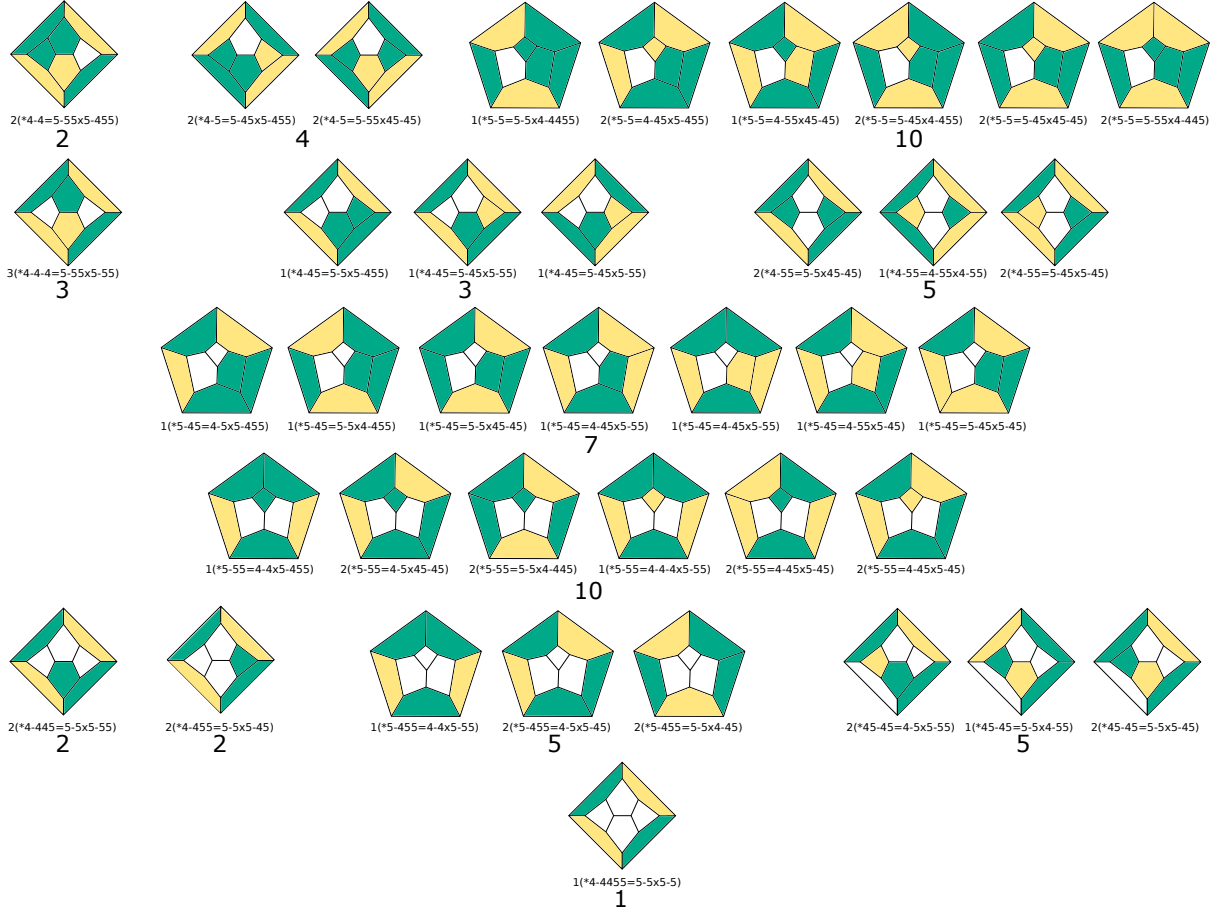

FIGURE 15. Decompositions of the dual elements

Proposition 4.3. *Let $\omega = \{p, q\}$, where F_p is a quadrangle, and F_q is a pentagon, and let F_u and F_v be quadrangles different from F_p . Then for $\omega_1 = \{q, u\}$, $\omega_2 = \{q, v\}$ and any λ_1, λ_2 we have*

$$\dim \text{Ann}_H(\tilde{\omega}) = \dim \text{Ann}_H(\tilde{\omega} + \lambda_1 \tilde{\omega}_1 + \lambda_2 \tilde{\omega}_2).$$

Proof. Denote $4-5 = \tilde{\omega}$, $4-4_1 = \tilde{\omega}_1$, $4-4_2 = \tilde{\omega}_2$, $\alpha = 4-5 + \lambda_1 4-4_1 + \lambda_2 4-4_2$. Then due to Fig. 15

- (1) $4-4_1^*$ is divided by $5-55_{11}$, $5-55_{12}$, $5-455_{11}$, and $5-455_{12}$. Moreover, choosing appropriate signs of generators, we can assume that

$$4-4_1^* = 5-55_{11} \cdot 5-455_{11} = 5-55_{12} \cdot 5-455_{12}.$$

- (2) $4-4_2^*$ is divided by $5-55_{21}$, $5-55_{22}$, $5-455_{21}$, and $5-455_{22}$. Here all the elements listed above are different. Moreover, we can assume that

$$4-4_2^* = 5-55_{21} \cdot 5-455_{21} = 5-55_{22} \cdot 5-455_{22}.$$

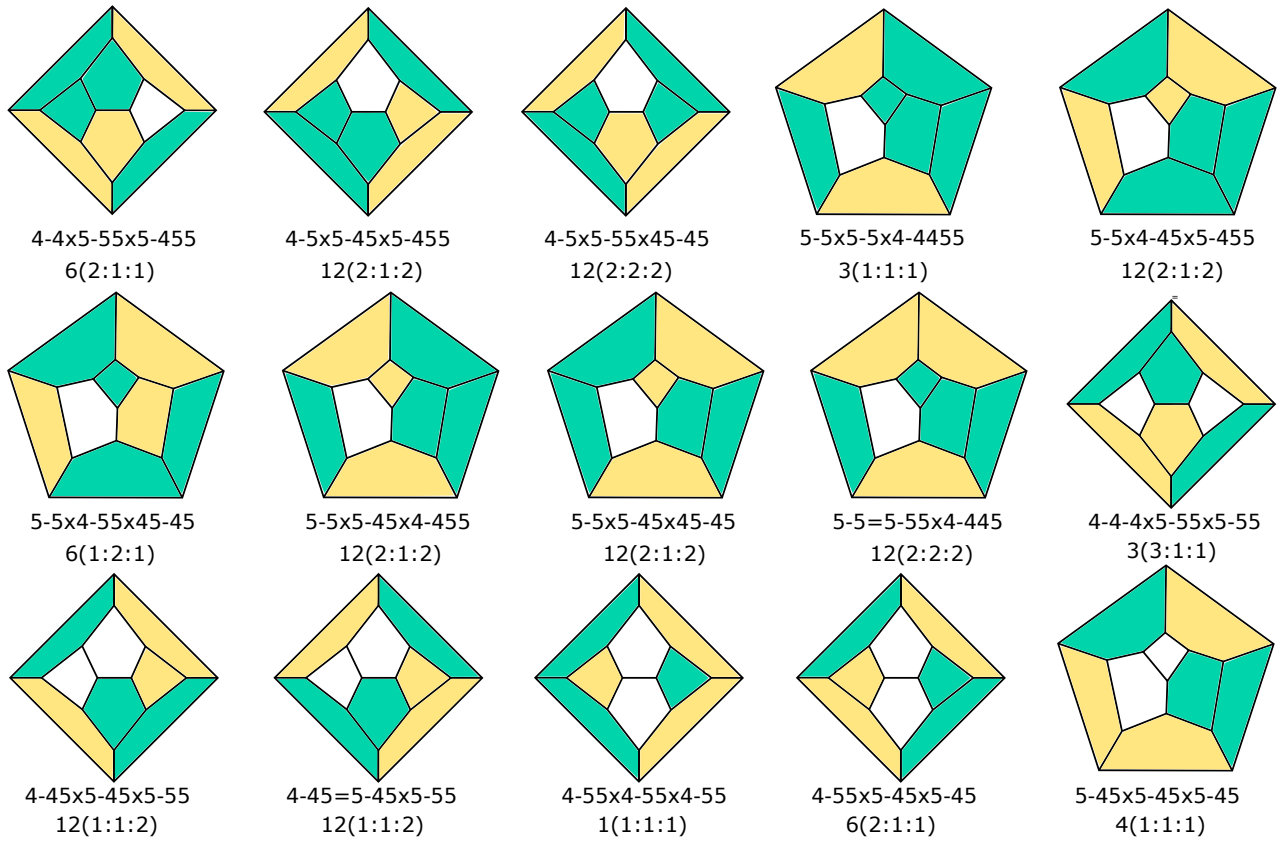

FIGURE 16. Decompositions of the dual elements

- (3) $4-5^*$ is divided by $5-45_1$, $5-45_2$, $5-455_{11}$, $5-455_{21}$, $5-55_{11}$, $5-55_{21}$, $45-45_1$ and $45-45_2$. Moreover, we can assume that

$$4-5^* = 5-45_1 \cdot 5-455_{11} = 5-45_2 \cdot 5-455_{21} = 5-55_{12} \cdot 45-45_1 = 5-55_{22} \cdot 45-45_2.$$

An element belongs to $\text{Ann}_H(\tilde{\omega})$ if and only if in its expression in terms of the canonical generators and dual elements coefficients at $4-5^*$ and $5-45_1$, $5-45_2$, $5-455_{11}$, $5-455_{21}$, $5-55_{11}$, $5-55_{21}$, $45-45_1$ and $45-45_2$ are zero.

Let $\beta = \sum_X (\beta(X)X + \gamma(X)X^*)$ be an expression of an element in $H^*(\mathcal{Z}_P, \mathbb{Q})$ in terms of canonical generators and dual elements. We have

$$\begin{aligned} \beta \cdot \alpha = & [\beta(4-5^*) + \beta(4-4_1^*)\lambda_1 + \beta(4-4_2^*)\lambda_2] [\mathcal{Z}_P] + \\ & + \beta(5-455_{11})\lambda_1 5-55_{11}^* + [\beta(5-455_{12})\lambda_1 + \beta(45-45_1)] 5-55_{12}^* + \\ & + [\beta(5-55_{11})\lambda_1 + \beta(5-45_1)] 5-455_{11}^* + \beta(5-55_{12})\lambda_1 5-455_{12}^* + \\ & + \beta(5-455_{21})\lambda_2 5-55_{21}^* + [\beta(5-455_{22})\lambda_2 + \beta(45-45_2)] 5-55_{22}^* + \\ & + [\beta(5-55_{21})\lambda_2 + \beta(5-45_2)] 5-455_{21}^* + \beta(5-55_{22})\lambda_2 5-455_{22}^* + \\ & + \beta(5-455_{11})5-45_1^* + \beta(5-455_{21})5-45_2^* + \beta(5-55_{12})45-45_1^* + \beta(5-55_{22})45-45_2^*, \end{aligned}$$

where $[\mathcal{Z}_P]$ is a fundamental class in cohomology. Thus, $\beta \cdot \alpha = 0$ if and only if

$$\begin{aligned} 0 = \beta(5-455_{11}) &= \beta(5-455_{21}) = \beta(5-55_{12}) = \beta(5-55_{22}) = \\ &= \lambda_1 \beta(5-55_{12}) = \lambda_1 \beta(5-455_{11}) = \lambda_2 \beta(5-55_{22}) = \lambda_2 \beta(5-455_{21}) = \\ &= \beta(5-455_{12})\lambda_1 + \beta(45-45_1) = \beta(5-55_{11})\lambda_1 + \beta(5-45_1) = \\ &= \beta(5-455_{22})\lambda_2 + \beta(45-45_2) = \beta(5-55_{21})\lambda_2 + \beta(5-45_2) = \\ &= \beta(4-5^*) + \beta(4-4_1^*)\lambda_1 + \beta(4-4_2^*)\lambda_2. \end{aligned}$$

This is equivalent to 9 linearly independent equations:

$$\begin{aligned} \beta(5-455_{11}) &= 0; & \beta(5-455_{21}) &= 0; & \beta(5-55_{12}) &= 0; & \beta(5-55_{22}) &= 0; \\ \beta(45-45_1) &= -\beta(5-455_{12})\lambda_1; & \beta(5-45_1) &= -\beta(5-55_{11})\lambda_1; \\ \beta(45-45_2) &= -\beta(5-455_{22})\lambda_2; & \beta(5-45_2) &= -\beta(5-55_{21})\lambda_2; \\ \beta(4-5^*) &+ \beta(4-4_1^*)\lambda_1 + \beta(4-4_2^*)\lambda_2 &= 0. \end{aligned}$$

Thus, $\text{codim Ann}_H(\alpha) = 9 = \text{codim Ann}_H(\tilde{\omega})$. □

5. REMARK

When the work on this paper was almost finished, we found a paper [FMW20], where it is announced without any details, that in the next paper [FMW20b] the authors will prove B -rigidity of any almost Pogorelov polytope and an analog of Theorem 0.2.

6. ACKNOWLEDGEMENTS

The author is grateful to Victor Buchstaber for his encouraging support and attention to this work. He is also grateful to the Fields Institute for Research in Mathematical Sciences (Canada) for providing excellent research conditions and support while working on this paper at the Thematic Program on Toric Topology and Polyhedral Products.

REFERENCES

- [A70a] E.M. Andreev, *On convex polyhedra in Lobachevskii spaces*, Math. USSR-Sb, 10:3 (1970), 413–440.
- [A70b] E.M. Andreev, *On convex polyhedra of finite volume in Lobachevskii space*, Math. USSR-Sb. 12:2 (1970), 255–259.
- [B74] D. Barnette, *On generation of planar graphs*, Discrete Mathematics. 7:(3-4) (1974) 199–208.
- [BGGMTW05] G. Brinkmann, S. Greenberg, C. Greenhill., B.D. McKay, R. Thomas, P. Wollan, *Generation of simple quadrangulations of the sphere*, Discrete Mathematics. 305 (2005), 33–54.
- [BE17S] V.M. Buchstaber, N.Yu. Erokhovets, *Fullerenes, Polytopes and Toric Topology*, In Volume 35 Combinatorial and Toric Homotopy: Introductory Lectures of Lect. Notes Ser. Inst. Math. Sci. Natl. Univ. Singap.; World Sci. Publ.: River Edge, NJ, USA, 2017; P. 67–178, arXiv: math.CO/160902949.
- [BE17I] V.M. Buchstaber, N.Yu. Erokhovets, *Construction of families of three-dimensional polytopes, characteristic patches of fullerenes and Pogorelov polytopes*, Izvestiya: Mathematics, **81**:5 (2017).
- [BEMPP17] V.M. Buchstaber, N.Yu. Erokhovets, M. Masuda, T.E. Panov, S. Park, *Cohomological rigidity of manifolds defined by right-angled 3-dimensional polytopes*, Russian Math. Surveys. 2017. V. 72, N. 2. P. 199–256. arXiv:1610.07575v3.
- [BP15] V.M. Buchstaber, T. E. Panov, *Toric topology*, Math. Surveys Monogr. V. 204, Amer. Math. Soc.: Providence, RI, USA, 2015.
- [DDS13] M. Deza, M. Dutour Sikirić, M.I. Shtogrin, *Fullerenes and disk-fullerenes*, Russian Math. Surveys, 68:4 (2013), 665–720.
- [FMW15] F. Fan, J. Ma, X. Wang, *B-Rigidity of flag 2-spheres without 4-belt*, arXiv:1511.03624.
- [FW15] F. Fan and X. Wang *On the cohomology of moment-angle complexes associated to Gorenstein* complexes*, Preprint (2015); arXiv:1508.00159v1.
- [FMW20] F. Fan, J. Ma, X. Wang, *Some rigidity problems in toric topology: I*, arXiv:2004.03362v2.
- [FMW20b] F. Fan, J. Ma, X. Wang, *Some rigidity problems in toric topology: II*, In preparation.
- [E18] N. Erokhovets, *Construction of Fullerenes and Pogorelov Polytopes with 5-, 6- and one 7-Gonal Face*, Symmetry. 2018. 10:3, 67.
- [E19] N.Yu. Erokhovets, *Three-dimensional right-angled polytopes of finite volume in the Lobachevsky space: combinatorics and constructions*, Proc. Steklov Inst. Math., **305** (2019), 78–134.
- [R96] I. Rivin, *A characterization of ideal polyhedra in hyperbolic 3-space*, Ann. of Math., Second Series, 143:1 (1996), 51–70.
- [P67] A.V. Pogorelov *A regular partition of Lobachevskian space*, Math. Notes. 1:1 (1967), 3–5.
- [T02] W.P. Thurston, *The geometry and topology of three-manifolds*, electronic version 1.1 of 2002. A version is currently available from the Mathematical Sciences Research Institute at the URL <http://www.msri.org/publications/books/gt3m/>.
- [V87] A.Yu. Vesnin, *Three-dimensional hyperbolic manifolds of Löbell type*, Siberian Mathematical Journal, 28:5 (1987), 731–734.
- [V17] A.Yu. Vesnin, *Right-angled polyhedra and hyperbolic 3-manifolds*, Russian Math. Surveys, 72:2 (2017), 335–374.

DEPARTMENT OF MECHANICS AND MATHEMATICS, MOSCOW STATE UNIVERSITY, 119992 MOSCOW, RUSSIA

E-mail address: erochovetsn@hotmail.com