

OPEN DIAGRAMS VIA COEND CALCULUS

MARIO ROMÁN

ABSTRACT. Morphisms in a monoidal category are usually interpreted as *processes*, and graphically depicted as square boxes. In practice, we are faced with the problem of interpreting what *non-square boxes* ought to represent in terms of the monoidal category and, more importantly, how should they be composed. Examples of this situation include *lenses* or *learners*. We propose a description of these non-square boxes, which we call *open diagrams*, using the monoidal bicategory of profunctors. A graphical coend calculus can then be used to reason about open diagrams and their compositions. This is work in progress.

1. INTRODUCTION

1.1. **Open Diagrams.** Morphisms in monoidal categories are interpreted as processes with inputs and outputs and generally represented by square boxes. This interpretation, however, raises the question of how to represent a process that does not consume all the inputs at the same time or a process that does not produce all the outputs at the same time. For instance, consider a process that consumes an input, produces an output, then consumes a second input and ends producing an output. Graphically, we have a clear idea of how this process should be represented, even if it is not a morphism in the category.

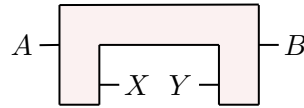

FIGURE 1. A process with a non-standard shape. The input A is taken at the beginning, then the output X is produced, strictly after that, the input Y is taken; finally, the output B is produced.

Reasoning graphically, it seems obvious, for instance, that we should be able to *plug* a morphism connecting the first output to the second input inside this process and get back an actual morphism of the category.

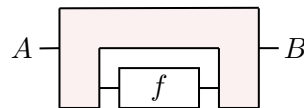

FIGURE 2. It is possible to plug a morphism $f: X \rightarrow Y$ inside the previous process (Figure 1), and, importantly, get back a morphism $A \rightarrow B$.

The particular shape depicted above has been extensively studied by [Ril18] under the name of (monoidal) *optic*; it can be also called a *monoidal lens*; and it has applications in bidirectional data accessing [PGW17, BG18, Kme18] or compositional game theory

[GHWZ18]. A multi-legged generalization has appeared also in quantum circuit design [CDP08] and quantum causality [KU17] as a notational convention, see [Rom20]. It can be shown that boxes of that particular shape should correspond to elements of a suitable *coend* (Figure 3, see also §1.2 and [Mil17, Ril18]). The intuition for this coend representation is that one should consider a tuple of morphisms and then quotient out by an equivalence relation generated by all the wires that are connected between these morphisms.

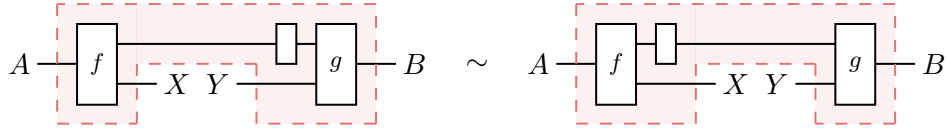

FIGURE 3. A box of this shape is meant to represent a pair of morphisms in a monoidal category quotiented out by "sliding a morphism" over the upper wire.

It has remained unclear, however, how this process should be carried in full generality and if it was in solid ground. Are we being formal when we use these *open* or *incomplete* diagrams? What happens with all the other possible shapes that one would want to consider in a monoidal category? In principle, they are not usual squares. For instance, the second of the shapes in Figure 4 has three inputs and two outputs, but the first input cannot affect the last output; and the last input cannot affect the first output.¹

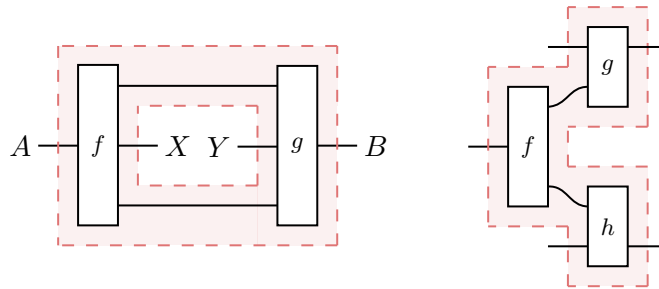

FIGURE 4. Some other shapes for boxes in a monoidal category.

This text presents the idea that incomplete diagrams should be interpreted as valid diagrams in the monoidal bicategory of profunctors; and that compositions of incomplete diagrams correspond to reductions that employ the monoidal bicategory structure. At the same time, this gives a graphical presentation of *coend calculus*.

1.2. Coend Calculus. Coends are particular cases of colimits and *coend calculus* is a practical formalism that uses Yoneda reductions to describe isomorphisms between them. Their dual counterparts are *ends*, and formalisms for both interact nicely in a *(Co)End calculus* [Lor19].

Definition 1.1. The **coend** $\int^{X \in \mathbf{C}} P(X, X)$ of a profunctor $P: \mathbf{C}^{op} \times \mathbf{C} \rightarrow \mathbf{Set}$ is the universal object endowed with dinatural morphisms

$$i_A: P(A, A) \rightarrow \int^{X \in \mathbf{C}} P(X, X).$$

In the sense that $i_B \circ P(f, \text{id}) = i_A \circ P(\text{id}, f)$ holds for every morphism $f: B \rightarrow A$ in \mathbf{C} . It is universal in the sense that any other object D endowed with dinatural morphisms $j_A: P(A, A) \rightarrow D$ factors uniquely through it.

¹This particular shape comes from a question by Nathaniel Virgo on categorytheory.zulipchat.com.

In other words, the coend is the coequalizer of the action of morphisms on both arguments of the profunctor. An element of the coend is an equivalence class of pairs $[X, x \in P(X, X)]$ quotiented by the equivalence relation generated by $[X, P(f, -)(u)] \sim [Y, P(-, f)(u)]$.

$$\int^{X \in \mathbf{C}} P(X, X) \cong \text{coeq} \left(\bigsqcup_{f: B \rightarrow A} P(A, B) \rightrightarrows \bigsqcup_{X \in \mathbf{C}} P(X, X) \right).$$

Our main idea is to use these dinaturality relations to deal with the quotienting arising in non-square monoidal boxes.

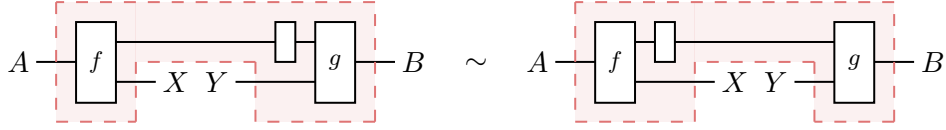

$$\int^M \mathbf{C}(A, M \otimes X) \times \mathbf{C}(M \otimes Y, B).$$

FIGURE 5. We can go back to the previous example (Figure 3) to check how it coincides with the quotienting arising from the dinaturality of a coend.

1.3. Contributions.

- A description of how to use the graphical calculus for monoidal bicategories (as in [Bar14]) to reason about *open diagrams* and *coend calculus*, paying special attention to how the monoidal structure of a category is represented with profunctors (§2 and §3.1). We show how some constructions in the literature provide examples of *open diagrams*: and how to these are optics (our main example), the Circ construction [KSW02] (§5.2) and *learners* [FJ19] (§5.3).
- A proposed formalization of the *internal diagrams* of [BDSPV15] and the *diagrams with holes* of [Ril18] in terms of *functor boxes* [Mel06]. We justify how these correspond to particular elements of sets described by coends (§4).
- A study of the multiple ways of composing monoidal lenses, and a recast of some coend calculus constructions on the literature on optics in terms of monoidal categories (§3.2). This serves as an application of the calculus.

2. THE MONOIDAL BICATEGORY OF PROFUNCTORS

Definition 2.1. There exists a symmetric monoidal bicategory \mathbf{Prof} having as objects the (small) categories $\mathbf{A}, \mathbf{B}, \mathbf{C}, \dots$; as 1-cells from \mathbf{A} to \mathbf{B} , the profunctors $\mathbf{A}^{op} \times \mathbf{B} \rightarrow \mathbf{Set}$; as 2-cells, the natural transformations; and as tensor product, the cartesian product of categories [Lor19]. Two profunctors $P: \mathbf{A}^{op} \times \mathbf{B} \rightarrow \mathbf{Set}$ and $Q: \mathbf{B}^{op} \times \mathbf{C} \rightarrow \mathbf{Set}$ compose into the profunctor $(P \diamond Q): \mathbf{A}^{op} \times \mathbf{C} \rightarrow \mathbf{Set}$ defined by

$$(P \diamond Q)(A, C) := \int^{B \in \mathbf{B}} P(A, B) \times Q(B, C).$$

The monoidal product of two profunctors $P_1: \mathbf{A}_1^{op} \times \mathbf{B}_1 \rightarrow \mathbf{Set}$ and $P_2: \mathbf{A}_2^{op} \times \mathbf{B}_2 \rightarrow \mathbf{Set}$ is the profunctor $(P_1 \otimes P_2): (\mathbf{A}_1 \times \mathbf{A}_2)^{op} \times (\mathbf{B}_1 \times \mathbf{B}_2) \rightarrow \mathbf{Set}$ defined by

$$(P_1 \otimes P_2)(A_1, A_2, B_1, B_2) := P_1(A_1, B_1) \times P_2(A_2, B_2).$$

The string diagrammatic calculus for monoidal bicategories has been studied by Bartlett [Bar14] expanding on a strictification result by Schommer-Pries [SP11]. It is similar to the

graphical calculus of monoidal categories with the caveat that deformations correspond to invertible 2-cells instead of equalities (see §9.2 for the full three-dimensional version). For instance, arrows between diagrams on this text will denote natural transformations, which are 2-cells of the bicategorical structure of profunctors.

Remark 2.2. Scalars in these diagrams, that is, profunctors having the unit as domain and codomain, are sets. We will be defining sets by using string diagrams during the rest of the text.

Definition 2.3 (Yoneda embedding of functors). Let $F: \mathbf{C} \rightarrow \mathbf{D}$ be a functor. It can be embedded as a profunctor $(\lrcorner F \rhd): \mathbf{C}^{op} \times \mathbf{D} \rightarrow \mathbf{Set}$ or as a profunctor $(\lrcorner F \rhd): \mathbf{D}^{op} \times \mathbf{C} \rightarrow \mathbf{Set}$. Moreover, every functor has an opposite, so it can also be embedded as a profunctor $(\lrcorner F \rhd): (\mathbf{D}^{op})^{op} \times \mathbf{C}^{op} \rightarrow \mathbf{Set}$ or as a profunctor $(\lrcorner F \rhd): (\mathbf{C}^{op})^{op} \times \mathbf{D}^{op} \rightarrow \mathbf{Set}$. In particular, $F \dashv G$ precisely when $(\lrcorner F \rhd) \cong (\lrcorner G \rhd)$.

The suggestive shape of the boxes (from [CK17]) is matched by their semantics. Every category has a dual (namely, its opposite category) and functors circulate as expected through the cups and the caps that represent dualities **Prof**.

$$\begin{array}{c} \lrcorner F \rhd \\ \text{---} \end{array} \cong \begin{array}{c} \text{---} \\ \lrcorner F \rhd \end{array} \quad ; \quad \begin{array}{c} \text{---} \\ \lrcorner F \rhd \end{array} \cong \begin{array}{c} \lrcorner F \rhd \\ \text{---} \end{array}$$

Both of these embeddings are strong monoidal pseudofunctors $\mathbf{Cat} \rightarrow \mathbf{Prof}$, fully faithful on the 2-cells. Pseudofunctoriality gives $(\lrcorner F \rhd \lrcorner G \rhd) \cong (\lrcorner (G \circ F) \rhd)$ and its counterpart. Monoidality gives the following isomorphism and its mirrored counterpart.

$$\begin{array}{c} \mathbf{C}_1 \quad \mathbf{D}_1 \\ \text{---} \lrcorner F_1 \rhd \text{---} \\ \mathbf{C}_2 \quad \mathbf{D}_2 \\ \text{---} \lrcorner F_2 \rhd \text{---} \end{array} \cong \begin{array}{c} \mathbf{C}_1 \quad \mathbf{D}_1 \\ \text{---} \lrcorner (F_1 \times F_2) \rhd \text{---} \\ \mathbf{C}_2 \quad \mathbf{D}_2 \end{array}$$

Proposition 2.4. *In the category of profunctors, functors are left adjoints, in the sense that there exist morphisms $\eta_F: (\text{---}) \rightarrow (\lrcorner F \rhd \lrcorner F \rhd)$ and $\varepsilon_F: (\lrcorner F \rhd \lrcorner F \rhd) \rightarrow (\text{---})$ and they verify the zig-zag identities. Moreover, every natural transformation commutes with these dualities in the sense that the following are two commutative squares.²*

$$\begin{array}{ccc} (\text{---}) & \xrightarrow{\eta_F} & (\lrcorner F \rhd \lrcorner F \rhd) & & (\lrcorner F \rhd \lrcorner G \rhd) & \xrightarrow{\alpha} & (\lrcorner F \rhd \lrcorner F \rhd) \\ \eta_G \downarrow & & \downarrow \alpha & & \downarrow \alpha & & \downarrow \varepsilon_F \\ (\lrcorner G \rhd \lrcorner G \rhd) & \xrightarrow{\alpha} & (\lrcorner F \rhd \lrcorner G \rhd) & & (\lrcorner G \rhd \lrcorner G \rhd) & \xrightarrow{\varepsilon_G} & (\text{---}) \end{array}$$

A partial converse holds: a left adjoint profunctor is representable when its codomain is Cauchy complete; see [Bor94].

Definition 2.5 (Yoneda embeddings). Every object $A \in \mathbf{C}$ determines two profunctors $(\mathbb{A} \text{---}) := \mathbf{C}(A, -): \mathbf{1}^{op} \times \mathbf{C} \rightarrow \mathbf{Set}$ and $(\text{---} \mathbb{A}) := \mathbf{C}(-, A): \mathbf{C}^{op} \times \mathbf{1} \rightarrow \mathbf{Set}$ called their contravariant and covariant Yoneda embeddings. Every morphism $f \in \mathbf{C}(A, B)$ can be seen as a natural transformation $f: (\text{---} \mathbb{A}) \rightarrow (\text{---} \mathbb{B})$. In particular, identities and composition give morphisms $\eta_A: (\text{---} \mathbb{A}) \rightarrow (\mathbb{A} \text{---} \mathbb{A})$ and $\varepsilon_A: (\text{---} \mathbb{A}) \rightarrow (\text{---})$. Unitality of the identity under composition becomes the zig-zag equation making these two adjoints (see Proposition 2.4).

²The graphical calculus of the bicategory makes these equations much clearer. We are emphasizing the monoidal bicategory structure here only for the sake of coherence.

2.1. Monoidal categories.

Definition 2.6. Every monoidal category \mathbf{C} has a canonical pseudomonoid structure on the monoidal bicategory \mathbf{Prof} given by $(\mathfrak{P}-) := \mathbf{C}(- \otimes -, -)$ and $(\circ-) := \mathbf{C}(I, -)$. It is a promonoidal category in the sense of [Lor19]. Because unit and multiplication arise from functors, they are left adjoint to $(-\mathfrak{Q}) := \mathbf{C}(-, - \otimes -)$ and $(-\circ) := \mathbf{C}(-, I)$, that gives a pseudocomonoid structure.

Following Proposition 2.4, the monoidal product determines an adjunction with counit $\varepsilon_{\otimes}: (\mathfrak{Q}\mathfrak{P}) \rightarrow (\text{---})$ and unit $\eta_{\otimes}: (\text{---}) \rightarrow (\mathfrak{P}\mathfrak{Q})$. The monoidal unit does the same with $\varepsilon_I: (-\circ) \rightarrow (\text{---})$ and $\eta_I: (\text{---}) \rightarrow (\circ-)$.

Proposition 2.7. *We have*

$$\begin{array}{c} \textcircled{A} \\ \textcircled{B} \end{array} \text{---} \cong \boxed{A \otimes B} \text{---} \quad \text{---} \begin{array}{c} \textcircled{A} \\ \textcircled{B} \end{array} \cong \text{---} \boxed{A \otimes B}$$

By definition, $(\textcircled{-}) \cong (\circ-)$ and $(-\textcircled{-}) \cong (-\circ)$.

Proof. This is a consequence of pseudofunctoriality (2.3). \square

2.2. Cartesian, cocartesian and symmetric monoidal categories. Every object of the category of profunctors has already a canonical pseudocomonoid structure lifted from \mathbf{Cat} and given by $(-\mathfrak{Q}) := \mathbf{C}(-^0, -^1) \times \mathbf{C}(-^0, -^2)$ and $(-\bullet) := 1$; but also a pseudomonoid structure given by $(\mathfrak{P}-) := \mathbf{C}(-^1, -^0) \times \mathbf{C}(-^2, -^0)$, and $(\bullet-) := 1$. These copy and discard representable and corepresentable functors, respectively.

Proposition 2.8. *A monoidal category is **cartesian** if and only if $(-\circ) \cong (-\bullet)$ and $(-\mathfrak{Q}) \cong (-\mathfrak{C})$, the monoidal structure coinciding with the canonical one. Dually, a monoidal category is **cocartesian** if and only if $(\mathfrak{P}-) \cong (\mathfrak{P}-)$ and $(\circ-) \cong (\bullet-)$.*

Proof. The natural isomorphism $\mathbf{C}(X, Y \otimes Z) \cong \mathbf{C}(X, Y) \times \mathbf{C}(X, Z)$ is precisely the universal property of the product; a similar reasoning holds for initial objects, terminal objects and coproducts. \square

Proposition 2.9. *If a monoidal category \mathbf{C} is symmetric then we have $\sigma: (\mathfrak{X}\mathfrak{P}) \cong (\mathfrak{P}\mathfrak{X})$ and $(-\mathfrak{Q}\mathfrak{X}) \cong (-\mathfrak{Q})$, commuting with unitors, associators and the adjunctions created by the monoidal structure.*

Proof. The symmetric pseudomonoid structure is lifted from \mathbf{Cat} , causing σ to commute with unitors and associators. Commuting with the adjunctions of the monoidal structure is a consequence of Proposition 2.4. \square

3. SHAPES OF OPEN DIAGRAMS

We have all the ingredients to construct shapes for open diagrams. We will start by the examples discussed on the introduction, focus then on the case of *lenses* [Ril18] and finally comment both on the construction of free categories with feedback (the *Circ* construction [KSW02]) and *learners* [FST19].

3.1. Motivating examples. Consider the examples that motivated the introduction (in Figure 4). We write them this time with the graphical calculus of the cartesian bicategory \mathbf{Prof} , which allows us to obtain formulaic descriptions of the shapes and compose them in different ways.

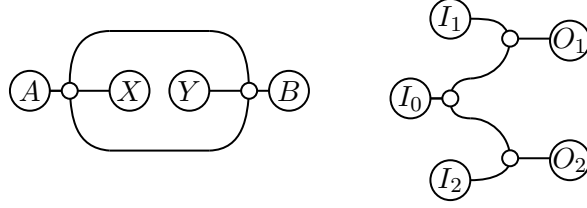

FIGURE 6. The shapes of Figure 4, interpreted as coends.

The corresponding coend descriptions are as follows.

$$\int^{M,N} \mathbf{C}(A, M \otimes X \otimes N) \times \mathbf{C}(M \otimes Y \otimes N, B),$$

$$\int^{M,N} \mathbf{C}(I_0, M \otimes N) \times \mathbf{C}(I_1 \otimes M, O_1) \times \mathbf{C}(N \otimes I_2, O_2).$$

Remark 3.1. If \mathbf{C} is cartesian monoidal, the second shape reduces to a pair of morphisms $\mathbf{C}(I_0 \times I_1, O_1)$ and $\mathbf{C}(I_0 \times I_2, O_2)$, which coincides with our previous intuition in Figure 4 that the input I_1 should not be able to affect O_2 , while the input I_2 should not be able to affect O_1 .

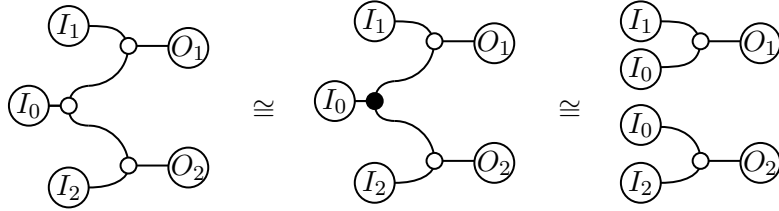

3.2. Lenses and optics. Profunctor optics have been extensively studied in functional programming [Kme18, Mil17, PGW17, BG18] for bidirectional data accessing. Categories of monoidal optics and the interpretation of optics as *diagrams with holes* were studied in depth by Riley [Ril18]. The theory of optics uses coend calculus both to describe how optics compose and how to reduce them in sufficiently well-behaved cases to tuples of morphisms. We are going to be studying optics from the perspective of the graphical calculus of **Prof**. This presents a new way of computing with coend calculus and describing reductions that also formalizes the intuition of optics as *diagrams with holes*.

Definition 3.2. A monoidal lens [Ril18, “Optic” in Definition 2.0.1], from $A, B \in \mathbf{C}$ to $X, Y \in \mathbf{C}$ is an element of the following set.

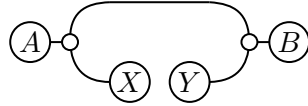

Proposition 3.3. For applications, the most popular case of monoidal lenses is that of cartesian lenses [FJ19, GHWZ18]. In a cartesian category \mathbf{C} , a lens $(A, B) \rightarrow (X, Y)$ is given by a pair of morphisms $\mathbf{C}(A, X)$ and $\mathbf{C}(A \times Y, B)$. In a cocartesian category, these are called prisms [Kme18] and they are given by a pair of morphisms $\mathbf{C}(S, A + T)$ and $\mathbf{C}(B, T)$.

Proof. We write the proof for lenses, the proof for prisms is dual and can be obtained by mirroring the diagrams. The coend derivation can be found, for instance, in [Mil17].

$$\int^M \mathbf{C}(A, M \times X) \times \mathbf{C}(M \times Y, B)$$

$$\begin{array}{ccc}
 \cong & & \cong \\
 \begin{array}{c} \text{Diagram 1: } A \text{ (black dot) connected to } B \text{ via } X, Y \\ \text{Diagram 2: } A \text{ connected to } X, \text{ and } A, Y \text{ connected to } B \end{array} & \int^M \mathbf{C}(A, M) \times \mathbf{C}(A, X) \times \mathbf{C}(M \times Y, B) & \\
 \cong & & \cong \\
 \begin{array}{c} \text{Diagram 3: } A \text{ connected to } X, \text{ and } A, Y \text{ connected to } B \\ \mathbf{C}(A, X) \times \mathbf{C}(A \times Y, B) \end{array} & & \square
 \end{array}$$

Example 3.4. As detailed in the introduction, a lens $(A, B) \rightarrow (X, Y)$ can be composed with a continuation $X \rightarrow Y$ to obtain a morphism $A \rightarrow B$. Let us illustrate this composition in the graphical calculus of **Prof**. It is also interpreted into the following chain of coend calculus, that describes that same composition.

$$\begin{array}{ccc}
 \begin{array}{c} \text{Diagram 1: } A \text{ connected to } B \text{ via } X, Y \\ \text{Diagram 2: } X \text{ connected to } Y \end{array} & \left(\int^M \mathbf{C}(A, M \otimes X) \times \mathbf{C}(M \otimes Y, B) \right) \times \mathbf{C}(X, Y) & \\
 \cong \{ \text{Topology} \} & \cong \{ \text{Continuity} \} & \\
 \begin{array}{c} \text{Diagram 3: } A \text{ connected to } B \text{ via } X, X, Y, Y \\ \text{Diagram 4: } A \text{ connected to } B \text{ via } Y, Y \end{array} & \int^M \mathbf{C}(A, M \otimes X) \times \mathbf{C}(X, Y) \times \mathbf{C}(M \otimes Y, B) & \\
 \rightarrow \{ \varepsilon_X \} & \rightarrow \{ \text{Composition along } X \} & \\
 \begin{array}{c} \text{Diagram 5: } A \text{ connected to } B \text{ via } Y, Y \\ \text{Diagram 6: } A \text{ connected to } B \end{array} & \int^M \mathbf{C}(A, M \otimes Y) \times \mathbf{C}(M \otimes Y, B) & \\
 \rightarrow \{ \varepsilon_Y \} & \rightarrow \{ \text{Composition along } Y \} & \\
 \begin{array}{c} \text{Diagram 7: } A \text{ connected to } B \\ \text{Diagram 8: } A \text{ connected to } B \end{array} & \int^{M, N} \mathbf{C}(A, M \otimes N) \times \mathbf{C}(M \otimes N, B) & \\
 \rightarrow \{ \varepsilon_{\otimes} \} & \rightarrow \{ \text{Composition along } M \otimes N \} & \\
 \begin{array}{c} \text{Diagram 9: } A \text{ connected to } B \\ \mathbf{C}(A, B) \end{array} & &
 \end{array}$$

Example 3.5. Two lenses of types $(A, B) \rightarrow (X, Y)$ and $(X, Y) \rightarrow (U, V)$ can be also composed with each other. This is the composition that gives rise to categories of optics [Ril18].

$$\begin{array}{ccc}
 \begin{array}{c} \text{Diagram 1: } A \text{ connected to } B \text{ via } X, Y \\ \text{Diagram 2: } X \text{ connected to } Y \text{ via } U, V \end{array} & & \\
 \cong & & \\
 \begin{array}{c} \text{Diagram 3: } A \text{ connected to } B \text{ via } X, X, U, V, Y, Y \\ \text{Diagram 4: } A \text{ connected to } B \end{array} & & \\
 \rightarrow \{ \varepsilon_X \} & &
 \end{array}$$

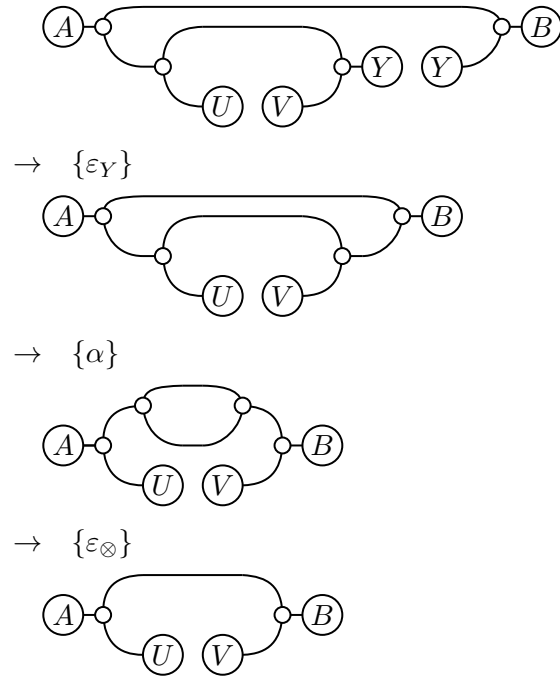

Example 3.6. There is, however, another way of composing two lenses when the category is symmetric. A lens $(A, Y) \rightarrow (X, V)$ can be composed with a lens $(X, B) \rightarrow (U, Y)$ into a lens $(A, B) \rightarrow (U, Y)$. As we will see during its construction, this composition explicitly uses symmetry.

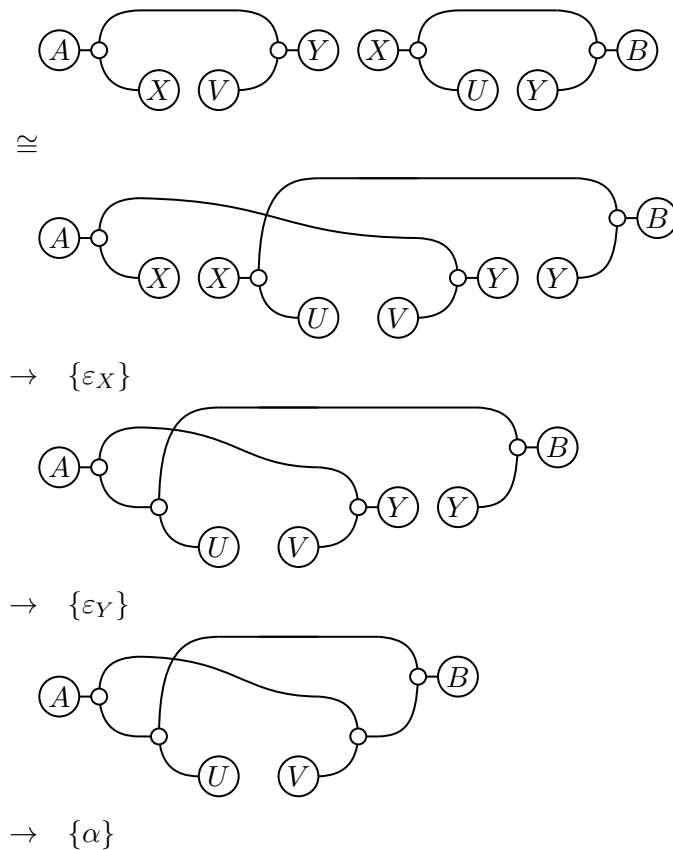

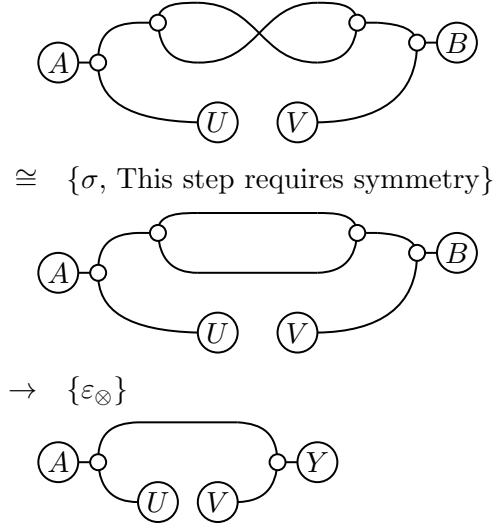

We can observe that even when the category **Prof** is symmetric; in order to produce a valid composition into a new lens, we explicitly use the symmetry of the base category **C**.

4. INTERNAL DIAGRAMS

We have studied so far possible *shapes* for open diagrams; our second step will be to fill them with actual morphisms. Let **C** be a monoidal category and let $f: A \rightarrow M \otimes X$ and $g: M \otimes Y \rightarrow B$ be two morphisms. Our goal in this section is to interpret diagrams like the following one in a suitable category of *pointed profunctors*.

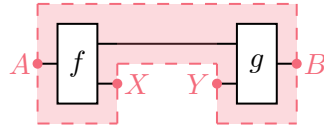

With the theory described so far, this incomplete diagram can be seen as a summary, emphasizing the relevant nodes (f and g), of the following derivation. Note that derivations from the empty diagram to a set H are precisely elements of that H .

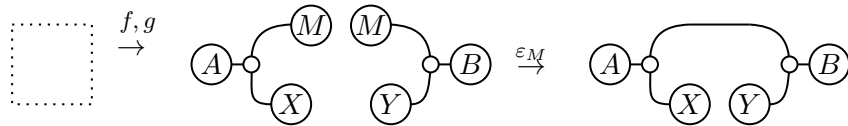

However, we will take a point view for open diagrams closer to the *internal diagrams* described in [BDSPV15] (summarized in [Hu19]). *Inflating the tubes* that represent diagrams in the bicategory of profunctors, we can summarize our derivation as follows.



This graphical notation is at this stage informal, but one can note that these internal diagrams look similar to the functor boxes of [Mel06]. Indeed, this section formalizes our usage of internal diagrams interpreting them as valid diagrams in the graphical calculus of a monoidal bicategory enhanced with functorial boxes.

4.1. Pointed Profunctors.

Definition 4.1. There exists a symmetric monoidal bicategory \mathbf{Prof}_* having as objects pairs (\mathbf{A}, X) where \mathbf{A} is a (small) category and $X \in \mathbf{A}$ is an object of that category; 1-cells from $(\mathbf{A}, X) \rightarrow (\mathbf{B}, Y)$ pairs (P, p) given by a profunctor $P: \mathbf{A}^{op} \times \mathbf{B} \rightarrow \mathbf{Set}$ and a point $p \in P(X, Y)$; 2-cells from $(P, p) \rightarrow (Q, q)$ are natural transformations $\eta: P \rightarrow Q$ such that $\eta_{X, Y}(p) = q$. Composition of 1-cells $(P, p): (\mathbf{A}, X) \rightarrow (\mathbf{B}, Y)$ and $(Q, q): (\mathbf{B}, Y) \rightarrow (\mathbf{C}, Z)$ is given by $(Q \diamond P, \langle p, q \rangle)$, where $\langle p, q \rangle \in (Q \diamond P)(X, Z)$ is the equivalence class under the coend of the pair (p, q) .

This category is monoidal with the monoidal product of 0-cells being $(\mathbf{A}, X) \times (\mathbf{B}, Y) := (\mathbf{A} \times \mathbf{B}, (X, Y))$ and the monoidal product on 1-cells defined by $(P_1, p_1) \otimes (P_2, p_2) := (P_1 \otimes P_2, (p_1, p_2))$.

Proposition 4.2. Let \mathbf{C} be a (small) category. There exists a pseudofunctor $\mathbf{C} \rightarrow \mathbf{Prof}_*$ sending every object $A \in \mathbf{C}$ to the 0-cell pair (\mathbf{C}, A) and every morphism $f \in \mathbf{C}(A, B)$ to the 1-cell pair $(\mathbf{C}(-, -), f)$. Moreover, when (\mathbf{C}, \otimes, I) is monoidal, the pseudofunctor is lax and oplax monoidal (weak pseudofunctor in [MV18]), with oplaxators being left adjoint to laxators. This would be an op-ajax monoidal pseudofunctor, following the notion of ajax monoidal functor from [FS18].

Proof. We only sketch the construction. The following natural transformations make the functor lax monoidal.

$$\left(\begin{array}{c} \text{---} \\ \text{---} \\ \text{---} \end{array} \right) := (\text{hom}(-, - \otimes -), \text{id}_{A \otimes B}): (\mathbf{C} \times \mathbf{C}, (A, B)) \rightarrow (\mathbf{C}, A \otimes B)$$

$$\left(\begin{array}{c} \text{---} \\ \text{---} \end{array} \right) := (\text{hom}(I, -), \text{id}_I): (\mathbf{1}, *) \rightarrow (\mathbf{C}, I)$$

The following natural transformations make the functor oplax monoidal.

$$\left(\begin{array}{c} \text{---} \\ \text{---} \\ \text{---} \end{array} \right) := (\text{hom}(- \otimes -, -), \text{id}_{A \otimes B}): (\mathbf{C}, A \otimes B) \rightarrow (\mathbf{C} \times \mathbf{C}, (A, B))$$

$$\left(\begin{array}{c} \text{---} \\ \text{---} \end{array} \right) := (\text{hom}(-, I), \text{id}_I): (\mathbf{C}, I) \rightarrow (\mathbf{1}, *)$$

Composition and identities give the counits and units of the adjunctions. The fact that identity is the unit for composition makes the following transformations be 2-cells of \mathbf{Prof}_* .

$$\begin{array}{ccc} \begin{array}{c} \text{---} \\ \text{---} \\ \text{---} \end{array} & \xrightarrow{\varepsilon_\mu} & \begin{array}{c} \text{---} \\ \text{---} \end{array} \\ \begin{array}{c} \text{---} \\ \text{---} \end{array} & \xrightarrow{\eta_\mu} & \begin{array}{c} \text{---} \\ \text{---} \\ \text{---} \end{array} \end{array} \quad \begin{array}{ccc} \begin{array}{c} \text{---} \\ \text{---} \end{array} & \xrightarrow{\eta_u} & \begin{array}{c} \text{---} \\ \text{---} \end{array} \\ \begin{array}{c} \text{---} \\ \text{---} \end{array} & \xrightarrow{\varepsilon_u} & \begin{array}{c} \text{---} \\ \text{---} \end{array} \end{array}$$

□

Remark 4.3. Scalars on \mathbf{Prof}_* are given by a set and some element of the set. From now on, we will use the graphical calculus of \mathbf{Prof}_* to describe elements of a set.

Proposition 4.4. Let \mathbf{C} be a category. For every $A \in \mathbf{C}$, there exist 1-cells $1 \rightarrow (\mathbf{C}, A)$ and $(\mathbf{C}, A) \rightarrow 1$ given by the Yoneda embeddings of A and the identity morphism.

$$\begin{array}{c} \text{---} \\ \text{---} \end{array} \quad \begin{array}{c} \text{---} \\ \text{---} \end{array}$$

Again, composition and identities define an adjunction.

Proposition 4.5. *There exists a functor $\mathcal{U}: \mathbf{Prof}_* \rightarrow \mathbf{Prof}$ that forgets about the specific point. It holds that $a \in A$ for every scalar $(a, A) \in \mathbf{Prof}_*((\mathbf{1}, \mathbf{1}), (\mathbf{1}, \mathbf{1}))$. Natural transformations $\alpha: P \rightarrow Q$ can be lifted to $\alpha_*: (P, p) \rightarrow (Q, \alpha(p))$ in a unique way, determining a discrete opfibration.*

The following morphisms follow the cups, caps, splitting and merging structure from \mathbf{Prof} in \mathbf{Prof}_* . Morphisms circulate through them as expected: turning to morphisms in the opposite category, being copied and discarded.

$$\begin{aligned} \left(\begin{array}{c} \text{---} \\ \text{---} \\ \text{---} \end{array} \right) &:= (\text{hom}(-, -), \text{id}_A): (\mathbf{C} \times \mathbf{C}^{op}, (A, A)) \rightarrow (\mathbf{1}, \mathbf{1}), \\ \left(\begin{array}{c} \text{---} \\ \text{---} \\ \text{---} \end{array} \right) &:= (\text{hom}(-, -), \text{id}_A): (\mathbf{1}, \mathbf{1}) \rightarrow (\mathbf{C} \times \mathbf{C}^{op}, (A, A)), \\ \left(\begin{array}{c} \text{---} \\ \text{---} \\ \text{---} \end{array} \right) &:= (\text{hom}(-^0, -^1) \times \text{hom}(-^0, -^2), (\text{id}_A, \text{id}_A)): (\mathbf{C}, A) \rightarrow (\mathbf{C} \times \mathbf{C}, (A, A)), \\ \left(\begin{array}{c} \text{---} \\ \text{---} \\ \text{---} \end{array} \right) &:= (\text{hom}(-^1, -^0) \times \text{hom}(-^2, -^0), (\text{id}_A, \text{id}_A)): (\mathbf{C} \times \mathbf{C}, (A, A)) \rightarrow (\mathbf{C}, A), \\ \left(\begin{array}{c} \text{---} \\ \text{---} \end{array} \right) &:= (1, *): (\mathbf{1}, \mathbf{1}) \rightarrow (\mathbf{C}, A); \quad \left(\begin{array}{c} \text{---} \\ \text{---} \end{array} \right) := (1, *): (\mathbf{C}, A) \rightarrow (\mathbf{1}, \mathbf{1}). \end{aligned}$$

5. APPLICATIONS OF OPEN DIAGRAMS

5.1. Lawful optics. As an example, we study the notion of lawful optics. Consider first the following two morphisms, that Riley [Ril18] calls *outside*,

$$\begin{array}{c} \text{---} \\ \text{---} \\ \text{---} \end{array} \xrightarrow{\{\varepsilon_X\}} \begin{array}{c} \text{---} \\ \text{---} \\ \text{---} \end{array} \xrightarrow{\{\varepsilon_\otimes\}} \text{---} \text{---}$$

once,

$$\begin{aligned} &\begin{array}{c} \text{---} \\ \text{---} \\ \text{---} \end{array} \\ &\rightarrow \{\eta_X\} \\ &\begin{array}{c} \text{---} \\ \text{---} \\ \text{---} \end{array} \\ &\rightarrow \{\eta_\otimes\} \\ &\begin{array}{c} \text{---} \\ \text{---} \\ \text{---} \end{array} \end{aligned}$$

and twice,

$$\begin{array}{c} \text{---} \\ \text{---} \\ \text{---} \end{array} \rightarrow \{\text{Copy}\}$$

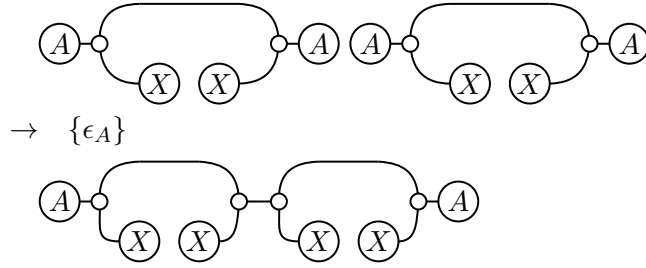

Definition 5.1. [Ril18, Definition 3.0.2] A type-invariant optic $\langle f, g \rangle \in \mathbf{Optic}(X, X, A, A)$ given by

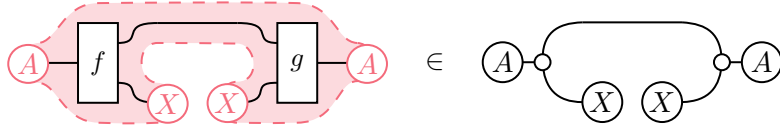

is **lawful** when the following two laws are satisfied. The first law says that $\text{outside}(\langle f, g \rangle) = \text{id}$,

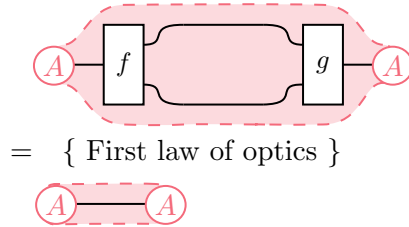

and the second law says that $\text{once}(\langle f, g \rangle) = \text{twice}(\langle f, g \rangle)$,

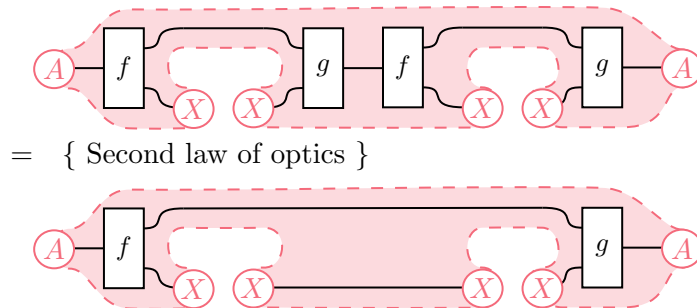

Importantly, the definition of both left hand sides of the lawfulness equations preserves the quotient relation under which optics are defined.

Remark 5.2. When f and g are mutual inverses, we can observe on the graphical calculus that the optic $\langle f, g \rangle$ is lawful. This can be also checked directly from the definition [Ril18, Proposition 3.0.4]. Similarly, one can check that optic composition as defined before is associative, or that optics form a category.

5.2. Feedback and the Circ construction. As one may expect, depicting diagrams in the category of profunctors gives us much more freedom than we would have drawing diagrams in the monoidal category. This extra freedom can be used to represent monoidal processes of more exotic shapes. If we choose not preserve the order of sequential compositions during this identification, and use the opposite category, we can introduce notions of feedback in any monoidal category \mathbf{C} .

Definition 5.3. [KSW02, adapting Definition 2.4] Let \mathbf{C} be a monoidal category. The category $\text{Circ}_{\mathbf{C}}$ has the same objects as \mathbf{C} but the hom-set between $X, Y \in \mathbf{C}$ is

$$\text{Circ}_{\mathbf{C}}(X, Y) := \begin{array}{c} \mathbf{C}^{op} \\ \begin{array}{c} \text{---} \\ \cup \\ \text{---} \\ \cup \\ \text{---} \\ \cup \\ \text{---} \\ \cup \\ \text{---} \\ \cup \\ \text{---} \\ \cup \\ \text{---} \\ \cup \\ \text{---} \\ \cup \\ \text{---} \end{array} \\ \begin{array}{c} \circ \quad \circ \\ \swarrow \quad \searrow \\ \circ \quad \circ \\ \swarrow \quad \searrow \\ \circ \quad \circ \\ \swarrow \quad \searrow \\ \circ \quad \circ \\ \swarrow \quad \searrow \\ \circ \quad \circ \end{array} \\ \begin{array}{c} \circ \\ \swarrow \quad \searrow \\ \circ \quad \circ \\ \swarrow \quad \searrow \\ \circ \quad \circ \\ \swarrow \quad \searrow \\ \circ \quad \circ \end{array} \\ \begin{array}{c} \circ \\ \swarrow \quad \searrow \\ \circ \quad \circ \\ \swarrow \quad \searrow \\ \circ \quad \circ \\ \swarrow \quad \searrow \\ \circ \quad \circ \end{array} \\ \begin{array}{c} \circ \\ \swarrow \quad \searrow \\ \circ \quad \circ \\ \swarrow \quad \searrow \\ \circ \quad \circ \\ \swarrow \quad \searrow \\ \circ \quad \circ \end{array} \\ \begin{array}{c} \circ \\ \swarrow \quad \searrow \\ \circ \quad \circ \\ \swarrow \quad \searrow \\ \circ \quad \circ \\ \swarrow \quad \searrow \\ \circ \quad \circ \end{array} \\ \begin{array}{c} \circ \\ \swarrow \quad \searrow \\ \circ \quad \circ \\ \swarrow \quad \searrow \\ \circ \quad \circ \\ \swarrow \quad \searrow \\ \circ \quad \circ \end{array} \\ \begin{array}{c} \circ \\ \swarrow \quad \searrow \\ \circ \quad \circ \\ \swarrow \quad \searrow \\ \circ \quad \circ \\ \swarrow \quad \searrow \\ \circ \quad \circ \end{array} \\ \begin{array}{c} \circ \\ \swarrow \quad \searrow \\ \circ \quad \circ \\ \swarrow \quad \searrow \\ \circ \quad \circ \\ \swarrow \quad \searrow \\ \circ \quad \circ \end{array} \\ \circ \end{array}$$

As we can see, this is a much compressed description of the free category with feedback, in the sense of Appendix 9.4, a simplified variant of the original Circ construction. It is also arguable that it makes intuitive sense: we are literally adding the feedback as a wire in the opposite category. From this description, is easy to see that the Circ construction can be easily generalized into multiple variants by just changing the category over which we take the coend. This technique is showcased in Definition 9.7 and §9.5.

A morphism of the free category with feedback is now an element of the following diagram.

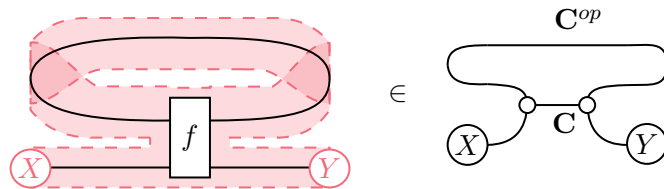

Note how the dinaturality conditions are expressed as follows and are a consequence of the fact that morphisms of \mathbf{C} circulate around the caps and cups that we just described.

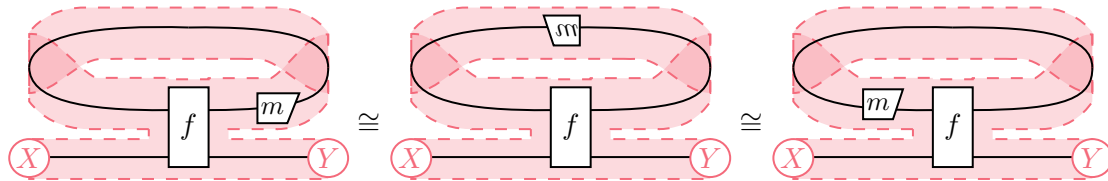

5.3. **Learners.** The connections between the approach of Fong, Spivak and Tuyéras [FST19] to compositional supervised machine learning and lenses have generated recent interest [FJ19]. The approach is based on a category of learners where a morphism can be described as follows.

Definition 5.4. Let (\mathbf{C}, \otimes, I) be a monoidal category. A (monoidal) **learner** taking inputs on an object A and producing outputs on an object B is an element of the following set.

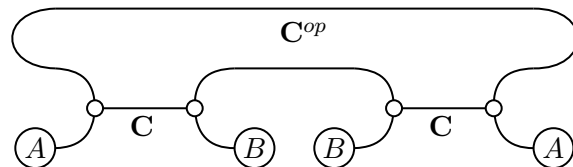

This is a generalization to the monoidal case of an alternative compact definition proposed by Riley [Ril18] in the form of a coend.

$$\int^{P, Q \in \mathbf{C}} \mathbf{C}(P \otimes A, Q \otimes B) \times \mathbf{C}(Q \otimes B, P \otimes A)$$

However, the original definition could be seen as conceptually clearer, as it splits the learner into the functions it should implement. Let us show both are equivalent in the cartesian case.

Proposition 5.5. [FJ19, following Definition 4.1] Let \mathbf{C} be a cartesian category. A learner taking inputs on A and producing outputs on B is given by

- a parameters object $P \in \mathbf{C}$,
- an implementation function $i: P \times A \rightarrow B$,
- an update function $u: P \times A \times B \rightarrow P$, and
- a request function $r: P \times A \times B \rightarrow A$.

Under the right quotient, a learner is precisely a monoidal learner in a cartesian category.

Proof. The following coend derivation appears, in the case of **Set**, in [Ril18, Definition 6.4.1]. It is included here for the sake of completeness and the slight generalization, but also to compare how it works under the graphical calculus.

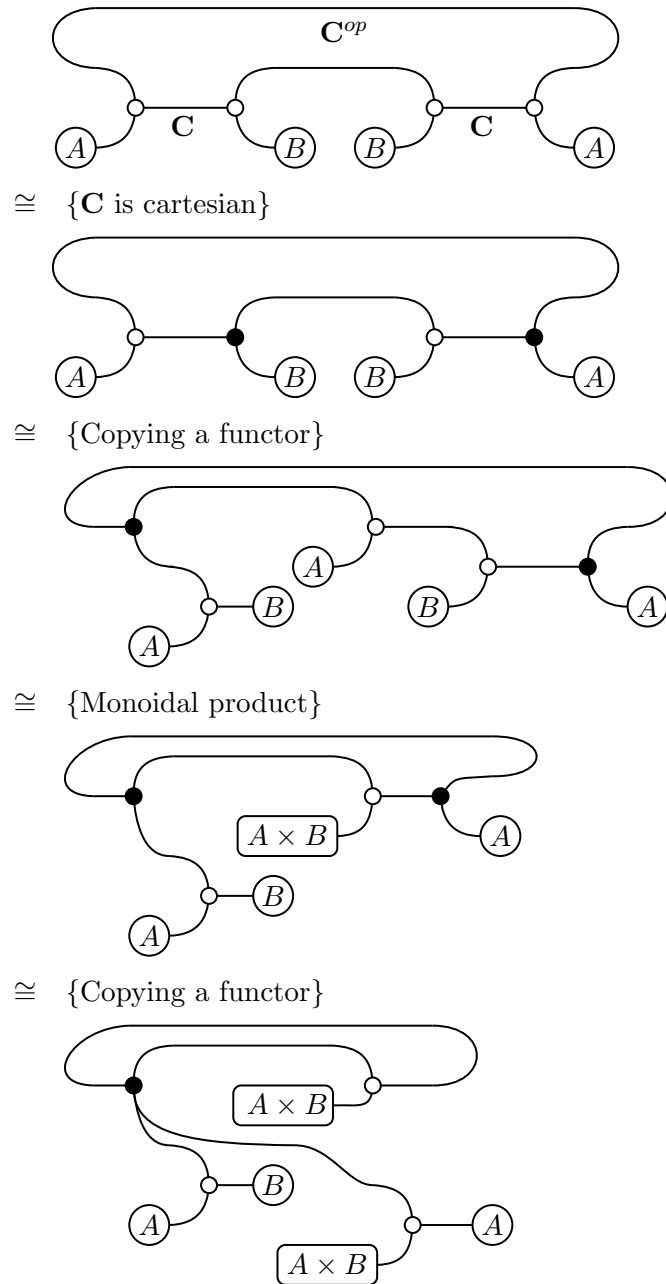

This is the definition in terms of parameters, implementation, update and request. The looping wire represents the parameters quotiented by a coend. A generic learner is given

by the following open diagram.

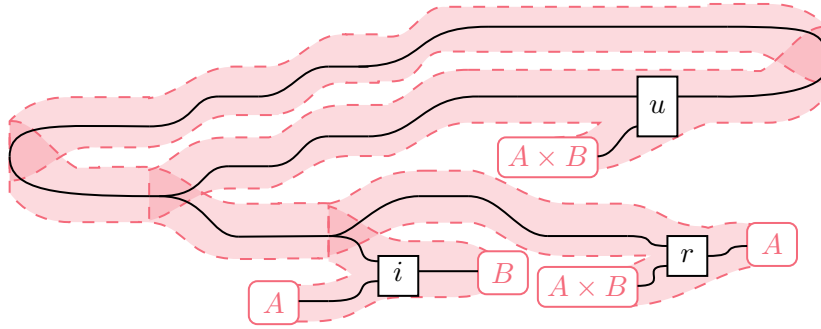

□

6. RELATED AND FURTHER WORK

- Graphical calculi for the cartesian bicategory of relations, as used in [BPS17], and graphical regular logic [FS18] are arguably presenting a decategorification of this same idea.
- Finite *combs*, as described by [CDP08], [KU17] and [Rom20], can be combined in many different ways with this technique. The present approach is strictly more general than considering combs, as it can express arbitrary shapes in non-symmetric monoidal categories. Previous graphical calculi for lenses and optics [Hed17, Boi20] have elegantly captured some aspects of optics by working on the Kleisli or Eilenberg-Moore categories of the Pastre-Street monoidal monad [PS08]. The present approach diverges greatly in the formalism (diagrams using the monoidal bicategory structure of profunctors) and presents a more general application. In any case, it also allows us to reason about categories of optics themselves. We believe that it is closer to, and it provides a formal explanation to the *diagrams with holes* of [Ril18, Definition 2.0.1], which were missing from previous approaches.
- Spans share the same monoidal bicategory structure as profunctors. Multiple approaches to open systems (decorated cospans [Fon15], structured cospans [BC19]) could be related in this way to open diagrams, but we have not explored this possibility yet. Another interesting direction is to repeat this reasoning for the case of the monoidal double category of profunctors and obtain a “tile” version of these diagrams.

7. CONCLUSIONS

We have presented a way to study and compose *processes* in monoidal categories that do not necessarily have the usual shape of a square box without losing the benefits of the usual language of monoidal categories. Direct applications seem to be circuit design, see [CDP08], or the theory of optics. This technique is justified by the formalism of coend calculus [Lor19] and string diagrams for monoidal bicategories [BDSPV15]. We also argue that the graphical representation of coend calculus is helpful to its understanding: contrasting with usual presentations of coends that are usually centered around the Yoneda reductions; the graphical approach seems to put more weight in the non-reversible transformations while making most applications of Yoneda lemma transparent. On internal diagrams, the proposed formalism seems to be enough for most of our purposes and even underused: we could speak of multiple categories at the same time and combine morphisms in any of them using functors and adjunctions. This work in progress has opened for exploration many paths that will be the subject of further work.

We have been working in the symmetric monoidal bicategory of profunctors for simplicity, but the same results extend to the symmetric monoidal bicategory of \mathcal{V} -profunctors for \mathcal{V} a Bénabou cosmos. As an example, the results on optics of [CEG⁺20] can be simplified in this calculus. We can even consider arbitrary monoidal bicategories and drop the requirements for symmetry, copying or discarding, if we only need to work with monoidal shapes that do not involve symmetry in their compositions. Finally, there is an important shortcoming to this approach that we leave as further work: the present graphical calculus is an extremely good tool for *coend calculus*, but it remains to see if it is so for *(co)end calculus*. In other words, *ends* enter the picture only as natural transformations, and this can feel limiting even if applying Yoneda embeddings usually suffices for most applications. As it happens with diagrammatic presentations of regular logic, the existential quantifier plays a more prominent role. Diagrammatic approaches to obtaining the universal quantifier in a situation like this go back to Peirce and are described by [HS20].

8. ACKNOWLEDGEMENTS

The author thanks seminars, discussion with, questions and/or comments by Paweł Sobocinski, Edward Morehouse, Fosco Loregian, Elena Di Lavore, Jens Seeber, Nathaniel Virgo, and the whole Compositional Systems and Methods group at Tallinn University of Technology. Mario Román was supported by the European Union through the ESF funded Estonian IT Academy research measure (project 2014-2020.4.05.19-0001).

REFERENCES

- [Bar14] Bruce Bartlett. Quasistrict symmetric monoidal 2-categories via wire diagrams, 2014.
- [BC19] John C. Baez and Kenny Courser. Structured cospans, 2019.
- [BDSPV15] Bruce Bartlett, Christopher L Douglas, Christopher J Schommer-Pries, and Jamie Vicary. Modular categories as representations of the 3-dimensional bordism 2-category. *arXiv preprint arXiv:1509.06811*, 2015.
- [BG18] Guillaume Boisseau and Jeremy Gibbons. What you needa know about Yoneda: Profunctor optics and the Yoneda Lemma (functional pearl). *PACMPL*, 2(ICFP):84:1–84:27, 2018.
- [Boi17] Guillaume Boisseau. Understanding profunctor optics: a representation theorem. Master’s thesis, University of Oxford, 2017.
- [Boi20] Guillaume Boisseau. String diagrams for optics. *arXiv preprint arXiv:2002.11480*, 2020.
- [Bor94] Francis Borceux. *Handbook of categorical algebra: volume 1, Basic category theory*, volume 1. Cambridge University Press, 1994.
- [BPS17] Filippo Bonchi, Dusko Pavlovic, and Paweł Sobociński. Functorial semantics for relational theories. *CoRR*, abs/1711.08699, 2017.
- [CDP08] G. Chiribella, G. M. D’Ariano, and P. Perinotti. Quantum Circuits Architecture. *Physical Review Letters*, 101(6), Aug 2008.
- [CEG⁺20] Bryce Clarke, Derek Elkins, Jeremy Gibbons, Fosco Loregian, Bartosz Milewski, Emily Pillmore, and Mario Román. Profunctor optics, a categorical update. *arXiv preprint arXiv:1501.02503*, 2020.
- [CK17] Bob Coecke and Aleks Kissinger. *Picturing quantum processes*. Cambridge University Press, 2017.
- [FJ19] Brendan Fong and Michael Johnson. Lenses and Learners. *CoRR*, abs/1903.03671, 2019.
- [Fon15] Brendan Fong. Decorated cospans, 2015.
- [FS18] Brendan Fong and David I. Spivak. Graphical regular logic. *CoRR*, abs/1812.05765, 2018.
- [FST19] Brendan Fong, David Spivak, and Rémy Tuyéras. Backprop as Functor: A compositional perspective on supervised learning. In *2019 34th Annual ACM/IEEE Symposium on Logic in Computer Science (LICS)*, pages 1–13. IEEE, 2019.
- [GHWZ18] Neil Ghani, Jules Hedges, Viktor Winschel, and Philipp Zahn. Compositional game theory. In *Proceedings of the 33rd Annual ACM/IEEE Symposium on Logic in Computer Science, LICS 2018, Oxford, UK, July 09-12, 2018*, pages 472–481, 2018.
- [Hed17] Jules Hedges. Coherence for lenses and open games. *CoRR*, abs/1704.02230, 2017.
- [HHV19] Lukas Heidemann, Nick Hu, and Jamie Vicary. *homotopy.io*. 2019.
- [HS20] Nathan Haydon and Paweł Sobociński. Compositional diagrammatic first-order logic. In *Peer Review*, 2020.

- [Hu19] Nick Hu. External traced monoidal categories. Master’s thesis, University of Oxford, 2019.
- [Kme18] Edward Kmett. lens library, version 4.16. Hackage <https://hackage.haskell.org/package/lens-4.16>, 2012–2018.
- [KSW02] Piergiulio Katis, Nicoletta Sabadini, and Robert F. C. Walters. Feedback, trace and fixed-point semantics. *ITA*, 36(2):181–194, 2002.
- [KU17] Aleks Kissinger and Sander Uijlen. A categorical semantics for causal structure. In *2017 32nd Annual ACM/IEEE Symposium on Logic in Computer Science (LICS)*, pages 1–12. IEEE, 2017.
- [Lor19] Fosco Loregian. Coend calculus. *arXiv preprint arXiv:1501.02503*, 2019.
- [Mar14] Daniel Marsden. Category theory using string diagrams. *arXiv preprint arXiv:1401.7220*, 2014.
- [Mel06] Paul-André Mellès. Functorial boxes in string diagrams. In *Computer Science Logic, 20th International Workshop, CSL 2006, 15th Annual Conference of the EACSL, Szeged, Hungary, September 25-29, 2006, Proceedings*, pages 1–30, 2006.
- [Mil17] Bartosz Milewski. Profunctor optics: the categorical view. <https://bartoszmilewski.com/2017/07/07/profunctor-optics-the-categorical-view/>, 2017.
- [MV18] Joe Moeller and Christina Vasilakopoulou. Monoidal grothendieck construction. *arXiv preprint arXiv:1809.00727*, 2018.
- [PGW17] Matthew Pickering, Jeremy Gibbons, and Nicolas Wu. Profunctor Optics: Modular Data Accessors. *Programming Journal*, 1(2):7, 2017.
- [PS08] Craig Pastro and Ross Street. Doubles for monoidal categories. *Theory and applications of categories*, 21(4):61–75, 2008.
- [Ril18] Mitchell Riley. Categories of Optics. *arXiv preprint arXiv:1809.00738*, 2018.
- [Rom20] Mario Román. Comb Diagrams for Discrete-Time Feedback. *arXiv preprint arXiv:2003.06214*, 2020.
- [SP11] Christopher J. Schommer-Pries. The classification of two-dimensional extended topological field theories, 2011.
- [Wil08] Simon Willerton. A Diagrammatic Approach to Hopf Monads. *arXiv preprint arXiv:0807.0658*, 2008.

9. APPENDIX

9.1. Optic composition is associative.

Proposition 9.1. [Ril18, Compare with Proposition 2.0.3] *Optics, with composition as described in Example 3.5, form a category.*

Proof. Let us first show that composition is associative. Consider three optics

$$o_i := \text{Diagram}(f_i, g_i, A_i, B_i, A_{i+1}, B_{i+1}), \text{ for } i = 1, 2, 3.$$

Lifting Example 3.5, we have two ways of composing them, as $o_1 \circ (o_2 \circ o_3)$ or $(o_1 \circ o_2) \circ o_3$, but they both give rise to the same final diagram.

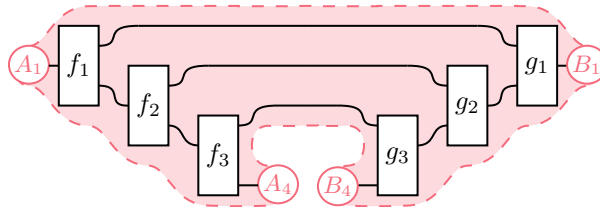

The identity is given by the following optic, and it can be checked that composing with it leaves any other optic unchanged.

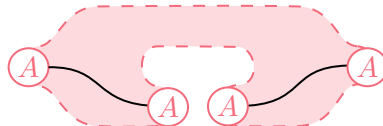

□

9.2. Three-dimensional calculus. The graphical calculus we are using is three-dimensional in nature. The work of Willerton [Wil08] is an example where the three-dimensional structure of the monoidal bicategory \mathbf{Cat} is depicted. It is only because of simplicity and technical constraints that we choose to work in some form of sliced two-dimensional graphical calculus. Arguably, it should not be this way and recent developments try to overcome these constraints. For instance, `Homotopy.io` is a proof assistant supporting n-dimensional diagrammatic reasoning that can render three-dimensional diagrams [HHV19].

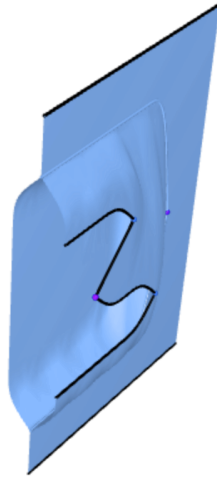

FIGURE 7. A monoidal lens is composed with a particular continuation. It is similar (except for the choice of continuation) to the construction in Example 3.4.

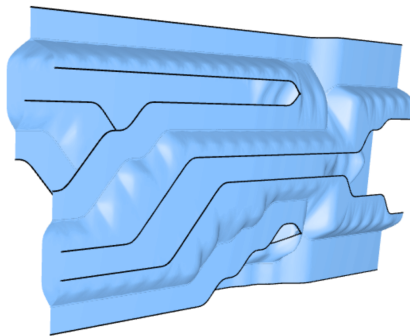
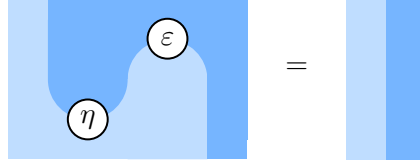

FIGURE 8. Two lenses composing. At the left end, we can see the figure of the two lenses. They get merged in the middle. At the right end, we can see a single lens.

9.3. Shifting perspective. So far, we have been working by considering \mathbf{Prof} from the perspective that makes it look as a monoidal category. This is particularly useful to reason about diagrams in the fashion coend calculus does, where the exact isomorphism or arrow we are applying at every step are not as important as the fact that they exist. The problem with this perspective is that it is explicitly requiring our pointed profunctors

construction to reason about equality at the level of morphisms. For this task, seeing **Prof** as a bicategory and forgetting about its additional monoidal structure seems more suited. The graphical calculus of bicategories is described, for instance, by Marsden [Mar14].

We use blue regions of increasing darkness to represent $\mathbf{C}, \mathbf{C}^2, \mathbf{C}^3, \dots$; and we left implicit the monoidal product and units as color changes. For instance, the following is a consequence of the adjunction between representable and corepresentable profunctors of the monoidal product.



9.3.1. *Describing optics.* The point of view emphasizes the construction process itself. This is important because it can be used to see that the fact that connecting wires in different places can be done independently of the order is a consequence of the interchange law in the bicategory.

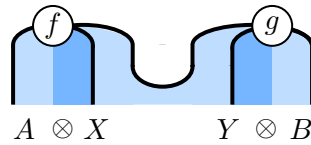

Proposition 9.2. *Optic composition is associative.*

Proof. A fully explicit version of Proposition . Composition of optics is described by the following diagram. Note how in the previous version, the associators were made invisible by the graphical calculus of monoidal categories under the functor boxes.

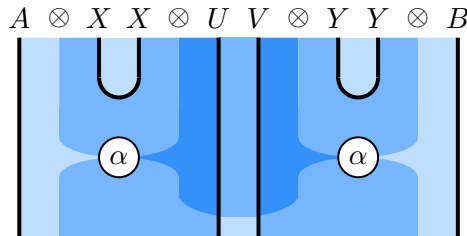

Let us show that it is associative by showing that the two ways of composing three optics are equal.

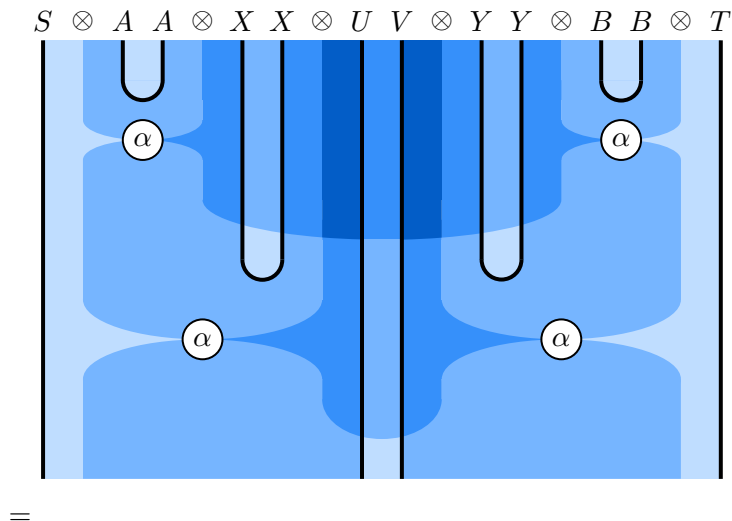

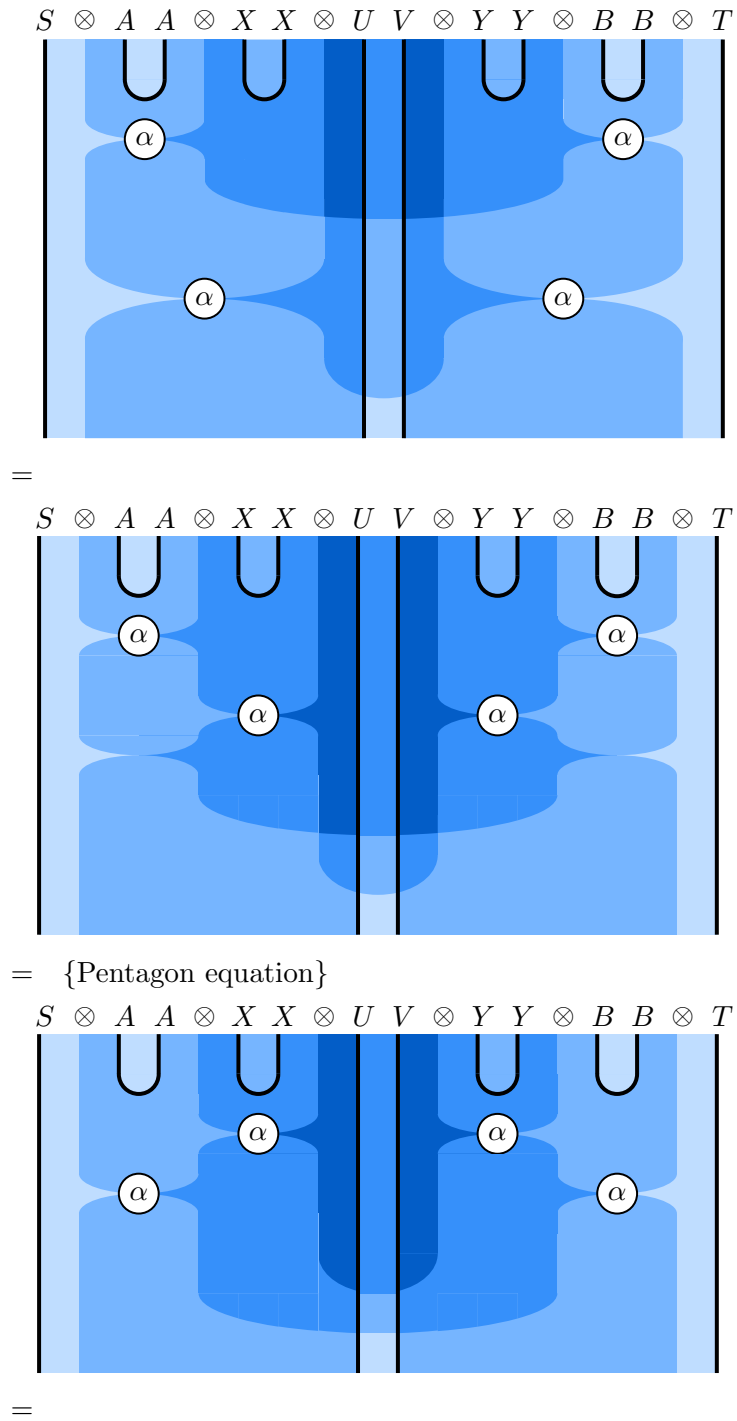

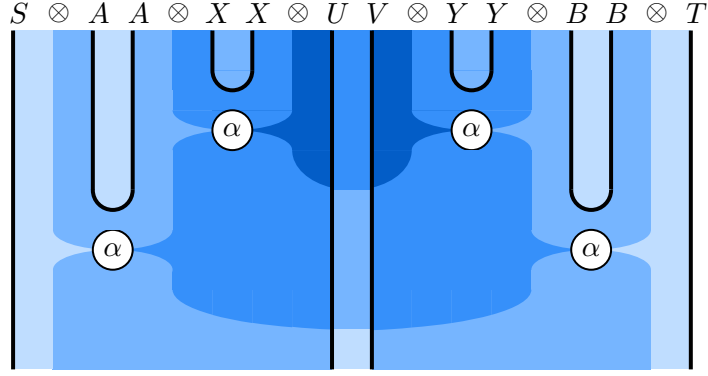

□

9.4. Categories with feedback. Our Circ construction is a slight variant of definition of categories with feedback from [KSW02] that does not restrict the coend to the core groupoid (the isomorphisms) of the category. We do this for simplicity, but we also discuss the original version in Definition 9.7. The axioms of a category with feedback that does not explicitly restrict the feedback to isomorphisms are described here.

Definition 9.3. A **category with feedback** is a symmetric monoidal category \mathbf{C} endowed with a operator $\text{fbk}_{A,B}^M: \mathbf{C}(M \otimes A, M \otimes B) \rightarrow \mathbf{C}(A, B)$, which we call *feedback*.

$$\text{fbk}_{A,B}^M(f) := \begin{array}{c} \overleftarrow{M} \\ \text{---} \text{---} \\ \boxed{f} \\ \text{---} \text{---} \\ A \quad B \end{array}$$

The feedback operator is subject to the following axioms.

- *Left and right tightening*, meaning that $v \circ \text{fbk}_{A,B}^M(f) = \text{fbk}_{A,B'}^M((\text{id} \otimes v) \circ f)$ for any $v \in \mathbf{C}(B, B')$; and that $\text{fbk}_{A,B}^M(f) \circ u = \text{fbk}_{A',B}^M(f \circ (\text{id} \otimes u))$ for any $u \in \mathbf{C}(A', A)$. This is to say that the feedback operator is natural in $A, B \in \mathbf{C}$.

$$\begin{array}{c} \overleftarrow{M} \\ \text{---} \text{---} \\ \boxed{f} \\ \text{---} \text{---} \\ A \quad B \end{array} \circ \begin{array}{c} \boxed{v} \\ \text{---} \text{---} \\ B \quad B' \end{array} = \begin{array}{c} \overleftarrow{M} \\ \text{---} \text{---} \\ \boxed{f} \\ \text{---} \text{---} \\ A \quad B \end{array} \circ \begin{array}{c} \overleftarrow{M} \\ \text{---} \text{---} \\ \boxed{v} \\ \text{---} \text{---} \\ B \quad B' \end{array} ; \quad \begin{array}{c} \overleftarrow{M} \\ \text{---} \text{---} \\ \boxed{f} \\ \text{---} \text{---} \\ A \quad B \end{array} \circ \begin{array}{c} \boxed{u} \\ \text{---} \text{---} \\ A' \quad A \end{array} = \begin{array}{c} \overleftarrow{M} \\ \text{---} \text{---} \\ \boxed{f} \\ \text{---} \text{---} \\ A \quad B \end{array} \circ \begin{array}{c} \boxed{u} \\ \text{---} \text{---} \\ A' \quad A \end{array}$$

Alternatively, the two tightening rules can be combined into a single *tightening* rule, saying that $\text{fbk}_{A',B'}^M((\text{id} \otimes v) \circ f \circ (\text{id} \otimes u)) = v \circ \text{fbk}_{A,B}^M(f) \circ u$.

$$\begin{array}{c} \overleftarrow{M} \\ \text{---} \text{---} \\ \boxed{f} \\ \text{---} \text{---} \\ A \quad B \end{array} \circ \begin{array}{c} \boxed{u} \\ \text{---} \text{---} \\ A' \quad A \end{array} \circ \begin{array}{c} \boxed{v} \\ \text{---} \text{---} \\ B \quad B' \end{array} = \begin{array}{c} \overleftarrow{M} \\ \text{---} \text{---} \\ \boxed{f} \\ \text{---} \text{---} \\ A \quad B \end{array} \circ \begin{array}{c} \overleftarrow{M} \\ \text{---} \text{---} \\ \boxed{v} \\ \text{---} \text{---} \\ B \quad B' \end{array} \circ \begin{array}{c} \boxed{u} \\ \text{---} \text{---} \\ A' \quad A \end{array}$$

- *Sliding*, meaning that $\text{fbk}_{A,B}^N((h \otimes \text{id}) \circ f) = \text{fbk}_{A,B}^M(f \circ (h \otimes \text{id}))$. This is to say that the feedback operator is dinatural in $M \in \mathbf{C}$.

$$\begin{array}{c} \overleftarrow{N} \\ \text{---} \text{---} \\ \boxed{f} \\ \text{---} \text{---} \\ A \quad B \end{array} \circ \begin{array}{c} \boxed{h} \\ \text{---} \text{---} \\ M \quad M \end{array} = \begin{array}{c} \overleftarrow{M} \\ \text{---} \text{---} \\ \boxed{f} \\ \text{---} \text{---} \\ A \quad B \end{array} \circ \begin{array}{c} \boxed{h} \\ \text{---} \text{---} \\ N \quad N \end{array}$$

- *Vanishing*, meaning first that $\text{fbk}_{A,B}^I(\lambda_B \circ f \circ \lambda_A^{-1}) = f$, which is to say that feedback on the unit does nothing. *Vanishing* also means that $\text{fbk}_{A,B}^M(\text{fbk}_{M \otimes A, M \otimes B}^N(f)) = \text{fbk}_{A,B}^{M \otimes N}(f)$, which is to say that feedback on a monoidal pair is the same as two consecutive feedbacks.

- *Strength*, meaning that $\text{fbk}_{A,B}^M(f) \otimes g = \text{fbk}_{A \otimes A', B \otimes B'}^M(f \otimes g)$.

Remark 9.4. Any traced category, and thus any compact closed category, is a category with both strong and weak feedback. The converse is not true, categories with feedback do not necessarily satisfy the yanking equation.

Definition 9.5. A *feedback functor* between two initialized feedback categories \mathbf{C} and \mathbf{D} is a strong monoidal functor $F: \mathbf{C} \rightarrow \mathbf{D}$ such that the following diagram commutes.

$$\begin{array}{ccc}
 \mathbf{C}(M \otimes A, M \otimes B) & \xrightarrow{\text{fbk}^{m,M}} & \mathbf{C}(A, B) \\
 \downarrow F & & \downarrow F \\
 \mathbf{D}(F(M \otimes A), F(M \otimes B)) & & \\
 \downarrow \cong & & \\
 \mathbf{D}(FM \otimes FA, FM \otimes FB) & \xrightarrow{\text{fbk}^{Fm, FM}} & \mathbf{D}(FA, FB)
 \end{array}$$

Categories with feedback form a category where morphisms are the feedback functors between them.

Proposition 9.6. *The free category with feedback Circ over a monoidal category \mathbf{C} is defined having as objects the same as \mathbf{C} and morphisms from A to B given by*

$$\text{Circ}_{\mathbf{C}}(A, B) := \int^{D \in \mathbf{C}} \mathbf{C}(A \otimes D, B \otimes D).$$

It is free in the sense that any monoidal functor $F: \mathbf{C} \rightarrow \mathbf{D}$, where \mathbf{D} is a category with feedback, factors uniquely through $\mathbf{C} \rightarrow \text{Circ}_{\mathbf{C}}$ via an initialized-feedback functor.

$$\begin{array}{ccc}
 \text{Circ}_{\mathbf{C}} & \xrightarrow{\exists! \tilde{F}} & \mathbf{D} \\
 \uparrow i & \nearrow F & \\
 \mathbf{C} & &
 \end{array}$$

9.4.1. *The original Circ construction.*

Definition 9.7. [KSW02, Definition 2.4] Let $U: \text{Core}(\mathbf{C}) \rightarrow \mathbf{C}$ be the obvious inclusion functor from its core subgroupoid. For any two objects $X, Y \in \mathbf{C}$, we define a morphism

in the $\text{Circ}_{\mathbf{C}}$ construction to be an element of the following set.

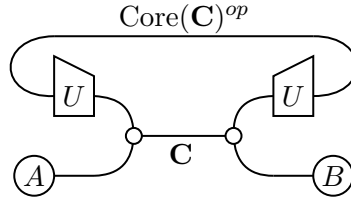

This is equivalently, an element of the following coend.

$$\text{Circ}_{\mathbf{C}}(X, Y) := \int^{M \in \text{Core}(\mathbf{C})} \mathbf{C}(M \otimes X, M \otimes Y).$$

This construction describes the free category with feedback once we restrict the *sliding* axiom to isomorphisms. This is a very interesting technique that is also showcased for algebraic lenses (§9.5): the graphical calculus makes it easy to see how restricting the category over which we take a coend can be used to slightly adjust our definitions.

9.5. Linear and algebraic lenses.

Proposition 9.8. *In a monoidal closed category $(\mathbf{C}, \otimes, I, -\circ)$, a lens $(A, B) \rightarrow (X, Y)$ is given by a single morphism $\mathbf{C}(A, (Y -\circ B) \otimes X)$.*

Proof. The adjunction that defines the exponential of the closed monoidal structure is $\mathbf{C}(X \otimes Y, Z) \cong \mathbf{C}(X, Y -\circ Z)$. This can be translated as saying that there is a functor $(-\circ): \mathbf{C}^{op} \times \mathbf{C} \rightarrow \mathbf{C}$, that we represent by a triangle, such that the following two diagrams are isomorphic.

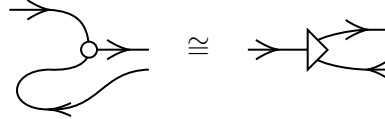

We can then rewrite the lens as follows.

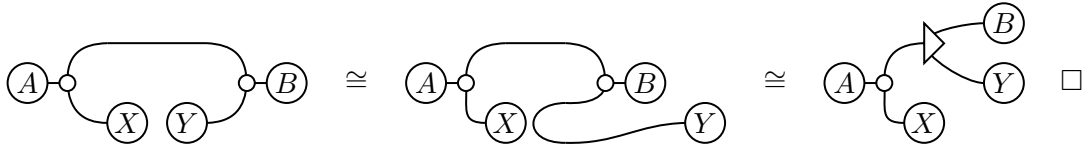

We have discussed so far the topic of monoidal lenses, but *optics* are a more general notion of lens. For simplicity, let us focus on a particular family of optics, similar to lenses, that restrict the category over which the coend is taken. This family can be used to construct lenses that deal with *creation* of missing entries (*achromatic lenses*, [Boi17]) and classification of the focus (*classifying lens*, [CEG⁺20, Remark 3.12]). This showcases a technique that we consider important on its own: restricting the coend to slightly adjust a definition.

Definition 9.9. [CEG⁺20, Definition 3.9] Let \mathbf{C} be a cartesian category and let $T: \mathbf{C} \rightarrow \mathbf{C}$ be a monad; let $F: \mathbf{C} \rightarrow \text{Alg}(T)$ and $U: \text{Alg}(T) \rightarrow \mathbf{C}$ be the free and forgetful functors to the Eilenberg-Moore category, respectively. An algebraic lens $(A, B) \rightarrow (X, Y)$ is an element of the following set.

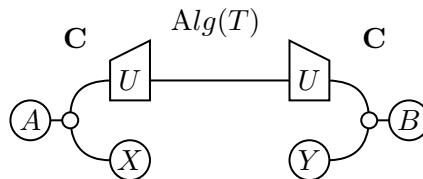

Proposition 9.10. [CEG⁺20, Proposition 3.10] *In a cartesian category, an algebraic lens is equivalent to a pair of functions $\mathbf{C}(A, X)$ and $\mathbf{C}(TA \times Y, B)$.*

Proof.

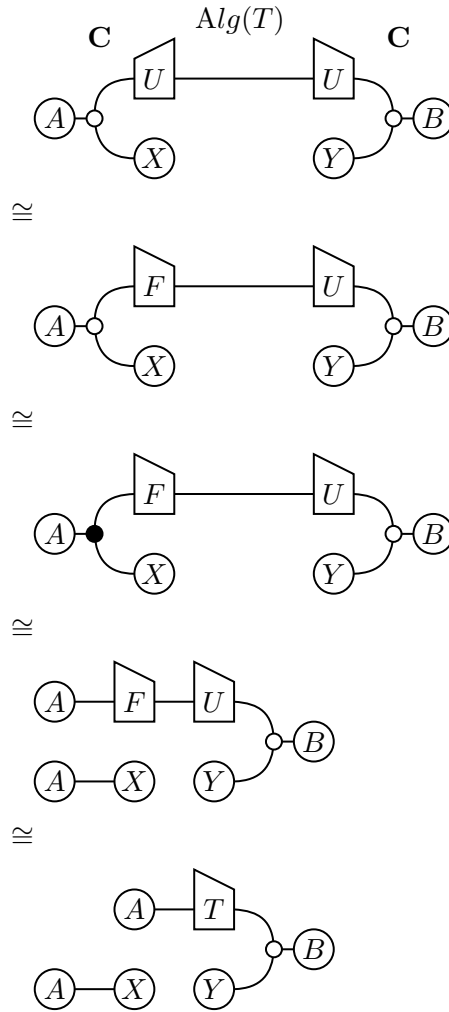

□