

Automated Attacker Synthesis for Distributed Protocols

Max von Hippel, Cole Vick, Stavros Tripakis, and Cristina Nita-Rotaru

Northeastern University, Boston MA 02118, USA
{vonhippel.m, stavros, c.nitarotaru}@northeastern.edu
vick.c@husky.neu.edu

Abstract. Distributed protocols should be robust to both benign malfunction (e.g. packet loss or delay) and attacks (e.g. message replay) from internal or external adversaries. In this paper we take a formal approach to the automated synthesis of attackers, i.e. adversarial processes that can cause the protocol to malfunction. Specifically, given a formal *threat model* capturing the distributed protocol model and network topology, as well as the placement, goals, and interface (inputs and outputs) of potential attackers, we automatically synthesize an attacker. We formalize four attacker synthesis problems - across attackers that always succeed versus those that sometimes fail, and attackers that attack forever versus those that do not - and we propose algorithmic solutions to two of them. We report on a prototype implementation called KORG and its application to TCP as a case-study. Our experiments show that KORG can automatically generate well-known attacks for TCP within seconds or minutes.

Keywords: Synthesis · Security · Distributed Protocols

1 Introduction

Distributed protocols represent the fundamental communication backbone for all services over the Internet. Ensuring the correctness and security of these protocols is critical for the services built on top of them [11]. Prior literature propose different approaches to correctness assurance, e.g. testing [31,13], or structural reasoning [12]. Many such approaches rely on manual analysis or are ad-hoc in nature.

In this paper, we take a systematic approach to the problem of security of distributed protocols, by using formal methods and synthesis [14]. Our focus is the automated generation of *attacks*. But what exactly is an attack? The notion of an attack is often implicit in the formal verification of security properties: it is a counterexample violating some security specification. We take a different approach. We provide a formal definition of *threat models* capturing the distributed protocol model and network topology, as well as the placement, goals, and capabilities of potential *attackers*. Note that an *attacker goal* is simply the negation of a *protocol property*, in the sense that the goal of an attacker is to violate desirable properties that the protocol must preserve. Intuitively, an attacker is a process that, when composed with the system, results in the system violating some protocol property.

By formally defining attackers as processes, our approach has several benefits: First, we can ensure that these processes are *executable*, meaning attackers are programs that reproduce attacks. This is in contrast to other approaches that generate a *trace* exemplifying an attack, but not a program producing the attack, e.g. [8,45]. Second, an explicit formal attacker definition allows us to distinguish different types of attackers, depending on: what exactly does it mean to violate a property (in some cases? in all cases?); how the attacker can behave, etc. We distinguish between \exists -attackers (that sometimes succeed in violating the security property) and \forall -attackers (that always succeed); and between attackers *with recovery* (that eventually revert to normal system behavior) and attackers without (that may attack forever).

We make four primary contributions.

- We propose a novel formalization of threat models and attackers as described above, where the threat models algebraically capture not only the attackers but also the attacker goals, the environmental and victim processes, and the network topology.
- We formalize four attacker synthesis problems – \exists ASP, R- \exists ASP, \forall ASP, R- \forall ASP – one for each of the four combinations of types of attackers described above.

- We propose solutions for the \exists ASP and R- \exists ASP problems via reduction to model-checking. The key idea of our approach is to replace the vulnerable processes - the victim(s) - by appropriate “gadgets”, then ask a model-checker whether the resulting system violates a certain property.
- We implement our solutions in a prototype open-source tool called KORG, and apply KORG to the TCP connection establishment and tear-down routines. Our experiments show that KORG is able to automatically synthesize realistic, well-known attacks against TCP within seconds or minutes.

The rest of the paper is organized as follows. We present background material in Section 2. We define attacker synthesis problems in Section 3 and present our solutions in Section 4. We describe the TCP case study in Section 5, present related work in Section 6, and summarize our conclusions in Section 7.

2 Formal Model Preliminaries

We model distributed protocols as interacting processes, in the spirit of [2]. We next define formally these processes and their composition. We also define formally the specification language that we use, namely LTL. We use the notation 2^X to denote the power-set of X , and ω -exponentiation to denote infinite repetition, e.g., $a^\omega = aaa \dots$.

2.1 Processes

Definition 1 (Process). A (finite-state input-output) process is a tuple $P = \langle AP, I, O, S, s_0, T, L \rangle$ with set of atomic propositions AP , set of inputs I , set of outputs O , set of states S , initial state $s_0 \in S$, transition relation $T \subseteq S \times (I \cup O) \times S$, and (total) labeling function $L : S \rightarrow 2^{AP}$, such that: AP, I, O , and S are finite; and $I \cap O = \emptyset$.

In formal methods, *Kripke Structures* [25] are commonly used to describe computer programs, because they are automata (and so well-suited to describing computer programs) and their states are labeled with atomic propositions (so they are well-suited to modal logic). A *process* is just a Kripke Structure with *inputs* and *outputs*. Using Kripke Structures allows us to leverage LTL for free, and separating messages into inputs and outputs allows us to describe network topologies entirely using just the interfaces of the interacting processes. This idea is fundamental to our formalism of threat models in Section 4. We now explain the technical details of processes.

Let $P = \langle AP, I, O, S, s_0, T, L \rangle$ be a process. For each state $s \in S$, $L(s)$ is a subset of AP that contains the set of atomic propositions that are true at state s . Consider a transition (s, x, s') starting at state s and ending at state s' with label x . If the label x is an input, then the transition is called an *input transition* and denoted $s \xrightarrow{x?} s'$. Otherwise, x is an output, and the transition is called an *output transition* and denoted $s \xrightarrow{x!} s'$. A transition (s, x, s') is called *outgoing* from state s and *incoming* to state s' .

A state $s \in S$ is called a *deadlock* iff it has no outgoing transitions. The state s is called *reachable* if either it is the initial state or there exists a sequence of transitions $((s_i, x_i, s_{i+1}))_{i=0}^m \subseteq T$ starting at the initial state s_0 and ending at $s_{m+1} = s$. Otherwise, s is called *unreachable*. The state s is called *input-enabled* iff, for all inputs $x \in I$, there exists some state $s' \in S$ such that there exists a transition $(s, x, s') \in T$. We call s an *input state* if all its outgoing transitions are input transitions, or an *output state* if all its outgoing transitions are output transitions. States with both outgoing input transitions and outgoing output transitions are neither input nor output states, while states with no outgoing transitions (i.e., deadlocks) are (vacuously) both input and output states.

Various definitions of process determinism exist; ours is a variation on that of [2]. A process P is *deterministic* iff all of the following hold: (i) its transition relation T can be expressed as a function $S \times (I \cup O) \rightarrow S$; (ii) every non-deadlock state in S is either an input state or an output state, but not both; (iii) input states are input-enabled; and (iv) each output state has only one outgoing transition. Determinism guarantees that: each state is a deadlock, an input state, or an output state; when a process outputs, its output is uniquely determined by its state; and when a process inputs, the input and state uniquely determine where the process transitions. More intuitively, deterministic processes can be translated into concrete programs in languages like C or JAVA. Determinism therefore helps us make our attackers realistic.

A *run* of a process P is an infinite sequence $r = ((s_i, x_i, s_{i+1}))_{i=0}^\infty \subseteq T^\omega$ of consecutive transitions. We use $\text{runs}(P)$ to denote all the runs of P . The run r induces an infinite sequence $\sigma = (L(s_i))_{i=0}^\infty$ of evaluations of the

labeling function L over consecutive states in S . Such a sequence σ is called a *computation*. Given a (zero-indexed) sequence ν , we let $\nu[i]$ denote the i^{th} element of ν ; $\nu[i : j]$, where $i \leq j$, denote the finite infix $(\nu[t])_{t=i}^j$; and $\nu[i :]$ denote the infinite postfix $(\nu[t])_{t=i}^{\infty}$; we will use this notation for runs and computations.

Given two processes $P_i = \langle AP_i, I_i, O_i, S_i, s_0^i, T_i, L_i \rangle$ for $i = 1, 2$, we say that P_1 is a *subprocess* of P_2 , denoted $P_1 \subseteq P_2$, if $AP_1 \subseteq AP_2, I_1 \subseteq I_2, O_1 \subseteq O_2, S_1 \subseteq S_2, T_1 \subseteq T_2$, and, for all $s \in S_1, L_1(s) \subseteq L_2(s)$.

2.2 Composition

The composition of two processes P_1 and P_2 is another process denoted $P_1 \parallel P_2$, where \parallel denotes composition. The composed process $P_1 \parallel P_2$ captures both the individual behaviors of P_1 and P_2 as well as their interactions with one another. We define the asynchronous parallel composition operator \parallel with rendezvous communication as in [2].

Definition 2 (Process Composition). Consider two processes $P_i = \langle AP_i, I_i, O_i, S_i, s_0^i, T_i, L_i \rangle$, for $i = 1, 2$. For the composition of P_1 and P_2 (denoted $P_1 \parallel P_2$) to be well-defined, we require the processes to have no common outputs, i.e., $O_1 \cap O_2 = \emptyset$, and no common atomic propositions, i.e., $AP_1 \cap AP_2 = \emptyset$. Then $P_1 \parallel P_2$ is defined to be the following:

$$P_1 \parallel P_2 = \langle AP_1 \cup AP_2, (I_1 \cup I_2) \setminus (O_1 \cup O_2), O_1 \cup O_2, S_1 \times S_2, (s_0^1, s_0^2), T, L \rangle \quad (1)$$

... where the transition relation T is precisely the set of transitions $(s_1, s_2) \xrightarrow{x} (s'_1, s'_2)$ such that, for $i = 1, 2$, if the label $x \in I_i \cup O_i$ is a label of P_i , then $s_i \xrightarrow{x} s'_i \in T_i$, else $s_i = s'_i$. $L : S_1 \times S_2 \rightarrow 2^{AP_1 \cup AP_2}$ is the function defined as $L(s_1, s_2) = L_1(s_1) \cup L_2(s_2)$.

Intuitively, we define process composition to capture two primary ideas: (1) *rendezvous communication*, meaning that a message is sent at the same time that it is received, and (2) *multi-casting*, meaning that a single message could be sent to multiple parties at once. We can use so-called *channel* processes to build asynchronous communication out of rendezvous communication (as we do in Section 5), and we can easily preclude multi-casting by manipulating process interfaces. Our definition therefore allows for a variety of communication models, making it flexible for diverse research problems. We next explain and illustrate the technical details.

A state of the composite process $P_1 \parallel P_2$ is a pair (s_1, s_2) consisting of a state $s_1 \in S_1$ of P_1 and a state $s_2 \in S_2$ of P_2 . The initial state of $P_1 \parallel P_2$ is a pair (s_0^1, s_0^2) consisting of the initial state s_0^1 of P_1 and the initial state s_0^2 of P_2 . The inputs of the composite process are all the inputs of P_1 that are not outputs of P_2 , and all the inputs of P_2 that are not outputs of P_1 . The outputs of the composite process are the outputs of the individual processes. $P_1 \parallel P_2$ has three kinds of transitions $(s_1, s_2) \xrightarrow{z} (s'_1, s'_2)$. In the first case, P_1 may issue an output z . If this output z is an input of P_2 , then P_1 and P_2 move simultaneously and $P_1 \parallel P_2$ outputs z . Otherwise, P_1 moves, outputting z , but P_2 stays still (so $s_2 = s'_2$). The second case is symmetric to the first, except that P_2 issues the output. In the third case, z is neither an output for P_1 nor for P_2 . If z is an input for both, then they synchronize. Otherwise, whichever process has z as an input moves, while the other stays still.

Note that sometimes rendezvous composition is defined to match $s_1 \xrightarrow{z^?} s'_1$ with $s_2 \xrightarrow{z^!} s'_2$ to form a *silent* transition $(s_1, s_2) \rightarrow (s'_1, s'_2)$, but with our definition the output is preserved, so the composite transition would be $(s_1, s_2) \xrightarrow{z^!} (s'_1, s'_2)$. This allows for *multi-casting*, where an output event of one process can synchronize with multiple input events from multiple other processes. It also means there are no silent transitions.

The labeling function L is total as L_1 and L_2 are total. Since we required the processes P_1, P_2 to have disjoint sets of atomic propositions, L does not change the logic of the two processes under composition. Note that the composition of two processes is a process. Additionally, \parallel is commutative and associative [2]. An example of process composition is shown in Fig. 1.

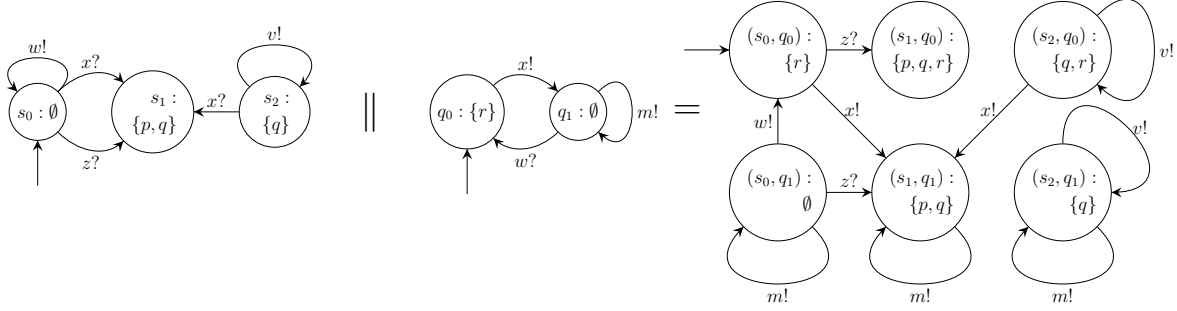

Fig. 1: On the top left is a process P with atomic propositions $\text{AP} = \{p, q\}$, inputs $I = \{x, z\}$, outputs $O = \{v, w\}$, states $S = \{s_0, s_1, s_2\}$, transition relation $T = \{(s_0, w, s_0), (s_0, x, s_1), (s_0, z, s_1), (s_2, x, s_1), (s_2, v, s_2)\}$, and labeling function L where $L(s_0) = \emptyset$, $L(s_1) = \{p, q\}$, and $L(s_2) = \{q\}$. On the top right is a process $Q = \langle \{r\}, \{w\}, \{x, m\}, \{q_0, q_1\}, q_0, \{(q_0, x, q_1), (q_1, m, q_1), (q_1, w, q_0)\}, L_Q \rangle$ where $L_Q(q_0) = \{r\}$ and $L_Q(q_1) = \emptyset$. Processes P and Q have neither common atomic propositions ($\{p, q\} \cap \{r\} = \emptyset$), nor common outputs ($\{w, v\} \cap \{x, m\} = \emptyset$), therefore the composition $P \parallel Q$ is well-defined. Bottom-center is the process $P \parallel Q$. Although $P \parallel Q$ is rather complicated, its only reachable states are (s_0, q_0) , (s_1, q_0) , and (s_1, q_1) , and its only run is $r = ((s_0, q_0), x, (s_1, q_1)), ((s_1, q_1), m, (s_1, q_1))^\omega$. Accordingly, the only computation of $P \parallel Q$ is $\sigma = \{r\}, \{p, q\}^\omega$. This fact is non-obvious when looking at only P and Q .

2.3 LTL

LTL [35] is a linear temporal logic for reasoning about computations. In this work, we use LTL to formulate properties of processes. The syntax of LTL is defined by the following grammar:

$$\phi ::= \underbrace{p \mid q \mid \dots}_{\in \text{AP}} \mid \phi_1 \wedge \phi_2 \mid \neg \phi_1 \mid \mathbf{X}\phi_1 \mid \phi_1 \mathbf{U}\phi_2 \quad (2)$$

... where $p, q, \dots \in \text{AP}$ can be any atomic propositions, and ϕ_1, ϕ_2 can be any LTL formulae. Let σ be a computation of a process P . If an LTL formula ϕ is true about σ , we write $\sigma \models \phi$. On the other hand, if $\neg(\sigma \models \phi)$, then we write $\sigma \not\models \phi$. The semantics of LTL with respect to σ are as follows.

$$\begin{aligned} \sigma \models p & \quad \text{iff } p \in \sigma[0] \\ \sigma \models \phi_1 \wedge \phi_2 & \quad \text{iff } \sigma \models \phi_1 \text{ and } \sigma \models \phi_2 \\ \sigma \models \neg \phi_1 & \quad \text{iff } \sigma \not\models \phi_1 \\ \sigma \models \mathbf{X}\phi_1 & \quad \text{iff } \sigma[1:] \models \phi_1 \\ \sigma \models \phi_1 \mathbf{U}\phi_2 & \quad \text{iff } (\exists K \geq 0 : \sigma[K:] \models \phi_2, \text{ and} \\ & \quad \forall 0 \leq j < K : \sigma[j:] \models \phi_1) \end{aligned} \quad (3)$$

Essentially, p holds iff it holds at the first step of the computation; the conjunction of two formulae holds if both formulae hold; the negation of a formula holds if the formula does not hold; $\mathbf{X}\phi_1$ holds if ϕ_1 holds in the next step of the computation; and $\phi_1 \mathbf{U}\phi_2$ holds if ϕ_2 holds at some future step of the computation, and until then, ϕ_1 holds. Standard syntactic sugar include \vee , **true**, **false**, **F**, **G**, and \rightarrow . For all LTL formulae ϕ_1, ϕ_2 and atomic propositions $p \in \text{AP}$: $\phi_1 \vee \phi_2 \equiv \neg(\neg\phi_1 \wedge \neg\phi_2)$; **true** $\equiv p \vee \neg p$; **false** $\equiv \neg \mathbf{true}$; **F** $\phi_1 \equiv \mathbf{trueU}\phi_1$; **G** $\phi_1 \equiv \neg \mathbf{F}\neg\phi_1$; and $\phi_1 \rightarrow \phi_2 \equiv (\neg\phi_1) \vee (\phi_1 \wedge \phi_2)$.

Example formulae include:

- Lunch will be ready in a moment: $\mathbf{X}\text{lunch-ready}$.
- I always eventually sleep: $\mathbf{GF}\text{sleep}$.
- I am hungry until I eat: hungryUeat .
- A and B are never simultaneously in their `crit` states: $\mathbf{G}\neg(\text{crit}_A \wedge \text{crit}_B)$.

An LTL formula ϕ is called a *safety property* iff it can be violated by a finite prefix of a computation, or a *liveness property* iff it can only be violated by an infinite computation [4]. For a process P and LTL formula ϕ , we write $P \models \phi$ iff, for every computation σ of P , $\sigma \models \phi$. For convenience, we naturally elevate our notation for satisfaction on computations to satisfaction on runs, that is, for a run r of a process P inducing a computation σ , we write $r \models \phi$ and say “ r satisfies ϕ ” iff $\sigma \models \phi$, or write $r \not\models \phi$ and say “ r violates ϕ ” iff $\sigma \not\models \phi$.

3 Attacker Synthesis Problems

We want to synthesize attackers automatically. But what exactly is an attacker, or an attack? Intuitively, an attacker is a process that, when composed with the system, results in the system violating some property. There are different types of attackers, depending on what it means to violate a property (in some cases? in all cases?), as well as on the system topology, i.e., the *threat model* (e.g. Fig. 2). In this section, we define the threat model and attacker concepts formally, followed by the attacker synthesis problems considered in this paper.

3.1 Threat Models

A *threat model* or *attacker model* prosaically captures the goals and capabilities of an attacker with respect to some victim and environment. Algebraically, it is difficult to capture the attacker goals and capabilities without also capturing the victim and the environment, so our abstract threat model includes all of the above. Our threat model captures: how many attackers there are; how they communicate with each other and with the rest of the system: what messages they can intercept, transmit, etc; and the attacker goals. We formalize the concept of a threat model in what follows.

Definition 3 (Input-Output Interface). An input-output interface is a tuple (I, O) such that $I \cap O = \emptyset$ and $I \cup O \neq \emptyset$. The class of an input-output interface (I, O) , denoted $\mathcal{C}(I, O)$, is the set of processes with inputs I and outputs O . Likewise, $\mathcal{C}(P)$ denotes the input-output interface the process P belongs to. (e.g. Fig. 3)

Definition 4 (Threat Model). A threat model is a tuple $(P, (Q_i)_{i=0}^m, \phi)$ where P, Q_1, \dots, Q_m are processes, each process Q_i has no atomic propositions (i.e., its set of atomic propositions is empty), and ϕ is an LTL formula such that $P \parallel Q_0 \parallel \dots \parallel Q_m \models \phi$. We also require that the system $P \parallel Q_0 \parallel \dots \parallel Q_m$ satisfies the formula ϕ in a non-trivial manner, that is, that $P \parallel Q_0 \parallel \dots \parallel Q_m$ has at least one infinite run.

In a threat model, the process P is called the *target process*, and the processes Q_i are called *vulnerable processes*. The goal of the adversary is to modify the vulnerable processes Q_i so that composition with the target process violates ϕ . (We assume that prior to the attack, the protocol behaves correctly, i.e., it satisfies ϕ .) For example, in TM_1 of Fig. 2, the target process is Alice composed with Bob, and the vulnerable processes are Oscar and Trudy, while in TM_5 , the target process is the composition of Jacob, Simon, Sophia, and Juan, and the only vulnerable process is Isabelle.

3.2 Attackers

Definition 5 (Attacker). Let $\text{TM} = (P, (Q_i)_{i=0}^m, \phi)$ be a threat model. Then $\mathbf{A} = (A_i)_{i=0}^m$ is called a TM-attacker if $P \parallel A_0 \parallel \dots \parallel A_m \not\models \phi$, and, for all $0 \leq i \leq m$: A_i is a deterministic process; A_i has no atomic propositions, and $A_i \in \mathcal{C}(Q_i)$.

The existence of a $(P, (Q_i)_{i=0}^m, \phi)$ -attacker means that if an adversary can exploit all the Q_i , then the adversary can attack P with respect to ϕ . Note that an attacker \mathbf{A} cannot succeed by blocking the system. Indeed, $P \parallel A_0 \parallel \dots \parallel A_m \not\models \phi$ implies that $P \parallel A_0 \parallel \dots \parallel A_m$ has at least one infinite run violating ϕ .

Real-world computer programs implemented in languages like C or JAVA are called *concrete*, while logical models of those programs implemented as algebraic transition systems such as processes are called *abstract*. The motivation for synthesizing abstract attackers is ultimately to recover exploitation strategies that actually work against concrete protocols. So, we should be able to translate an abstract attacker (Fig. 3) into a concrete one (Fig. 11). Determinism guarantees that we can do this. We also require the attacker and the vulnerable processes to have no atomic propositions, so the attacker cannot “cheat” by directly changing the truth-hood of the property it aims to violate.

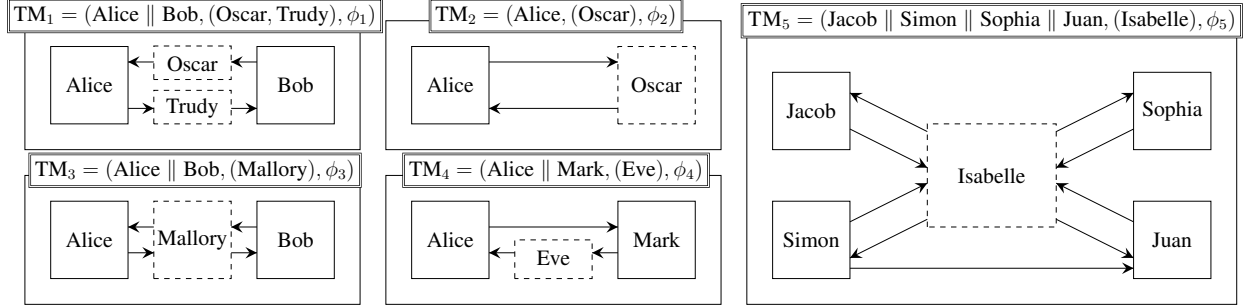

Fig. 2: Example Threat Models. The properties ϕ_i are not shown. Solid and dashed boxes are processes; we only assume the adversary can exploit the processes in the dashed boxes. TM_1 describes a distributed on-path attacker scenario, TM_2 describes an off-path attacker, TM_3 is a classical man-in-the-middle scenario, and TM_4 describes a one-directional man-in-the-middle, or, depending on the problem formulation, an eavesdropper. TM_5 is a threat model with a distributed victim where the attacker cannot affect or read messages from Simon to Juan. Note that a directed edge in a network topology from Node 1 to Node 2 is logically equivalent to the statement that a portion of the outputs of Node 1 are also inputs to Node 2. In cases where the same packet might be sent to multiple recipients, the sender and recipient can be encoded in a message subscript. Therefore, the entire network topology is *implicit* in the interfaces of the processes in the threat model according to the composition definition.

We can define an attacker for many properties at once by conjoining those properties (e.g. $\phi_1 \wedge \phi_2 \wedge \phi_3$), or for many processes at once by composing those processes (e.g. $P_1 \parallel P_2 \parallel P_3$). We therefore do not lose expressibility compared to a definition that explicitly allows many properties or processes.

For a given threat model many attackers may exist. We want to differentiate attacks that are more effective from attacks that are less effective. One straightforward comparison is to partition attackers into those that always violate ϕ , and those that only sometimes violate ϕ . We formalize this notion with \exists -attackers and \forall -attackers.

Definition 6 (\exists -Attacker vs \forall -Attacker). Let \mathbf{A} be a $(P, (Q_i)_{i=0}^m, \phi)$ -attacker. Then \mathbf{A} is called a \forall -attacker if $P \parallel A_0 \parallel \dots \parallel A_m \models \neg\phi$. Otherwise, \mathbf{A} is called an \exists -attacker.

A \forall -attacker \mathbf{A} always succeeds, because $P \parallel \mathbf{A} \models \neg\phi$ means that *every* behavior of $P \parallel \mathbf{A}$ satisfies $\neg\phi$, that is, *every* behavior of $P \parallel \mathbf{A}$ violates ϕ . Since $P \parallel \mathbf{A} \not\models \phi$, there must exist a computation σ of $P \parallel \mathbf{A}$ such that $\sigma \models \neg\phi$, so, a \forall -attacker cannot succeed by blocking. An \exists -attacker is any attacker that is not a \forall -attacker, and every attacker succeeds in at least one computation, so an \exists -attacker sometimes succeeds, and sometimes does not. In most real-world systems, infinite attacks are impossible, implausible, or just uninteresting. To avoid such attacks, we define an attacker that produces finite-length sequences of adversarial behavior, and then “recovers”, meaning that it behaves like a normal environmental process (see Fig. 4).

Definition 7 (Attacker with Recovery). Let $TM = (P, (Q_i)_{i=0}^m, \phi)$ be a threat model and \mathbf{A} a TM-attacker. If, for each $0 \leq i \leq m$, the attacker component A_i consists of a finite DAG ending in the initial state of Q_i , followed by all of Q_i , then we say the attacker \mathbf{A} is an attacker with recovery. (We refer to the Q_i component of each A_i as its recovery.) For example, see Fig. 3, A_3 .

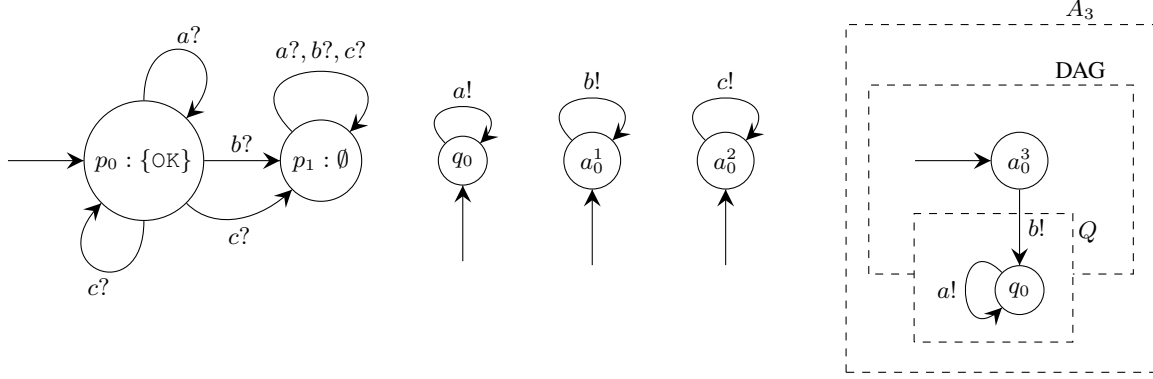

Fig. 3: From left to right: processes P , Q , A_1 , A_2 , A_3 . Let $\phi = \mathbf{G} \text{OK}$, and let the interface of Q be $\mathcal{C}(Q) = (\emptyset, \{a, b, c\})$. Then $P \parallel Q \models \phi$. A_1 and A_2 are both deterministic and have no input states. Let $\mathcal{C}(A_1) = \mathcal{C}(A_2) = \mathcal{C}(Q)$. Then, A_1 and A_2 are both $(P, (Q), \phi)$ -attackers. A_1 is a \forall -attacker, and A_2 is an \exists -attacker. A_3 is a \forall -attacker with recovery consisting of a DAG starting at a_0^3 and ending at the initial state q_0 of Q , plus all of Q , namely the recovery.

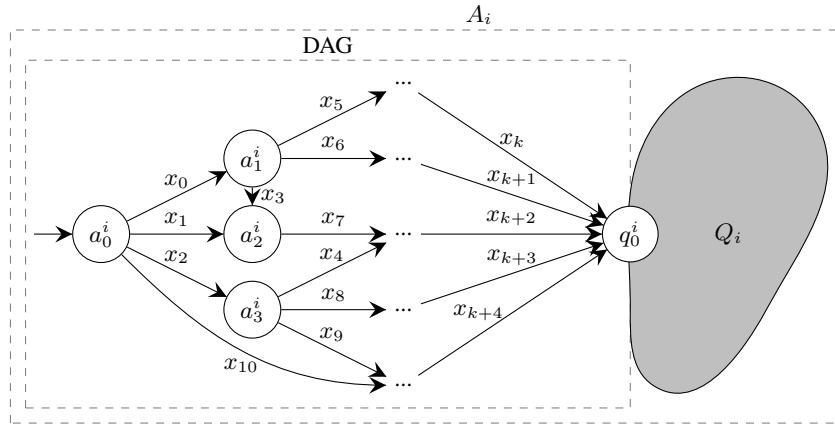

Fig. 4: Suppose $\mathbf{A} = (A_i)_{i=0}^m$ is attacker with recovery for $\text{TM} = (P, (A_i)_{i=0}^m, \phi)$. Further suppose A_i has initial state a_0^i , and Q_i has initial state q_0^i . Then A_i should consist of a DAG starting at a_0^i and ending at q_0^i , plus all of Q_i , called the *recovery*, indicated by the shaded blob. Note that if some Q_i is non-deterministic, then there can be no attacker with recovery, because Q_i is a subprocess of A_i , and all the A_i s must be deterministic in order for \mathbf{A} to be an attacker.

3.3 Attacker Synthesis Problems

Each type of attacker - \exists versus \forall , with recovery versus without - naturally induces a synthesis problem.

Problem 1 (\exists -Attacker Synthesis Problem ($\exists\text{ASP}$)). Given a threat model TM , find a TM -attacker, if one exists; otherwise state that none exists.

Problem 2 (Recovery \exists -Attacker Synthesis Problem ($R\text{-}\exists\text{ASP}$)). Given a threat model TM , find a TM -attacker with recovery, if one exists; otherwise state that none exists.

We defined \exists and \forall -attackers to be disjoint, but, if the goal is to find an \exists -attacker, then surely a \forall -attacker is acceptable too; we therefore did not restrict the $\exists\text{ASP}$ to only \exists -attackers.

Problem 3 (\forall -Attacker Synthesis Problem (\forall ASP)). Given a threat model TM, find a TM- \forall -attacker, if one exists; otherwise state that none exists.

Problem 4 (Recovery \forall -Attacker Synthesis Problem (R- \forall ASP)). Given a threat model TM, find a TM- \forall -attacker with recovery, if one exists; otherwise state that none exists.

The attacker synthesis problems considered in this paper are summarized in Table 1. Each row defines a problem.

Problem	Name	Abbreviation	Find ..., if one exists; otherwise state that none exists.
1	\exists -Attacker Synthesis Problem	\exists ASP	an attacker
2	Recovery \exists -Attacker Synthesis Problem	R- \exists ASP	an attacker with recovery
3	\forall -Attacker Synthesis Problem	\forall ASP	a \forall -attacker
4	Recovery \forall -Attacker Synthesis Problem	R- \forall ASP	a \forall -attacker with recovery

Table 1: Attacker Synthesis Problems.

4 Solutions

We present solutions to the \exists ASP and R- \exists ASP for any number of attackers, and for both safety and liveness properties. The \forall ASP and R- \forall ASP are left for future work, and are briefly discussed in Section 7.

We reduce the \exists ASP and R- \exists ASP to model-checking. The idea is to replace the vulnerable processes Q_i by appropriate “gadgets”, then ask a model-checker whether the resulting system violates a certain property. We prove that existence of a violation (a counterexample) is equivalent to existence of an attacker, and we show how to automatically transform the counterexample into an attacker. The gadgets and the LTL formula are different, depending on whether we seek attackers without or with recovery. The details are presented below.

4.1 Gadgetry

We begin by defining *lassos* and *bad prefixes*. A computation σ is a *lasso* if it equals a finite word α , then infinite repetition of a finite word β , i.e., $\sigma = \alpha \cdot \beta^\omega$. A prefix α of a computation σ is called a *bad prefix* for P and ϕ if P has ≥ 1 runs inducing computations starting with α , and every computation starting with α violates ϕ . We use the terms *lasso* and *bad prefix* when discussing runs whenever the run (or prefix of a run) being discussed induces a computation that is a lasso or bad prefix, respectively. We assume a *model checker*: a procedure $\text{MC}(P, \phi)$ that takes as input a process P and property ϕ , and returns \emptyset if $P \models \phi$, or one or more violating lasso runs or bad prefixes of runs for P and ϕ , otherwise [4].

Attackers cannot have atomic propositions. So, the only way for \mathbf{A} to *attack* TM is by sending and receiving messages, hence the space of attacks is within the space of labeled transition sequences. We exhaust this space with a *Daisy Process*.

Definition 8 (Daisy Process). Let $Q = \langle \emptyset, I, O, S, s_0, T, L \rangle$ be a process with no atomic propositions. Then the daisy of Q , denoted $\text{DAISY}(Q)$, is the process defined below, where $L' : \{d_0\} \rightarrow \{\emptyset\}$ is the map such that $L'(d_0) = \emptyset$.

$$\text{DAISY}(Q) = \langle \emptyset, I, O, \{d_0\}, d_0, \{(d_0, w, d_0) \mid w \in I \cup O\}, L' \rangle \quad (4)$$

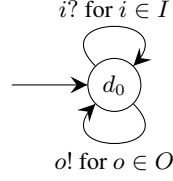

Fig. 5: $\text{DAISY}(Q)$ has transitions $d_0 \xrightarrow{i?} d_0$ and $d_0 \xrightarrow{o!} d_0$ for each $i \in I$ and $o \in O$. So if Q has a run $s_0 \xrightarrow{m_0} s_1 \xrightarrow{m_1} s_2 \xrightarrow{m_2} \dots$, then $\text{DAISY}(Q)$ must have an I/O-equivalent run $d_0 \xrightarrow{m_0} d_0 \xrightarrow{m_1} d_0 \xrightarrow{m_2} \dots$. In other words, $\text{DAISY}(Q)$ can do everything Q can do, and more.

Next, we define a *Daisy with Recovery*. This gadget is an *abstract process*, i.e., a generalized process with a non-empty set of initial states $S_0 \subseteq S$. Composition and LTL semantics for abstract processes are naturally defined. We implicitly transform processes to abstract processes by wrapping the initial state in a set.

Definition 9 (Daisy with Recovery). Given a process $Q_i = \langle \emptyset, I, O, S, s_0, T, L \rangle$, the daisy with recovery of Q_i , denoted $\text{RDAISY}(Q_i)$, is the abstract process $\text{RDAISY}(Q_i) = \langle AP, I, O, S', S_0, T', L' \rangle$, with atomic propositions $AP = \{\text{recover}_i\}$, states $S' = S \cup \{d_0\}$, initial states $S_0 = \{s_0, d_0\}$, transitions $T' = T \cup \{(d_0, x, w_0) \mid x \in I \cup O, w_0 \in S_0\}$, and labeling function $L' : S' \rightarrow 2^{AP}$ that takes s_0 to $\{\text{recover}_i\}$ and other states to \emptyset . (We reserve the symbols $\text{recover}_i, \dots$ for use in daisies with recovery, so they cannot be sub-formulae of the property in any threat model.)

The daisy with recovery gadget is illustrated in Fig. 6.

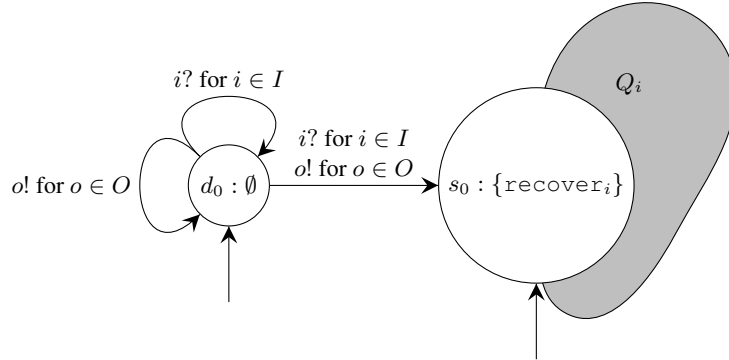

Fig. 6: $\text{RDAISY}(Q_i)$ is the result of (1) directly connecting $\text{DAISY}(Q_i)$ to the initial state of Q_i in every possible way, (2) allowing both the initial state of the daisy and the initial state of Q_i to be initial states of the abstract process, and (3) adding a single atomic proposition recover_i to the initial state of Q_i .

4.2 Solution to the \exists ASP

Let $\text{TM} = (P, (Q_i)_{i=0}^m, \phi)$ be a threat model. Our goal is to find an attacker for TM , if one exists. First, we check whether the system $P \parallel \text{DAISY}(Q_0) \parallel \dots \parallel \text{DAISY}(Q_m)$ satisfies ϕ . If it does, then no attacker exists, as the daisy processes encompass any possible attacker behavior. Define:

$$R = \text{MC}(P \parallel \text{DAISY}(Q_0) \parallel \dots \parallel \text{DAISY}(Q_m), \phi) \quad (5)$$

If $R = \emptyset$ then no attacker exists. On the other hand, if the system violates ϕ , then we can transform a violating run into a set of attacker processes by projecting it onto the corresponding interfaces. Choose a violating run or bad prefix

$r \in R$ arbitrarily. Either $r = \alpha$ is some finite bad prefix, or $r = \alpha \cdot \beta^\omega$ is a violating lasso. For each $0 \leq i \leq m$, let α_i be the projection of α onto the process $\text{DAISY}(Q_i)$. That is, let $\alpha_i = []$; then for each (s, x, s') in α , if x is an input or an output of Q_i , and q, q_i are the states $\text{DAISY}(Q_i)$ embodies in s, s' , add (q, x, q') to α_i .

For each α_i , create an incomplete process A_i^α with a new state s_{j+1}^α and transition $s_j^\alpha \xrightarrow{z} s_{j+1}^\alpha$ for each $\alpha_i[j] = (d_0^i, z, d_0^i)$ for $0 \leq j < |\alpha_i|$. If $r = \alpha \cdot \beta^\omega$ is a lasso, then for each $0 \leq i \leq m$, define A_i^β from β_i in the same way that we defined A_i^α from α_i ; let A'_i be the result of merging the first and last states of A_i^β with the last state of A_i^α . Otherwise, if $r = \alpha$ is a bad prefix, let A'_i be the result of adding an input self-loop to the last state of A_i^α , or an output self-loop if Q_i has no inputs. Either way, A'_i is an incomplete attacker. Finally let A_i be the result of making every input state in A'_i input-enabled via self-loops, and return the attacker $\mathbf{A} = (A_i)_{i=0}^m$. An illustration of the method is given in Figure 7.

Threat Model: $\text{TM}' = (P, (Q_0, Q_1), \phi)$, where the processes from left to right are P, Q_0 , and Q_1 , and where $\phi = \mathbf{FGL}$. P has inputs k and m , and output n . Q_0 has no inputs, and output m . Q_1 has inputs n and h , and output k . Recall that $P \parallel Q_0 \parallel Q_1 \models \phi$.

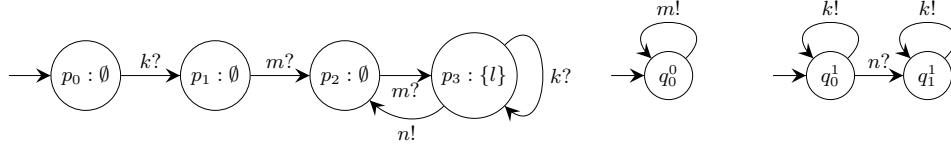

Violating run: A run $r \in R$ where R is defined as in Equation 5.

$$r = \overbrace{\left[\begin{array}{c} p_0 \\ d_0^0 \\ d_0^1 \end{array} \right] \xrightarrow{k!} \left[\begin{array}{c} p_1 \\ d_0^0 \\ d_0^1 \end{array} \right] \xrightarrow{m!} \left[\begin{array}{c} p_2 \\ d_0^0 \\ d_0^1 \end{array} \right] \xrightarrow{m!} \left[\begin{array}{c} p_3 \\ d_0^0 \\ d_0^1 \end{array} \right]}^{\alpha} \xrightarrow{n!} \overbrace{\left[\begin{array}{c} p_2 \\ d_0^0 \\ d_0^1 \end{array} \right] \xrightarrow{m!} \left[\begin{array}{c} p_3 \\ d_0^0 \\ d_0^1 \end{array} \right]}^{\beta^\omega} \xrightarrow{n!} \dots \in R$$

Application of solution: r is projected and translated into an attacker $\mathbf{A} = (A_0, A_1)$.

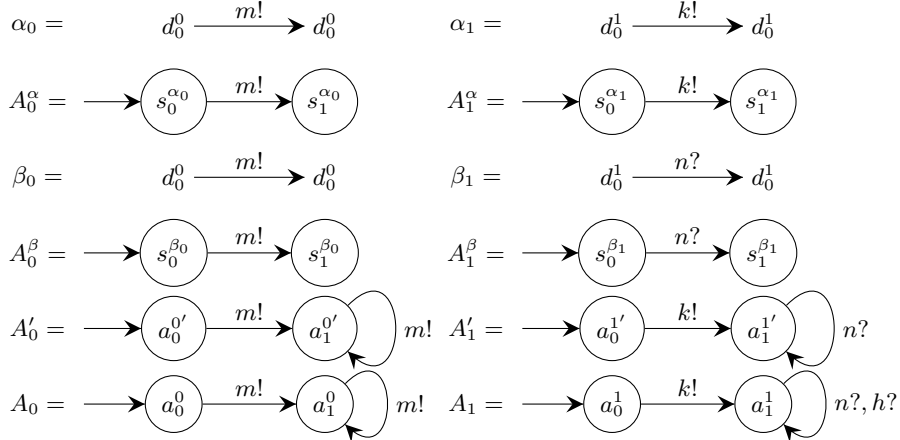

Fig. 7: Example threat model TM' on top, followed by a violating run in R , followed by translation of the run into attacker.

Theorem 1 (Solution for \exists ASP is Sound and Complete). Let $\text{TM} = (P, (Q_i)_{i=0}^m, \phi)$ be a threat model, and define R as in Equation 5. Then the following hold. (1) $R \neq \emptyset$ iff a TM-attacker exists. (2) If $R \neq \emptyset$, then the procedure described above eventually terminates, and returns some TM-attacker \mathbf{A} .

Sketch of Proof. We prove (2) then (1). Suppose $r \in R$. Processes are finite and threat models are finitely large, so the procedure eventually terminates. We need to show the result $\mathbf{A} = (A_i)_{i=0}^m$ is a TM-attacker. Showing the result is

deterministic is straightforward, and it should be equally clear that each A_i has the same interface as its respective Q_i . We inductively demonstrate that $P \parallel A_0 \parallel \dots \parallel A_m$ has some run r' that is I/O-equivalent to the run r and induces the same computation. So then $r' \not\models \phi$, so \mathbf{A} is a TM-attacker and therefore (2) holds.

We now turn our attention to (1). If a TM-attacker \mathbf{A}' exists, then $P \parallel A'_0 \parallel \dots \parallel A'_m$ has a run r violating ϕ . The daisies can do everything the Q_i s can do and more, so the daisies yield some I/O-equivalent run r' violating ϕ , and so $R \neq \emptyset$. On the other hand, if $R = \emptyset$ then we can easily prove by way of contradiction that no attacker exists, since attackers, daisies, and vulnerable processes have no atomic propositions, and therefore any violating run of an attacker with P could be translated into an I/O-equivalent run of the daisies with P inducing the same computation. So (1) holds and we are done. \square

4.3 Solution to the R- \exists ASP

Let $\text{TM} = (P, (Q_i)_{i=0}^m, \phi)$ be a threat model as before. Now our goal is to find a TM-attacker *with recovery*, if one exists. The idea to solve this problem is similar to the idea for finding attackers without recovery, with two differences. First, the daisy processes are now more complicated, and include recovery to the original Q_i processes. Second, the formula used in model-checking is not ϕ , but a more complex formula ψ to ensure that all attackers eventually recover. We define the property ψ so that in prose it says “if all daisies eventually recover, then ϕ holds”. Then, we define R like before, except we replace daisies with daisies with recovery, and ϕ with ψ , as defined below.

$$\psi = \left(\bigwedge_{0 \leq i \leq m} \mathbf{F} \text{ recover}_i \right) \implies \phi \quad (6)$$

$$R = \text{MC}(P \parallel \text{RDAISY}(Q_0) \parallel \dots \parallel \text{RDAISY}(Q_m), \psi) \quad (7)$$

If $R = \emptyset$ then no attacker with recovery exists. If any Q_i is not deterministic, then likewise no attacker with recovery exists, because our attacker definition requires the attacker to be deterministic but if Q_i is not deterministic and $Q_i \subseteq A_i$ then obviously A_i is not deterministic.

Otherwise, choose a violating run (or bad prefix) $r \in R$ arbitrarily. We proceed as we did for the \exists ASP but with three key differences. First, we define α_i by projecting α onto $\text{RDAISY}(Q_i)$ as opposed to $\text{DAISY}(Q_i)$. Second, for each $0 \leq i \leq m$, instead of using A_i^β if r is a lasso, or adding self-loops to the final state if r is a bad prefix, we simply glue A_i^α to Q_i by setting the last state of A_i^α to be the initial state of Q_i . (The result of gluing is a process; the initial state of A_i^α is its only initial state.) Third, instead of using self-loops to input-enable input states, we use input transitions to the initial state of Q_i . This way, the part of the process before Q_i is guaranteed to be a finite DAG. Then we return the result $\mathbf{A} = (A_i)_{i=0}^m$.

Lemma 1 (Attackers with Recovery induce Violating Runs with Recovery). *Let $\text{TM} = (P, (Q_i)_{i=0}^m, \phi)$ be a threat model and \mathbf{A} a TM-attacker with recovery. Define ψ as in Equation 6. Let $r \in \text{runs}(P \parallel A_0 \parallel \dots \parallel A_m)$ be a run such that $r \not\models \phi$. Then there exists a run $r' \in \text{runs}(P \parallel \text{RDAISY}(Q_0) \parallel \dots \parallel \text{RDAISY}(Q_m))$ such that $r' \not\models \psi$.*

Proof. Define TM, ψ, r as in the problem statement. Let $S_1 = P \parallel A_0 \parallel \dots \parallel A_m$ and $S_2 = P \parallel \text{RDAISY}(Q_0) \parallel \dots \parallel \text{RDAISY}(Q_m)$. We need to show there exists a run $r' \in \text{runs}(S_2)$ such that $r' \not\models \psi$.

Let $\tau_0 = (s, x, s')$ be the first transition in r . Consider the transition $\tau_n = r[n]$ with label x_n . Let s_n be the final state of τ'_{n-1} if $n > 0$, or the initial state of S_2 otherwise. Let τ'_n be the transition of S_2 beginning at s_n defined according to the following rules.

- i. If P transitions in τ_n , then P performs the same transition in τ'_n . Otherwise, P stays still in τ'_n .
- ii. If A_i never transitions in r , then no transition in r can have a label in the interface of A_i according to our composition definition. But A_i, Q_i , and $\text{RDAISY}(Q_i)$ all have the same interface. So then we just let $\text{RDAISY}(Q_i)$ stay still in the initial state q_0^i of its recovery in τ'_n , where it satisfies recover_i .
- iii. Else, if A_i transitions in τ_n after recovering, then $\text{RDAISY}(Q_i)$ takes the same transition in τ'_n as A_i does in τ_n .
- iv. Else, if A_i transitions in τ_n , and either this transition ends in recovery for A_i or after this transition A_i stays still forever in r , then $\text{RDAISY}(Q_i)$ performs a transition with label x_n from the initial state d_0^i of its daisy to q_0^i .
- v. Else, if A_i transitions in τ_n , and the previous case does not hold, then $\text{RDAISY}(Q_i)$ performs a self-loop with label x_n on d_0^i .

Let $r' = \prod_{j \geq 0} \tau_j'$. As each τ_j' is a valid transition of S_2 beginning at the final state of τ_{j-1}' , or at the initial state of S_2 if $j = 0$, considering our composition definition, it inductively follows that r' is a run of S_2 . By the finitude of the DAGs in the A_i : in r , all the A_i either recover, or eventually stay still forever. Each $\text{RDAISY}(Q_i)$ recovers in the same step of r' where A_i either recovers or stops moving in r , according to iv., or begins in recovery, according to ii. Therefore $r' \models \mathbf{F}\text{recover}_i$ for each $0 \leq i \leq m$. And since P embodies the same sequence of transitions in r as it does in r' , the two runs induce the same computation. Therefore $r' \not\models \phi$. So r' is a run of S_2 violating ψ and we are done. \square

Theorem 2 (Solution for R- \exists ASP is Sound and Complete). *Let $\text{TM} = (P, (Q_i)_{i=0}^m, \phi)$ be a threat model, and define R as in Equation 7. Furthermore, assume all the Q_i s are deterministic. Then the following hold. (1) $R \neq \emptyset$ iff a TM-attacker with recovery exists. (2) If $R \neq \emptyset$, then the procedure described above eventually terminates, and returns some TM-attacker A with recovery.*

Sketch of Proof. We prove (1) then (2). First assume $R \neq \emptyset$. An attacker must exist, by basically the same logic we used in proving Theorem 1 with the additional step of observing that $\neg\psi \implies \neg\phi$. Second, this attacker must have recovery, as in order to violate ψ it must satisfy $(\mathbf{F}\text{recover}_0) \wedge \dots \wedge (\mathbf{F}\text{recover}_m)$. This suffices to prove (1) left-to-right. Now discard our prior assumption, and instead assume an attacker with recovery $A = (A_i)_{i=0}^m$ exists. By Definition 7, $P \parallel A_0 \parallel \dots \parallel A_m$ has a run r violating ϕ . Then Lemma 1 implies $R \neq \emptyset$ so (1) holds right-to-left. Therefore (1) holds and we may proceed to (2).

Assume $R \neq \emptyset$ and let $r \in R$ be the run selected by the procedure. The solution terminates, and returns a sequence of processes $(A_i)_{i=0}^m$. If $r = \alpha \cdot \beta^\omega$ is a lasso then logically the lasso portion must happen in recovery, as the DAG is finite and acyclic and r is a run so it captures both states and labeled transitions between them. In this case clearly $P \parallel A_0 \parallel \dots \parallel A_m$ has a run r violating ψ . On the other hand, if $r = \alpha$ is a bad prefix, then we need only show that $P \parallel A_0 \parallel \dots \parallel A_m$ has a run r' with a prefix that is I/O-equivalent to α , and this follows from basically the same logic as we used in proving Theorem 1. Moreover, the determinism of the A_i s follows neatly from the determinism of the Q_i s and the logic used in proving Theorem 1. That each A_i has the same interface as its respective Q_i should be obvious. So A is an attacker with recovery and we are done. \square

5 Case Study: TCP

Below we first describe our implementation then the details of our case study (TCP).

Implementation We implemented our solutions in an open-source tool called KORG¹. We say an attacker A for a threat model $\text{TM} = (P, (Q_i)_{i=0}^m, \phi)$ is a *centralized attacker* if $m = 0$, or a *distributed attacker*, otherwise. KORG handles the versions of the \exists ASP and R- \exists ASP for liveness and safety properties for a centralized attacker. KORG is implemented in PYTHON 3 and uses the model-checker SPIN [18] as its underlying verification engine.

Attacker:	Centralized		Distributed	
	\exists Problem	\forall Problem	\exists Problem	\forall Problem
With	✓	✗	✗	✗
Without	✓	✗	✗	✗

Table 2: ✓ or ✗ denote if the solution to a problem is or is not implemented in KORG, for both liveness and safety properties.

TCP is a fundamental Internet protocol consisting of three stages: connection establishment, data transfer, and connection tear-down. We focus on the first and third stages, which jointly we call the connection routine. Our approach and model (see Fig. 8, 9) are inspired by SNAKE [21]. Run-times and results are listed in Table 3.

¹ Named after the Korg microKORG synthesizer, with its dedicated “attack” control on Knob 3. Code and models are freely and openly available at <https://github.com/maxvonhippel/AttackerSynthesis>.



Fig. 8: TCP threat model block diagram. Each box is a process. An arrow from process P_1 to process P_2 denotes that a subset of the outputs of P_2 are exclusively inputs of P_1 . PEERS 1 and 2 are TCP peers. A *channel* is a directed FIFO queue of size one with the ability to detect fullness. A full channel may be overwritten. 1TON, NTO1, 2TON, and NTO2 are channels. Implicitly, channels relabel: for instance, 1TON relabels outputs from PEER 1 to become inputs of NETWORK; NETWORK transfers messages between peers via channels, and is the vulnerable process.

Threat Models We use channels to build asynchronous communication out of direct (rendezvous) communication. Rather than communicating directly with the NETWORK, the peers communicate with the channels, and the channels communicate with the NETWORK, allowing us to model the fact that packets are not instantaneously transferred in the wild. We use the shorthand CHAN!MSG to denote the event where MSG is sent over a channel CHAN ; it is contextually clear who sent or received the message. TCP exists in the *Transport Layer* of the internet, an upper layer reliant on the lower *Link Layer* and *Internet Layer*. We abstract the lower network stack layer TCP relies on with NETWORK, which passes messages between $1\text{TON} \parallel 2\text{TON}$ and $\text{NTO1} \parallel \text{NTO2}$. We model the peers symmetrically.

Given a property ϕ about TCP, we can formulate a threat model TM as follows, where we assume the adversary can exploit the lower layers of a network and ask if the adversary can induce TCP to violate ϕ : $\text{TM} = (\text{PEER 1} \parallel \text{PEER 2} \parallel 1\text{TON} \parallel 2\text{TON} \parallel \text{NTO1} \parallel \text{NTO2}, (\text{NETWORK}), \phi)$. We consider three properties ϕ_1, ϕ_2, ϕ_3 , giving rise to three threat models $\text{TM}_1, \text{TM}_2, \text{TM}_3$, respectively.

TM₁: No Half-Closed Connection Establishment The safety property ϕ_1 says that if PEER 1 is in Closed, then PEER 2 cannot be in Established.

$$\phi_1 = \mathbf{G}(\text{Closed}_1 \implies \neg \text{Established}_2) \quad (8)$$

KORG discovers an attacker that spoofs the active participant in an active-passive connection establishment (see message sequence chart in Fig. 10), as described in [15]. Note that our model does not capture message sequence numbers and in the real world the attacker also needs to guess the sequence number of the passive peer.

TM₂: Passive-Active Connection Establishment Eventually Succeeds The liveness property ϕ_2 says that if it is infinitely often true that PEER 1 is in Listen while PEER 2 is in SYN Sent, then it must eventually be true that PEER 1 is in Established.

$$\phi_2 = (\mathbf{GF}(\text{Listen}_1 \wedge \text{SYN Sent}_2)) \implies \mathbf{F} \text{Established}_1 \quad (9)$$

KORG discovers an attack where a SYN packet from PEER 2 is dropped. The corresponding attacker code is given in the PROMELA language of SPIN in Fig. 11. The attacker in Fig. 11 also induces deleterious behavior not captured by violation of ϕ_2 , where the system deadlocks in (SYN Sent, SYN Received).

TM₃: Peers Do Not Get Stuck The safety property ϕ_3 says that the two peers will never simultaneously deadlock outside their End states. Let S_i denote the set of states in Fig. 9 for PEER i , and $S'_i = S_i \setminus \{\text{End}\}$.

$$\phi_3 = \bigwedge_{s_1 \in S'_1} \bigwedge_{s_2 \in S'_2} \neg \mathbf{FG}(s_1 \wedge s_2) \quad (10)$$

For the problem with recovery, KORG discovers an attacker that selectively drops the ACK sent by PEER 1 as it transitions from i_0 to Established in an active/passive connection establishment routine, leaving PEER 2 stranded in SYN Received, leading to a violation of ϕ_3 . This type of packet-loss-induced deadlock is not uncommon in real-world TCP implementations, e.g. [32,34,17].

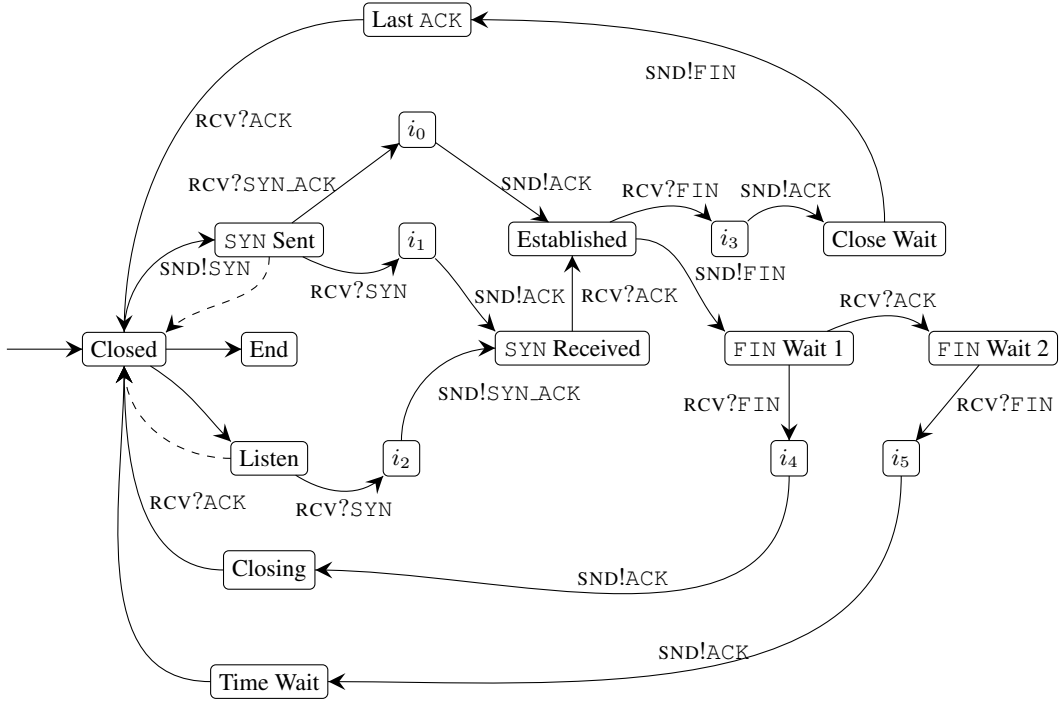

Fig. 9: A TCP peer. For $i = 1, 2$, if this is PEER i , then $SND := iTON$ and $RCV := NTOi$. All the states except i_0, \dots, i_5 , and End are from the finite state machine in the TCP RFC [36]. The RFC diagram omits the implicit states i_0, \dots, i_5 , instead combining send and receive events on individual transitions. In the RFC, Closed is called a “fictional state”, where no TCP exists. We add a state End to capture the difference between a machine that elects not to instantiate a peer and a machine that is turned off. We label each state s with a single atomic proposition s_i . Dashed transitions are *timeout transitions*, meaning they are taken when the rest of the system deadlocks.

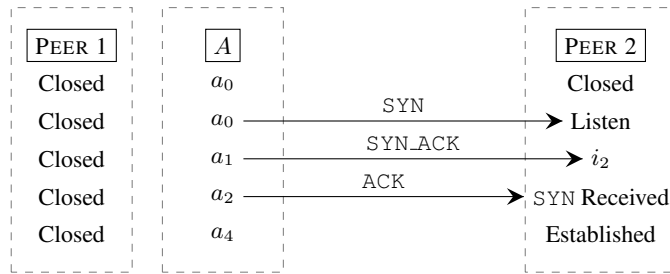

Fig. 10: Time progresses from top to bottom. Labeled arrows denote message exchanges over implicit channels. The property is violated in the final row; after this recovery may begin.

```
Nto1 ! ACK; Nto2 ! ACK; 2toN ? SYN; /* ... recovery ... */
```

Fig. 11: Body of PROMELA process for a TM_2 -attacker with recovery generated by KORG. PEER 2 transitions from Closed to SYN Sent and sends SYN to PEER 1. The attacker drops this packet so that it never reaches PEER 1. PEER 1 then transitions back and forth forever between Closed and Listen, and the property is violated. Because SPIN attempts to find counterexamples as quickly as possible, the counterexamples it produces are not in general minimal.

Threat Model	Runtime (s) (\exists ASP/R- \exists ASP)	Attackers Found
TM ₁	2.24 / 2.45	7 / 5
TM ₂	2.23 / 2.39	5 / 5
TM ₃	350.70 / 1378.99	4 / 5

Table 3: Column 2 captures the total average runtime in seconds over ten trials, each trial with ≤ 10 attackers synthesized, on a 16Gb 2018 quad-core Intel[®] Core[™] i7-8550U CPU running Linux Mint 19.3 Cinnamon. Column 3 denotes the number of unique attackers found across all ≤ 100 generated attackers for each threat model. For both Column 2 and Column 3, results are given in the format A/B , where A is the result for the \exists ASP and B is the result for R- \exists ASP. For example, in about 2.39 seconds KORG generates ten TM₂-attackers with recovery, and after repeating this process ten times for a total of 100 generated attackers, we find that about five are unique and the rest are duplicates. Note that this experiment was performed with the `characterize` flag set to False, meaning KORG does not automatically detect \forall -attackers in the results. Instructions and code to reproduce these results are given in the GitHub repository.

Performance Performance results for the above experiments are given in Table 3.

KORG is a prototype implementation, and is not optimized for speed. Nonetheless, KORG’s comparative performance across the three threat models is interesting. KORG took roughly $160\times$ longer to solve the \exists ASP and $570\times$ longer to solve the R- \exists ASP for TM₃ than it did for TM₁ and TM₂. The LTL model-checking problem is polynomial in the size of the model and exponential in the size of the LTL formula [42], and ϕ_3 is roughly $10\times$ larger than ϕ_2 or ϕ_3 . State compression and partial order reduction in SPIN may also contribute to differences in run-time.

We chose TCP connection establishment for our case study because it is simple and well-understood. Across three properties (two safety and one liveness), with and without recovery, KORG synthesized attackers exhibiting attack strategies that have worked or could work against some real-world TCP implementations, modulo sequence numbers. The synthesized attackers are simple, consisting of only a few lines of code, but our TCP model is also simple since we omitted sequence numbers, congestion control, and other details. Moving forward, we want to apply KORG to more complicated models and discover novel exploits.

6 Related Work

Prior works formalized security problems using game theory (e.g., FLIPIT [41], [24]), “weird machines” [10], attack trees [43], Markov models [40], and other methods. Prior notions of attacker quality include \mathcal{O} -complexity [9], expected information loss [38], or success probability [30], which is similar to our concept of \forall versus \exists -attackers. Attacker synthesis work exists in cyber-physical systems [33,5,20,26,30]. Most of these works define attacker success using bad states or information theory. Problems include the *actuator attacker synthesis problem* [27]; the *hardware-aware attacker synthesis problem* [39]; and the *fault-attacker synthesis problem* [6].

Maybe the most similar work to our own is PROVERIF [8], which verifies properties of, and generates attacks against, cryptographic protocols. We formalize the problem with operational semantics (processes) and reduce it to model checking, whereas PROVERIF uses axiomatic semantics (PROLOG clauses) and reduces it to automated proving. Another similar tool is NETSMC [45], a model-checker that efficiently finds counter-examples to security properties of stateful networks.

Existing techniques for automated attack discovery include state-machine-informed search [21], open-source-intelligence [44], bug analysis [19], and genetic programming [23]. Defensive synthesis also exists [3]. The generation of a failing test-case for a protocol property is not unlike attack discovery, so some testing literature is also related (e.g., [29]).

TCP was previously formally studied using a process language called SPEX [37], Petri nets [16], the HOL proof assistant [7], and various other algebras (see Table 2.2 in [28]). Our model is neither the most detailed nor the most comprehensive, but it captures all possible establishment and tear-down routines, and is tailored to our framework.

This paper focuses on attacker synthesis at the protocol level, and thus differs from the work reported in [22] in two ways: first, the work in [22] synthesizes mappings between high-level protocol models and execution platform models, thereby focusing on linking protocol design and implementation; second, the work in [22] synthesizes correct (secure) mappings, whereas we are interested in synthesizing attacks.

7 Conclusions and Future Work

We present a novel formal framework for automated attacker synthesis. The framework includes an explicit definition of threat models and four novel, to our knowledge, categories of attackers. We formulate four attacker synthesis problems, and propose solutions to two of them by reduction to model-checking and program transformations. We prove our solutions are both sound and complete; sketches of these proofs are provided in Section 4. Finally, we implement our solutions for the case of a centralized attacker in an open-source tool called KORG, and we apply KORG to the study of the TCP connection routine, and discuss the results. KORG and the TCP case study are freely and openly available at github.com/maxvonhippel/AttackerSynthesis.

In future work we want to solve the \forall ASP and the R- \forall ASP. We believe these problems can be reduced to distributed controller synthesis problems like the ones studied in [1]. Once we solve these problems we aim to implement our solutions in KORG; we also want to improve the performance of KORG and extend it to support distributed attackers. Finally, we intend to apply KORG to more complicated real-world systems and uncover novel vulnerabilities.

Acknowledgments

This material is based upon work supported by the National Science Foundation under NSF SaTC award CNS-1801546. Any opinions, findings, and conclusions or recommendations expressed in this material are those of the author(s) and do not necessarily reflect the views of the National Science Foundation. The first author would like to thank Benjamin Quiring for multiple illuminating discussions, Dr. Ming Li for suggesting relevant papers, and Dr. Frank von Hippel for editorial feedback.

References

1. Alur, R., Martin, M., Raghothaman, M., Stergiou, C., Tripakis, S., Udupa, A.: Synthesizing finite-state protocols from scenarios and requirements. In: Haifa Verification Conference. pp. 75–91. Springer (2014)
2. Alur, R., Tripakis, S.: Automatic synthesis of distributed protocols. *SIGACT News* **48**(1), 55–90 (2017)
3. Ardeshiricham, A., Takashima, Y., Gao, S., Kastner, R.: VeriSketch: Synthesizing secure hardware designs with timing-sensitive information flow properties. In: Proceedings of the 2019 ACM SIGSAC Conference on Computer and Communications Security. pp. 1623–1638 (2019)
4. Baier, C., Katoen, J.P.: Principles of model checking. MIT press (2008)
5. Bang, L., Rosner, N., Bultan, T.: Online synthesis of adaptive side-channel attacks based on noisy observations. In: 2018 IEEE European Symposium on Security and Privacy. pp. 307–322. IEEE (2018)
6. Barthe, G., Dupressoir, F., Fouque, P.A., Grégoire, B., Zapalowicz, J.C.: Synthesis of fault attacks on cryptographic implementations. In: Proceedings of the 2014 ACM SIGSAC Conference on Computer and Communications Security. pp. 1016–1027 (2014)
7. Bishop, S., Fairbairn, M., Mehnert, H., Norrish, M., Ridge, T., Sewell, P., Smith, M., Wansbrough, K.: Engineering with logic: Rigorous test-oracle specification and validation for TCP/IP and the sockets API. *Journal of the ACM* **66**(1), 1–77 (2018)
8. Blanchet, B.: An Efficient Cryptographic Protocol Verifier Based on Prolog Rules. In: 14th IEEE Computer Security Foundations Workshop. pp. 82–96. IEEE Computer Society, Cape Breton, Nova Scotia, Canada (Jun 2001)
9. Branco, R., Hu, K., Kawakami, H., Sun, K.: A mathematical modeling of exploitations and mitigation techniques using set theory. In: 2018 IEEE Security and Privacy Workshops (SPW). pp. 323–328. IEEE (2018)
10. Bratus, S., Locasto, M.E., Patterson, M.L., Sassaman, L., Shubina, A.: Exploit programming: From buffer overflows to weird machines and theory of computation. *USENIX; login* **36**(6) (2011)
11. Chong, S., Guttman, J., Datta, A., Myers, A., Pierce, B., Schaumont, P., Sherwood, T., Zeldovich, N.: Report on the NSF workshop on formal methods for security. (2016)
12. Dijkstra, E.W., et al.: Notes on structured programming (1970)
13. Duran, J.W., Ntafos, S.: A report on random testing. In: Proceedings of the 5th international conference on Software engineering. pp. 179–183. IEEE Press (1981)
14. Friedman, J.: Alonzo church. application of recursive arithmetic to the problem of circuit synthesis summaries of talks presented at the summer institute for symbolic logic cornell university, 1957, 2nd edn., communications research division, institute for defense analyses, princeton, nj, 1960, pp. 3–50. 3a-45a. *The Journal of Symbolic Logic* **28**(4), 289–290 (1963)

15. Friedrichs, O.: A simple TCP spoofing attack. citi.umich.edu/u/provos/papers/secnet-spoof.txt (February 1997), accessed: 3 January 2020
16. Han, B., Billington, J.: Termination properties of TCPs connection management procedures. In: International Conference on Application and Theory of Petri Nets. pp. 228–249. Springer (2005)
17. henryouly: [solved]TCP connection blocked in SYN_SENT status. bbs.archlinux.org/viewtopic.php?id=33875 (2007), accessed: 3 January 2020
18. Holzmann, G.: The Spin Model Checker. Addison-Wesley (2003)
19. Huang, S.K., Huang, M.H., Huang, P.Y., Lai, C.W., Lu, H.L., Leong, W.M.: Crax: Software crash analysis for automatic exploit generation by modeling attacks as symbolic continuations. In: 2012 IEEE Sixth International Conference on Software Security and Reliability. pp. 78–87. IEEE (2012)
20. Huang, Z., Etigowni, S., Garcia, L., Mitra, S., Zonouz, S.: Algorithmic attack synthesis using hybrid dynamics of power grid critical infrastructures. In: 2018 48th Annual IEEE/IFIP International Conference on Dependable Systems and Networks. pp. 151–162. IEEE (2018)
21. Jero, S., Lee, H., Nita-Rotaru, C.: Leveraging state information for automated attack discovery in transport protocol implementations. In: 2015 45th Annual IEEE/IFIP International Conference on Dependable Systems and Networks. pp. 1–12. IEEE (2015)
22. Kang, E., Lafortune, S., Tripakis, S.: Automated Synthesis of Secure Platform Mappings. In: Computer Aided Verification (CAV) (Jul 2019)
23. Kayacik, H.G., Zincir-Heywood, A.N., Heywood, M.I., Burschka, S.: Generating mimicry attacks using genetic programming: a benchmarking study. In: 2009 IEEE Symposium on Computational Intelligence in Cyber Security. pp. 136–143. IEEE (2009)
24. Klaška, D., Kučera, A., Lamser, T., Řehák, V.: Automatic synthesis of efficient regular strategies in adversarial patrolling games. In: Proceedings of the 17th International Conference on Autonomous Agents and MultiAgent Systems. pp. 659–666. International Foundation for Autonomous Agents and Multiagent Systems (2018)
25. Kripke, S.A.: Semantical considerations on modal logic. *Acta Philosophica Fennica* **16**(1963), 83–94 (1963)
26. Lin, L., Thuijsman, S., Zhu, Y., Ware, S., Su, R., Reniers, M.: Synthesis of supremal successful normal actuator attackers on normal supervisors. In: 2019 American Control Conference. pp. 5614–5619. IEEE (2019)
27. Lin, L., Zhu, Y., Su, R.: Synthesis of actuator attackers for free. arXiv preprint arXiv:1904.10159 (2019)
28. Lockefer, L., Williams, D.M., Fokkink, W.: Formal specification and verification of TCP extended with the window scale option. *Science of Computer Programming* **118**, 3–23 (2016)
29. McMillan, K.L., Zuck, L.D.: Formal specification and testing of QUIC. In: Proceedings of the ACM Special Interest Group on Data Communication, pp. 227–240. ACM (2019)
30. Meira-Góes, R., Kwong, R., Lafortune, S.: Synthesis of sensor deception attacks for systems modeled as probabilistic automata. In: 2019 American Control Conference. pp. 5620–5626. IEEE (2019)
31. Myers, G.J.: The art of software testing. John Wiley & Sons (1979)
32. Pfenerty: Tcp connections hang in SYN_SENT. experts-exchange.com/questions/21729170/TCP-connections-hang-in-SYN-SENT.html (February 2006), accessed: 3 January 2020
33. Phan, Q.S., Bang, L., Pasareanu, C.S., Malacaria, P., Bultan, T.: Synthesis of adaptive side-channel attacks. In: 2017 IEEE 30th Computer Security Foundations Symposium. pp. 328–342. IEEE (2017)
34. Philipp: Connection requests hang with SYN_SENT, after a few tries. superuser.com/q/725561/241104 (March 2014), accessed: 3 January 2020
35. Pnueli, A.: The temporal logic of programs. In: 18th Annual Symposium on Foundations of Computer Science. pp. 46–57. IEEE (1977)
36. Postel, J., et al.: Rfc 793 Transmission Control Protocol (September 1981)
37. Schwabe, D.: Formal specification and verification of a connection establishment protocol. *ACM SIGCOMM Computer Communication Review* **11**(4), 11–26 (1981)
38. Srivastava, H., Dwivedi, K., Pankaj, P.K., Tewari, V.: A formal attack centric framework highlighting expected losses of an information security breach. *International Journal of Computer Applications* **68**(17) (2013)
39. Trippel, C., Lustig, D., Martonosi, M.: Security verification via automatic hardware-aware exploit synthesis: The CheckMate approach. *IEEE Micro* **39**(3), 84–93 (2019)
40. Valizadeh, S., van Dijk, M.: Toward a theory of cyber attacks. arXiv preprint arXiv:1901.01598 (2019)
41. Van Dijk, M., Juels, A., Oprea, A., Rivest, R.L.: FlipIt: The game of stealthy takeover. *Journal of Cryptology* **26**(4), 655–713 (2013)
42. Vardi, M.Y., Wolper, P.: An automata-theoretic approach to automatic program verification. In: Proceedings of the First Symposium on Logic in Computer Science. pp. 322–331. IEEE Computer Society (1986)
43. Wideł, W., Audinot, M., Fila, B., Pinchinat, S.: Beyond 2014: Formal methods for attack tree-based security modeling. *ACM Computing Surveys* **52**(4), 1–36 (2019)

44. You, W., Zong, P., Chen, K., Wang, X., Liao, X., Bian, P., Liang, B.: Semfuzz: Semantics-based automatic generation of proof-of-concept exploits. In: Proceedings of the 2017 ACM SIGSAC Conference on Computer and Communications Security. pp. 2139–2154 (2017)
45. Yuan, Y., Moon, S.J., Uppal, S., Jia, L., Sekar, V.: NetSMC: A custom symbolic model checker for stateful network verification. In: 17th USENIX Symposium on Networked Systems Design and Implementation. USENIX Association, Santa Clara, CA (Feb 2020)