

A Deductive Verification Framework for Circuit-building Quantum Programs

CHRISTOPHE CHARETON, LRI, Centrale Supélec, Université Paris-Saclay, France

SÉBASTIEN BARDIN, CEA, LIST, Université Paris-Saclay, France

FRANÇOIS BOBOT, CEA, LIST, Université Paris-Saclay, France

VALENTIN PERRELLE, CEA, LIST, Université Paris-Saclay, France

BENOIT VALIRON, LRI, Centrale Supélec, Université Paris-Saclay, France

While recent progress in quantum hardware open the door for significant speedup in certain key areas, quantum algorithms are still hard to implement right, and the validation of such quantum programs is a challenge. Early attempts either suffer from the lack of automation or parametrized reasoning, or target high-level abstract algorithm description languages far from the current *de facto* consensus of *circuit-building quantum programming languages*. As a consequence, no significant quantum algorithm implementation has been currently verified in a scale-invariant manner. We propose QBRICKS, the first formal verification environment for circuit-building quantum programs, featuring clear separation between code and proof, parametric specifications and proofs, high degree of proof automation and allowing to encode quantum programs in a natural way, i.e. close to textbook style. QBRICKS builds on best practice of formal verification for the classical case and tailor them to the quantum case: we bring a new domain-specific circuit-building language for quantum programs, namely QBRICKS-DSL, together with a new logical specification language QBRICKS-SPEC and a dedicated Hoare-style deductive verification rule named Hybrid Quantum Hoare Logic. Especially, *we introduce and intensively build upon HOPS, a higher-order extension of the recent path-sum symbolic representation*, used for both *specification* (parametrized) and *automation* (closure properties).

To illustrate the opportunity of QBRICKS, we implement the first verified parametric implementations of several famous and non-trivial quantum algorithms, including the quantum part of Shor integer factoring (Order Finding – Shor-OF), quantum phase estimation (QPE) – a basic building block of many quantum algorithms, and Grover search. These breakthroughs were amply facilitated by the specification and automated deduction principles introduced within QBRICKS.

CCS Concepts: • **Software and its engineering** → **Formal language definitions**; • **Theory of computation** → **Semantics and reasoning**; • **Hardware** → **Quantum computation**.

Additional Key Words and Phrases: deductive verification, quantum programming, quantum circuits

1 INTRODUCTION

1.1 Quantum computing. Quantum computing is a young research field: its birth act is usually dated in 1982, when Feynman [25] raised the idea of simulating the quantum mechanics phenomena by storing information in particles and controlling them according to quantum mechanics laws. This initial idea has become one over many application fields for quantum computing, along with cryptography [66], deep learning [9], optimization [23, 24], solving linear systems [36], etc. In all these domains there are now quantum algorithms beating the best known classical algorithms by either quadratic or even exponential factors. In parallel to the rise of quantum algorithms, the design of quantum hardware has moved from lab-benches [15] to programmable, 50-qubits machines designed by industrial actors [4, 42] reaching the point where quantum computers would beat classical computers for specific tasks [4].

Authors' addresses: Christophe Chareton, LRI, Centrale Supélec, Université Paris-Saclay, France, christophe.chareton@lri.fr; Sébastien Bardin, CEA, LIST, Université Paris-Saclay, France, sebastien.bardin@cea.fr; François Bobot, CEA, LIST, Université Paris-Saclay, France, francois.bobot@cea.fr; Valentin Perrelle, CEA, LIST, Université Paris-Saclay, France, valentin.perrelle@cea.fr; Benoit Valiron, LRI, Centrale Supélec, Université Paris-Saclay, France, benoit.valiron@lri.fr.

This has stirred a shift from a theoretical standpoint on quantum algorithms to a more programming-oriented view with the question of their concrete coding and implementation [60, 70, 72].

In this context, a particularly important problem is the adequacy between the mathematical description of an algorithm and its concrete implementation as a program.

1.2 The hybrid model. The vast majority of quantum algorithms are described within the *quantum co-processor model* [47], i.e. an hybrid model where a *classical* computer controls a *quantum* co-processor holding a quantum memory (cf. Figure 1). The co-processor is able to apply a fixed set of elementary operations (buffered as *quantum circuits*) to update and query (*measure*) the quantum memory. Importantly, while measurement allows to retrieve classical (probabilistic) information from the quantum memory, it also modifies it (*destructive effect*). The state of the quantum memory is represented by a linear combination of possible concrete values – generalizing the classical notion of probabilities to the complex case, and the core of a quantum algorithm consists in successfully setting the memory in a specific *quantum state*.

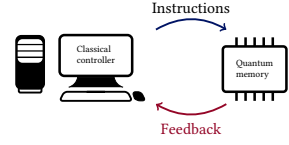

Fig. 1. Scheme of the hybrid model

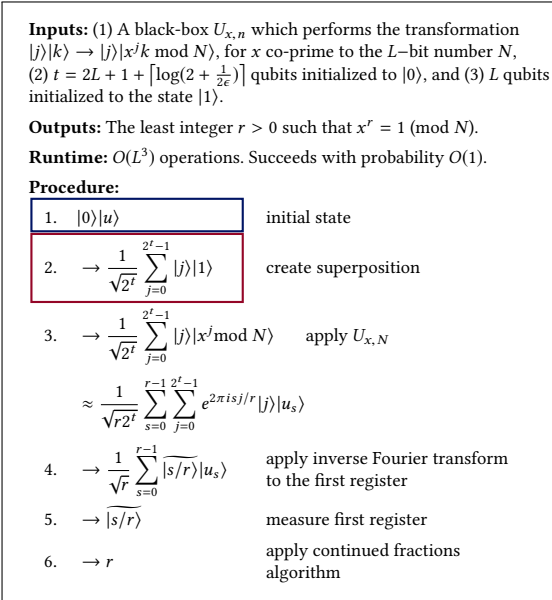

Fig. 2. Bird eye view of Shor [66]’s factoring algorithm (as presented in [54, p. 232])

Major *quantum programming languages* such as Quipper [33], Liqui|⟩ [73], Q# [69], ProjectQ [68], Silq [10], and the rich ecosystem of existing quantum programming frameworks [60] follow this hybrid model and provide dedicated features for interacting with the quantum memory and well-suited for implementing quantum algorithms. They usually embed these features within a standard classical programming language, with forth (send quantum instructions) and backs (get measurement results) between the classical control loop (classical computer) and the quantum part (co-processor). Such *circuit-building quantum languages* are the current consensus for high-level executable quantum programming languages.

1.3 The problem with quantum algorithms.

The core of a quantum algorithm –the interaction with the quantum co-processor– is usually provided in the form of Figure 2. Starting from an initial state, the algorithm describes a series of high-level operations which, once composed, realize the desired state. This state is then usually measured to retrieve a classical information. Each high-level operation may itself be described in a similar way, until one reaches elementary operations. The benefit for using the quantum algorithm instead of a classical counterpart lies in the fact that the number of elementary operations is small. The description of

the algorithm is therefore both the specification — the global memory-state transformation — and the way to realize it — the list of elementary operations, or *quantum circuit*.

A major issue is then to verify that the circuit generated by the code written as an implementation of a given algorithm is indeed a run of this algorithm, and that the circuit has indeed the specified size.

1.4 The case for quantum formal verification. While testing and debugging are the common verification practice in classical programming, they become extremely complicated in the quantum case. Indeed, debugging and assertion checking are essentially impossible due to the destructive aspect of quantum measurement. Moreover, the probabilistic nature of quantum algorithms seriously impedes system-level quantum testing. Finally, classical emulation of quantum algorithms is (strongly believed to be) intractable.

On the other hand, nothing prevents *a priori* the formal verification of quantum programs. Formal methods and formal verification [16] design a wide range of techniques aiming at proving the correctness of a system with absolute, mathematical guarantee — reasoning over all possible inputs and paths of the system, with methods drawn from logic, automated reasoning and program analysis. The last two decades have seen an extraordinary blooming of the field, with significant case-studies ranging from pure mathematics [32] to complete software architectures [46, 49] and industrial systems [7, 19]. In addition to offering an alternative to testing, formal verification has in principle the decisive additional advantages to both enable parametric proof certificates and offer once-for-all absolute guarantees for the correctness of programs.

We will focus on *deductive verification* [5, 26, 27, 39], that, we argue, is well suited for quantum formal verification (cf. Section 4).

1.5 Goal and challenges. *Our goal is to provide a formal development framework for circuit-building quantum programs, including specification, programming and verification.* Such a framework should satisfy the following principles.

Close to algorithmic description. It should enable to specify and code algorithms in a way that directly matches their usual description from the literature, in order both to lower implementation & certification time and to increase confidence in the specification.

Separation of concerns. It should enable a clear distinction between code and specification, in order to decouple implementation from certification — in particular, specification should be optional and it should be possible to add it to a program at a later stage.

Parametricity. It should allow parametric (i.e. scale-invariant) specifications and proofs, so as to enable the generic specification and verification of parametrized algorithms. This is crucial as quantum algorithms always describe *parametrized families* of circuits.

Proof automation. It should, as far as possible, provide automatic proof means. Indeed, program verification should be as painless as possible to the programmer in order to be adopted.

These requirements raise several challenges from the formal verification point of view. Indeed, while questions about semantics, properties, specification and efficient verification algorithms have been largely investigated in the standard case, everything remains to be done in the quantum case. For example:

Non-standard data: Quantum algorithms rely heavily on *amplitudes* (generalization of probabilities to arbitrary *complex numbers*), not studied at all in standard verification;

Second-order reasoning: We are interested here in *parametrized circuit-building programs*, i.e. programs that describe *families* of circuits meeting some postcondition — this is somehow akin to addressing dynamic code (i.e., jit) in the classical case.

The major scientific questions at stake here are: (1) How to specify quantum programs in a natural way? (2) How to support efficient proof automation for quantum programs?

	1.	2.	3.	4.	5.	QBRICKS
• Circuit-building language	x	x	o	o	o	o
• Scale invariance (parametric)	o	x	o	o	x	o
• Proof automation	o	o	x	x	o	o
• Separate specification from code	o	o	x	o	x	o
• Specifications fitting algorithm	x	x	x	x	o	o

Table 3. Formal verification of quantum programs

1. QHL [50]
2. QMC [29, 76]
3. [12]
4. Qwire [37, 58, 63]
5. Path-sums [1, 2] We omit [50] as their high-level formalism is not circuit-based

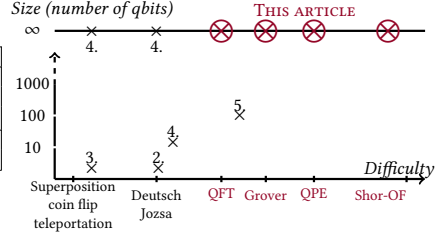

Fig. 4. Certified quantum circuits from the literature

As a matter of fact, prior works on quantum formal verification do not fully reach these goals.

1.6 Prior attempts. We summarize in Table 3 the state of the art against the requirements laid above for proving properties of quantum programs, while Figure 4 plots the success of the existing methods against scale-sensitivity and algorithm difficulty. Model-checking approaches [29, 76] are fully automatic but highly scale-sensitive. Other methods are based on interactive proofs through proof assistants, for instance Coq. One can cite the approach of Boender et al. [12] or Qwire [58, 63]. These however lack automation and deeply mix code and specification. Moreover, the underlying matrix semantics impedes scalability of the approach — so far it came only with small case-studies: coin_flip [61], teleportation [12], and (recently) Deutsch-Jozsa¹ algorithm [37]. Recently, Amy [1, 2] developed a powerful framework for reasoning over quantum circuits, the path-sums symbolic representation. Thanks to their good closure properties, reasoning with path-sums is well automated and can scale up to large problem instances (up to 100 qubits). Yet, the method is not parametric and only addresses fixed-size circuits.

Another explored direction tackles the formalization of *quantum programs with classical control*, where the input/outputs from the quantum co-processor are taken as oracles. Initiated by [74], this line of work does not consider circuit-building languages but rather high-level algorithmic models where quantum circuits are directly given as partial density operators of arbitrary size rather than built from elementary components — somehow, this is akin to verifying an algorithm expressed over sets versus verifying an implementation of the said algorithm working over red-black trees. It uses an extension of Hoare Logic, called Quantum Hoare Logic and designed for the specification of quantum programs as mathematical objects. Recently, the authors focused on the definition, automatic generation [77] and proof support [51, 75] for loop invariants in quantum programs invariants. In [50] the authors present a formalization of QHL in Isabelle/HOL and illustrate it on a restricted case of Grover algorithm.

1.7 Proposal and contributions. We propose QBRICKS, the first formal verification environment for circuit-building quantum programs, featuring clear separation between code and proof, parametric specification and proof, high degree of proof automation and allowing to encode quantum programs in a natural way, i.e. close to textbook style. QBRICKS builds on best practice from formal verification for the classical case (separation of concerns, flexible logical specification language, proof automation, domain-based specialization) and tailors them to the quantum case.

More precisely, while relying on the general framework of deductive verification, we tailor it to the specific needs of quantum, bringing several key innovations along the road. QBRICKS builds

¹ Deutsch-Jozsa consists in deciding, given an integer function that is known to be either constant or balanced, which case it is. It has no practical application and only serves as an easy-to-understand illustration for quantum speedup in introductory courses. We see it as a toy example — especially compared to Grover, QPE or Shor-OF.

upon the circuit-building, first-order functional language QBRICKS-DSL together with the logical specification language QBRICKS-SPEC. While minimal, QBRICKS-DSL can express implementations of existing non-trivial quantum algorithms and QBRICKS-SPEC is expressive enough to offer *higher-order* specification (parametrized circuit production). The two *key cornerstones* behind QBRICKS are: (1) a new Hoare-style proof system, called *Hybrid Quantum Hoare Logic (HQHL)* dedicated to circuit-building quantum languages, and (2) the new *higher-order path-sums (HOPS)* symbolic representation of quantum states, extending path-sums Amy [1] to the parametric case while keeping good closure properties – HOPS prove extremely useful both as a specification mechanism and as an automation mechanism.

In the end, we bring the following contributions.

Framework. A programming and verification framework, that is: on one hand, a core domain-specific language (QBRICKS-DSL, Section 5) for describing families of quantum circuits, with enough expressive power to describe parametric circuits from non-trivial quantum algorithm; on the other hand, a logical, domain-specific, specification language (QBRICKS-SPEC, Section 6), tightly integrated with QBRICKS-DSL to specify properties of parametrized programs representing families of quantum circuits.

Higher-Order Path-Sums. A flexible symbolic representation for reasoning about quantum states, integrated with QBRICKS-SPEC and building upon the recent path-sum symbolic representation [1, 2]. Our representation, called *higher-order path-sums (HOPS)*, retains the compositional and closure properties of regular path-sums while allowing *genericity* and *parametricity* of both specifications and proofs: HOPS expressions not only contain regular path-sum constructs but also terms from QBRICKS-DSL. Especially, HOPS provides a unified and powerful way to reason about many essential quantum concepts (Section 6).

Dedicated Proof Engine. We introduce the Hybrid Quantum Hoare Logic (HQHL) deduction system for deductive verification over circuit-building quantum programs – tightly coupled with HOPS and producing proof obligations in the QBRICKS-SPEC logic, together with deduction abilities dedicated to standard quantum structures (Section 7).

Implementation. This framework is embedded in the Why3 deductive verification tool [11, 27] as a DSL, and provides proof automation mechanisms dedicated to the quantum case – this material is grounded in standard mathematics theories – linear algebra, arithmetic, complex numbers, binary operations, *etc.* – with 450+ definitions and 1,000+ lemmas (Table 23). The Why3 embedding comes with a series of semantic shortcuts designed to increase the overall level of proof automation, based on high-level composition rules and circuit subclasses with simple HOPS semantics (Section 8).

Case studies. We present in Section 9 verified parametric implementations of the quantum part of [66]’s factoring algorithm (Order Finding –Shor-OF), Quantum Phase Estimation (QPE) [17, 45]², Grover algorithm [34] (search) and Quantum Fourier Transform (QFT) – all of them being much more complex than previous formally verified circuit-building implementations. Comparison with alternative approaches demonstrate a clear gain in proof effort (on Grover, factor 5 vs. the restricted proof on a high-level algorithm model [50]), while our method achieves a high level of proof automation (95% on Shor-OF). Moreover, we are also able for Shor-OF to prove the polynomial complexity of the circuits produced by our implementation.

1.8 Discussion. The scope of this paper is limited to proving properties of circuit-building quantum programs. We do not claim to support right now the interactions between classical data and quantum data (referred to as “classical control” in the literature), nor the probabilistic side-effect

²QPE is a major quantum building block, at the heart of, e.g., HHL [36] logarithmic linear system solving algorithm or quantum simulation [30].

resulting from the measurement. Still, we are already able to target realistic implementations of famous quantum algorithms, and thanks to equational theories for complex and real number we can *reason* on the probabilistic outcome of a measurement.

Also, we do not claim any novelty in the proofs for Shor-OF, QPE or Grover by themselves, but rather the first parametric correctness proofs of the circuits produced by programs implementing Shor-OF, QPE or Grover.

That said, *we present the first non trivial, automated, parametric proofs of significant circuit-building quantum programs, where prior works were limited to toy examples, establishing a new baseline for quantum verification of realistic programs.*

2 BACKGROUND: QUANTUM ALGORITHMS AND PROGRAMS

While in classical computing, the state of a bit is either 0 or 1, in quantum computing [54] the state of a *quantum bit* (or *qubit*) is described by *amplitudes* over the two elementary values 0 and 1 (denoted in the Dirac notation with $|0\rangle$ and $|1\rangle$), i.e. linear combinations $\alpha_0|0\rangle + \alpha_1|1\rangle$ where α_0 and α_1 are any *complex values* satisfying $|\alpha_0|^2 + |\alpha_1|^2 = 1$. In a sense, amplitudes are generalization of probabilities.

More generally, the state of a *qubit register* of n qubits (“qubit-vector”) is any *superposition* of the 2^n elementary bit-vectors (“basis element”, where a bit-vector $k \in \{0..2^n - 1\}$ is denoted $|k\rangle_n$), that is any $|u\rangle_n = \sum_{k=0}^{2^n-1} \alpha_k |k\rangle_n$ such that $\sum_{k=0}^{2^n-1} |\alpha_k|^2 = 1$. For example, in the case of two qubits, the basis is $|00\rangle$, $|01\rangle$, $|10\rangle$ and $|11\rangle$ (also abbreviated $|0\rangle_2$, $|1\rangle_2$, $|2\rangle_2$ and $|3\rangle_2$). Such a (quantum state) vector $|k\rangle_n$ is called a *ket* of length n (and dimension 2^n).

Technically speaking, we say that the quantum state of a register of n qubits is represented by a normalized vector in a Hilbert space of finite dimension 2^n (a.k.a. finite-dimensional Hilbert space), whose basis is generated by the Kronecker product (a.k.a. tensor product, denoted \otimes) over the elementary bit-vectors. For instance, for $n = 2$: $|0\rangle \otimes |0\rangle$, $|0\rangle \otimes |1\rangle$, $|1\rangle \otimes |0\rangle$ and $|1\rangle \otimes |1\rangle$ act as definitions for $|00\rangle$, $|01\rangle$, $|10\rangle$ and $|11\rangle$.

2.1 Quantum Data Manipulation. The core of a quantum algorithm consists in manipulating a qubit register through two main classes of operations. (1) *Quantum gate*. Local operation on a fixed number of qubits, whose action consists in the application of a *unitary map* to the corresponding quantum state vector i.e. a linear and bijective operation preserving norm and orthogonality. The fact that unitary maps are bijective ensures that every unitary gate admits an *inverse*. Unitary maps over n qubits are usually represented as $2^n \times 2^n$ *matrices*. (2) *Measurement*. The retrieval of classical information out of the quantum memory. This operation is probabilistic and modifies the global state of the system: measuring the n -qubit system $\sum_{k=0}^{2^n-1} \alpha_k |k\rangle_n$ returns the bit-vector k of length n with probability $|\alpha_k|^2$.

Quantum gates might be applied in *sequence* or in *parallel*: sequence application corresponds to *map composition* (or, equivalently, matrix multiplication), while parallel application corresponds to the *Kronecker product*, or tensor product, of the original maps — or, equivalently, the Kronecker product of their matrix representations.³

³Given two matrices A and B with respectively $r(A)$ and $r(B)$ rows and $c(A)$ and $c(B)$ columns, their Kronecker product is the matrix $A \otimes B = \begin{pmatrix} a_{11}B & & \dots & a_{c(A)}B \\ \vdots & \ddots & & \vdots \\ a_{r(A)1}B & & \dots & a_{r(A)c(A)}B \end{pmatrix}$. This operation is central in quantum information representation. It enjoys a number of useful algebraic properties such as associativity, bilinearity or the equality $(A \otimes B) \cdot (C \otimes D) = (A \cdot C) \otimes (B \cdot D)$ for any matrices A, B, C, D of adequate sizes – where \cdot denotes matrix multiplication.

2.2 Quantum Circuits. In a way similar to classical Boolean functions, the application of quantum gates can be written in a diagrammatic notation: *quantum circuits*. Qubits are represented with horizontal wires and gates with boxes. Circuits are built *compositionally*, from a given set of *atomic gates* and by a small set of *circuit combinators*, including: parallel and sequential compositions, circuit inverting, controlling, iteration, etc.

As an example of a quantum circuit, we show in Figure 5 the bird-eye view of the circuit of QPE, the (quantum) phase estimation algorithm, a standard primitive in many quantum algorithms. QPE is parametrized by n (a number of wires) and U (a unitary – the *oracle*) and is built as follows. First, a register of n qubits is initialized in state $|0\rangle$, while another one is initialized in state $|v\rangle_n$. Then comes the circuit itself: a structured sequence of quantum gates, using the unary Hadamard gate H and the circuits U^{2^i} (realizing U to the power 2^i) and $\text{inverse(QFT}(n))$ – the reversed Quantum Fourier Transform. Both are defined as sub-circuits in a similar way.

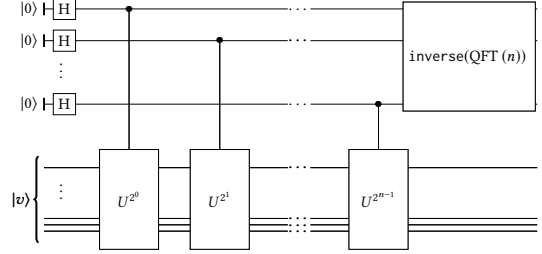

Fig. 5. The circuit for QPE

For the purpose of the current discussion, one should simply note two things: (1) the circuit is made of parallel compositions of Hadamard gates and of sequential compositions of controlled U^{2^i} (the controlled operation is depicted with vertical lines and symbol \bullet); (2) the circuit is *parametrized* by n and by U . This is very common: in general, a quantum algorithm constructs a circuit whose size and shape depend on the parameters of the problem. It describes a *family of quantum circuits*.

2.3 Quantum algorithms. Quantum algorithms intend to solve classical problems in a probabilistic way, but with better performance than with classical algorithms. They generally consist in the generation of a quantum circuit based on the problem parameters (e.g. the size of the instance), usually followed by iterating the following three steps: (1) memory initialization, (2) run of the quantum circuit, (3) measure of the memory to retrieve a classical piece of data.

The quantum circuit is seen as a predictive tool that probabilistically gives some (classical) information from which one can infer the targeted result. The fact that the probability is high enough is a direct consequence of the mathematical properties of the unitary map described by the quantum circuit. The essence of the quantum algorithm –and the reason for its efficiency– consists in describing an efficient circuit realizing this unitary map.

Obtaining guarantees on the families of circuits realized by quantum programs is therefore of uttermost importance.

We use the following famous quantum algorithms throughout the article:

- Phase Estimation algorithm (QPE) [17, 45]: takes as parameter a matrix U , an eigenvector $|v\rangle$ and answers the eigenvalue of U corresponding to $|v\rangle$. While the algorithm answers in a deterministic way for some sub-cases, in general it only answers up to some probability.
- Grover [34]’s search algorithm: given a sparse non-zero function $f : \{0 \dots 2^n - 1\} \rightarrow \{0, 1\}$, Grover’s algorithm outputs one value x such that $f(x) = 1$ with a probability high-enough to beat brute-force search.
- Shor [66]’s factoring algorithm: We consider the quantum part of the algorithm: the Order Finding algorithm. *We shall refer to it as Shor-OF*. Concretely, given a non prime integer N and a co-prime x , it outputs a period for x modulo N , in time $\text{POLYLOG}(N)$ and probability of

success $O(1)$. It is based on an application of QPE with a modular multiplication operator as oracle.

2.4 Existing quantum programming languages: the circuit-building paradigm. The standard model for quantum computation is the *quantum co-processor model*: the quantum memory is stored in a dedicated co-processor that the classical computer accesses through a dedicated interface. This distinction between purely classical computation and manipulation of quantum data is well-suited for most of the existing quantum algorithms. Indeed, they usually consist in two main parts: a classical part, for dealing with classical information and circuit-building, and a quantum part, where the circuit is sent to the quantum co-processor.

Quantum programming languages follow this pattern: they usually come up as domain-specific languages embedded in a classical computing framework: The interaction with the quantum co-processor is handled through an interface allowing for qubit initializations, measurements and elementary quantum gates. Elementary quantum gates are usually buffered into circuits before being sent to the co-processor. Each language then has its own design-choices on how to present the circuit to the programmer and which native circuit-manipulation library to offer.

The bottom line is that, regardless of the language-design choices, the core of a quantum programming language is to offer circuit-building and circuit manipulation operators in order to build as naturally as possible the circuits given in the descriptions of quantum algorithms from the literature.

2.5 Path-Sum Representation. Historically the semantics for quantum circuits has been given in term of unitary matrices [54] acting on Hilbert spaces, that is, the canonical mathematical formalism for quantum computation. If this semantics is well-adapted for representing simple high-level circuit combinators such as the action of control or inversion, it is cumbersome for specifying the semantics of general circuits.

Path sums [1, 2] is a recent symbolic representation that has been shown successful for proving *equivalence* of general quantum circuits. Its strength is to formalize the notation used in e.g. Figure 2. The path-sum of a unitary matrix U is then written as $U : |x\rangle \mapsto PS(x)$ where x is a list of booleans. $PS(x)$ is defined with the syntax of Figure 6. The $P_k(x)$ are called *phase polynomials* while the $|\phi_k(x)\rangle$ are *basis-kets*.

This representation is *closed* under functional composition and Kronecker product. For instance, if V sends y to $PS'(y) = \frac{1}{\sqrt{2}^{n'}} \sum_{k=0}^{2^{n'}-1} \exp\left(\frac{2 \cdot \pi \cdot i \cdot P'_k(y)}{2^{m'}}, then $U \otimes V$ sends $|x\rangle \otimes |y\rangle$ to$

$$\frac{1}{\sqrt{2}^{n+n'}} \sum_{j=0}^{2^{n+n'}-1} e^{\frac{2 \cdot \pi \cdot i (2^{m'} \cdot P_{j/2^n}(x) + 2^m \cdot P'_{j\%2^n}(y))}{2^{m+m'}}} |\phi_{j/2^n}(x)\rangle \otimes |\phi'_{j\%2^n}(y)\rangle \quad (1)$$

that is in the form shown in Figure 6. However, if it has been shown successful to prove the equivalence of large circuit instances [2], its main limitation stands in the fact that path-sum only address fixed-size circuits. Albeit a useful, compositional tool, it cannot be used for proving properties of parametrized circuit-building quantum programs.

This paper proposes an extension of path-sum semantics to address the parametric verification of general quantum programs.

3 MOTIVATING EXAMPLE

Let us consider the n -indexed family of circuits consisting of n Hadamard gates, in sequence, as shown in Figure 7. Sequencing two Hadamard gates can easily be shown equivalent to the identity operation. In other word, when fed with $|0\rangle$, if n is even the circuit outputs $|0\rangle$.

$$\begin{aligned}
PS(x) &::= \frac{1}{\sqrt{2}^n} \sum_{k=0}^{2^n-1} e^{\frac{2 \cdot \pi \cdot i \cdot P_k(x)}{2^m}} |\phi_k(x)\rangle \\
P_k(x) &::= x_i \mid n \mid P_1(x) \cdot P_2(x) \mid P_1(x) + P_2(x) \\
|\phi_k(x)\rangle &::= |b_1(x)\rangle \otimes \dots \otimes |b_n(x)\rangle \\
b_i(x) &::= x_i \mid \neg b(x) \mid b_1(x) \wedge b_2(x) \mid b_1(x) \oplus b_2(x) \mid \text{true} \mid \text{false}
\end{aligned}$$

Fig. 6. Syntax for regular path-sums [1, 2]

Albeit small, this circuit family together with its simple specification exemplifies the typical framework we aim at in the context of certification of circuit-building quantum programs:

- The description of the circuit family is parametrized by a classical parameter (here, the non-negative integer n);
- The pre-condition imposes both constraints (here, the evenness of n) and soundness conditions (here, the non-negativeness of n) on the parameters;
- The post-condition can both refer to the semantics of the circuit result and to its form and shape (here, its size).

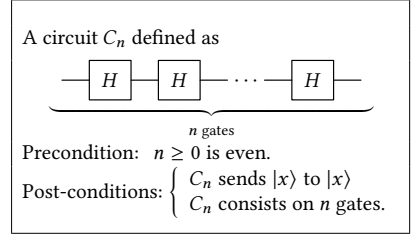

Fig. 7. Motivating Example

Shortcomings of existing approaches. In order to prove program specifications, the literature offers several methods and tools, yet none of them fits our needs here.

(1) In the expressive Qwire environment [58, 63] embedded in Coq, the semantics of quantum programs is based on matrices over complex numbers. If this toy motivating example would be definable, the drawbacks of this approach is in general its lack of scalability and automation. (2) The quantum Hoare logic environment embedded in Isabelle/HOL [50] offers a high-level abstract view of quantum programs – especially it does not offer circuits *per se*. It is thus not well-suited to detail the fine-grained description of circuit-building implementations, in particular the procedural description of a purely unitary circuit. Coding the toy example in Figure 7 would be extremely ad-hoc and complicated as the framework does not natively offer elementary gates nor iteration over classical integers. (3) The last possibility would be to use path-sums [2]: this framework is scalable and well-suited for sequence of gates, but limited to *fixed-size* circuits, while we target programs building families of circuits.

It is to be noted that none of these approaches offer the possibility to reason about the size of the produced circuit: either there is no such notion of circuit [50], or the circuit is not an object one can reason on [2, 58, 63].

By contrast, our own method allows to encode the Hadamard example in QBRICKS with 2 lines of codes and 11 lines of specification. Our deduction verification engine then produces 18 proof obligations (ensuring the contract and circuit well-formedness) simple enough so that all of them are automatically discharged by automated provers.

The circuit family presented in Figure 7 will be used in the rest of the paper as a running, toy example for QBRICKS. In particular, we show in Example 5.1 how to code it in our framework and how to express the specification in Example 6.2.

Target for QBRICKS. The goal of QBRICKS is to offer a formal verification framework for realistic circuit-building quantum programs, including parametric specification and proofs. We ultimately demonstrate this ability in Section 9 on implementations of Grover, QPE and Shor-OF – the experimental data are discussed in Section 9.

4 OUR PROPOSAL FOR CERTIFIED QUANTUM PROGRAMS

A common way to describe quantum algorithms in the literature is to declare, or describe, either semi-formally or in natural language, a sequence of unitary operations to be implemented, intercrossed with a sequence of formal assertions describing the evolution of the state of the system along the performance of these functions. The example in Figure 2 illustrates this case: it corresponds to the exact description of the circuit for Shor’s algorithm at it is written in [54, p. 232]. The formal description of state, left column in Figure 2, is interpretable as specifications for the operations declared in the right column. For example, operation *create superposition* is declared on the right column, line 1. We interpret the formal expression of line 1, left (framed in blue), as its precondition and the one of line 2, left (framed in red), as its post-condition.

Our key observation is that standard quantum algorithm descriptions match perfectly with the process of deductive program verification [26, 39], a well established formal method.

4.1 Deductive verification for quantum programs. *Deductive program verification* [5, 26, 27, 39] is probably the oldest formal method technique, dating back to 1969 [39]. In this approach, programs are *annotated* with *logical assertions*, such as pre- and post-conditions for operations or loop invariants, then so-called *proof obligations* are automatically generated (e.g., by the weakest precondition algorithm) in such a way that proving (a.k.a. discharging) them ensures that the logical assertions hold along any execution of the program. These proof obligations are commonly proven by help of proof assistants or automatic solvers.

In more details, for any function f , annotations by precondition pre and postcondition $post$ are to be understood as a contract for the implementation: the programmer commits to ensuring that the output of f satisfies $post$ for any input satisfying pre , which, in essence, translates into

$$\forall x. pre(x) \rightarrow post(f(x))$$

Suppose that the function f is defined, specified and verified. And suppose one defines and specifies a further function g , using a call $f(a)$ to f . This generates a new proof obligation. To fulfill it, the already verified proof obligation for f is assumed as an hypothesis.

This compositional reasoning method is particularly well-suited to the compositional nature of circuits.

4.2 Rational for the design of QBRICKS. We adopt the methodology presented in Section 4.1 and adapt the key ingredients of deductive verification to the case of circuit-building quantum programs. Hence, QBRICKS is equipped with: a domain specific language (DSL) for building circuit families, a dedicated logical specification language, a novel symbolic representation (HOPS) and a new Hoare-style logic –called *Hybrid Quantum Hoare Logic (HQHL)*.

Circuit representation. The language QBRICKS-DSL is only aimed at implementing quantum algorithms and specifications provided in the form of Figure 2. The circuits used in quantum algorithms act in general on contiguous blocks of memory registers and consist of simple compositions and hierarchical descriptions. Thus, unlike existing quantum programming languages such as Quipper [33] or Qwire [58], for QBRICKS there is no need for complex wire manipulation.

Following this analysis, the low-level circuit-representation we choose as a target QBRICKS is akin to the one of qPCF [56]: a circuit is a simple compositional structure consisting of base gates

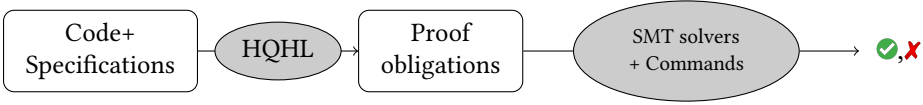

Fig. 8. Overview of QBRICKS certified implementation process

and circuit combinators such as sequential and parallel composition, control, inversion, etc. These constructions are packaged withing a domain-specific language (DSL) aimed at describing families of circuits.

Symbolic representation of quantum circuits. As mentioned in Section 2.5, if path-sums offer a compositional specification framework, they address the case of fixed-size circuits. In particular, one cannot give specification to general, parametrized programs describing families of circuits.

QBRICKS proposes a solution to this limitation, by unifying what can be done with the matrix and the path-sum semantics. Our proposal is a *higher-order path-sum semantics (HOPS)*. On one hand, we keep the functional view on the action of circuits on quantum registers, making it suitable for deductive verification. On the other hand, we *extend* its syntax to support parametric circuit construction, high-level circuit combinators and reference to QBRICKS-DSL constructs.

Specification and verification. It turns out that HOPS offer a very convenient specification mechanism for quantum programs. They form the bedrock of the QBRICKS-DSL specification language – together with a few other theories such as bit-vectors, integers or complex values.

It also turns out that HOPS are convenient for verification purpose too: we design a proof-obligation generation procedure within HQHL dedicated to circuit-building quantum languages, yielding proof obligations in the QBRICKS-DSL (first-order) logic.

Finally, while part of the QBRICKS-DSL logic can be directly handled by automated solvers (such as SMT), we add dedicated equational theories and axioms for those parts of the logic (e.g., HOPS manipulation or complex values).

Implementation. We implement QBRICKS as a domain-specific language embedded in the Why3 deductive verification tool [11, 27], allowing to take advantage of its advanced programming, specification and verification features for classical programs. We add all quantum-related features on top of it.

An overview of QBRICKS certified implementation process is depicted in Figure 8: the user writes a QBRICKS-DSL programs together with QBRICKS-SPEC specifications. Our HQHL engine produces proof obligations in QBRICKS-DSL logic. Taking advantage of the interface provided by Why3 embedding, the user can either directly send these proof obligations to a series of SMT-solvers for validation, together with our circuits specifications equational theories, or facilitate solving by use of a series of interactive predicate transformation commands (such as introduction of lemmas or hypotheses, beta-reduction, etc).

5 QBRICKS-DSL

QBRICKS is structured as a domain-specific language (DSL), called QBRICKS-DSL, and a domain-specific logical specification language called QBRICKS-SPEC. The language is targeted for *circuit description*: measurement is out of the scope of the language, and all QBRICKS-DSL expressions are terminating. We follow a very simple strategy for circuit building: we use a regular inductive datatype for circuits, where the data constructors are elementary gates, sequential and parallel composition, and ancilla creation. In particular, unlike e.g. Quipper or Qwire, a quantum circuit is not a function acting on qubits: it is a simple, static object. Nonetheless, for the sake of implementing

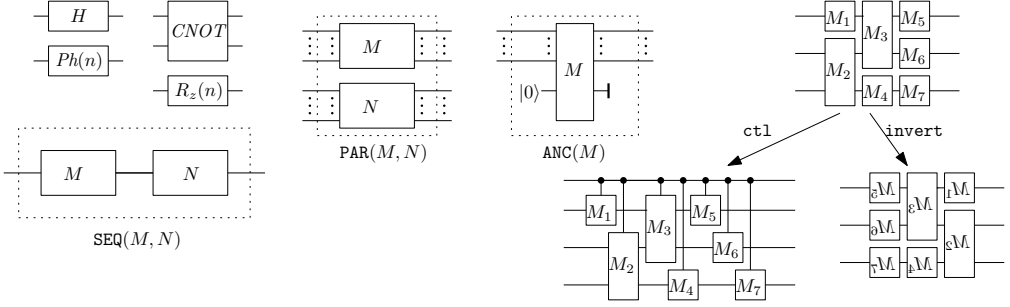

Fig. 9. Circuit combinators

quantum circuits from the literature this does not restrict expressivity as they are usually precisely represented as sequences of blocks.

Even if the language does not feature measurement, it is nonetheless possible to *reason* on probabilistic outputs of circuits, if we were to measure the result of a circuit. Indeed, this can be expressed in a regular theory of real and complex numbers.

QBRICKS-DSL is designed as a first-order, functional language: for the purpose of circuit construction, this is enough and designing a deductive system for it can then be done in a canonical way, following e.g. Why3 strategy. Similarly, the specification language QBRICKS-SPEC is a first-order predicate language, equipped with various equational theories. This makes proof-obligations more easily amenable to automated solvers.

In the rest of this section, we present the language QBRICKS-DSL. Section 6 is then devoted to QBRICKS-SPEC while Section 7 to the deduction rules.

5.1 Syntax of QBRICKS-DSL. The DSL QBRICKS-DSL is a small first-order functional, call-by-value language with a special datatype `circ` as the media to build and manipulate circuits. The core of QBRICKS-DSL can be presented as a simply-typed calculus, presented in Figure 10. The basic data constructors for `circ` are CNOT, SWAP, ID, H, $\text{Ph}(e)$ and $R_z(e)$ (see Table 16 in the Appendix for their semantics). The constructor for high-level circuit operations are sequential composition `SEQ`, parallel composition `PAR` and ancilla creation/termination `ANC` (see Figure 9 for details).

On top of `circ`, the type system of QBRICKS-DSL features the type of integers `int` (with constructors \underline{n} , one for each integer n), booleans `bool` (with constructors `tt` and `ff`), and n -ary products (with constructor (e_1, \dots, e_n)). This type system is not meant to be exhaustive and it can be extended with usual constructs such as floats, lists and other user-defined inductive datatypes – its embedding into WhyML makes it easy to use such types. The term constructs are limited to function calls, `let`-style composition, test with `if-then-else` and simple iteration: `iter f n a` stands for $f(f(\dots f(a)\dots))$, with n calls to f . We again stress out that this could easily be extended – we just do not need it for our purpose.

The language is essentially first-order: this is reflected by the types A of expressions. The type of a function is given by the types of its arguments and the type of its output. By abuse of notation, the type of a function with inputs of types A_i and output of type B is written $A_1 \times \dots \times A_n \rightarrow B$.

A function f is either a function f_d defined with a declaration d or a constant function f_c . The functions defined by declarations must not be mutually recursive: this small, restricted language only features iteration. Constant functions consist in integer operators ($+$, $*$, $-$, *etc*), boolean operators (\wedge , \vee , \neg , \rightarrow , *etc*), Comparison operators ($<$, \leq , \geq , $>$, $=$, \neq : $\text{int} \times \text{int} \rightarrow \text{bool}$) and high-level circuit operators: `ctl`, `invert` : `circ` \rightarrow `circ` for controlling and inverting circuits, and `width`, `size` : `circ` \rightarrow `int` for counting the number of input and output wires, and the number

Expression	e	$::= x \mid c \mid f(e_1, \dots, e_n) \mid \text{let } \langle x_1, \dots, x_n \rangle = e \text{ in } e' \mid$ $\text{if } e_1 \text{ then } e_2 \text{ else } e_3 \mid \text{iter } f \ e_1 \ e_2$
Data Constructor	c	$::= \underline{n} \mid \text{tt} \mid \text{ff} \mid \langle e_1, \dots, e_n \rangle \mid \text{CNOT} \mid \text{SWAP} \mid \text{ID} \mid \text{H} \mid \text{Ph}(e) \mid \text{R}_z(e) \mid$ $\text{ANC}(e) \mid \text{SEQ}(e_1, e_2) \mid \text{PAR}(e_1, e_2)$
Function	f	$::= f_d \mid f_c$
Declaration	d	$::= \text{let } f_d(x_1, \dots, x_n) = e$
Type	A	$::= \text{bool} \mid \text{int} \mid \top \mid A_1 \times \dots \times A_n \mid \text{circ.}$
Value	v	$::= x \mid \underline{n} \mid \text{tt} \mid \text{ff} \mid \langle v_1, \dots, v_n \rangle \mid$ $\text{CNOT} \mid \text{SWAP} \mid \text{ID} \mid \text{H} \mid \text{Ph}(\underline{n}) \mid \text{R}_z(\underline{n}) \mid \text{ANC}(v) \mid \text{SEQ}(v_1, v_2) \mid \text{PAR}(v_1, v_2)$
Context	$C[-]$	$::= [-] \mid f(v_1, \dots, v_{i-1}, C[-], e_{i+1}, \dots, e_n) \mid$ $\text{let } \langle x_1, \dots, x_n \rangle = C[-] \text{ in } e' \mid \text{if } C[-] \text{ then } e_2 \text{ else } e_3 \mid$ $\text{iter } f \ C[-] \ e \mid \text{iter } f \ v \ C[-] \mid \langle v_1, \dots, v_{i-1}, C[-], e_{i+1}, \dots, e_n \rangle \mid$ $\text{CNOT} \mid \text{ID} \mid \text{H} \mid \text{Ph}(C[-]) \mid \text{R}_z(C[-]) \mid \text{ANC}(C[-]) \mid$ $\text{SEQ}(C[-], e) \mid \text{SEQ}(v, C[-]) \mid \text{PAR}(C[-], e) \mid \text{PAR}(v, C[-])$

Fig. 10. Syntax for QBRICKS-DSL

$$\begin{array}{c}
\frac{}{\Gamma, x : A \vdash x : A} \quad \frac{\Gamma \vdash f : A_1 \times \dots \times A_n \rightarrow B \quad \Gamma \vdash e_i : A_i}{\Gamma \vdash f(e_1, \dots, e_n) : B} \quad \frac{\Gamma \vdash e_i : A_i}{\Gamma \vdash \langle e_1, \dots, e_n \rangle : A_1 \times \dots \times A_n} \\
\frac{\Gamma \vdash e_1 : A_1 \times \dots \times A_n \quad \Gamma, x_1 : A_1, \dots, x_n : A_n \vdash e_2 : B}{\Gamma \vdash \text{let } \langle x_1, \dots, x_n \rangle = e_1 \text{ in } e_2 : B} \\
\frac{\Gamma \vdash e_1 : \text{bool} \quad \Gamma \vdash e_2 : A \quad \Gamma \vdash e_3 : A}{\Gamma \vdash \text{if } e_1 \text{ then } e_2 \text{ else } e_3 : A} \quad \frac{\Gamma \vdash e_1 : \text{int} \quad \Gamma \vdash e_2 : A \quad f : A \rightarrow A}{\Gamma \vdash \text{iter } f \ e_1 \ e_2 : A}
\end{array}$$

Fig. 11. Typing rules for QBRICKS-DSL

of gates (not counting ID nor SWAP) in the circuit C , $\text{width}(C)$ stands for the number of input and output wires of C , $\text{invert}(C)$ stands for the invert of C and $\text{ctl}(C)$ the control of C . See Figure 9 for the intuitive definition of circuit combinators.

Two very useful function declarations are the first and second projections $\text{fst} : A \times B \rightarrow A$ and $\text{snd} : A \times B \rightarrow B$. For instance, the former is defined with $\text{let } \text{fst}(x) = (\text{let } \langle y, z \rangle = x \text{ in } y)$.

The typing rules are the usual ones (summarized for convenience in Table 11).

5.2 Operational semantics. As any other regular functional programming language, QBRICKS-DSL is equipped with an operational semantics based on beta-reduction and substitution. We define a notion of value and applicative context as in Table 10. We then define a rewriting strategy as the relation defined with $C[e] \rightarrow C[e']$ whenever $e \rightarrow e'$ is one of the rule of Table 12. The table is split into the rules for the language constructs and the rules defining the behavior of the constant functions. We only give a subset of the latter rules. For instance, the arithmetic operations are defined in a canonical manner, and the boolean and comparison operators are defined in a similar manner on values of type int and bool . The rules for the constant functions acting on circuits are also for the most part straightforward: the size of a sequence is the sum of the sizes of the compounds for instance. The rules which we do not provide are the ones for the control operation ctl : the intuition behind their definition can be found in Figure 9. For the elementary gates, any definition can be used (see e.g. [54]), as long as it can be written with the chosen set of gates. One just has to then adjust the lemmas referring to ctl in QBRICKS-SPEC. Similarly, the invert

Language constructs	
Assuming that there is a declaration $f(x_1, \dots, x_n) \triangleq e$.	
$f(v_1, \dots, v_n) \rightarrow e[x_1 := v_1, \dots, x_n := v_n]$	
$\text{let } \langle x_1, \dots, x_n \rangle = \langle v_1, \dots, v_n \rangle \text{ in } e \rightarrow e[x_1 := v_1, \dots, x_n := v_n]$	
$\text{if tt then } e_1 \text{ else } e_2 \rightarrow e_1$	
$\text{if ff then } e_1 \text{ else } e_2 \rightarrow e_2$	
$\text{when } n \leq 0: \text{ iter } f \ \underline{n} \ a \rightarrow a$	
$\text{when } n > 0: \text{ iter } f \ \underline{n} \ a \rightarrow f(\text{iter } f \ \underline{n-1} \ a)$	
Constant functions (subset of the rules)	
$\underline{n + m} \rightarrow \underline{n + m}$	$\text{width}(\text{CNOT}) \rightarrow 2$
$\underline{n - m} \rightarrow \underline{n - m}$	$\text{width}(\text{SWAP}) \rightarrow 2$
$\underline{n * m} \rightarrow \underline{n * m}$	$\text{width}(g) \rightarrow 1 \quad (g \text{ other gate})$
$\text{size}(\text{ID}) \rightarrow 0$	$\text{width}(\text{SEQ}(v_1, v_2)) \rightarrow \text{width}(v_1)$
$\text{size}(\text{SWAP}) \rightarrow 0$	$\text{width}(\text{PAR}(v_1, v_2)) \rightarrow \text{width}(v_1) + \text{width}(v_2)$
$\text{size}(g) \rightarrow 1 \quad (g \text{ other gate})$	$\text{width}(\text{ANC}(v)) \rightarrow \text{width}(v) - 1$
$\text{size}(\text{SEQ}(v_1, v_2)) \rightarrow \text{size}(v_1) + \text{size}(v_2)$	$\text{invert}(\text{SEQ}(v_1, v_2)) \rightarrow \text{SEQ}(\text{invert}(v_2), \text{invert}(v_1))$
$\text{size}(\text{PAR}(v_1, v_2)) \rightarrow \text{size}(v_1) + \text{size}(v_2)$	$\text{invert}(\text{PAR}(v_1, v_2)) \rightarrow \text{PAR}(\text{invert}(v_1), \text{invert}(v_2))$
$\text{size}(\text{ANC}(v)) \rightarrow \text{size}(v)$	$\text{invert}(\text{ANC}(v)) \rightarrow \text{ANC}(\text{invert}(v))$

Table 12. Operational semantics for QBRICKS-DSL

of elementary gates are not given: we can choose the usual ones from the litterature —and this definition is then parametrized by the choice of gates.

5.3 Properties. Note that the target low-level representation for an expression of type `circ` is a value made of the circuit data constructors. This is derived from the safety properties of the language:

PROPERTY 5.3.1 (SAFETY PROPERTIES AND NORMALIZATION). *Provided that $\Gamma \vdash e : A$ and $e \rightarrow e'$, then $\Gamma \vdash e' : A$. Provided that $\vdash e : A$ is a closed expression, and provided that all the function in e recursively admits (external) definitions, then either e is a value or it reduces. Finally, the reduction strategy (\rightarrow) is normalizing: there does not exist an infinite reduction sequence $e_1 \rightarrow e_2 \rightarrow \dots$ \square*

Example 5.1. The motivating example of Section 3 can be written in QBRICKS-DSL as

```
let aux(x) = SEQ(x, H)
let main(n) = iter aux n ID
```

The function `aux` inputs a circuit and append a Hadamard gate at the end. The function `main` then input an integer parameter `n` and iterate the function `aux` to obtain `n` Hadamard in sequence. In particular, one can show that for instance

$$\text{main } \underline{4} \rightarrow^* \text{SEQ}(\text{SEQ}(\text{SEQ}(\text{SEQ}(\text{ID}, \text{H}), \text{H}), \text{H}), \text{H}), \text{H}),$$

that is, a sequence of 4 Hadamard gates.

5.4 Universality and usability of the chosen circuit constructs. In QBRICKS-DSL, we use a restricted, small set of elementary circuit building blocks. For instance, we have not included the NOT-gate $\begin{pmatrix} 0 & 1 \\ 1 & 0 \end{pmatrix}$. This is a design choice: the chosen elementary gates are not meant to be convenient but simple to specify yet forming a universal set of gates: A *universal* (resp. *pseudo-universal*) set of elementary gates is such that they can be composed thanks to sequence or parallelism so as to perform (resp. approach arbitrarily close) any quantum unitary matrix.

Other, maybe more convenient gates can then be defined as macros on top of them. If one aims at using QBRICKS inside a verification compilation tool-chain, these macros can for instance be the gates of the targeted architecture.

5.5 Validity of circuits. A circuit is represented as a rigid rectangular shape with a fixed number of input and output wires. In particular, there is a notion of validity: a `circ` object only makes sense provided two constraints:

- in $\text{SEQ}(C_1, C_2)$, the two circuits C_1 and C_2 should have the same number of wires (i.e. the same size). For instance, $\text{SEQ}(\text{CNOT}, \text{H})$ is not valid: one cannot put in sequence a 2-qubit gates with a 1-qubit gate. This is a simple *syntactic* constraint;
- in $\text{ANC}(C)$, the circuit C should have $n + 1$ wires. Moreover, if given as input a vector where the last qubit is in state $|0\rangle$, its output should also leave this qubit in state $|0\rangle$. This condition is on the other hand a *semantic* constraint.

Note that even the syntactic constraints cannot be checked by a simple typing procedure, because of the higher-order reasoning involved here: the constraints must hold for any value of the parameters. All these syntactic and semantic constraints are thus expressed in QBRICKS-SPEC, our domain-specific logical specification language, and meant to be sent as proof obligations to a proof engine.

Example 5.2. Note how the circuit generated by `main` in Example 5.1 is not necessarily a valid circuit (although in this case it is). This is one of the constraints that can be handled by QBRICKS-SPEC, as shown in Example 6.2.

5.6 Denotational semantics. As all expressions in QBRICKS-DSL are terminating, one can use regular sets as denotational semantics for the language. In order to be able to handle the partial definitions coming up in Section 6, we include in the denotation of each type an “error” element \perp . We therefore define the denotation of basic types as the set of their values: $\llbracket \text{bool} \rrbracket = \{\text{tt}, \text{ff}, \perp\}$, $\llbracket \text{int} \rrbracket = \mathbb{Z} \cup \{\perp\}$ and $\llbracket \text{circ} \rrbracket = \{v \mid \vdash v : \text{circ}\} \cup \{\perp\}$. Product types are defined as the set-product: $\llbracket A_1 \times \cdots \times A_n \rrbracket = (\llbracket A_1 \rrbracket \times \cdots \times \llbracket A_n \rrbracket) \cup \{\perp\}$ and $\llbracket \top \rrbracket = \{\star, \perp\}$, the singleton set. Finally, functions are defined as set-functions from the input set to the output set. The denotation of the language constructs are the usual one in a semantics based on sets ; for the constant functions, the definitions are the canonical ones: arithmetic operations maps to arithmetic operations for instance. In QBRICKS-DSL, everything is well-defined and \perp is only attainable from \perp —so for instance, $\perp + x = \perp$.

Note that in the denotational semantics one can build non-valid circuits. For instance, the circuit $\text{SEQ}(\text{CNOT}, \text{H})$ is a member of $\llbracket \text{circ} \rrbracket$. This is to be expected as we aim at the following property:

PROPERTY 5.6.1 (SOUNDNESS). *Provided that $\vdash e : A$, we have $\llbracket e \rrbracket \in \llbracket A \rrbracket \setminus \{\perp\}$. Moreover, provided that $e \rightarrow e'$ then we have $\llbracket e \rrbracket = \llbracket e' \rrbracket$. \square*

It is however possible to formalize the notion of syntactically valid circuits as a subset of $\llbracket \text{circ} \rrbracket$.

Definition 5.3. We define the (syntactic) unary relation $\mathcal{V}_{\text{syntax}}$ on $\llbracket \text{circ} \rrbracket$ as follows: Each one of the gate belongs to $\mathcal{V}_{\text{syntax}}$; if C_1 and C_2 belongs to $\mathcal{V}_{\text{syntax}}$ then so does $\text{PAR}(C_1, C_2)$ and $\text{ANC}(C_1)$; if moreover $\llbracket \text{width} \rrbracket(C_1) = \llbracket \text{width} \rrbracket(C_2)$ then $\text{SEQ}(C_1, C_2)$ belongs to $\mathcal{V}_{\text{syntax}}$.

6 QBRICKS-SPEC

In term of semantics of quantum circuits, the main novelty of QBRICKS is to be able to reason on *open terms* seen as circuit description, parametrized programs. To do so, we build upon the recent proposal of path-sums [1, 2]. In QBRICKS-SPEC, we define the notion of *higher-order path-sums* (HOPS). Original path-sums in [1] are fixed functionals, computed from concrete, fixed-size circuits. In HOPS, the phase polynomials, ranges and basis kets are instead written as open terms

from QBRICKS-DSL, *parametrized* with term variables. This correspondence. This integration with QBRICKS-DSL brings two decisive advantages compared to the original path-sums:

- **Parametricity and compositionality.** Because of the sharing of term variables between QBRICKS-DSL terms and HOPS, QBRICKS-SPEC gives the ability to give specification to general programs describing families of circuits instead of fixed-size circuits. QBRICKS-SPEC opens path-sums to *higher-order* specification and verification while retaining the vertical and horizontal compositional properties;
- **Versatility.** Thanks to the integration within a logical framework, QBRICKS-SPEC gives the ability to define —and reason— upon logical macros asserting useful constraints related to probabilities, eigenvalues, etc (See Section 7.4).

6.1 Syntax of QBRICKS-SPEC. QBRICKS-SPEC consists of a set of dedicated relations and functions, together with a language of algebraic expressions on top of a first-order logic, together with logical libraries to express constraints. We define QBRICKS-SPEC as a first-order, predicate logic with the following syntax.

Formula	$\phi, \psi ::= \phi \vee \psi \mid \phi \wedge \psi \mid \neg \phi \mid \phi \rightarrow \psi \mid R(\hat{e}_1, \dots, \hat{e}_n)$
First-order expression	$\hat{e} ::= x \mid c(\hat{e}_1, \dots, \hat{e}_n) \mid f(\hat{e}_1, \dots, \hat{e}_n) \mid f_\ell(\hat{e}_1, \dots, \hat{e}_n).$

The first-order expressions \hat{e} form a subset of QBRICKS-DSL: they are restricted to variables and (formal) function calls to other first-order expressions. Unlike regular, general expressions —meant to be computational vehicles— these first-order expressions only aim at being reasoned upon. The functions names are then expanded with *logic functions* f_ℓ with no computational content. Among these new functions, we introduce one function $\text{iter}_f : \text{int} \times A \rightarrow A$ for each function $f : A \rightarrow A$, standing for the equational counterpart of the iteration. The logic functions are defined equationally in the logic: see Section 7 for details. The relation R ranges over a list of constant relations over first-order expressions. An important one is $\text{circ_valid} : \text{circ} \rightarrow \text{bool}$, expressing the syntactic property $\mathcal{V}_{\text{syntax}}$ of Definition 5.3. In QBRICKS-SPEC, we identify relations and functions of return type bool . Constant relations are therefore simply constant functions of output type bool .

The type system of QBRICKS-SPEC is extended with opaque types, equipped with constant functions and relations to reason upon them. They come with no computational content: the aim is purely to be able to *express and prove specification properties* of programs. This is why we did not incorporate them in QBRICKS-DSL’s type system.

The opaque types we consider in QBRICKS-SPEC are `complex`, `real`, `bitvector`, `hops` and `ket`. The operators and relations for these new types are given in Table 13. Note that in the rest of the paper, by abuse of notation we shall omit the casting operations `i_to_r` and `r_to_c`. We shall also use a declared exponentiation function $[-]^{[-]}$ overloaded by abuse of notation with type $\text{complex} \times \text{int} \rightarrow \text{complex}$ and $\text{real} \times \text{int} \rightarrow \text{real}$. The three types `complex`, `real` and `bitvector` are standard; the types `hops` and `ket` are novel and form the main reasoning vehicle in QBRICKS-SPEC.

6.2 The types `hops` and `ket`. In short, the type `hops` encodes our *higher-order path sum* (HOPS) representation for expressions of type `circ` in QBRICKS-DSL, while `ket` encodes the notion of ket-vector. As these types are pure reasoning apparatus, we only need them in QBRICKS-SPEC and they are defined uniquely though an equational theory.

As shown in Figure 6, a regular path-sum is a static abstract object consisting of 4 pieces: a *global range* (the value n), what we shall be calling its *width*, i.e. the size of the bit-vector x , and the *phase polynomial* $\frac{P_k(x)}{2^m}$ and the *ket* vector $\phi_k(x)$, functions of both the input x and the index k .

To reflect this structure, the type `hops` is equipped with 4 constant functions acting on an HOPS (see Table 13): `hops_width`, yielding its width, `hops_range`, yielding its range, `hops_angle`,

complex and real	hops
$i, \pi : \text{complex}$ $i_to_r : \text{int} \rightarrow \text{real}$ $r_to_c : \text{real} \rightarrow \text{complex}$ $\text{Re, Im, abs} : \text{complex} \rightarrow \text{real}$ $e^{\parallel} : \text{complex} \rightarrow \text{complex}$ $-c, +c, *c, /c : \text{complex} \times \text{complex} \rightarrow \text{complex}$ $-r, +r, *r, /r : \text{real} \times \text{real} \rightarrow \text{real}$ $\sqrt{_} : \text{real} \rightarrow \text{real}$	$\text{hops_width} : \text{hops} \rightarrow \text{int}$ $\text{hops_range} : \text{hops} \rightarrow \text{int}$ $\text{hops_angle} : \text{hops} \times \text{bitvector} \times \text{bitvector} \rightarrow \text{real}$ $\text{hops_ket} : \text{hops} \times \text{bitvector} \times \text{bitvector} \rightarrow \text{bitvector}$ $\text{hops_equiv} : \text{hops} \times \text{hops} \rightarrow \text{bool}$ $\text{circ_to_hops} : \text{circ} \rightarrow \text{hops}$ $\text{hops_apply} : \text{hops} \times \text{ket} \rightarrow \text{ket}$
bitvector	ket
$\text{bv_length} : \text{bitvector} \rightarrow \text{int}$ $\text{bv_cst} : \text{int} \times \text{bool} \rightarrow \text{bitvector}$ $\text{bv_get} : \text{bitvector} \times \text{int} \rightarrow \text{bool}$ $\text{bv_set} : \text{bitvector} \times \text{int} \times \text{bool} \rightarrow \text{bitvector}$	$\text{ket_length} : \text{ket} \rightarrow \text{int}$ $\text{ket_get} : \text{ket} \times \text{bitvector} \rightarrow \text{complex}$ $\text{bv_to_ket} : \text{bitvector} \rightarrow \text{ket}$ $+k, -k, \otimes_k : \text{ket} \times \text{ket} \rightarrow \text{ket}$ $*_k : \text{complex} \times \text{ket} \rightarrow \text{ket}$

Table 13. Primary operators for QBRICKS-SPEC

yielding the real number corresponding to $\frac{P_k(x)}{2^m}$, and hops_ket yielding the ket-vector $\phi_k(x)$. Note how the two last functions also inputs two bit-vectors, corresponding to k and x . If path-sums compose nicely, a given linear map does not have a unique representative path-sum (partly due to the fact that phase polynomials are equal modulo 2π). To capture this equivalence, we introduce the constant relation hops_equiv . In order to relate circuits and HOPS, we introduce the constant function circ_to_hops : it returns *one possible* HOPS that *represents* the input circuit. The chosen HOPS is built in a constructive manner on the structure of the circuit. A useful relation is $(- \triangleright -)$ relating a circuit and a HOPS: it is defined as $(c \triangleright h) \triangleq \text{hops_equiv}(\text{circ_to_hops}(c), h)$. Another useful macro is the function $\text{circ_apply} : \text{circ} \times \text{ket} \rightarrow \text{ket}$, defined as $\text{circ_apply}(C, k) \triangleq \text{hops_apply}(\text{circ_to_hops}(C), k)$.

The type ket is a handle to easily manipulate ket-vectors, and Table 13 presents the constant functions meant to manipulate it. bv_to_ket builds a basis ket-vector out of the input bit vector ; ket_length returns the number of qubits in the ket ; ket_get returns the amplitude of the corresponding basis ket-vector. The other operations are the usual operations on vectors: addition, subtraction, tensors, scalar multiplication. Finally, the function hops_apply relates hops and ket: it identifies the input HOPS to a functional and applies it to the input ket-vector.

6.3 Denotational semantics of the new types. The denotational semantics of real and complex are respectively the sets $\mathbb{R} \cup \{\perp\}$ and $\mathbb{C} \cup \{\perp\}$, and the denotation of the operators are the canonical ones. As for Section 5, \perp maps to \perp , so for instance $\perp +_r x = \perp$.

The denotation of bitvector is defined as the set of all bit-vectors, together with the “error” element \perp . The constant functions are mapped to their natural candidate definition, using \perp as the default result when they should not be defined. So for instance, $\llbracket \text{bv_cst} \rrbracket(-1, \text{tt}) = \perp$.

An element of ket is meant to be a ket-vector: we defined $\llbracket \text{ket} \rrbracket$ as the set of *all* possible ket-vectors $\sum_{i=0}^{2^m} \alpha_n |b_n\rangle_m$, for all possible $m, n \in \mathbb{N}$, $\alpha_n \in \mathbb{C}$ and bit-vectors b_n of size m , together with the error element \perp .

Finally, hops is defined as the set of formal path-sums, as defined in Table 6, together with the error element \perp . The denotation of the constant functions are defined as discussed in Section 6.2. As an example, $\llbracket \text{hops_range} \rrbracket$ returns the range of the corresponding HOPS. The map circ_to_hops builds a valid HOPS out of the input circuit, or \perp if the circuit is not valid. The defined HOPS follows the structure of the circuit. For instance, $\text{circ_to_hops}(\text{SEQ}(C_1, C_2))$ is the sequential composition of the two HOPS $\text{circ_to_hops}(C_1)$ and $\text{circ_to_hops}(C_2)$ (as shown in Equation (1)).

6.4 Parametricity of HOPS. A regular path-sum is not parametric: it represents *one* fixed functional. So why did we chose $\llbracket \text{hops} \rrbracket$ to be a set of path-sums? Let us consider an example.

Example 6.1. Consider the motivating example of Section 3 and its instantiation in Example 5.1. The function `main` describes a family of circuits indexed by an integer parameter n . Now, consider the typing judgment $h : \text{hops}, n : \text{int} \vdash (\text{main}(n) \triangleright h) : \text{bool}$. It can be regarded as a relation between HOPS h and integers n , valid whenever h represents `main`(n). Technically, this relation is not quite the graph of a function (since several HOPS might match the circuit `main`(n)). Nonetheless, to each n is associated a different set of HOPS h : in this sense, one can say that h is “higher-order”, as it is parametrized by n . Thus the “HOPS” terminology.

6.5 Regular sequents and HQHL sequents in QBRICKS-SPEC. Formulas in QBRICKS-SPEC are typed objects —and to a certain extent one can identify them with first-order expressions of type `bool`. Due to this correspondence, we shall only say that logic judgments in QBRICKS-SPEC are well-formed judgments of the form $\Delta \vdash \phi$ where the well-formedness means that $\Delta \vdash \phi : \text{bool}$ is a valid typing judgment in QBRICKS-DSL. That being said, a well-formed judgment $\Delta \vdash \phi$ is valid whenever it holds in the denotational semantics: for every instantiation σ sending $x : A$ in Δ to $\llbracket A \rrbracket$, the notation $\llbracket \phi \rrbracket_\sigma$ is valid. In particular, the (free) variables of ϕ can be regarded as universally quantified by the context Δ .

Another useful kind of judgment is one allowing equational reasoning on terms: if $\Delta \vdash e_1 : A$ and $\Delta \vdash e_2 : A$ are valid QBRICKS – DSL typing judgments, the judgment $\Delta \Vdash e_1 = e_2 : A$ is valid whenever for every instantiation σ sending $x : B$ in Δ to $\llbracket B \rrbracket$, the denotations of e_1 and e_2 with respect to σ are equal (as set-elements).

In order to be able to express program specifications with pre- and post-conditions, we finally define a HQHL sequent of the form $\Delta \Vdash \{\phi\}e\{\psi\} : A$ (we omit the type A when irrelevant or clear). The formula ψ can make use of a reserved free variable `result` of type A . Such a sequent is then well-formed provided that $\Delta \vdash \phi : \text{bool}$, $\Delta, \text{result} : A \vdash \psi : \text{bool}$ and $\Delta \vdash e : A$ are valid typing judgments. Note how the reserved free variable `result` is being added to Δ for typing ψ . For convenience, we also extend the notation to `resulti` to stand for the i th projection of `result` when A is of the form $A_1 \times \dots \times A_n$.

Then the point is that first, families of quantum circuits can be described in QBRICKS-DSL and specifications in QBRICKS-SPEC, and second, that one can come up with a set of meaningful axioms that are enough to derive these specifications. This is the goal of Section 7.

Example 6.2. Consider the motivating example of Section 3 and its instantiation in Example 5.1. We can now give a specification to the function `main`, as follows:

$$n : \text{int}, m : \text{int}, x : \text{ket} \Vdash \{n \geq 0 \wedge \text{ket_length}(x) = 1 \wedge n = 2 * m\} \text{main}(n) \{\text{circ_apply}(C, x) = x\}.$$

The fact that `circ_apply` is well-defined implies that C is valid.

7 THE HQHL DEDUCTION SYSTEM

Thanks to the logic judgments presented in Section 6.5, it is possible to reason with QBRICKS-SPEC formulas on expressions written in QBRICKS-DSL. If we showed how to give a semantical meaning to the validity of a judgment, we have not explained how to derive such a validity from first principles. This is the purpose of the current section.

PROPERTY 7.0.1 (VALIDITY OF THE DEDUCTION RULES). *All of the deduction rules that we add in this section are sound with respect to the semantics.* \square

Note that we do not aim in this section at being exhaustive: we only aim at giving an intuition as of how and why one can rely on an automated deductive system to derive QBRICKS-SPEC judgments. In particular, we show how to break down a program specification into a set of proof obligations that can be sent to an SMT solver to be automatically discharged.

7.1 Deriving HQHL judgments. In Example 6.2, we were able to state a HQHL judgment for the motivating example of Section 3. Using a bottom-up strategy, it is possible to use the deduction rules of Figure 14 to break down the judgments into pieces reasoning on smaller terms. Along the way, there is the need for introducing invariants and assertions. As usual, some of these assertions can be derived by computing the weakest-preconditions: we do not necessarily have to introduce every single one.

In the deduction rule (`iter`) of Figure 14, the first-order expression \hat{e}_1 is mechanically built from e_1 by inlining function calls, replacing $P[\text{if } e_1 \text{ then } e_2 - \text{else } e_3]$ with the equivalent formulation $(e_1 \wedge P[e_2]) \vee (\neg e_1 \wedge P[e_3])$, changing `let`'s with calls to projections, and replacing each `iter f a i` with its functional counterpart `iterf(a, i)`. The deduction rule (`eq`) states that whenever one can show that two expressions are equal one can substitute one for the other inside a HQHL judgment. Finally, we can derive from the semantics the usual substitution rules. For instance, provided that $\Gamma, x : A \vdash \psi$ and $\Gamma \vdash e : A$ then $\Gamma \vdash \psi[x := e]$.

The rules of Figure 14 make it possible to break an expression down to a first-order expression from QBRICKS-SPEC. When such a case is attained one can rely on the rule

$$\frac{\Gamma \vdash \phi \rightarrow \psi[\text{result} := \hat{e}]}{\Gamma \Vdash \{\phi\} \hat{e} \{\psi\} : A} \text{ (f-o)}$$

to generate a proof obligation as a regular sequent in QBRICKS-SPEC. Of course, there is no guarantee that any such proof-obligation can automatically be discharged. However, our work show that this strategy can successfully be applied, as exemplified by the non-trivial case studies we considered in Section 9.

7.2 Deduction rules for hops. The main tools to relate circuits and HOPS are the constant function `circ_to_hops`, its relational counterpart $(-\triangleright-)$, and the declared function `circ_apply`. They can be specified inductively on the structure of the input circuit. As an example of a lemma to be added for reasoning on $(-\triangleright-)$, consider the case of the Hadamard gate. The sequent $\Gamma \vdash (H \triangleright h)$ can be derived from

$$\begin{aligned} \Gamma, \vec{x}, \vec{y} : \text{bitvector} \vdash & (\text{bv_length}(\vec{x}) = 1 \wedge \text{bv_length}(\vec{y}) = 1) \rightarrow \\ & \text{hops_width}(h) = 1 \wedge \text{hops_range}(h) = 1 \wedge \\ & \text{hops_angle}(h)(\vec{x}, \vec{y}) = (-1)^{\vec{x}_0 * \vec{y}_0} \wedge \text{hops_ket}(h_3)(\vec{x}, \vec{y}) = \vec{y}. \end{aligned}$$

This simply states that the HOPS of the Hadamard gate is of the form $|x\rangle_1 \mapsto \sum_{j=0}^1 (-1)^{\vec{x}_0 * \vec{y}_0} |y\rangle_1$.

For the circuit combinator `PAR`, one can state the rule

$$\frac{\Gamma \vdash (C_1 \triangleright h_1) \quad \Gamma \vdash (C_2 \triangleright h_2) \quad \Gamma, \vec{x}, \vec{y} : \text{bitvector} \vdash \text{hops_par}(h_1, h_2, h_3, \vec{x}, \vec{y})}{\Gamma \vdash (\text{PAR}(C_1, C_2) \triangleright h_3)} \text{ seq}$$

where $\text{hops_par}(h_1, h_2, h_3, \vec{x}, \vec{y})$ is a formula encapsulating the relationship between the phase polynomials, the kets, the ranges and the widths of h_1 , h_2 and h_3 , as shown in Equation (1) in Section 2.5. The complete set of rules for $(-\triangleright-)$ can be found in Appendix C

7.3 Equational reasoning. The SMT solvers we aim at using to discharge proof obligations requires equational theories describing how to reason on the constant functions that were introduced. Some of these equational theories are standard and well-known in verification: for instance, bit-vectors and algebraic fields. Together with a few properties on square-root, exponentiation, real

$$\begin{array}{c}
\frac{\Gamma, x \Vdash \{\phi \wedge x \leq 0\} e_2 \{P[x, \text{result}]\} \quad \Gamma, x, y \Vdash \{\phi \wedge P[x, y]\} f(y) \{P[x+1, \text{result}]\}}{\Gamma \Vdash \{\phi\} \text{iter } f e_1 e_2 \{P[\hat{e}_1, \text{result}]\}} \quad (\text{iter}) \\
\\
\frac{\Gamma \Vdash \{P\} e_1 \{Q[x_i := \text{result}_i]\} \quad \Gamma, x_1, \dots, x_n \Vdash \{Q\} e_2 \{R\}}{\Gamma \Vdash \{P\} \text{let } x_1, \dots, x_n = e_1 \text{ in } e_2 \{R\}} \quad (\text{let}) \\
\\
\frac{\Gamma \Vdash \{P\} e_1 \{Q[x := \text{result}]\} \quad \Gamma, x \Vdash \{Q \wedge x\} e_2 \{R\} \quad \Gamma, x \Vdash \{Q \wedge \neg x\} e_3 \{R\}}{\Gamma \Vdash \{P\} \text{if } e_1 \text{ then } e_2[x := e_1] \text{ else } e_3[x := e_1] \{R\}} \quad (\text{if}) \\
\\
\frac{\forall i \cdot \Gamma \Vdash \{P\} e_i \{R_i[\text{result}_i]\}}{\Gamma \Vdash \{P\} \langle e_1, \dots, e_n \rangle \{R_1[\text{result}_1] \wedge \dots \wedge R_n[\text{result}_n]\}} \quad (\text{tuple}) \\
\\
\frac{f(x_1, \dots, x_n) \triangleq e \quad \Gamma \Vdash \{P\} e[x_1 := e_1, \dots, x_n := e_n] \{R\}}{\Gamma \Vdash \{P\} f(e_1, \dots, e_n) \{R\}} \quad (\text{decl}) \\
\\
\frac{\Gamma \vdash P \rightarrow P' \quad \Gamma \Vdash \{P'\} e \{Q'\} : A \quad \Gamma, \text{result} : A \vdash Q' \rightarrow Q}{\Gamma \Vdash \{P\} e \{Q\} : A} \quad (\text{weaken}) \\
\\
\frac{\Gamma \Vdash e_1 = e_2 : A \quad \Gamma \Vdash \{P[e_1]\} e[e_1] \{Q[e_1]\} : A}{\Gamma \Vdash \{P[e_2]\} e[e_2] \{Q[e_2]\} : A} \quad (\text{eq})
\end{array}$$

Fig. 14. Deduction rules for QBRICKS: HQHL rules for term constructs

and imaginary parts, the latter is all we need for `real` and `complex`: in quantum computation, the manipulations of real and complex numbers turns out to be quite limited. In particular, we do not need anything related to real or complex analysis.

The main difficulty in the design of QBRICKS has been to lay out equational theories and lemmas for `circ`, `hops` and `ket` that can efficiently help in automatically discharging proof obligations. Many of these equations and lemmas are quite straightforward. For instance, we turn the rewriting rules of Table 12 into equations, such as $(x, y : \text{circ}) \Vdash \text{width}(\text{PAR}(x, y)) = \text{width}(x) + \text{width}(y)$, or $n : \text{int} \Vdash \text{iter}_f(a, n+1) = f(\text{iter}_f(a, n))$. These equations maps the (syntactic) computational behavior of expressions into the logic. Other equations are expressing purely semantic properties. For instance, the equation

$$\Gamma \Vdash \text{circ_apply}(\text{SEQ}(C_1, C_2), k) = \text{circ_apply}(\text{circ_apply}(C_1, \text{circ_apply}(C_2, k)))$$

is correct with respect to the semantics and is part of the equational theory.

Circuit size. An important equational theory that we need in QBRICKS-SPEC is one for reasoning on the size of circuits. Being able to reason on circuit size is one of the important feature for the certifying an quantum algorithm implementation: one of its main point is for instance the polynomiality of the number of gates over the size of the input. We again stress out that this aspect of certification is not addressed by existing approaches [1, 37, 50].

As we discussed above, the equational theory for circuits reflects the rewrite rules. For instance, we have $(x, y : \text{circ}) \Vdash \text{size}(\text{PAR}(x, y)) = \text{size}(x) + \text{size}(y)$. A complete set of rules can be found in Appendix, in Figure 18.

Example 7.1. Consider the motivating example of Section 3 and its instantiation in Example 5.1. We can specify the size of the resulting circuit, as follows:

$$n : \text{int} \Vdash \{n \geq 0\} \text{main}(n) \{\text{size}(\text{result}) = n\}.$$

7.4 Specialized libraries. For QBRICKS we also derived more specialized, non-trivial libraries of lemmas. In particular:

Subclasses of circuits. Shortcuts for reasoning on specific classes of circuits. Among them are, in particular, the circuits with an hops of range (1). We call them *flat* circuits. Flat circuits enjoy a number of simplifying properties that are exposed in Section D. Section D also introduce a further simplified subclass of circuits, called *diagonal* circuits.

Eigenvectors and eigenvalues. One of the common need in the specification of quantum programs (and in particular in the case of QPE) is the need for asserting that a particular ket k is an eigenvector of the unitary map described by some circuit c , with eigenvalue the complex number ρ . In QBRICKS-SPEC we define the relation $\text{eigen}(c, k, \rho)$ as $\text{circ_apply}(c, k) = \rho *_k k$

Probabilities. A quantum program is usually a probabilistic program: it returns the desired result with a probability that depends on the problem parameters (number of iteration, structure of the problem, etc). If one aims at fully specifying such programs, this probability therefore needs to be expressible as post-condition.

As recalled in Section 2.1, the probability of obtaining a result by a measurement is correlated with the amplitudes of the corresponding ket-basis vectors in the quantum state of the memory. In QBRICKS-SPEC we define a relation $\text{proba_partial_measure} : \text{circ} \times |\times\rangle_{\text{bitvector}} \rightarrow \text{Re}$ meaning that when the input circuit is applied to the input ket, if we were to measure the result the probability of obtaining the given vector would be the result of the function. We define it as $\text{proba_partial_measure}(c, k, x) = (\text{abs}(\text{ket_get}(\text{circ_apply}(c, k), x)))^2$. In the specifications of Grover, QPE and Shor-OF we define specialized functions based on $\text{proba_partial_measure}$ specifying the constraints specific to each algorithm.

Algebraic operations on operators. In the course of the proof of quantum specification, it is sometimes useful to be able to manipulate algebraic expressions containing building blocks such as *rotations* or *projectors*. In QBRICKS-SPEC, with the use of HOPS it is possible to define such objects as macros, and then prove algebraic equalities between them, that we then add as auxiliary lemmas to be used by the automated provers. The use of HOPS gives us the possibility to specify—and prove—equalities parametrized by problem instances. This is for instance used extensively in the proof of the Grover specification.

8 IMPLEMENTATION

The QBRICKS framework described so far is implemented as a DSL embedded inside the Why3 deductive verification platform [11, 28], written in the WhyML programming language.⁴ This allows us to benefit from several strengths of Why3, such as efficient code extraction toward Ocaml, generation of proof obligations (to implement the HQHL mechanism) and access to several proof means. Indeed, a dedicated interface enables direct access to proof obligations and either send them to a set of automatic SMT-solvers (CBC4, Alt-Ergo, Z3, etc.), or enter a number of interactive proof transformation commands (calls for lemmas or hypotheses, term substitutions, etc.) or even send them towards proof assistants (Coq, Isabelle/HOL)—we do not use this option in our case-studies.

The development itself counts 17,000+ lines of code, including 400+ definitions and 1700+ lemmas, all proved within Why3. Most of the development concerns the (verified) mathematical libraries (14,000+ loc for a total of 17,000+ loc—see Table 23 in Appendix, Section E). They cover the

⁴Implementation statistics and description of mathematical libraries can be found in Appendix, Section E.

mathematical structures at stake in quantum computing (complex, Kronecker product, bit-vectors, etc.), together with a *formally verified collection* of mathematical results concerning them. They count 14,000+ lines of code: 300+ definitions, 1600+ lemmas and 32 axiomatic definitions.

9 CASE STUDIES AND EXPERIMENTAL EVALUATION

Thanks to our implementation of QBRICKS, we could develop and prove parametric implementations of several emblematic quantum algorithms, namely Grover search, QFT, QPE and Shor-OF. We also implemented Deutsch-Jozsa for the sake of comparison with prior work.

9.1 Case studies. Before discussing the experimental evaluation in Section 9.2, let us first introduce our implementations of QPE, Shor-OF and Grover algorithms⁵.

Quantum Phase Estimation (QPE). Developed by Cleve et al. [17], Kitaev [45], this procedure inputs a unitary operator U and an eigenvector $|v\rangle$ of U and finds the eigenvalue $e^{2\pi i\Phi_v}$ associated with $|v\rangle$. It is a central piece in many emblematic algorithms, such as quantum simulation [30] or HHL algorithm [36] – resolution of linear systems of equations in time POLYLOG . We implemented two different versions of QPE:

- In the first case (*core case*) we assume that Φ_v admits a binary writing with n bits. Then there is $\varphi_v \in \llbracket 0, 2^n \rrbracket$ such that $\Phi_v = \frac{\varphi_v}{2^n}$, and the eigenvalue associated with $|v\rangle$ is $e^{2\pi i\Phi_v}$ (also written $\omega_n^{\varphi_v}$). The goal is to seek this value φ_v and the algorithm deterministically outputs this value.
- In the second version (*general case*), no assumption is made over Φ_v which can take any real value such that $0 \leq \Phi < 1$. The goal is to seek the value $k \in \llbracket 0, 2^n \rrbracket$ that minimizes the distance $\Phi - \frac{k}{2^n}$ (modulo 1). The output of the algorithm is non deterministic. The proved specification is that it outputs k with probability at least $\frac{4}{\pi^2}$.

Shor [66]’s algorithm. Certainly the most emblematic of all quantum algorithms, it implements integer factoring by polynomial reduction to Order Finding. The quantum circuit –the quantum part of the algorithm, the one we are certifying– consists in an application of QPE to the unitary operator $U : |y\rangle \rightarrow |x \cdot y \bmod N\rangle$. We developed a certified *concrete* implementation following the implementation proposed in [6] –a reference in term of complexity. Besides proving the functional requirements of the order-finding problem (including achieving it with probability $O(1)$), we also prove some appreciable **complexity results**: our implementation requires applying $O(\text{Log}_2(N))^4$ quantum gates and requires $4\text{Log}_2(N) + 2$ qubits.⁶

Grover search algorithm. Developed by Grover [34], in its first version, it enables to find a distinguished element in an unstructured data base with a quadratic speedup with regards to the best known equivalent classical approaches. It was then generalized by Boyer et al. [13] to the similar problem with a parameterized number k of distinguished elements. We implemented this most general case, without any restriction over k .

9.2 Experimental evaluation. In addition to QPE, Shor-OF and Grover algorithm, we also consider implementations of the Quantum Fourier Transform (QFT) and the Deutsch-Jozsa algorithm.

We have been successful on all the cases, providing the first verified parametric implementation of QFT, QPE, Shor-OF and Grover.

⁵More details can be found in Appendix, Section F.1.

⁶A further refinement is possible by, as indicated in [6], using an hybrid version of the Quantum Fourier Transform, but it would require adding effective measure operation and classical control to QBRICKS.

Different metrics about our formal developments are reported in Table 15⁷: lines of decorated code, lemmas, proof obligations (PO), automatically proven PO (within time limit 5 seconds), remaining POs and the number of interactive commands we entered to discharge them – this last metric is detailed in Table 29 in Appendix, Section F.2.

Note that metrics for each implementation strictly concern the code that is *proper* to it (eg., QPE contains calls to QFT but QPE line in Table 15 does not include the QFT implementation. Similarly, Shor-OF calls both QPE and QFT) – the whole Shor-OF development is reported in the “Shor-OF full” row and row “Total” sums it with lines DJ and Grover.

	#LoC	#Extr.	#Def.	#Lem.	#POs	Automation			#Cmd
						# Aut.	% Aut.	Non aut.	
DJ	53	11	2	1	72	61	>84%	11	39
Grover	416	42	9	20	698	668	>95%	30	167
QFT	65	18	3	0	62	53	>85%	9	37
QPE	319	33	6	15	423	396	>93%	27	155
Shor-OF	809	132	34	1	1522	1456	>95%	66	264
Shor-OF (full)	1193	183	43	16	2007	1905	95%	102	456
Total	1662	236	54	37	2777	2634	>94%	143	662

#LoC.: lines of decorated code – # Extr.: lines of extracted code (OCaml)

#Aut.: automatically proven POs – #Cmd: interactive commands

Table 15. Implementation & verification for case studies with QBRICKS

Result. *QBRICKS did allow us to implement and verify in a parametric manner the Shor-OF, QPE and Grover algorithms, at a rather smooth cost and with high proof automation (94% in average, 95% for full Shor-OF).*

Interestingly, it should be noted that while Grover relies on mechanisms and arguments significantly different from those of QPE or Shor-OF, we were able to implement, specify and prove it without adding anything new to QBRICKS – demonstrating the genericity of our approach.

A last interesting observation concerns the time we spent on the different implementations of these case studies, given in chronological order: 1.5 person.year to build QBRICKS and be able to implement, specify and prove QFT and a restricted case of QPE – 1 person.day for DJ – 2 person.weeks for each of QPE (full case) and Grover – and finally 10 person.days to add Shor-OF on top of QPE. Considering how significantly the initial development effort factorizes over further developments, we have good reasons to believe that QBRICKS provides a generic and convenient environment for specifying, developing and proving quantum programs in a reasonably fast and easy way.

9.3 Comparison with prior works. Table 30 in Appendix (Section F.2) provides a summary of the comparison with these preexisting formal verification efforts for quantum programs.

Regular path-sums. Amy [1, 2] uses path sums for the verification of several circuits of complexity similar to that of QFT (QFT, Hidden shift, Toffoli generalized, etc). Yet, these experiments consider fixed circuits (up to 100 qubits) and the technique cannot be applied to parametric families of circuits or circuit-building languages.

⁷Experiments were run on Linux, on a PC equipped with an Intel(R) Core(TM) i7-7820HQ 2.90GHz and 15 GB RAM. We used Why3 version 1.2.0 with solvers Alt-Ergo-2.2.0, CVC 3-2.4.1, CVC4-1.0, Z3-4.4.1.

QHL. Liu et al. [50] report about the parametric verification of Grover search algorithm, on a *restricted case*⁸ and in the *high-level* algorithm description formalism of QHL – especially QHL has no notion of circuit. Interestingly, the generic verification of our low-level implementation is 5× smaller than theirs: 3184 total lines vs 583 total lines (416 lines + 167 commands).

Qwire. Finally, Hietala et al. [37] have presented in their 2019 preprint a fully verified parametric (circuit-building) implementation of the Deutsch-Josza algorithm in Coq. This implementation is given two independent correction proofs. As already pointed out, DJ is more a standard teaching example (with no practical application) than a representative quantum algorithm – roughly speaking, 10× smaller than Grover and 20× smaller than (full) Shor-OF. Moreover, our development requires significantly less efforts than theirs: less code (53 vs 74 lines) and 5.5× less proof commands (39 vs 222) for their textbook-style version – the one closest to our own version⁹.

9.4 Summary. It appears that QBRICKS provides a powerful framework for the development of formally verified parametric implementations of realistic quantum algorithms, setting up a new baseline in terms of quantum program formal proofs and achieving high scores in terms of proof automation.

10 RELATED WORKS

Formal verification of quantum circuits. In the last couple of years, several efforts have been led toward introducing formal methods in quantum programming. Prior efforts regarding quantum circuit verification [1, 2, 12, 29, 50, 58, 61, 63, 76] have been described throughout the paper, especially in Sections 1, 3 and 9.

We build on top of these seminal works and propose the first deductive verification framework for circuit-building quantum programs – the current consensus in quantum programming languages, featuring clear separation between code & proof, parametric specifications & proofs and a high degree of proof automation.

Especially, our technique is more automated than those based on interactive proving [37, 63] thanks to the new HQHL Hoare-style deduction system, borrows and extends the path sum representation [2] to the parametric case, and do consider a circuit-building language rather than a high-level algorithm description language [50].

Quantum Languages and Deductive Verification. Liu et al. [50] introduce Quantum Hoare Logic for high-level description of quantum algorithms. QHL and our own HQHL are very different, as the underlying formalisms are very different. Combining the two approaches on a combined formalism is an exciting research direction.

Optimized compilation of circuits. Formal methods and other program analysis techniques are also used in quantum compilation, in order to build highly optimized circuits [3, 8, 35, 38, 57, 62, 67]. This is a crucial current research area. Indeed, the quantum hardware available in the near future is expected to be highly constrained in terms of qubits, connectivity and quality: the so-called NISQ era [55, 59, 71].

Especially, the ZX-calculus [18] represents quantum circuits by diagrams, amenable to automatic simplification through dedicated rewriting rules. This framework leads to a graphical proof assistant [44] geared at certifying the semantic equivalence between circuit diagrams, with application to circuit equivalence checking and certified circuit compilation and optimization [21, 22, 43]. Yet,

⁸Given a predicate value with k true value in $\llbracket 0, 2^n \rrbracket$, Grover algorithm outputs one of these true values with good probability. The case in [50, p. 232] concerns cases where $k = 2^j$ for a given integer j .

⁹We still have a strong gain over their optimized encoding in terms of proof commands (39 vs 112), while roughly equivalent for code (53 vs 59 lines).

ZX-calculus is restricted to fixed circuits and cannot handle parametrized families of circuits or circuit-building languages.

Other quantum applications of formal methods. Huang *et al.* [40, 41] proposes a “runtime-monitoring like” verification method for quantum circuits, with an annotation language restricted to structural properties of interest (e.g., superposition or entanglement). Verification of these assertions is led by statistical testing instead of formal proofs. The recent Silq language [10] also represents an advance in the way toward automation in quantum programming. It automatizes uncomputation operations, enabling the programmer to abstract from low level implementation details. Another line of research is concerned with the development of specialized type systems for quantum programming languages. In particular, frameworks based on linear logic [48, 64, 65] and dependent types [56, 58] have been developed to tackle the non-duplicability of qubits and the constraints on the structure of circuits. Finally, formal methods are also at stake for the verification of protocols using quantum information, such as cryptographic protocols [14, 20, 31, 52, 53].

11 CONCLUSION

We have presented QBRICKS, the first formal verification environment for circuit-building quantum programs – featuring clear separation between code and proof, parametric specifications and proofs, high degree of proof automation and allowing to encode quantum programs in a natural way. We build on best practices of formal verification for the classical case and tailor them to the quantum case. Especially, while relying on the general framework of deductive verification, we design a new domain-specific circuit-building language QBRICKS-DSL for quantum programs together with a new logical specification language QBRICKS-SPEC and the novel Hybrid Quantum Hoare Logic. Finally, we introduce and intensively build upon *higher-order path sums* (HOPS), a symbolic representation convenient for both specification (parametricity) and automation (closure).

In order to demonstrate the interest of the full framework, we develop the first verified parametric implementations of three famous non-trivial quantum algorithms (namely Shor-OF, QPE and Grover search), proving by fact that applying formal verification to realistic (circuit-building) quantum programs is possible and should be further developed.

REFERENCES

- [1] Matthew Amy. 2019. *Formal Methods in Quantum Circuit Design*. Ph.D. Dissertation. University of Waterloo, Ontario, Canada. <http://hdl.handle.net/10012/14480>
- [2] Matthew Amy. 2019. Towards Large-scale Functional Verification of Universal Quantum Circuits. In *Proceedings 15th International Conference on Quantum Physics and Logic, QPL 2018 (Electronic Proceedings in Theoretical Computer Science)*, Peter Selinger and Giulio Chiribella (Eds.), Vol. 287. EPTCS, Halifax, Canada, 1–21. <https://doi.org/10.4204/EPTCS.287.1>
- [3] Matthew Amy, Martin Roetteler, and Krysta M. Svore. 2017. Verified Compilation of Space-Efficient Reversible Circuits. In *Proceedings of the 29th International Conference on Computer Aided Verification (CAV 2017), Part II (Lecture Notes in Computer Science)*, Rupak Majumdar and Viktor Kuncak (Eds.), Vol. 10427. Springer, Heidelberg, Germany, 3–21. https://doi.org/10.1007/978-3-319-63390-9_1
- [4] Frank Arute, Kunal Arya, Ryan Babbush, Dave Bacon, Joseph C. Bardin, Rami Barends, Rupak Biswas, Sergio Boixo, Fernando G. S. L. Brandao, David A. Buell, et al. 2019. Quantum supremacy using a programmable superconducting processor. *Nature* 574, 7779 (2019), 505–510.
- [5] Mike Barnett, Manuel Fähndrich, K. Rustan M. Leino, Peter Müller, Wolfram Schulte, and Herman Venter. 2011. Specification and verification: the Spec# experience. *Commun. ACM* 54, 6 (2011), 81–91. <https://doi.org/10.1145/1953122.1953145>
- [6] Stéphane Beauregard. 2002. Circuit for Shor’s algorithm using $2n + 3$ qubits. *arXiv preprint quant-ph/0205095* (2002).
- [7] Patrick Behm, Paul Benoit, Alain Faivre, and Jean-Marc Meynadier. 1999. Météor: A Successful Application of B in a Large Project. In *Proceedings of the World Congress on Formal Methods in the Development of Computing Systems (FM’99), Volume 1 (Lecture Notes in Computer Science)*, Jeannette M. Wing, Jim Woodcock, and Jim Davies (Eds.), Vol. 1708. Springer, Toulouse, France, 369–387. https://doi.org/10.1007/3-540-48119-2_22
- [8] Debjyoti Bhattacharjee, Mathias Soeken, Srijit Dutta, Anupam Chattopadhyay, and Giovanni De Micheli. 2019. Reversible Pebble Games for Reducing Qubits in Hierarchical Quantum Circuit Synthesis. In *Proceedings of the 49th IEEE International Symposium on Multiple-Valued Logic (ISMVL 2019)*. IEEE, Fredericton, NB, Canada, 102–107. <https://doi.org/10.1109/ISMVL.2019.00026>
- [9] Jacob Biamonte, Peter Wittek, Nicola Pancotti, Patrick Rebentrost, Nathan Wiebe, and Seth Lloyd. 2017. Quantum machine learning. *Nature* 549, 7671 (2017), 195. <https://doi.org/10.1038/nature23474>
- [10] Benjamin Bichsel, Maximilian Baader, Timon Gehr, and Martin T. Vechev. 2020. Silq: a high-level quantum language with safe uncomputation and intuitive semantics. In *Proceedings of the 41st ACM SIGPLAN International Conference on Programming Language Design and Implementation, PLDI 2020, London, UK, June 15-20, 2020*, Alastair F. Donaldson and Emina Torlak (Eds.). ACM, 286–300. <https://doi.org/10.1145/3385412.3386007>
- [11] François Bobot, Jean-Christophe Filliâtre, Claude Marché, and Andrei Paskevich. 2011. Why3: Shepherd Your Herd of Provers. In *Proceedings of Boogie 2011: First International Workshop on Intermediate Verification Languages*, Wrocław, Poland, 53–64. Available online as hal-00790310.
- [12] Jaap Boender, Florian Kammüller, and Rajagopal Nagarajan. 2015. Formalization of Quantum Protocols using Coq. In *Proceedings of the 12th International Workshop on Quantum Physics and Logic (QPL 2015) (Electronic Proceedings in Theoretical Computer Science)*, Chris Heunen, Peter Selinger, and Jamie Vicary (Eds.), Vol. 195. EPTCS, Oxford, UK, 71–83. <https://doi.org/10.4204/EPTCS.195.6>
- [13] Michel Boyer, Gilles Brassard, Peter Høyer, and Alain Tapp. 1998. Tight bounds on quantum searching. *Fortschritte der Physik: Progress of Physics* 46, 4-5 (1998), 493–505.
- [14] Anne Broadbent. 2018. How to Verify a Quantum Computation. *Theory of Computing* 14, 1 (2018), 1–37. <https://doi.org/10.4086/toc.2018.v014a011>
- [15] Isaac L. Chuang, Neil Gershenfeld, and Mark Kubinec. 1998. Experimental implementation of fast quantum searching. *Physical review letters* 80, 15 (1998), 3408. <https://doi.org/10.1103/PhysRevLett.80.3408>
- [16] Edmund M. Clarke and Jeannette M. Wing. 1996. Formal Methods: State of the Art and Future Directions. *ACM Computing Surveys (CSUR)* 28, 4 (1996), 626–643. <https://doi.org/10.1145/242223.242257>
- [17] Richard Cleve, Artur Ekert, Chiara Macchiavello, and Michele Mosca. 1998. Quantum algorithms revisited. *Proceedings of the Royal Society of London. Series A: Mathematical, Physical and Engineering Sciences* 454, 1969 (1998), 339–354. <https://doi.org/10.1098/rspa.1998.0164>
- [18] Bob Coecke and Aleks Kissinger. 2017. *Picturing quantum processes*. Cambridge University Press, Cambridge, United Kingdom.
- [19] Pascal Cuoq, Florent Kirchner, Nikolai Kosmatov, Virgile Prevosto, Julien Signoles, and Boris Yakobowski. 2012. Frama-C - A Software Analysis Perspective. In *Proceedings of the 10th International Conference on Software Engineering and Formal Methods (SEFM 2012) (Lecture Notes in Computer Science)*, George Eleftherakis, Mike Hinchey, and Mike Holcombe (Eds.), Vol. 7504. Springer, Thessaloniki, Greece, 233–247. https://doi.org/10.1007/978-3-642-33826-7_16
- [20] Timothy AS Davidson. 2012. *Formal verification techniques using quantum process calculus*. Ph.D. Dissertation. University of Warwick.

- [21] Niel de Beaudrap, Ross Duncan, Dominic Horsman, and Simon Perdrix. 2019. Pauli Fusion: a computational model to realise quantum transformations from ZX terms. (2019). Available online as arXiv:1904.12817.
- [22] Andrew Fagan and Ross Duncan. 2018. Optimising Clifford Circuits with Quantomatic. In *Proceedings of the 15th International Conference on Quantum Physics and Logic (QPL 2018) (Electronic Notes In Theoretical Computer Science)*, Peter Selinger and Giulio Chiribella (Eds.), Vol. 287. EPTCS, Halifax, Canada, 85–105. <https://doi.org/10.4204/EPTCS.287.5>
- [23] Edward Farhi, Jeffrey Goldstone, and Sam Gutmann. 2014. A quantum approximate optimization algorithm. (2014). Available online as arXiv:1411.4028.
- [24] Edward Farhi, Jeffrey Goldstone, Sam Gutmann, Joshua Lapan, Andrew Lundgren, and Daniel Preda. 2001. A quantum adiabatic evolution algorithm applied to random instances of an NP-complete problem. *Science* 292, 5516 (2001), 472–475. <https://doi.org/10.1126/science.1057726>
- [25] Richard P. Feynman. 1982. Simulating physics with computers. *International Journal of Theoretical Physics* 21, 6–7 (1982), 467–488. <https://doi.org/10.1007/BF02650179>
- [26] Jean-Christophe Filliâtre. 2011. Deductive software verification. *STTT* 13, 5 (2011), 397–403. <https://doi.org/10.1007/s10009-011-0211-0>
- [27] Jean-Christophe Filliâtre and Claude Marché. 2007. The Why/Krakatoa/Caduceus Platform for Deductive Program Verification. In *Proceedings of the 19th International Conference on Computer Aided Verification (CAV 2007) (Lecture Notes in Computer Science)*, Werner Damm and Holger Hermanns (Eds.), Vol. 4590. Springer, Berlin, Germany, 173–177. https://doi.org/10.1007/978-3-540-73368-3_21
- [28] Jean-Christophe Filliâtre and Andrei Paskevich. 2013. Why3 - Where Programs Meet Provers. In *Proceedings of the 22nd European Symposium on Programming Languages and Systems (ESOP 2013), Held as Part of the European Joint Conferences on Theory and Practice of Software (ETAPS 2013) (Lecture Notes in Computer Science)*, Matthias Felleisen and Philippa Gardner (Eds.), Vol. 7792. Springer, Rome, Italy, 125–128. https://doi.org/10.1007/978-3-642-37036-6_8
- [29] Simon J. Gay, Rajagopal Nagarajan, and Nikolaos Papanikolaou. 2008. QMC: A Model Checker for Quantum Systems. In *Proceeding of the 20th International Conference on Computer Aided Verification (CAV 2008) (Lecture Notes in Computer Science)*, Aarti Gupta and Sharad Malik (Eds.), Vol. 5123. Springer, Princeton, NJ, USA, 543–547. https://doi.org/10.1007/978-3-540-70545-1_51
- [30] Iulia M Georgescu, Sahel Ashhab, and Franco Nori. 2014. Quantum Simulation. *Reviews of Modern Physics* 86, 1 (2014), 153. <https://doi.org/10.1103/RevModPhys.86.153>
- [31] Alexandru Gheorghiu, Theodoros Kapourniotis, and Elham Kashefi. 2019. Verification of quantum computation: An overview of existing approaches. *Theory of Computing Systems* 63, 4 (2019), 715–808. <https://doi.org/10.1007/s00224-018-9872-3>
- [32] Georges Gonthier. 2008. Formal Proof — the Four-Color Theorem. *Notices of the AMS* 55, 11 (2008), 1382–1393. <https://www.ams.org/notices/200811/index.html>
- [33] Alexander S. Green, Peter LeFanu Lumsdaine, Neil J. Ross, Peter Selinger, and Benoît Valiron. 2013. Quipper: A Scalable Quantum Programming Language. In *Proceedings of the ACM SIGPLAN Conference on Programming Language Design and Implementation, (PLDI'13)*, Hans-Juergen Boehm and Cormac Flanagan (Eds.). ACM, Seattle, WA, USA, 333–342. <https://doi.org/10.1145/2491956.2462177>
- [34] Lov K. Grover. 1996. A Fast Quantum Mechanical Algorithm for Database Search. In *Proceedings of the Twenty-Eighth Annual ACM Symposium on the Theory of Computing (STOC)*, Gary L. Miller (Ed.). ACM, Philadelphia, Pennsylvania, USA, 212–219. <https://doi.org/10.1145/237814.237866>
- [35] W. Haaswijk, M. Soeken, A. Mishchenko, and G. De Micheli. 2019. SAT-Based Exact Synthesis: Encodings, Topology Families, and Parallelism. (2019). To appear in *IEEE Transactions on Computer-Aided Design of Integrated Circuits and Systems*, <https://doi.org/10.1109/TCAD.2019.2897703>.
- [36] Aram W. Harrow, Avinandan Hassidim, and Seth Lloyd. 2009. Quantum Algorithm for Linear Systems of Equations. *Physical Review Letters* 103 (Oct 2009), 150502. Issue 15. <https://doi.org/10.1103/PhysRevLett.103.150502>
- [37] Kesha Hietala, Robert Rand, Shih-Han Hung, Xiaodi Wu, and Michael Hicks. 2019. Verified Optimization in a Quantum Intermediate Representation. (2019). Available as arXiv:1904.06319.
- [38] Kesha Hietala, Robert Rand, Shih-Han Hung, Xiaodi Wu, and Michael Hicks. 2019. A Verified Optimizer for Quantum Circuits. (2019). Available as arXiv:1912.02250v1.
- [39] C. A. R. Hoare. 1969. An Axiomatic Basis for Computer Programming. *Commun. ACM* 12, 10 (1969), 576–580. <https://doi.org/10.1145/363235.363259>
- [40] Yipeng Huang and Margaret Martonosi. 2018. QDB: From Quantum Algorithms Towards Correct Quantum Programs. In *Proceedings of the 9th Workshop on Evaluation and Usability of Programming Languages and Tools (PLATEAU@SPLASH 2018) (OpenAccess Series in Informatics (OASICS))*, Titus Barik, Joshua Sunshine, and Sarah Chasins (Eds.), Vol. 67. Schloss Dagstuhl - Leibniz-Zentrum fuer Informatik, Boston, Massachusetts, USA, 4:1–4:14. <https://doi.org/10.4230/OASICS.PLATEAU.2018.4>

- [41] Yipeng Huang and Margaret Martonosi. 2019. Statistical assertions for validating patterns and finding bugs in quantum programs. In *Proceedings of the 46th International Symposium on Computer Architecture (ISCA 2019)*, Srilatha Bobbie Manne, Hillery C. Hunter, and Erik R. Altman (Eds.). ACM, Phoenix, AZ, USA, 541–553. <https://doi.org/10.1145/3307650.3322213>
- [42] IBM Blog. 2019. On Quantum Supremacy. Blog Article¹⁰.
- [43] Aleks Kissinger and John van de Wetering. 2019. Reducing T-count with the ZX-calculus. (2019). Available online as arXiv:1903.10477.
- [44] Aleks Kissinger and Vladimir Zamdzhiev. 2015. Quantomatic: A Proof Assistant for Diagrammatic Reasoning. In *Proceedings for the 25th International Conference on Automated Deduction (CADE-25) (Lecture Notes in Computer Science)*, Amy P. Felty and Aart Middeldorp (Eds.), Vol. 9195. Springer, Berlin, Germany, 326–336. https://doi.org/10.1007/978-3-319-21401-6_22
- [45] A Yu Kitaev. 1995. Quantum measurements and the Abelian stabilizer problem. (1995). Available online as arXiv:quant-ph/9511026.
- [46] Gerwin Klein, June Andronick, Kevin Elphinstone, Gernot Heiser, David Cock, Philip Derrin, Dhammika Elkaduwe, Kai Engelhardt, Rafal Kolanski, Michael Norrish, Thomas Sewell, Harvey Tuch, and Simon Winwood. 2010. seL4: formal verification of an operating-system kernel. *Communication of the ACM* 53, 6 (2010), 107–115. <https://doi.org/10.1145/1743546.1743574>
- [47] Emmanuel Knill. 1996. *Conventions for quantum pseudocode*. Technical Report. Los Alamos National Lab., NM (United States).
- [48] Ugo Dal Lago, Andrea Masini, and Margherita Zorzi. 2010. Quantum implicit computational complexity. *Theoretical Computer Science* 411, 2 (2010), 377–409. <https://doi.org/10.1016/j.tcs.2009.07.045>
- [49] Xavier Leroy et al. 2012. *The CompCert verified compiler. Documentation and user’s manual*. INRIA Paris-Rocquencourt.
- [50] Junyi Liu, Bohua Zhan, Shuling Wang, Shenggang Ying, Tao Liu, Yangjia Li, Mingsheng Ying, and Naijun Zhan. 2019. Formal Verification of Quantum Algorithms Using Quantum Hoare Logic. In *Computer Aided Verification*, Isil Dillig and Serdar Tasiran (Eds.). Springer International Publishing, Cham, 187–207.
- [51] Tao Liu, Yangjia Li, Shuling Wang, Mingsheng Ying, and Naijun Zhan. 2016. A Theorem Prover for Quantum Hoare Logic and Its Applications. (2016). Available as arXiv:1601.03835.
- [52] Urmila Mahadev. 2018. Classical Verification of Quantum Computations. In *Proceedings of the 59th IEEE Annual Symposium on Foundations of Computer Science (FOCS 2018)*, Mikkel Thorup (Ed.). IEEE Computer Society, Paris, France, 259–267. <https://doi.org/10.1109/FOCS.2018.00033>
- [53] Rajagopal Nagarajan and Simon Gay. 2002. Formal verification of quantum protocols. (2002). Available online as arXiv:quant-ph/0203086.
- [54] Michael A. Nielsen and Isaac Chuang. 2002. *Quantum computation and quantum information*. Cambridge University Press, Cambridge, United Kingdom.
- [55] Alexandru Paler. 2017. On the Influence of Initial Qubit Placement During NISQ Circuit Compilation. In *Proceedings of the First International Workshop on Quantum Technology and Optimization Problems (QTOPNetSys 2019) (Lecture Notes in Computer Science)*, Sebastian Feld and Claudia Linnhoff-Popien (Eds.), Vol. 11413. Springer, Munich, Germany, 207–217. https://doi.org/10.1007/978-3-030-14082-3_18
- [56] Luca Paolini, Mauro Piccolo, and Margherita Zorzi. 2019. qPCF: Higher-Order Languages and Quantum Circuits. *Journal of Automated Reasoning* 63, 4 (Dec 2019), 941–966. <https://doi.org/10.1007/s10817-019-09518-y>
- [57] Alex Parent, Martin Roetteler, and Krysta M. Svore. 2017. REVS: A Tool for Space-Optimized Reversible Circuit Synthesis. In *Proceedings of the 9th International Conference on Reversible Computation (RC 2017) (Lecture Notes in Computer Science)*, Iain Phillips and Hafizur Rahaman (Eds.), Vol. 10301. Springer, Kolkata, India, 90–101. https://doi.org/10.1007/978-3-319-59936-6_7
- [58] Jennifer Paykin, Robert Rand, and Steve Zdancewic. 2017. QWIRE: a Core Language for Quantum Circuits. In *Proceedings of the 44th ACM SIGPLAN Symposium on Principles of Programming Languages (POPL’17)*, Giuseppe Castagna and Andrew D. Gordon (Eds.). ACM, Paris, France, 846–858. <https://doi.org/10.1145/3009837.3009894>
- [59] John Preskill. 2018. Quantum Computing in the NISQ era and beyond. *Quantum* 2 (2018), 79. <https://doi.org/10.22331/q-2018-08-06-79>
- [60] Quantum Computing Report. 2019. List of Tools. Available online¹¹.
- [61] Robert Rand. 2018. *Formally Verified Quantum Programming*. Ph.D. Dissertation. University of Pennsylvania.
- [62] Robert Rand, Jennifer Paykin, Dong-Ho Lee, and Steve Zdancewic. 2018. ReQWIRE: Reasoning about Reversible Quantum Circuits. In *Proceedings 15th International Conference on Quantum Physics and Logic (QPL 2018) (Electronic*

¹⁰<https://www.ibm.com/blogs/research/2019/10/on-quantum-supremacy/>

¹¹<https://quantumcomputingreport.com/resources/tools/>

- Proceedings in Theoretical Computer Science*), Peter Selinger and Giulio Chiribella (Eds.), Vol. 287. EPTCS, Halifax, Canada, 299–312. <https://doi.org/10.4204/EPTCS.287.17>
- [63] Robert Rand, Jennifer Paykin, and Steve Zdancewic. 2017. QWIRE Practice: Formal Verification of Quantum Circuits in Coq. In *Proceedings 14th International Conference on Quantum Physics and Logic (QPL 2017) (Electronic Proceedings in Theoretical Computer Science)*, Bob Coecke and Aleks Kissinger (Eds.), Vol. 266. EPTCS, Nijmegen, The Netherlands, 119–132. <https://doi.org/10.4204/EPTCS.266.8>
- [64] Neil J. Ross. 2015. *Algebraic and Logical Methods in Quantum Computation*. Ph.D. Dissertation. Dalhousie University.
- [65] Peter Selinger and Benoît Valiron. 2006. A Lambda Calculus for Quantum Computation with Classical Control. *Mathematical Structures in Computer Science* 16 (2006), 527–552.
- [66] Peter W. Shor. 1994. Algorithms for Quantum Computation: Discrete Log and Factoring. In *Proceedings of the 35th Annual Symposium on Foundations of Computer Science (FOCS'94)*. IEEE, IEEE Computer Society Press, Santa Fe, New Mexico, US., 124–134. <https://doi.org/10.1109/SFCS.1994.365700>
- [67] Mathias Soeken, Thomas Häner, and Martin Roetteler. 2018. Programming Quantum Computers Using Design Automation. (2018). Available online as arXiv:1803.01022.
- [68] Damian S. Steiger, Thomas Häner, and Matthias Troyer. 2018. ProjectQ: an open source software framework for quantum computing. *Quantum* 2 (Jan. 2018), 49. <https://doi.org/10.22331/q-2018-01-31-49>
- [69] Krysta M Svore, Alan Geller, Matthias Troyer, John Azariah, Christopher Granade, Bettina Heim, Vadym Kliuchnikov, Mariia Mykhailova, Andres Paz, and Martin Roetteler. 2018. Q#: Enabling scalable quantum computing and development with a high-level domain-specific language. (2018). Available online as arXiv:1803.00652.
- [70] Krysta M. Svore and Matthias Troyer. 2016. The Quantum Future of Computation. *IEEE Computer* 49, 9 (2016), 21–030. <https://doi.org/10.1109/MC.2016.293>
- [71] Swamit S. Tannu and Moinuddin K. Qureshi. 2019. Not All Qubits Are Created Equal: A Case for Variability-Aware Policies for NISQ-Era Quantum Computers. In *Proceedings of the Twenty-Fourth International Conference on Architectural Support for Programming Languages and Operating Systems, (ASPLOS 2019)*, Iris Bahar, Maurice Herlihy, Emmett Witchel, and Alvin R. Lebeck (Eds.). ACM, Providence, RI, USA, 987–999. <https://doi.org/10.1145/3297858.3304007>
- [72] Benoît Valiron, Neil J. Ross, Peter Selinger, Dana Scott Alexander, and Jonathan M. Smith. 2015. Programming the quantum future. *Commun. ACM* 58, 8 (2015), 52–61. <https://doi.org/10.1145/2699415>
- [73] Dave Wecker and Krysta M Svore. 2014. LIQ|i>: A software design architecture and domain-specific language for quantum computing. (2014). Available online as arXiv:1402.4467.
- [74] Mingsheng Ying. 2011. Floyd-hoare logic for quantum programs. *ACM Transactions on Programming Languages and Systems (TOPLAS)* 33, 6 (2011), 19:1–19:49. <https://doi.org/10.1145/2049706.2049708>
- [75] Mingsheng Ying. 2019. Toward automatic verification of quantum programs. *Formal Aspects of Computing* 31, 1 (2019), 3–25. <https://doi.org/10.1007/s00165-018-0465-3>
- [76] Mingsheng Ying, Yangjia Li, Nengkun Yu, and Yuan Feng. 2014. Model-Checking Linear-Time Properties of Quantum Systems. *ACM Transactions on Computational Logic* 15, 3 (2014), 22:1–22:31. <https://doi.org/10.1145/2629680>
- [77] Mingsheng Ying, Shenggang Ying, and Xiaodi Wu. 2017. Invariants of quantum programs: characterisations and generation. In *Proceedings of the 44th ACM SIGPLAN Symposium on Principles of Programming Languages (POPL 2017)*. ACM, Paris, France, 818–832. <http://dl.acm.org/citation.cfm?id=3009840>

A MATRIX SEMANTICS FOR GATES

The following Table gives the matrix semantics for gates that are used in this article, bringing complements to Section 5.1.

CNOT	SWAP	ID	H	Ph(n)	$R_z(n)$
$\begin{pmatrix} 1 & 0 & 0 & 0 \\ 0 & 1 & 0 & 0 \\ 0 & 0 & 0 & 1 \\ 0 & 0 & 1 & 0 \end{pmatrix}$	$\begin{pmatrix} 1 & 0 & 0 & 0 \\ 0 & 0 & 1 & 0 \\ 0 & 1 & 0 & 0 \\ 0 & 0 & 0 & 1 \end{pmatrix}$	$\begin{pmatrix} 1 & 0 \\ 0 & 1 \end{pmatrix}$	$\frac{1}{\sqrt{2}} \begin{pmatrix} 1 & 1 \\ 1 & -1 \end{pmatrix}$	$\begin{pmatrix} e^{\frac{2i\pi}{2^n}} & 0 \\ 0 & e^{\frac{2i\pi}{2^n}} \end{pmatrix}$	$\begin{pmatrix} e^{\frac{-2i\pi}{2^n}} & 0 \\ 0 & e^{\frac{2i\pi}{2^n}} \end{pmatrix}$

Table 16. Matrix semantics for gates

B COMPLETE DEDUCTION RULES FOR RELATION ($_ \triangleright _$)

In this section we first introduce some additional definitions and notations about bit-vectors and kets, completing Section 6.1. Here and in the following we commit the abuse to treat boolean values `tt` and `ff` as, respectively, 0 and 1, omitting the call for the required cast function.

B.1 Additional notations and definitions for bit-vectors and kets. *Bit vectors.* Type `bitvector` is an opaque type with two operators

$$\begin{aligned} \text{bv_length} & : \text{bitvector} \rightarrow \text{int} \\ \text{bv_get} & : \text{bitvector} \rightarrow \text{int} \rightarrow \text{int} \end{aligned}$$

and invariants

$$\begin{aligned} \Gamma, \vec{x} : \text{bitvector} & \vdash \{ \top \} \text{bv_length}(\vec{x}) \{ \text{result} \geq 0 \} \\ \Gamma, \vec{x} : \text{bitvector}, i : \text{int} & \vdash \{ i \in \llbracket 0, \text{bv_length}(\vec{x}) \rrbracket \} \text{bv_get}(\vec{x}, i) \{ \text{result} \in \llbracket 0, 2 \rrbracket \} \end{aligned}$$

We usually abbreviate $\text{bv_get}(\vec{x}, i)$ by \vec{x}_i . Type `bitvector` is given with constructors `bv_set` and `bv_cst`. Let f be an integer function with values in $\{0, 1\}$ and let n be a positive integer. Then we define $\text{make_bv}(f, n)$ as the sequence $(f(0))(f(1)) \dots (f(n-1))$. Formally, let us first introduce predicate `binary`:

$$\Gamma, f : \text{int} \rightarrow \text{int}, i : \text{int} \vdash_{\text{def}} \{ i \in \llbracket 0, s \rrbracket \} \text{binary}_s(f) \{ \text{result} = f(i) \in \llbracket 0, 2 \rrbracket \}$$

then:

$$\begin{aligned} \Gamma, f : \text{int} \rightarrow \text{int}, i : \text{int} & \vdash \\ \{ i \in \llbracket 0, s \rrbracket, \text{binary}_s(f) \} & \text{make_bv}(f, s) \{ \text{bv_length}(\text{result}) = s \wedge \text{result}_i = f(i) \} \end{aligned}$$

We also define concatenation of bit vectors \vec{x} and \vec{y} . It satisfies:

$$\begin{aligned} \Gamma, \vec{x}, \vec{y}, i : \text{int} : \text{bitvector} & \vdash \\ \{ \top \} \text{concat}(\vec{x}, \vec{y}) & \left\{ \begin{array}{l} \text{bv_length}(\text{result}) = \\ \text{bv_length}(\vec{x}) + \text{bv_length}(\vec{y}) \end{array} \right\} \\ \{ i \in \llbracket 0, \text{bv_length}(\vec{x}) \rrbracket \} & \text{concat}(\vec{x}, \vec{y}) \{ \text{result}_i = \vec{x}_i \} \\ \left\{ \begin{array}{l} i \in \llbracket \text{bv_length}(\vec{x}), \\ \text{bv_length}(\vec{x}) + \text{bv_length}(\vec{y}) \rrbracket \end{array} \right\} & \text{concat}(\vec{x}, \vec{y}) \{ \text{result}_i = \vec{y}_{i - \text{bv_length}(\vec{x})} \} \end{aligned}$$

Let \vec{x} be a bit vector and let i, j integers $\llbracket 0, \text{bv_length}(\vec{x}) \rrbracket$ such that $i < j$, then we introduce sections of \vec{x} in, respectively, $\llbracket 0, i \rrbracket$, $\llbracket i + 1, \text{bv_length}(\vec{x}) \rrbracket$ and $\llbracket i + 1, j \rrbracket$. They satisfy the following rules:

$\Gamma, \vec{x} : \text{bitvector}, i, j, k : \text{int} \vdash$

$$\left\{ \begin{array}{l} j \in \llbracket 0, \text{bv_length}(\vec{x}) \rrbracket \\ k \in \llbracket 0, \text{bv_length}(\vec{x} - i) \rrbracket \end{array} \right\} \vec{x}_{\uparrow i} \left\{ \begin{array}{l} \text{bv_length}(\text{result}) = \vec{x} - i \\ \text{result}_k = \vec{x}_{k+i} \end{array} \right\},$$

$$\left\{ \begin{array}{l} j \in \llbracket 0, \text{bv_length}(\vec{x}) \rrbracket \\ k \in \llbracket 0, j \rrbracket \end{array} \right\} \vec{x}_{\uparrow j} \left\{ \begin{array}{l} \text{bv_length}(\text{result}) = j, \\ \text{result}_k = \vec{x}_k \end{array} \right\}$$

$$\left\{ \begin{array}{l} i \in \llbracket 0, \text{bv_length}(\vec{x}) \rrbracket \\ j \in \llbracket i, \text{bv_length}(\vec{x}) \rrbracket \\ k \in \llbracket 0, \text{bv_length}(j - i) \rrbracket \end{array} \right\} \vec{x}_{\uparrow i:j} \left\{ \begin{array}{l} \text{bv_length}(\text{result}) = i - j \\ \text{result}_k = \vec{x}_{k+j} \end{array} \right\}$$

At last we introduce two functions `bv_to_int` and `int_to_bv`, from bit vectors to integers and back, enabling the interpretation of a bit vector as a binary integer :

$$\Gamma, x : \text{bitvector} \quad \vdash$$

$$\{\top\} \text{bv_to_int}(\vec{x}) \left\{ \text{result} = \sum_{k=0}^{\text{bv_length}(\vec{x})-1} \vec{x}_k * 2^{\text{bv_length}(\vec{x})-k-1} \right\}$$

$$\Gamma, x : \text{bitvector}, k, n, i : \text{int} \quad \vdash$$

$$\{0 \leq n, k \in \llbracket 0, 2^n \rrbracket, i \in \llbracket 0, n \rrbracket\} \text{int_to_bv}(k, n) \left\{ \begin{array}{l} \text{bv_length}(\text{result}) = n \\ \text{result}_i = \text{div}(\text{mod } k \ 2^{n-i+1}) \ 2 \end{array} \right\}$$

B.2 Kets. Type `ket` is an opaque type, similar as bit-vectors with complex values. Kets have a number of cells equal to 2^n , for a positive integer n called its logarithmic length (also called, for simplicity, its length). They are defined without norm restriction. Usually, we designate kets using the standard Dirac notation $|v\rangle_n$, with n being the logarithmic length of $|v\rangle$. We drop this n index when unnecessary.

Dirac notation is also used as notation for functions casting integers and bit vectors to kets : let k, n be integers such that $k \in \llbracket 0, 2^n \rrbracket$ and let \vec{x} be a bit vector. Then:

$$\Gamma, k, n, i : \text{int} \vdash$$

$$\{0 \leq n, k \in \llbracket 0, 2^n \rrbracket\} |k\rangle_n \left\{ \text{ket_length}(\text{result}) = n \right\}$$

$$\{0 \leq n, k \in \llbracket 0, 2^n \rrbracket\} |k\rangle_n \left\{ \text{ket_get}(\text{result}, k) = 1 \right\}$$

$$\{0 \leq n, k \in \llbracket 0, 2^n \rrbracket, i \in \llbracket 0, 2^n \rrbracket, i < k\} |k\rangle_n \left\{ \text{ket_get}(\text{result}, i) = 0 \right\}$$

Functions `+`, `-`, `⊗` are introduced and used the usual way over kets :

$\Gamma, |v\rangle, |w\rangle : \text{ket}, i : \text{int} \vdash$

$$\{\top\} |v\rangle \otimes |w\rangle \left\{ \begin{array}{l} \text{ket_length}(\text{result}) = \\ \text{ket_length}(|v\rangle) + \text{ket_length}(|w\rangle) \end{array} \right\}$$

$$\left\{ \begin{array}{l} i \in \llbracket 0, \text{ket_length}(|v\rangle) + \\ \text{ket_length}(|w\rangle) \rrbracket \end{array} \right\} |v\rangle \otimes |w\rangle \left\{ \begin{array}{l} \text{ket_get}(\text{result}, i) = \\ \text{ket_get}(|v\rangle, \text{div } i \ 2^{n_2}) * \text{ket_get}(|w\rangle, \text{mod } i \ 2^{n_2}) \end{array} \right\}$$

$$\{\top\} |v\rangle + |w\rangle \left\{ \text{ket_length}(\text{result}) = \text{ket_length}(|v\rangle) \right\}$$

$$\left\{ \begin{array}{l} i \in \llbracket 0, \text{ket_length}(|v\rangle) \rrbracket \\ \text{ket_length}(|v\rangle) = \\ \text{ket_length}(|w\rangle) \end{array} \right\} |v\rangle + |w\rangle \left\{ \text{ket_get}(\text{result}, i) = \text{ket_get}(|v\rangle, i) + \text{ket_get}(|w\rangle, i) \right\}$$

$$\{\top\} |v\rangle - |w\rangle \left\{ \text{ket_length}(\text{result}) = \text{ket_length}(|v\rangle) \right\}$$

$$\left\{ \begin{array}{l} i \in \llbracket 0, \text{ket_length}(|v\rangle) \rrbracket \\ \text{ket_length}(|v\rangle) = \\ \text{ket_length}(|w\rangle) \end{array} \right\} |v\rangle - |w\rangle \left\{ \text{ket_get}(\text{result}, i) = \text{ket_get}(|v\rangle, i) - \text{ket_get}(|w\rangle, i) \right\}$$

C DEDUCTIVE RULES FOR RELATION ($_ \triangleright _$)

In this section, we complete the introduction of deductive rules for relation ($_ \triangleright _$) from Section 7.2. We first give rules for gates, then rules for composed circuits.

C.1 Gates hops characterization predicates. For any gate in the language, we first introduce a specific predicate characterizing an hops for this gate. Predicate `hops_had`, for Hadamard gate, was given in Section 7.2, below are similar predicates for the additional gates;

ID

$$\begin{aligned} \text{hops_id}(h, \vec{x}, \vec{y}) &:= \text{bv_length}(\vec{x}) = 1 \wedge \text{bv_length}(\vec{y}) = 0 \rightarrow \\ &\quad \text{hops_width}(h) = 1 \wedge \text{hops_range}(h) = 0 \wedge \\ &\quad \text{hops_angle}(h)(\vec{x}, \vec{y}) = 1 \wedge \text{hops_ket}(h)(\vec{x}, \vec{y}) = \vec{x} \end{aligned}$$

SWAP

$$\begin{aligned} \text{hops_swap}(h, \vec{x}, \vec{y}) &:= \text{bv_length}(\vec{x}) = 2 \wedge \text{bv_length}(\vec{y}) = 0 \rightarrow \\ &\quad \text{hops_width}(h) = 2 \wedge \text{hops_range}(h) = 0 \wedge \\ &\quad \text{hops_angle}(h)(\vec{x}, \vec{y}) = 1 \wedge \text{hops_ket}(h)(\vec{x}, \vec{y}) = \text{bv_set}(\text{bv_get}(\vec{x}, 0), 0, \text{bv_get}(\vec{x}, 1)) \end{aligned}$$

Ph

$$\begin{aligned} \text{hops_phase}(h, n, \vec{x}, \vec{y}) &:= 0 \leq n \wedge \text{bv_length}(\vec{x}) = 1 \wedge \text{bv_length}(\vec{y}) = 0 \rightarrow \\ &\quad \text{hops_width}(h) = 1 \wedge \text{hops_range}(h) = 0 \wedge \\ &\quad \text{hops_angle}(h)(\vec{x}, \vec{y}) = e^{\frac{2\pi i}{2^n}} \wedge \text{hops_ket}(h)(\vec{x}, \vec{y}) = \vec{x} \end{aligned}$$

Rz

$$\begin{aligned} \text{hops_rz}(h, n, \vec{x}, \vec{y}) &:= 0 \leq n \wedge \text{bv_length}(\vec{x}) = 1 \wedge \text{bv_length}(\vec{y}) = 0 \rightarrow \\ &\quad \text{hops_width}(h) = 1 \wedge \text{hops_range}(h) = 0 \wedge \\ &\quad \text{hops_angle}(h)(\vec{x}, \vec{y}) = e^{(-1)^{1-\vec{x}_0} \frac{2\pi i}{2^n}} \wedge \text{hops_ket}(h)(\vec{x}, \vec{y}) = \vec{x} \end{aligned}$$

CNOT

$$\begin{aligned} \text{hops_cnot}(h, \vec{x}, \vec{y}) &:= (\text{bv_length}(\vec{x}) = 2 \wedge \text{bv_length}(\vec{y}) = 0) \rightarrow \\ &\quad \text{hops_width}(h) = 2 \wedge \text{hops_range}(h) = 0 \wedge \\ &\quad \text{hops_angle}(h)(\vec{x}, \vec{y}) = 1 \wedge \text{hops_ket}(h)(\vec{x}, \vec{y}) = \vec{x}_0 \cdot ((1 - \vec{x}_0)\vec{x}_1 + \vec{x}_0(1 - \vec{x}_1)) \end{aligned}$$

C.2 Combining circuits. We also introduce binary and ternary relations between hops, so as to characterize the conditions for relation ($_ \triangleright _$) in combined circuits. This induces one hops relation per circuit combinator:

Sequence composition

$$\begin{aligned} \text{hops_seq}(h_1, h_2, h_3, \vec{x}, \vec{y}) := & \\ & \left(\begin{array}{l} \text{bv_length}(\vec{x}) = \text{hops_width}(h_1), \\ \text{bv_length}(\vec{y}) = \text{hops_range}(h_1) + \text{hops_range}(h_2) \wedge \\ \text{hops_width}(h_1) = \text{hops_width}(h_2) \wedge \end{array} \right) \\ & \rightarrow \\ & \left(\begin{array}{l} \text{hops_width}(h_3) = \text{hops_width}(h_1) \wedge \\ \text{hops_range}(h_3) = \text{hops_range}(h_1) + \text{hops_range}(h_2) \wedge \\ (\text{hops_angle}(h_3)(\vec{x}, \vec{y}) = \text{hops_angle}(h_1)(\vec{x}, \vec{y}_{\text{hops_range}(h_2)\uparrow}) + a \\ \text{hops_angle}(h_2)(\text{hops_ket}(h_1)(\vec{x}, \vec{y}_{\text{hops_range}(h_2)\uparrow}), \vec{y}_{1\text{hops_range}(h_2)})) \wedge \\ (\text{hops_ket}(h_3)(\vec{x}, \vec{y}) = \text{hops_ket}(h_2)(\text{hops_ket}(h_1)(\vec{x}, \vec{y}_{\text{hops_range}(h_2)\uparrow}), \vec{y}_{1\text{hops_range}(h_2)})) \end{array} \right) \end{aligned}$$

Parallel composition

$$\begin{aligned} \text{hops_par}(h_1, h_2, h_3, \vec{x}, \vec{y}) := & \\ & \left(\begin{array}{l} \text{bv_length}(\vec{x}) = \text{hops_width}(h_1) + \text{hops_width}(h_2) \wedge \\ \text{bv_length}(\vec{y}) = \text{hops_range}(h_1) + \text{hops_range}(h_2) \end{array} \right) \\ & \rightarrow \\ & \left(\begin{array}{l} \text{hops_width}(h_3) = \text{hops_width}(h_1) + \text{hops_width}(h_2) \wedge \\ \text{hops_range}(h_3) = \text{hops_range}(h_1) + \text{hops_range}(h_2) \wedge \\ (\text{hops_angle}(h_3)(\vec{x}, \vec{y}) = \text{hops_angle}(h_1)(\vec{x}_{\text{hops_width}(h_2)\uparrow}, \vec{y}_{\text{hops_range}(h_2)\uparrow}) + a \\ \text{hops_angle}(h_2)(\vec{x}_{1\text{hops_width}(h_2)}, \vec{y}_{1\text{hops_range}(h_2)})) \wedge \\ (\text{hops_ket}(h_3)(\vec{x}, \vec{y}) = \text{hops_ket}(h_1)(\vec{x}_{\text{hops_width}(h_2)\uparrow}, \vec{y}_{\text{hops_range}(h_2)\uparrow}) \otimes \\ \text{hops_ket}(h_2)(\vec{x}_{1\text{hops_width}(h_2)}, \vec{y}_{1\text{hops_range}(h_2)})) \end{array} \right) \end{aligned}$$

Control composition

$$\begin{aligned} \text{hops_ctl}(h_1, h_2, c, \vec{x}, \vec{y}) := & \\ & (\text{bv_length}(\vec{x}) = \text{hops_width}(h_1) + 1 \wedge \text{bv_length}(\vec{y}) = \text{hops_range}(h_1)) \\ & \rightarrow \\ & \left(\begin{array}{l} \text{hops_width}(h_2) = \text{hops_width}(h_1) + 1 \wedge \text{hops_range}(h_2) = \text{hops_range}(h_1) \wedge \\ (\text{hops_angle}(h_2)(\vec{x}, \vec{y}) = \vec{x}_0 * \text{hops_angle}(h_1)(\vec{x}_{1\uparrow}, \vec{y}) + (1 - \vec{x}_0)) \wedge \\ (\text{hops_ket}(h_2)(\vec{x}, \vec{y}) = \text{if } \vec{x}_0 = 1 \text{ then } \text{concat}(\text{bv_cst}(1, 1), \text{hops_ket}(h_1)(\vec{x}_{1\uparrow}, \vec{y})) \text{ else } \vec{x}) \end{array} \right) \end{aligned}$$

Ancilla composition

$$\begin{aligned} \text{hops_ancilla}(h_1, h_2, \vec{x}, \vec{y}) := & \\ & \left(\begin{array}{l} \{\text{hops_width}(h_2) = \text{hops_width}(h_1) - 1 \wedge \\ \text{bv_length}(\vec{x}) = \text{hops_width}(h_2) \wedge \text{bv_length}(\vec{y}) = \text{hops_range}(h_2) \wedge \\ \vec{x}_{\text{hops_width}(h_1-1)} = 0\} \rightarrow (\text{hops_ket}(h_1)(\vec{x}, \vec{y}))_{\text{hops_width}(h_1-1)} = 0 \end{array} \right) \\ & \rightarrow \\ & \left(\begin{array}{l} \text{hops_width}(h_2) = \text{hops_width}(h_1) - 1 \wedge \text{hops_range}(h_2) = \text{hops_range}(h_1) \wedge \\ \text{hops_angle}(h_2)(\vec{x}, \vec{y}) = \text{hops_ket}(h_1)(\text{concat}(\vec{x}, \text{bv_cst}(1, 0)), \vec{y}) \wedge \\ \text{concat}(\text{hops_ket}(h_2)(\vec{x}, \vec{y}), \text{bv_cst}(1, 0)) = \text{hops_angle}(h_1)(\text{concat}(\vec{x}, \text{bv_cst}(1, 0)), \vec{y}) \end{array} \right) \end{aligned}$$

C.3 Deduction rules. As introduced in Section 7.2, the characterization predicates introduced so far serve as hypotheses for compositional deduction rules for relation (\triangleright) . These rules are given in Table 17.

C.4 Circuit size deduction rules. We end up this section by providing the compositional deduction rules for circuit sizes, in Figure 18 : SWAP and ID gates have size 0, the other gates have size 1, composing two circuits either in sequence or in parallel adds up their sizes, controlling a

$\frac{\Gamma, \vec{x}, \vec{y} : \text{bitvector} \vdash \text{hops_id}(h, \vec{x}, \vec{y})}{\Gamma \vdash (\text{ID} \triangleright h)} \text{ id}$
$\frac{\Gamma, \vec{x}, \vec{y} : \text{bitvector} \vdash \text{hops_swap}(h, \vec{x}, \vec{y})}{\Gamma \vdash (\text{SWAP} \triangleright h)} \text{ swap}$
$\frac{\Gamma, \vec{x}, \vec{y} : \text{bitvector} \vdash \text{hops_had}(h, \vec{x}, \vec{y})}{\Gamma \vdash (\text{H} \triangleright h)} \text{ had}$
$\frac{\Gamma, \vec{x}, \vec{y} : \text{bitvector} \vdash \text{hops_phase}(p, h, \vec{x}, \vec{y})}{\Gamma \vdash (\text{Ph}(p) \triangleright h)} \text{ phase}$
$\frac{\Gamma, \vec{x}, \vec{y} : \text{bitvector} \vdash \text{hops_rz}(p, h, \vec{x}, \vec{y})}{\Gamma \vdash (\text{R}_z(p) \triangleright h)} \text{ rz}$
$\frac{\Gamma, \vec{x}, \vec{y} : \text{bitvector} \vdash \text{hops_cnot}(h, \vec{x}, \vec{y})}{\Gamma \vdash (\text{CNOT} \triangleright h)} \text{ cnot}$
$\frac{\Gamma \vdash (C_1 \triangleright h_1) \quad \Gamma \vdash (C_2 \triangleright h_2) \quad \Gamma, \vec{x}, \vec{y} : \text{bitvector} \vdash \text{hops_seq}(h_1, h_2, h_3, \vec{x}, \vec{y})}{\Gamma \vdash (\text{SEQ}(C_1, C_2) \triangleright h_3)} \text{ seq}$
$\frac{\Gamma \vdash (C_1 \triangleright h_1) \quad \Gamma \vdash (C_2 \triangleright h_2) \quad \Gamma, \vec{x}, \vec{y} : \text{bitvector} \vdash \text{hops_par}(h_1, h_2, h_3, \vec{x}, \vec{y})}{\Gamma \vdash (\text{PAR}(C_1, C_2) \triangleright h_3)} \text{ par}$
$\frac{\Gamma \vdash (C \triangleright h_1) \quad \Gamma, (\vec{x}, \vec{y} : \text{bitvector}) \vdash \text{hops_ctl}(h_1, h_2, k, \vec{x}, \vec{y})}{\Gamma \vdash (\text{CTL}(C) \triangleright h_2)} \text{ ctl}$
$\frac{\Gamma \vdash (C \triangleright h_1) \quad \Gamma, (\vec{x}, \vec{y} : \text{bitvector}) \vdash \text{hops_ancilla}(h_1, h_2, k, \vec{x}, \vec{y})}{\Gamma \vdash (\text{ANC}(C) \triangleright h_2)} \text{ ancilla}$
$\frac{\Gamma \vdash (C \triangleright h_1) \quad \Gamma \vdash \text{hopsequiv}(h_1, h_2)}{\Gamma \vdash (C \triangleright h_2)} \text{ hosp_subst}$

Fig. 17. Deduction rules for relation $(_ \triangleright _)$

circuit raises its size by factor at most constant `ctl-size-const` and discarding an ancilla qubit does not affect the size of a circuit.

D REASONING ABOUT HOPS: SPECIAL CIRCUIT SUBCLASSES

In this section, we complement Section 7.4 by presenting reasoning rules dedicated to specific cases of circuits, namely flat and diagonal circuits.

D.1 Flat circuits. Observe from definitions in Section C.1 that all gates but Hadamard have a correct hops with `hops_range` equal to 0. We call an hops with range 0 an hop, and we call the circuit property of admitting a correct hop being *flat*.

One easily observes that flatness is stable through sequence, parallel, control and ancilla composition. In an hop h , function `hops_apply` is a pseudo-sum of one term, indexed by the only bit-vector \vec{y} of length 0 (written (\cdot^0)). Then we defined functions `flat_h_ket` and `flat_h_angle`

$\frac{C \in \{\text{ID}, \text{SWAP}\}}{\text{width}(C) = 0}$	Id-SWAP-size	$\frac{C \in \{\text{H}, \text{Ph}(n), \text{R}_z(n)\}}{\text{size}(C) = 1}$	gate-size
$\frac{\Gamma \vdash \text{size}(C_1) = n_1 \quad \Gamma \vdash \text{size}(C_2) = n_2 \quad \Gamma \vdash \text{width}(C_1) = \text{width}(C_2)}{\Gamma \vdash \text{size}(\text{SEQ}(C_1, C_2)) = n_1 + n_2}$		seq-size	
$\frac{\Gamma \vdash \text{size}(C_1) = n_1 \quad \Gamma \vdash \text{size}(C_2) = n_2}{\Gamma \vdash \text{size}(\text{PAR}(C_1, C_2)) = n_1 + n_2}$		par-size	
$\frac{\Gamma \vdash 0 \leq k, k + \text{width}(C) < n, \quad 0 \leq c < \text{qsize}(\text{GC}), k \leq c \rightarrow i + \text{width}(G) < c}{\Gamma \vdash \text{size}(\text{CTL}(C, c, k, n)) \leq \text{ctl-size-const} * n}$		ctl-size	
$\frac{\Gamma \vdash (C \triangleright H_1) \quad \Gamma \vdash \text{hops_ancilla}(H_1, H_2, k)}{\Gamma \vdash \text{size}(\text{ANC}(C, k) = \text{size}(C))}$		anc-size	

Fig. 18. Deduction rules for QBRICKS: size (number of gates)

over hop. They ensure

$\Gamma, x : \text{bitvector}, h : \text{hops} \vdash$

$$\left\{ \begin{array}{l} \text{bv_length}(\vec{x}) = \text{hops_width}(h) \wedge \\ \text{bv_length}(\vec{y}) = 0 \wedge \\ \text{hops_range}(h = 0) \end{array} \right\} \quad \text{flat_h_angle}(h, \vec{x}) \quad \{\text{result} = \text{hops_angle}(h)(\vec{x}, \vec{y})\},$$

$$\left\{ \begin{array}{l} \text{bv_length}(\vec{x}) = \text{hops_width}(h) \wedge \\ \text{bv_length}(\vec{y}) = 0 \wedge \\ \text{hops_range}(h = 0) \end{array} \right\} \quad \text{flat_h_ket}(h, \vec{x}) \quad \{\text{result} = \text{hops_ket}(h)(\vec{x}, \vec{y})\}$$

and we have:

$\Gamma, x : \text{bitvector}, h : \text{hops} \vdash$

$$\left\{ \begin{array}{l} \text{bv_length}(\vec{x}) = \text{hops_width}(h), \\ \text{hops_range}(h) = 0 \end{array} \right\} \quad \text{hops_apply}(h, |\vec{x}\rangle) \quad \left\{ \begin{array}{l} \text{result} = \\ \text{flat_h_angle}(h, \vec{x}) | \text{flat_h_ket}(h, \vec{x}) \end{array} \right\}$$

Furthermore, for any given flat circuit C , functions `flat_h_angle` and `flat_h_ket` are actually independent of the choice of an hop correct for C . Formally, we have the following theorem :

$\Gamma, h_1, h_2 : \text{hops}, C : \text{circ}, \vec{x} : \text{bitvector} \vdash$

$$\left\{ \begin{array}{l} \text{hops_range}(h_1) = 0, \\ \text{hops_range}(h_2) = 0, \\ (h_1 \triangleright C), (h_2 \triangleright C) \end{array} \right\} \quad h_1 \quad \left\{ \begin{array}{l} \text{flat_h_ket}(\text{result}, \vec{x}) = \text{flat_h_ket}(h_2, \vec{y}), \\ \text{flat_h_angle}(\text{result}, \vec{x}) = \text{flat_h_angle}(h_2, \vec{y}), \end{array} \right\}$$

Thus, we can directly use functions `flat_angle` : `circ` \rightarrow `bitvector` \rightarrow `complex` and `flat_ket` : `circ` \rightarrow `bitvector` \rightarrow `ket` for flat circuits:

$\Gamma, C : \text{circ}, \vec{x}, h : \text{hops} : \text{bitvector} \vdash$

$$\left\{ \begin{array}{l} \text{bv_length}(\vec{x}) = \text{width}(C), \\ \text{hops_range}(h) = 0, \\ (h \triangleright C) \end{array} \right\} \quad \text{flat_angle}(C, \vec{x}) \quad \{\text{result} = \text{flat_h_angle}(h, \vec{x})\},$$

$$\left\{ \begin{array}{l} \text{bv_length}(\vec{x}) = \text{width}(C), \\ \text{hops_range}(h) = 0, \\ (h \triangleright C) \end{array} \right\} \quad \text{flat_ket}(C, \vec{x}) \quad \{\text{result} = \text{flat_h_ket}(h, \vec{x})\}$$

Hence, for the semantics of flat circuits, one can reason directly with functions `flat_angle` and `flat_ket`, along the rules given in Figures 19 (flat gates), 20 (flat combined circuits) and 21 (interpreting `flat_ket` and `flat_angle` characterizations in terms of hops).

$\frac{\Gamma, \vec{x} : \text{bitvector} \vdash}{\left\{ \text{bv_length}(\vec{x}) = 1 \right\}} \quad \text{ID} \quad \left\{ \begin{array}{l} \text{flat}(\text{result}), \\ \text{width}(\text{result}) = 1, \\ \text{flat_ket}(\text{result}, \vec{x}) = \vec{x}, \\ \text{flat_angle}(\text{result}, \vec{x}) = 1 \end{array} \right\}$	id-flat
$\frac{\Gamma, \vec{x} : \text{bitvector} \vdash}{\left\{ \text{bv_length}(\vec{x}) = 1 \right\}} \quad \text{SWAP} \quad \left\{ \begin{array}{l} \text{flat}(\text{result}), \\ \text{width}(\text{result}) = 1, \\ \text{flat_ket}(\text{result}, \vec{x}) = \\ \text{bv_set}(\text{bv_get}(\vec{x}, 0), 0, \text{bv_get}(\vec{x}, 1)), \\ \text{flat_angle}(\text{result}, \vec{x}) = 1 \end{array} \right\}$	swap-flat
$\frac{\Gamma, \vec{x} : \text{bitvector}, n : \text{int} \vdash}{\left\{ \begin{array}{l} \text{bv_length}(\vec{x}) = 1 \\ 0 \leq n \end{array} \right\}} \quad \text{Ph}(n) \quad \left\{ \begin{array}{l} \text{flat}(\text{result}), \\ \text{width}(\text{result}) = 1, \\ \text{flat_ket}(\text{result}, \vec{x}) = \vec{x}, \\ \text{flat_angle}(\text{result}, \vec{x}) = e^{2\pi i \frac{1}{2^n}} \end{array} \right\}$	phase-flat
$\frac{\Gamma, \vec{x} : \text{bitvector}, n : \text{int} \vdash}{\left\{ \begin{array}{l} \text{bv_length}(\vec{x}) = 1 \\ 0 \leq n \end{array} \right\}} \quad \text{R}_z(n) \quad \left\{ \begin{array}{l} \text{flat}(\text{result}), \\ \text{width}(\text{result}) = 1, \\ \text{flat_ket}(\text{result}, \vec{x}) = \vec{x}, \\ \text{flat_angle}(\text{result}, \vec{x}) = e^{(-1)^{1-\vec{x}_0} 2\pi i \frac{1}{2^n}} \end{array} \right\}$	rz-flat
$\frac{\Gamma, \vec{x} : \text{bitvector} \vdash}{\left\{ \text{bv_length}(\vec{x}) = 1 \right\}} \quad \text{CNOT} \quad \left\{ \begin{array}{l} \text{flat}(\text{result}), \\ \text{width}(\text{result}) = 1, \\ \text{flat_ket}(\text{result}, \vec{x}), \\ = \vec{x}_0 \cdot ((1 - \vec{x}_0)\vec{x}_1 + \vec{x}_0(1 - \vec{x}_1)), \\ \text{flat_angle}(\text{result}, \vec{x}) = 1 \end{array} \right\}$	cnot-flat

Fig. 19. Deduction rules for QBRICKS: Flat gates

D.2 Diagonal circuits. A further refinement of the semantics is possible for flat circuits whose function `flat_ket` behaves as the identity. These circuits are called *diagonal* circuits. Since this

$\Gamma \vdash \text{flat}(C_1) \quad \Gamma \vdash \text{flat}(C_2)$	seq-flat
$\Gamma, x : \text{bitvector}, \vdash$ $\left\{ \begin{array}{l} \text{width}(C_1) = \text{width}(C_2), \text{bv_length}(x) = \text{width}(C_1) \\ \text{SEQ}(C_1, C_2) \\ \text{flat}(\text{result}) \wedge \text{width}(\text{result}) = \text{width}(C_1) \wedge \\ \text{flat_angle}(\text{result}, \vec{x}) = \text{flat_angle}(C_1, \vec{x}) + \text{flat_angle}(C_2, \text{flat_ket}(C_1, x)) \wedge \\ \text{flat_ket}(\text{result}, \vec{x}) = \text{flat_ket}(C_2, \text{flat_ket}(C_1, x)) \end{array} \right\}$	
$\Gamma \vdash \text{flat}(C_1) \quad \Gamma \vdash \text{flat}(C_2)$	par-flat
$\Gamma, x : \text{bitvector} \vdash$ $\left\{ \begin{array}{l} \text{bv_length}(x) = \text{width}(C_1) + \text{width}(C_2) \\ \text{PAR}(C_1, C_2) \\ \text{flat}(\text{result}) \wedge \text{width}(\text{result}) = \text{width}(C_1) + \text{width}(C_2) \wedge \\ \text{flat_angle}(\text{result}, \vec{x}) = \text{flat_angle}(C_1, \vec{x}_{\text{width}(C_1)\uparrow}) * \text{flat_angle}(C_2, \vec{x}_{1\text{width}(C_1)}) \wedge \\ \text{flat_ket}(\text{result}, \vec{x}) = \text{concat}(\text{flat_ket}(C_1, \vec{x}_{\text{width}(C_1)\uparrow}), \text{flat_ket}(C_2, \vec{x}_{1\text{width}(C_1)})) \end{array} \right\}$	
$\Gamma \vdash \text{flat}(C)$	ctl-flat
$\Gamma, x : \text{bitvector} \vdash$ $\left\{ \begin{array}{l} \text{bv_length}(x) = \text{width}(C) + 1 \\ \text{CTL}(C) \\ \text{flat}(\text{result}) \wedge \text{width}(\text{result}) = \text{width}(C) + 1 \wedge \\ \text{flat_angle}(\text{result}, \vec{x}) = \vec{x}_0 * \text{flat_angle}(C, \vec{x}_{11}) + (1 - x_0) \wedge \\ \text{flat_ket}(\text{result}, \vec{x}) = \\ \text{if } \vec{x}_0 = 1 \text{ then } \text{concat}(\text{bv_cst}(1, 1), \text{flat_ket}(C, \vec{x}_{11})) \text{ else } \vec{x} \end{array} \right\}$	
$\Gamma, (x : \text{bitvector}) \vdash$ $\left\{ \text{bv_length}(x) = \text{width}(C), \vec{x}_i = 0 \right\} \quad C \quad \left\{ \begin{array}{l} \text{flat}(\text{result}) \wedge \\ \text{flat_ket}(\text{result}, \vec{x})_i = 0 \end{array} \right\}$	anc-flat
$\Gamma, (\vec{x} : \text{bitvector}) \vdash$ $\left\{ \begin{array}{l} \text{bv_length}(x) = \text{width}(C) - 1 \\ \text{ANC}(C) \\ \text{flat}(\text{result}) \wedge \text{width}(\text{result}) = n - 1 \wedge \\ \text{flat_angle}(\text{result}, \vec{x}) = \text{flat_angle}(C, (\text{concat}(\vec{x}, \text{bv_cst}(1, 0)))) \\ \text{concat}(\text{flat_ket}(\text{result}, \vec{x}))(\text{bv_cst}(1, 0)) = \\ (\text{flat_ket}(C, \text{concat}(\vec{x}, \text{bv_cst}(1, 0)))) \end{array} \right\}$	

Fig. 20. Deduction rules for QBRICKS: Flat circuits

$\Gamma \vdash (C \triangleright h)$	$\Gamma \vdash \{\top\}$	$h \quad \{\text{hops_range}(\text{result}) = 0\}$	flat-by-hops
$\Gamma \vdash \left\{ \text{bv_length}(x) = \text{width}(C) \right\}$	C	$\left\{ \begin{array}{l} \text{flat}(\text{result}) \\ \text{flat_angle}(\text{result}, \vec{x}) = \text{hops_angle}(h)(\vec{x}, \vec{\cdot}^0) \\ \text{flat_ket}(\text{result}, \vec{x}) = \text{hops_ket}(h)(\vec{x}, \vec{\cdot}^0) \end{array} \right\}$	
$\Gamma \vdash \text{flat}(C)$	$\Gamma \vdash$	$\left\{ \begin{array}{l} \text{bv_length}(\vec{x}) = \text{width}(C) \\ h \\ \text{hops_range}(\text{result}) = 0, \\ \text{hops_width}(\text{result}) = \text{width}(C) \\ \text{hops_angle}(\text{result})(\vec{x}, \vec{\cdot}^0) = \text{flat_angle}(C, \vec{x}) \\ \text{hops_ket}(\text{result})(\vec{x}, \vec{\cdot}^0) = \text{flat_ket}(C, \vec{x}) \end{array} \right\}$	flat-to-hops
$\Gamma \vdash (C \triangleright h)$			

Fig. 21. Deduction rules for QBRICKS: hop

property is again preserved through sequence, parallel, control and ancilla composition, we can reason about the semantics of diagonal circuits without care for function `flat_ket`.

E IMPLEMENTATION: MORE DETAILS

We provide here more details about the implementation, complementing Section 8.

E.1 Framework overview. The overall QBRICKS verification chain is depicted in Figure 22.

Implementation. The first step concerns the design of an algorithm A with parameters \vec{p} thanks to QBRICKS-DSL and QBRICKS-SPEC. QBRICKS is embedded in the Why3 programming language (called WhyML). We provide for it a set of mathematical libraries, enabling reasoning about QBRICKS-SPEC formulas (see Section E.2 below for further details about these). Note that specifications are inserted within the implementation, as decorations for functions. The specification material may also contain, still within the implementation, intermediary lemmas and ghost material (either ghost definition for functions objects that are used exclusively for the specifications, or ghost elements inserted as parameters for non-ghost functions).

Code extraction, PO generation. Next, we can perform two different Why3 compilation operations:

- Code extraction, which basically consists in deleting all the ghost material from the implementation. It results in a simple Ocaml implementation of A with parameters \vec{p} .
- Compilation of the specification code, generating:
 - first order logic proof obligations (POs).
 - first order logic axioms, formalizing definitions from the algorithm implementation. They contribute to the logical context to evaluate PO satisfaction, together with, for any function f , specifications for functions above f or from imported files.

Solving. Then QBRICKS takes advantage of various means to prove the generated POs modulo our equational theories. A dedicated interface enables to directly access them and either send them to a set of automatic SMT-solvers (CVC4, Alt-Ergo, Z3, etc.), or enter a number of interactive proof transformation commands (calls for lemmas or hypotheses, term substitutions, etc.) or even to proof assistants (Coq, Isabelle/HOL) – we do not use this option in our case-studies.

Statistics about QBRICKS implementation are given in Table 23. The development itself counts 17,000+ lines of code, including 400+ definitions and 1700+ lemmas – all proved within Why3 but 32 axioms in the mathematical libraries (see next section). Notice the volume of (verified) mathematical libraries in the overall development (14,695 loc for a total of 17,313 loc). These libraries are described in the next section.

E.2 Mathematical libraries. When we began developing QBRICKS, there was no native automated support for data-types commonly manipulated in quantum, such as complex numbers, angles, matrices, kets, vectors, etc. Hence, aside the implementation of QBRICKS-DSL and QBRICKS-SPEC, QBRICKS development also required the development of a WhyML library for these data-types *in the quantum context*.

The goal, for this specific part, was to provide the mathematical structures at stake in quantum computing, together with a *formally verified collection* of mathematical results concerning them. Then these developments are led as mathematical theories, elaborating proofs from a restricted number of axiomatic definitions.

As shown Table 23, this library contains 14,000+ lines of code: 300+ definitions, 1600+ lemmas and 32 axioms. Most of the axioms are actually axiomatic definitions giving structure for data types `complex` and `angle`. These are listed in Table 24:

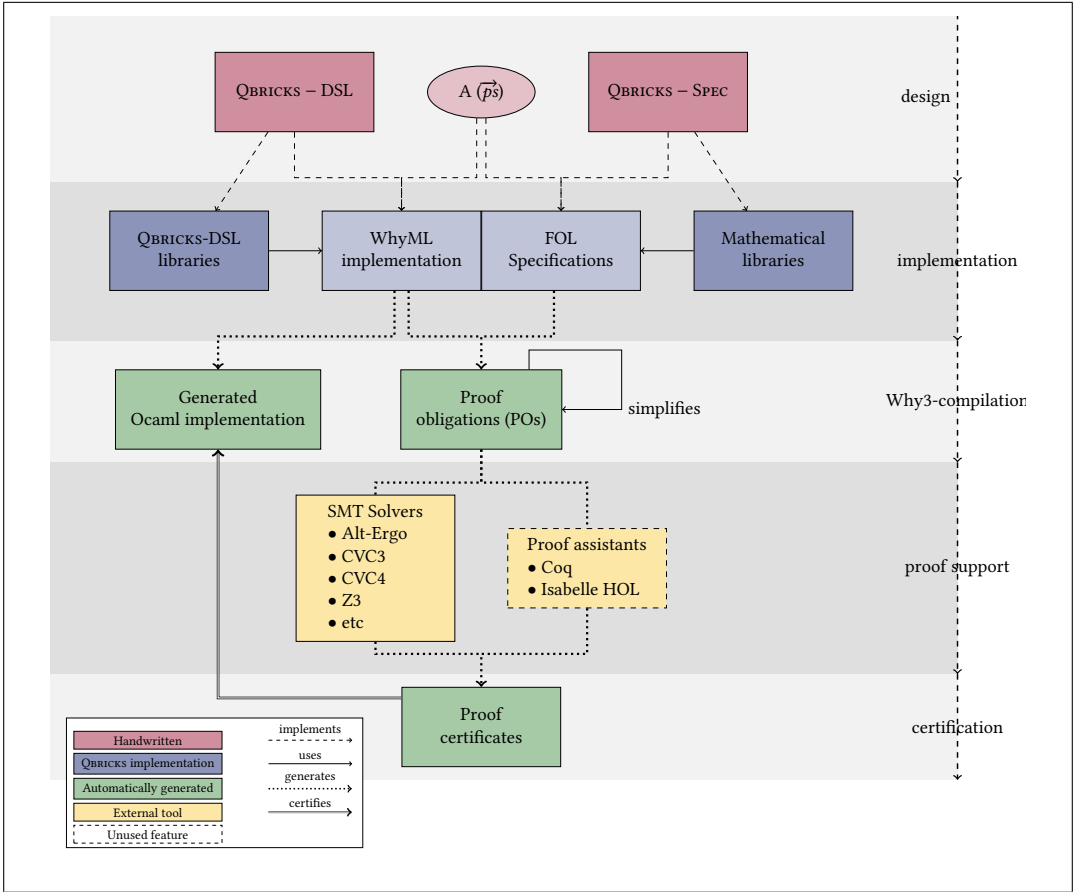

Fig. 22. Implementation of QBRICKS within Why3

- Complex numbers are given a field structure. We introduce a casting function r_to_c from the Why3 standard library type $REAL$ to $complex$. It preserves the field structure. Then constant i is introduced and any complex x is uniquely identified as the addition of a real value $Re(x)$ and a pure imaginary value $i * Im(x)$. Real numbers ordering are imported for pure real complexes (with $Im = 0$) and π is introduced as a positive constant. At last we axiomatically define integer exponentiation of complexes and the standard complex exponentiation of constant e .
- Angles are given a group structure. A casting function c_to_a from $complex$ to $angles$ is introduced. Given value x , it builds the angle of measure $2i\pi * x$ radians. Conversely, function a_to_c , given an angle θ , computes the complex value corresponding to θ on the unity circle. Mind that angles are uniquely determined by this complex value. At last, we introduce a single division over 2 operation for angles.

QBRICKS-SPEC libraries use two additional axioms : the matrix data type is a record type with two positive integer arguments (for the number of rows and the number of columns of the matrix) and a value function of type $(int \times int) \rightarrow complex$. An axiom identifies matrices if they share the same number of rows r and columns c , and their value coincide for positive integers bounded by r and c . Kets are introduced as matrices respecting certain conditions (to have 2^n rows, for a

	Lines of code	Lemmas	Modules	Definitions
Mathematics libraries	14695	1614	77	328
Sets	532	59	4	14
Algebra	2091	190	10	37
Arithmetics	538	77	4	7
Binary arithmetics	1778	189	8	42
Complex numbers	2226	344	15	57
Quantum data	3335	310	12	68
Exponentiation	843	100	4	4
Iterators	861	72	6	30
Functions	259	33	3	8
Kronecker product	420	41	2	8
Unity circle	1812	199	9	53
Qbricks core	1357	50	5	35
Semantics reasoning	744	55	3	35
Generic functions	517	12	5	34
TOTAL	17313	1731	78	410

Table 23. Metrics about QBRICKS implementation

Complex numbers	
Field:	Type $c(-, +, *, 0, 1)$, is a field*
r_to_c : $r \rightarrow c$	$\begin{array}{l} r_to_c(0.0) = 0 \\ r_to_c(1.0) = 1 \\ \forall x : r.r_to_c(-x) = -r_to_c(x) \end{array} \quad \begin{array}{l} \forall x, y : r.r_to_c(x * y) = x * y \\ \forall x, y : r.r_to_c(x + y) = x + y \\ \forall x, y : r.y \neq 0.0 \rightarrow r_to_c(x/y) = x/y \end{array}$
i : \mathbf{t}	$i * i = -1$
Re, Im : $c \rightarrow c$	$\begin{array}{l} \forall x, y : c. \text{Re}(x + y) = \text{Re}(x) + \text{Re}(y) \\ \forall x, y : c. \text{Im}(x + y) = \text{Im}(x) + \text{Im}(y) \\ \forall x : c. x = \text{Re}(x) + i * \text{Im}(x) \\ \forall x : c. \forall y, z : c. x = y + i * z \rightarrow y = \text{Re}(x) \wedge z = \text{Im}(x) \end{array}$
π : \mathbf{t}	$0 < \pi$
$\square\square$: $c \times \text{int} \rightarrow c$	$\begin{array}{l} \forall x : c. x^0 = 1 \\ \forall x : c. x^1 = x \\ \forall x : c. e^x \neq 0 \end{array} \quad \begin{array}{l} \forall x : c. \forall i, j : \text{int}. x^{(i+j)} = x^i * x^j \\ \forall x : c. x \neq 0 \rightarrow 0^x = 0 \end{array}$
$e\square$: $c \rightarrow c$	$\begin{array}{l} e^0 = 1 \\ e^1 = e \\ \forall x, y : c. e^{(x+y)} = e^x * e^y \end{array}$
Angles	
Type $a(+_a, -_a, 0_a)$, is a group*	
c_to_a : $c \rightarrow a$	$\begin{array}{l} \forall x, y : c. \text{Im}(x) = 0 \rightarrow \text{Im}(y) = 0 \rightarrow c_to_a(x + y) = c_to_a(x) +_a c_to_a(y) \\ \forall x : c.r. \text{Im}(x) = 0 \rightarrow c_to_a(-x) = -_a c_to_a(x) \end{array}$
a_to_c : $a \rightarrow c$	$\begin{array}{l} a_to_c(0_a) = 1 \\ \forall x : c. \text{Im}(x) = 0 \rightarrow a_to_c(c_to_a(x)) = e^{2i\pi * x} \end{array} \quad \forall \theta, \theta' : a. \theta = \theta' \leftrightarrow a_to_c(\theta) = a_to_c(\theta')$
$\square/_a2$: $a \rightarrow a$	$\forall \theta : a. \theta/_a2 +_a \theta/_a2 = \theta$

(*) : theory cloned from the algebra Why3 standard library

Table 24. Axiomatic definitions introduced in QBRICKS-SPEC libraries

given positive integer n , and 1 column). Similarly, the `bitvector` opaque data-type is introduced with parameter a positive integer `length` and value from `int` to `{0, 1}`. And we identify, by use of a last axiom, bit vectors that share the same length and whose value coincide up to this bound.

F EXPERIMENTAL EVALUATION: MORE DETAILS

This section complements Section 9, with both more detailed commented descriptions of case-studies (Section F.1) and additional statistics (Section F.2).

F.1 Case studies: description and comments. This section complements Section 9.1. We introduce and comment the specifications for our implementations of QPE, Shor-OF, Deutsch-Jozsa and Grover search algorithms.

Quantum Phase Estimation. All the eigenvalues of a unitary operator U are equal to $e^{2\pi i\Phi}$ for a given real Φ such that $0 \leq \Phi < 1$. Phase estimation (QPE) [17, 45] is a procedure that, given a unitary operator U and an eigenvector $|v\rangle$ of U , finds the eigenvalue $e^{2\pi i\Phi}$ associated with $|v\rangle$. It is a central piece in many emblematic algorithms, such as quantum simulation [30] or HHL algorithm [36] – resolution of linear systems of equations in time POLYLOG .

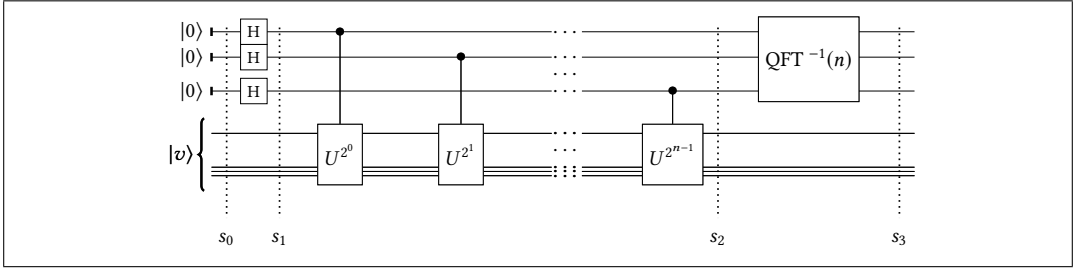

Fig. 25. The circuit for QPE

An overall view on the circuit for QPE is given on Figure 25 and the successive intermediary register states are given in Table 26. It uses two registers, one of size n and initialized to $|0\rangle_n$ and one of size s and initially in state $|v\rangle_s$: First, we superpose the first register of the entry state, by applying an Hadamard gate H to each of its qubits. It results in state s_1 .

$$\begin{aligned}
s_0 &= |0\rangle_n \otimes |v\rangle_s & s_1 &= \left(\frac{1}{\sqrt{2^n}} \sum_{k=0}^{2^n-1} |k\rangle_n \right) \otimes |v\rangle_s & s_2 &= \left(\frac{1}{\sqrt{2^n}} \sum_{j=0}^{2^n-1} e^{\frac{2\pi i \overleftarrow{j} \phi_v}{2^n}} |j\rangle_n \right) \otimes |v\rangle_s \\
& & s_3 &= \left(\frac{1}{2^n} \sum_{j=0}^{2^n-1} \sum_{l=0}^{2^n-1} e^{\frac{2\pi i \overleftarrow{j} (l-\phi_v)}{2^n}} |i\rangle_n \right) \otimes |v\rangle
\end{aligned}$$

Fig. 26. Successive states of the register along QPE circuit

Then we perform, on the second register, a sequence of U circuits elevated to the successive powers of 2 and controlled by qubits from the first register. It results in state s_2 . At last, we apply the reversed quantum Fourier transformation, $\text{QFT}^{-1}(n)$, to the first register and get state s_3 .

The specifications for this algorithm are given in Figure 27. It inputs an oracle HOPS f together with a circuit C implementing it, an eigenvector $|v\rangle$ of f together with the associated ghost eigenvalue $e^{2\pi i s \theta}$ and two register length parameters k and n . The first postcondition then certifies that, in the general case, the probability to find an x such that $x - \theta < \frac{1}{2^{n+1}}$ after applying circuit $\text{QPE}(C, k, n)$ on entry $|0\rangle_k |v\rangle$ and measuring qubits 0 to n is at least $\frac{4}{\pi^2}$. The second postcondition concerns the particular case when θ is a multiple of $\frac{1}{2^n}$. Then this probability rises to 1.

Shor-OF. [66]’s Order Finding is the central procedure in Shor’s integer prime factor decomposition algorithm. It consists in a particular instantiation of QPE. This algorithm is certainly the most

$$\begin{aligned}
& \Gamma, (f : \text{hops}), (C : \text{circ}), (|v\rangle : \text{ket}), (k, n : \text{int}), (\text{ghost } \theta : \text{real}), (j : \text{ghost int}) \vdash \\
& \quad ((C \triangleright f) \wedge \text{width}(C) = n \wedge 0 < k \wedge \text{Eigen}(f, |v\rangle, e^{2i\pi i^* \theta})) \\
& \quad \quad \text{QPE}(C, k, n) \\
& \quad \left(\begin{array}{l} \text{proba_partial_measure_p}(\text{result}, k | v\rangle, \text{error} < \frac{1}{2^{k+1}}) \geq \frac{4}{\pi^2} \wedge \\ \theta = \frac{j}{2^k} \rightarrow \text{proba_partial_measure}(\text{result}, |v\rangle, |j\rangle_k) = 1 \end{array} \right)
\end{aligned}$$

Fig. 27. Specification for our implementation of Quantum Phase estimation

famous of all quantum computing existing algorithm, raising worldwide interest for the domain. Given a non prime integer N , it outputs a factor of it in time $\text{POLYLOG}(N)$. Its most spectacular application is that it enables to break the RSA encryption protocol in polynomial time.

As a result from Bézout's identity, for any integer $a < N$ co-prime with N , if r is the modular order of a in N (that is the least integer such that $\text{mod } a^r N = 1$) and if r is even (which happens with probability $O(1)$), then either $\text{gcd}(a^{r/2} - 1)$ or $\text{gcd}(a^{r/2} + 1)$ divides N . Furthermore, if U is an unitary implementing the multiplication modulo N then for any $k \leq r$, $e^{\frac{-2i\pi * sk}{r}}$ is an eigenvalue of U . The quantum part of Shor-OF algorithm then consists in:

- implementing, for each $j < k$, the circuit U^{2^j} ,
- applying quantum phase estimation, with oracle these U^{2^j} , on input ket $|1\rangle_n$ (which is the uniform superposition of U eigenstates).

Note the importance of the implementation of U^{2^j} circuits. In particular, a naive implementation of them as iterative sequences of 2^j instances of U would introduce an exponential complexity factor and loose any advantage of using a quantum computer. Hence, the functional correction of an implementation is not enough. In the case of Shor-OF for example, a relevant implementation must also certify the POLYLOG complexity requirement.

We implemented the version of the oracle U^j described in the reference implementation [6]. The overall specification for our implementation is given in Figure 25.

$$\begin{aligned}
& \Gamma(a, b, n : \text{int}), (j : \text{ghost int}) \vdash \\
& \quad (\text{co_prime}(a, b) \wedge 1 \leq b < 2^n \wedge 1 \leq j < b \wedge \text{mod } a^j b = 1) \\
& \quad \quad \text{Shor-circ}(a, b, n) \\
& \quad \left(\begin{array}{l} \text{proba_partial_measure_p}(|1\rangle_n, \text{error} \leq \frac{1}{2^{2n+1}}) \geq \frac{4}{\pi^2} \wedge \\ \text{size}(\text{result}) = \text{Shor-poly}(n) \wedge \\ \text{ancillas}(\text{result}) = n + 2 \wedge \text{width}(\text{result}) = 3 * n \end{array} \right)
\end{aligned}$$

Fig. 28. Specification for our implementation of Shor-OF algorithm

- (1) As for QPE, the probability that the measurement will give an output close to an eigenvalue is more than $\frac{4}{\pi^2}$. In this case, recovering the actual value $e^{\frac{-2i\pi * sk}{r}}$ requires another classical manipulation, the *continuous fraction expansion*,
- (2) the second postcondition concerns the size of the circuit, proved by use of rules from Figure 18. Note that the specification is not given as a complexity class (such as $O(n^4)$), but gives the actual polynomial $\text{Shor-poly}(n)$. It is equal to $(n + 1)^4(28\text{ctl-size-const}^2 + 12\text{ctl-size-const}) + (n + 1)^2(10\text{ctl-size-const} + 1) + 4n + 8\text{ctl-size-const} + 3$. Furthermore, the implementation of oracles in [6] uses several instances of the QFT. For them, it

leaves open the possibility to use approximations for QFT with k_{max} gates. Hence the author provides a size bound that is in $O(n^2)$ and linear in k_{max} . In our implementation we used the standard exact implementation of QFT, with number of gates bounded by (n^2) .

- (3) The third and fourth postcondition specify the width of the circuit and the number of additional ancilla qubits it requires. For the final application of QFT^{-1} (that appearing in Figure 25), [6] uses a semi-classical version of QFT^{-1} , which makes use of a single qubit instead of $2 * n$. Since QBRICKS does not contain classical data operations, here also we implemented the standard version of QFT^{-1} , so that the whole circuit has width $3 * n$ and uses an additional $n + 2$ ancilla qubits.

Deutsch-Josza algorithm. Deutsch-Josza algorithm is a toy algorithm, mainly used in introductory courses as an illustration of quantum state superposition. Given a positive integer n , given a function f from int to bool that is guaranteed to be either constant or balanced on $\llbracket 0, 2^n \rrbracket$ and given a circuit C implementing f ¹², Deutsch-Josza algorithm decides, in time linear in n , whether f is constant or balanced on $\llbracket 0, 2^n \rrbracket$. Its complete specifications is given as:

$$\Gamma, (C : \text{circ}), (f : \text{int} \rightarrow \text{bool}), (n : \text{int}) \vdash$$

$$\left(\begin{array}{c} \text{implements}(C, f) \wedge 1 < n \\ \wedge (\neg \text{constant}(f, n) \rightarrow \text{balanced}(f, n)) \\ \text{Deutsch-Josza}(C, n) \end{array} \right)$$

$$\left(\begin{array}{c} \text{constant}(f, n) \rightarrow \text{proba_partial_measure} \\ \quad (\text{result}, \text{concat}(\text{bv_cst}(n, 0))(\text{bv_cst}(1, 1))) = 1 \wedge \\ \text{balanced}(f, n) \rightarrow \text{proba_partial_measure} \\ \quad (\text{result}, \text{concat}(\text{bv_cst}(n, 0))(\text{bv_cst}(1, 1)), \text{bv_cst}(n, 0)) = 0 \wedge \\ \quad \text{size}(\text{result}) = 2 * n + \text{size}(C) + 2 \wedge \\ \quad \text{width}(\text{result}) = n + 1 \wedge \text{ancillas}(\text{result}) = \text{ancillas}(C) \end{array} \right)$$

Hence, the two first postconditions ensures that the partial measurement outputs $|0\rangle$ exactly when the function f is constant, the third postcondition gives a size bound for the circuit (that is linear in both n and the size of the oracle implementation), and last line states that the width of the circuit is $n + 1$ and it does not use any extra ancilla from those (maybe) required for C .

Grover algorithm. Grover algorithm enables to search distinguished elements in a non-structured data base. It notably provides a quadratic acceleration in the resolution of NP-hard problems. Given positive integers n and k such that $k \in \llbracket 1, 2^n \rrbracket$, given a function f from int to bool that is guaranteed to be satisfied by exactly k elements in $\llbracket 0, 2^n \rrbracket$ and given a circuit C implementing f and a positive index i , the algorithm consists in an iterative sequence of i times a sequence combination of a specific operator (called *Grover diffusion operator*) and oracle U . It is such that the probability to obtain, after measurement, a result satisfying f , is equal to $\sin^2\left(\arcsin\left(\frac{k}{2^n}\right)(1 + 2i)\right)$. This specification is formalized below together with the size of the circuit (that is linear in both n and the number of iterations i) and the width of the circuit (equal to n).

¹² which formally means that for any bit vectors x of length n and y of length 1,

$$\text{circuit_io}(C, |x\rangle \otimes |y\rangle) = |x\rangle \otimes |y \oplus f(\text{bv_to_int}(x))\rangle$$

$$\Gamma, (C : \text{circ}), (f : \text{int} \rightarrow \text{bool}), (n, i, k : \text{int}) \vdash$$

$$\left(\begin{array}{l} \text{implements}(C, f) \wedge 1 < n \wedge 1 \leq k < 2^n - 1 \wedge 1 \leq i \\ \wedge \text{Card}(\{j \mid 0 \leq j < 2^n \wedge f(j) = \text{true}\}) = k \\ \text{Grover}(C, k, n) \end{array} \right)$$

$$\left(\begin{array}{l} \text{proba_partial_measure}_f(\text{result}, \text{bv_cst}(n, 0), f) = \sin^2\left(\arcsin\left(\frac{k}{2^n}\right)(1 + 2i)\right) \wedge \\ \text{size}(\text{result}) = i * (\text{size}(C) * \mathcal{O}(n)) \\ \wedge \text{width}(\text{result}) = n \wedge \text{ancillas}(\text{result}) = 1 \end{array} \right)$$

In this specification, we used expression $\text{proba_partial_measure}_f(\text{result}, \text{bv_cst}(n, 0), f)$ as a syntactic sugar for

$$\sum_{\substack{j \in [0, 2^n[\\ f(j) = \text{tt}}} \text{proba_partial_measure}(\text{result}, \text{bv_cst}(n, 0), \text{int_to_bv}(n, i))$$

F.2 Case studies: metrics. This section complements Section 9.2.

Details on interactive proof commands. Table 29 reports a classification of the interactive (proof) commands used in our case-studies to discharge the remaining PO. Interactive commands divide mainly into:

- calls for deduction rules (Rules),
- calls for hypotheses from the context (Hyp.),
- β -reductions,
- splitting commands (splitting conjunction in either goal or context and elimination of case distinctions),
- and substitutions (Subst).

Column Misc. contains introduction of constant values for existential quantification, case distinctions and intermediate assertions.

	#Rules	#Hyp.	# β -red.	#Split.	#Subst.	Misc.	Total
DJ	17	9	10	2	1	0	39
Grover	91	26	23	12	15	0	167
QFT	15	14	5	3	0	0	37
QPE	66	36	17	15	19	2	155
Shor-OF	93	62	25	57	19	8	264
Shor-OF (full)	174	112	47	75	38	10	456
Total	282	147	80	89	54	10	662

#Rules: calls for deduction rules — #Hyp.: calls for hypotheses

Table 29. Verification for case studies: repartition of interactive commands

As a complement to these figures, it should be mentioned that the specifications for these algorithms all contain some pure mathematical proofs which are not directly linked to circuit composition. For example, 198 out of the 321 lines of decorated code declared for QPE in Table 15 concerns rewriting lemmas for the measurement outcomes. Also, our implementation for Grover follows the standard algorithm explanation. Doing so, it introduces, in addition to circuit building and hops specifications, vectorial space embedding and geometry material which, again, actually represents the major part of the proof effort.

Prior work. Table 30 gives a summary of anterior efforts for the verification of quantum programs.

		Circuit building	Parameters	Restrictions	Size	Automation
QBRICKS	DJ	✓	U, n	None	53LoC + 39Cmd	Partial
	Grover	✓	U, k, n	None	416 LoC+ 167 Cmd	Partial
	QFT	✓	n	None	65 LoC + 37 Cmd	Partial
	QPE	✓	$U, n, v\rangle$	None	319 LoC + 155 Cmd	Partial
	Shor-OF	✓	n, a, b	None	809 LoC + 264 Cmd	Partial
Path-sums	QFT	✓	Not parameterized	Only instances	Unknown	Full
	Others	✗	✗	✗	✗	✗
Qwire	DJ	✓	U, n	None	74 LoC + 222Cmd [†] 59 LoC + 112Cmd [†]	None
	Others	✗	✗	✗	✗	✗
QHL	Grover	None	U, k, n	$\exists j. k = 2^j$	3000 + LoC [‡]	Partial
	Others	✗	✗	✗	✗	✗

#LoC.: lines of decorated code – #Cmd: interactive commands

U : circuit oracle – # n : width of the input register # $|v\rangle$ eigen vector of U – # a, b, k : further integer parameters

Table 30. Comparison with quantum formal verification from the literature

[†]: The authors provide two proofs: the textbook-style proof and a new clever proof. The proof in QBRICKS corresponds to textbook style.

[‡]: QHL does not provide any information on proof commands or tactics, but the lines of code include intermediate lemmas.