

Selecting and Designing Grippers for an Assembly Task in a Structured Approach

Jingren Xu^{1,2}, Keisuke Koyama¹, Weiwei Wan¹, Yukiyasu Domae² and Kensuke Harada^{1,2}

Abstract—In this paper, we present a structured approach of selecting and designing a set of grippers for an assembly task. Compared to current experience-based gripper design method, our approach accelerates the design process by automatically generating a set of initial design options on gripper type and parameters according to the CAD models of assembly components. We use mesh segmentation techniques to segment the assembly components and fit the segmented parts with shape primitives, according to the predefined correspondence between primitive shape and gripper type, suitable gripper types and parameters can be selected and extracted from the fitted shape primitives. Then considering the assembly constraints, applicable gripper types and parameters can be filtered from the initial options. Among the applicable gripper configurations, we further minimize the required number of grippers for performing the assembly task, by exploring the gripper that is able to handle multiple assembly components during the assembly. Finally, the feasibility of the designed grippers are experimentally verified by assembling a part of an industrial product.

I. INTRODUCTION

Robots have been increasingly engaged in industrial applications such as robotic assembly, where a set of mechanical components are handled and manipulated by robotic grippers. The gripper plays a pivotal role for the robot interacting with the environment, and the performance of the gripper grasping an assembly component is strongly influenced by how well the chosen gripper and its characteristics coincide with the characteristics needed for grasping a specific part [1]. Therefore, designing reliable grippers is one of the key issues for applying robots in industrial environment.

However, robotic grippers are manually designed in most cases, the manual design process is time-consuming and requires a lot of experience and expertise, which makes it extremely challenging to design grippers especially for an assembly task, where a set of grippers are usually required to handle all the different assembly components. Moreover, with the recent trend in High-Mix Low-Volume production, a more efficient approach of designing grippers is highly demanded in order to keep robots competitive in agile manufacturing.

To improve the efficiency of gripper design, we propose a structured approach of designing the grippers based on the shape analysis and assembly constraints. The insight is that the industrial products are usually comprised of many

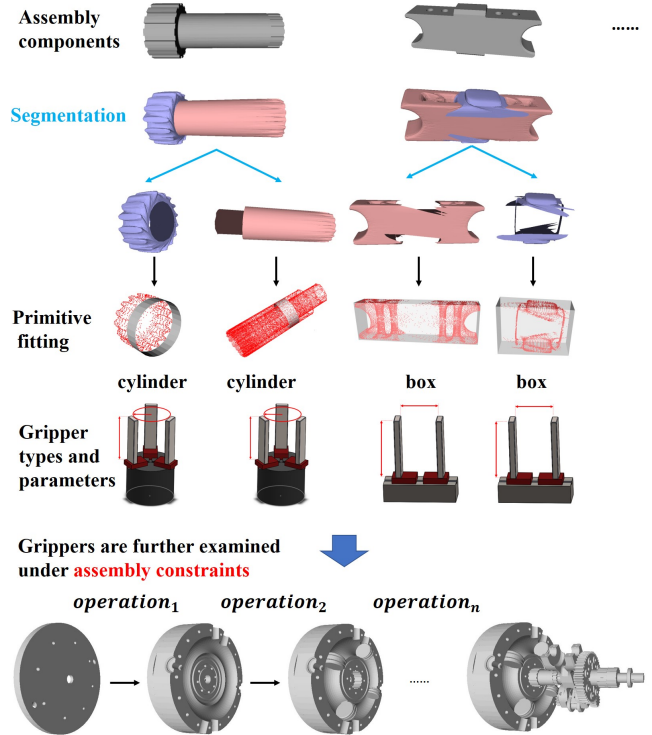

Fig. 1: Overview of the proposed approach of selecting and designing grippers for an assembly task. In the first stage, suitable gripper types (2-finger or 3-finger gripper) and parameter (opening width) can be determined by mesh segmentation and primitive fitting, then grippers of such configurations are further evaluated under the assembly constraints, such as affordance and collision avoidance.

regular shape primitives, such as cylinder and cuboid, each of the shape primitives can be firmly grasped by a suitable type of gripper, we take advantage of the relation between shape primitive and gripper type and predefine the rules for selecting suitable gripper types, which reduces the space for searching possible gripper configurations and significantly accelerates the design process. Through mesh segmentation techniques, we can uncover the underlying shape primitives and assign predefined gripper types to them, since the assigned type of gripper's characteristics coincide well with the geometrical characteristics of the segmented parts, high-quality grasps can be easily obtained. In addition, the gripper parameters, such as the max/min opening width, can be further extracted from the dimension of the fitted primitives. These steps are automatically processed and provide a re-

¹Graduate School of Engineering Science, Osaka University { xu@hlab., harada@, wan@ }sys.es.osaka-u.ac.jp

²Automation Research Team, Artificial Intelligence Research Center, National Institute of Advanced Industrial Science and Technology (AIST) domae.yukiyasu@aist.go.jp

duced number of gripper configurations for further selection and evaluation under the assembly constraints. Afterwards, we minimize the number of grippers to reduce the cost.

A few researches have been done on the design of gripper for assembly tasks. However these researches are limited to designing the local shape of the fingertip [2] and general suggestions for designing the gripper systems. There has been no concrete attempt on the structured approach of selecting and designing grippers, as well as minimizing the number of gripper, for a sequence of assembly tasks. Moreover, we explicitly take into account the assembly constraints and demonstrate our approach on a part of an industrial product.

The rest of the paper is organized as follows: Section II reviews the related work, section III introduces the segmentation of the assembly components, section IV exacts the initial set of gripper configurations by primitive fitting, and they are further evaluated under the assembly constraints in section V, the feasibility of the designed grippers are confirmed by an assembly experiment in section VI. Finally, we draw the conclusions and provide the prospect for future work in section VII.

II. RELATED WORK

The structured approach of gripper design proposed in this paper is closely related to two topics: Gripper design [3], [4], [5], [6] and part/model/primitive based grasp planning [7], [8], [9], [10], [11]. Most of the existing work is either on the gripper design or primitive based grasping, very few work considers combining these two topics together.

A. Gripper Design and Robotic Assembly

Most of the grippers are specially designed according to the task to be performed [6], [12], in this case, the design process is long and takes many iterations to obtain a satisfactory design. There have been very few attempts to design grippers for assembly tasks and improve the design efficiency. Pham et al. [5] surveyed the design methods to achieve versatile and cost-effective gripping and proposed a strategy for minimizing the required number of grippers through part-family grouping, and later Pham et al. [4] proposed a system to determine the configuration of grippers for assembly tasks. Honarpardaz et al. [13], [2] provided some suggestions on determining the local shape of the finger-tip to fit the object surface. They also pointed out the number of grippers can be reduced with the help of gripper changers. However, none of the above work proposed structured approach that covers from model processing, parameter extraction, evaluation to the minimization of the number of grippers, moreover, none of them explicitly considered the assembly constraints and none of them provided experiment on assembling an industrial product.

In addition to the gripper configuration, the contact between the finger and object plays an important role on grasp stability, thus the contact model has been studied extensively [14], [15], [16], [17]. Some researchers studied the finger design to improve the performance of the gripper.

Honarpardaz et al. [13], [2] proposed generic optimized finger design (GOFD) to automate the finger design process, the fingertip shape is designed to mimic the workpiece, and the contact area is increased. Song et al. [18] noticed that most grasp contacts share a few local geometries, they proposed a uniform cost algorithm to cluster a set of example grasp contacts into several contact primitives, and designed the finger shape to match the local geometry in order to increase the contact area.

For an assembly task, usually more than one gripper is required to handle all the assembly components, therefore, a tool changer is necessary to switch between different grippers in order to handle all the assembly components. Harada et al. [19] incorporated the tool changer into the assembly planner and proposed an assembly planner that is able to automatically select a suitable gripper to assemble parts. Kramberger et al. [20] proposed a flexible and cost-effective grasping solution to quickly develop and test custom fingertips to handle multiple parts.

B. Shape Approximation Based Grasping

Grasp planning is difficult due to the large number of possible gripper configurations, but grasping planning can be simplified if considering the shape of the object and the grasping strategy are closely related. Miller et al. modeled the object as a set of simple shape primitives [7], then the grasp location and preshape can be determined. Huebner et al. [9] approximated the object by box primitives and select grasps based on the approximated boxes. However, the error of approximating by primitives may result in low-quality grasps, to counteract this problem, Przybylski et al. [8] proposed the grid of spheres for grasp planning, which effectively reduce the search space for grasps without sacrificing potential high-quality grasps.

These researches **passively** plan grasps for a given shape, we can also **actively** design the gripper configurations according the shape of target object in order to easily obtain high-quality grasps, which is one of the concerns of this paper. Our main contributions are summarized as follows:

- We proposed a structured approach of configuring the gripper types and parameters based on mesh segmentation and primitive fitting.
- The assembly constraints are taken into account in the evaluation of the candidate gripper configurations. And the number of grippers required for the assembly task is minimized to reduce the cost.
- Most of the existing work is tested on relatively simple product, the proposed method is experimentally verified by assembling a part of an industrial product.

III. MESH SEGMENTATION

Mechanical products are usually comprised of many regular shapes such as cylinders and cuboids, which makes the proposed method feasible and promising in industrial applications. In this paper, the purpose of mesh segmentation is to find the underlying shape primitives of an assembly component, then suitable gripper types are determined

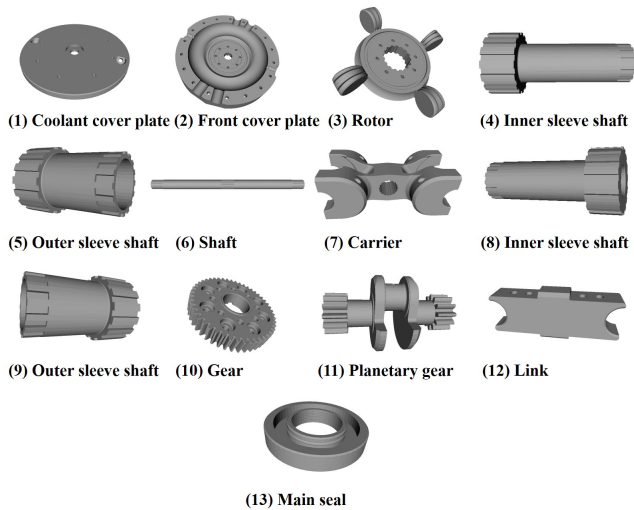

Fig. 2: Models of all the assembly components before processing, they are displayed in the order of the assembly sequence.

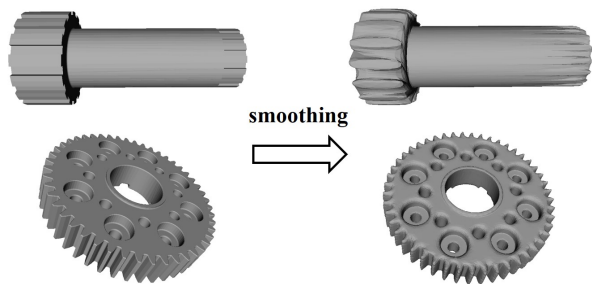

Fig. 3: Two examples of models before and after smoothing.

according to the predefined rules. We segment the mesh models of the assembly components (Fig. 2) based on Shape Diameter Function (SDF) [21], which is a measure of the local diameter of the object on the surface. Readers are referred to [22] for other mesh segmentation methods.

Before the mesh segmentation, smoothing is applied on the mesh to eliminate the sharp edges of the screw thread, otherwise it may result in undesirable segments [23]. Fig. 3 shows the mesh after smoothing is applied. After smoothing, all the assembly components are segmented based on SDF value. The segmentation result is shown in Fig. 4, different segments are colored differently, each of the segments is regarded as a candidate for grasping¹.

IV. GRIPPER SELECTION AND DIMENSIONING

Through the mesh segmentation, the assembly component with complex shape is decomposed into segments with simpler shapes. Obviously, some shape primitives can be easily grasped by some common types of gripper, e.g. cylinders can be easily grasped by the 3-finger centric gripper. Therefore, we attempt to fit the segments with shape primitives and then determine the suitable gripper types according to the predefined rules. In this section, we obtain the initial decisions on

¹Grasping on multiple segments are not considered in this paper.

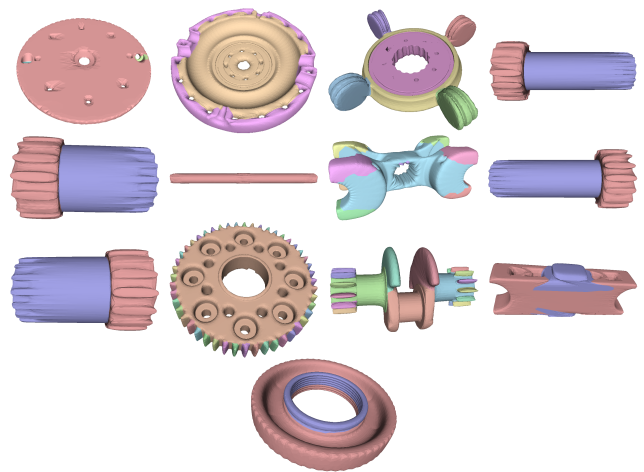

Fig. 4: After mesh segmentation, an assembly component is decomposed into several segments, different segments are marked with different colors. The original component with complex shape is decomposed into segments with simpler shapes, which are suitable for further primitive fitting.

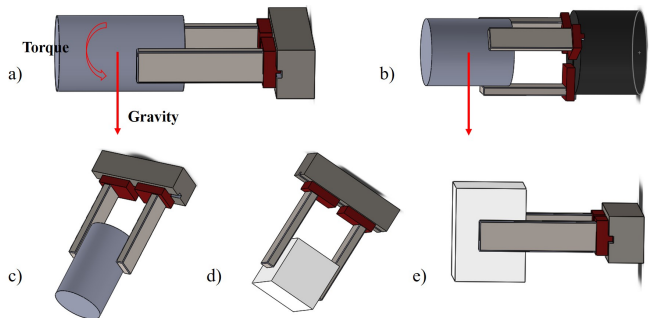

Fig. 5: (a) & (c) Grasping a cylinder by a 2-finger gripper is not stable under external torque, the object may slip around the contact normal. (b) Grasping a cylinder by a 3-finger gripper is stable in the radial direction. (d) & (e) Grasping a box shape by a 2-finger gripper is appropriate.

gripper types and parameters based on previous segmentation result.

A. Rules for Gripper Type Selection

Let's consider using two common types of gripper: 2-finger parallel jaw gripper and 3-finger centric gripper as shown in Fig. 5 (a) and (b). 2-finger grippers are suitable for grasping parts with (nearly) parallel surfaces, Fig. 5 (d) and (e) show a 2-finger gripper grasping a box with parallel surfaces, the gripper fingers coincide well with the object surfaces and they have large contact area, thus the grasp is robust. However, it is not suitable to grasp a cylinder using a 2-finger gripper, as shown in Fig. 5 (a), external force such as gravity may result in large torsional force and lead to slip around the contact normal. For cylindrical objects, it is preferable to select the 3-finger centric grippers, grasping cylindrical objects by 3-finger centric grippers is stable against the force in the radial direction and the torque as marked in Fig. 5 (a). Another merit of grasping cylindrical

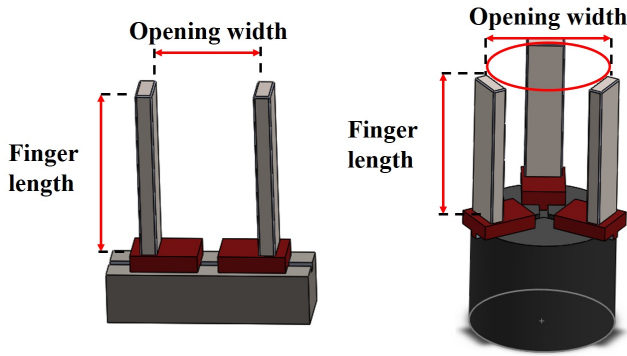

Fig. 6: The opening width and finger length of the 2-finger and 3-finger grippers.

objects using 3-finger grippers is that the grasp stability is independent of the radius of the cylinders, however, the stability of grasping a cylindrical object using a 2-finger gripper depends on the relative curvature of the finger and object surface, that is, grasping a cylinder with larger radius is more stable since the contact area is larger².

B. Gripper Type

Each segment of an assembly component shown in Fig. 4 is a candidate for grasping, in order to determine suitable gripper type for grasping the segment, we fit every segment with cylinder and bounding box. If the volume of cylinder is closer to the volume of the segment, then a 3-finger centric gripper is selected for this segment, otherwise, the 2-finger jaw gripper is used. Since the segments of a surface mesh are usually not closed surface, the volume of the such segments are obtained by calculating the volume of their convex hulls.

Fig. 7 shows two examples of fitting the segmented part with primitives. The rotor in Fig. 7 (b) is segmented into 6 parts, we fit all of them with cylinders and bounding boxes, by comparing the volume of the segmented part and the fitted primitive, the appropriate fitting for every segment can be determined. As a result, five of them can be closely fitted by cylinders and the other one is fitted by its bounding box. The fitted cylinders are represented by gray belts, the height of the cylinder is manually set as 1cm for visualization, but it can also be calculated from the maximum distance along the cylinder's axis between the points on the segment. Notice that the third segment looks cylindrical but it is empty on the cylindrical surface, therefore it is actually better fitted by the bounding box. Then the corresponding gripper type can be selected for every segment based on the predefined rules. In order to grasp a mechanical component, at least one of its segmented parts should be graspable by the designed grippers, e.g. we need a gripper capable of grasping at least one of the 6 segments in Fig. 7.

C. Gripper Parameters

The maximum and minimum opening width and finger length are important parameters for the grippers. In order

²Assume soft finger contact and constant external force.

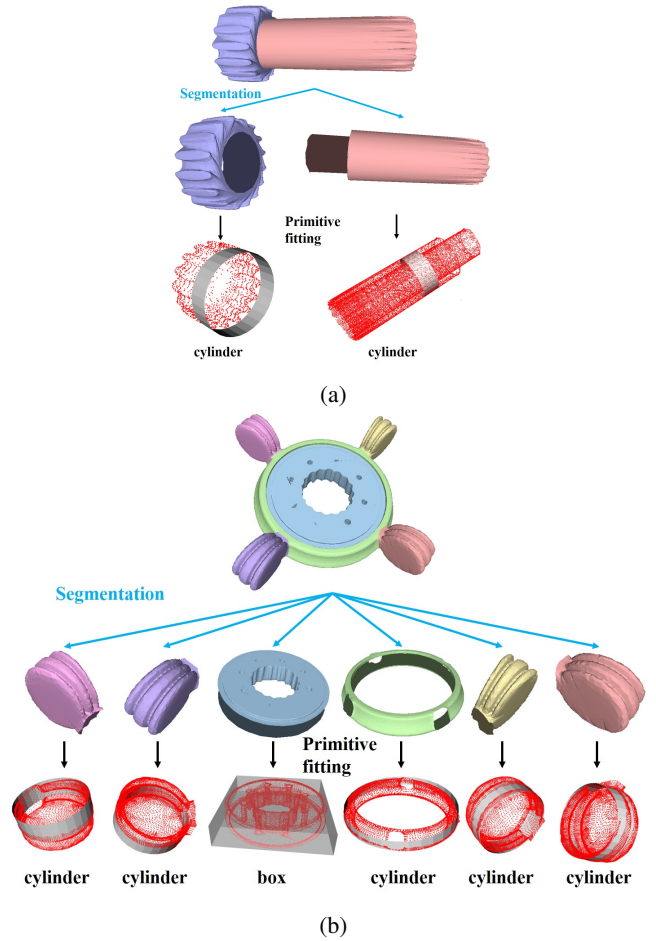

Fig. 7: Two examples of fitting the segmented parts with shape primitives. (a) The inner sleeve shaft is segmented into two parts, and both of the two parts are fitted appropriately by cylinders. (b) Five segments of the rotor are more closely fitted by cylinders and the other one is fitted its bounding box, notice that the third segment looks cylindrical but it is empty on the cylindrical surface.

to grasp a segment, the characteristic length of the shape primitives, which are the diameter for a cylinder primitive and side length for a box primitive, must be included within the stroke of the gripper. As for the finger length, there is no requirement if only considering the capability of grasping instead of the stability or quality of grasping. However, the finger length has to fulfill some requirements in order to satisfy the assembly constraints, for example, the finger should be long enough to avoid collision with the shaft when inserting the shaft sleeve to the shaft. And the requirement on the finger length is obtained in section V-B. In addition, the grasp parameters such as the gripper approach direction can be determined from the fitted primitives. The 3-finger centric gripper should approach the part along the axial direction, and the 2-finger gripper can approach the part as long as the finger surfaces are parallel to the non-empty surfaces of the bounding box.

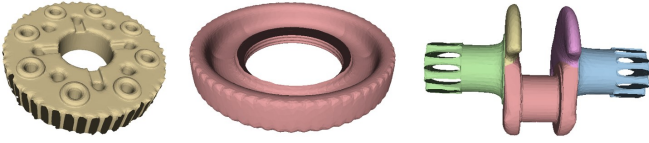

Fig. 8: Gear teeth and screw thread do not afford grasping, thus removed from the candidate graspable segments.

V. EVALUATION AND FINAL DECISION

Through mesh segmentation and shape primitive fitting, we have obtained the initial candidate gripper type and parameters for every segmented part of the assembly components, however, some of them are not applicable considering the assembly constraints. In this section, we take into account the assembly constraints and finalize the minimum number of grippers for the given assembly task.

A. Assembly Task Specification

Referring to the assembly task decomposition method proposed by Mosemann et al. [24], an assembly task can be represented as a sequence of assembly operations, in each assembly *operation_i*, a new assembly component is added to the existing subassembly. We assume the assembly sequence is already given, then the assembly task is denoted as *Assembly* = {*operation₁*, *operation₂*, ..., *operation_n*}, each assembly operation can be represented as $\langle c_a, c_p, {}^aT_p, {}^{a'}T_p \rangle$, where c_a and c_p are the active and passive subassemblies being manipulated in the operation, aT_p and ${}^{a'}T_p$ are spatial transformation between active and passive assembly component before and after the assembly operation.

B. Assembly Constraints

In an assembly operation *operation_i*, the gripper has to grasp one segment of c_a and change the spatial relationship from aT_p to ${}^{a'}T_p$. When grasping c_a , not every segment of c_a is suitable for grasping, the affordance of different segments should be taken into account in selecting suitable segments. Moreover, the gripper must avoid the collision with c_p during the spatial transformations.

1) *Affordance*: Affordance is defined as the possible action on an object or environment [25]. In an assembly operation, not all the segments of an assembly components afford grasping. For example, screw thread and gear teeth are mainly used for fastening and transmission, if they are directly handled by the gripper, they may be damaged and lose their main affordance. As illustrated in Fig. 8, some segments are removed from the candidates for grasping considering their major affordance.

2) *Collision Avoidance*: There are two cases collision occurs, either the gripper grasps the segment that is to be mated with subassembly c_p or the gripper collides with c_p during the assembly operation. Considering collision avoidance, a segment is graspable only if there exists a collision free grasping pose for the gripper to assemble c_a to c_p . To get the graspable segments satisfying collision avoidance

constraint, we sample a set of grasps and finger lengths for each segment, then check the collision during the assembly operation, if there is at least one collision-free grasp, then the segment is graspable.

After examining under the assembly constraints, the remaining graspable segments of every assembly component are listed in Fig. 9, alongside the segments are the requirements on gripper types and parameters for grasping the segments.

C. Minimize the Number of Grippers

Now we have obtained the graspable segments of all the assembly components. For grasping and assembling each component, at least one of its segments should be handled by the gripper. Since the constraint on finger length listed in Fig. 9 is simple and not upper bounded, we consider minimizing the number of grippers based on the open width.

Let \mathcal{P} denotes the product to be assembled, \mathcal{P} is comprised of a set of components $\{C_1, C_2, \dots, C_n\}$, after segmentation and evaluation, a component C_i has m graspable segments $\{S_{i1}, S_{i2}, \dots, S_{im}\}$. For each component C_i , select one of its segments $S_{ij_i} \in C_i$ for grasping, then $s = \{S_{1j_1}, S_{2j_2}, \dots, S_{nj_n}\} \in S$ denotes a set of n segments to be grasped for assembling \mathcal{P} , and S is the set of all the combinations of segments by selecting one segment from one component. Let W and w denote the maximum opening widths and D and d denote the strokes of 3-finger and 2-finger gripper, respectively. The stroke of a type of gripper is constant but the maximum gripper opening width can be changed by modifying the finger's dimension. Each set $s = \{S_{1j_1}, S_{2j_2}, \dots, S_{nj_n}\}$ can be divided into two subsets, s_2 and s_3 , (line 8 of Algorithm. 1), which are the segments grasped by 2-finger and 3-finger grippers, respectively. The elements in each subset are arranged in descending order according to their corresponding opening widths (line 9 and 10 of Algorithm. 1). Initialize the width of gripper be the maximum dimension of the segments, then we can determine number of 2-finger and 3-finger grippers, by checking if the dimension of the segment is included in the stroke of grippers in turn. The algorithm is shown in Algorithm 1, where $w2finger$ and $W3finger$ denote the list of gripper widths of 2-finger and 3-finger grippers, $descendingOrder$ is to rearrange the segments according to their dimensions, Dim denotes dimension of the segment, $num2finger$ and $num3finger$ are the number of 2-finger and 3-finger grippers needed.

D. Other Aspects for Optimization

1) *Stability of Grasping Different Segments*: In an assembly operation, grasping different segments may result in different force/torque distribution. Consider assembling the carrier to the shaft in Fig. 2, if grasping contact positions are not symmetric about the shaft, it will lead to uneven normal force between shaft and hole, which may result in insertion failure, or even damage the components. Therefore, it is worth noting the influence of stability criteria on the optimal graspable segment.











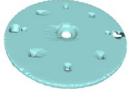

No.	Graspable segments	Gripper type	Opening width	Finger length
1		3-finger	227 mm	
2		3-finger	227 mm	
3		3-finger	110 mm	
4		3-finger	25 mm	
5		3-finger	32 mm	
		3-finger	40 mm	> 41 mm
6		3-finger	18 mm	
7		2-finger	16.7 mm	
		2-finger	19.1 mm	
		2-finger	17.2 mm	
		2-finger	15.9 mm	
		2-finger	16.5 mm	
		2-finger	15.8 mm	
		2-finger	16.9 mm	
		2-finger	18.5 mm	
8		2-finger	60 mm	
		3-finger	40 mm	> 50 mm
9		3-finger	32 mm	
		3-finger	40 mm	> 41 mm
10		2-finger	17 mm	> 4.5 mm
11		2-finger	20 mm	
12		2-finger	15 mm	
		2-finger	32.8 mm	
13		3-finger	37.5 mm	> 22.7 mm

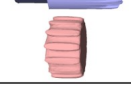
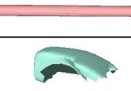
Fig. 9: The remaining graspable segments after checking the assembly constraints.

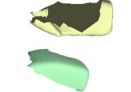
Algorithm 1: Minimize the number of grippers

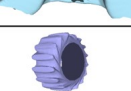
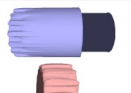
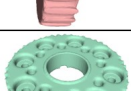
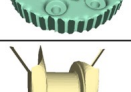
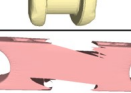
```

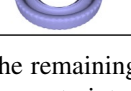
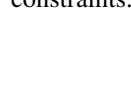
1  $nummin \leftarrow n$  //  $n$ : number of components
2  $w2finger \leftarrow \{\}$  // 2 finger, width
3  $W3finger \leftarrow \{\}$  // 3 finger, width
4 for  $s = \{\mathcal{S}_{1j_1}, \mathcal{S}_{2j_2}, \dots, \mathcal{S}_{nj_n}\} \in S$  do
5    $numtot \leftarrow 0$ 
6    $num2finger \leftarrow 0$ 
7    $num3finger \leftarrow 0$ 
8    $s_2, s_3 \leftarrow divide(s)$ 
9    $s_2 \leftarrow descendingOrder(s_2)$ 
10   $s_3 \leftarrow descendingOrder(s_3)$ 
11   $w \leftarrow Dim(s_2[0])$ 
12   $W \leftarrow Dim(s_3[0])$ 
13   $w2finger_i \leftarrow \{\}$ 
14   $W3finger_i \leftarrow \{\}$ 
15  for  $\mathcal{S}_2 \in s_2$  do
16    if  $w - d < Dim(\mathcal{S}_2) < w$  then continue
17    else
18       $num2finger \leftarrow num2finger + 1$ 
19       $w2finger_i.push\_back(Dim(\mathcal{S}_2))$ 
20       $w \leftarrow Dim(\mathcal{S}_2)$ 
21    end
22  end
23  for  $\mathcal{S}_3 \in s_3$  do
24    if  $W - D < Dim(\mathcal{S}_3) < W$  then continue
25    else
26       $num3finger \leftarrow num3finger + 1$ 
27       $W3finger_i.push\_back(Dim(\mathcal{S}_3))$ 
28       $W \leftarrow Dim(\mathcal{S}_3)$ 
29    end
30  end
31   $numtot \leftarrow num2finger + num3finger$ 
32  if  $numtot < nummin$  then
33     $nummin \leftarrow numtot$ 
34     $w2finger \leftarrow w2finger_i$ 
35     $W3finger \leftarrow W3finger_i$ 
36  end
37 end
38 return  $nummin, w2finger, W3finger$ 

```

2) *Finer Finger Design:* The assembly components must be stably grasped from the environment. For components to be grasped by three-finger grippers, stability with respect to gravity is guaranteed, as long as the gripper hold the cylindrical object horizontally (Fig. 5 (b)). However, a two-finger gripper grasping an object is fragile to external torque in the finger surface normal direction. It is necessary to design the shape of the finger surface to increase the contact area with the object, especially when the object surface is curved. Appropriate finger curvature can be determined by using the soft finger contact model, the Fig. 5 (a) illustrates the situation of the maximum torque caused by gravity, and it should be balanced by the torsional friction exerted by the soft finger contact.

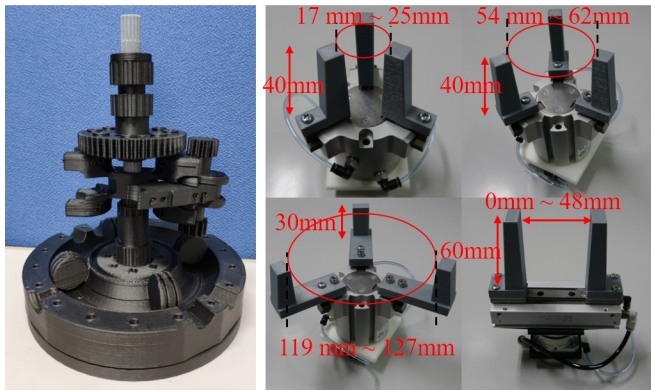

Fig. 10: (Left): The product to be assembled. (Right): The designed 4 grippers in their maximum opening state, the strokes are 8mm for 3-finger air chuck and 48mm for the 2-finger air chuck, respectively.

VI. EXPERIMENT

In this section, the effectiveness and feasibility of our approach are verified by assembling a part of an industrial product using the designed grippers. Considering the limit of our 3D printer, the product is scaled to 55% of its original size and printed out as shown in Fig. 10 (Left). According to the strokes of the grippers we use, one 2-finger gripper with maximum opening of 33mm, and three 3-finger grippers with maximum opening of 22mm, 60.5mm and 124.9mm are required. The finger of the 2-finger gripper should be longer than 2.5mm in order to grasping segment surrounded by gear teeth, the 3-finger gripper with stroke of 22mm should have fingers longer than 27.5mm, in order to avoid collision with the shaft. We model and print out the fingers and attach them to the air chucks, the 2-finger gripper is constructed by attaching 2 fingers on SMC MHF2-12D2 air chuck (stroke: 48mm, 0mm to 48 mm), the 3-finger gripper is constructed by attaching 3 fingers on SMC MHSL3-32D air chuck (stroke: 8mm, 34 mm to 42 mm). As shown in Fig. 10, the actual opening widths are slightly larger than the calculation results to account for the uncertainties.

We performed the assembly experiment on a NEXTAGE robot from Kawada Robotics Inc., as shown in Fig. 11, all the 13 assembly components can be firmly grasped by using the designed 4 grippers. In Fig. 12, since the assembly constraints are considered in selecting graspable segments of the assembly parts, the robot is able to successfully complete the task without collision with the subassembly during the assembly.

VII. CONCLUSIONS AND FUTURE WORK

Tackling the challenges of designing grippers for an assembly task, we presented a structured approach of designing and selecting the grippers. The input for our approach are the assembly specification and the geometrical models of the assembly components. In the first phase, the assembly components with complex shape are segmented into simpler parts, then the segmented parts are fitted with shape

primitives. By defining the correspondence between simple shape primitives and gripper types, suitable gripper types and parameters can be determined from the results of mesh segmentation and primitive fitting. In the second phase, the results in the first phase are examined under the assembly constraints, afterwards, the number of grippers is minimized by finding the opening width that covers dimensions of multiple assembly components. Finally, the effectiveness of designed grippers is confirmed by the assembly experiment.

In the future, the current work can be improved from several aspects: (1) We consider exploring more powerful mesh segmentation method [26] to decompose the assembly components, the affordance of the part will be taken into account in the segmentation. (2) More shape primitives such as cone can be used to improve the ability of fitting more complex shapes. (3) The representation of the assembly task and constraints can be refined, and classifying the basic assembly operations (such as peg-in-hole) can further automate the design process. (4) The fingertip shape can be studied in detail to increase the contact area.

REFERENCES

- [1] J. Schmalz and G. Reinhart, "Automated selection and dimensioning of gripper systems," *Procedia CIRP*, vol. 23, pp. 212–216, 2014.
- [2] M. Honarpardaz, J. Ölvander, and M. Tarkian, "Fast finger design automation for industrial robots," *Robotics and Autonomous Systems*, vol. 113, pp. 120–131, 2019.
- [3] M. Honarpardaz, M. Tarkian, D. Sirkett, J. Ölvander, X. Feng, J. Elf, and R. Sjögren, "Generic automated multi-function finger design," in *IOP Conference Series: Materials Science and Engineering*, vol. 157, p. 012015, IOP Publishing, 2016.
- [4] D. T. Pham, N. S. Gourashi, and E. E. Eldukhri, "Automated configuration of gripper systems for assembly tasks," *Proceedings of the Institution of Mechanical Engineers, Part B: Journal of Engineering Manufacture*, vol. 221, no. 11, pp. 1643–1649, 2007.
- [5] D. Pham and S. Yeo, "Strategies for gripper design and selection in robotic assembly," *The International Journal of Production Research*, vol. 29, no. 2, pp. 303–316, 1991.
- [6] K. Nie, W. Wan, and K. Harada, "An adaptive robotic gripper with l-shape fingers for peg-in-hole tasks," in *2018 IEEE/RSJ International Conference on Intelligent Robots and Systems (IROS)*, pp. 4022–4028, IEEE, 2018.
- [7] A. T. Miller, S. Knoop, H. I. Christensen, and P. K. Allen, "Automatic grasp planning using shape primitives," in *2003 IEEE International Conference on Robotics and Automation (Cat. No. 03CH37422)*, vol. 2, pp. 1824–1829, IEEE, 2003.
- [8] M. Przybylski, T. Asfour, and R. Dillmann, "Planning grasps for robotic hands using a novel object representation based on the medial axis transform," in *2011 IEEE/RSJ International Conference on Intelligent Robots and Systems*, pp. 1781–1788, IEEE, 2011.
- [9] K. Huebner and D. Kragic, "Selection of robot pre-grasps using box-based shape approximation," in *2008 IEEE/RSJ International Conference on Intelligent Robots and Systems*, pp. 1765–1770, IEEE, 2008.
- [10] N. Vahrenkamp, L. Westkamp, N. Yamanobe, E. E. Aksoy, and T. Asfour, "Part-based grasp planning for familiar objects," in *2016 IEEE-RAS 16th International Conference on Humanoid Robots (Humanoids)*, pp. 919–925, IEEE, 2016.
- [11] J. Bohg, A. Morales, T. Asfour, and D. Kragic, "Data-driven grasp synthesis survey," *IEEE Transactions on Robotics*, vol. 30, no. 2, pp. 289–309, 2013.
- [12] B. R. Cannon, T. D. Lillian, S. P. Magleby, L. L. Howell, and M. R. Linford, "A compliant end-effector for microscribing," *Precision engineering*, vol. 29, no. 1, pp. 86–94, 2005.
- [13] M. Honarpardaz, M. Meier, and R. Haschke, "Fast grasp tool design: From force to form closure," in *2017 13th IEEE Conference on Automation Science and Engineering (CASE)*, pp. 782–788, IEEE, 2017.



Fig. 11: Designed 4 grippers are able to firmly grasp all the 13 assembly components.

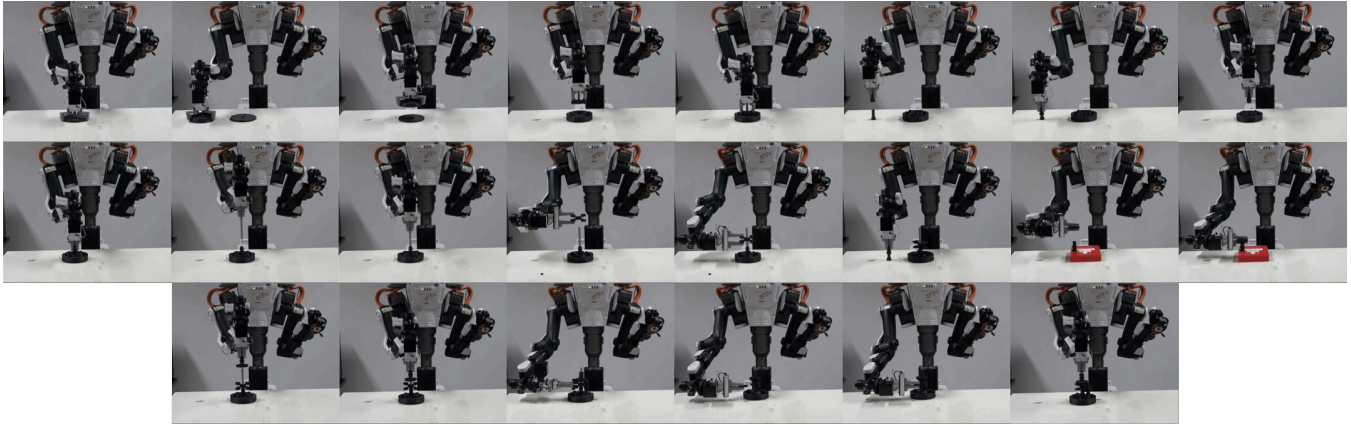

Fig. 12: The robot successfully assembled the product, there is no collision between the gripper and the subassembly.

- [14] K. Harada, T. Tsuji, S. Uto, N. Yamanobe, K. Nagata, and K. Kitagaki, "Stability of soft-finger grasp under gravity," in *2014 IEEE International Conference on Robotics and Automation (ICRA)*, pp. 883–888, IEEE, 2014.
- [15] M. Ciocarlie, C. Lackner, and P. Allen, "Soft finger model with adaptive contact geometry for grasping and manipulation tasks," in *Second Joint EuroHaptics Conference and Symposium on Haptic Interfaces for Virtual Environment and Teleoperator Systems (WHC'07)*, pp. 219–224, IEEE, 2007.
- [16] K. Harada, T. Tsuji, K. Nagata, N. Yamanobe, K. Maruyama, A. Nakamura, and Y. Kawai, "Grasp planning for parallel grippers with flexibility on its grasping surface," in *2011 IEEE International Conference on Robotics and Biomimetics*, pp. 1540–1546, IEEE, 2011.
- [17] A. Bicchi and V. Kumar, "Robotic grasping and contact: A review," in *Proceedings 2000 ICRA. Millennium Conference. IEEE International Conference on Robotics and Automation. Symposia Proceedings (Cat. No. 00CH37065)*, vol. 1, pp. 348–353, IEEE, 2000.
- [18] H. Song, M. Y. Wang, and K. Hang, "Fingertip surface optimization for robust grasping on contact primitives," *IEEE Robotics and Automation Letters*, vol. 3, no. 2, pp. 742–749, 2018.
- [19] K. Harada, K. Nakayama, W. Wan, K. Nagata, N. Yamanobe, and I. G. Ramirez-Alpizar, "Tool exchangeable grasp/assembly planner," in *International Conference on Intelligent Autonomous Systems*, pp. 799–811, Springer, 2018.
- [20] A. Kramberger, A. Wolniakowski, M. H. Rasmussen, M. Muni, A. Ude, and C. Schlette, "Automatic fingertip exchange system for robotic grasping in flexible production processes," in *2019 IEEE 15th International Conference on Automation Science and Engineering (CASE)*, pp. 1664–1669, IEEE, 2019.
- [21] L. Shapira, A. Shamir, and D. Cohen-Or, "Consistent mesh partitioning and skeletonisation using the shape diameter function," *The Visual Computer*, vol. 24, no. 4, p. 249, 2008.
- [22] A. Shamir, "A survey on mesh segmentation techniques," in *Computer graphics forum*, vol. 27, pp. 1539–1556, Wiley Online Library, 2008.
- [23] P. Cignoni, M. Callieri, M. Corsini, M. Dellepiane, F. Ganovelli, and G. Ranzuglia, "MeshLab: an Open-Source Mesh Processing Tool," in *Eurographics Italian Chapter Conference (V. Scarano, R. D. Chiara, and U. Erra, eds.)*, The Eurographics Association, 2008.
- [24] H. Mosemann and F. M. Wahl, "Automatic decomposition of planned assembly sequences into skill primitives," *IEEE transactions on Robotics and Automation*, vol. 17, no. 5, pp. 709–718, 2001.
- [25] N. Yamanobe, W. Wan, I. G. Ramirez-Alpizar, D. Petit, T. Tsuji, S. Akizuki, M. Hashimoto, K. Nagata, and K. Harada, "A brief review of affordance in robotic manipulation research," *Advanced Robotics*, vol. 31, no. 19-20, pp. 1086–1101, 2017.
- [26] T. Le and Y. Duan, "A primitive-based 3d segmentation algorithm for mechanical cad models," *Computer Aided Geometric Design*, vol. 52, pp. 231–246, 2017.