

# PA-Cache: Learning-based Popularity-Aware Content Caching in Edge Networks

Qilin Fan  
Chongqing University

Jian Li  
Binghamton University-SUNY

Xiuhua Li  
Chongqing University

Qiang He  
Swinburne University of Technology

Shu Fu  
Chongqing University

Sen Wang  
Chongqing University

## Abstract

With the aggressive growth of smart environments, a large amount of data are generated by edge devices. As a result, content delivery has been quickly pushed to network edges. Compared with classical content delivery networks, edge caches with smaller size usually suffer from more bursty requests, which makes conventional caching algorithms perform poorly in edge networks. This paper aims to propose an effective caching decision policy called PA-Cache that uses evolving deep learning to adaptively learn time-varying content popularity to decide which content to evict when the cache is full. Unlike prior learning-based approaches that either use a small set of features for decision making or require the entire training dataset to be available for learning a fine-tuned but might outdated prediction model, PA-Cache weights a large set of critical features to train the neural network in an evolving manner so as to meet the edge requests with fluctuations and bursts. We demonstrate the effectiveness of PA-Cache through extensive experiments with real-world data traces from a large commercial video-on-demand service provider. The evaluation shows that PA-Cache improves the hit rate in comparison with state-of-the-art methods at a lower computational cost.

## 1 Introduction

Recent years have seen an explosion of Internet traffic including images, audio and video contents, produced by a wide variety of mobile applications and edge users. To that end, edge caching such as 5G macro base station, has become the dominant technology to improve the performance of content delivery. Compared to the conventional content delivery networks (CDNs), edge caching has the following unique characteristics [12] [16]: (i) *Limited resources*. Unlike the cloud which has huge and diverse resources, the limited computing and storage resources of edge cache allow only a small set of contents to be cached and low-complexity tasks to be executed; and (ii) *Bursty requests*. The requests from edge users usually vary a lot over time. This makes conven-

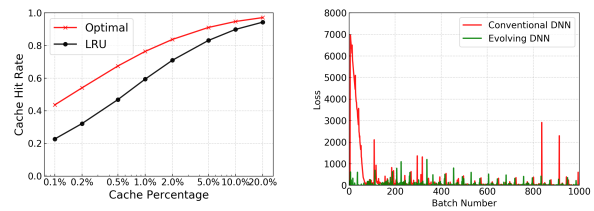

Figure 1: LRU vs. offline optimal algorithm.

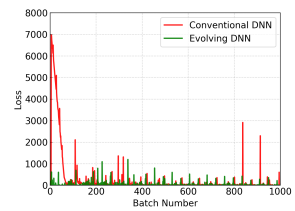

Figure 2: Model convergence over batch number.

tional caching algorithms perform poorly in edge networks. Figure 1 shows the performance of the widely used Least Recently Used (LRU) algorithm [5] and the offline optimal (Bélády’s) algorithm [2]. It is clear that LRU performs poorer when the cache size is small.

Recently, learning-based caching algorithms have been proposed to either learn content popularities to determine which content to evict when the cache is full or decide whether or not to admit a content upon a request. However, these approaches are subject to some limitations: (i) Reinforcement learning (RL) has been applied into caching algorithm design [9] [17] [8]. However, RL-based caching has been shown to perform suboptimally when compared to simple heuristics. A key challenge is that rewards (cache hits) manifest with large delays, which prevents timely feedback to the learning algorithm and introduces notable complexity [3]; (ii) The requests at edge caches are time-varying and bursty and new contents can be continuously generated by edge users. However, conventional deep neural networks (DNNs) require the entire training dataset to be available for learning a fine-tuned but might outdated prediction model with high computational complexity. It is difficult to adopt methods which are based on conventional DNNs [6] [15] at edge caches; (iii) Online learning-based algorithm, e.g., PopCaching [11], utilizes the similarity between the access patterns of different contents for predicting the popularity of content. However, its performance gain is highly dependent on the selection of hand-crafted features. Moreover, PopCaching’s prediction model, based on

the sample average approximation method, is still shallow. It would be difficult to learn complex patterns.

In this paper, we propose a novel popularity-aware caching decision policy, PA-Cache, for content caching at edge networks. Different from previous approaches, PA-Cache weights a large set of content features to adaptively learn the time-varying popularities at edge networks. Furthermore, to overcome the large computational costs of DNN, PA-Cache takes advantage of faster convergent shallow network at the beginning, and then the powerful representation of DNN when more requests arrive sequentially, which makes our algorithm highly scalable and computationally efficient. The experimental results show that PA-Cache approximates the optimal algorithm with 7% performance gap, and significantly reduces the computational costs compared to conventional DNNs as shown in Figure 2. This will be described in details in Section 4.

**Our Contributions.** We summarize our main contributions as follows:

- ▷ We present PA-Cache, a novel popularity-aware cache decision policy. It exploits the temporal content popularity prediction by attaching every hidden layer representation of the multi-layer recurrent neural network to an output regression. To learn the evolving popularity, we use a hedge strategy to adaptively train the DNN so as to improve the popularity accuracy at each iteration. To the best of our knowledge, this is one of the first work on popularity-aware edge caching.
- ▷ We conduct extensive experiments using real-world traces collected from iQiYi, the largest video-on-demand (VoD) service provider in China. The experimental results demonstrate the effectiveness and superiority of PA-Cache over several candidate algorithms.

**Roadmap.** The rest of this paper is organized as follows. Section 2 introduces the system architecture. PA-Cache and experimental results are presented in Section 3 and Section 4, respectively. We conclude the paper in Section 5. Section 6 summarizes the topics for future investigations.

## 2 System Overview

We design Popularity-aware Content caching, PA-Cache for edge networks. PA-Cache takes advantage of existing CDN caching structure. Figure 3 shows the system overview. PA-Cache has three basic modules: *Feature Updater (FU)*, *Learning Handler (LH)*, and *Decision Interface (DI)*.

- FU collects raw content features, and then generates input vectors for LH based on these. The corresponding vectors are temporarily stored in the feature database.
- LH takes the feature vectors generated by FU as input to the DNN to learn and predict content popularities.
- DI determines which content should be evicted when the cache is full based on the learned popularity.

The main operations of an edge cache consist of three procedures:

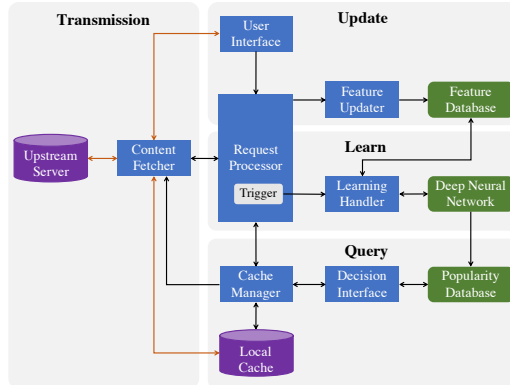

Figure 3: System overview of PA-Cache.

- **Update.** Upon a request, the *Request Processor* triggers the update process. FU collects the latest features from contents and writes it into the *Feature Database*.
- **Learn.** The *Request Processor* triggers a learning process periodically after every  $\phi$  hours. LH takes the feature vectors along with the ground-truth popularity as the input to train the DNN in an evolving manner. Here,  $\phi$  is a parameter characterizing the tradeoff between learning accuracy and computational costs, and needs to be properly chosen. We will evaluate its impact in Section 4. The updated predicted content popularity is written into the *Popularity Database*.
- **Query.** The *Cache Manager* checks if the requested content is in the *Local Cache*. If so, the *Content Fetcher* fetches the content from the *Local Cache* and responds to the request. Otherwise, the *Cache Manager* sends a query to the DI that determines which cached content should be evicted according to *Popularity Database* and returns a response to the *Cache Manager*. The *Cache Manager* evicts the least popular content, and asks the *Content Fetcher* to download the requested content from the *Upstream Server* to serve the request.

## 3 Popularity-aware Content Caching

### 3.1 Feature Selection

In order to predict content popularity, PA-Cache first extracts critical video features. In this paper, we consider two categories of features: the contextual features that would be variant over time; and the semantic features that would not change. The detailed features are given in Section 4. Specifically, to better describe the categorical (non-numeric) features (e.g., type, language), they are transformed into 0/1 coding vectors as the genres are independent of the order when they are labelled. This is inspired by the continuous bag of words language model [14]. In addition, since the numeric features (e.g., the number of video requests, length) may have a large value ranges, we normalize their values into the range of [0, 1].

## 3.2 Popularity Prediction

As motivated earlier, we consider an evolving prediction task. The goal of evolving deep learning is to learn a function  $F : \mathbb{R}^{m \times d} \rightarrow \mathbb{R}^m$  based on a sequence of training samples  $\mathcal{D} = \{(x_1, y_1), \dots, (x_t, y_t), \dots, (x_T, y_T)\}$ , that arrive sequentially from time step 1 to  $T$ , where  $x_t \in \mathbb{R}^{m \times d}$  represents the input features at time step  $t$ ,  $m$  is the number of instances, and  $d$  is the feature dimension. The corresponding revealed content popularity is denoted as  $y_t \in \mathbb{R}^m$ . The prediction is denoted as  $\hat{y}_t$ , and the learning performance is evaluated based on the cumulative prediction error of  $m$  mini-batch instances.

### 3.2.1 An Evolving Deep Learning Framework using Hedge Back Propagation

Given an input  $x$ , the content popularity prediction task can be conducted by a conventional multi-layer recurrent neural network (RNN) with  $L$  hidden layers. However, using such a model for evolving learning faces several challenges [18]:

- (i) **Model selection.** The network depth must be fixed in advance, and cannot be changed. However, depth selection is a daunting task, especially for evolving settings. For a small number of instances, a shallow network would be preferred for fast convergence, while for a large number of instances, a deep network could achieve better overall performance.
- (ii) **Convergence.** These include vanishing gradient, saddle point problems and diminishing feature reuse (useful shallow features are lost in deep feedforward steps). These issues are further exaggerated in the evolving setting.

To address these issues, we amend the multi-layer RNN architecture by attaching every hidden layer representation to an output regression for evolving learning through hedge backpropagation (HBP) [18]. HBP automatically decides how and when to adapt the depth of the network in an evolving manner. Figure 4 illustrates the evolving deep learning framework using HBP. Consider a multi-layer RNN with  $L$  hidden layers, i.e., maximum capacity is  $L$  hidden layers. Feature vectors are fed into a gated recurrent unit (GRU) layer, which has a powerful capacity to learn the long-term dependencies of sequential data, and capture the evolving patterns of dynamic content popularity. The standard GRU architecture can be described as an encapsulated cell with several multiplicative gate units. The prediction function for the proposed evolving DNN is given by  $F(x) = \sum_{l=1}^L \alpha^{(l)} f^{(l)}(x)$  where  $f^{(l)}(x) = \Theta^{(l)} h_t^{(l)}$ , and  $h_t$  hidden state vector.

### 3.2.2 Model Training

DNN is usually trained by using the mean square error loss function. However, when applied to heavy-tailed data which is common in VoD systems [19], this model may fail to produce accurate predictions. It is important to reduce the error on the most popular contents since any arithmetic mean is biased towards higher values. Given only a handful of such contents,

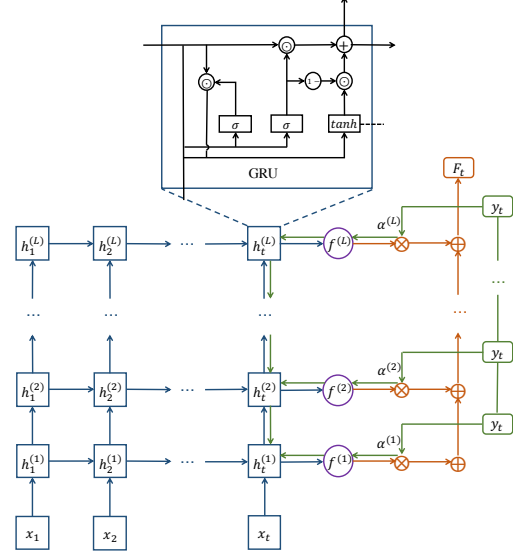

Figure 4: Evolving deep learning framework using HBP. Blue lines represent feedforward flows for computing hidden layer features. Orange lines indicate the prediction output followed by the hedging combination. Green lines indicate the updating flows with the HBP approach.

the overall performance of such model may be low for the majority of contents. In order to mitigate this limitation, we utilize the mean relative squared error instead.

Two sets of new learning parameters are also introduced, i.e.,  $\Theta^{(l)}$  (parameters for  $f^{(l)}(x)$ ) and  $\alpha^{(l)}$ . Unlike the conventional DNN, in which the final prediction is given by the regression using feature representation  $h^{(L)}$ , here the prediction is a weighted combination of regressions learnt based on the feature representations from  $(h^{(1)}, \dots, h^{(L)})$ . Each regression in intermediate layer  $f^{(l)}(x)$  is parameterized by  $\Theta^{(l)}$ . The final prediction of this model is a weighted combination of the predictions of all regressions, where the weight of each regression is denoted by  $\alpha^{(l)} > 0$ , and the loss suffered by the model is  $\mathcal{L}(F(x), y) = \sum_{l=1}^L \alpha^{(l)} \mathcal{L}(f^{(l)}(x), y)$ . During the evolving learning procedure, we need to learn  $\alpha^{(l)}$  and  $\Theta^{(l)}$ .

We employ the hedge algorithm [7] to learn  $\alpha^{(l)}$ . At the first iteration, all weights  $\alpha^{(l)}$  are uniformly distributed, i.e.,  $\alpha^{(l)} = \frac{1}{L}, l = 1, \dots, L$ . At every iteration, the regression  $f^{(l)}$  makes a prediction  $\hat{y}_t^{(l)}$ . The weight of the regression is updated as follows:  $\alpha_{t+1}^{(l)} \leftarrow \alpha_t^{(l)} \beta^{\min(\mathcal{L}(f^{(l)}(x), y), \kappa)}$ , where  $\beta \in (0, 1)$  is the discount rate parameter,  $\kappa$  is the threshold parameter for smoothing “noisy” data. Thus, a regression’s weight is discounted by a factor of  $\beta^{\min(\mathcal{L}(f^{(l)}(x), y), \kappa)}$  in every iteration. At the end of every iteration, weights  $\alpha$  are normalized such that  $\sum_{l=1}^L \alpha^{(l)} = 1$ .

Learning  $\Theta^{(l)}$  for all regressions can be done via gradient descent methods, where the input to the  $l$ -th regression is  $h^{(l)}$ . This update is given by:  $\Theta_{t+1}^{(l)} \leftarrow \Theta_t^{(l)} - \eta \alpha^{(l)} \nabla_{\Theta^{(l)}} \mathcal{L}(f^{(l)}(x_t), y_t)$ , where  $\eta$  is the learning rate.

Since shallower models are usually inclined to converge faster than deeper models [10], the hedging strategy might lower  $\alpha$  weights of deeper regression to a very small value, and thus lead to slow learning in deeper regressions. Therefore, a smoothing parameter  $\zeta \in (0, 1)$  is introduced to set a minimum weight for each regression. After the weight update of the regressions in each iteration, the weights are set as  $\alpha^{(l)} \leftarrow \max(\alpha^{(l)}, \frac{\zeta}{L})$ .  $\zeta$  guarantees that each regression will be selected with at least probability  $\frac{\zeta}{L}$ . This balances the tradeoff between exploration (all regressions at every depth will affect the backpropagation update) and exploitation.

### 3.3 PA-Cache Algorithm

For each incoming request  $R_k$ , we first extract its features of the requested content and update the *Feature Database* module. We then examine the local cache to see whether the requested content  $c(k)$  is cached. If  $c(k)$  is in the cache, then the client is served using the content copy in the local cache. Otherwise,  $c(k)$  is fetched from the upstream server to serve the client. In this case, PA-Cache evicts the least popular content  $c^{evict}$  already in the local cache according to the *Popularity Database* module. To quickly find the least popular content, PA-Caching maintains a priority queue  $Q$  that stores the cached contents along with their estimated popularities. The top element of  $Q$  is considered the least popular content. Each eviction operation will update  $Q$  accordingly. To keep the popularity estimates of contents up to date, PA-Cache triggers a learning process periodically after every  $\phi$  hour to update the predictions for contents.

## 4 Experimental Evaluation

To evaluate the performance of PA-Cache, we conduct extensive experiments on real-world data traces. This section presents and analyzes the experimental results.

### 4.1 Evaluation Setup

**Dataset.** The experiments are conducted on a mobile video behavior dataset [13] collected from iQiYi<sup>1</sup>, which is the largest VoD service provider in China. This dataset spans two weeks and covers two million users watching 0.3 million unique videos. In each trace item, the following information is recorded: (i) User id (anonymized): the unique identifier of each user; (ii) Request time: the timestamp when the user requests a video; (iii) Video content: the name and some basic information of the video, e.g., score, number of comments. Besides, we implement a crawler to collect more information to complement the features of videos such as the area, type, language, length, publish date, director, performer.

<sup>1</sup><http://www.iqiyi.com>

**PA-Cache Parameter Settings.** We implement PA-Cache using MXNet [4] on a PC with an Intel(R) Core(TM) i5-7360U CPU @ 2.30GHz and 8 GB RAM. We aim to learn a 10-layer evolving DNN with 512 units in the first layer and 16 units in the last hidden layer. The number of units from the 2-nd layer to the 9-th layer decreases gradually. The mini-batch size is 128. We set  $\beta = 0.99$ ,  $\kappa = 100$ , and  $\zeta = 0.1$ . The learning rate  $\eta$  is fixed to 10.

We build a discrete event simulator as illustrated in Fig. 3. To compute the results given the limited computing resources, we sample and pick  $C = 10,000$  videos from the dataset randomly in the experiments. By default, the storage capacity is set  $s = 100$ , i.e., the cache percentage is  $s/C = 1.0\%$ . The *Learning Handler* module trains a DNN in Fig. 4 after every  $\phi = 1$  hour. We separate the traces into two periods: (i) The warm-up period represents the input of the prediction of video popularity. This period lasts for the first seven days of the traces; (ii) The test period starts immediately after the warm-up period. The experimental results presented in this section are all obtained under the above settings unless explicitly clarified.

**Baselines.** We compare the performance of PA-Cache against the following benchmarks: (1) **PopCaching** [11]. The cache utilizes the similarity between the access patterns of different contents and predicts their popularity when making replacement decisions. (2) **FNN-Caching** [6]. The cache employs feedforward neural network (FNN) to predict content popularity and accordingly makes caching decisions. (3) **Optimal** [2]. The cache node runs Bélády’s MIN algorithm. It is an optimal, offline policy for replacing the content in the cache that has the longest time to its next occurrence. However, Bélády’s MIN algorithm is not implementable in a real system due to the fact that it needs future information. This algorithm establishes the performance upper bound.

### 4.2 Performance Comparison

The average cache hit rate is shown in Figure 5, where the x-axis represent cache percentage, which is the ratio between the cache size and the total number of unique contents. Since the performance of PopCaching is highly dependent on the hand-crafted features, we generate the content context vectors for several times and select the parameter setting which achieves 75 percentile. From Figure 5, we observe that PA-Cache achieves higher hit rate than PopCaching and FNN-Caching. For example, PA-Cache outperforms PopCaching and FNN-Caching by 11.7% and 5.2% in the case where cache percentage is 1.0%.

Figure 6 presents the long-term performance of the candidate algorithms over time. Again we observe that PA-Cache provides notable performance over PopCaching and FNN-Caching by up to 13.7% and 6.0% respectively. The performance gap between PA-Cache and Optimal is approximately around 7%. Moreover, PA-Cache maintains a more stable

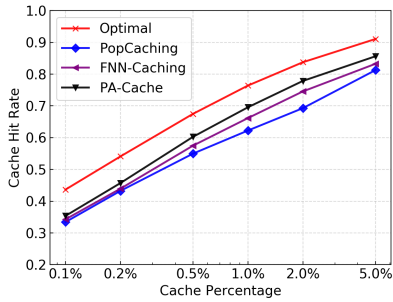

Figure 5: Cache hit rate over cache size.

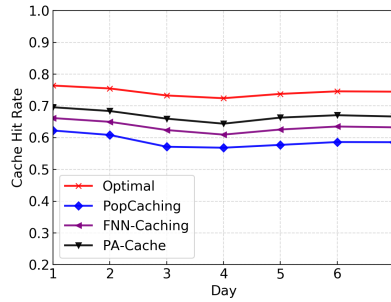

Figure 6: Cache hit rate over time.

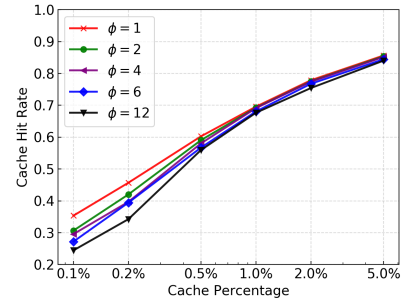

Figure 7: Cache hit rate for different  $\phi$ .

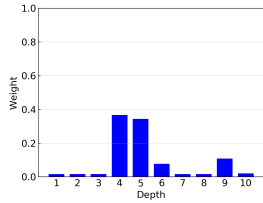

Figure 8: First 30% data.

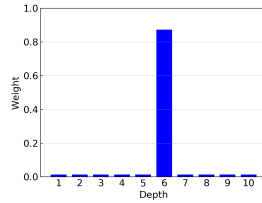

Figure 9: First 60% data.

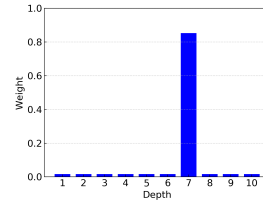

Figure 10: First 90% data.

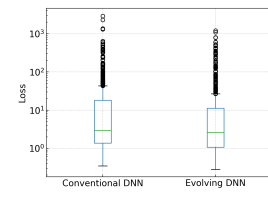

Figure 11: Loss value boxplot.

cache hit rate with a smaller variance of  $2.8 \times 10^{-4}$  compared to that of  $4.0 \times 10^{-4}$  for PopCaching and  $3.0 \times 10^{-4}$  for FNN-Caching.

We also evaluate the adaptability of our proposed evolving DNN model. Figures 8, 9 and 10 illustrate the evolution of DNN weight distribution over time on the training set. Initially (first 30%), the maximum weights have gone to shallower regressions in the 4-th and 5-th layers. Then slightly deeper regression with the 6-th layer picks the highest weight in the second phase (first 60%), and finally even deeper regression with the 7-th layer obtains higher weight (first 90%). It shows that our evolving DNN is capable of performing model selection.

We further compare the convergence behavior of our evolving DNN with a conventional 10-layer DNN as shown in Figure 2. It shows the variation of loss as the batch number increases. We observe that the loss of the 10-layer conventional DNN converges to a local optimum after about 120-th batches, while our evolving DNN converges much more quickly. It means that our evolving DNN can benefit from fast convergence of its shallow networks at the beginning. Moreover, the boxplots are shown in Figure 11 for 800 loss values obtained during the training after 200 batches. The boxes relate to the interquartile range, the whiskers represent the farthest MRSE values, the bar in the box represents the median value, and outliers are represented by the small circles. The boxplots indicate that the evolving DNN obtains smoother variance and lower median loss compared to the conventional 10-layer DNN. It also indicates that our evolving DNN also acquires the merits of powerful representation of its deep networks.

### 4.3 Practical Consideration

The first consideration is the frequency of re-estimation for content popularity. While updating the DNN more frequently allows the system to adapt to time-varying demands and correct for estimation errors more timely, each update incurs overhead. Figure 7 shows the impact of choosing different parameters of  $\phi$  on achievable caching performance under various cache percentage. As we can see, when the cache percentage is small, parameter  $\phi$  has a great impact on the cache hit rate. The smaller the  $\phi$  is, the higher the cache hit rate achieves. After the cache percentage increases to about 0.5%, the cache hit rate does not significantly change with  $\phi$ . This is meaningful in practice since the algorithm scales to different size of time window for update.

## 5 Conclusion

We presented the design, implementation and evaluation of PA-Cache, a novel popularity-aware content caching for edge networks. PA-Cache can effectively deal with the challenging content caching task upon time-varying content popularity. It combines the strength of recurrent neural network (i.e., GRU) in learning the comprehensive representations of requested contents and the hedge strategy (i.e., HBP) that utilizes an over-complete network to automatically decide how and when to adapt the depth of network in an evolving manner. We evaluated the performance of PA-Cache with experiments on real-world data traces. The experimental results demonstrated the effectiveness and superiority of our PA-Cache.

## 6 Discussion Topics

This paper has shown some promising preliminary results and demonstrated the potential of incorporating the evolving deep learning of time-varying content popularity into the caching decision making for edge networks. While there are several avenues for future work, we seek to highlight and discuss three key questions.

**How does the approach bootstrap newly popular content (i.e. flash crowds)?** The historical information is available for existing videos, but new videos generated from content providers may be added to the system continually. Although the historical information of  $\phi$  hour in our PA-Cache, much smaller than PopCaching or FNN-Caching, is enough for prediction. The cold start problem of new videos is still crucial for the performance improvement of caching system. We can employ a small LRU-cache space [1] to handle the load of new videos due to new releases for which we do not estimate. But how to adaptively partition the cache space deserves further investigation.

**How to design an efficient cooperation mechanism among cache nodes?** Our current work focuses on studying the caching policy for a single caching node. A more common setting in edge networks, however, involves a network of interconnected caching nodes. To improve the overall caching performance of edge networks, it is desirable that the cache nodes collaborate to decide which contents should be cached (e.g., to avoid storing redundant contents).

**What is the reason for the performance gap between PA-Cache and optimality, and how to further bridge it?** Figures 5 and 6 illustrate the performance gap between PA-Cache and Bélády's algorithm is stable, hardly influenced by time or cache percentage. It is essential to perform analysis of PA-Cache and optimal caching policy on real-world data traces to figure out the reason and gain the insights. Furthermore, inspired by Bélády's algorithm, we argue that to bridge the gap to optimality we might further devise deep learning methods to predict the arrival time or the ranking of contents and translate them into caching policy.

## References

- [1] David Applegate, Aaron Archer, Vijay Gopalakrishnan, Seungjoon Lee, and KK Ramakrishnan. Optimal Content Placement for a Large-scale VoD System. *IEEE/ACM Transactions on Networking*, 24(4):2114–2127, 2016.
- [2] Laszlo A. Belady. A Study of Replacement Algorithms for a Virtual-Storage Computer. *IBM Systems journal*, 1966.
- [3] Daniel S Berger. Towards Lightweight and Robust Machine Learning for CDN Caching. In *Proc. of ACM HotNets*, 2018.
- [4] Tianqi Chen, Mu Li, Yutian Li, Min Lin, Naiyan Wang, Minjie Wang, Tianjun Xiao, Bing Xu, Chiyuan Zhang, and Zheng Zhang. MXNet: A Flexible and Efficient Machine Learning Library for Heterogeneous Distributed Systems. *arXiv preprint arXiv:1512.01274*, 2015.
- [5] Edward Grady Coffman and Peter J Denning. *Operating Systems Theory*. Prentice-Hall Englewood Cliffs, NJ, 1973.
- [6] Vladyslav Fedchenko, Giovanni Neglia, and Bruno Ribeiro. Feedforward Neural Networks for Caching: Enough or Too Much? *ACM SIGMETRICS Performance Evaluation Review*, 46(3):139–142, 2019.
- [7] Yoav Freund and Robert E Schapire. A Decision-Theoretic Generalization of Online Learning and an Application to Boosting. *Journal of computer and system sciences*, 55(1):119–139, 1997.
- [8] Yu Guan, Xinggong Zhang, and Zongming Guo. CACA: Learning-based Content-Aware Cache Admission for Video Content in Edge Caching. In *Proc. of ACM Multimedia*, 2019.
- [9] Vadim Kirilin, Aditya Sundarajan, Sergey Gorinsky, and Ramesh K Sitaraman. RL-Cache: Learning-based Cache Admission for Content Delivery. In *Proc. of ACM NetAI*, 2019.
- [10] Gustav Larsson, Michael Maire, and Gregory Shakhnarovich. FractalNet: Ultra-Deep Neural Networks without Residuals. *arXiv preprint arXiv:1605.07648*, 2016.
- [11] Suoheng Li, Jie Xu, Mihaela Van Der Schaar, and Weiping Li. Popularity-Driven Content Caching. In *Proc. of IEEE INFOCOM*, 2016.
- [12] Dong Liu, Binqiang Chen, Chenyang Yang, and Andreas F Molisch. Caching at the Wireless Edge: Design Aspects, Challenges, and Future Directions. *IEEE Communications Magazine*, 54(9):22–28, 2016.
- [13] Ge Ma, Zhi Wang, Miao Zhang, Jiahui Ye, Minghua Chen, and Wenwu Zhu. Understanding Performance of Edge Content Caching for Mobile Video Streaming. *IEEE Journal on Selected Areas in Communications*, 35(5):1076–1089, 2017.
- [14] Tomas Mikolov, Ilya Sutskever, Kai Chen, Greg S Corrado, and Jeff Dean. Distributed Representations of Words and Phrases and Their Compositionality. In *Proc. of NIPS*, 2013.
- [15] Haitian Pang, Jiangchuan Liu, Xiaoyi Fan, and Lifeng Sun. Toward Smart and Cooperative Edge Caching for 5G Networks: A Deep Learning based Approach. In *Proc. of IEEE/ACM IWQoS*, 2018.

- [16] Nitish K Panigrahy, Jian Li, Faheem Zafari, Don Towsley, and Paul Yu. Optimizing Timer-based Policies for General Cache Networks. *arXiv preprint arXiv:1711.03941*, 2017.
- [17] Alireza Sadeghi, Gang Wang, and Georgios B Giannakis. Deep Reinforcement Learning for Adaptive Caching in Hierarchical Content Delivery Networks. *IEEE Transactions on Cognitive Communications and Networking*, 5(4):1024–1033, 2019.
- [18] Doyen Sahoo, Quang Pham, Jing Lu, and Steven CH Hoi. Online Deep Learning: Learning Deep Neural Networks on the Fly. In *Proc. of IJCAI*, 2018.
- [19] Chen Zhang, Yuedong Xu, Yipeng Zhou, and Xiaoming Fu. On the “Familiar Stranger” Phenomenon in a Large-Scale VoD System. In *Proc. of IEEE INFOCOM WKSHPs*, 2017.