

A Content-Based Deep Intrusion Detection System

Mahdi Soltani, Mahdi Jafari Siavoshani, Amir Hossein Jahangir

Abstract—By growing the number of Internet users and the prevalence of web applications, we have to deal with very complex software and applications in the network. This results in an increasing number of new vulnerabilities in the systems, which consequently leads to an increase in the cyber and, in particular, zero-day attacks. The cost of generating appropriate signatures for these attacks is a potential motive for using machine learning-based methodologies. Although there exist many studies on the use of learning-based methods for attack detection, they generally use extracted features and overlook raw contents. This approach can lessen the performance of detection systems against content-based attacks like SQL injection, Cross-site Scripting (XSS), and various viruses.

As a new paradigm, in this work, we propose a scheme, called deep intrusion detection (DID) system that uses the *pure content* of traffic flows in addition to traffic metadata in the learning and detection phases. To this end, we employ deep learning techniques recently developed in the machine learning community. Due to the inherent nature of deep learning, it can process high dimensional data content and, accordingly, discover the sophisticated relations between the auto extracted features of the traffic. To evaluate the proposed DID system, we use the ISCX IDS 2017 dataset. The evaluation metrics, such as precision and recall, reach 0.992 and 0.998, respectively, which show the high performance of the proposed DID method.

Index Terms—Deep Learning, Intrusion Detection, Content-Based Attacks, Recurrent Neural Networks, Long Short-Term Memory, Machine Learning, Misuse, Malware Detection, DoS Attacks.

I. INTRODUCTION

WE live in the cyber era in which network-based technologies have become omnipresent. Meanwhile, threats and attacks are rapidly growing in the cyberspace. Nowadays, mainly signature-based intrusion detection systems (IDSs) are used to detect these malicious traffics. However, since new vulnerabilities and, consequently, zero-day attacks appear each day, the cost of generating accurate signatures with a low false-positive rate is growing.

The traditional approach to intrusion detection systems is based on detecting some form of a *signature*. A signature is extracted from the known attacks by employing security experts. A signature must completely cover different variants of the attack for which it has been extracted. Also, benign traffic and other types of attacks should not be falsely confused with it. Hence, extracting an accurate signature is a complicated and time-consuming process. By the increasing growth of the Internet's applications and users, more vulnerabilities are expected to appear, which results in emerging more new attacks. Therefore, the signature extraction process becomes a more challenging problem in the coming years.

The learning-based approach is an alternative solution to the signature-based intrusion detection systems. In addition to resolving the signature extraction problem, some learning approaches can also detect zero-day attacks by determining abnormal traffic.

There exist several research studies on the use of machine learning methods for the detection of intrusions in computer networks. Among them, we can mention pioneers like Bayesian networks [1], support vector machine (SVM) [2], decision trees [3], and the new deep learning techniques (e.g., see [4] and [5]). These studies generally focus on some specific features of traffic as inputs, and they usually have a low potential to detect content-based attacks. However, it is well known that the content-based attacks, like SQL injection, malicious software, and viruses, are the most destructive attacks against assets that are accessible on the Internet.

According to our study, only a few of previous learning-based works on IDSs have considered content-based attacks. These works, like [6], [7], [8], and [9], use n -gram methods for extracting the frequencies of characters in deterministic windows. However, as shown in [10], n -gram methods are vulnerable to mimicry attacks. In these kinds of attacks, some unused parts of packets like IP options or PADDING parts in exploits can be used for adjusting the frequencies of n -grams.

A severe obstacle for analyzing the contents of network traffic is the large dimension of payloads. Nowadays, this challenge can be handled effectively by employing Deep Learning techniques [11], [12]. In this paper, a deep learning-based intrusion detection method, called deep intrusion detection (DID) system is proposed. It uses the pure content of traffic (i.e., packet payload) as the input data. In the pre-processing phase, the content of each flow is converted to a numerical matrix. The learning and detection phases use this matrix for separating normal traffic from the malicious one.

In this work, our primary contribution is to use all content bytes of traffic during the learning and detection phases. This goal is achieved by employing deep learning methods (in particular, in this work, we leverage using the LSTM neural network). Besides, we propose an appropriate pre-processing phase for feeding the traffic flows into the learning models. Finally, we evaluate our proposed scheme on the ISCX IDS 2017 dataset [13]. This dataset has an appropriate variety of full captured normal and attacks traffic; in particular, it contains some content-based attacks like Heartbleed.

The remainder of the paper is organized as follows. In Section II, we summarize the most relevant related works. Section III presents the details of the proposed DID system. This system also includes a pre-processing phase for preparing contents of traffic flows to be fed to a deep learning model (i.e., an LSTM neural network). In Section IV, the conducted experiments and results obtained are discussed. Finally, Sec-

M. Soltani, M. Jafari Siavoshani, and A. H. Jahangir are with the Department of Computer Engineering, Sharif University of Technology, Tehran, Iran. (email: mahdi@ce.sharif.edu; Corresponding author: mjafari@sharif.edu; Corresponding author: jahangir@sharif.edu)

tion V concludes the paper and explains the possible future directions.

II. RELATED WORKS

In the following, we will review some of the learning-based approaches used in intrusion detection systems.

A. Traditional Machine Learning Approach

In the literature, a variety of learning-based techniques such as support vector machine (SVM), naive Bayes, decision tree, random forest, and neural networks have been proposed for intrusion detection systems.

SVM is one of the most popular classification algorithms used so far. It has been used in research studies like [2], [14], [15] and [16]. In this algorithm, the classification process is performed by detecting a set of hyperplanes, as separators, in a high-dimensional space. The high time-complexity of the learning phase and the difficulty of finding a suitable kernel function are the most important challenges of this method. Learning time complexity has a superlinear relation with the number of input instances. Besides, there is a quadratic relation between the size of the kernel matrix and the number of instances.

Bayesian classifiers [17] use Bayes rule for predicting membership of input data to classes. They are built by using expert knowledge or efficient algorithms that perform inference. In Naive Bayesian classifiers, features are assumed to be conditionally independent. Though this assumption is not satisfied in practice, however, experiments have proved its good performance. Many papers have used this technique, e.g., see [18] and [1].

Authors in [18] have suggested generating multi-Bayesian network models in which each one separately generates an anomaly score for the input traffic. In [1], an IDS based on Bayesian network classifiers is proposed. In this research, association rules are used for the detection of normal/intrusion traffic. New traffic will get a low probability level for each of the normal or attack groups. So, these suspicious connections will also be labeled as an attack. In the second phase, these attacks are classified into four known or unknown attack categories by Bayesian rules.

One of the main data mining techniques used in intrusion detection systems is associated with decision trees. In [19], the misuse detection engine of Snort [20] is replaced by decision trees. Firstly, the existing rules are provided to a clustering algorithm for reducing the comparison needed to determine rules that are triggered by specific input data. These clusters are based on the values of important features. When the clustering algorithm reaches a rule set for the given feature of the input data, the decision tree determines the triggered rules inside that cluster.

Random forests (RF) [21] consist of a collection of decision trees. In addition to good performance in comparison with SVM and neural networks (NNs), this approach can run efficiently on large datasets with many features. RF is robust against overfitting and can handle unbalanced data. Works like [3] and [22] use this technique.

Artificial neural networks (ANNs) had been the most popular algorithms until the 1990s when SVM was invented. Of the benefits of SVM against ANN, one can mention to its having a less local minimum problem and also its lower learning time. However, with the emergence of new ANN variants like recurrent and convolutional NNs, the ANNs have begun to be used again.

In [23], a detector for finding attacks on Telnet is proposed. This system extracts 89 pre-defined keywords from the Telnet sessions. These keywords represent the suspicious actions or well-known attacks in Telnet. After extracting the distribution of these keywords, their statistics are given to a binary neural network. Finally, the instances which are recognized as attacks, are given to a secondary NN, which determines the class name of the attack. They have finally obtained detection rates up to 80%.

ANNs can also be used for the detection of DoS attacks like SYNFLOOD, UDPSTORM, and SMURF (for example, see [24]). For this purpose, authors of [24] use a time window, which is then labeled as normal or attack traffic. Since the input size of an ANN is fixed, they use a pre-processing phase with the aid of an anomaly-based ANN, namely, a self-organization map (SOM). SOM can cluster the input data into a fixed number of clusters. Hence, independently from the number of packets in the time window, a fixed number of inputs is provided for the ANN by this clustering technique. The model is evaluated by DARPA 1999 dataset [25] and reaches 100% detection of normal traffic and 76% false-positive rate for attacks.

In 2017, feature reduction techniques had been proposed by using ANNs [26]. The authors use a combination of information gain and correlation for feature selection. Then, after normalizing the numbers of each class in the KDD99 dataset [27], their model achieves the average recall value of 91.72%.

B. Deep Learning Approach

Recurrent neural network (RNN) is a class of ANNs in which nodes have some amount of memory. As a result, in addition to the current input, the previous inputs can also influence the current output. These networks are suitable for sequential inputs that possess a dependency with each other. Long short-term memory (LSTM) network is a class of RNNs [28]. LSTM has been proposed to solve the vanishing and exploding gradient by introducing some gates to the neural network structure. Therefore, LSTM can effectively learn the relations between items that are far away from each other in a sequence. Computer network flows, consisting of packets, form a sequence of data; hence, RNN and LSTM are natural candidates for the analysis of computer network traffics.

Authors in [4] have employed gated recurrent unit (GRU), which is a variant of LSTM. They have slightly modified GRU and used SVM as a classifier instead of the softmax function. The goal of this modification is to increase the computational efficiency of the model. They have evaluated the proposed model with 2013 network traffic data obtained by the honeypot systems at Kyoto University. The inputs of this model are 24

statistical features of the dataset. For improving performance and reducing the computation cost of the mode, the continuous features are converted to bins and, finally, are represented in a one-hot format. Their model has an average accuracy of 80.53%.

In another work, Kim et al. [29] have applied LSTM architecture in IDS and use the KDD99 dataset for evaluating their proposed model. Their input vector contains 41 normalized features, and the output vector is composed of 4 attack classes and one non-attack class. In their evaluation, the average values of recall and fall-out are 98.79% and 10%, respectively.

In [30], the authors use deep learning for detecting anomalies in a software-defined network (SDN) environment. They use six basic features of the NSL-KDD dataset (duration, protocol type, SRC bytes, DST bytes, count, and SRV count) to detect anomaly flows. Finally, the attack detection accuracy is reported as 75.75%.

Also, in some other research studies like [31], [32], and [33], the deep learning approach is employed for the reduction of input dimensions by selecting among pre-extracted features.

Although deep learning methods have been proposed for solving intrusion detection problems so far, to the best of our knowledge, they use extracted features of inputs, as in traditional approaches. These features mostly represent general aspects of traffic flow, like source/destination port/IP address, duration time, start time, and packet/byte number of sent or received packets. These features are generally crucial to the detection of some kinds of attacks like DDoS and portscan. However, many important attacks, like SQL injections, worms, viruses, and XSS, which are content-based attacks, have general features very similar to benign traffics. In the following, some traditional research studies which have paid attention to these kinds of attacks are reviewed.

C. Content-Based Approach

Generally, some restricting extracted features are used in machine learning-based intrusion detectors. These general features are rarely based on contents transmitted through the established flow. Consequently, content-based attacks have a high impact on the security and privacy of network applications and services in such systems.

In the following, we review some related works on content inspection for intrusion detection. Most of the payload-based detectors extract statistical features by using the n -gram technique. PYLE [6], Anagram [7], and McPAD [8] are among the most well-known works. PYLE uses 1-gram method and extracts the frequency of values in each byte of the packet. Anagram uses 5-gram and stores the extracted 5-grams in Bloom filters. There are two kinds of Bloom filters in this work: one designed for attacks and the other for benign n -grams. Finally, these two Bloom filters examine the input traffic.

It is evident that in n -gram analysis, the dimension of feature space grows dramatically. Hence, limited by the curse of dimensionality problem, in practice, this approach can be used at most for $n = 2$, which yields 65536 features. To mitigate this problem, McPAD [8] measures the frequency

of the occurrences of pairs of symbols (bytes), which are k bytes apart from each other in the payload. In this way, some information in n -grams with $n > 2$ can be extracted by such pairs of bytes. Moreover, this method will only generate 256^2 features regardless of the value of k .

In [10], the authors show that blending attacks can defeat n -gram methods. These attacks fill unused parts of network traffics with new characters in proportion to the target frequency and, consequently, convert the statistics of characters to become similar to benign traffics. Their evaluation shows that to launch an attack against a 5-gram detector, at least two packets (i.e., about 2000 bytes) are needed. Besides, they propose fragmentation overlapping for solving larger values of n . Different operation systems (OSs) have different behaviors for extracting bytes in overlapping situations. They may prefer the first or last arrived overlapped bytes. The other bytes will be ignored by the OS. So these ignored bytes can be used in higher values of n for deluding the n -gram detectors.

In another research [34], after encoding the content by Base64, the integer values are extracted. Finally, the frequencies of these integer values are enumerated. Even though authors do not mention an n -grams method, but in fact, they have used a 1-gram approach.

III. METHODOLOGY

The high dimensionality of traffic content is one of the biggest challenges in the detection of content-based attacks. Although this challenge can be addressed by employing deep learning methodology, according to our survey, all the previous proposed studies have focused on pre-extracted features which are vulnerable to content-based attacks.

In this work, we propose a deep learning-based IDS method to extend the detection scope by covering the content-based attacks as well. Since traffic contents can have long-time dependencies, input feature space should have a high dimension. As deep learning methods are designed for such large data spaces, we propose using deep learning techniques directly on the raw bytes of contents instead of applying it to the extracted traffic features. The proposed method is called deep intrusion detection (DID). This method can be applied to both passive and on-line traffic. In this research, the passive mode is followed, as illustrated in Figure 1.

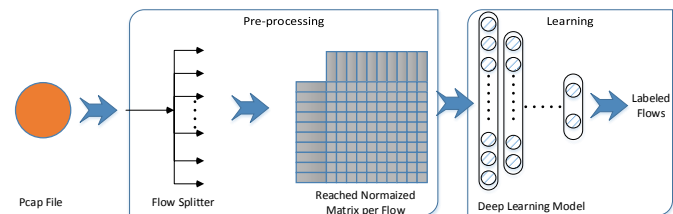

Fig. 1. General illustration of DID system in the passive mode.

Since traffic flows consist of sequences of data, algorithms like RNN and LSTM that are developed for sequential data are among the best candidates for the DID approach. In the following, we describe the proposed DID approach and explain how it uses deep learning methods to detect content-based

attacks. In the following, we have two main subsections. The first one provides a complete description of the pre-processing module, and the second highlights the deep learning module of DID. In particular, in this work, we will employ LSTM for the deep learning module of DID. However, it should be noted that DID is not only limited to use LSTM, rather other algorithms can also be employed in the deep learning module.

A. Pre-processing Phase in Deep Intrusion Detection

Traditional learning methods highly depend on the pre-extracted features. As a result, the accuracy of such algorithms depends heavily on the selection of input features. Hence, these features should be found and extracted by experts, which makes the process expensive, time-consuming, and prone to error. Moreover, due to the increase of variant of known attacks and the emergence of new ones, extracting some static and definite features cannot provide adequate information for intrusion detection tasks.

In contrast, deep learning algorithms can extract complicated features from the raw data automatically. Consequently, to address the above issues, DID uses deep learning techniques to learn various cyberattacks, including content-based attacks. It is well known that deep learning algorithms can detect sophisticated relations in high dimensional spaces. Hence, they are good candidates for the detection of content-based attacks.

Although some content-based intrusion detection systems like [6], [7], and [8] focus on packet-level granularity, in real-world, some packets can belong to both benign and attack flows (e.g., SYN or FIN packets, or HTTP GET requests in DDoS attacks). Moreover, some attacks are distributed among more than one packet. Therefore, the concept of malicious traffic resides in the flow contents. As a result, we assume that the input to the DID method is based on flows instead of packets.

In this work, we propose an offline version of DID, where each flow is considered as an input sequence to an LSTM neural network. Each packet represents a data point in the input sequence. Since the maximum Ethernet frame size is around 1500 bytes, so we consider 1500 as the dimension for each packet. Hence, the input is assumed to be a sequence of 1500-dimensional points.

Additionally, the size of input sequences depends on the number of packets in the traffic flows. In the offline DID, we assume some reasonable maximum value for the number of packets (which we will later determine this parameter by inspecting the dataset). Finally, since each byte is in the range of 0 to 255, in order to improve the deep network performance and making the parameters on the same scale, we normalize each byte value to a number between 0 and 1, by dividing it to 255.

According to the pre-processing phase explained above, we have a normalized matrix per each flow (as depicted in Figure 2), where rows describe different packets in the flow, and the i th column contains the normalized value of the i th bytes of packets. Moreover, we add a column to the matrix for storing inter-arrival times of packet flows to detect attacks such as HTTP flooding, which sends some benign

requests continuously over the established connection. These normalized matrices can be the input of the deep learning module of DID (we will later enrich these matrices).

1 st packet						
2 nd packet						
3 rd packet						
⋮						
k th packet						
packet's time interval	1 st byte	2 nd byte	3 rd byte	...	n th byte	

Fig. 2. Basic output of the pre-processing phase in the form of a normalized matrix, that is fed into the deep learning module.

Considering a large number of parameters in deep learning algorithms, and a limited number of flows that are used in the training phase, there is a reasonable chance of overfitting if the datasets are not used with enough care. As an example, IP addresses can be a misleading factor. This misleading effect exists in most of the available public datasets like ISCX IDS 2017 [13] and KDD99 [27]. In [35], authors have shown that many parameters of the DARPA 99 [25] traffic, like TTL, TOS, and the IP addresses, can cause overfitting. For example, TTLs of the attack traffics are mostly 126 and 253, but benign traffic has nine restricted values, which are different from the attack ones. Besides, source IP addresses of attacks are different from benign traffics and can simply be used for discrimination. The KDD99 dataset also has inherited these vulnerabilities. Since the attack traffic constitutes a small part of the dataset, there are so many IP addresses that are purely normal, and the algorithm can assign a substantial weight for IP addresses to attain higher accuracy. However, we know that this is not a valid assumption in the real-world.

Considering the above issues, in our pre-processing phase, we eliminate some bytes of packets that belong to fields like CHECKSUM and IP addresses. It should be noted that this elimination can cause some performance reduction in the detection phase. For example, ignoring the client's IP address in a monolithic environment, like a university, can avoid overfitting, but in heterogeneous networks with different types of clients, some valuable information can be missed. Besides, server IP addresses can be beneficial in server-side IDSes. So, in the real world, this elimination should be applied according to the conditions of the deployment environment.

The pre-processing phase can be completed by enriching the normalized matrices. The basic pre-processing matrices are adequate for detecting flow-based attacks. However, there exist other kinds of attacks that can be recognized by considering some intra-flows features. These features are also added to the first row of the basic pre-processing matrix to make it richer. For example, *flooding* attacks can be generated by making many legitimate connections rapidly, and these kinds of attacks can be detected by adding time intervals between flows. Since in the real world, the normal and attack flows are interleaved, the computation of the time interval between flows should be

based on the original flows' arrival times. The other approach is based on splitting the flows into benign traffic and attack, and then extracting the time interval in each subgroup. This approach can increase the detection error ratio when there exists normal traffic between attacks.

To address the intra-flow attacks, we use four more extensive intra-flows features as follows: aggregative source or destination address repetition in a fixed-size bucket of packets or in a time window. Attacks like DDoS use multi different IP addresses to send requests to the victim server, called Type I attacks. Detection of this kind of attack can be done by aggregating flows that have the same destination IP address. On the other hand, in some attacks like port scanning, there is a single client IP address that tries to recognize different active services (ports) on a specific victim IP address or a specific service (port), which is activated on a network range. The mentioned scenarios have the same source address and destination port or same source and destination address, respectively. For simplification, we call these kinds of attacks as Type II.

Another important aspect of detecting intra-flow attacks is network bandwidth. For networks with low bandwidth, a fixed size window (or bucket) is used for aggregation. As the time interval between flows can exceed the time threshold, time windows cannot detect the attacks. On the other hand, the fixed-size window cannot detect attacks in high-speed traffics because the window will be filled rapidly, and the new information will overwrite the older ones. A time window can handle this situation as well. In real networks, bandwidth has no fixed value, and according to the conditions like days vs. nights, it can have low or high bandwidth. So we use a combination of these two kinds of windows for the detection of intra-flow attacks.

The four aforementioned intra-flow features are extracted per each flow. Detection of Type I attacks depends on the aggregation of flows based on their destination IP addresses. Hence, as a new flow arrives, it is compared with flows that are observed in the fixed-size and fixed-time windows. The number of flows having the same IP address as the new one in both windows is used as features. Similarly, aggregation based on the source IP address is done for the detection of Type II attacks. In this case, the source address of each flow is compared with the source addresses of flows in the fixed-size and fixed-time windows.

Finally, the five new intra-flow features will be added to the first row of the basic normalized matrix (see Figure 3). This enriched matrix will be used as an input of the deep learning module of DID. In the following, some candidates for DID deep learning module are discussed, and the LSTM model is implemented.

B. Deep Learning Module of Deep Intrusion Detection

As mentioned earlier, in DID, we prepare a rich normalized matrix as the input for a deep learning algorithm. This matrix has the potential for extracting content-based and some intra-flow attacks. In the following, some candidates for deep learning modules are discussed. The main important point, which

Flow's information	Flow's time interval	Aggregate src in time window	Aggregate dst in time window	Aggregate src in fixed sized window	Aggregate dst in fixed sized window	0	...	0
1 st packet								
2 nd packet								
3 rd packet								
...								
k th packet								
Packet's Time Interval		1 st byte	2 nd byte	3 rd byte	4 th byte	n th byte

Fig. 3. The format of enriched normalized matrices that are used as the input to the deep learning module of DID.

is common among the proposed methods, is the sequential nature of these algorithms. In fact, since packets, flows, and network traffics are all, in general, sequential data, the chosen algorithms should match or benefit from this feature.

1) *Recurrent Neural Networks*: Recurrent Neural Network (RNN) is suitable for learning patterns in data sequences and time series, such as processing natural languages and genetic data [36]. This feature makes RNN an extremely useful tool for analyzing computer network traffic. The difference between recurrent neural networks and feed-forward neural networks is that besides the current input, some information from previous inputs is also processed. In RNN, decision making related to an input instant at the moment t depends on the decision made at the moment $t - 1$.

The mathematical definition of the forward memory transfer process in recursive neural networks is as follows

$$h_t = \phi(Wx_t + Uh_{t-1}),$$

where h_t is the state of the hidden layer of the recurring neural network at the moment t . The value of h_t is a function of the input at the moment t (i.e., x_t) which is multiplied to hidden layer weights W , and the last moment hidden layer feedback h_{t-1} which is multiplied to its own weights U . The weight matrices apply the relative importance of the input at the current moment and the feedback input from the previous moment.

2) *LSTM*: LSTM is a special type of recurring neural network which is capable of learning long-term dependencies. These networks have proven to be very effective in many different circumstances and are now widely used in practice. An LSTM layer consists of some similar units, called LSTM cell. Inside each cell, there are four neural networks linked to each other in a specific structure (see Figure 4). One of the main concepts in an LSTM cell is its state, denoted by C_t . The cell state passes forward in the entire recurring neural network chain, and only a few linear operators are applied to it. The LSTM network is capable of clearing or adding information to the cell state by using the gateways. The current input x_t of the neural network is concatenated with the feedback input h_{t-1} , and this joint vector enters into four distinct neural networks. If the current input and the feedback input of the LSTM cell have equal sizes (e.g., n), then the input to each of those four neural networks is equal to $2n$, and each of them has n neurons and produces n outputs.

The activation functions of the four neural networks are not the same; three neural networks have the "sigmoid" activation

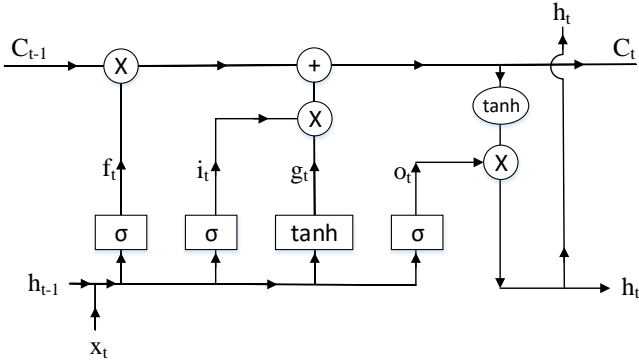

Fig. 4. The internal structure of an LSTM cell.

function, and the other one uses “*tanh*”. The outputs of the three neural networks with the sigmoid activation function are called i , f , and o , respectively, and the output of the neural network with the *tanh* activation function is called g . The outputs of these neural networks enter the gateways and generate the output of the entire LSTM cell and the new cell state that goes to the next LSTM cell.

The function that is applied by the gates to the outputs of the neural networks can be described as follows. Since f , i , and o are outputs of the sigmoid activation function, they have values between zero and one. This makes these outputs suitable for acting as gateways. If we look at the status of a cell in the form of a variable, the f gate can restore the cell state to its original value (i.e., set its value to 0). The goal of the gateway i is to determine if it is going to increase or decrease the cell state, and gate g specifies the amount of change in cell state. As described above, gate g is the output of the *tanh* activation function so that it can be between -1 and 1 . Therefore, if i manages to make a change in cell state, the value of this change is determined by the gate g . The o gate also specifies whether the cell’s state should be transferred as the exit of this layer to the output or not. Consequently, LSTM learns when it is necessary to forget a piece of information and when it is necessary to process and memorize them.

3) *LSTM-Based Classifier*: Since in practice, it has been observed that LSTM based classifiers and their variants perform very well on sequential data, we construct a deep learning model with two LSTM layers as a proof of concept for our proposed deep intrusion detection (DID) framework. Figure 5 presents the details of the proposed model. As shown in Figure 5, after extraction of sequential features with LSTM layers (with 100 and 50 units, respectively), some fully connected layers (with 2500, 1250, 512, 256, 64, and 16 neurons) are employed to extract the more complicated features. Finally, a softmax layer is applied for binary classification between attack and benign traffics. The activation functions of all layers (except the last one) are ReLU, and in order to avoid overfitting, some dropout layers with a 20% drop rate are added among fully connected ones. Finally, the Adam algorithm is used for optimization in the training phase, and the loss value is computed by binary cross-entropy as the loss function.

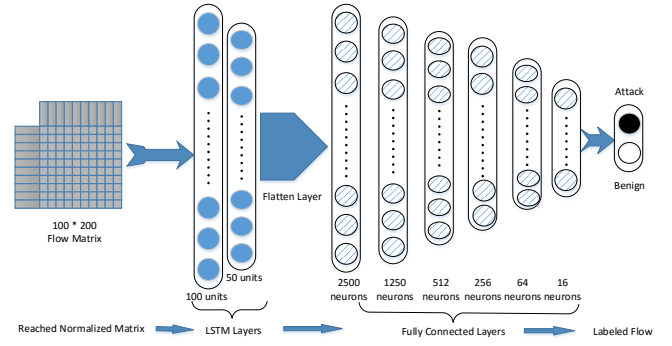

Fig. 5. The proposed LSTM-based classifier used in the our DID framework.

TABLE I
DETAILS OF THE ISCX IDS 2017 DATASET.

Day	Attack type	Attack Size	Benign Size
Monday	-	0B	11GB
Tuesday	Brute Force	51MB	11GB
Wednesday	DoS / DDoS	2GB	11GB
Thursday	Web Attack, Infiltration	42MB	8.4GB
Friday	Botnet ARES, Port Scan	2GB	7.5 GB

IV. EXPERIMENT

This section contains a real implementation of a DID instance on the ISCX IDS 2017 dataset. In the following, first, the ISCX IDS 2017 dataset is briefly introduced. Then, after the explanation of the pre-processing phase, the experimental results are presented and compared with McPAD [8] as a well-known content-based detection approach.

A. Dataset

For this research, ISCX IDS 2017 is used as the benchmark dataset. This dataset is made of 30GB network traffic captured in seven different days, which is the most recent IDS evaluation dataset and contains different types of attacks. Especially, content-based attacks like Heartbleed are also included in this dataset. Traffic capturing is done in a simulated computer network with several servers and clients. The developers of ISCX IDS 2017 have analyzed real traces of a client-server network and have tried to create the same profile for the clients. The details of the seven days of network traffic are shown in Table I.

The main advantages of this dataset compared to the previous ones are:

- Implementing a complete network configuration, including Modem, Firewall, Switches, Routers, and a variety of operating systems.
- Simulation of user profiles.
- The dataset is labeled. This is a requirement for classification purposes. Besides, it presents the full captured traffic without anonymization techniques.
- Implementing all kind of interactions in the network.
- Using a wide range of protocols and network attacks.

Although, as explained above, this dataset has many advantages, it has its shortcomings too. One of the most important

deficiencies of this dataset is its limited variety of protocols and attacks in comparison to real-world traffics. For example, IP addresses of attack traffic are very limited, and hence, the other IP addresses can be recognized as pure benign traffic. More precisely, attacks on Tuesday and Wednesday are just focused on one and two destination addresses, respectively. Besides, DoS attacks on Friday are all from a specific client IP address. On the other hand, real network conditions like packet loss and different TTLs are not presented in this dataset. Moreover, so many kinds of applications like social networking, are not considered.

Finally, according to our survey, the ISCX IDS 2017 dataset is one of the best dataset available in the context of IDS. However, we should be aware of its weaknesses and simplicity. Obviously, in the real world, we need to implement more complicated models with increments in the number of layers and the number of nodes in each layer. Moreover, as discussed in Section III-A, we should be aware of this lack of diversity in the pre-processing phase.

B. Pre-processing

In this phase, we prepare the dataset as the input of a neural network. First, we need to extract and split the network flows from the pcap files. To this end, we read the large pcap files and make separate files per each flow. Flow separation is based on the source port, destination port, source IP address, destination IP address, and flow start time. The end of flow is reached when the TCP FIN packet is read, or the maximum flow time (1,200,000 ms) is passed.

1) *Constructing the Input Matrix:* Network flows are not suitable to be input directly to the neural network. To make the flows applicable, we have to apply several changes to them. First, we read the packets of each flow. For each packet, the data link header is removed since it does not have any information for network intrusion detection tasks. Then we read the bytes of the packet and divide them by 255 to obtain a normalized value between 0 and 1.

The maximum size of each packet is 1514 bytes, and smaller packets are padded by zero-value bytes. Besides, since the header length of UDP is less than TCP, we add zero to the end of the UDP header so it will have the same size as TCP header. There are some fields in network traffic, which can mislead the deep learning model. For example, the checksum field can have random values, and most probably, it is useless. Moreover, as explained above, IP addresses can lead to the overfitting problem. We mask the value of these fields by zero. In the end, we will have an $n \times 1514$ matrix, where n is the number of packets.

The dimensions of the input matrix for this dataset can be reduced by inspecting the dataset traffic. As shown in Figure 6, packet size in normal and attack traffic has two distinct ranges: packets that have only the first 200 bytes, and packets with the maximum size of 1514 bytes. By performing several experiments on the dataset, we found that the first 200 bytes of each packet constitutes the discriminant bytes, and inspecting extra bytes has no significant impact on the learning accuracy. In addition, benign and attack flows in this dataset

contain mainly less than 100 packets (as shown in Figure 7). So, inspecting only the first 100 packets of each flow can yield almost a complete evaluation of the nature of flows in the ISCX 2017 dataset.

Finally, we have chosen the first 200 bytes of the first 100 packets of each flow as an input matrix according to the nature of flows in this dataset.

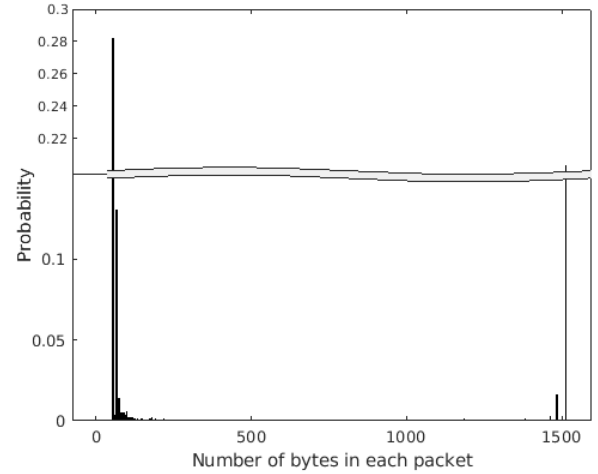

(a) Benign

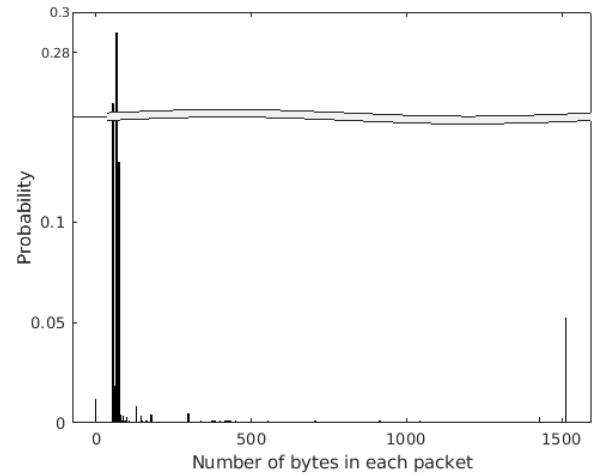

(b) Attack

Fig. 6. Distribution of the number of bytes per packet in benign (6a) and attack (6b) traffic.

2) *Subsampling:* As shown in Table I, the size of the ISCX IDS 2017 dataset is 50GB before the pre-processing phase, and the pre-processing phase increases its size tremendously to more than 500GB. Due to hardware limitations, we cannot use all of the network flows for training the neural network. Therefore, we need to reduce the size of the dataset. Also, the dataset is imbalanced, and the number of normal flows is much higher than the number of attack flows. This does not allow to train correctly and sufficiently the neural network. To fix these issues, we choose all of the attack flows and select the same amount of normal flows randomly, which will balance the dataset and reduce the size of the input data. Finally, we have a pre-processed dataset with a size of around 40GB.

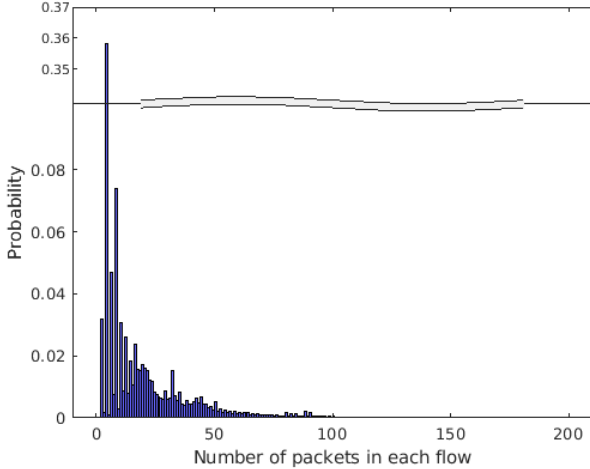

(a) Benign

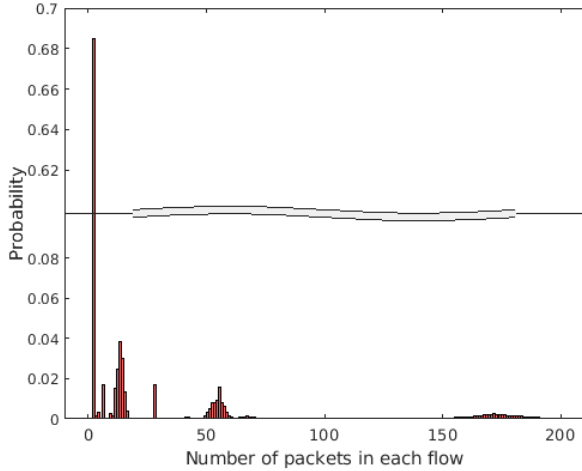

(b) Attack

Fig. 7. Distribution of the number of packets per flow in benign (7a) and attack (7b) traffics.

C. Experimental Results

After converting each flow to an enriched input matrix, we have split the dataset randomly into three subsets. The first set, which contains 64% of the flows, is used for training and tuning the weights of the deep learning model. The second and third sets are used during validation and test phases and contain 16% and 20% of flows, respectively.

There exist several metrics for evaluating the performance of the trained model. Among them, we have chosen precision (PR), recall (RC), fall-out (FO), and F_1 score (F_1). Based on a confusion matrix, equations of these parameters are stated as follows (TP: true positive, FP: false positive, TN: true negative, and FN: false negative):

$$PR = TP / (TP + FP), \quad (1)$$

$$RC = TP / (TP + FN), \quad (2)$$

$$FO = FP / (FP + TN), \quad (3)$$

$$F_1 = \frac{2 \times PR \times RC}{PR + RC}. \quad (4)$$

TABLE II
THE HARDWARE EXPERIMENT ENVIRONMENT.

OS	Debian version 9.3 with kernel 4.9.0-amd64
CPU	Intel(R) Xeon(R) X5680 3.33GHz with 24 virtual cores
RAM	18 GB
GPU	GeForce GTX 1080 Ti
GPU Frame Buffer	11 GB

Recall (RC) is a valuable metric in IDSs as it determines the ratio of attacks that have been detected to the actual attacks. Besides, the ratio of benign flows, which are labeled as attacks, to the total actual benign flows is determined by the fall-out (FO). Precision (PR) shows the ratio of correctly generated alerts (existence of attacks) to all alerts. This metric represents the trust of network administrators to the generated security alarms. Finally, F_1 score tries to make a balance between the importance of precision and recall. This is achieved by calculating the harmonic mean of these valuable metrics.

To implement our deep learning model, we have used the Keras library [37], with Tensorflow [38] as its backend. The characteristic of our experiment environment is shown in Table II.

Figure 8 depicts the value of loss in the training phase. Finally, at the end of the training phase, the mean of loss in training and validation data is 0.03 and 0.01, respectively. The lower value of loss in the validation phase is due to the dropout layers applied during the training phase, which improves the generalization of the deep model. Consequently, by removing them in the validation phase, better results have been achieved. The results of the evaluation of this model by the test data are presented in Table III.

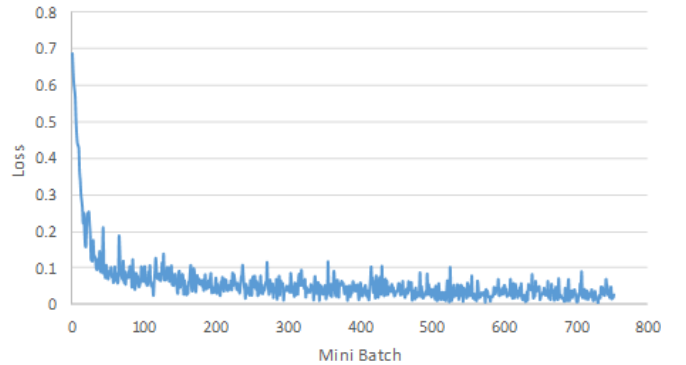

Fig. 8. Loss of the proposed deep learning module of DID during the training phase.

Our work is comparable with [34] and [8]. Soheily-Khah et al. [34] use 50 features of the ISCX 2012 dataset for evaluation of their model, which is achieved by combining K -means and random forest algorithms. This research is related to our work since it uses some learning algorithms over the ISCX dataset, and this method can be compared with deep learning. Their model has achieved recall and fall-out of around 98.9 and 0.1, respectively. Note that since they have not announced the average evaluation metrics, we have used their reported tables

TABLE III

THE RESULTS ACHIEVED BY THE PROPOSED DID FRAMEWORK AND ITS COMPARISON TO McPAD, BOTH EVALUATED ON THE ISCX IDS 2017. BESIDES, THE REPORTED VALUES OF [34] OVER ISCX IDS 2012 ARE PRESENTED.

Dataset	Model	Precision	Fall-out	Recall	F_1 score
ISCX IDS 2017	DID (with LSTM)	0.992	0.002	0.998	0.992
	McPAD [8]	0.993	0.019	0.177	0.300
ISCX IDS 2012	Soheily-Khah and et al. [34]	0.987	0.001	0.989	0.988

and the mean of metrics for different protocols (since PR was not reported, the value is calculated).

The other related work is [8], which is one of the best researches about detecting content-based attacks. We have evaluated this method by using its source code, which is available at [39]. Even though this code yields suitable results over the dataset used by themselves in [8], but it shows a weak performance in learning ISCX IDS 2017 dataset. This weakness is related to the comprehensiveness of the ISCX IDS dataset against previous ones like DARPA or KDD99. The results of the evaluation of McPAD by ISCX IDS 2017 are represented in Table III.

The main weakness of McPAD is its detection rate, represented by the recall, which is around 20%. Although McPAD has a significant detection rate over the dataset used in [8], it cannot be beneficial in real-world traffic. Further inspections show that while their normal traffic is suitable, but the attack ones which are used in the evaluation, has some notable weaknesses. For example, allShellcode.pcap file has only 11 TCP sessions, which in each one contains a shell-code attack. As the NOP sled in these attacks has many repetitions of bytes like 0x90 and 0x61, they can be easily detected. Besides, in the other attack file, which is called allGeneric.pcap, has 66 HTTP attacks. Among them, there are 11 shell-code attacks that can be detected as the previous one, and the others have hostnames that do not exist in the training dataset (like www and www.i-pi.com). Consequently, the n -gram mechanism can detect these kinds of attacks. However, in the case of the ISCX IDS 2017 dataset, although its alarm has significant reliability (PR = 99.3%), its detection rate is low (RC = 17.7%).

Finally, we would like to mention that the average delay of our proposed model per flow in the test phase is around 100 milliseconds. Since the input data in DID are flows, according to [40], on average, we can assume each flow contains 78 packets, and each packet contains 870 bytes. As a result, the proposed model with our test environment can handle around 5 Megabit per second, which can be a challenge in high-performance applications that should be addressed in future works.

D. Discussion

According to our experiments, the proposed deep intrusion detection (DID) approach can have a comparative advantage over previous works in inspecting more varieties of attacks, especially the ones that are placed in the payload of traffic. However, the proposed approach has some challenges which

should be addressed in future works. Some of these challenges are explained below.

The main current shortcoming of using deep learning in network detection is its throughput. With the increasing rate of internet bandwidth, we have to count on devices with appropriate throughput along with a high detection rate and low false alarm. Consequently, according to the complexity of deep learning algorithms, one of the main forward steps toward this goal is to optimize the deep intrusion detectors and implement them over high-performance devices like FPGAs or ASICs.

Another challenge to making ML-based IDSeS more applicable in practice is to adapt them to imbalanced data. The imbalance of data can make a machine learning model tend to the major category. However, detecting the minor category may be of high value for us (such as detecting cancer in medical applications or attack detection in computer networks). Alongside, if the test dataset is also imbalanced, the overall detection rate of the algorithm cannot provide an effective measure of the performance of the intrusion detection method in real scenarios. For example, for a dataset with 95% benign traffic, this can lead to a model that labels all the inputs as benign traffic to achieve 95% accuracy while the desired goal of the intrusion detection system is to detect attacks as much as possible with low false positive. In this paper, the data reduction mechanism for the majority group has been applied. However, this solution can cause some losses in the diversity of the major category (i.e., in this paper, the benign traffic). Consequently, some kinds of benign flows may be detected as attacks in a more comprehensive dataset, which has more complicated attacks.

Finally, in this research, we have used a labeled dataset for training the model. However, the lack of adequate diversity in this dataset can lead to poor performance in real networks. On the other hand, each network has its own behavior for normal traffics (like the number of new connections per second), which may be considered an abnormal behavior in other networks. Hence, it is very crucial that we learn the models according to their deployment environment.

V. CONCLUSION

In this paper, we presented a Deep Intrusion Detection approach that uses deep learning algorithms for detecting a wide range of attacks, including content-based ones like SQL injection and Heartbleed attack. We have used an LSTM-based model as an implementation of the deep learning module of the DID approach. LSTM layers can extract meaningful relations among bytes of packets of each flow. Besides using dropout layers, we tried to avoid overfitting. Four metrics that provide valuable information in intrusion detection applications have been selected for evaluation, namely, precision, recall, fall-out, and F_1 score. On the ISCX IDS 2017 dataset, we have achieved a precision of 0.992, fall-out of 0.2, recall of 0.998, and F_1 score of 0.992. The experimental results show that the proposed approach has better performance in comparison with the previous work.

ACKNOWLEDGMENT

The authors would like to thank Ramin Shirali and Jafar Gholamzadeh for their invaluable help, discussion, and feedback on this work.

REFERENCES

- [1] F. Jemili, M. Zaghdoud, and B. Ahmed, Mohamed, "A framework for an adaptive intrusion detection system using Bayesian network," *2007 IEEE Intelligence and Security Informatics*, pp. 66–70, 2007.
- [2] F. E. Heba, A. Darwish, E. Hassanien, Aboul, and A. Abraham, "Principle components analysis and support vector machine based intrusion detection system," *2010 10th International Conference on Intelligent Systems Design and Applications*, pp. 363–367, 2010.
- [3] J. Zhang, M. Zulkernine, and A. Haque, "Random-forests-based network intrusion detection systems," *IEEE Transactions on Systems, Man, and Cybernetics, Part C (Applications and Reviews)*, vol. 38, no. 5, pp. 649–659, 2008.
- [4] F. M. Agarap, Abien, "A neural network architecture combining gated recurrent unit (GRU) and support vector machine (SVM) for intrusion detection in network traffic data," *Proceedings of the 2018 10th International Conference on Machine Learning and Computing*, pp. 26–30, 2018.
- [5] A. Salama, Mostafa, F. Eid, Heba, A. Ramadan, Rabie, A. Darwish, and E. Hassanien, Aboul, "Hybrid intelligent intrusion detection scheme," in *Soft computing in Industrial Applications*. Springer, 2011, pp. 293–303.
- [6] K. Wang and J. Stolfo, Salvatore, "Anomalous payload-based network intrusion detection," *International Workshop on Recent Advances in Intrusion Detection*, pp. 203–222, 2004.
- [7] K. Wang, J. Parekh, Janak, and J. Stolfo, Salvatore, "Anagram: A content anomaly detector resistant to mimicry attack," *International Workshop on Recent Advances in Intrusion Detection*, pp. 226–248, 2006.
- [8] R. Perdisci, D. Ariu, P. Fogla, G. Giacinto, and W. Lee, "Mcpad- a multiple classifier system for accurate payload-based anomaly detection," *Computer Networks*, vol. 53, no. 6, pp. 864–881, 2009.
- [9] G. F. Cretu-Ciocarlie, A. Stavrou, M. E. Locasto, S. J. Stolfo, and A. D. Keromytis, "Casting out demons: Sanitizing training data for anomaly sensors," *IEEE Symposium on Security and Privacy*, pp. 81–95, 2008.
- [10] Y. Song, E. Locasto, Michael, A. Stavrou, A. Keromytis, and J. Stolfo, Salvatro, "On the infeasibility of modeling polymorphic shellcode," *Machine Learning*, vol. 81, no. 2, pp. 179–205, 2010.
- [11] Y. Bengio, A. Courville, and P. Vincent, "Representation learning: A review and new perspectives," *IEEE Transactions on Pattern Analysis and Machine Intelligence*, vol. 35, no. 8, pp. 1798–1828, Aug 2013.
- [12] Y. LeCun, Y. Bengio, and G. Hinton, "Deep learning," *nature*, vol. 521, no. 7553, pp. 436–444, 2015.
- [13] I. Sharafaldin, H. Lashkari, Arash, and A. Ghorbani, Ali, "Toward generating a new intrusion detection dataset and intrusion traffic characterization," in *ICISSP*, 2018, pp. 108–116.
- [14] R.-C. Chen, K.-F. Cheng, Y.-H. Chen, and C.-F. Hsieh, "Using rough set and support vector machine for network intrusion detection system," in *First Asian Conference on Intelligent Information and Database Systems*. IEEE, 2009, pp. 465–470.
- [15] N. Jia and D. Liu, "Application of svm based on information entropy in intrusion detection," in *International Conference on Intelligent and Interactive Systems and Applications*. Springer, 2017, pp. 464–468.
- [16] H. Wang, J. Gu, and S. Wang, "An effective intrusion detection framework based on svm with feature augmentation," *Knowledge-Based Systems*, vol. 136, pp. 130–139, 2017.
- [17] D. Heckerman, "A tutorial on learning with bayesian networks," in *Innovations in Bayesian networks*. Springer, 2008, pp. 33–82.
- [18] C. Kruegel, D. Mutz, W. Robertson, and F. Valeur, "Bayesian event classification for intrusion detection," *Proceedings of the 19th Annual Computer Security Applications*, p. 14, 2003.
- [19] C. Kruegel and T. Toth, "Using decision trees to improve signature based intrusion detection," *International Workshop on Recent Advances in Intrusion Detection*, pp. 173–191, 2003.
- [20] "Snort 2.9," <https://www.snort.org>, 2018, [Online; accessed 18-October-2018].
- [21] L. Breiman, "Random forests," *Machine Learning*, vol. 45, no. 1, pp. 5–32, 2001.
- [22] N. Farnaaz and M. Jabbar, "Random forest modeling for network intrusion detection system," *Procedia Computer Science*, vol. 89, pp. 213–217, 2016.
- [23] P. Lippmann, Richard and K. Cunningham, Robert, "Improving intrusion detection performance using keyword selection and neural networks," *Computer Networks*, vol. 34, no. 4, pp. 597–603, 2000.
- [24] A. Bivens, C. Palagiri, R. Smith, B. Szymanski, and M. Embrechts, "Network-based intrusion detection using neural networks," *Intelligent Engineering Systems through Artificial Neural Networks*, vol. 12, no. 1, pp. 579–584, 2002.
- [25] R. Lippmann, W. Haines, Joshua, J. Fried, David, J. Korba, and K. Das, "The 1999 darpa off-line intrusion detection evaluation," *Computer Networks*, vol. 34, no. 4, pp. 579–595, 2000.
- [26] Akashdeep, I. Manzoor, and N. Kumar, "A feature reduced intrusion detection system using ann classifier," *Expert Systems with Applications*, vol. 88, pp. 249–257, 2017.
- [27] "Kdd cup 1999," <http://kdd.ics.uci.edu/databases/kddcup99/kddcup99.html>, 2018, [Online; accessed 12-November-2018].
- [28] S. Hochreiter and J. Schmidhuber, "Long short-term memory," *Neural computation*, vol. 9, no. 8, pp. 1735–1780, 1997.
- [29] J. Kim, J. Kim, L. T. Thu, Huong, and H. Kim, "Long short term memory recurrent neural network classifier for intrusion detection," *2016 International Conference on Platform Technology and Service (PlatCon)*, pp. 1–5, 2016.
- [30] A. Tang, Tuan, L. Mhamdi, D. McLernon, A. R. Zaidi, Syed, and M. Ghogho, "Deep learning approach for network intrusion detection in software defined networking," *2016 International Conference on Wireless Networks and Mobile Communications (WINCOM)*, pp. 258–263, 2016.
- [31] E. Aminanto, Muhamad, R. Choi, C. Tanuwidjaja, Harry, D. Yoo, Paul, and K. Kwangjo, "Deep abstraction and weighted feature selection for wi-fi impersonation detection," *IEEE Transactions on Information Forensics and Security*, vol. 13, no. 3, pp. 621–636, 2018.
- [32] A. Javaid, Q. Niyaz, W. Sun, and A. Mansoor, "A deep learning approach for network intrusion detection system," *BICT'15 Proceedings of the 9th EAI International Conference on Bio-inspired Information and Communications Technologies (formerly BIONETICS)*, pp. 21–26, 2016.
- [33] K. Kim and E. Aminato, Muhaamad, "Deep learning in intrusion detection perspective: Overview and further challenges," *2017 International Workshop on Big Data and Information Security (IWBIS)*, pp. 5–10, 2017.
- [34] S. Soheily-Khah, P.-F. Marteau, and N. Béchet, "Intrusion detection in network systems through hybrid supervised and unsupervised mining process-a detailed case study on the ISCX benchmark dataset," in *2018 1st International Conference on Data Intelligence and Security (ICDIS)*. IEEE, 2018, pp. 219–226.
- [35] V. Mahoney, Matthew and K. Chan, Philip, "An analysis of the 1999 darpa/lincoln laboratory evaluation data for network anomaly detection," *International Workshop on Recent Advances in Intrusion Detection*, pp. 220–237, 2003.
- [36] G. Dorffner, "Neural networks for time series processing," *Neural Network World*, vol. 6, pp. 447–468, 1996.
- [37] F. Chollet, "keras," <https://github.com/fchollet/keras>, 2017.
- [38] M. Abadi, A. Agarwal, P. Barham, E. Brevdo, Z. Chen, C. Citro, G. S. Corrado, A. Davis, J. Dean, M. Devin, S. Ghemawat, I. Goodfellow, A. Harp, G. Irving, M. Isard, Y. Jia, R. Jozefowicz, L. Kaiser, M. Kudlur, J. Levenberg, D. Mané, R. Monga, S. Moore, D. Murray, C. Olah, M. Schuster, J. Shlens, B. Steiner, I. Sutskever, K. Talwar, P. Tucker, V. Vanhoucke, V. Vasudevan, F. Viégas, O. Vinyals, P. Warden, M. Wattenberg, M. Wicke, Y. Yu, and X. Zheng, "TensorFlow: Large-scale machine learning on heterogeneous systems," 2015, software available from tensorflow.org. [Online]. Available: <http://tensorflow.org/>
- [39] "Mcpad project," <http://roberto.perdisci.com/projects/mcpad>, 2009, [Online; accessed 12-November-2018].
- [40] P. Jurkiewicz, G. Rzym, and P. Borylo, "Flow length and size distributions in campus internet traffic," *CoRR*, vol. abs/1809.03486, 2018.