

HAMILTONIAN DECOMPOSITION AND VERIFYING VERTEX ADJACENCY IN 1-SKELETON OF THE TRAVELING SALESPERSON POLYTOPE BY VARIABLE NEIGHBORHOOD SEARCH

ANDREI NIKOLAEV AND ANNA KOZLOVA

ABSTRACT. We consider a Hamiltonian decomposition problem of partitioning a regular graph into edge-disjoint Hamiltonian cycles. A sufficient condition for vertex adjacency in the 1-skeleton of the traveling salesperson polytope can be formulated as the Hamiltonian decomposition problem in a 4-regular multigraph. We introduce a heuristic general variable neighborhood search algorithm for this problem based on finding a vertex-disjoint cycle cover of the multigraph through reduction to perfect matching and several cycle merging operations. The algorithm has a one-sided error: the answer “not adjacent” is always correct, and was tested on random directed and undirected Hamiltonian cycles and on pyramidal tours.

1. INTRODUCTION

A *Hamiltonian decomposition* of a regular graph is a partition of its edge set into Hamiltonian cycles. The problem of finding edge-disjoint Hamiltonian cycles in a given regular graph plays an important role in combinatorial optimization [23], coding theory [4, 5], privacy-preserving distributed mining algorithms [10], analysis of interconnection networks [19] and other areas. See also theoretical results on estimating the number of Hamiltonian decompositions of regular graphs [15]. Our motivation for this problem comes from the field of polyhedral combinatorics.

2. TRAVELING SALESPERSON POLYTOPE

We consider a classic traveling salesperson problem: given a complete weighted graph (or digraph) $K_n = (V, E)$, it is required to find a Hamiltonian cycle of minimum weight. We denote by HC_n the set of all Hamiltonian cycles in K_n . With each Hamiltonian cycle $x \in HC_n$ we associate a characteristic vector $x^v \in \mathbb{R}^E$ by the following rule:

$$x_e^v = \begin{cases} 1, & \text{if the cycle } x \text{ contains an edge } e \in E, \\ 0, & \text{otherwise.} \end{cases}$$

The polytope

$$\text{TSP}(n) = \text{conv}\{x^v \mid x \in HC_n\}$$

is called *the symmetric traveling salesperson polytope*.

The asymmetric traveling salesperson polytope $\text{ATSP}(n)$ is defined similarly as the convex hull of characteristic vectors of all possible Hamiltonian cycles in the complete digraph K_n .

Key words and phrases. Hamiltonian decomposition, traveling salesperson polytope, 1-skeleton, vertex adjacency, general variable neighborhood search, variable neighborhood descent, vertex-disjoint cycle cover, perfect matching.

The research is supported by the grant of the President of the Russian Federation MK-2620.2018.1 (agreement no. 075-015-2019-746).

The 1-*skeleton* of a polytope P is the graph whose vertex set is the vertex set of P and edge set is the set of geometric edges or one-dimensional faces of P . The study of 1-skeleton is of interest, since, on the one hand, there are algorithms for perfect matching, set covering, independent set, a ranking of objects, problems with fuzzy measures, and many others that are based on the vertex adjacency relation in 1-skeleton and the local search technique (see, for example, [1, 6, 11, 12, 14]). On the other hand, some characteristics of 1-skeleton, such as the diameter and clique number, estimate the time complexity for different computation models and classes of algorithms [7, 9, 16].

Unfortunately, the classic result by Papadimitriou states that the construction of 1-skeleton of the traveling salesperson polytope is hard for both directed and undirected graphs.

Theorem 1 (Papadimitriou [31]). *The question of whether two vertices of the polytopes TSP(n) or ATSP(n) are nonadjacent is NP-complete.*

As a result, there are a lot of papers on the diameter and clique number of 1-skeleton of TSP(n) and ATSP(n) [7, 34, 35], but little progress with adjacency relation. We can only note the polynomial-time algorithms to test vertex adjacencies in the pedigree polytope [2], the polytope of pyramidal tours [8] and the polytope of pyramidal tours with step-backs [29] which are directly related to the traveling salesperson problem.

3. HAMILTONIAN DECOMPOSITION AND THE 1-SKELETON

We apply the Hamiltonian decomposition problem to analyze the 1-skeleton of the traveling salesperson polytope. Let $x = (V, E_x)$ and $y = (V, E_y)$ be two Hamiltonian cycles on the vertex set V . We denote by $x \cup y$ a multigraph $(V, E_x \cup E_y)$ that contains all edges of both cycles x and y .

Lemma 1 (Sufficient condition for nonadjacency [33]). *Given two Hamiltonian cycles x and y , if the multigraph $x \cup y$ contains a Hamiltonian decomposition into edge-disjoint cycles z and w different from x and y , then the corresponding vertices x^v and y^v of the polytope TSP(n) (or ATSP(n)) are not adjacent.*

From a geometric point of view, the sufficient condition means that the segment connecting two vertices x^v and y^v intersects with the segment connecting two other vertices z^v and w^v of the polytope TSP(n) (or ATSP(n) correspondingly). Thus, the vertices x^v and y^v cannot be adjacent in 1-skeleton. An example of a satisfied sufficient condition is shown in Fig. 1.

Thus, the sufficient condition for vertex nonadjacency of the traveling salesperson polytope can be formulated as a combinatorial problem.

INSTANCE. Let x and y be two Hamiltonian cycles.

QUESTION. Does the multigraph $x \cup y$ contain a pair of edge-disjoint Hamiltonian cycles z and w different from x and y such that

$$z \cup w = x \cup y \text{ and } z \cap w = \emptyset?$$

Testing of whether a graph has a Hamiltonian decomposition is NP-complete, even for 4-regular undirected graphs and 2-regular directed graphs [32]. Thus, verifying the sufficient condition for vertex nonadjacency is hard. Polynomially solvable special cases of the Hamiltonian decomposition and vertex adjacency problems have been studied in the literature, in particular: pedigrees [2], pyramidal tours [8] and pyramidal tours with step-backs [29]. Based on them, we can consider polynomial sufficient conditions for nonadjacency in the traveling salesperson polytope, however, all of them will be weaker than the condition of Lemma 1 [3].

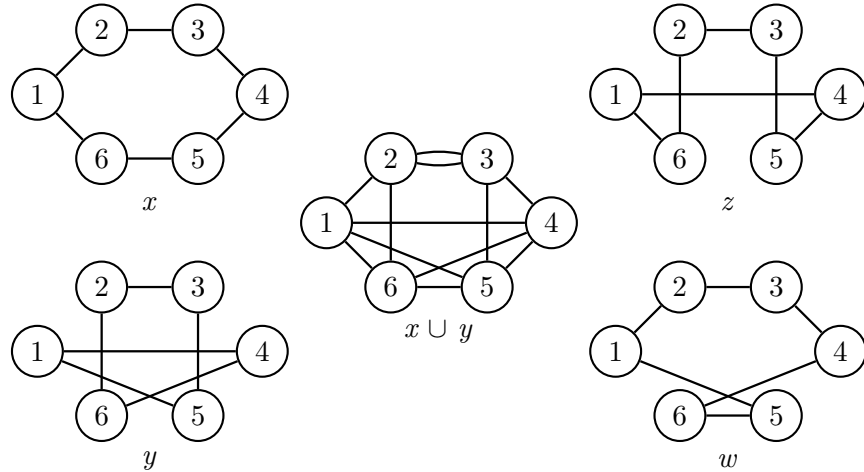

FIGURE 1. The multigraph $x \cup y$ has two different Hamiltonian decompositions

Note that any 4-regular multigraph always has an even number of Hamiltonian decompositions [36]. There is no contradiction with Lemma 1 and Theorem 1. If the Hamiltonian cycles x and y contain the same edge, then both copies of this edge are included in the multigraph $x \cup y$. The exchange of such edges can provide a Hamiltonian decomposition, however, the cycles z and w will not differ from x and y .

4. GENERAL VARIABLE NEIGHBORHOOD SEARCH

We introduce a heuristic general variable neighborhood search algorithm with 3 different neighborhood structures to find the Hamiltonian decomposition in the multigraph $x \cup y$. The variable neighborhood search metaheuristic was proposed by Mladenovi and Hansen in 1997 [28] and has since developed rapidly both in its methods and applications. See, for example, current surveys [17, 18] and some recent applications of general VNS [24, 27].

The GVNS algorithm is an improved version of the simulated annealing approach from [22] that has the same feasible set, the objective function, and the third neighborhood structure.

4.1. Feasible set. The set of feasible solutions consists of pairs z and w of vertex-disjoint cycle covers of the multigraph $x \cup y$. A *vertex-disjoint cycle cover* of a graph G is a set of cycles with no vertices in common which are subgraphs of G and contain all vertices of G . The idea is as follows. All vertices in the multigraph $x \cup y$ have degrees equal to 4 (or both indegrees and outdegrees equal to 2 for directed cycles). Let z be a vertex-disjoint cycle cover of $x \cup y$, then all the remaining edges form a graph $w = (x \cup y) \setminus z$ with all vertex degrees being equal to 2 (both indegrees and outdegrees equal to 1). Thus, w is also a vertex-disjoint cycle cover of $x \cup y$ (Fig. 2).

Finding a vertex-disjoint cycle cover of both directed and undirected graphs can be performed in polynomial time by a reduction to perfect matching [37]. Let us recall that a *perfect matching* is a set of pairwise nonadjacent edges that matches all vertices of the graph. The procedures for directed and undirected graphs are somewhat different. We consider them separately.

Let x and y be two undirected Hamiltonian cycles.

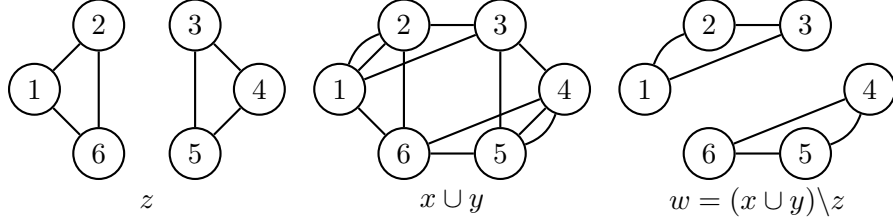
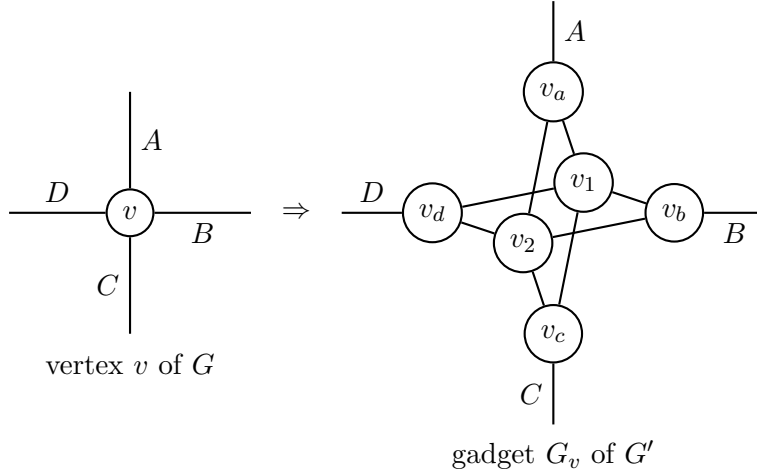
FIGURE 2. The multigraph $x \cup y$ and its two complementary cycle coversFIGURE 3. Construction of the graph G' for the undirected multigraph G

Step 1. From the multigraph $x \cup y = G = (V, E)$, we construct a new graph $G' = (V', E')$. With each vertex $v \in V$ we associate a gadget G_v that is a complete bipartite subgraph $K_{4,2}$ (note that the degree of v equals 4) as it is shown in Fig. 3:

- there are 4 vertices in the outer part (v_a, v_b, v_c and v_d) that correspond to 4 edges incident to v in G (edges A, B, C, D) and are connected with other gadgets;
- there are 2 vertices in the inner part (v_1 and v_2) that are only adjacent to the vertices inside the gadget.

Step 2. A perfect matching in G' corresponds to a vertex-disjoint cycle cover in the original graph G . Indeed, perfect matching has to cover both vertices in the inner part. Therefore, it includes exactly one edge adjacent to v_1 and one edge adjacent to v_2 . These two edges cover only two of the four vertices in the outer part $\{v_a, v_b, v_c, v_d\}$. Two other vertices have to be covered by the edges of G (Fig. 4). We include these edges into z , then the degree of each vertex v in the graph z equals 2, and therefore, z is a vertex-disjoint cycle cover of the multigraph $x \cup y$.

A perfect matching in a general undirected graph can be found by Micali-Vazirani algorithm in $O(\sqrt{VE})$ time [26].

Let x and y be two directed Hamiltonian tours.

Step 1. From the directed multigraph $x \cup y = D = (V, A)$, we construct a bipartite graph $D' = (L, R, E)$. With each vertex $v \in V$ we associate a pair of vertices $v_L \in L$

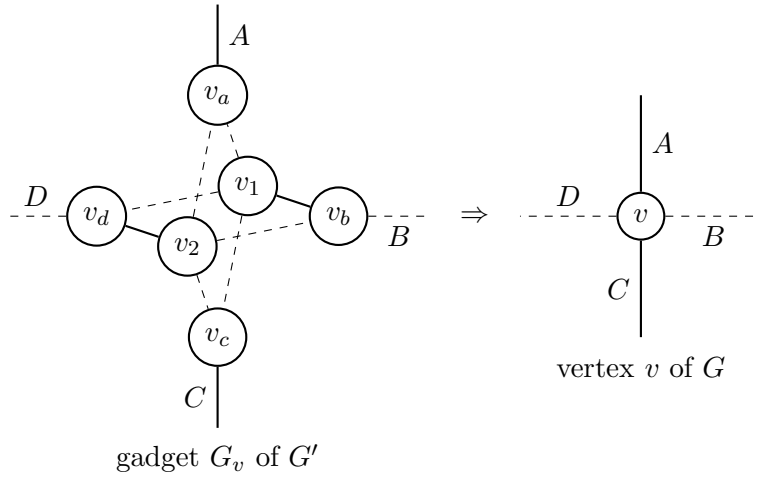

FIGURE 4. Perfect matching in G' (solid) and vertex-disjoint cycle cover in G

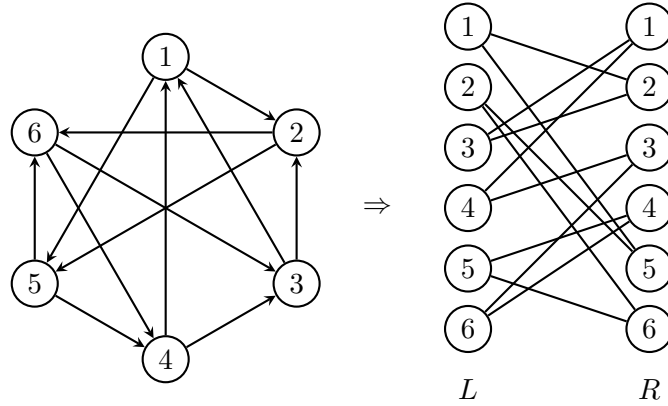

FIGURE 5. Directed multigraph D (left) and corresponding bipartite graph D' (right)

and $v_R \in R$, and with each edge $(u, v) \in A$ we associate a new edge (u_L, v_R) in the bipartite graph D' (Fig. 5).

Step 2. A perfect matching in the bipartite graph D' corresponds to a vertex-disjoint directed cycle cover in the original graph D . Indeed, every vertex of D is a head of exactly one edge and a tail of exactly one edge of a perfect matching in D' (Fig. 6).

A perfect matching in a bipartite graph can be found by HopcroftKarp algorithm in $O(\sqrt{VE})$ time [20].

4.2. Objective function. As the objective function, we chose the total number of connected components in the vertex-disjoint cycle covers z and w . If it equals 2, then z and w are Hamiltonian cycles.

4.3. First neighborhood structure. We consider the directed graphs. Without loss of generality, let here and further z be a vertex-disjoint cycle cover with at least 2 connected components.

FIGURE 6. Perfect matching in D' (left) and vertex-disjoint cycle cover of D (right)

FIGURE 7. Example of the first neighborhood structure

The idea is as follows. We choose an edge (a_1, a_2) of z and remove it (move to w). Since the directed multigraph $x \cup y$ is 2-regular, there are only 2 edges with their heads adjacent to the vertex a_2 : (a_1, a_2) and (b_1, a_2) . We add the edge (b_1, a_2) of w to z (Fig. 7, the removed edges are dotted). But now outdegree of b_1 in z equals 2. Again, there are only 2 edges with their tails adjacent to b_1 : (b_1, a_2) and (b_1, b_2) . We cannot backtrack and remove the just added edge (b_1, a_2) . Therefore, we remove the edge (b_1, b_2) , and so on. This is summarized in Algorithm 1.

Note that the whole procedure is deterministic. If after this operation z and w are the correct cycle covers and the number of connected components has decreased, then we proceed to a new solution. The total size of the neighborhood is $O(V)$, as we have to check every edge of the vertex-disjoint cycle cover z exactly once.

We call an edge *fixed* if it coincides in the original cycles x and y . Since two copies of one edge cannot get into one cycle, we fix them in z and w .

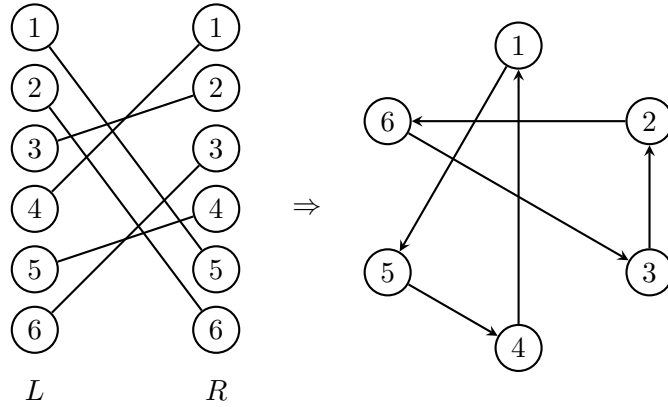
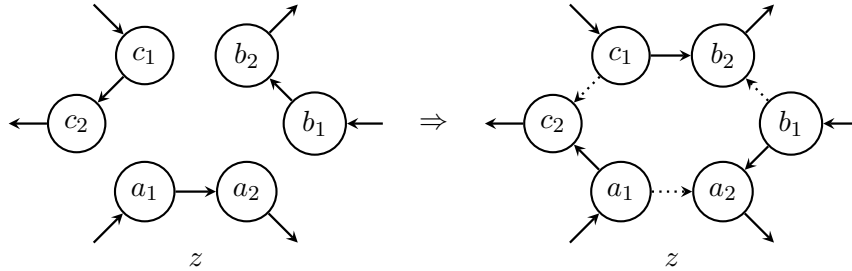
For the undirected graphs, the procedure is similar to Algorithm 1. Again in a cycle for each edge of z we move the edge to w and try to restore the cycle covers by exchanging edges. The key difference is that the procedure is no longer deterministic: at each step, we have a choice of several edges to add or remove (see the second neighborhood structure for more details). Thus, every time we make a random choice of which edge to add or remove and run k random walks. The time complexity of checking the first neighborhood for undirected graphs is $O(k \cdot V^2)$.

Algorithm 1 Local search with respect to the first neighborhood

```

1: procedure LOCALSEARCH_1( $z, w$ )
2:   while there are unchecked and unfixed edges in  $z$  (or  $w$ ) do
3:      $z' \leftarrow z, w' \leftarrow w$  ▷ Neighboring solution
4:     Choose an unchecked and unfixed edge  $(a_1, a_2)$  of  $z'$  ▷ In random order
5:      $z' \gg (a_1, a_2) \gg w'$  ▷ Move the edge  $(a_1, a_2)$  from  $z'$  to  $w'$ 
6:      $z' \ll (b_1, a_2) \ll w'$  ▷ Move the edge  $(b_1, a_2)$  from  $w'$  to  $z'$ 
7:      $a_1.outdegree \leftarrow a_1.outdegree - 1$ 
8:      $b_1.outdegree \leftarrow b_1.outdegree + 1$ 
9:     while there is some vertex  $b_1$  of  $z'$  with outdegree equals 2 do ▷ See Fig. 7
10:       $z' \gg (b_1, b_2) \gg w'$ 
11:       $b_1.outdegree \leftarrow b_1.outdegree - 1$ 
12:       $z' \ll (c_1, b_2) \ll w'$ 
13:       $c_1.outdegree \leftarrow c_1.outdegree + 1$ 
14:     end while
15:     if a better solution is found then
16:       return  $z'$  and  $w'$  ▷ First improvement w.r.t. the first neighborhood
17:     end if
18:     Mark all moved edges as checked ▷ Avoid double checking the same edges
19:   end while
20:   return  $z$  and  $w$  is a local minimum w.r.t. the first neighborhood
21: end procedure

```

4.4. Second neighborhood structure. Now we consider the undirected graphs. Let again z be the cycle cover with at least two connected components. We choose an edge of z and remove it (move to w). Then in z there are vertices with degrees other than 2.

Let u be some vertex of degree 1. We can restore the vertex degree of u in three different ways: by adding one of two incident edges from w , or by adding both incident edges from w at the same time and removing the existing edge of z (Fig. 8, the removed edges are dotted). Note that we cannot return the previously deleted edge (u, v_1) . We explore all three options using DFS with a bounded search tree. Again, if we manage to merge cycles, get the correct cycle covers, and reduce the number of connected components, then we proceed to a new solution. The procedure is summarized in Algorithm 2.

Other cases of vertex degree are treated similarly. If a vertex degree is equal to 3, we again have up to three ways to restore a vertex degree by removing one or two edges. In cases of degrees 0 and 4, there is only one way to restore a vertex degree by adding/removing two edges at the same time.

The time complexity of checking the second neighborhood is $O(3^d \cdot V)$ where $d = depthL$ is the recursion depth limit. The procedure for directed graphs is similar, but with no more than two options at each step.

Note that the first and second neighborhood structures explore the same search tree for merging cycles through the exchange of edges. However, the difference is as follows:

- the first neighborhood structure explores only some branches (branches of a special type for directed graphs and a limited number of random branches for undirected graphs);
- the second neighborhood structure explores the search tree completely, but only to a limited depth.

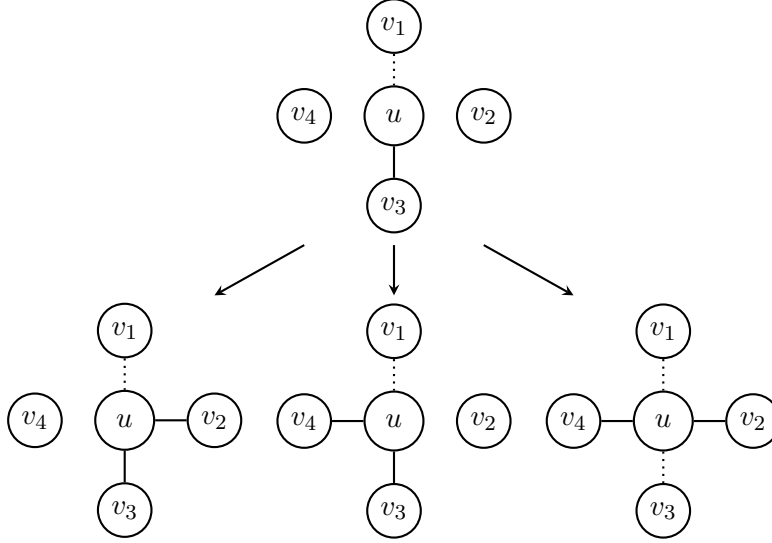

FIGURE 8. Second neighborhood structure, 3 ways to restore the vertex degree

4.5. Third neighborhood structure. In the third neighborhood structure, we choose a random edge of w with endpoints in two different connected components of z (or vice versa) and add it to the queue of fixed edges. Such an edge always exists due to the connectivity of the multigraph $x \cup y$. The neighboring solution is constructed as a new vertex-disjoint cycle cover by the perfect matching algorithms with fixed edges forming the initial matching. When the queue limit $fixEdgesN$ is exceeded, the first edge of the queue is deleted. The procedure is summarized in Algorithm 3.

For the third neighborhood structure, we chose the simulated annealing approach [21] for two reasons. Firstly, constructing a cycle cover through perfect matching is an expensive enough procedure to examine the entire neighborhood. Secondly, the simulated annealing allows the algorithm to get out of a local minimum.

4.6. Final algorithm. The final general variable neighborhood search algorithm is summarized in Algorithm 4. We have arranged the neighborhoods in order of increasing complexity:

- (1) the first neighborhood is quite small and simple ($O(V)$ for directed graphs and $O(k \cdot V^2)$ for undirected graphs);
- (2) the second neighborhood explores the entire search tree to a limited depth, therefore, it is larger and requires significant time ($O(2^d \cdot V)$ for directed graphs and $O(3^d \cdot V)$ for undirected graphs);
- (3) construction of each neighboring solution with respect to the third neighborhood requires a recalculation of vertex-disjoint cycle covers by calling perfect-matching algorithms, therefore, it is the most time-consuming of the three.

We combined the first two neighborhoods in the basic variable neighborhood descent approach [13]: with the first improvement w.r.t. the second neighborhood, we return to the first neighborhood. If the algorithm is stuck in a local minimum w.r.t. both first and second neighborhood structures, we apply the simulated annealing approach w.r.t. the third neighborhood to shake the solution and get new cycle covers.

Algorithm 2 Local search with respect to the second neighborhood

```

1: procedure LOCALSEARCH_2( $z, w, depthL$ )
2:   while there are unchecked and unfixed edges in  $z$  (or  $w$ ) do
3:     Choose an unchecked and unfixed edge  $(u, v_1)$  of  $z$  ▷ In random order
4:     BOUNDEDSEARCHTREE( $z \gg (u, v_1) \gg w, depth = 1, depthL$ ) ▷ Move the edge
      ( $u, v_1$ ) from  $z$  to  $w$  and explore the search tree on modified graphs
5:     if a better solution is found then
6:       return  $z$  and  $w$  ▷ First improvement w.r.t. the second neighborhood
7:     end if
8:     Mark the edge  $(u, v_1)$  as checked
9:   end while
10:  return  $z$  and  $w$  is a local minimum w.r.t. the second neighborhood
11: end procedure

12: procedure BOUNDEDSEARCHTREE( $z$  and  $w, depth, depthL$ )
13:  if  $z$  and  $w$  are correct cycle covers then
14:    if the number of connected components has decreased then
15:      Proceed to a new solution and exit recursion
16:    end if
17:    return ▷ Backtrack to the previous step
18:  end if
19:  if  $depth > depthL$  or other stop conditions are satisfied then
20:    return ▷ Backtrack to the previous step
21:  end if
22:  Choose a vertex  $u$  of  $z$  whose degree is not equal to 2
23:  if vertex degree of  $u$  is equal to 1 then ▷ See Fig. 8
24:    BOUNDEDSEARCHTREE( $z \ll (u, v_2) \ll w, depth + 1, depthL$ )
25:    BOUNDEDSEARCHTREE( $z \ll (u, v_4) \ll w, depth + 1, depthL$ )
26:    BOUNDEDSEARCHTREE( $z \ll (u, v_2), (u, v_4) \ll w$  and  $z \gg (u, v_3) \gg w, depth +$ 
       $1, depthL$ )
27:  end if
28:  Consider other cases of vertex degrees
29: end procedure

```

4.7. Stopping criteria. If the decomposition of the multigraph $x \cup y$ into edge-disjoint Hamiltonian cycles z and w is found, then the algorithm successfully stops and returns the solution. By the sufficient condition (Lemma 1), the corresponding vertices x^v and y^v of the traveling salesperson polytope are not adjacent. Otherwise, we stop when the limits are exceeded either for the number of shaking steps $iterN$ or for the running time $timeL$. The algorithm could not find the Hamiltonian decomposition, hence the corresponding vertices are “probably adjacent”. Thus, the algorithm has a one-sided error: the answer “not adjacent” is always correct, while the answer “probably adjacent” leaves the possibility that the vertices are not adjacent.

4.8. Vertex adjacency and preprocessing. The GVNS algorithm is designed primarily for the construction of the Hamiltonian decomposition of 4-regular multigraph $x \cup y$. The only time the algorithm directly accesses the cycles x and y is to verify that the Hamiltonian decomposition z and w is different from x and y (line 7, Algorithm 4). Thus, if we omit this

Algorithm 3 Simulated annealing with respect to the third neighborhood

```

1: procedure SIMULATEDANNEALING( $z, w, iter, T, fixEdgesN$ )
2:   Choose a random edge  $e$  of  $w$  with endpoints in two different connected components
   of  $z$  (or vice versa)
3:   UPDATEFIXEDEDGESQUEUE( $z, w, e, fixEdgesN$ )
4:    $z', w' \leftarrow$  GETNEWCYCLECOVERS( $z \cup w$ ) ▷ Third neighborhood structure
5:   if  $e^{-\frac{E(z', w') - E(z, w)}{T}} \geq \text{RAND}(0, 1)$  then ▷ SA probabilistic transition
6:      $z \leftarrow z', w \leftarrow w'$  ▷ Proceed to a new solution
7:   end if
8:    $T \leftarrow$  COOLINGSCHEDULE( $k$ )
9:   return  $z$  and  $w$ 
10: end procedure

```

Algorithm 4 General variable neighborhood search

```

1: procedure GVNS( $x \cup y, iterN, initT, fixEdgesN, depthL, timeL$ )
2:    $T \leftarrow initT$ 
3:    $z, w \leftarrow$  GETINITIALCYCLECOVERS( $x \cup y$ ) ▷ By perfect matching algorithms
4:    $iter \leftarrow 1$ 
5:   while  $iter \leq iterN$  and running time  $\leq timeL$  do
6:     repeat ▷ Variable neighborhood descent
7:       if  $z$  and  $w$  are Hamiltonian cycles (different from  $x$  and  $y$ ) then
8:         return Hamiltonian decomposition  $z$  and  $w$ 
9:       end if
10:      LOCALSEARCH_1( $z, w$ ) ▷ First improvement w.r.t. the first neighborhood
11:      if a better solution is found then
12:        continue ▷ Restart the local search w.r.t. the first neighborhood
13:      end if ▷ Local minimum w.r.t. the first neighborhood
14:      LOCALSEARCH_2( $z, w, depthL$ ) ▷ First improvement w.r.t. the second
neighborhood
15:      until  $z$  and  $w$  is a local minimum w.r.t. both neighborhood structures
16:      repeat ▷ Third neighborhood structure
17:        SIMULATEDANNEALING( $z, w, iter, T, fixEdgesN$ )
18:         $iter \leftarrow iter + 1$ 
19:      until a new solution is found
20:    end while
21:    return Hamiltonian decomposition into cycles  $z$  and  $w$  is not found
22: end procedure

```

check, then we obtain the algorithm for the Hamiltonian decomposition problem without any connection to the traveling salesperson polytope. This is one of the main features of the algorithm.

Otherwise, if we are interested exactly in vertex adjacency in 1-skeleton of the traveling salesperson polytope, then the preprocessing step can be added to the algorithm, at which we first consider sufficient conditions for nonadjacency that can be verified in polynomial time. For example, pyramidal tours [8], pyramidal tours with step-backs [29], pedigrees [2, 3], etc.

5. COMPUTATIONAL RESULTS

We chose four algorithms for comparison:

- (1) SA: simulated annealing with respect to the third neighborhood only (this is the previous version of the algorithm described in [22]);
- (2) GVNS: general variable neighborhood search algorithm presented in this paper (Algorithm 4).
- (3) VND-12: one iteration of basic variable neighborhood descent w.r.t. the first and second neighborhood structures (lines 6-15 of the Algorithm 4);
- (4) VND-21: the same basic variable neighborhood descent algorithm as VND-12, but the order of the first and second neighborhoods is inverted.

The considered algorithms were tested on random directed and undirected Hamiltonian cycles and on directed and undirected pyramidal tours. A Hamiltonian tour is called a *pyramidal* if the salesperson starts in city 1, then visits some cities in ascending order, reaches city n , and returns to city 1 visiting the remaining cities in descending order. We chose the pyramidal tours since for them the Hamiltonian decomposition problem of whether for two given pyramidal tours x and y the union multigraph $x \cup y$ contains a pair of edge-disjoint pyramidal tours z and w can be solved in linear time [8]. We used this fact as a sufficient condition for nonadjacency and generated random pairs of pyramidal tours for which a solution to the Hamiltonian decomposition problem is guaranteed to exist.

We used the following parameters:

- for all algorithms: the time limit $timeL = 500$ seconds;
- for SA: the number of iterations $iterN = 5\,000$, the initial temperature $initT = 1\,000$, and the size of the queue of fixed edges $fixEdgesN = \lfloor \frac{n}{3} \rfloor$;
- for GVNS: the number of iterations $iterN = 1\,000$, the recursion depth for the second neighborhood $depthL = 10$; the initial temperature $initT = 1\,000$, and the size of the queue of fixed edges $fixEdgesN = \lfloor \frac{n}{3} \rfloor$;
- for VND-12 and VND-21: the recursion depth for the second neighborhood $depthL = 10$.

The algorithms are implemented in Node.js. All experiments are performed on a machine with an Intel(R) Core(TM) i5-4690 with CPU 3.50GHz and 16GB RAM.

The results of the tests are presented in Tables 1–4. For each graph size, from $N = 96$ to $N = 6\,144$, we generated 100 random tests. Since the Hamiltonian decomposition is a decision problem, we measured only three characteristics: the average runtime in seconds for solved and unsolved instances, and the percentage of successfully solved problems out of 100.

Based on the test results, it can be seen that for random undirected Hamiltonian cycles (Table 1) all algorithms proved to be quite successful. Although, the GVNS on average turned out to be 150 times faster than SA, which allowed GVNS to solve all instances, while SA on graphs with more than 2000 vertices ran into a time limit and failed. Note that a single iteration of VND was enough to solve all instances, with VND-12 working on average 25 times faster than VND-21. We can conclude that the union of two random undirected Hamiltonian cycles almost always contains several different Hamiltonian decompositions and any of the algorithms finds at least one of them. From a geometric point of view, two random vertices of the symmetric traveling salesperson polytope $TSP(n)$ are not adjacent with a very high probability.

The situation is completely different for random directed Hamiltonian cycles (Table 2), where the SA and GVNS found a solution in about 10-25% of cases. We investigated the

TABLE 1. Computational results for 100 random undirected Hamiltonian cycles

N	SA			GVNS		
	Not solved (s)	Solved (s)	Not adj.	Not solved (s)	Solved (s)	Not adj.
256	–	2.399	100%	–	0.039	100%
384	–	7.736	100%	–	0.077	100%
512	–	13.225	100%	–	0.139	100%
768	–	47.686	100%	–	0.285	100%
1024	–	114.389	100%	–	0.564	100%
1536	–	378.941	100%	–	1.162	100%
2048	500.000	176.635	44%	–	1.901	100%
3072	500.000	223.015	25%	–	3.896	100%
4096	500.000	230.985	14%	–	8.265	100%
6144	500.000	–	0%	–	17.798	100%
	VND-12			VND-21		
N	Not solved (s)	Solved (s)	Not adj.	Not solved (s)	Solved (s)	Not adj.
256	–	0.034	100%	–	1.919	100%
384	–	0.073	100%	–	3.826	100%
512	–	0.124	100%	–	4.877	100%
768	–	0.254	100%	–	8.520	100%
1024	–	0.459	100%	–	12.219	100%
1536	–	1.151	100%	–	19.884	100%
2048	–	2.055	100%	–	26.581	100%
3072	–	5.354	100%	–	52.542	100%
4096	–	8.660	100%	–	77.732	100%
6144	–	18.510	100%	–	145.018	100%

TABLE 2. Computational results for 100 random directed Hamiltonian cycles

N	SA			GVNS		
	Not solved (s)	Solved (s)	Not adj.	Not solved (s)	Solved (s)	Not adj.
96	5.813	0.125	17%	9.572	0.022	19%
128	9.143	0.576	17%	15.875	0.130	18%
192	16.147	0.654	21%	30.196	0.187	21%
256	26.009	1.941	20%	64.056	1.108	25%
384	52.432	6.601	17%	121.141	0.933	20%
512	95.017	19.685	19%	191.424	1.706	22%
768	206.871	55.055	17%	395.074	1.263	19%
1024	357.549	97.451	14%	463.027	2.153	17%
1536	499.232	258.778	9%	500.000	4.972	16%
2048	500.000	30.552	6%	500.000	26.161	26%
	VND-12			VND-21		
N	Not solved (s)	Solved (s)	Not adj.	Not solved (s)	Solved (s)	Not adj.
96	0.098	0.015	7%	0.525	0.472	4%
128	0.217	0.003	7%	1.039	1.187	9%
192	0.293	0.006	10%	1.835	1.257	11%
256	0.843	0.150	11%	3.172	2.494	9%
384	1.294	0.152	7%	5.079	5.131	10%
512	1.669	0.151	9%	7.804	3.866	7%
768	3.079	0.059	4%	12.063	10.049	8%
1024	4.888	0.358	6%	16.324	15.265	3%
1536	7.772	0.177	5%	31.842	33.392	5%
2048	9.602	0.260	6%	57.515	48.423	4%

TABLE 3. Computational results for 100 undirected pyramidal tours

N	SA			GVNS		
	Not solved (s)	Solved (s)	Not adj.	Not solved (s)	Solved (s)	Not adj.
256	29.291	7.362	7%	–	0.062	100%
384	60.223	18.904	2%	–	0.165	100%
512	106.710	–	0%	–	0.252	100%
768	235.904	–	0%	–	0.623	100%
1024	376.132	–	0%	–	1.129	100%
1536	500.000	–	0%	–	2.319	100%
2048	500.000	–	0%	–	4.322	100%
3072	500.000	–	0%	–	12.933	100%
4096	500.000	–	0%	–	30.939	100%
6144	500.000	–	0%	–	52.279	100%
	VND-12			VND-21		
N	Not solved (s)	Solved (s)	Not adj.	Not solved (s)	Solved (s)	Not adj.
256	0.155	0.074	97%	0.291	0.544	96%
384	–	0.155	100%	1.531	0.882	99%
512	0.473	0.253	97%	2.943	1.731	96%
768	2.212	0.609	96%	5.529	3.732	98%
1024	–	1.059	100%	6.040	7.468	96%
1536	8.723	3.004	98%	15.815	16.650	95%
2048	–	5.730	100%	46.727	34.806	97%
3072	–	13.488	100%	94.374	87.131	92%
4096	73.669	25.677	99%	280.352	201.532	94%
6144	–	60.268	100%	500.000	285.637	32%

TABLE 4. Computational results for 100 directed pyramidal tours

N	SA			GVNS		
	Not solved (s)	Solved (s)	Not adj.	Not solved (s)	Solved (s)	Not adj.
192	12.066	2.462	72%	–	0.034	100%
256	18.492	3.324	45%	–	0.078	100%
384	35.991	4.426	24%	–	0.224	100%
512	59.528	7.112	15%	–	0.582	100%
768	120.154	13.237	8%	–	1.820	100%
1024	202.288	–	0%	–	3.001	100%
1536	269.308	–	0%	500.000	11.000	96%
2048	374.129	–	0%	500.000	22.805	95%
3072	500.000	–	0%	500.000	32.614	83%
4096	500.000	–	0%	500.000	72.210	70%
	VND-12			VND-21		
N	Not solved (s)	Solved (s)	Not adj.	Not solved (s)	Solved (s)	Not adj.
192	0.020	0.009	73%	0.065	0.105	66%
256	0.043	0.017	74%	0.126	0.170	67%
384	0.106	0.028	66%	0.385	0.421	53%
512	0.152	0.064	56%	0.645	0.870	61%
768	0.322	0.132	61%	1.827	1.914	44%
1024	0.580	0.255	46%	3.428	3.311	36%
1536	1.209	0.470	38%	9.865	9.433	30%
2048	2.058	0.957	36%	22.995	20.554	27%
3072	5.483	3.087	17%	66.456	53.724	14%
4096	10.399	3.984	16%	193.328	143.103	12%

behavior of algorithms on small graphs (up to 50 vertices), where the problem can be solved by backtracking, and the SA and GVNS showed accurate results there. From a geometric perspective, it is known that the 1-skeleton of the asymmetric traveling salesperson polytope is generally much denser than the 1-skeleton of the symmetric polytope. For example, the diameter of the 1-skeleton of ATSP(n) is 2 [30], while the best known upper bound for the diameter of the 1-skeleton of TSP(n) is 4 [34].

Summary for random directed Hamiltonian cycles: VND-21 solved 70 instances, VND-12 solved 72 instances, SA solved 157 instances and GVNS solved 203 instances out of 1 000. It can be seen that for directed graphs VND w.r.t. the first and second neighborhood structures is not as effective as for undirected graphs. Between two versions of variable neighborhood descent, the VND-12 was on average 5 times faster. We compared the SA and GVNS by their success rate. Note that it is hidden in the Table 2 that their results are nested: all instances solved by SA were also solved by GVNS. Since we are considering the decision problem with yes/no answers, we applied the McNemar test to evaluate the statistical significance of the results [25]. The GVNS algorithm against SA had χ^2 with Yates correction of 1.0 equal to 44.022 with the corresponding p -value being less than 1×10^{-6} . Thus, the GVNS algorithm showed statistically significantly better results for random directed Hamiltonian cycles.

However, in the general case, since we tested the algorithms on random cycles, we do not know if the algorithm could not find a solution because it failed or because there is no solution. Therefore, we considered the synthetic tests on pyramidal tours, for which the sufficient condition for nonadjacency is satisfied and the solution is guaranteed to exist.

Test results on pyramidal tours (Tables 3-4) allow even better comparison between the GVNS and the previous SA version of the algorithm. The SA performed poorly and solved only 9 instances for undirected graphs and 164 instances for directed graphs out of 1 000, while the GVNS solved all 1 000 instances for undirected graphs and 944 instances for directed graphs. Besides, the GVNS was much faster. Again, it can be seen that the variable neighborhood descent is very successful for undirected graphs where just one iteration solved almost all instances (987 for VND-12 and 895 for VND-21), and slightly less effective for directed graphs (483 instances for VND-12 and 410 for VND-21 out of 1 000). Between two versions of VND, their success rate was relatively close with VND-12 being on average 6 times faster for undirected graphs and 10 times faster for directed graphs.

Summing up the tests, the general variable neighborhood search showed significant improvement both in success rate and running time over the simulated annealing approach from [22]. For undirected graphs, often just one iteration of the variable neighborhood descent w.r.t. the first and second neighborhood structures was enough. The only weak point of GVNS was on directed pyramidal tours of large size, where the algorithm failed to solve several instances with a solution known to exist. However, each time the algorithm ran into a time limit. With broader time constraints, the results could be better. Also note that the alternative order of the neighborhoods, different from the increasing complexity, only slowed down the algorithm and did not lead to better results.

6. CONCLUSION

We introduce the general variable neighborhood search algorithm with 3 different neighborhood structures to find a Hamiltonian decomposition of the 4-regular multigraph. The algorithm showed good computational results on both directed and undirected graphs.

The Hamiltonian decomposition problem arises in the analysis of the 1-skeleton of the traveling salesperson polytope. Thus, the GVNS algorithm can be applied to verify vertex

adjacency in the 1-skeleton of both $TSP(n)$ and $ATSP(n)$ polytopes based on the sufficient condition of Lemma 1. Here the algorithm has a one-sided error: the answer “not adjacent” is always correct, while the answer “probably adjacent” leaves the possibility that the vertices actually are not adjacent.

With some modifications, the algorithm can be applied to the Hamiltonian decomposition problem in $2k$ -regular graphs.

Acknowledgements. We are very grateful to the anonymous reviewers for their comments and suggestions which helped to improve the presentation of the results in this paper.

REFERENCES

- [1] Aguilera NE, Katz RD, Tolomei PB (2017) Vertex adjacencies in the set covering polyhedron. *Discrete Appl. Math.* 218: 40–56. doi:10.1016/j.dam.2016.10.024.
- [2] Arthanari TS (2006) On pedigree polytopes and Hamiltonian cycles. *Discrete Math.* 306: 1474–1492. doi:10.1016/j.disc.2005.11.030.
- [3] Arthanari TS (2013) Study of the pedigree polytope and a sufficiency condition for nonadjacency in the tour polytope. *Discrete Optim. bf* 10: 224–232. doi:10.1016/j.disopt.2013.07.001.
- [4] Bae MM, Bose B (2003) Edge disjoint Hamiltonian cycles in k -ary n -cubes and hypercubes. *IEEE T. Comput.* 52: 1271–1284. doi:10.1109/TC.2003.1234525
- [5] Bailey RF (2009) Error-correcting codes from permutation groups. *Discrete Math.* 309: 4253–4265. doi:10.1016/j.disc.2008.12.027
- [6] Balinski ML (1985) Signature methods for the assignment problem. *Oper. Res.* 33: 527–536. doi:10.1287/opre.33.3.527.
- [7] Bondarenko VA (1983) Nonpolynomial lower bounds for the complexity of the traveling salesman problem in a class of algorithms. *Autom. Rem. Contr.* 44: 1137–1142.
- [8] Bondarenko VA, Nikolaev AV (2018) On the skeleton of the polytope of pyramidal tours. *J. Appl. Ind. Math.* 12: 9–18. doi:10.1134/S1990478918010027.
- [9] Bondarenko VA, Nikolaev AV (2013) Combinatorial and geometric properties of the Max-Cut and Min-Cut problems. *Dokl. Math.* 88: 516–517. doi:10.1134/S1064562413050062.
- [10] Clifton C, Kantarcioglu M, Vaidya J, Lin X, Zhu MY (2002) Tools for privacy preserving distributed data mining. *SIGKDD Explor. Newsl.* 4: 28–34. doi:10.1145/772862.772867
- [11] Chegiredy CR, Hamacher HW (1987) Algorithms for finding k -best perfect matchings. *Discrete Appl. Math.* 18: 155–165. doi:10.1016/0166-218X(87)90017-5.
- [12] Combarro EF, Miranda P (2010) Adjacency on the order polytope with applications to the theory of fuzzy measures. *Fuzzy Set. Syst.* 161: 619–641. doi:10.1016/j.fss.2009.05.004.
- [13] Duarte A, Snchez-Oro J, Mladenovi N, Todosijevi R (2018) Variable neighborhood descent. In: Mart R., Pardalos P., Resende M. (eds) *Handbook of Heuristics*, 341–367, Springer, Cham. doi:10.1007/978-3-319-07124-4_9.
- [14] Gabow HN (1977) Two algorithms for generating weighted spanning trees in order. *SIAM J. Comput.* 6: 139–150. doi:10.1137/0206011.
- [15] Glebov R, Luria Z, Sudakov B (2017) The number of Hamiltonian decompositions of regular graphs. *Isr. J. Math.* 222: 91–108. doi:10.1007/s11856-017-1583-y
- [16] Grötschel M, Padberg M (1985) Polyhedral theory. In: *The Traveling Salesman Problem: A Guided Tour of Combinatorial Optimization*, E. Lawler, J. K. Lenstra, A. Rinnooy Kan, and D. Shmoys, eds., 251–305, John Wiley, Chichester.
- [17] Hansen P, Mladenovi N (2018) Variable neighborhood search. In: Mart R., Pardalos P., Resende M. (eds) *Handbook of Heuristics*, 759–787, Springer, Cham. doi:10.1007/978-3-319-07124-4_19
- [18] Hansen P, Mladenovi N, Todosijevi R, Hanafi S (2017) Variable neighborhood search: basics and variants. *EURO J. Comput. Optim.* 5: 423–454. doi:10.1007/s13675-016-0075-x
- [19] Hung R-W (2011) Embedding two edge-disjoint Hamiltonian cycles into locally twisted cubes, *Theor. Comput. Sci.* 412: 4747–4753. doi:10.1016/j.tcs.2011.05.004
- [20] Hopcroft JE, Karp RM (1973) An $n^{5/2}$ algorithm for maximum matchings in bipartite graphs. *SIAM J. Comp.* 2: 225–231. doi:10.1137/0202019.
- [21] Kirkpatrick S, Gelatt CD, Vecchi MP (1983) Optimization by simulated annealing. *Science.* 220: 671–680. doi:10.1126/science.220.4598.671.

- [22] Kozlova A, Nikolaev A (2019) Simulated annealing approach to verify vertex adjacencies in the traveling salesperson polytope. In: Khachay M., Kochetov Y., Pardalos P. (eds) *Mathematical Optimization Theory and Operations Research. MOTOR 2019. LNCS*, 11548: 374–389. doi:10.1007/978-3-030-22629-9_26
- [23] Krarup J (1995) The peripatetic salesman and some related unsolved problems. In: Roy B. (eds) *Combinatorial Programming: Methods and Applications. NATO Advanced Study Institutes Series (Series C Mathematical and Physical Sciences)*, 19: 173–178. doi:10.1007/978-94-011-7557-9_8
- [24] Lawrance Amaldass NI, Lucas C, Mladenovic N (2019) Variable neighbourhood search for financial derivative problem. *Yugoslav J. Oper. Res.* 29: 359–373. doi:10.2298/YJOR180515016L
- [25] McNemar Q (1947) Note on the sampling error of the difference between correlated proportions or percentages. *Psychometrika*, 12: 153–157. doi:10.1007/BF02295996
- [26] Micali S, Vazirani VV (1980) An $O(\sqrt{|V|} \cdot |E|)$ algorithm for finding maximum matching in general graphs. In: *Proc. 21st IEEE Symp. Foundations of Computer Science*, 17–27. doi:10.1109/SFCS.1980.12
- [27] Mladenovi M, Delot T, Laporte G, Wilbaut C (2020) The parking allocation problem for connected vehicles. *J. Heuristics*, 26: 377–399. doi:10.1007/s10732-017-9364-7
- [28] Mladenovi N, Hansen P (1997) Variable neighborhood search. *Comput. Oper. Res.* 24: 1097–1100. doi:10.1016/S0305-0548(97)00031-2
- [29] Nikolaev A (2019) On vertex adjacencies in the polytope of pyramidal tours with step-backs. In: Khachay M., Kochetov Y., Pardalos P. (eds) *Mathematical Optimization Theory and Operations Research. MOTOR 2019. LNCS*, 11548: 247–263. doi:10.1007/978-3-030-22629-9_18
- [30] Padberg MW, Rao MR (1974) The travelling salesman problem and a class of polyhedra of diameter two. *Math. Program.*, 7: 32–45. doi:10.1007/BF01585502.
- [31] Papadimitriou CH (1978) The adjacency relation on the traveling salesman polytope is NP-Complete. *Math. Program.* 14: 312–324. doi:10.1007/BF01588973.
- [32] Péroche B (1984) NP-completeness of some problems of partitioning and covering in graphs. *Discrete Appl. Math.* 8: 195–208. doi:10.1016/0166-218X(84)90101-X
- [33] Rao MR (1976) Adjacency of the traveling salesman tours and 0-1 vertices. *SIAM J. Appl. Math.* 30: 191–198. doi:10.1137/0130021.
- [34] Rispoli FJ, Cosares S (1998) A bound of 4 for the diameter of the symmetric traveling salesman polytope. *SIAM J. Discrete Math.*, 11: 373–380. doi:10.1137/S0895480196312462.
- [35] Sierksma G (1993) The skeleton of the symmetric traveling salesman polytope. *Discrete Appl. Math.* 43: 63–74. doi:10.1016/0166-218X(93)90169-O.
- [36] Thomason AG (1978) Hamiltonian cycles and uniquely edge colourable graphs *Annals Discrete Math.*, 3: 259–268. doi:10.1016/S0167-5060(08)70511-9.
- [37] Tutte WT (1954) A short proof of the factor theorem for finite graphs. *Can. J. Math.*, 6: 347–352. doi:10.4153/CJM-1954-033-3.

P. G. DEMIDOV YAROSLAVL STATE UNIVERSITY, YAROSLAVL, RUSSIA
E-mail address: andrei.v.nikolaev@gmail.com, fyz95@mail.ru