



Efficient Recognition of Graph Languages

Project Report

GRAHAM CAMPBELL¹  and DETLEF PLUMP 
DEPARTMENT OF COMPUTER SCIENCE
UNIVERSITY OF YORK, UNITED KINGDOM

September 2019

¹Supported by a Vacation Internship from the Engineering and Physical Sciences Research Council (EPSRC) in the UK.

Abstract

Graph transformation is the rule-based modification of graphs, and is a discipline dating back to the 1970s. In general, to match the left-hand graph of a fixed rule within a host graph requires polynomial time, but to improve matching performance, Dörr proposed to equip rules and host graphs with distinguished root nodes. This model was implemented by Plump and Bak, but unfortunately, such rules are not invertible. We address this problem by defining rootedness using a partial function into a two-point set rather than pointing graphs with root nodes, meaning derivations are natural double pushouts. Moreover, we give a sufficient condition on rules to give constant time rule application on graphs of bounded degree, and that, the graph class of trees can be recognised in linear time, given an input graph of bounded degree. Finally, we define a new notion of confluence up to garbage and non-garbage critical pairs, showing it is sufficient to require strong joinability of only the non-garbage critical pairs to establish confluence up to garbage. Finally, this new result, presented for conventional graph transformation systems, can be lifted to our rooted setting by encoding node labels and rootedness as looped edges.

Contents

List of Figures	ix
List of Theorems	xi
Executive Summary	xiii
Preface	xvii
1 Theoretical Background	1
1.1 Graphs and Morphisms	1
1.2 Graph Transformation	2
1.3 Adding Relabelling	3
1.4 Rooted Graph Transformation	4
1.5 Graph Languages	5
1.6 Abstract Reduction Systems	6
1.7 Graph Programming Languages	7
2 A New Theory of Rooted Graph Transformation	9
2.1 Graphs and Morphisms	10
2.2 Rules and Derivations	12
2.3 Foundational Theorems	13
2.4 Equivalence of Rules	16
2.5 Graph Transformation Systems	17
2.6 Equivalence of GT Systems	19

3	Fast Language Recognition	21
3.1	Complexity Theorems	21
3.2	Recognising Trees in Linear Time	24
3.3	Recognising Full Binary Trees	28
3.4	Recognising Trees in GP 2	29
4	Confluence Analysis I	31
4.1	Definitions and Closedness	31
4.2	Non-Garbage Critical Pairs	34
4.3	Extended Flow Diagrams	37
5	Confluence Analysis II	39
5.1	Encoding PLRGs	39
5.2	Local Church-Rosser and Independence	42
5.3	Confluence up to Garbage	42
5.4	Tree Recognition Revisited	44
6	Conclusion	47
6.1	Evaluation	48
6.2	Future Work	48
A	Basic Mathematical Notions	51
A.1	Sets I	51
A.2	Functions	52
A.3	Binary Relations	53
A.4	Orders	53
A.5	Sets II	54
B	Category Theory	55
B.1	Foundations	55
B.2	Pushouts and Pullbacks	56

<i>CONTENTS</i>	vii
C Abstract Reduction Systems	57
C.1 Foundations	57
C.2 Termination	58
C.3 Confluence	59
D Graph Transformation	61
D.1 Partially Labelled Graphs	61
D.2 Typed Graphs	62
D.3 Pushouts and Pullbacks	63
D.4 Rules and Derivations	63
D.5 Transformation Systems	64
D.6 Confluence and Termination	65
D.7 Critical Pair Analysis	65
D.8 Rooted Graph Transformation	67
D.9 Edge Replacement Grammars	68
E Graph Theory	69
E.1 Basic Definitions	69
E.2 Classes of Graphs	70
Bibliography	73

List of Figures

1.1	Example Concrete Graph	2
1.2	Graph Morphism Commuting Diagrams	2
1.3	Example Concrete Graphs	2
1.4	Relabelling Non-Example	3
1.5	Complexity Assumptions Table	5
1.6	Example Rooted Rule	5
2.1	Example Rooted Derivation	9
2.2	Example Graph	10
2.3	Graph Morphism Commuting Diagrams	11
2.4	Commuting Squares	13
2.5	Example (Non-)Isomorphic Rules	16
2.6	Derivations Diagram	17
2.7	Example Rules Demonstrating Non-Equivalence	20
3.1	Complexity Assumptions Table	22
3.2	Tree Grammar Rules	24
3.3	Tree Recognition Rules	25
3.4	Example Reductions	25
3.5	Full Binary Tree Rules	28
3.6	GP 2 Implementation	29
3.7	Graph Classes	30
3.8	Measured Performance	30

4.1	Example Reduction Rules	32
4.2	Example Non-Closed Rules	34
4.3	Example Non-Joinable Pair	34
4.4	Pair Factorisation Diagram	36
4.5	EFD Grammar Rules	37
4.6	Non-Joinable Critical Pair	38
5.1	Example Encoded PLRG	40
5.2	Non-Strongly Joinable Critical Pair	45
B.1	Pushout and Pullback	56
C.1	Confluence Properties	59
D.1	Partially Labelled Graph Diagram	61
D.2	Direct Derivation	63
D.3	Sequential Independence Diagram	65
D.4	Parallel Independence Diagram	66
D.5	Edge Replacement Rule	68

List of Theorems

1.1	Theorem (Property Undecidability)	7
2.1	Theorem (Derivation Theorem)	15
2.2	Theorem (Compatible Derivations)	16
2.3	Theorem (Membership Test)	18
2.4	Theorem (GT System Equivalence)	19
3.1	Theorem (Fast Derivations)	23
3.2	Theorem (Tree Recognition)	27
3.3	Theorem (FBT Recognition)	29
4.1	Theorem (Undecidable Closedness)	33
4.2	Theorem (Newman-Garbage Lemma)	33
4.3	Theorem (Non-Garbage Critical Pair Lemma)	36
4.4	Theorem (Efficient Recognition Correctness)	37
4.5	Theorem (Efficient EFD Recognition)	38
5.1	Theorem (Compatible Derivations)	41
5.2	Theorem (Sequential Independence)	42
5.3	Theorem (Parallel Independence)	42
5.4	Theorem (Compatible Strong Joinability)	43
5.5	Theorem (Non-Garbage Critical Pair Lemma)	44
A.1	Theorem (Well-Ordered Sets)	54
A.2	Theorem (Countable Sets)	54

B.1	Theorem (Limit Uniqueness)	56
C.1	Theorem (Noetherian Induction)	58
C.2	Theorem (Church-Rosser)	59
C.3	Theorem (Newman's Lemma)	59
D.1	Theorem (Typed-Labelled Graph Correspondence)	62
D.2	Theorem (Limit Existence)	63
D.3	Theorem (Derivation Theorem)	64
D.4	Theorem (Property Undecidability)	65
D.5	Theorem (Sequential Independence)	65
D.6	Theorem (Parallel Independence)	66
D.7	Theorem (Critical Pair Lemma)	66
D.8	Theorem (Rooted Derivation Uniqueness)	67
D.9	Theorem (Decidable Membership Problem)	68
E.1	Theorem (Graph Decomposition)	70

Executive Summary

Motivation and Goals

Graph transformation is the rule-based modification of graphs, and is a discipline dating back to the 1970s, with the ‘algebraic approach’ invented at the Technical University of Berlin by Ehrig, Pfender, and Schneider [1], [2]. It is a comprehensive framework in which the local transformation of structures can be modelled and studied in a uniform manner [3]–[5]. Applications in Computer Science are wide-reaching including compiler construction, software engineering and concurrent systems [6]–[9].

The declarative nature of graph rewriting rules comes at a cost: In general, to match the left-hand graph L of a rule within a host graph G requires $|G|^{|L|}$ time. To improve matching performance, Dörr [10] proposed to equip rules and host graphs with distinguished (root) nodes, and to match roots in rules with roots in host graphs. This concept has been implemented in GP 2, allowing GP 2 specifications to rival the performance of traditional implementations in languages such as C [11]. Automated refinement of graph rewriting specifications to rooted versions remains an open research problem.

Graph transformation with root nodes and relabelling is not yet well understood. With only relabelling, Habel and Plump have been able to recover many, but not all, of the standard results [12], [13]. Moreover, Bak and Plump’s model suffers from the problem that derivations are not necessarily invertible. This motivates us to develop a new model of rooted graph transformation with relabelling which does not suffer this problem. If we have termination and invertibility, then we have an algorithm for testing graph language membership, and if we have confluence (and constant time matching), then we have an efficient algorithm too [14], [15].

Testing for ‘confluence’ is not possible in general [16], however we can sometimes use ‘critical pair’ analysis to show confluence. Confluence remains poorly understood, and while there are techniques for classifying ‘conflicts’ [17]–[19], it is rarely possible to actually show confluence. Moreover, in general, confluence is stronger than required for language efficient membership testing, motivating a weaker definition of confluence.

Our method will be to use mathematical definitions and proofs, as is usual in theoretical computer science. We aim to:

1. Outline rooted DPO graph transformation with relabelling;
2. Repair the problem of lack of invertibility in rooted GT systems;
3. Develop a new example of linear time graph algorithm;
4. Develop new results for confluence analysis of GT systems.

Results and Evaluation

We regard this project as a success, both the original and extended versions, having achieved our four goals. Our first, second and third goals have been addressed by the first, second and third chapters, respectively, and the final goal by the next two chapters. We started by briefly reviewing the current state of graph transformation, with a particular focus on the ‘injective DPO’ approach with relabelling and graph programming languages, establishing issues with the current approach to rooted graph transformation due to its ‘pointed’ implementation. We also briefly reviewed DPO-based graph programming languages.

We address the lack of invertibility of rooted derivations by defining rootedness using a partial function onto a two-point set rather than pointing graphs with root nodes. We have shown rule application corresponds to ‘NDPOs’, how Dodds’ complexity theory [20] applies in our system, and briefly discussed the equivalence of and refinement of GT systems. Developing a fully-fledged theory of correctness and refinement for (rooted) GT systems remains future work, as does establishing if the Parallelism and Concurrency theorems hold [13], [21]. Applications of our model to efficient graph class recognition are exciting due to the invertibility of derivations.

We have shown a new result that the graph class of trees can be recognised by a rooted GT system in linear time, given an input graph of bounded degree. Moreover, we have given empirical evidence by implementing the algorithm in GP2 and collecting timing results. The program and results were presented at CALCO 2019 [22]. Overcoming the restriction of host graphs to be of bounded degree remains open research, as well as showing further case studies and applications.

We have defined a new notion of ‘confluence up to garbage’ and ‘non-garbage critical pairs’, and shown that it is sufficient to require strong joinability of only the non-garbage critical pairs to establish confluence up to garbage. Moreover, we have lifted our results to our new framework for rooted graph transformation with relabelling via a faithful functor. We have applied this theory to Extended Flow Diagrams [23] and the encoding of partially labelled (rooted) GT systems as standard GT systems, performing non-garbage crit-

ical pair analysis on the encoded system. Further exploring the relationship between confluence up to garbage and closedness remains open work, as does improving the analysis of (non-garbage) critical pairs to allow us to decide confluence in more cases than currently possible via pair analysis.

Ethical Considerations

This project is of a theoretical nature. As such, no human participants were required, and no confidential data has been collected. Moreover, there are no anticipated ethical implications of this work or its applications.

Preface

This report is an extended version of the BSc Thesis of Graham Campbell [24] which incorporates additional results developed over 10 weeks, funded by a Vacation Internship of the Engineering and Physical Sciences Research Council (EPSRC) and supervised by Dr. Detlef Plump. Part of Chapter 3 was presented at CALCO 2019 as part of a co-authored paper looking at linear time algorithms in GP 2 [22].

Compared to the original thesis, the focus has been even more on fast language recognition. We have provided a more detailed introduction and theoretical background, and more care has been taken when defining the new theory, due to the page limit being removed. We have separated the semantic definitions of bounded degree and bounded roots preservation from the syntactic condition, which gives clarity that the syntactic condition is both sufficient and necessary. We have also provided a linear time full binary tree recognition system on graphs of bounded degree.

Additionally, in the second half of the report, we have reworked the previous definitions of confluence up to garbage and closure, changing, give an result that closedness is undecidable in general, and an example showing that a system can be locally confluent up to garbage and terminating, but not confluent up to garbage. Finally, we give a formal encoding of our new rooted GT systems as standard GT systems, which allows us to recover the Local Church-Rosser Theorem and the Non-Garbage Critical Pair Lemma in our new setting.

The structure of the report is as follows. We:

1. Provide a quick introduction and outline the theoretical background;
2. Present our new framework for rooted DPO graph transformation with relabelling and invertible rules;
3. Look at complexity of derivations in our new framework, and show that the framework is sufficient to recognise trees in linear time;
4. Develop new results for confluence analysis of conventional GT systems;
5. Lift our new results to the rooted framework via a faithful functor;
6. Summarise and evaluate our results, and list future work.

In the appendices, we have provided an overview of the notation used for sets, functions, relations, categories, and abstract reduction systems, and also some key results that we will be needing, from the literature. We also provide supplementary technical background on ‘conventional’ graph transformation, and graph theory, including the definitions of various graph classes.

During the period covered by the grant, Campbell also worked on improving the GP 2 Compiler. That work has not been summarised in this report, however is available in a separate report [25].

Chapter 1

Theoretical Background

“Mathematics is a game played according to certain simple rules with meaningless marks on paper.”

– David Hilbert, *Nine Mathematical Maxims and Minims (1988)*

Graph transformation is the rule-based modification of graphs, and is a discipline dating back to the 1970s, with the ‘algebraic approach’ invented at the Technical University of Berlin by Ehrig, Pfender, and Schneider [1], [2]. It is a comprehensive framework in which the local transformation of structures can be modelled and studied in a uniform manner [3]–[5].

In this chapter, we will review the rewriting of totally labelled graphs with relabelling, and Bak and Plump’s modifications adding ‘root’ nodes [26]. We will see how (rooted) graph transformation systems are instances of abstract reduction systems, and will look at graph programming languages.

1.1 Graphs and Morphisms

There are various definitions of a ‘graph’. In particular, we are interested in graphs where edges are directed and parallel edges are permitted. We will start by introducing ‘unlabelled’ graphs. We will then build on these with (partially) labelled (rooted) graphs and morphisms.

Definition 1.1. We can formally define a **concrete graph** as:

$$G = (V, E, s : E \rightarrow V, t : E \rightarrow V)$$

where V is a **finite** set of **vertices**, E is a **finite** set of **edges**. We call $s : E \rightarrow V$ the **source** function, and $t : E \rightarrow V$ the **target** function.

Definition 1.2. If G is a **concrete graph**, then $|G| = |V_G| + |E_G|$.

Example 1.1. Consider the concrete graph $G = (\{1, 2, 3\}, \{a, b, c, d\}, s, t)$ where $s = \{(a, 1), (b, 2), (c, 3), (d, 3)\}$, $t = \{(a, 2), (b, 1), (c, 1), (d, 3)\}$ (treating functions as sets). Its graphical representation is given in Figure 1.1. Note that the numbers are not ‘labels’, but ‘node ids’. \triangle

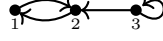

Figure 1.1: Example Concrete Graph

Definition 1.3. Given two concrete graphs G and H , a **graph morphism** $g : G \rightarrow H$ is a pair of maps $g = (g_V : V_G \rightarrow V_H, g_E : E_G \rightarrow E_H)$ such that sources and targets are preserved. That is, $\forall e \in E_G$, $g_V(s_G(e)) = s_H(g_E(e))$ and $g_V(t_G(e)) = t_H(g_E(e))$. Equivalently, both of the squares in Figure 1.2 commute.

$$\begin{array}{ccc} E_G & \xrightarrow{s_G} & V_G \\ \downarrow g_E & & \downarrow g_V \\ E_H & \xrightarrow{s_H} & V_H \end{array} \quad \begin{array}{ccc} E_G & \xrightarrow{t_G} & V_G \\ \downarrow g_E & & \downarrow g_V \\ E_H & \xrightarrow{t_H} & V_H \end{array}$$

Figure 1.2: Graph Morphism Commuting Diagrams

Definition 1.4. A graph morphism $g : G \rightarrow H$ is **injective/surjective** iff both g_V and g_E are injective/surjective as functions. We say g is an **isomorphism** iff it is both injective and surjective.

Example 1.2. The identity morphism (id_V, id_E) is an isomorphism between any graph and itself. \triangle

Example 1.3. Consider the graphs in Figure 1.3. There are four morphisms $G \rightarrow H$, three of which are injective, none of which are surjective. There are actually also four morphisms $H \rightarrow G$, three of which are surjective. \triangle



Figure 1.3: Example Concrete Graphs

Definition 1.5. We say that graphs G, H are **isomorphic** iff there exists a **graph isomorphism** $g : G \rightarrow H$, and we write $G \cong H$. This naturally gives rise to **equivalence classes** $[G]$, called **abstract graphs**.

Proposition 1.1. The **quotient** (Definition A.21) of the **collection** of all **concrete graphs** with \cong is the **countable set** of all **abstract graphs**.

1.2 Graph Transformation

There are various approaches to graph transformation, most notably the ‘edge replacement’ [27], ‘node replacement’ [28], and ‘algebraic’ approaches [3], [4]. The two major approaches to algebraic graph transformation are the so called ‘double pushout’ (DPO) approach, and the ‘single pushout’ (SPO) approach.

Because the DPO approach operates in a structure-preserving manner (rule application in SPO is without an interface graph, so there are no dangling condition checks), this approach is more widely used than the SPO [4], [5, p.9-14]. For this reason, we will focus only on the DPO approach with injective matching.

Given an unlabelled graph (Definition 1.1), there are two common approaches to augmenting it with data: **typed graphs** and **totally labelled graphs**. We choose to work with the **labelled approach** (Section D.1) because it is easy to understand and reason about, has a **relabelling** theory (Section 1.3), and a ‘rooted’ modification (Section 1.4). Details of the **typed approach** can be found in Section D.2. Note that typed (attributed) (hyper)graphs have a rich theory [15], [29]–[35].

A review of graph transformation of labelled graphs using the DPO approach with injective matching can be found in Appendix D. We will also cover the definitions and results for our new type of system in Chapter 2, so we will not repeat ourselves in this chapter by giving all of the detail again. Additionally, an example system and grammar can be found in Chapter 3.

1.3 Adding Relabelling

The origin of partially labelled graphs is from the desire to have ‘relabelling’. If the interface K is totally labelled, then any node which has context (incident edges) cannot be deleted, and so we must preserve its label to avoid breaking uniqueness of rule application. We can get around this problem with partial labelling of interface graphs, and thus with modest modifications to the theory for totally labelled graphs we allow rules to ‘relabel’ nodes. We shall be using this foundation going forward. All the relevant definitions and theorems are in Appendix D.

We are in fact using a restricted version of the theory presented by Habel and Plump [12], the restriction being that we allow the interface K to be partially labelled, but require L , R and G to be totally labelled, ensuring that given a totally labelled input graph G , the result graph H is also totally labelled. Thus, derivations are defined only on totally labelled graphs, but allow us to relabel nodes.

Example 1.4. Consider the following totally labelled ‘rule’, over the label alphabet $(\{1, 2\}, \{\square\})$ where x, y are to be determined:

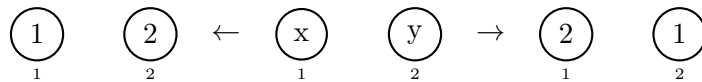

Figure 1.4: Relabelling Non-Example

We want to swap the labels without deleting the nodes, because they may

have context. There is no value we can choose for x or y such that the conditions to be a totally labelled graph morphism are satisfied. Now consider the setting where we allow the interface graph to have a partial node label map. We could simply not label the interface nodes, and then we have exactly what we want. \triangle

1.4 Rooted Graph Transformation

Rooted graph transformation first appeared when Dörr [10] proposed to equip rules and host graphs with distinguished (root) nodes, and to match roots in rules with roots in host graphs. Root nodes were first considered in the DPO setting by Dodds and Plump [14], [20], and most recently, Bak and Plump [11], [26] have used rooted graph transformation in conjunction with the theory of partially labelled graph transformation in GP 2.

The motivation for root nodes is to improve the complexity of finding a match of the left-hand graph L of a rule within a host graph G . In general, linear time graph algorithms may, instead, take polynomial time when expressed as graph transformation systems [14], [26], [36], [37]. An excellent account of this is available in Part II of Dodds' Thesis [20].

We can define rooted graphs in a pointed style, just as for typed graphs. An account of the theoretical modifications is provided in Section D.8, using Bak's approach [26]. This is different to Dodds' approach [14], [20] which implemented roots as a special node label. Bak's approach allows nodes to have genuine labels and also be rooted, and has been implemented in GP 2.

We can formalise the problem of applying a rule:

Definition 1.6 (Graph Matching Problem (GMP)). Given a graph G and a rule $r = \langle L \leftarrow K \rightarrow R \rangle$, find the set of injective graph morphisms $L \rightarrow G$.

Definition 1.7 (Rule Application Problem (RAP)). Given a graph G , a rule $r = \langle L \leftarrow K \rightarrow R \rangle$, and an injective match $g : L \rightarrow G$, find the result graph H . That is, does it satisfy the 'dangling condition', and if so, construct H .

Proposition 1.2. The GMP requires time $O(|G|^{|L|})$ time given the assumptions in Figure 1.5, derived from Dodds' PhD Thesis [20]. Moreover, given a match, one can decide if it is applicable in $O(|r|)$ time. That is, the RAP requires $O(|r|)$ time. [20]

To improve matching performance, one can add root nodes to rules and match roots in rules with roots in host graphs, meaning we need only consider subgraphs of bounded size for matching, vastly improving the time complexity. That is, given a graph G of bounded degree (Definition E.7) containing a bounded number of root nodes, and a rule of bounded size with L containing a single root node, then the time complexity of GMP is only constant [20].

Input	Output	Time
label l	The set Z of nodes with label l .	$O(Z)$
node v	Values $\deg(v)$, $\text{indeg}(v)$, $\text{outdeg}(v)$.	$O(1)$
node v , label l	No. edges with source v , label l .	$O(1)$
node v , label l	No. edges with target v , label l .	$O(1)$
node v , label l	Set X of edges with source v , label l .	$O(X)$
node v , label l	Set X of edges with target v , label l .	$O(X)$
graph G	$ V_G $ and $ E_G $.	$O(1)$

Figure 1.5: Complexity Assumptions Table

Example 1.5. Figure 1.6 ‘moves the root node’ and also ‘relabels’ the nodes in the host graph. A ‘fast’ rooted implementation of the 2-colouring problem is available at [26], showcasing root nodes in GP 2. \triangle

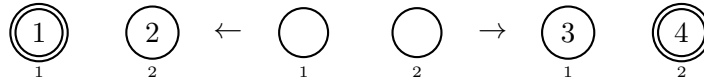

Figure 1.6: Example Rooted Rule

We will revisit time complexity in Section 3.1, showing that if rules are of a certain type, then derivations take only constant time, allowing us to use only derivation length as a measure of time complexity, as in standard complexity analysis theory for (non-deterministic) Turing Machines, first considered by Hartmanis and Stearns in 1965 [38].

1.5 Graph Languages

Intuitively, a graph language is simply a set of graphs, just like a string language is a set of strings. Just like we can define string languages using string grammars, we can define graph languages using graph grammars, where we rewrite some start graph using a set of graph transformation rules. Derived graphs are then defined to be in the language if they are terminally labelled. We formally define graph languages in Section D.5.

Definition 1.8. Let \mathcal{L} be some fixed label alphabet (Definition D.1). We let $\mathcal{G}(\mathcal{L})$ be the **collection** of all totally labelled **abstract graphs**, and $\widehat{\mathcal{G}}(\mathcal{L})$ be the **collection** of all totally labelled, totally rooted **abstract graphs**.

Proposition 1.3. Given some \mathcal{L} , $\mathcal{G}(\mathcal{L})$ and $\widehat{\mathcal{G}}(\mathcal{L})$ are **countable sets**.

There are only countably many abstract graphs; an essential property when setting up graph languages. We would be in trouble if the universal language was not countable, or not even a set! Naming of elements from uncountable sets requires non-standard theory (such as Type-2 Computability Theory [39]), and we get into even more trouble when we want to name elements from

sets larger than the continuum cardinality. When we make computability statements about languages, we are tacitly assuming a Gödel numbering [40].

We choose to define languages as abstract graphs, so that they are countable sets, rather than proper classes. Moreover, when one talks of a finite graph language, we can genuinely be referring to its cardinality, and not the cardinality of its quotient under graph isomorphism. This approach is not standardised, and many authors prefer to define graph languages in terms of concrete graphs. The other obvious approach (used by Courcelle and Engelfriet [41]) is to restrict the ambient from which nodes and edges are drawn from to some countable set which is closed under pairing (to allow for the disjoint union construction when computing pushouts).

Uesu showed in 1978 that the DPO graph grammars can generate every **recursively enumerable** (Definition A.30) set of graphs [42]. A large body of literature exists when it comes to context-free graph grammars, however the focus is on (hyper)edge replacement grammars [27] and node replacement grammars [28], which are less powerful than DPO-grammars. We have provided a formal definition of edge replacement grammars in Section D.9.

1.6 Abstract Reduction Systems

Abstract reduction systems (or simply **reduction systems** or **ARS**) are a much more general setting than **graph transformation systems** (**GT systems** or **GTS**), and model the step-wise transformation of objects (see Appendix C). These systems were studied for the first time by Newman in the early 40s [43]. Turing Machines and GT systems clearly fit into this model of reduction. Moreover, the formal semantics of programming languages is often defined in terms of a step-wise computation relation.

Example 1.6. $(\mathbb{N}, >)$ is a **terminating** (Definition C.4), **finitely branching** (Definition C.6), **confluent** (Definition C.8) ARS (Definition C.1). \triangle

Example 1.7. $(\mathbb{Z}, >)$ by comparison is not **terminating** or **finitely branching**, but it is **confluent!** \triangle

Definition 1.9. Let $T = (\mathcal{L}, \mathcal{R})$ be a (rooted) **GTS**. Then $(\mathcal{G}(\mathcal{L}), \rightarrow_{\mathcal{R}})$ is the **induced ARS** defined by $\forall [G], [H] \in \mathcal{G}(\mathcal{L}), [G] \rightarrow_{\mathcal{R}} [H]$ iff $G \Rightarrow_{\mathcal{R}} H$.

Lemma 1.1. Consider the **ARS** $(\mathcal{G}(\mathcal{L}), \rightarrow)$ induced by a (rooted) **GTS**. Then \rightarrow is a **binary relation** (Definition A.14) on $\mathcal{G}(\mathcal{L})$. Moreover, it is **finitely branching** (Definition C.6) and **decidable** (Definition A.29).

Proof. By Proposition 1.3, $\mathcal{G}(\mathcal{L})$ is a countable set, and so \rightarrow is a countable set (by Theorem A.2), and is well-defined since derivations are unique up to isomorphism (Theorem D.8). Finally, we have only finitely many rules, and for each rule, there can only exist finitely many matches $L \rightarrow G$, so there can

only ever be finitely many result graphs H (up to isomorphism) $G \Rightarrow_{\mathcal{R}} H$ for any given G . \square

Theorem 1.1 (Property Undecidability). Consider the **ARS** $(\mathcal{G}(\mathcal{L}), \rightarrow)$ induced by a (rooted) **GTS**. Then testing if \rightarrow is **terminating**, **acyclic**, or **(locally) confluent** is **undecidable** in general.

Proof. Testing for acyclicity or termination was shown to be undecidable in general by Plump in 1998 [44]. Undecidability of (local) confluence checking was shown by Plump in 1993 [16], even for terminating GT systems [45]. \square

While confluence testing is undecidable, there are some instances in which one can decide confluence or non-confluence of GT systems. In 1970, Knuth and Bendix showed that confluence checking of terminating term rewriting systems is decidable [46]. Moreover, it suffices to compute all ‘critical pairs’ and check their joinability [47]–[49]. Unfortunately, joinability of critical pairs does not imply local confluence of GT system, otherwise we could have contradicted our theorem! In 1993, Plump showed that ‘strong joinability’ of all critical pairs is sufficient but not necessary to show local confluence [16], [45]. We have summarised these results in Section D.7.

1.7 Graph Programming Languages

GT systems naturally lend themselves to expressing computation by considering the normal forms of the input graph.

Example 1.8. Given a GT system $T = (\mathcal{L}, \mathcal{R})$, consider the **state space** $\Sigma = \mathcal{G}(\mathcal{L}) \cup \{\perp\}$ and the induced ARS $(\mathcal{G}(\mathcal{L}), \rightarrow_{\mathcal{R}})$. We may define the **semantic function** $f_T : \mathcal{G}(\mathcal{L}) \rightarrow \mathcal{P}(\Sigma)$ by $f_T([G]) = \{[H] \mid [H] \text{ is a normal form of } [G] \text{ with respect to } \rightarrow_{\mathcal{R}}\} \cup \{\perp \mid \text{there is an infinite reduction sequence starting from } [G]\}$ and $f_T(\perp) = \{\perp\}$. \triangle

There are a number of GT languages and tools, such as AGG [50], GMTE [51], Dactl [52], GP 2 [53], GReAT [54], GROOVE [55], GrGen.Net [56], Henshin [57], PROGRES [58], and PORGY [59]. Habel and Plump [60] show that such languages can be ‘computationally complete’:

Proposition 1.4. To be **computationally complete**, the three constructs:

1. Nondeterministic application of a rule from a set of rules (\mathcal{R}) ;
2. Sequential composition $(P1; P2)$;
3. Iteration in the form that rules are applied as long as possible $P\downarrow$.

are not only **sufficient**, but **necessary** (using DPO-based rule application).

Example 1.9. The semantics of some program P is a binary relation \rightarrow_P on some set of abstract (rooted) graphs \mathcal{G} , inductively defined as follows:

1. $\rightarrow_{\mathcal{R}} := \rightarrow$ (where \rightarrow is the induced ARS relation on \mathcal{R}).
2. $\rightarrow_{P_1; P_2} := \rightarrow_{P_2} \circ \rightarrow_{P_1}$.
3. $\rightarrow_{P_{\downarrow}} := \{([G], [H]) \mid [G] \rightarrow_P^* [H] \text{ and } [H] \text{ is in normal form}^1\}$. \triangle

Remark 1.1. While GT systems can ‘simulate’ any Turing Machine, this does not make them ‘computationally complete’ in the strong sense that any computable function on arbitrary graphs can be programmed.

GP 2 is an experimental rule-based language for problem solving in the domain of graphs, developed at York, the successor of GP [53], [61]. GP 2 is of interest because it has been designed to support formal reasoning on programs [62], with a semantics defined in terms of partially labelled graphs, using the injective DPO approach with relabelling [12], [63]. Poskitt and Plump have set up the foundations for verification of GP 2 programs [64]–[67] using a Hoare-Style [68] system (actually for GP [61], [69]), Hristakiev and Plump have developed static analysis for confluence checking [18], [70], and Bak and Plump have extended the language, adding root nodes [11], [26]. Plump has shown computational completeness [71].

GP 2 uses a model of ‘rule schemata’ with ‘application conditions’, rather than ‘rules’ as we have seen up until now. The label alphabet used for both nodes and edges is $(\mathbb{Z} \cup \text{Char}^*)^* \times \mathcal{B}$. Roughly speaking, rule application works by finding an injective ‘pre-morphism’ by ignoring labels, and then checking if there is an assignment of values such that after evaluating the label expressions, the morphism is label-preserving. The application condition is then checked, then rule application continues. [53]

The formal semantics of GP 2 is given in the style of Plotkin’s structural operational semantics [72]. Inference rules inductively define a small-step transition relation \rightarrow on configurations. The inference rules and definition of the semantic function $\llbracket \cdot \rrbracket : \text{ComSeq} \rightarrow \mathcal{G} \rightarrow \mathcal{P}(\mathcal{G} \cup \{\text{fail}, \perp\})$ were first defined in [53]. Up-to-date versions can be found in [11].

¹ $[H]$ is in normal form iff it is not reducible using \rightarrow_P

Chapter 2

A New Theory of Rooted Graph Transformation

“In mathematics the art of asking questions is more valuable than solving problems.”

– Georg Cantor, *Doctoral thesis (1867)*

Graph transformation with relabelling as described in Sections 1.2, 1.3, D.4 and D.5 has desirable properties. It was shown by Habel and Plump in 2002 [12] that derivations are natural double pushouts (Theorem D.3) and thus are invertible. Unfortunately, Bak and Plump’s modifications to add root nodes (Sections 1.4 and D.8) mean that derivations no longer exhibit these properties. That is, only the right square of a derivation in a rooted GT system need be a natural pushout. This asymmetry is unfortunate, because derivations are no longer invertible. Figure 2.1 shows an example rooted derivation in which the right square is not a pullback.

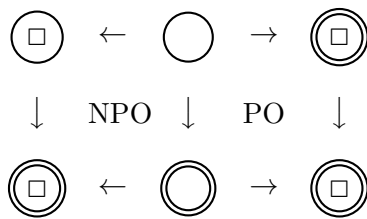

Figure 2.1: Example Rooted Derivation

We propose an alternative theory for rooted graph transformation with relabelling, with some more desirable properties. Critically, we **restore invertibility** of derivations (Corollary 2.1), and remove some undesirable matching cases (Lemma 2.5), allowing us to prove a handy root node invariance result (Corollary 2.2). Our restrictions are slightly more than Habel and Plump’s original version of graph transformation with relabelling, however our interest

is only in the cases that are practically useful. Similar restrictions are already in place within the graph programming language GP 2 [53].

2.1 Graphs and Morphisms

Fix some common label alphabet (Definition D.1) $\mathcal{L} = (\mathcal{L}_V, \mathcal{L}_E)$. In this section we define our new notions of graphs and morphisms.

Definition 2.1. A **graph** over \mathcal{L} is a tuple $G = (V, E, s, t, l, m, p)$ where:

1. V is a **finite** set of **vertices**;
2. E is a **finite** set of **edges**;
3. $s : E \rightarrow V$ is a **total** source function;
4. $t : E \rightarrow V$ is a **total** target function;
5. $l : V \rightarrow \mathcal{L}_V$ is a **partial** function, labelling the vertices;
6. $m : E \rightarrow \mathcal{L}_E$ is a **total** function, labelling the edges;
7. $p : V \rightarrow \mathbb{Z}_2^1$ is a **partial** function, determining vertex rootedness.

Definition 2.2. If G is a **graph**, then we define its size $|G| = |V_G| + |E_G|$.

Definition 2.3. A graph G is **totally labelled** iff l_G is total, and **totally rooted** if p_G is total. If G is both, then we call it a **TLRG**.

Remark 2.1. A totally rooted graph need not have every node a root node, only p_G must be total. 0 denotes unrooted, and 1 rooted. When we draw graphs, we shall denote the absence of rootedness with **diagonal stripes**. If a node has a **double border**, it is rooted, otherwise, it is unrooted.

Example 2.1. Let $\mathcal{L} = (\{\square, \triangle\}, \{x, y\})$. Then $G = (V, E, s, t, l, m, p)$ is a graph over \mathcal{L} where $V = \{1, 2, 3, 4\}$, $E = \{1, 2\}$, $s = \{(1, 1), (2, 2)\}$, $t = \{(1, 2), (2, 3)\}$, $l = \{(1, \square), (2, \triangle)\}$, $m = \{(1, x), (2, y)\}$, and $p = \{(1, 0), (2, 1), (4, 0)\}$. Its graphical representation is shown in Figure 2.2. G is neither totally rooted nor totally labelled, since node 3 has both undefined rootedness and no label, and node 4 also has no label. \triangle

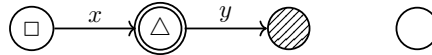

Figure 2.2: Example Graph

Definition 2.4. A **graph morphism** between graphs G and H is a pair of functions $g = (g_V : V_G \rightarrow V_H, g_E : E_G \rightarrow E_H)$ such that sources, targets, labels, and rootedness are preserved. That is:

1. $\forall e \in E_G, g_V(s_G(e)) = s_H(g_E(e));$ [Sources]
2. $\forall e \in E_G, g_V(t_G(e)) = t_H(g_E(e));$ [Targets]

¹ \mathbb{Z}_2 is the quotient $\mathbb{Z}/2\mathbb{Z} = \{0, 1\}$.

3. $\forall e \in E_G, m_G(e) = m_H(g_E(e));$ [Edge Labels]
4. $\forall v \in l_G^{-1}(\mathcal{L}_V), l_G(v) = l_H(g_V(v));$ [Node Labels]
5. $\forall v \in p_G^{-1}(\mathbb{Z}_2), p_G(v) = p_H(g_V(v)).$ [Rootedness]

Remark 2.2. If G and H are **TLRGs**, then this is equivalent to the following diagram commuting (for s_G, s_H and t_G, t_H separately):

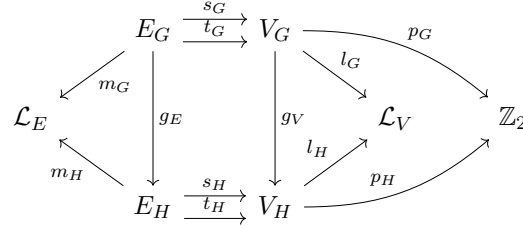

Figure 2.3: Graph Morphism Commuting Diagrams

An important property of morphisms is that if a node is labelled, then its image under the morphism must have the same label, and the same for the rootedness. However, if the label or rootedness of a node is not defined, then we do not specify anything about its image. Nodes with undefined labels may be mapped to nodes with undefined labels, but could also be mapped to labelled nodes, and similarly for rootedness. There are some circumstances where it is useful to additionally insist on undefinedness being preserved, which motivates our next definition.

Definition 2.5. A graph morphism $g : G \rightarrow H$ is **undefinedness preserving** iff it is both:

1. **Label-undefinedness preserving:** $l_G = l_H \circ g_V;$
2. **Root-undefinedness preserving:** $p_G = p_H \circ g_V.$

Remark 2.3. The undefinedness preserving property is exactly requiring that the two right-most triangles in Figure 2.3 commute. It is thus a triviality that all morphisms between TLRG are undefinedness preserving.

Just like unlabelled (totally labelled) graphs and morphisms, our new notion of graphs and morphisms forms a category where the graphs are the objects and the morphisms are the arrows.

Proposition 2.1. Our new notion of graphs and morphisms is a **locally small** (Definition B.3), **finitary** (Definition B.4) **category** (Definition B.1).

Definition 2.6. A graph morphism $g : G \rightarrow H$ is **injective** (**surjective**) iff the underlying functions g_V, g_E are injective (surjective). We say that g is an **isomorphism** iff it is both **injective** and **surjective**, and $g^{-1} : H \rightarrow G$ is also a graph morphism.

Proposition 2.2. Morphisms are **injective** (**surjective, isomorphisms**) iff they are **monic** (**epic, isomorphisms**) in the category theoretic sense.

Proposition 2.3. A morphism is an **isomorphism** iff it is **injective**, **surjective**, and **undefinedness preserving**.

Example 2.2. There exist morphisms that are injective, surjective graph morphisms that are not isomorphisms. Just consider two discrete (no edges) graph with one node, the first with no node label, and the second with some label. There is an injective, surjective morphism from the first to second, but not in the other direction. \triangle

Definition 2.7. We say H is a **subgraph** of G iff there exists an **inclusion morphism** $H \hookrightarrow G$. This happens iff $V_H \subseteq V_G$, $E_H \subseteq E_G$, $s_H = s_G|_{E_H}$, $t_H = t_G|_{E_H}$, $m_H = m_G|_{E_H}$, $l_H \subseteq l_G$, $p_H \subseteq p_G$ (treating functions as sets).

Remark 2.4. There are two obvious (non-equivalent) definitions of subgraph. We have chosen here to define subgraphs to be exactly those that can be included in the parent structure. This is particularly useful when it comes to defining rules later. The other definition (closer to that given by Habel and Plump for partially labelled graphs) would be to require the morphism to also be undefinedness preserving.

Definition 2.8. We say that graphs G, H are **isomorphic** iff there exists a **graph isomorphism** $g : G \rightarrow H$. This gives **equivalence classes** $[G]$ over \mathcal{L} . We denote by $\mathcal{G}^\oplus(\mathcal{L})$ the collection of totally labelled, totally rooted **abstract graphs** over some fixed \mathcal{L} .

There are only countably many abstract graphs; an essential property when setting up graph languages. As we remarked in Chapter, 1, we would be in trouble if the universal language was not a countable set.

Proposition 2.4. $\mathcal{G}^\oplus(\mathcal{L})$ is a **countable set**.

2.2 Rules and Derivations

Fixing some common $\mathcal{L} = (\mathcal{L}_V, \mathcal{L}_E)$, we define rules and derivations. We only concern ourselves, for now, with ‘linear rules’ and injective matches [63]. Moreover, some of the results we will be showing later don’t hold in more general versions of this set up.

Definition 2.9. A **rule** $r = \langle L \leftarrow K \rightarrow R \rangle$ consists of left/right **TLRGs** L , R , the interface **graph** K , and **inclusions** $K \hookrightarrow L$ and $K \hookrightarrow R$.

Remark 2.5. Insisting on inclusions is without loss of generality. We could have only required two injective graph morphisms, but assuming inclusions makes for neater proofs involving rules. Moreover, we can think of K as a subgraph of both L and R .

Example 2.3. See Figure 3.3. \triangle

Definition 2.10. We define the **inverse rule** to be $r^{-1} = \langle R \leftarrow K \rightarrow L \rangle$.

Definition 2.11. If $r = \langle L \leftarrow K \rightarrow R \rangle$ is a **rule**, then $|r| = \max\{|L|, |R|\}$.

Definition 2.12. Given a **rule** $r = \langle L \leftarrow K \rightarrow R \rangle$ and a **TLRG** G , we say that an **injective** morphism $g : L \hookrightarrow G$ satisfies the **dangling condition** iff no edge in $G \setminus g(L)$ is incident to a node in $g(L \setminus K)$.

Definition 2.13. To **apply** a rule $r = \langle L \leftarrow K \rightarrow R \rangle$ to some **TLRG** G , find an **injective** graph morphism $g : L \hookrightarrow G$ satisfying the **dangling condition**, then:

1. Delete $g(L \setminus K)$ from G . For each unlabelled node v in K , make $g_V(v)$ unlabelled, and for each node v in K with undefined rootedness, make $g_V(v)$ have undefined rootedness, giving **intermediate graph** D .
2. Add disjointly $R \setminus K$ to D , keeping their labels and rootedness. For each unlabelled node v in K , label $g_V(v)$ with $l_R(v)$, and for each node with undefined rootedness v in K , make $g_V(v)$ have rootedness $p_R(v)$, giving the **result graph** H .

If the **dangling condition** fails, then the rule is not applicable using the **match** g . We can exhaustively check all matches to determine applicability.

Definition 2.14. We write $G \Rightarrow_{r,g} M$ for a successful application of r to G using match g , obtaining result $M \cong H$. We call this a **direct derivation**. We may omit g when it is not relevant, writing simply $G \Rightarrow_r M$.

Remark 2.6. Formally, a direct derivation is actually the diagram Figure 2.4.

Definition 2.15. For a given set of rules \mathcal{R} , we write $G \Rightarrow_{\mathcal{R}} H$ iff H is **directly derived** from G using any of the rules from \mathcal{R} .

Definition 2.16. We write $G \Rightarrow_{\mathcal{R}}^+ H$ iff H is **derived** from G in one or more **direct derivations**, and $G \Rightarrow_{\mathcal{R}}^* H$ iff $G \cong H$ or $G \Rightarrow_{\mathcal{R}}^+ H$.

2.3 Foundational Theorems

We will show that gluing and deletions correspond to natural pushouts and natural pushout complements, respectively. Thus, derivations are invertible.

$$\begin{array}{ccccc}
 L & \longleftarrow & K & \longrightarrow & R \\
 \downarrow & (1) & \downarrow & (2) & \downarrow \\
 G & \longleftarrow & D & \longrightarrow & H
 \end{array}$$

Figure 2.4: Commuting Squares

Our first technical lemma ensures that pullbacks exist in our new setting.

Lemma 2.1. Given **graph morphisms** $g : L \rightarrow G$ and $c : D \rightarrow G$, there exist a **graph** K and **graph morphisms** $b : K \rightarrow L$, $d : K \rightarrow D$ such that the resulting square is a **pullback** (Definition B.8).

Proof. The constructions are exactly as in Lemma 1 of [12], with the rootedness function defined analogously to the node labelling function. Trivial modifications to the proof give the result. \square

Our second technical lemma, roughly speaking, ensures that pullbacks exist in our new setting, in the case $K \rightarrow D$ is injective and that we don't have any confusion created by conflicting labels or rootedness. In the totally labelled case (without root nodes), we don't need to worry about such confusion.

Lemma 2.2. Let $b : K \rightarrow R$, $d : K \rightarrow D$ be **graph morphisms** such that:

1. d is **injective**,
2. $\forall v \in V_R, |l_R(\{v\}) \cup l_D(d_V(b_V^{-1}(\{v\})))| \leq 1$,
3. $\forall v \in V_R, |p_R(\{v\}) \cup p_D(d_V(b_V^{-1}(\{v\})))| \leq 1$.

Then, there exist a **graph** H and **graph morphisms** $h : R \rightarrow H$, $c : D \rightarrow H$ such that the resulting square is a **pushout** (Definition B.7).

Proof. The constructions are exactly as in Lemma 2 of [12], with the rootedness function defined analogously to the node labelling function. \square

Our third technical lemma says that as long as $K \rightarrow D$ is injective, and no additional labels or roots are introduced in D , then the left square is a pullback if it is a pushout.

Lemma 2.3. Given two **graph morphisms** $b : K \rightarrow L$ and $d : K \rightarrow D$ such that b is **injective** and L is a **TLRG**, then the pushout (1) is **natural** (Definition B.9) iff $l_D(d_V(V_K \setminus l_K^{-1}(\mathcal{L}_V))) = \emptyset = p_D(d_V(V_K \setminus p_K^{-1}(\mathbb{Z}_2)))$.

Proof. Let square (1) in Figure 2.4 be a natural pushout with graph morphisms $g : L \rightarrow G$ and $c : D \rightarrow G$. Once again, we can proceed as in Lemma 3 of [12] with the obvious modifications. Similar for the other direction. \square

Our final technical lemma shows a correspondence between the existence of natural pushout complements and matches satisfying the dangling condition. Moreover, that the intermediate graph D is essentially unique (unique up to isomorphism).

Lemma 2.4. Let $g : L \rightarrow G$ be an **injective graph morphism** and $K \rightarrow L$ an **inclusion morphism**. Then, there exist a **graph** D and **morphisms** $K \rightarrow D$ and $D \rightarrow G$ such that the square (1) is a **natural pushout** iff g satisfies the **dangling condition**. Moreover, in this case, D is unique up to isomorphism.

Proof. Proceed as in Lemma 4 of [12] with the obvious modifications. \square

We now present our first major theorem. The explicit construction of derivations given earlier corresponds exactly to a NDPO diagram. Moreover, the result graph is essentially unique and the input is a **TLRG** iff the result is.

Theorem 2.1 (Derivation Theorem). Given a rule $\langle L \leftarrow K \rightarrow R \rangle$ and an **injective graph morphism** $g : L \rightarrow G$, then there exists a **natural DPO** diagram as above iff g satisfies the **dangling condition**. In this case, D and H are unique up to isomorphism, and rule application exactly corresponds to that given in Definition 2.13. Moreover, if $G \Rightarrow_r H$, then G is a **TLRG** iff H is a **TLRG**.

Proof. Proceed as in Theorem 1 of [12] with the obvious modifications. Totality of labelling is given by Theorem 2 of [12], and totality of rootedness is given by replacing all occurrences of the labelling function with the rootedness function in the proof. \square

An important consequence of having both squares as natural pushouts is that we have a symmetry giving invertibility of derivations. This symmetry is unique to this new approach to rooted graph transformation. In Bak's approach (Appendix D.8), derivations are not, in general, invertible (Figure 2.1). In Bak's system, the intermediate graph D must not have a root if we want to invert the derivation.

Corollary 2.1. Derivations are **invertible**. That is $G \Rightarrow_r H$ iff $H \Rightarrow_{r^{-1}} G$.

Proof. By the last theorem, $G \Rightarrow_r H$ means we have a match $g : L \rightarrow G$, and a comatch $h : R \rightarrow H$, and so by symmetry, we have the result. \square

It absolutely cannot be overstated how important invertibility is! It will be the foundation of so many arguments within the rest of the theory and examples, in particular when it comes to language recognition. Moreover, if it weren't for invertibility, there is no way that we could perform an encoding in Chapter 5 to recover the Critical Pair Lemma!

Finally, we can now show our root node invariance result. By comparison, in Bak's system, non-root nodes could be matched against root nodes.

Lemma 2.5. Let G be a **TLRG**, and $r = \langle L \leftarrow K \rightarrow R \rangle$ a rule. Then root nodes in L can only be matched against root nodes in G , and similarly for non-root nodes.

Proof. Immediate from the definitions. \square

Corollary 2.2. Let G be a **TLRG**, and $r = \langle L \leftarrow K \rightarrow R \rangle$ a rule such that L and R both contain k root nodes, for some fixed $k \in \mathbb{N}$. Then any **TLRG** H derived from G using r contains n root nodes iff G contains n root nodes.

Proof. By Lemma 2.5 (non-)roots in L can only be identified with (non-)roots in G , and by symmetry the same for R in H . By Theorem 2.1, NDPO existence corresponds to Definition 2.13, so, $|p_G^{-1}(\{1\})| = |p_H^{-1}(\{1\})|$. \square

2.4 Equivalence of Rules

We now consider equivalence of rules, starting by formalising what it means to say that two rules are isomorphic, and then we will show that we can find a normal form for rules, unique up to isomorphism. In the next sections, we will see these notions of equivalence can be extended to GT systems in a natural way. Derivation compatibility will prove to be an important notion.

Definition 2.17. Given rules $r_1 = \langle L_1 \leftarrow K_1 \rightarrow R_1 \rangle$, $r_2 = \langle L_2 \leftarrow K_2 \rightarrow R_2 \rangle$. We call r_1 and r_2 **isomorphic** iff there exists isomorphisms $f : L_1 \rightarrow L_2$, $g : R_1 \rightarrow R_2$ such that $f|_{K_1} = g|_{K_1}$ and $f(K_1) = K_2$. Write $r_1 \cong r_2$.

The above notion of **rule isomorphism** is an **equivalence**, and gives rise to **abstract rules** $[r]$. Moreover, the collection of all abstract rules over some fixed alphabet forms a countable set. This is a nice little result, since the collection of all rules is actually not a set.

Definition 2.18. Given a rule $r = \langle L \leftarrow K \rightarrow R \rangle$, define its **normal form** $r \downarrow = \langle L \leftarrow K' \rightarrow R \rangle$ where $K' = (V_K, \emptyset, \emptyset, \emptyset, \emptyset, \emptyset)$. We say two rules r_1, r_2 are **normalisation equivalent** iff $r_1 \downarrow \cong r_2 \downarrow$. We write $r_1 \simeq r_2$.

Clearly, this gives us a **coarser** notion of **equivalence** for rules than the notion of **isomorphism**. This notation of equivalence is important because it has the property that all concrete representatives behave the same, in the sense of Theorem 2.2.

Example 2.4. Consider the rules over $(\{\square, \triangle\}, \{\square, \triangle\})$ as given in Figure 2.5. Clearly r_1 and r_2 are isomorphic, but r_3 is not isomorphic to either. Rule r_1 has normal form r'_1 . \triangle

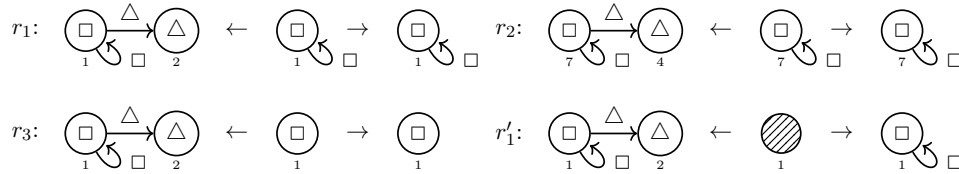

Figure 2.5: Example (Non-)Isomorphic Rules

Theorem 2.2 (Compatible Derivations). Given a rule $r = \langle L \leftarrow K \rightarrow R \rangle$ and its normal form $r \downarrow = \langle L \leftarrow K' \rightarrow R \rangle$, then for all TLRGs G, H , $G \Rightarrow_r H$ iff $G \Rightarrow_{r \downarrow} H$.

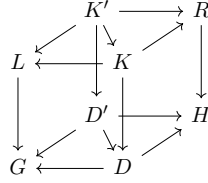

Figure 2.6: Derivations Diagram

Proof. Consider some fixed graph G . The set of injective morphisms $g : L \rightarrow G$ satisfying the dangling condition must be identical for both rules since L is the same and so is V_K . Then, by the explicit construction of H given by Definition 2.13, $G \Rightarrow_{r,g} H$ iff $G \Rightarrow_{r\downarrow,g} H$. \square

Remark 2.7. Normal forms for rules is not actually a new observation, and is the foundation of rule schemata in GP 2 [53]. Moreover, maximising the number of edges in the interface of rules leads to a reduction of the number of critical pairs (Section D.7) of a GT system [70].

2.5 Graph Transformation Systems

We can now define graph transformation systems using our new definitions of graphs and rules. Next, we will look at different notions of equivalence for such system. This will become important in Chapter 5, when we rely on derivation compatibility.

Definition 2.19. A **graph transformation system** $T = (\mathcal{L}, \mathcal{R})$, consists of a label alphabet $\mathcal{L} = (\mathcal{L}_V, \mathcal{L}_E)$, and a **finite** set \mathcal{R} of rules over \mathcal{L} .

Definition 2.20. Given a **graph transformation system** $T = (\mathcal{L}, \mathcal{R})$, we define the inverse system $T^{-1} = (\mathcal{L}, \mathcal{R}^{-1})$ where $\mathcal{R}^{-1} = \{r^{-1} \mid r \in \mathcal{R}\}$.

Definition 2.21. Given a **graph transformation system** $T = (\mathcal{L}, \mathcal{R})$, a subalphabet of **non-terminals** \mathcal{N} , and a **start graph** S over \mathcal{L} , then a **graph grammar** is the system $\mathbf{G} = (\mathcal{L}, \mathcal{N}, \mathcal{R}, S)$.

A graph is terminally labelled whenever none of the nodes or edges are labelled by non-terminals. Clearly the property of being terminally labelled is preserved under isomorphism, so we can lift it to a property of abstract graphs. We can then define the language generated by a grammar as follows:

Definition 2.22. Given a **graph grammar** \mathbf{G} as defined above, we say that a graph G is **terminally labelled** iff $l(V) \cap \mathcal{N}_V = \emptyset$ and $m(E) \cap \mathcal{N}_E = \emptyset$. Thus, we can define the **graph language** generated by \mathbf{G} :

$$L(\mathbf{G}) = \{[G] \mid S \Rightarrow_{\mathcal{R}}^* G, G \text{ terminally labelled}\}$$

One can think of graph transformation systems in terms of grammars that define languages. If they are terminating, then membership testing is decidable, but in general, non-deterministic in the sense that a deterministic

algorithm must backtrack if it produces a normal form not equal to the start graph, to determine if another derivation sequence could have reached it. If the system is confluent too, then the algorithm becomes deterministic.

Definition 2.23 (Language Recognition). $T = (\mathcal{L}, \mathcal{R})$ recognises a language \mathbf{L} over $\mathcal{P} \subseteq \mathcal{L}$ iff $\exists[S] \in \mathbf{L}$ such that $\forall[G] \in \mathcal{G}^\oplus(\mathcal{P})$, $[G] \in \mathbf{L}$ iff $G \Rightarrow_{\mathcal{R}}^* S$.

Theorem 2.3 (Membership Test). Given a **grammar** $\mathbf{G} = (\mathcal{L}, \mathcal{N}, \mathcal{R}, S)$, $[G] \in \mathbf{L}(\mathbf{G})$ iff $G \Rightarrow_{\mathcal{R}^{-1}}^* S$ and G is terminally labelled. That is, $(\mathcal{L}, \mathcal{R}^{-1})$ recognises $\mathbf{L}(\mathbf{G})$ over $\mathcal{L} \setminus \mathcal{N}$.

Proof. The key point is that rules and derivations are invertible, which means that if S can be derived from G using the reverse rules, then G can be derived from S using the original rules so is in the language. If S cannot be derived from G , then G cannot be in the language since that would imply there was a derivation sequence from S to G which we could invert to give a contradiction. By construction, we only consider terminally labelled G . \square

Remark 2.8. If $T = (\mathcal{L}, \mathcal{R})$ recognizing a language \mathbf{L} is terminating, then membership testing for \mathbf{L} is decidable. Moreover, if T is also confluent, then recognition is efficient in the sense that we need not backtrack. The algorithm is simply to compute a normal form, and test if it is isomorphic to S .

Just like in Section 1.6, we can define the **induced ARS** of a GT system.

Definition 2.24. Let $T = (\mathcal{L}, \mathcal{R})$ be a **GT system**. Then $(\mathcal{G}^\oplus(\mathcal{L}), \rightarrow_{\mathcal{R}})$ is the **induced ARS** defined by $\forall[G], [H] \in \mathcal{G}^\oplus(\mathcal{L})$, $[G] \rightarrow_{\mathcal{R}} [H]$ iff $G \Rightarrow_{\mathcal{R}} H$. We may also use the notation \rightarrow_T in place of $\rightarrow_{\mathcal{R}}$ whenever the ambient label alphabet is not clear.

Lemma 2.6. Consider the **ARS** $(\mathcal{G}^\oplus(\mathcal{L}), \rightarrow_{\mathcal{R}})$ induced by a **GT system**. Then $\rightarrow_{\mathcal{R}}$ is a **binary relation** (Definition A.14) on $\mathcal{G}^\oplus(\mathcal{L})$. Moreover, it is **finitely branching** (Definition C.6) and **decidable** (Definition A.29).

Remark 2.9. This does not, in general, imply that $\rightarrow_{\mathcal{R}}^*$ is decidable. We say that T is **(locally) confluent (terminating)** iff its **induced ARS** is.

Lemma 2.7. A **GT system** is **terminating** iff there is a **monotone** (Definition A.27) embedding from the **induced ARS** into $(\mathbb{N}, >)$.

Proof. By Lemma 2.6, the induced ARS of a GT system is finitely branching, so the result follows from Lemma C.3. \square

When we were thinking about reversing the rules to produce a membership test, we were thinking about them as a computation device. There was an input graph, and output graph(s) (and possibly non-termination). We defined a semantic function in Example 1.8. We can do this again in our new setting.

Definition 2.25. Given $T = (\mathcal{L}, \mathcal{R})$, define **state space** $\Sigma = \mathcal{G}^\oplus(\mathcal{L}) \cup \{\perp\}$ and **induced ARS** $(\mathcal{G}^\oplus(\mathcal{L}), \rightarrow_{\mathcal{R}})$. Define the **semantic function** $f_T : \mathcal{G}^\oplus(\mathcal{L}) \rightarrow \mathcal{P}(\Sigma)$ by $f_T([G]) = \{[H] \mid [H] \text{ is a normal form of } [G] \text{ w.r.t. } \rightarrow_{\mathcal{R}} \cup \{\perp \mid \text{there is an infinite reduction sequence starting from } [G] \text{ w.r.t. } \rightarrow_{\mathcal{R}}\} \text{ and } f_T(\perp) = \{\perp\}\}$.

Proposition 2.5. Given $T = (\mathcal{L}, \mathcal{R})$, then $\forall [G] \in \mathcal{G}^\oplus(\mathcal{L}), |f_T([G])| \geq 1$. Moreover, if T is confluent and terminating, then $\forall [G] \in \mathcal{G}^\oplus(\mathcal{L}), |f_T(G)| = 1$.

Proposition 2.6. Given $T = (\mathcal{L}, \mathcal{R})$, in general it is undecidable if $[H] \in f_T([G])$ for any TLRG G, H , and also if $\perp \in f_T([G])$.

2.6 Equivalence of GT Systems

Building on the work from Section 2.4, we can ask when two graph transformations are equivalent, or rather, when they are distinct. We will give various notions of equivalence, and show there is a hierarchy of inclusion, as each notion is more and more general than the last.

Definition 2.26. Two **GT systems** $T_1 = (\mathcal{L}, \mathcal{R}_1), T_2 = (\mathcal{L}, \mathcal{R}_2)$ are:

1. **Isomorphic** ($T_1 \cong T_2$) iff their quotients (Definition A.21) under rule isomorphism (Definition 2.17) are equal ($\mathcal{R}_1/\cong = \mathcal{R}_2/\cong$);
2. **Normalisation equivalent** ($T_1 \simeq_N T_2$) iff their quotients under rule equivalence (Definition 2.18) are equal ($\mathcal{R}_1/\simeq = \mathcal{R}_2/\simeq$);
3. **Step-wise equivalent** ($T_1 \simeq_S T_2$) iff their **induced ARSs** (Definition 2.24) are equal ($\rightarrow_{T_1} = \rightarrow_{T_2}$);
4. **Semantically equivalent** ($T_1 \simeq_F T_2$) iff their **semantic functions** are equal ($f_{T_1} = f_{T_2}$).

Proposition 2.7. Each of the above notions are equivalences.

Remark 2.10. A way of looking at **step-wise equivalence** is to say that it is a formalisation of what it means to have **derivation compatibility** in the sense of Theorem 2.2.

Proposition 2.8. This notion of isomorphism gives rise to **abstract graph transformation systems** $[T]$ over some fixed label alphabet \mathcal{L} . Let $\mathcal{T}(\mathcal{L})$ denote the collection of all such classes. Then, $\mathcal{T}(\mathcal{L})$ is a **countable set**.

Remark 2.11. Clearly **isomorphism** and **normalisation equivalence** are well behaved. That is, it is **decidable** to check if two GT systems share the same class. The same is not true of **semantic equivalence**.

Theorem 2.4 (GT System Equivalence). GT system **isomorphism** is finer than **normalisation equivalence** is finer than **step-wise equivalence** is finer than **semantic equivalence**. That is, $T_1 \cong T_2$ implies $T_1 \simeq_N T_2$ implies $T_1 \simeq_S T_2$ implies $T_1 \simeq_F T_2$. Moreover, there exist GT systems in which the implication direction is strictly one-way.

Proof. Let T_1, T_2 be GT systems over some \mathcal{L} , with rule sets $\mathcal{R}_1, \mathcal{R}_2$. Within this proof, rules $r_1, r_2, r_3, r_4, r_5, r_6$ can be found in Figure 2.7.

Suppose $T_1 \cong T_2$. Then the \cong -classes of \mathcal{R}_1 correspond to those of \mathcal{R}_2 . Clearly, if we find the normal form of each class, then the correspondence between these classes of normal forms is preserved. So $T_1 \simeq_N T_2$. To see the inclusion is strict, consider the two systems $(\mathcal{L}, \{r_1\}), (\mathcal{L}, \{r_2\})$. They are non-isomorphic, but are normalisation equivalent.

Next suppose $T_1 \simeq_N T_2$. Then by Theorem 2.2, the choice of representative element from each class is irrelevant, that is, the derivations possible are identical. Now, since the \simeq_N -classes of \mathcal{R}_1 and \mathcal{R}_2 are identical, combining all possible derivations from the classes leaves us with identical possible derivations for each. Thus, it is immediate that the induced ARS is identical. To see the inclusion is strict, consider the two systems $(\mathcal{L}, \{r_3\}), (\mathcal{L}, \{r_3, r_4\})$. They are not normalisation equivalent, but are step-wise.

Finally, suppose $T_1 \simeq_S T_2$. Then the induced ARS relations $\rightarrow_{\mathcal{R}_1}, \rightarrow_{\mathcal{R}_2}$ are equal, so clearly $f_{T_1} = f_{T_2}$. To see the inclusion is strict, consider the two systems $(\mathcal{L}, \{r_5\}), (\mathcal{L}, \{r_6\})$ are not step-wise equivalent since r_5 is always applicable with no effect, but r_6 is also always applicable, adding a new node. They are, however, semantically equivalent since their semantic functions both evaluate to $\{\perp\}$ on all inputs.

Thus, we have shown each forward implication, and that there exist cases where the reverse implication is false. \square

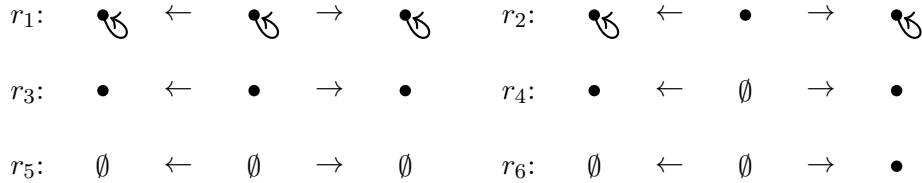

Figure 2.7: Example Rules Demonstrating Non-Equivalence

In general, we might be interested in more than proving just equivalence. That is, when does one GT system ‘refine’ the other. The (stepwise) refinement of programs was originally proposed by Dijkstra [73], [74] and Wirth [75]. Thinking in terms of GT systems, one may want to consider compatibility of the semantic function. Development of a refinement calculus that behaves properly with rooted GT systems remains open research.

Chapter 3

Fast Language Recognition

“Computer Science is no more about computers than astronomy is about telescopes.”

– Edsger W. Dijkstra, *Unknown source*

The Graph Matching Problem (Definition 1.6) and Rule Application Problem (Definition 1.7) can be considered in our setting. We will see that if we have an input graph with bounded degree (Definition E.7) and a bounded number of root nodes, and a finite set of ‘fast’ rules, then we can perform matching in constant time. Moreover, under mild constraints, for systems of fast rules, we need only analyse the derivation length to determine the time complexity of finding a normal form.

The language of all unlabelled trees is well-known to be expressible using classical graph transformation systems, using a single rule. The question of recognising trees ‘efficiently’ is less understood. We present a GT system that can test if a graph is a tree in linear time, given the input is of ‘bounded degree’: a new result for graph transformation systems. We also show that this can easily be adapted to recognise only full binary trees, and can be translated easily into GP 2.

Part of this chapter was presented at CALCO 2019 as part of a co-authored paper looking at linear time algorithms in GP 2 [22].

3.1 Complexity Theorems

We begin by defining the notion of a ‘fast’ rule. Intuitively, requiring every connected component of a rule to contain a root node is going to allow an implementation to both match each root node in the host graph in constant time, and then match the rest of the subgraphs around the root nodes quickly.

Definition 3.1. We call a rule $r = \langle L \leftarrow K \rightarrow R \rangle$ **fast** iff every connected component (Definition E.5) of L contains a root node. Additionally, we call a GT system **fast** iff all its rules are **fast**.

Just like in Lemma 1.2, we need to set up some assumptions about the complexity of various problems. We will assume that graphs are stored in a format such that the time complexities of various problems are as given in the table (Figure 3.1), based on Dodds' assumptions (Figure 1.5) [20]. In our model, we have root nodes specified explicitly with a rootedness function, so we have updated the table to reflect this. Moreover, we have made our assumptions as weak as possible to see the results we need. An additional advantage of our assumptions is that they are realistic even when the alphabet is not finite, such as in GP 2.

Input	Output	Time
label l	The set Z of rooted nodes with label l .	$O(Z)$
label l	The set Z of unrooted nodes with label l .	$O(V)$
node v	Values $\deg(v)$, $\text{indeg}(v)$, $\text{outdeg}(v)$.	$O(1)$
node v	Set X of edges with source v .	$O(X)$
node v	Set X of edges with target v .	$O(X)$
graph G	$ V_G $ and $ E_G $.	$O(1)$

Figure 3.1: Complexity Assumptions Table

Lemma 3.1. Given a **TLRG** G of **bounded degree** containing a **bounded** number of root nodes, and a **fast** rule r , then the GMP (Definition 1.6) requires $O(|r|)$ time and produces $O(|r|)$ matches.

Proof. Under the same assumption as in Dodds' Thesis [20, p. 39], this is easy to see, since there are only a constant number of subgraphs to consider. The full proof is a minor modification of Dodds' proof. The most notable difference is that in our model, root nodes are not encoded as a special label, rather, via the rootedness function. This is handled in our complexity assumptions table. Then, because we have a bounded number of root nodes in G , we can then, ultimately, conclude $O(|r|)$ time rather than $O(|V_G|)$ time. \square

Lemma 3.2. Given a **TLRG** G of **bounded degree**, a rule r , and an **injective match** g , then RAP (Definition 1.7) requires $O(|r|)$ time.

Proof. Obvious modifications of the proofs in Dodds' Thesis. \square

Definition 3.2. Define $\text{mx} : \mathcal{P}(\mathbb{N}) \rightarrow \mathbb{N}$ by $\text{mx}(\emptyset) = 0$ and $\text{mx}(S) = \max(S)$ where $S \neq \emptyset$. We can then define $\text{mx_deg}(G) = \text{mx}(\{\deg_G(v) \mid v \in V_G\})$.

Definition 3.3. Given an upper bound on the degree of nodes N and an upper bound on the number of root nodes M , a GT system $T = (\mathcal{L}, \mathcal{R})$ is:

1. **Bounded degree preserving** iff for all **TLRG** G, H such that $\text{mx_deg}(G) \leq N$, then $G \Rightarrow_{\mathcal{R}} H$ implies that $\text{mx_deg}(H) \leq N$;

2. **Bounded roots preserving** iff for all **TLRG** G, H such that $|p_G^{-1}(\{1\})| \leq M$, then $G \Rightarrow_{\mathcal{R}} H$ implies that $|p_H^{-1}(\{1\})| \leq M$.

Luckily, these properties can be easily statically checked by looking at the shape of the rules (Lemma 3.3).

Definition 3.4. Given an upper bound on the degree of nodes $N \in \mathbb{N}$, a rule $r = \langle L \leftarrow K \rightarrow R \rangle$ is:

1. **Bounded degree preserving** iff $\forall v \in (V_R \setminus V_K), \deg_R(v) \leq N$ and $\forall v \in V_K, \deg_R(v) \leq \deg_L(v)$;
2. **Bounded roots preserving** iff $|p_R^{-1}(\{1\})| \leq |p_L^{-1}(\{1\})|$.

Lemma 3.3. A GT system is **bounded degree preserving (bounded roots preserving)** iff every rule is **bounded degree preserving (bounded roots preserving)**.

Proof. The forwards direction can be seen by contradiction. Suppose that a rule were not preserving, then one could construct a graph where one could derive a graph of too large degree or too many root nodes. The reverse direction is obvious by Theorem 2.1 and Corollary 2.2. \square

Remark 3.1. Being **bounded degree preserving** does not mean that the maximum degree of a direct successor of a graph need be reduced, unlike for bounded root nodes. The rule that introduces a new node with a looped edge is **bounded degree preserving**, but one could imagine starting a derivation with the empty graph, then applying such a rule, taking the maximum degree of the graph from 0 to 1.

Theorem 3.1 (Fast Derivations). Given a **TLRG** G of **bounded degree** containing a **bounded** number of root nodes, and a **fast** GT system $T = (\mathcal{L}, \mathcal{R})$, then one can decide in **constant time** the **direct successors** (Definition C.3) of G , up to isomorphism.

Proof. Combine the above lemmas. There is a constant number of rules to apply. For each rule, a bounded number of matches are produced in constant time, and then the RAP takes constant time for each match. \square

Corollary 3.1 (Derivation-Complexity Lemma). Given G as above, and $T = (\mathcal{L}, \mathcal{R})$ a **fast, bounded degree preserving, bounded roots preserving, terminating** GT system with maximum derivation length $N \in \mathbb{N}$, then one can find a **normal form** (Definition C.3) of G in $O(N)$ time.

Proof. By induction, the application of a rule satisfying the stated conditions will preserve the bound on the number of root nodes and the bound on the degree of the nodes. Thus, we have the result. \square

Thus, we have shown that if we have a set of rules as per Corollary 3.1, we need only consider the maximum length of derivations when reasoning about time complexity, as mentioned at the end of Section 1.4.

3.2 Recognising Trees in Linear Time

A **tree** is a graph containing a node from which there is a unique **directed path** to each node in the graph (Proposition E.2). It is easy to see that it is possible to generate the collection of all trees by inductively adding new leaf nodes to the discrete graph of size one. That is, the language of all unlabelled trees can be specified by DPO-based graph grammar. The question of ‘efficient’ recognition of trees is less understood. In this section, we will show that it is possible to recognise the collection of all unlabelled trees in linear time. Moreover, at the end of the chapter, we will give an implementation of the algorithm in GP 2, providing empirical evidence of the linear run time.

Writing a graph grammar that generates all unlabelled trees is straightforward. Simply start with the trivial tree (a single node), and arbitrarily add edges pointing to a new node, away from this start node.

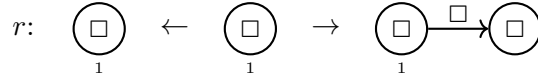

Figure 3.2: Tree Grammar Rules

Example 3.1 (Tree Grammar). Let $\mathbf{TREE} = (\mathcal{L}, \mathcal{N}, S, \mathcal{R})$ where:

1. $\mathcal{L} = (\{\square\}, \{\square\})$ where \square denotes the empty label;
2. $\mathcal{N} = (\emptyset, \emptyset)$;
3. S be the graph with a single node labelled with \square ;
4. $\mathcal{R} = \{r\}$.

To see that this grammar generates the set of all trees, we must show that every graph in the language is a tree, and then that every tree is in the language. This is easy to see by induction. \triangle

Notice how the above construction has given us a decision procedure for testing if $[G] \in \mathbf{L}(\mathbf{TREE})$:

Lemma 3.4. The GT system $(\{\square\}, \{\square\}, \{r^{-1}\})$ recognises $\mathbf{L}(\mathbf{TREE})$, in the sense of Definition 2.23. That is, $[G] \in \mathbf{L}(\mathbf{TREE})$ iff $G \Rightarrow_{r^{-1}} S$. Moreover, the system is confluent and terminating.

Proof. We first must comment that we are considering the GT system as a classical system as in Appendix D, without root nodes. As such, we must adjust Definition 2.23 accordingly. Now, by Theorem 2.3 (also adjusted accordingly), it is immediate that the GT system recognises the language of trees. To see that it is terminating is easy, since each rule is size reducing. Finally, local confluence can be seen via critical pair analysis (Section D.7) since there are no ‘critical pairs’. Thus, by Newman’s Lemma (Theorem C.3), the system is confluent. \square

While the algorithm may be fast in the sense that we need not backtrack, the process of finding a match at each derivation step is slow, since we must consider the entire host graph when finding a match. Next, we will see that rooted graph transformation rules can actually recognise trees in linear time.

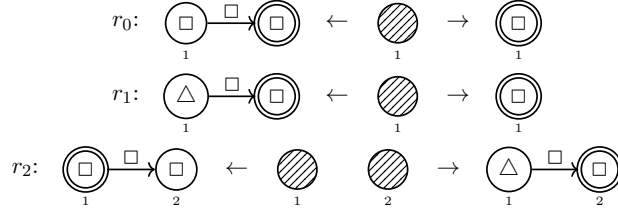

Figure 3.3: Tree Recognition Rules

Let $\mathcal{L} = (\{\square, \triangle\}, \{\square\})$, and $\mathcal{R} = \{r_0, r_1, r_2\}$. We are going to show that \mathcal{R} induces a linear time algorithm for testing if a graph is a tree. Intuitively, this works by pushing a special node (a ‘root’ node) to the bottom of a branch, and then pruning. If we start with a tree and run this until we cannot do it anymore, we must be left with a single node. The triangle labels are necessary so that, in the case that the input graph is not a tree, we could ‘get stuck’ in a directed cycle.

Example 3.2. Figure 3.4 shows a reduction of a tree and non-trees. Note, in particular, how the triangles prevent an infinite sequence of derivations moving the root node around the 3-cycle. \triangle

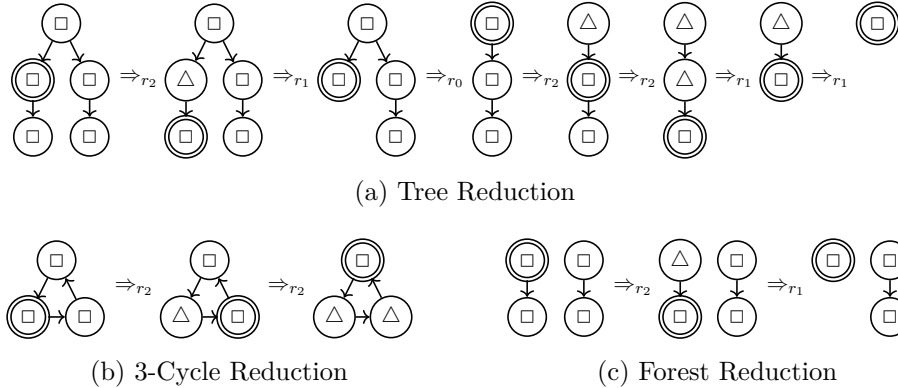

Figure 3.4: Example Reductions

Definition 3.5. Given a graph G , we define G^\ominus to be exactly G , but with every node unrooted, and everything labelled by \square . That is:

$$G^\ominus = (V_G, E_G, s_G, t_G, V_G \times \{\square\}, E_G \times \{\square\}, V_G \times \{0\}).$$

For the rest of this section, by ‘input graph’, we mean any TLRG containing exactly one ‘root’ node, with edges and vertices all labelled \square . By ‘input tree’, we mean an ‘input graph’ that is also a tree (Definition E.9). Next, we show some technical lemmata, giving names to the results that are directly used in our proof of main result (Theorem 3.2).

Lemma 3.5 (Tree Termination). The system $(\mathcal{L}, \mathcal{R})$ is terminating. Moreover, derivations have length at most $2|V_G|$.

Proof. Let $\#G = |V_G|$, $\square G = |\{v \in V_G \mid l_G(v) = \square\}|$, for any TLRG G . If $G \Rightarrow_{r_0} H$ or $G \Rightarrow_{r_1} H$, then $\#G > \#H$ and $\square G > \square H$. If $G \Rightarrow_{r_2} H$ then $\#G = \#H$ and $\square G > \square H$. Thus, termination follows from Lemma 2.7, since $\varphi([G]) = \#G$ is a monotone embedding into $(\mathbb{N}, >)$. To see the last part, notice that $\square G \leq \#G$ for all TLRGs G , so the result is immediate since there are only $2\#G$ natural numbers less than $2\#G$. \square

Lemma 3.6. If G is a tree and $G \Rightarrow_{\mathcal{R}} H$, then H is a tree. If G is not a tree and $G \Rightarrow_{\mathcal{R}} H$, then H is not a tree.

Proof. Clearly, the application of r_2 preserves structure. Suppose G is a tree. r_0 or r_1 are applicable iff node 2 is matched against a leaf node due to the dangling condition. Upon application, the leaf node and its incoming edge is removed. Clearly the result graph is still a tree.

If G is not a tree and one of r_0 or r_1 is applicable, then we can see the properties of not being a tree are preserved. That is, if G is not connected, H is certainly not connected. If G had parallel edges, due to the dangling condition, they must exist in $G \setminus g(L)$, so H has parallel edges. Similarly, cycles are preserved. Finally, if G had a node with incoming degree greater than one, then H must too, since the node in G that is deleted in H had incoming degree one, and the degree of all other nodes is preserved. \square

Corollary 3.2 (Tree Preservation). If G is an input graph and $G \Rightarrow_{\mathcal{R}}^* H$, then G is a tree iff H is a tree.

Proof. Induction. \square

Lemma 3.7. The system $(\mathcal{L}, \mathcal{R})$ preserves the number of root nodes in graphs. That is, if $G \Rightarrow_{\mathcal{R}}^* H$, then $|p_G^{-1}(\{1\})| = |p_H^{-1}(\{1\})|$.

Proof. Each of the rules r_0, r_1, r_2 preserves the number of roots, so by Corollary 2.2, the number of root nodes is invariant across rule applications. Thus, the result holds by induction on derivation length. \square

Corollary 3.3. If G is an input graph and $G \Rightarrow_{\mathcal{R}}^* H$, then H has exactly one root node. Moreover, there is no derivation sequence that derives the empty graph.

Proof. The first part follows from Lemma 3.7 since input graphs have exactly one root node. To see that the empty graph cannot be derived, notice that each derivation reduces $\#G$ by at most one, and no rules are applicable when $\#G = 1$. \square

Remark 3.2. In Bak and Plump's model (and hence GP 2), Corollary 3.3 is still true, however a more direct proof is needed. Since the root node in the LHS of each rule must be matched against a root node in the host graph, so the other non-roots can only be matched against non-roots.

Lemma 3.8. If G is an input graph and $G \Rightarrow_{\mathcal{R}}^* H$. Then, every Δ -node in H either has a child Δ -node or a root-node child.

Proof. Clearly G satisfies this, as there are no Δ -nodes. We now proceed by induction. Suppose $G \Rightarrow_{\mathcal{R}}^* H \Rightarrow_{\mathcal{R}} H'$ where H satisfies the condition. If r_0 or r_1 is applicable, we introduce no new Δ -nodes. Additionally, in the case of r_1 , any Δ -node parents of the image 1 are preserved. So H' satisfies the condition. Finally, if r_2 is applied, then the new Δ -node has a root-node child, and the Δ -nodes in $H' \setminus h(R)$ have the same children, so H' satisfies the condition. \square

Corollary 3.4. Let G be an input tree and $G \Rightarrow_{\mathcal{R}}^* H$. Then the root-node in H has no Δ -node children.

Proof. By Corollary 3.3, H has exactly one root node, and by Lemma 3.8, all chains of Δ -nodes terminate with a root-node. If said root-node were to have a Δ -node child, then we would have a cycle, which contradicts that H is a tree (Corollary 3.2). \square

Lemma 3.9 (Tree Progress). Let G be an input tree and $G \Rightarrow_{\mathcal{R}}^* H$. Then, either $|V_H| = 1$ or H is not in normal form.

Proof. By Corollary 3.3, $|V_H| \geq 1$. If $|V_G| = 1$, then G is in normal form. Otherwise, either the root node has no children, or it has at least one \square -child. In the first case, r_0 must be applicable, and in the second, r_2 .

Suppose $G \Rightarrow_{\mathcal{R}}^* H$. If $|V_H| = 1$, then H is in normal form by the proof to Corollary 3.3. Otherwise, by Corollary 3.2 H is a tree and $|V_H| > 1$. Now, the root-node in H (Corollary 3.3) must have a non-empty neighbourhood. If it has no children, then r_0 or r_1 must be applicable. Otherwise, r_2 must be applicable, since by Corollary 3.4, there must be a \square -node child. So H is not in normal form. \square

We now present the main result of this chapter:

Theorem 3.2 (Tree Recognition). Given an input graph G , one may use the system $(\mathcal{L}, \mathcal{R})$ from G to find a normal form for G , say H . H is the single root-node graph labelled by \square iff $[G^\ominus] \in \mathbf{L}(\mathbf{TREE})$. Moreover, for input graphs of bounded degree, we terminate in linear time.

Proof. By Lemma 3.5, our system is terminating and derivations have maximum length $2\#G$. By Corollary 3.2 and Lemma 3.9, G is a tree iff we can derive the singleton tree without backtracking. Finally, by Corollary 3.1, the algorithm terminates in linear time, since our ruleset satisfies the necessary conditions. \square

We will return to this example in Section 5.4, where we see that the system is actually not confluent! We will show, however, that it is confluent ‘up to garbage’ on a class containing the ‘input trees’.

3.3 Recognising Full Binary Trees

In the previous section, we gave a grammar defining the language of all unlabelled trees, and showed that it was possible to adapt it to efficiently recognise the language by using a ‘root’ node. In this section, we will show that this technique can be adapted to recognise the language of all unlabelled full binary trees (Definition E.9) in linear time.

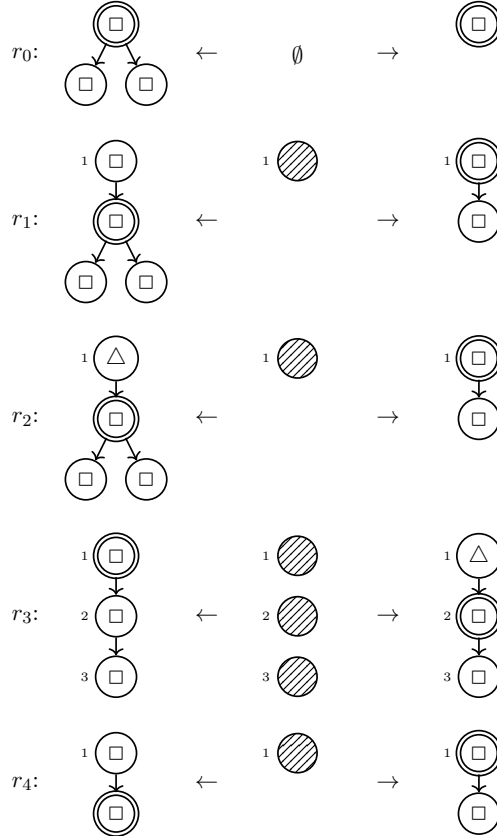

Figure 3.5: Full Binary Tree Rules

Let $\mathcal{L} = (\{\square, \triangle\}, \{\square\})$, and $\mathcal{R} = \{r_0, r_1, r_2, r_3, r_4\}$. We are going to show that \mathcal{R} induces a linear time algorithm for testing if a graph is a full binary tree (FBT). Intuitively, this works in a similar way to the reduction for trees, with the major difference that we only ‘prune’ (r_0, r_1, r_2) whenever the root is in a position where it has exactly two children who are themselves leaf nodes. Rules r_3, r_4 ensure that we can always prune, so that we only get stuck in the case that our input was not a full binary tree. Similarly to the previous system for trees, the triangle labels are necessary so that, in the case that the input graph is not a tree, we could ‘get stuck’ in a directed cycle.

For the rest of this section, by ‘input graph’, we mean any TLRG containing exactly one ‘root’ node, with edges and vertices all labelled \square . By ‘input FBT’,

we mean an ‘input graph’ that is also a FBT. The proof of complexity and correctness is similar to the previous system, so we won’t give all the detail.

Theorem 3.3 (FBT Recognition). Given an input graph G , one may use the system $(\mathcal{L}, \mathcal{R})$ from G to find a normal form for G , say H . H is the single root-node graph labelled by \square iff G^\ominus is an unlabelled FBT. Moreover, for input graphs of bounded degree, we terminate in linear time.

Proof. The linear derivation length comes from the fact that if r_0 appears in a derivation sequence from an input graph, then it must be the last derivation, and it must derive a normal form. Moreover, if r_5 appears in a derivation sequence, then it must appear at the only at the very start of a derivation sequence from an input graph. The remaining r_1, r_2, r_3 must appear in the middle of an derivation sequence from an input graph, at most a linear number of times. All of the rules in our GT system are of the form such that Corollary 3.1 can be applied, so we can conclude linear time complexity.

For correctness, one must show the analogous results to Corollary 3.2 and Lemma 3.9. That is, that FBTs derive only FBTs, and non-FBTs derive only non-FBTs, and that progress is always made, given an input FBT, until we reach the singleton FBT. The proof detail is not dissimilar from the existing proofs for trees, once one has taken care of the existing observations we have made about the location of rules r_0 and r_5 in derivation sequences starting from an input graph. \square

3.4 Recognising Trees in GP 2

Our algorithm from Section 3.2 can be implemented in GP 2. The program (Figure 3.6) expects an arbitrary labelled input graph with every node coloured grey, no ‘root’ nodes, and no additional ‘marks’. It will fail iff the input is not a tree. Given an input graph of bounded degree, it will always terminate in linear time with respect to (w.r.t.) the number of nodes in the input graph.

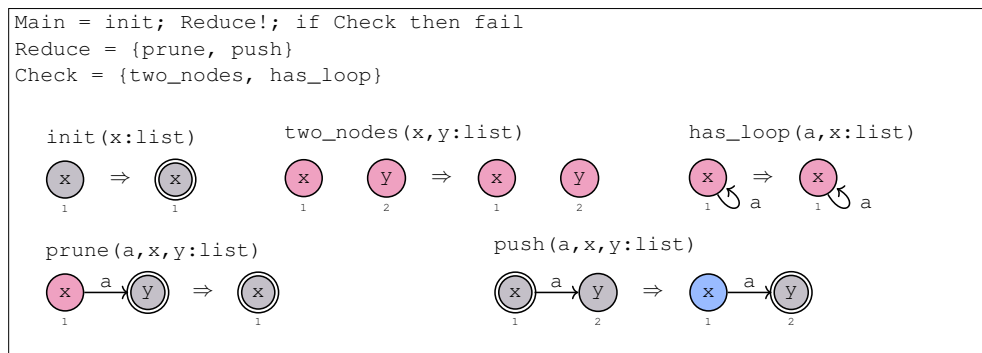

Figure 3.6: GP 2 Implementation

To see that the program is correct follows mostly from our existing proofs. Grey nodes encode the \square label, and blue nodes, \triangle . The ‘init’ rule will fail if the input graph is empty, otherwise, it will make exactly one node rooted, in at most linear time. The ‘Reduce!’ step is then exactly our previous GT system, which we have shown to be correct, and terminates in linear time. Finally, the ‘Check’ step checks for garbage in linear time. There is no need to check the host graph is not equal to the empty graph (Corollary 3.3).

We have performed empirical benchmarking to verify the complexity of the program, testing it with linked lists, binary trees, grid graphs, and star graphs (Figure 3.7). Formal definitions of each of these graph classes can be found in Section E.2. We have exclusively used ‘perfect’ binary trees, and ‘square’ grid graphs in our testing.

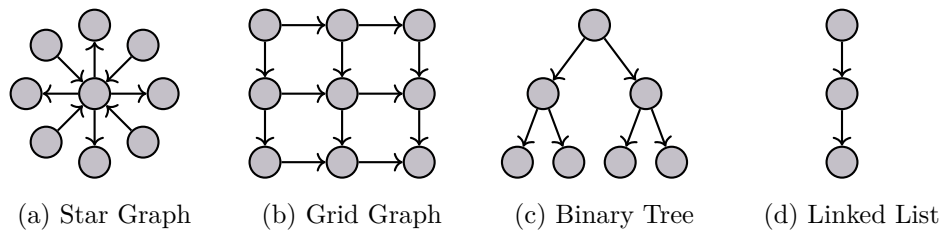

Figure 3.7: Graph Classes

Star Graphs are not of bounded degree, so we saw quadratic time complexity as expected. The other graphs are of bounded degree, thus we observed linear time complexity (Figure 3.8).

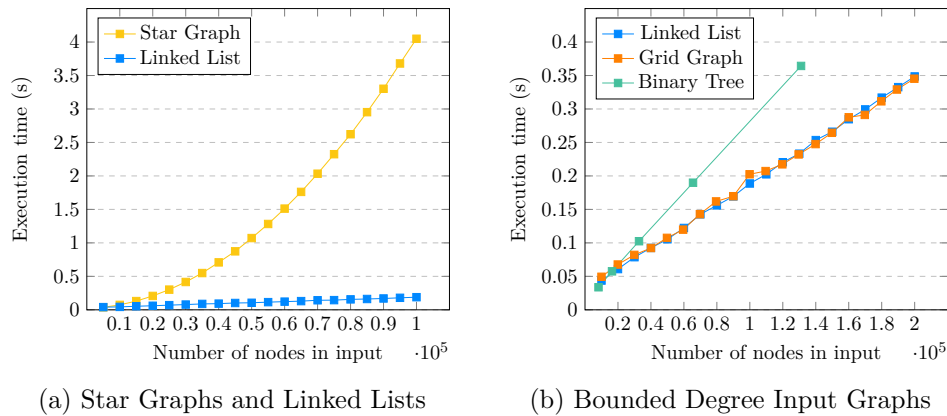

Figure 3.8: Measured Performance

We thus have empirical evidence, that in some sense, our complexity assumptions must be realistic, and that our proofs are not contradicted by the results. It remains future work to formalise complexity, in general, for GP 2.

Chapter 4

Confluence Analysis I

“Beware of bugs in the above code; I have only proved it correct, not tried it.”

– Donald Knuth, *Notes on the van Emde Boas construction of priority deques: An instructive use of recursion (1977)*

Efficient testing of language membership is an important problem in graph transformation [15], [76], [77]. Our GT system for testing if a graph is a tree is actually not confluent, but if the input is a tree, then it has exactly one normal form, so it was in some sense confluent. We can formalise this with the new notion of ‘confluence up to garbage’.

4.1 Definitions and Closedness

In this section, we shall be working with standard GT systems, as defined in Appendix D, but without relabelling. That is, all graphs are totally labelled, including interface graphs. All the results in this section will actually generalise to systems with relabelling, or the systems defined in Chapter 2.

Definition 4.1. Let $T = (\mathcal{L}, \mathcal{R})$ be a GT system, and $\mathbf{D} \subseteq \mathcal{G}(\mathcal{L})$ be a set of abstract graphs. Then, a graph G is called **garbage** iff $[G] \notin \mathbf{D}$.

Definition 4.2. Let $T = (\mathcal{L}, \mathcal{R})$, and $\mathbf{D} \subseteq \mathcal{G}(\mathcal{L})$. \mathbf{D} is **closed** under T iff for all G, H such that $G \Rightarrow_{\mathcal{R}} H$, if $[G] \in \mathbf{D}$ then $[H] \in \mathbf{D}$. \mathbf{D} is **strongly closed** under T iff we have $[G] \in \mathbf{D}$ iff $[H] \in \mathbf{D}$.

This set of abstract graphs \mathbf{D} represents the ‘good input’, and the ‘garbage’ is the graphs that are not in this set. \mathbf{D} need not be explicitly generated by a graph grammar. For example, it could be defined by some (monadic second-order [78]) logical formula.

There are a couple of immediately obvious results:

Proposition 4.1. Strong closedness \Rightarrow closedness.

Proposition 4.2. Given $\mathbf{D} \subseteq \mathcal{G}(\mathcal{L})$ closed under $T = (\mathcal{L}, \mathcal{R})$, then for all graphs G, H such that $G \Rightarrow_{\mathcal{R}}^* H$, if $[G] \in \mathbf{D}$, then $[H] \in \mathbf{D}$.

Example 4.1. Consider the reduction rules in Figure 4.1. The language of acyclic graphs is **closed** under the GT system $((\{\square\}, \{\square\}), \{r_1\})$, and the language of trees (forests) is **strongly closed** under $((\{\square\}, \{\square\}), \{r_2\})$. \triangle



Figure 4.1: Example Reduction Rules

We can now define **(local) confluence up to garbage**, allowing us to say that, ignoring the garbage graphs, a system is **(locally) confluent**. Note that we previously called this property **(local) confluence modulo garbage**, however we have decided this name was confusing because we are not interested in confluence ‘modulo’ an equivalence relation. Rather, we are just choosing to ignore certain start graphs.

Definition 4.3. Let $T = (\mathcal{L}, \mathcal{R})$, $\mathbf{D} \subseteq \mathcal{G}(\mathcal{L})$. If for all graphs G, H_1, H_2 , such that $[G] \in \mathbf{D}$, if $H_1 \Leftarrow_{\mathcal{R}} G \Rightarrow_{\mathcal{R}} H_2$ implies that H_1, H_2 are **joinable**, then T is **locally confluent** on \mathbf{D} (or **locally confluent up to garbage** w.r.t. \mathbf{D}).

Definition 4.4. Let $T = (\mathcal{L}, \mathcal{R})$, $\mathbf{D} \subseteq \mathcal{G}(\mathcal{L})$. If for all graphs G, H_1, H_2 , such that $[G] \in \mathbf{D}$, if $H_1 \Leftarrow_{\mathcal{R}}^* G \Rightarrow_{\mathcal{R}}^* H_2$ implies that H_1, H_2 are **joinable**, then T is **confluent** on \mathbf{D} (or **confluent up to garbage** w.r.t. \mathbf{D}).

Definition 4.5. Let $T = (\mathcal{L}, \mathcal{R})$, $\mathbf{D} \subseteq \mathcal{G}(\mathcal{L})$. If there is no infinite derivation sequence $G_0 \Rightarrow_{\mathcal{R}} G_1 \Rightarrow_{\mathcal{R}} G_2 \Rightarrow_{\mathcal{R}} \dots$ such that $[G_0] \in \mathbf{D}$, then T is **terminating** on \mathbf{D} (or **terminating up to garbage** w.r.t. \mathbf{D}).

Lemma 4.1. Let $T = (\mathcal{L}, \mathcal{R})$, $\mathbf{D} \subseteq \mathcal{G}(\mathcal{L})$, $\mathbf{E} \subseteq \mathbf{D}$. Then **(local) confluence (termination)** on \mathbf{D} implies **(local) confluence (termination)** on \mathbf{E} .

Proof. Immediate consequence of set inclusion! \square

Corollary 4.1. Let $T = (\mathcal{L}, \mathcal{R})$, $\mathbf{D} \subseteq \mathcal{G}(\mathcal{L})$. Then **(local) confluence (termination)** implies **(local) confluence (termination)** on \mathbf{D} .

Proof. Local confluence (confluence, termination) is exactly local confluence (confluence, termination) on $\mathcal{G}(\mathcal{L})$. \square

Example 4.2. Looking again at r_1 and r_2 from our first example, it is easy to see that r_1 is in fact **terminating** and **confluent up to garbage** on the language of acyclic graphs. Similarly, r_2 is **terminating** and **confluent up to garbage** on the language of trees. \triangle

Lemma 4.2. Let $T = (\mathcal{L}, \mathcal{R})$, $\mathbf{D} \subseteq \mathcal{G}(\mathcal{L})$. Then, if \mathbf{D} is **closed** under T , the **induced ARS** $(\mathbf{D}, \rightarrow)$ where $[G] \rightarrow [H]$ iff $G \Rightarrow_{\mathcal{R}} H$, is closed and well-defined. Moreover, it is **(locally) confluent (terminating)** whenever T is, **up to garbage** with respect to \mathbf{D} .

Proof. Since \mathbf{D} is closed under T , by Proposition 4.2, the induced ARS $(\mathbf{D}, \rightarrow)$ where $[G] \rightarrow [H]$ iff $G \Rightarrow_{\mathcal{R}} H$ is closed, and clearly it is well-defined due to the uniqueness of derivations up to isomorphism. Clearly this induced ARS is (locally) confluent (terminating) if T is (locally) confluent (terminating) up to garbage with respect to \mathbf{D} . \square

Definition 4.6 (Closedness Problem).

Input: A GT system $T = (\mathcal{L}, \mathcal{R})$ and a graph grammar \mathbf{G} over \mathcal{L} .

Question: Is $L(\mathbf{G})$ is **closed** under T ?

Theorem 4.1 (Undecidable Closedness). The **closedness problem** is **undecidable** in general, even for terminating GT systems T with only one rule, and \mathbf{G} an edge replacement grammar (Section D.9).

Proof. This was shown in 1998 by Fradet and Le Métayer [79]. \square

Remark 4.1. Closedness and language recognition has actually been considered before by Bakewell, Plump, and Runciman, in the context of languages specified by reduction systems without non-terminals [80], [81].

Theorem 4.2 (Newman-Garbage Lemma). Let $T = (\mathcal{L}, \mathcal{R})$, $\mathbf{D} \subseteq \mathcal{G}(\mathcal{L})$. If T is **terminating** on \mathbf{D} and \mathbf{D} is **closed** under T , then it is **confluent** on \mathbf{D} iff it is **locally confluent** on \mathbf{D} .

Proof. By Lemma 4.2, the induced ARS $(\mathbf{D}, \rightarrow)$ is well-defined, closed, and terminating. Thus, by the original Newman's Lemma (Theorem C.3), the induced ARS is confluent iff it is locally confluent, as required. \square

The requirement of closure is reasonable, even in the presence of termination on all graphs. Of course, there exists systems that are both locally confluent up to garbage and terminating confluent up to garbage, which are not closed, but are confluent up to garbage, as in Example 4.3.

Example 4.3. Choose some \mathbf{D} of size at least 2, and a graph G which has a non-isomorphic successor under some GT system T . Suppose \mathbf{D} is closed under T , T locally confluent and T terminating on \mathbf{D} . Then construct $\mathbf{E} = \mathbf{D} \setminus \{[H]\}$ where $H \not\cong G$ is a successor of G under T . Then, T is locally confluent and terminating on \mathbf{E} , but not closed. \triangle

However, in general, closure is needed. In Example 4.4, we show a system that is locally confluent up to garbage and terminating, yet is not confluent up to garbage.

Example 4.4. Let $\mathcal{L} = (\{\square\}, \{\square\})$ and $\mathcal{R} = \{r_0, r_1, r_2, r_3\}$, where the rules are given in Figure 4.2. Let $\mathbf{D} = \mathbf{L}(\mathbf{TREE})$ from Section 3.2.

Then, $(\mathcal{L}, \mathcal{R})$ is locally confluent on \mathbf{D} and terminating on $\mathcal{G}(\mathcal{L})$, however is not confluent on \mathbf{D} ! This was possible because we are not closed on \mathbf{D} . An example non-joinable pair is given in Figure 4.3, generated by moving three steps away from the start graph. In our diagrams, unlabelled edges are understood to be \square -labelled. \triangle

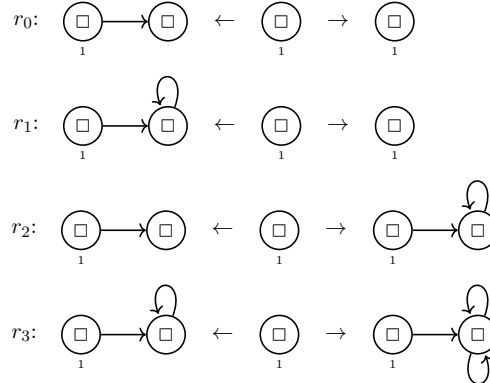

Figure 4.2: Example Non-Closed Rules

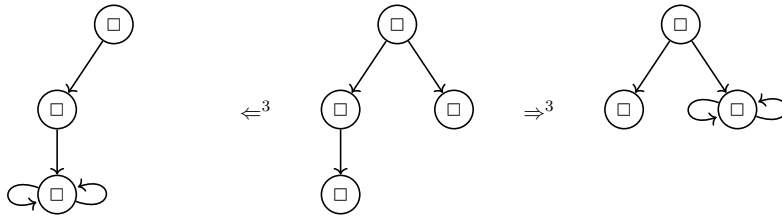

Figure 4.3: Example Non-Joinable Pair

In this section, we have defined garbage, (local) confluence (termination) up to garbage, and closedness. We have shown that if we have closedness and termination up to garbage, then local confluence up to garbage implies confluence up to garbage, and an example where not having closedness fails, even in the presence of termination. Moreover, we have shown that closedness is undecidable in general.

4.2 Non-Garbage Critical Pairs

In 1970, Knuth and Bendix showed that confluence checking of terminating term rewriting systems is decidable [46]. Moreover, it suffices to compute all ‘critical pairs’ and check their joinability [47]–[49]. Unfortunately, for (terminating) graph transformation systems, confluence is not decidable (Theorem 1.1), and joinability of critical pairs does not imply local confluence. In 1993,

Plump showed that ‘strong joinability’ of all critical pairs is sufficient but not necessary to show local confluence [16], [45]. We have summarised these results in Section D.7.

We would like to generalise Theorem D.7 to allow us to determine when we have local confluence up to garbage. For this, we need to define a notion of subgraph closure and non-garbage critical pairs. In this section, we shall be working with standard GT systems, as defined in Appendix D, but without relabelling. That is, all graphs are totally labelled, including interface graphs.

Definition 4.7. Let $\mathbf{D} \subseteq \mathcal{G}(\mathcal{L})$ be a set of abstract graphs. Then \mathbf{D} is **subgraph closed** iff for all graphs G, H , such that $H \subseteq G$, if $[G] \in \mathbf{D}$, then $[H] \in \mathbf{D}$. The **subgraph closure** of \mathbf{D} , denoted $\bar{\mathbf{D}}$, is the smallest set containing \mathbf{D} that is **subgraph closed**.

Proposition 4.3. Given $\mathbf{D} \subseteq \mathcal{G}(\mathcal{L})$, $\bar{\mathbf{D}}$ always **exists**, and is **unique**. Moreover, $\mathbf{D} = \bar{\mathbf{D}}$ iff \mathbf{D} is **subgraph closed**.

Proof. The key observations are that the subgraph relation is transitive, and each graph has only finitely many subgraphs. Clearly, the smallest possible set containing \mathbf{D} is just the union of all subgraphs of the elements of \mathbf{D} , up to isomorphism. This is the unique subgraph closure of \mathbf{D} . \square

Remark 4.2. $\bar{\mathbf{D}}$ always exists, however it need not be decidable, even when \mathbf{D} is! It is not obvious what conditions on \mathbf{D} ensure that $\bar{\mathbf{D}}$ is decidable. Interestingly, the classes of regular and context-free string languages are actually closed under substring closure [82].

Example 4.5. \emptyset and $\mathcal{G}(\mathcal{L})$ are subgraph closed. \triangle

Example 4.6. The language of discrete graphs is subgraph closed. \triangle

Example 4.7. The subgraph closure of the language of trees is the language of forests. The subgraph closure of the language connected graphs is the language of all graphs. \triangle

Definition 4.8. Let $T = (\mathcal{L}, \mathcal{R})$, $\mathbf{D} \subseteq \mathcal{G}(\mathcal{L})$. A **critical pair** (Definition D.31) $H_1 \leftarrow G \Rightarrow H_2$ is **non-garbage** iff $[G] \in \bar{\mathbf{D}}$.

Lemma 4.3. Given a GT system $T = (\mathcal{L}, \mathcal{R})$ and $\mathbf{D} \subseteq \mathcal{G}(\mathcal{L})$, then there are only finitely many **non-garbage critical pairs** up to isomorphism.

Proof. By Theorem D.7 and Lemma D.3, there are only finitely many critical pairs for T , up to isomorphism, and there exists a terminating procedure for generating them. Thus, there are only finitely many non-garbage critical pairs up to isomorphism. \square

Corollary 4.2. Given a GT system $T = (\mathcal{L}, \mathcal{R})$ and $\mathbf{D} \subseteq \mathcal{G}(\mathcal{L})$ such that $\bar{\mathbf{D}}$ is **decidable**, then one can find the finitely many **non-garbage critical pairs** in **finite time**.

Proof. By Lemma 4.3, we have only finitely many pairs to consider, and we can generate them in finite time. Since \bar{D} has a computable membership function, we can test if the start graph in each pair is garbage in finite time. \square

Corollary 4.3. Let $T = (\mathcal{L}, \mathcal{R})$, $D \subseteq \mathcal{G}(\mathcal{L})$ be such that T is **terminating** on D and \bar{D} is **decidable**. Then, one can **decide** if all the **non-garbage critical pairs** are **strongly joinable** (Definition D.34).

Proof. By Corollary 4.2, we can find the finitely many pairs in finite time, and since T is terminating on D and finitely branching (Lemma 1.1), both sides of each pair have only finitely many successors (Lemma C.1), thus we can test for strong joinability in finite time. \square

Lemma 4.4. Let $T = (\mathcal{L}, \mathcal{R})$, $D \subseteq \mathcal{G}(\mathcal{L})$. Then, the **non-garbage critical pairs** are **complete**. That is, for each pair of **parallelly independent** (Definition D.30) direct derivations, $H_1 \leftarrow_{r_1, g_1} G \Rightarrow_{r_2, g_2} H_2$ such that $[G] \in D$, there is a **critical pair** $P_1 \leftarrow_{r_1, o_1} K \Rightarrow_{r_2, o_2} P_2$ with extension diagrams (1), (2), and an inclusion morphism $m : K \rightarrow G$.

$$\begin{array}{ccccc}
 P_1 & \longleftarrow & K & \Longrightarrow & P_2 \\
 \downarrow & (1) & \downarrow & (2) & \downarrow \\
 H_1 & \longleftarrow & G & \Longrightarrow & H_2
 \end{array}$$

Figure 4.4: Pair Factorisation Diagram

Proof. By Lemma 6.22 in [5], critical pairs are complete when $D = \mathcal{G}(\mathcal{L})$. If we only consider derivations from start graphs G such that $[G] \in D \subseteq \mathcal{G}(\mathcal{L})$, clearly all factorings with critical pairs are such that K can be embedded into G , so $[K] \in \bar{D}$. Thus, the non-garbage critical pairs are complete. \square

Theorem 4.3 (Non-Garbage Critical Pair Lemma). Let $T = (\mathcal{L}, \mathcal{R})$, $D \subseteq \mathcal{G}(\mathcal{L})$. If all its **non-garbage critical pairs** are **strongly joinable**, then T is **locally confluent** on D .

Proof. By the proof of Theorem 6.28 in [5], strong joinability of critical pairs implies local confluence due to completeness. But, the non-garbage critical pairs are complete with respect to D , so we have the result. \square

Corollary 4.4. Let $T = (\mathcal{L}, \mathcal{R})$, $D \subseteq \mathcal{G}(\mathcal{L})$. If T is **terminating** on D , D is **closed** under T , and all T 's **non-garbage critical pairs** are **strongly joinable** then T is **confluent** on D .

Proof. By the above theorem, T is **locally confluent up to garbage**, so by the Newman-Garbage Lemma (Theorem 4.2), T is **confluent up to garbage** as required. \square

Remark 4.3. Obviously, testing for local confluence up to garbage is undecidable in general, even when \bar{D} is decidable and the system is terminating and strongly closed. What is remarkable though, is that confluence up to garbage is actually undecidable general for a terminating non-length-increasing string rewriting systems and D a regular string language [83]!

4.3 Extended Flow Diagrams

In 1976, Farrow, Kennedy and Zuconci presented **semi-structured flow graphs**, defining a grammar with confluent reduction rules [23]. Plump has considered a restricted version of this language: **extended flow diagrams** (EFDs) [45]. The reduction rules for **extended flow diagrams** efficiently recognise the EFDs, despite not being confluent. That is, we have an efficient mechanism for testing for language membership, since we need not ‘backtrack’, just like in Theorem 3.2.

Definition 4.9 (Efficient Recognition). $T = (\mathcal{L}, \mathcal{R})$ **efficiently recognises** L over $\mathcal{P} \subseteq \mathcal{L}$ iff T recognises L , T is terminating, and T is confluent on L .

Theorem 4.4 (Efficient Recognition Correctness). Given an GT system $T = (\mathcal{L}, \mathcal{R})$ **efficiently recognising** a language L over $\mathcal{P} \subseteq \mathcal{L}$ and an input graph G over \mathcal{P} , the following algorithm is correct: Compute a normal form of G by deriving successor graphs using T as long as possible. If the result graph is isomorphic to S , the input graph is in the language. Otherwise, the graph is not in the language.

Proof. Suppose G is not L . Then, since T is terminating our algorithm must be able to find a normal form of G , say H , and because T recognises L , it must be the case that H is not isomorphic to S , and so the algorithm correctly decides that G is not in L .

Now, suppose that G is in L . Then, because T is terminating, as before, we must be able to derive some normal form, H . But then, since T is both confluent on L and recognises L , it must be the case that H is isomorphic to S , and so the algorithm correctly decides that G is in L . \square

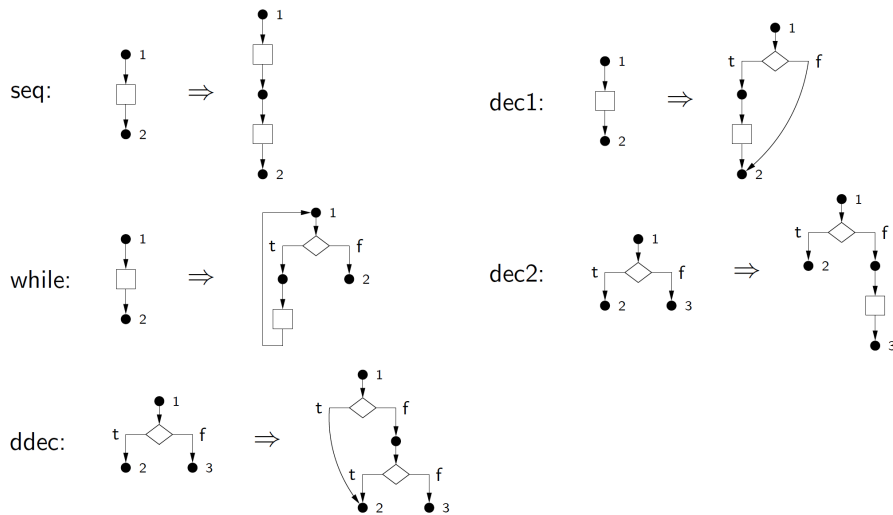

Figure 4.5: EFD Grammar Rules

Definition 4.10. The language of **extended flow diagrams** is generated by $\mathbf{EFD} = (\mathcal{L}, \mathcal{N}, \mathcal{R}, S)$ where $\mathcal{L}_V = \{\bullet, \square, \diamond\}$, $\mathcal{L}_E = \{t, f, \square\}$, $\mathcal{N}_V = \mathcal{N}_E = \emptyset$, $\mathcal{R} = \{seq, while, ddec, dec1, dec2\}$, and $S = \bullet \rightarrow \square \rightarrow \bullet$.

In the figure, the shorthand notation with the numbers under the nodes places such nodes in the interface graph of the rules. We assume that the interface graphs are discrete (have no edges).

Lemma 4.5. Every **directed cycle** in an extended flow diagram contains a t -labelled edge

Proof. Induction. □

Theorem 4.5 (Efficient EFD Recognition). $\mathbf{EFD}^{-1} = (\mathcal{L}, \mathcal{R}^{-1})$ **efficiently recognises** $L(\mathbf{EFD})$.

Proof. By Theorem 2.3, \mathbf{EFD}^{-1} recognises $L(\mathbf{EFD})$, and one can see that it is terminating since each rule is size reducing.

We now proceed by performing critical pair analysis on \mathbf{EFD}^{-1} . There are ten critical pairs, all but one of which are strongly joinable apart from one (Figure 4.6). Now observe that Lemma 4.5 tells us that EFDs cannot contain such cycles. With this knowledge, we define D to be all graphs such that directed cycles contain at least one t -labelled edge. Clearly, D is subgraph closed, and then by our Non-Garbage Critical Pair Lemma (Theorem 4.3), we have that \mathbf{EFD}^{-1} is locally confluent on D .

Next, it is easy to see that D is closed on \mathbf{EFD}^{-1} , so we can use Newman-Garbage Lemma (Theorem 4.2) to conclude confluence on D and thus, by Lemma 4.1, \mathbf{EFD}^{-1} is confluent on $L(\mathbf{EFD})$.

Thus, \mathbf{EFD}^{-1} efficiently recognises $L(\mathbf{EFD})$, as required. □

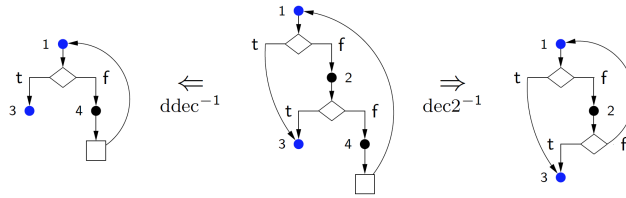

Figure 4.6: Non-Joinable Critical Pair

Chapter 5

Confluence Analysis II

“The development of mathematics towards greater precision has led, as is well known, to the formalization of large tracts of it, so that one can prove any theorem using nothing but a few mechanical rules.”

– Kurt Gödel, *Opening of the paper introducing the undecidability theorem (1931)*

In the last chapter, we have seen that the notion of confluence up to garbage was sufficient to give efficient language recognition, however it is not yet known if these results transfer to the setting with root nodes and partial labelling. In this chapter, we will introduce definitions of sequential and parallel independence for such rules, and show that the (Non-Garbage) Critical Pair Lemma holds. We do this by showing that ‘conventional’ totally labelled systems can simulate relabelling and root nodes.

5.1 Encoding PLRGs

We can encode the graphs and morphisms given in Chapter 2 as totally labelled graphs and morphisms (in Appendix D). Both of these are locally small categories, and we denote them $PLRG(\mathcal{L})$ and $TLG(\mathcal{L})$ respectively. We will refer to the graph transformation systems from Chapter 2 as **R-GT systems**, and those from Appendix D without relabelling as **T-GT systems**.

Without loss of generality, we will assume that $\mathcal{L} = (\mathcal{L}_V, \mathcal{L}_E)$ is an arbitrary label alphabet such that $\mathcal{L}_V \cap \mathcal{L}_E = \emptyset$ and $\{\square, 0, 1\} \cap (\mathcal{L}_V \cup \mathcal{L}_E) = \emptyset$.

In this section we will see that this encoding is a actually fully faithful functor and that we have **derivation compatibility**, in a similar sense to Remark 2.10.

Definition 5.1 (Object Encoding). Given $G = (V, E, s, t, l, m, p) \in PLRG(\mathcal{L})$,

define $e(G) = (V', E', s', t', l', m')$ where:

1. $V' = V$;
2. $E' = E \times \{0\} \cup l^{-1}(\mathcal{L}_V) \times \{1\} \cup p^{-1}(\{0, 1\}) \times \{2\}$;
3. $s'((e, 0)) = s(e)$ and $s'((v, i)) = v$ for $i = 1, 2$;
4. $t'((e, 0)) = t(e)$ and $t'((v, i)) = v$ for $i = 1, 2$;
5. $l'(v) = \square$;
6. $m'((e, 0)) = m(e)$, $m'((v, 1)) = l(v)$, and $m'((v, 2)) = p(v)$.

We denote by $e(X)$ where X is some collection of objects (or their isomorphism classes), the image of the objects under e . In an abuse of notation, we will also denote the the label alphabet of the encoded objects by $e(\mathcal{L}) = (\{\square\}, \mathcal{L}_E \cup \mathcal{L}_V \cup \{0, 1\})$.

Proposition 5.1. $e(G) \in \mathbf{TLG}(e(\mathcal{L}))$.

Proof. Clearly each graph has exactly one well-defined encoding, and it is totally labelled by construction. \square

Example 5.1. Let $\mathcal{L} = (\{x\}, \{y, z\})$. Then Figure 5.1 shows an example PLRG and its encoding as a totally labelled graph. \triangle

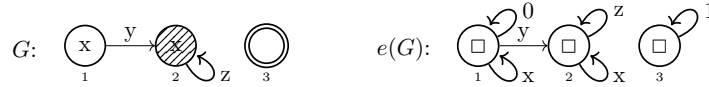

Figure 5.1: Example Encoded PLRG

Definition 5.2 (Arrow Encoding). Given $g \in \mathbf{Hom}_{\mathbf{PLRG}(\mathcal{L})}(G, H)$, define $e(g) = (g'_V, g'_E)$ where:

1. $g'_V(v) = g_V(v)$;
2. $g'_E((e, 0)) = (g_E(e), 0)$ and $g'_E((v, i)) = (g_V(v), i)$ for $i = 1, 2$.

Proposition 5.2. $e(g) \in \mathbf{Hom}_{\mathbf{TLG}(e(\mathcal{L}))}(e(G), e(H))$.

Proof. By construction. \square

Now that we have setup our encoding function, we are ready to give our first important technical lemma, allowing us to then show that derivations are compatible (Theorem 5.1).

Lemma 5.1. e is a **fully faithful functor** $e : \mathbf{PLRG}(\mathcal{L}) \rightarrow \mathbf{TLG}(e(\mathcal{L}))$.

Proof. By Propositions 5.1 and 5.2, each graph and morphism has a well-defined encoding. The first axiom as given in Definition B.5 is given by Proposition 5.2, and the remaining 2 axioms are almost immediate. Thus we have a functor.

To see fullness, suppose that there is a morphism between two encoded graphs. Since morphisms are required to preserve labels, it is not possible to have confusion between the edges (that would introduce extra morphisms).

That is, root-loops have to be mapped to root-loops, non-root-loops to non-root-loops, l -label-loops to l -label-loops for all $l \in \mathcal{L}_V$, and m -label-loops to m -label-loops for all $m \in \mathcal{L}_E$. We can then, decode such a morphism to a morphism between the original graphs in the original setting.

Faithfulness is explicit from the construction of encoded morphisms. Each morphism is mapped to a distinct encoded morphism. \square

Lemma 5.2 (Dangling Condition Compatibility). Given a TLRG G and an inclusion $i : K \rightarrow L$ where L is a TLRG and K a PLRG, then the set of injective morphisms $L \rightarrow G$ satisfying the dangling condition w.r.t. i (in the sense of R-GT systems) is in bijective correspondence via e with the set of injective morphisms $e(L) \rightarrow e(G)$ satisfying the dangling condition w.r.t. $e(i)$ (in the sense of T-GT systems).

Proof. First, we show that the injective morphisms are in bijective correspondence. Suppose that $g : L \rightarrow G$ is an injective morphism, then by construction, $e(g) : e(L) \rightarrow e(G)$ is injective. The reverse direction is a consequence of the elementary result that fully faithful functors reflect monomorphisms.

Suppose again that $g : L \rightarrow G$ is an injective morphism. Then g satisfies the dangling condition w.r.t. i iff no edge in $G \setminus g(L)$ is incident to a node in $g(L \setminus K)$ iff no edge in $e(G \setminus g(L))$ is incident to a node in $e(g(L \setminus K))$ iff no edge in $e(G) \setminus e(g)(e(L))$ is incident to a node in $e(g)(e(L) \setminus e(K))$ iff $e(g)$ satisfies the dangling condition w.r.t. $e(i)$. The correctness of the movement of e comes from the explicit constructions. \square

Theorem 5.1 (Compatible Derivations). Given a **rule** $r = \langle L \leftarrow K \rightarrow R \rangle$ from a R-GT system, then for all TLRG G, H , $G \Rightarrow_r H$ iff $e(G) \Rightarrow_{e(r)} e(H)$, where $e(r)$ encodes the rule in the obvious way.

Proof. By Lemma 5.2, e reflects and preserves injective morphisms satisfying the dangling condition. But, it is an elementary result that a fully faithful functor reflects all limits and colimits, so by Theorems D.3 and 2.1 we have the result! \square

We can define the track morphism and closedness in the same way as for T-GT systems. We have compatibility of tracks and also of closedness. Note, in particular, the special case when $\mathbf{D} = \mathcal{G}(\mathcal{L})$.

Corollary 5.1 (Track Compatibility). $e(tr_{G \Rightarrow^* H}) = tr_{e(G) \Rightarrow^* e(H)}$.

Proof. Induction on derivation length using Theorem 5.1. \square

Corollary 5.2 (Closedness Compatibility). Let $T = (\mathcal{L}, \mathcal{R})$ be some R-GT system, and $\mathbf{D} \subseteq \mathcal{G}^\oplus(\mathcal{L})$. Then \mathbf{D} is **closed** under T iff $e(\mathbf{D})$ is **closed** under $e(T) = (e(\mathcal{L}), e(\mathcal{R}))$.

5.2 Local Church-Rosser and Independence

The purpose of this chapter is to define sequential and parallel independence for R-GT systems, and show they are compatible with the T-GT encoding. Moreover, Theorems 5.2 and 5.3, together, constitute the Local Church-Rosser Theorem, and so we have lifted this result into our new setting.

Definition 5.3. The derivations $G_1 \Rightarrow_{r_1, g_1} H \Rightarrow_{r_2, g_2} G_2$ are **sequentially independent** iff $(h_1(R_1) \cap g_2(L_2)) \subseteq (h_1(K_1) \cap g_2(K_2))$.

Proposition 5.3. We have sequential independence of derivations iff their encoding is sequentially independent in the sense of Definition D.29.

Proof. Definition bashing. □

Theorem 5.2 (Sequential Independence). If $G_1 \Rightarrow_{r_1, g_1} H \Rightarrow_{r_2, g_2} G_2$ are **sequentially independent**, then there exists a graph H' and **sequentially independent** steps $G \Rightarrow_{r_2} H' \Rightarrow_{r_1} G_2$.

Proof. By combining Theorem 5.1 and Proposition 5.3, the result is immediate from Lemma D.1. □

Definition 5.4. The derivations $H_1 \Leftarrow_{r_1, g_1} G \Rightarrow_{r_2, g_2} H_2$ are **parallelly independent** iff $(g_1(L_1) \cap g_2(L_2)) \subseteq (g_1(K_1) \cap g_2(K_2))$.

Remark 5.1. The derivations $H_1 \Leftarrow_{r_1, g_1} G \Rightarrow_{r_2, g_2} H_2$ are **parallelly independent** iff $H_1 \Rightarrow_{r_1^{-1}, h_1} G \Rightarrow_{r_2, g_2} H_2$ are **sequentially independent**.

Proposition 5.4. We have parallel independence of derivations iff their encoding is parallelly independent in the sense of Definition D.30.

Proof. Definition bashing. □

Theorem 5.3 (Parallel Independence). If $H_1 \Leftarrow_{r_1, g_1} G \Rightarrow_{r_2, g_2} H_2$ are **parallelly independent**, then there exists a graph G' and **direct derivations** $H_1 \Rightarrow_{r_2} G' \Leftarrow_{r_1} H_2$ with $G \Rightarrow_{r_1} H_1 \Rightarrow_{r_2} G'$ and $G \Rightarrow_{r_2} H_2 \Rightarrow_{r_1} G'$ **sequentially independent**.

Proof. By combining Theorem 5.1 and Proposition 5.4, the result is immediate from Lemma D.2. □

5.3 Confluence up to Garbage

The ultimate goal of this chapter is to recover the (Non-Garbage) Critical Pair Lemma for R-GT systems. We will begin this section by noting that all the definitions from Section 4.1 can be trivially re-formulated for R-GT systems. We will not give all the definitions and results again here, but we do need to state the relationship between (local) confluence (termination) of a R-GT system and that of its encoding.

We start by noting compatibility of confluence and termination.

Lemma 5.3 (Compatible Properties). Given a R-GT system $T = (\mathcal{L}, \mathcal{R})$ and $\mathbf{D} \subseteq \mathcal{G}^\oplus(\mathcal{L})$, then T is **(locally) confluent (terminating)** on \mathbf{D} iff $e(T) = (e(\mathcal{L}), e(\mathcal{R}))$ is **(locally) confluent (terminating)** on $e(\mathbf{D})$.

Recall from Remark 2.4 that there are two obvious definitions of subgraph. The alternative definition that insists on the inclusion being undefinedness preserving will actually be most useful to us in this context, since we want to insist that all subgraphs of a TLRG are themselves TLRGs. We will thus use that definition of subgraph throughout the remainder of this chapter.

Definition 5.5. Let $\mathbf{D} \subseteq \mathcal{G}^\oplus(\mathcal{L})$ be a set of abstract TLRGs. Then \mathbf{D} is **subgraph closed** iff for all TLRG G, H , such that $H \subseteq G$, if $[G] \in \mathbf{D}$, then $[H] \in \mathbf{D}$. The **subgraph closure** of \mathbf{D} , denoted $\overline{\mathbf{D}}$, is the smallest set containing \mathbf{D} that is **subgraph closed**.

Proposition 5.5. Given $\mathbf{D} \subseteq \mathcal{G}^\oplus(\mathcal{L})$, $\overline{\mathbf{D}}$ always **exists**, and is **unique**. Moreover, $\mathbf{D} = \overline{\mathbf{D}}$ iff \mathbf{D} is **subgraph closed**.

We now must setup the definition of a (non-garbage) critical pair. We will show that this definition is compatible across encoding, and also that (strong) joinability is.

Definition 5.6. A pair of **direct derivations** $G_1 \leftarrow_{r_1, g_1} H \Rightarrow_{r_2, g_2} G_2$ is a **critical pair** iff:

1. $H = g_1(L_1) \cup g_2(L_2)$;
2. The steps are not **parallelly independent**;
3. If $r_1 = r_2$ then $g_1 \neq g_2$.

Definition 5.7. A **critical pair** $H_1 \leftarrow G \Rightarrow H_2$ is **non-garbage** w.r.t. \mathbf{D} iff $[G] \in \overline{\mathbf{D}}$.

Lemma 5.4 (Compatible Non-Garbage Critical Pairs). Given a R-GT system $T = (\mathcal{L}, \mathcal{R})$ and $\mathbf{D} \subseteq \mathcal{G}^\oplus(\mathcal{L})$, a pair of **direct derivations** $G_1 \leftarrow_{r_1, g_1} H \Rightarrow_{r_2, g_2} G_2$ is a **non-garbage critical pair** w.r.t. \mathbf{D} iff its encoding via e is a non-garbage critical pair w.r.t. $e(\mathbf{D})$ in the sense of a T-GT system.

Proof. Due to Proposition 5.4 and Lemma 5.1. □

Corollary 5.3 (Compatible Critical Pairs). Given a R-GT system $T = (\mathcal{L}, \mathcal{R})$, a pair of **direct derivations** $G_1 \leftarrow_{r_1, g_1} H \Rightarrow_{r_2, g_2} G_2$ is a **critical pair** iff its encoding via e is a non-garbage critical pair w.r.t. $e(\mathcal{G}^\oplus(\mathcal{L}))$ in the sense of a T-GT system.

Theorem 5.4 (Compatible Strong Joinability). Given a R-GT system $T = (\mathcal{L}, \mathcal{R})$, a **critical pair** is **(strongly) joinable** iff its encoding is.

Proof. Due to Theorem 5.1, Corollary 5.1 and Lemma 5.4. □

Just like in the previous case, there are only finitely many (non-garbage) critical pairs, and so long as the sub-graph closure of D is decidable, we can generate them all.

Lemma 5.5. Given a R-GT system $T = (\mathcal{L}, \mathcal{R})$ and $D \subseteq \mathcal{G}^\oplus(\mathcal{L})$, then there are only finitely many **non-garbage critical pairs** up to isomorphism.

Proof. Lemma 4.3 combined with Lemma 5.4. \square

Corollary 5.4. Given a R-GT system $T = (\mathcal{L}, \mathcal{R})$ and $D \subseteq \mathcal{G}^\oplus(\mathcal{L})$ such that \bar{D} is **decidable**, then one can find the finitely many **non-garbage critical pairs in finite time**.

Proof. By Lemma 5.5, we have only finitely many pairs to consider. Continue as in the proof of Corollary 4.2. \square

Corollary 5.5. Let $T = (\mathcal{L}, \mathcal{R})$, $D \subseteq \mathcal{G}^\oplus(\mathcal{L})$ be such that T is **terminating** on D and \bar{D} is **decidable**. Then, one can **decide** if all the **non-garbage critical pairs** are **strongly joinable** (Definition D.34).

Proof. By Corollary 5.4, we can find the finitely many pairs in finite time. Continue as in the proof of Corollary 4.3. \square

Remark 5.2. Clearly $e(\mathcal{G}^\oplus(\mathcal{L}))$ is always decidable, so it is always possible to generate all the genuine critical pairs of a R-GT system.

We are now, finally, ready to reproduce the (Non-Garbage) Critical Pair Lemma.

Theorem 5.5 (Non-Garbage Critical Pair Lemma). Let $T = (\mathcal{L}, \mathcal{R})$, $D \subseteq \mathcal{G}^\oplus(\mathcal{L})$. If all its **non-garbage critical pairs** are **strongly joinable**, then T is **locally confluent** on D .

Proof. By compatibility Lemma 5.4 and Theorem 5.4, we can simply apply the original Non-Garbage Critical Pair Lemma (Theorem 4.3). \square

Corollary 5.6. Let $T = (\mathcal{L}, \mathcal{R})$, $D \subseteq \mathcal{G}^\oplus(\mathcal{L})$. If T is **terminating** on D , D is **closed** under T , and all T 's **non-garbage critical pairs** are **strongly joinable** then T is **confluent** on D .

Proof. By the above theorem, T is **locally confluent up to garbage**, so by the Newman-Garbage Lemma, T is **confluent up to garbage**. \square

5.4 Tree Recognition Revisited

It is possible to rephrase the results from Section 3.2 in terms of our new notion of garbage, where the rules r_0, r_1, r_2 are from Figure 3.3:

Proposition 5.6. Let $\mathcal{L} = (\{\square, \triangle\}, \{\square\})$ and $\mathcal{R} = \{r_0, r_1, r_2\}$. Then, $\mathbf{D} = \{[G] \in \mathcal{G}^\oplus(\mathcal{L}) \mid [G^\ominus] \in \mathbf{L}(\mathbf{TREE}), |p_G^{-1}(\{1\})| = 1\}$ is **strongly closed** under $T = (\mathcal{L}, \mathcal{R})$ and T is **confluent** on $\mathbf{E} = \{[G] \in \mathbf{D} \mid l_G(V_G) = \{\square\}\}$.

Proof. Strong closedness is due to Lemma 3.6 and confluence up to garbage due to Theorem 3.2. \square

One would hope that we could then perform non-garbage critical pair analysis w.r.t. \mathbf{D} (where \mathbf{D} is as in Proposition 5.6) in order to demonstrate local confluence on \mathbf{D} . It turns out that every non-garbage critical pair is joinable, but unfortunately, one of them is not strongly joinable (Figure 5.2), so we are unable to make any conclusion about local confluence up to garbage using the Non-Garbage Critical Pair Lemma (Theorem 5.5).

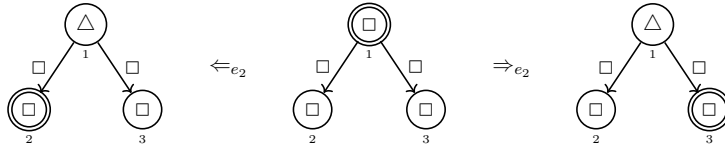

Figure 5.2: Non-Strongly Joinable Critical Pair

Thus, just like Plump's original Critical Pair Lemma, strong joinability of (non-garbage) critical pairs is sufficient, but not necessary to imply local confluence (up to garbage). As discussed in the next chapter, it remains future work to develop stronger (non-garbage) critical pair analysis theorems.

Chapter 6

Conclusion

“In a sense, mathematics has been most advanced by those who distinguished themselves by intuition rather than by rigorous proofs.”

– Felix Klein, *Unknown source*

We have reviewed the current state of graph transformation, with a particular focus on the ‘injective DPO’ approach with relabelling and graph programming languages, establishing issues with the current approach to rooted graph transformation. We developed a new type of graph transformation system that supports relabelling and root nodes, but where derivations are invertible, and looked at a case study, showing that rooted graph transformation systems can recognise trees in linear time. This work on tree recognition was presented at CALCO 2019 [22]. We have also defined some notions of equivalence for our new type of graph transformation system, and briefly discussed a possible theory of refinement.

In Chapter 4, we have introduced the new notion of confluence up to garbage for graph transformation systems, that allows us to have confluence, except in the cases we do not care about. Moreover, we have shown that it is sufficient to only analyse the non-garbage critical pairs to establish confluence up to garbage, and if said system is closed and terminating up to garbage, then we may conclude confluence up to garbage. We have shown closedness is undecidable in general, and applied our results to see that EFDs can be recognised by a system that is confluent up to garbage. Finally, in Chapter 5, we recovered notions of independence of derivations in our new notion of rooted GT systems with relabelling, along with the Local Church-Rosser Theorem and (Non-Garbage) Critical Pair Lemma, by encoding our rooted systems as conventional systems via a fully faithful functor.

6.1 Evaluation

We regard this project as a success, having achieved our four original goals as detailed in the Executive Summary. Our first goal was to review rooted DPO graph transformation with relabelling. We have done this in Chapter 1, looking at labelled GT systems with the DPO approach with injective matching, and how relabelling and root nodes have been implemented, providing further detail in Appendices C and D. We also briefly reviewed graph languages and DPO-based graph programming languages.

Our second goal was to address the problem that the current theory of rooted graph transformation does not have invertible derivations. We have fixed this problem in Chapter 2 by defining rootedness using a partial function onto a two-point set rather than pointing graphs with root nodes. We have shown rule application corresponds to NDPOs, how Dodds' complexity theory applies in our system, and briefly discussed the equivalence of and refinement of GT systems.

Our third goal was to show a new example of how rooted graph transformation can be applied. We showed a new result that the graph class of trees can be recognised by a rooted GT system in linear time, given an input graph of bounded degree. Moreover, we have given empirical evidence by implementing the algorithm in GP 2 and collecting timing results. The results are in the CALCO 2019 post-proceedings [22].

Our final goal was to develop new confluence analysis theory. We have defined a new notion of confluence up to garbage and non-garbage critical pairs, and shown that it is sufficient to require strong joinability of only the non-garbage critical pairs to establish confluence up to garbage, applying this theory to EFDs. Moreover, we have recovered the Local Church-Rosser Theorem and (Non-Garbage) Critical Pair Lemma for our new notion of rooted graph transformation with relabelling. We look to publish this work.

6.2 Future Work

Developing a fully-fledged theory of correctness and refinement for (rooted) GT systems remains future work, extending the work from Section 2.6. Additionally, extending this notion to GP 2, or other graph transformation based languages, and looking at the automated introduction of root nodes in order to improve time complexity remains open. Overcoming the restriction of host graphs to be of bounded degree in Theorem 3.1 remains open too.

Further exploring the relationship between (local) confluence up to garbage and closedness remains open work. In fact, confluence analysis of GT systems remains an underexplored area in general. Developing a stronger version of the

Non-Garbage Critical Pair Lemma that allows for the detection of persistent nodes that need not be identified in the joined graph would allow conclusions of confluence up to garbage where it was previously not determined, remains future work. It is also unclear under what conditions one can decide if a graph is in the subgraph closure of a language, specified by a grammar, or otherwise.

Additional future work in the foundations of our new theory of rooted graph transformation would be to continue to establish the foundational theorems. We have shown the Local Church-Rosser Theorem and Critical Pair Lemma, however, the Parallelism and Concurrency Theorems [21], which have applications in database systems [84], algebraic specifications [85], and logic programming [6], remain future work. One may also want to recover a formalism of the Extension Theorem, which we didn't need when proving the Critical Pair Lemma [86].

Finally, it remains open research, to explore the overlap between graph transformation systems and the study of 'reversible computation' [87]. Our new foundations of rooted graph transformation allows for the specification of both efficient and reversible GT systems. Since graph transformation is a uniform way of expressing many problems in computer science, it is only natural that its applications in reversible computation is explored.

Appendix A

Basic Mathematical Notions

There is not time to give an account of an axiomatization of set theory. Instead, we will simply state that we are using Von Neumann-Bernays-Gödel Set Theory (NBG) [88], [89]. For the most part, a naive approach will suffice. We will use the word ‘collection’ to refer, informally, to something that may or may not be a set. We will avoid the use of the word ‘class’ to mitigate confusion with equivalence relations. When it comes to the definition of decidable (for sets of graphs) we will tacitly assuming a Gödel numbering [40].

A.1 Sets I

We split the ‘Sets’ section into two halves. This section is derived from Chapters 2 and 3 of [90] and Chapter 3 of [91].

Definition A.1. We let \emptyset denote the **empty set**. If A is a **set**, then we write $a \in A$ to say that a ‘belongs to’ A . We say that B is a **subset** of A , $B \subseteq A$ iff $\forall x \in B, x \in A$. We say $A = B$ iff $A \subseteq B$ and $B \subseteq A$.

Definition A.2. If A, B are sets, then we define:

1. **Set union:** $A \cup B = \{x \mid x \in A \text{ or } x \in B\}$;
2. **Set intersection:** $A \cap B = \{x \mid x \in A \text{ and } x \in B\}$;
3. **Set difference:** $A \setminus B = \{x \mid x \in A \text{ and } x \notin B\}$;
4. **Cartesian product:** $A \times B = \{(a, b) \mid a \in A \text{ and } b \in B\}$;
5. **Power set:** $\mathcal{P}(A) = \{X \mid X \subseteq A\}$, $\mathcal{P}_1(A) = \mathcal{P}(A) \setminus \emptyset$.

Definition A.3. We define the **disjoint union** of sets A, B to be their **coproduct** in the category of sets (Example B.1). It can be convenient to define this as $A + B = (A \times \{1\}) \cup (B \times \{2\})$, or simply to assume that $A \cap B = \emptyset$ and define $A + B = A \cup B$.

Definition A.4. Let $\mathbb{N} = \{0, 1, 2, \dots\}$, and $\mathbb{Z} = \{\dots, -1, 0, 1, \dots\}$.

A.2 Functions

This section is derived from Chapters 2 and 3 of [90] and Chapter 1 of [92]. We use the conventional order of composition.

Definition A.5. Let A, B be sets. A **function** f from **domain** A to **codomain** B is a rule which assigns to each $a \in A$ a **unique** $b \in B$. We write $b = f(a)$, $f : A \rightarrow B$, and call a the **argument** of f . Formally, a **function** from A to B is a subset of $A \times B$ such that for each $a \in A$ there is **exactly one** element (a, b) in f .

Definition A.6. Let A, B, C, D be sets. If $f : A \rightarrow B$, $g : C \rightarrow D$ are **functions**, then f and g are **equal** ($f = g$) iff they are equal as sets.

Definition A.7. Let A, B, C be sets. If $f : A \rightarrow B$, $g : B \rightarrow C$ are **functions**, then we form a new **function** $(g \circ f) : A \rightarrow C$ the **composite** of f and g by the rule $(g \circ f)(a) = g(f(a))$.

Proposition A.1. Composition of functions is **associative**. That is, given $f : A \rightarrow B$, $g : B \rightarrow C$, $h : C \rightarrow D$, then $h \circ (g \circ f) = (h \circ g) \circ f$.

Definition A.8. For any set A , the **identity function** on A , $id_A : A \rightarrow A$ is defined by $\forall a \in A, id_A(a) = a$.

Proposition A.2. If $f : B \rightarrow A$, then $id_A \circ f = f$. If $g : A \rightarrow C$, $g \circ id_A = g$.

Definition A.9. Let $f : A \rightarrow B$ be a **function**. Then a **function** $g : B \rightarrow A$ is the **inverse** of f iff $g \circ f = id_A$ and $f \circ g = id_B$.

Proposition A.3. Let $f : A \rightarrow B$ be a **function**. Then, if an **inverse** exists, it is unique, and is denoted $f^{-1} : B \rightarrow A$.

Definition A.10. Let $f : A \rightarrow B$ be a **function**. Then f is **injective** iff $\forall a, b \in A, f(a) = f(b)$ implies $a = b$. f is **surjective** iff $\forall a \in A, \exists b \in B, f(a) = b$. If f satisfies both properties, then it is **bijective**.

Lemma A.1. A **function** has an **inverse** iff it is a **bijection**.

Definition A.11. Let $f : A \rightarrow B$ be a **function**, $X \subseteq A$, and $Y \subseteq B$. Then the **image** of A under f is $f(A) = \{f(a) \mid a \in A\} \subseteq B$, and the **preimage** of B is $f^{-1}(B) = \{a \in A \mid f(a) \in B\} \subseteq A$.

Remark A.1. This does not imply the existence of an inverse, but if it does exist, then preimage of f coincides with the image of f^{-1} .

Definition A.12. Let $f : A \rightarrow B$ be a **function**, and $X \subseteq A$. Then the **restriction** of f to X is $f|_X : X \rightarrow B$ is defined by $\forall x \in X, f|_X(x) = f(x)$.

Definition A.13. A **partial function** $f : A \rightarrow B$ is a subset f of $A \times B$ such that there is **at most one** element (a, b) in f .

A.3 Binary Relations

This section is derived from Chapter 2 of [90], Chapter 1 of [92] and Appendix A of [48].

Definition A.14. Let A be a set. Then a **binary relation** on A is a subset R of $A \times A$. For any $a, b \in A$, we write aRb iff $(a, b) \in R$.

Definition A.15. Let A be a set. Then, the **identity relation** on A is $\iota_A = \{(a, a) \mid a \in A\}$, and the **universal relation** on A is $\omega_A = A \times A$.

Definition A.16. Let A be a set. Then we call a **binary relation** R on A **functional** iff for any $a, b, c \in A$, aRb and aRc implies $b = c$.

Definition A.17. Let A be a set, and R, S be **binary relations** on A . Then the **composition** of R and S is $S \circ R = \{(x, y) \in A \times A \mid \exists z \in A \text{ with } xRz \text{ and } zSy\}$. Define $R^0 = \iota_A$, and $\forall n \in \mathbb{N}^+$, $R^n = R \circ R^{n-1}$.

Definition A.18. Let A be a set. Then the **inverse** of a **binary relation** R on A is $R^{-1} = \{(b, a) \in A \times A \mid aRb\}$.

Proposition A.4. When considered as **binary relations**, **functions** and **partial functions** are **functional**. Moreover, the definitions of **composition** and **inverses** coincide.

Definition A.19. A **binary relation** R on A is:

1. **Reflexive** iff $\iota_A \subseteq R$;
2. **Irreflexive** iff $\iota_A \cap R = \emptyset$;
3. **Symmetric** iff $R = R^{-1}$;
4. **Antisymmetric** iff $R \cap R^{-1} \subseteq \iota_A$;
5. **Transitive** iff $R \circ R \subseteq R$;
6. **Connex** iff $\omega_A \setminus \iota_A \subseteq R \cup R^{-1}$.

Definition A.20. A **binary relation** is a **preorder** iff it is **reflexive** and **transitive**. A **symmetric preorder** is called an **equivalence**.

Proposition A.5. The classes $[a] = \{b \in A \mid a \sim b\}$ of an **equivalence** \sim on A **partition** A into a union of pairwise disjoint non-empty subsets.

Definition A.21. Given an **equivalence** \sim , define $A/\sim = \{[a] \mid a \in A\}$.

A.4 Orders

This section is derived from Chapter 1 of [92] and Appendix A of [48].

Definition A.22. An **antisymmetric preorder** \leq on X is called a **partial order**, and we call (X, \leq) a **partially ordered set** (**poset**).

Definition A.23. A **partial order** satisfying the **connex** property is called a **total order**, giving a **totally ordered set**.

Definition A.24. A **strict order** is an **irreflexive, transitive** relation.

Proposition A.6. Every **partial order** \leq induces a **strict order** $\leq \setminus \iota$, and every **strict order** $<$ induces a **partial order** $< \cup \iota$.

Definition A.25. Let (X, \leq) be a poset, and $\emptyset \neq Y \subseteq X$. Then:

1. $a \in Y$ is **minimal** iff $\forall y \in Y, y \leq a$ implies $y = a$;
2. $b \in Y$ is the **minimum** iff $\forall y \in Y, b \leq y$;
3. $c \in X$ is a **lower bound** for Y iff $\forall y \in Y, c \leq y$.

Proposition A.7. Let (X, \leq) be a poset, and $\emptyset \neq Y \subseteq X$. Then every **minimum** element of Y is **minimal**, Y and has **at most one minimum**.

Definition A.26. We say that the poset (X, \leq) satisfies the **minimal condition (well-founded)** iff every non-empty subset of X has a **minimal** element. If \leq is also a **total order**, then we say it is **well-ordered**.

Definition A.27. Let $(X, \leq_X), (Y, \leq_Y)$ be posets. Then a function $\varphi : X \rightarrow Y$ is called **monotone** iff $a \leq_X b$ implies $\varphi(a) \leq_Y \varphi(b)$.

A.5 Sets II

This section is derived from Chapter 7 of [93], Part I of [94], Chapter 8 of [95], and Chapter 1 of [39].

Theorem A.1 (Well-Ordered Sets). Every set can be **well-ordered**, and every **well-ordered** set is **isomorphic** to an **ordinal** (see [93] for details).

Proposition A.8. We define the **cardinality** of A ($|A|$), to be the **least ordinal** κ such that there is some **bijection** $f : A \rightarrow \kappa$. Every set has **unique** cardinality. All sets with **cardinality** \leq to that of \mathbb{N} are **countable**.

Theorem A.2 (Countable Sets). The **Cartesian product** of two **countable** sets is **countable**, and a **countable union** of **countable** sets is **countable**. If A is **finite**, then $\mathcal{P}(A)$ is **finite**. The set $\mathcal{P}(\mathbb{N})$ is **uncountable**.

Definition A.28. A **partial function** $f : \mathbb{N} \rightarrow \mathbb{N}$ is **computable** iff there exists a **Turing Machine** that computes f (see [95] for details).

Definition A.29. A **countable** set $A \subseteq \mathbb{N}$ has **characteristic function** $\chi_A : \mathbb{N} \rightarrow \{0, 1\}$ defined by $\forall x \in \mathbb{N}, \chi_A(x) = 1$ iff $x \in A$. A is **decidable** or **recursive** iff χ_A is **computable**. Otherwise, A is **undecidable**.

Definition A.30. $A \subseteq \mathbb{N}$ is **semidecidable** or **recursively enumerable** iff it is the **domain** of a **computable** function.

Appendix B

Category Theory

The definitions and theorems in this appendix are derived Chapter 1 of [96], Appendix A of [5], Chapter 1 of [91], and Chapter 1 of [97].

B.1 Foundations

Definition B.1. A category \mathbf{C} consists of the following data:

1. **Objects:** A, B, C, \dots
2. **Arrows:** f, g, h, \dots
3. For each arrow f , there are given objects $\text{dom}(f)$, $\text{cod}(f)$, and we write $f : A \rightarrow B$ to indicate that $A = \text{dom}(f)$, $B = \text{cod}(f)$;
4. Given arrows $f : A \rightarrow B$, $g : B \rightarrow C$, $g \circ f$ is an arrow such that $A = \text{dom}(g \circ f)$, $C = \text{cod}(g \circ f)$;
5. For each object A there is given an arrow $1_A : A \rightarrow A$;

such that for all arrows $f : A \rightarrow B$, $g : B \rightarrow C$, $h : C \rightarrow D$, we have $h \circ (g \circ f) = (h \circ g) \circ f$ and $f \circ 1_A = f = 1_B \circ f$. We write $A \in \mathbf{C}$ when A is an object in \mathbf{C} .

Definition B.2. We call an arrow $f : A \rightarrow B$ **monic (epic)** iff it is **left (right) cancellative**. We call f an **isomorphism** and write $A \cong B$ iff f admits a two-sided inverse.

Definition B.3. A category \mathbf{C} is called **small** iff the collection of all arrows is a **set**. Otherwise, it is called **large**. \mathbf{C} is called **locally small** iff the collection of arrows between any two objects ($\text{Hom}_{\mathbf{C}}(X, Y)$) is a **set**.

Proposition B.1. Every **small** category is **locally small**. Moreover, a **locally small** category is **small** iff the collection of all objects is a **set**.

Definition B.4. A category is **finitary** iff there are only finitely many **subobjects** up to isomorphism, where A is a **subobject** of B iff there is a monomorphism $A \rightarrow B$.

Example B.1. The collection of all sets as objects and all functions between them as arrows forms a locally small category. The collection of all finite sets and functions between them is a locally small, finitary category. \triangle

Definition B.5. A **functor** $F : \mathbf{C} \rightarrow \mathbf{D}$ between categories \mathbf{C} , \mathbf{D} is a mapping such that:

1. $F(f : A \rightarrow B) = F(f) : F(A) \rightarrow F(B)$;
2. $F(1_A) = 1_{F(A)}$;
3. $F(g \circ f) = F(g) \circ F(f)$.

Definition B.6. A (covariant) **functor** $F : \mathbf{C} \rightarrow \mathbf{D}$ between two locally small categories \mathbf{C} , \mathbf{D} is **faithful** (**full**) if the induced function $F_{X,Y} : \text{Hom}_{\mathbf{C}}(X, Y) \rightarrow \text{Hom}_{\mathbf{D}}(F(X), F(Y))$ is **injective** (**surjective**) for all objects X, Y in \mathbf{C} .

B.2 Pushouts and Pullbacks

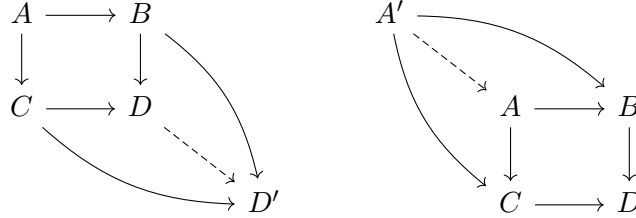

Figure B.1: Pushout and Pullback

Definition B.7. Given arrows $A \rightarrow B$ and $A \rightarrow C$, an object D together with arrows $B \rightarrow D$ and $C \rightarrow D$ is a **pushout** iff:

1. **Commutativity:** $A \rightarrow B \rightarrow D = A \rightarrow C \rightarrow D$.
2. **Universal property:** For all arrows $B \rightarrow D'$, $C \rightarrow D'$ such that $A \rightarrow B \rightarrow D' = A \rightarrow C \rightarrow D'$, there is a unique arrow $D \rightarrow D'$ such that $B \rightarrow D \rightarrow D' = B \rightarrow D'$ and $C \rightarrow D \rightarrow D' = C \rightarrow D'$.

Definition B.8. Given arrows $B \rightarrow D$ and $C \rightarrow D$, an object A together with arrows $A \rightarrow B$ and $A \rightarrow C$ is a **pullback** iff:

1. **Commutativity:** $A \rightarrow B \rightarrow D = A \rightarrow C \rightarrow D$.
2. **Universal property:** For all arrows $A' \rightarrow B$, $A' \rightarrow C$ such that $A' \rightarrow B \rightarrow D = A' \rightarrow C \rightarrow D$, there is a unique arrow $A' \rightarrow A$ such that $A' \rightarrow A \rightarrow B = A' \rightarrow B$ and $A' \rightarrow A \rightarrow C = A' \rightarrow C$.

Definition B.9. A **pushout** that is a **pullback** is called a **natural pushout**.

Theorem B.1 (Limit Uniqueness). If they exist, a **pushout** (**pullback**), D (A) are unique up isomorphism.

Definition B.10. Given arrows $A \rightarrow B$ and $B \rightarrow D$, a (natural) **pushout complement** is an object C together with arrows $A \rightarrow C$ and $C \rightarrow D$ such that the resulting square is a (natural) **pushout**.

Appendix C

Abstract Reduction Systems

The definitions and theorems in this appendix are derived from Chapter 2 of [48], Section 2.2 of [98], and Section 1.1 of [99].

C.1 Foundations

Definition C.1. An **abstract reduction system** (ARS) is a pair (A, \rightarrow) where A is a **set** and \rightarrow a **binary relation** on A .

Definition C.2. Let (A, \rightarrow) be an ARS. We define the notation:

1. **Composition:** $\xrightarrow{n} := \rightarrow^n$ ($n \geq 0$);
2. **Transitive closure:** $\xrightarrow{+} := \bigcup_{n \geq 1} \xrightarrow{n}$;
3. **Reflexive transitive closure:** $\xrightarrow{*} := \xrightarrow{+} \cup \xrightarrow{0}$;
4. **Reflexive closure:** $\xrightarrow{=} := \rightarrow \cup \xrightarrow{0}$;
5. **Inverse:** $\leftarrow := \rightarrow^{-1}$;
6. **Symmetric closure:** $\leftrightarrow := \rightarrow \cup \leftarrow$.

Remark C.1. It is usual, in practice, that \rightarrow is **decidable**. This **does not** imply that $\xrightarrow{+}$ is **decidable**, only that \xrightarrow{n} is **decidable**.

Definition C.3. Let (A, \rightarrow) be an ARS. We say that:

1. x is **reducible** iff there is a y s.t. $x \rightarrow y$;
2. x is in **normal form** iff x is not reducible;
3. y is a **normal form** of x iff $x \xrightarrow{*} y$ and y is in normal form. If x has a **unique normal form**, it is denoted $x \downarrow$;
4. y is a **successor** to x iff $x \xrightarrow{+} y$, and a **direct successor** iff $x \rightarrow y$;
5. x and y are **joinable** iff there is a z s.t. $x \xrightarrow{*} z \xleftarrow{*} y$. We write $x \downarrow y$.

C.2 Termination

Definition C.4. Let (A, \rightarrow) be an ARS. Then \rightarrow is called **terminating** iff there is no infinite descending chain $x_0 \rightarrow x_1 \rightarrow \dots$.

Remark C.2. Other texts call a **terminating** reduction **uniformly terminating** or **Noetherian**, or say it satisfies the **descending chain condition**.

The principle of **Noetherian induction** (**well-founded induction**) is a generalisation of induction from $(\mathbb{N}, >)$ to any **terminating** reduction system.

Definition C.5. Let (A, \rightarrow) be an ARS, and P is some property of the elements of A . Then the inference rule for **Noetherian Induction** is:

$$\frac{\forall x \in A, (\forall y \in A, x \xrightarrow{+} y \Rightarrow P(y)) \Rightarrow P(x)}{\forall x \in A, P(x)}$$

Theorem C.1 (Noetherian Induction). Let (A, \rightarrow) be an ARS. The following are equivalent for an ARS:

1. The principle of **Noetherian induction** holds;
2. \rightarrow is **well-founded** (Definition A.26);
3. \rightarrow is **terminating** (Definition C.4).

Definition C.6. Let (A, \rightarrow) be an ARS. Then \rightarrow is called

1. **Finitely branching** iff each a has only finitely many direct successors;
2. **Globally finite** iff each a has only finitely many successors;
3. **Acyclic** iff there is no a such that $a \xrightarrow{+} a$.

Lemma C.1. Let (A, \rightarrow) be an ARS. Then:

1. If \rightarrow is **finitely branching** and **terminating**, then it is **globally finite**;
2. If \rightarrow is **acyclic** and **globally finite**, then it is **terminating**;
3. \rightarrow is **acyclic** iff $\xrightarrow{+}$ is a **strict order**.

Definition C.7. Let (A, \rightarrow) be an ARS. Then \rightarrow is called **normalising** iff every element has a **normal form** (Definition C.3).

Lemma C.2. Let (A, \rightarrow) be an ARS. If \rightarrow is **terminating**, then every element has at least one **normal form**.

Lemma C.3. A **finitely branching** reduction **terminates** iff there is a **monotone** (Definition A.27) embedding into $(\mathbb{N}, >)$.

Remark C.3. The **union** of two **terminating** reductions need not be **terminating**.

C.3 Confluence

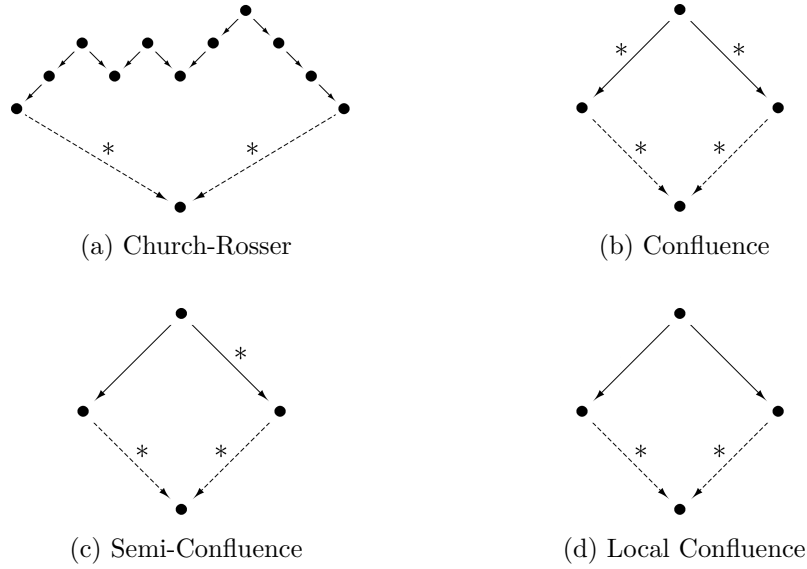

Figure C.1: Confluence Properties

Definition C.8. Let (A, \rightarrow) be an ARS. Then \rightarrow is called:

1. **Church-Rosser** iff $x \xrightarrow{*} y$ implies $x \downarrow y$;
2. **Confluent** iff $y_1 \xleftarrow{*} x \xrightarrow{*} y_2$ implies $y_1 \downarrow y_2$;
3. **Semi-confluent** iff $y_1 \leftarrow x \xrightarrow{*} y_2$ implies $y_1 \downarrow y_2$;
4. **Locally confluent** iff $y_1 \leftarrow x \rightarrow y_2$ implies $y_1 \downarrow y_2$;
5. **Convergent** iff it is both confluent and terminating.

Theorem C.2 (Church-Rosser). Let (A, \rightarrow) be an ARS. Then, the following are equivalent:

1. \rightarrow is **Church-Rosser**;
2. \rightarrow is **semi-confluent**;
3. \rightarrow is **confluent**.

Lemma C.4. Let (A, \rightarrow) be an ARS. If \rightarrow is **confluent**, then:

1. Every element has at most one **normal form**;
2. If \rightarrow is **normalising**, then $x \xrightarrow{*} y$ iff $x \downarrow = y \downarrow$.

Theorem C.3 (Newman's Lemma). A **terminating** reduction is **confluent** iff it is **locally confluent**.

Appendix D

Graph Transformation

We give a quick introduction to the theory of algebraic graph transformation derived from my earlier literature review [100], which is in turn derived from [5]. This Appendix should be read along side Chapter 1, since definitions are split between that Chapter and this Appendix, such as the definition of an unlabelled graph (Section 1.1).

Compared to [100], we generalise to **partially labelled graphs** using [12] and [101], in that we allow **relabelling** of **totally labelled graphs**. The additional sections on pushouts and pullbacks and critical pair analysis is derived from [5] and [101], the section on rooted graphs from [26], and the section on edge replacement grammars from [102] and [103]. The proof of Theorem D.3 is by Habel and Plump [12], and of Theorem D.4 is given by the proof of Theorem 1.1 which is due to Plump [16], [44], [45].

D.1 Partially Labelled Graphs

Definition D.1. A label alphabet $\mathcal{L} = (\mathcal{L}_V, \mathcal{L}_E)$ consists of **finite** sets of **node labels** \mathcal{L}_V and **edge labels** \mathcal{L}_E .

Definition D.2. A **concrete partially labelled graph** over a label alphabet \mathcal{L} is a **concrete graph** equipped with two **partial** label maps $l : V \rightarrow \mathcal{L}_V$, $m : E \rightarrow \mathcal{L}_E$: $G = (V, E, s, t, l, m)$.

$$\mathcal{L}_E \xleftarrow{m} E \begin{array}{c} \xrightarrow{s} \\ \xrightarrow{t} \end{array} V \xrightarrow{l} \mathcal{L}_V$$

Figure D.1: Partially Labelled Graph Diagram

Remark D.1. By this definition, we **do not** work with the free monoid on the alphabet, as in string rewriting systems. Nodes and edges are labelled exactly with the elements from the respective alphabets.

Definition D.3. We say that a **partially labelled graph** G is **totally labelled** iff l_G is total.

Definition D.4. Given a common \mathcal{L} , a **partially labelled graph morphism** $g : G \rightarrow H$ is a graph morphism on the underlying concrete graphs, with the extra constraint that labels must be preserved, if defined. That is:

1. $\forall e \in E_G, g_V(s_G(e)) = s_H(g_E(e));$ [Sources]
2. $\forall e \in E_G, g_V(t_G(e)) = t_H(g_E(e));$ [Targets]
3. $\forall e \in E_G, m_G(e) = m_H(g_E(e));$ [Edge Labels]
4. $\forall v \in l_G^{-1}(\mathcal{L}_V), l_G(v) = l_H(g_V(v)).$ [Node Labels]

Definition D.5. Given a common \mathcal{L} , a partially labelled graph morphism $g : G \rightarrow H$ is **undefinedness preserving** iff $l_G = l_H \circ g_V$.

Definition D.6. Given a common \mathcal{L} , a partially labelled graph morphism $g : G \rightarrow H$ is **injective/surjective** iff the underlying graph morphism is injective/surjective.

Definition D.7. Given a common \mathcal{L} , we say H is a **subgraph** of G iff there exists an **inclusion morphism** $H \hookrightarrow G$. This happens iff $V_H \subseteq V_G, E_H \subseteq E_G, s_H = s_G|_{E_H}, t_H = t_G|_{E_H}, m_H = m_G|_{E_G}, l_H \subseteq l_G$.

Remark D.2. Given a **totally labelled graph** G , and H **partially labelled**. If there exists a **surjective morphism** $G \rightarrow H$, then H is **totally labelled**.

Definition D.8. We say that graphs G, H are **isomorphic** iff there exists an **injective, surjective** graph morphism $g : G \rightarrow H$ such that $g^{-1} : H \rightarrow G$ is a graph morphism. We write $G \cong H$, and call g an **isomorphism**. This naturally gives rise to **equivalence classes** $[G]$: the **countably** many partially labelled abstract graphs over some fixed \mathcal{L} .

D.2 Typed Graphs

Definition D.9. A **typed graph** is the tuple $G_T = (G, type_G)$ where G is an **unlabelled graph**, and $type_G$ is a graph morphism $G \rightarrow TG$ where TG is an **unlabelled graph** called a **type graph**. The vertices and edges of TG are called the **node alphabet** and **edge alphabet**.

Definition D.10. Given two **typed graphs** G_T, H_T , a **typed graph morphism** is an **unlabelled graph morphism** $f : G \rightarrow H$ such that $type_H \circ f = type_G$.

Theorem D.1 (Typed-Labelled Graph Correspondence). There is a **bijective correspondence** between the **totally labelled graphs** over some fixed **label alphabet** \mathcal{L} and the **typed graphs** over \mathcal{L} .

D.3 Pushouts and Pullbacks

The following propositions hold in the category of unlabelled (totally labelled) graphs, but not necessarily for partially labelled graphs.

Proposition D.1. Every pushout satisfies the following:

1. **No junk:** Each item in D has a preimage in B or C .
2. **No confusion:** If $A \rightarrow B$, $A \rightarrow C$ monic, then $B \rightarrow D$, $C \rightarrow D$ monic and an item from B is merged in D with an item from C only if the items have a common preimage in A .

Proposition D.2. A pushout is **natural** if $A \rightarrow B$ is **monic**.

Theorem D.2 (Limit Existence). **Pushouts, pushout complements, and pullbacks** always exist.

D.4 Rules and Derivations

Let $\mathcal{L} = (\mathcal{L}_V, \mathcal{L}_E)$ be the ambient label alphabet, and graphs be concrete.

Definition D.11. A **rule** $r = \langle L \leftarrow K \rightarrow R \rangle$ consists of **totally labelled graphs** L, R over \mathcal{L} , the **partially labelled graph** K over \mathcal{L} , and **inclusions** $K \hookrightarrow L$ and $K \hookrightarrow R$.

Definition D.12. We define the **inverse rule** to be $r^{-1} = \langle R \leftarrow K \rightarrow L \rangle$.

Definition D.13. If $r = \langle L \leftarrow K \rightarrow R \rangle$ is a **rule**, then $|r| = \max\{|L|, |R|\}$.

Definition D.14. Given a **rule** $r = \langle L \leftarrow K \rightarrow R \rangle$ and a **totally labelled graph** G , we say that an **injective** morphism $g : L \hookrightarrow G$ satisfies the **dangling condition** iff no edge in $G \setminus g(L)$ is incident to a node in $g(L \setminus K)$.

$$\begin{array}{ccccc}
 L & \longleftarrow & K & \longrightarrow & R \\
 \downarrow g & & \downarrow d & & \downarrow h \\
 G & \longleftarrow & D & \longrightarrow & H
 \end{array}$$

Figure D.2: Direct Derivation

Definition D.15. To **apply** a rule $r = \langle L \leftarrow K \rightarrow R \rangle$ to some **totally labelled graph** G , find an **injective** graph morphism $g : L \hookrightarrow G$ satisfying the **dangling condition**, then:

1. Delete $g(L \setminus K)$ from G , and for each unlabelled node v in K , make $g_V(v)$ unlabelled, giving the **intermediate graph** D ;
2. Add disjointly $R \setminus K$ to D , keeping their labels, and for each unlabelled node v in K , label $g_V(v)$ with $l_R(v)$, giving the **result graph** H .

If the **dangling condition** fails, then the rule is not applicable using the **match** g . We can exhaustively check all matches to determine applicability.

Definition D.16. We write $G \Rightarrow_{r,g} M$ for a successful application of r to G using match g , obtaining result $M \cong H$. We call Figure D.2 a **direct derivation**, and the injective morphism h the **comatch**.

Theorem D.3 (Derivation Theorem). It turns out that **deletions** are **natural pushout complements** and **gluings** are **natural pushouts** in the category of partially labelled graphs. Moreover, direct derivations are **natural double pushouts**, D and H are **unique up to isomorphism**, and H is **totally labelled**. Moreover, derivations $G \Rightarrow_{r,g} H$ are **invertible**.

Definition D.17. Given a rule set \mathcal{R} , we define $\mathcal{R}^{-1} = \{r^{-1} \mid r \in \mathcal{R}\}$.

Definition D.18. For a given set of rules \mathcal{R} , we write $G \Rightarrow_{\mathcal{R}} H$ iff H is **directly derived** from G using any of the rules from \mathcal{R} .

Definition D.19. We write $G \Rightarrow_{\mathcal{R}}^+ H$ iff H is **derived** from G in one or more **direct derivations**, and $G \Rightarrow_{\mathcal{R}}^* H$ iff $G \cong H$ or $G \Rightarrow_{\mathcal{R}}^+ H$.

D.5 Transformation Systems

Definition D.20. A **graph transformation system** $T = (\mathcal{L}, \mathcal{R})$, consists of a label alphabet $\mathcal{L} = (\mathcal{L}_V, \mathcal{L}_E)$, and a **finite** set \mathcal{R} of rules over \mathcal{L} .

Proposition D.3. Given a **graph transformation system** $T = (\mathcal{L}, \mathcal{R})$, then one can always decide if $G \Rightarrow_{\mathcal{R}} H$.

Definition D.21. Given a **graph transformation system** $T = (\mathcal{L}, \mathcal{R})$, we define the inverse system $T^{-1} = (\mathcal{L}, \mathcal{R}^{-1})$.

Definition D.22. Given a label alphabet $\mathcal{L} = (\mathcal{L}_V, \mathcal{L}_E)$, $\mathcal{P} = (\mathcal{P}_V, \mathcal{P}_E)$ is a **subalphabet** of \mathcal{L} iff $\mathcal{P}_V \subseteq \mathcal{L}_V$ and $\mathcal{P}_E \subseteq \mathcal{L}_E$. We define the other standard set operations pairwise too, such as union, intersection, and difference of alphabets.

Definition D.23. Given a **graph transformation system** $T = (\mathcal{L}, \mathcal{R})$, a subalphabet of **non-terminals** \mathcal{N} , and a **start graph** S over \mathcal{L} , then a **graph grammar** is the system $\mathbf{G} = (\mathcal{L}, \mathcal{N}, \mathcal{R}, S)$.

Definition D.24. Given a **graph grammar** \mathbf{G} as defined above, we say that a graph G is **terminally labelled** iff $l(V) \cap \mathcal{N}_V = \emptyset$ and $m(E) \cap \mathcal{N}_E = \emptyset$. Thus, we can define the **graph language** generated by \mathbf{G} :

$$\mathbf{L}(\mathbf{G}) = \{[G] \mid S \Rightarrow_{\mathcal{R}}^* G, G \text{ terminally labelled}\}$$

Proposition D.4. Given a **graph grammar** $\mathbf{G} = (\mathcal{L}, \mathcal{N}, \mathcal{R}, S)$, $G \Rightarrow_r H$ iff $H \Rightarrow_{r^{-1}} G$, for some $r \in \mathcal{R}$ (simply use the comatch). Moreover, $[G] \in \mathbf{L}(\mathbf{G})$ iff $G \Rightarrow_{\mathcal{R}^{-1}}^* S$ and G is terminally labelled.

Remark D.3. Graph languages need not be finite. In fact, graph grammars are as powerful as unrestricted string grammars. As such, many questions like if the language is empty, are undecidable in general.

D.6 Confluence and Termination

Let $T = (\mathcal{L}, \mathcal{R})$ be a graph transformation system.

Definition D.25. The graphs H_1, H_2 are **joinable** iff there is a graph M such that $H_1 \Rightarrow_{\mathcal{R}}^* M \Leftarrow_{\mathcal{R}}^* H_2$.

Definition D.26. T is **locally confluent** iff for all graphs G, H_1, H_2 such that $H_1 \Leftarrow_{\mathcal{R}} G \Rightarrow_{\mathcal{R}} H_2$, H_1 and H_2 are **joinable**.

Definition D.27. T is **confluent** iff for all graphs G, H_1, H_2 such that $H_1 \Leftarrow_{\mathcal{R}}^* G \Rightarrow_{\mathcal{R}}^* H_2$, H_1 and H_2 are **joinable**.

Definition D.28. T is **terminating** iff there is no infinite derivation sequence $G_0 \Rightarrow_{\mathcal{R}} G_1 \Rightarrow_{\mathcal{R}} G_2 \Rightarrow_{\mathcal{R}} G_3 \Rightarrow_{\mathcal{R}} \dots$.

Theorem D.4 (Property Undecidability). Testing if T has (**local**) **confluence** or is **terminating** is **undecidable** in general.

D.7 Critical Pair Analysis

Throughout this section, we fix some common label alphabet $\mathcal{L} = (\mathcal{L}_V, \mathcal{L}_E)$, and also require that the **interface** in all rules to be **totally labelled**.

Definition D.29. The derivations $G_1 \Rightarrow_{r_1, g_1} H \Rightarrow_{r_2, g_2} G_2$ are **sequentially independent** iff $(h_1(R_1) \cap g_2(L_2)) \subseteq (h_1(K_1) \cap g_2(K_2))$.

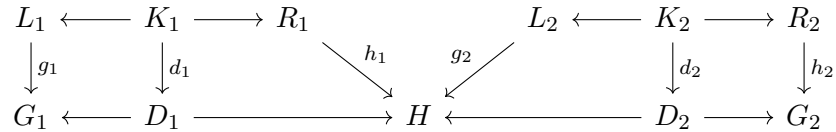

Figure D.3: Sequential Independence Diagram

Lemma D.1. The derivations $G_1 \Rightarrow_{r_1, g_1} H \Rightarrow_{r_2, g_2} G_2$ are **sequentially independent** iff there exist morphisms $R_1 \rightarrow D_2$ and $L_2 \rightarrow D_1$ with $R_1 \rightarrow D_1 \rightarrow H = R_1 \rightarrow H$ and $L_1 \rightarrow D_2 \rightarrow H = L_2 \rightarrow H$.

Theorem D.5 (Sequential Independence). If $G_1 \Rightarrow_{r_1, g_1} H \Rightarrow_{r_2, g_2} G_2$ are **sequentially independent**, then there exists a graph H' and **sequentially independent** steps $G \Rightarrow_{r_2} H' \Rightarrow_{r_1} G_2$.

Definition D.30. The derivations $H_1 \Leftarrow_{r_1, g_1} G \Rightarrow_{r_2, g_2} H_2$ are **parallelly independent** iff $(g_1(L_1) \cap g_2(L_2)) \subseteq (g_1(K_1) \cap g_2(K_2))$.

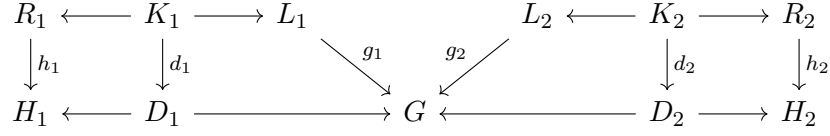

Figure D.4: Parallel Independence Diagram

Lemma D.2. The derivations $H_1 \leftarrow_{r_1, g_1} G \Rightarrow_{r_2, g_2} H_2$ are **parallelly independent** iff there exist morphisms $L_1 \rightarrow D_2$ and $L_2 \rightarrow D_1$ with $L_1 \rightarrow D_2 \rightarrow G = L_1 \rightarrow G$ and $L_2 \rightarrow D_1 \rightarrow G = L_2 \rightarrow G$.

Remark D.4. The derivations $H_1 \leftarrow_{r_1, g_1} G \Rightarrow_{r_2, g_2} H_2$ are **parallelly independent** iff $H_1 \Rightarrow_{r_1^{-1}, h_1} G \Rightarrow_{r_2, g_2} H_2$ are **sequentially independent**.

Theorem D.6 (Parallel Independence). If $H_1 \leftarrow_{r_1, g_1} G \Rightarrow_{r_2, g_2} H_2$ are **parallelly independent**, then there exists a graph G' and **direct derivations** $H_1 \Rightarrow_{r_2} G' \leftarrow_{r_1} H_2$ with $G \Rightarrow_{r_1} H_1 \Rightarrow_{r_2} G'$ and $G \Rightarrow_{r_2} H_2 \Rightarrow_{r_1} G'$ **sequentially independent**.

Definition D.31. A pair of **direct derivations** $G_1 \leftarrow_{r_1, g_1} H \Rightarrow_{r_2, g_2} G_2$ is a **critical pair** iff $H = g_1(L_1) \cup g_2(L_2)$, the steps are not **parallelly independent**, and if $r_1 = r_2$ then $g_1 \neq g_2$.

Lemma D.3. Every graph transformation system has, up to isomorphism, only finitely many critical pairs.

Definition D.32. Let $G \Rightarrow H$ be a **direct derivation**. Then the **track morphism** is defined to be the partial morphism $tr_{G \Rightarrow H} = in' \circ in^{-1}$, where in and in' are the bottom left and right morphisms in Figure D.2, respectively. We define $tr_{G \Rightarrow^* H}$ inductively as the composition of track morphisms.

Definition D.33. The set of **persistent nodes** of a critical pair $\Phi : H_1 \leftarrow G \Rightarrow H_2$ is $Persist_\Phi = \{v \in G_V \mid tr_{G \Rightarrow H_1}(\{v\}), tr_{G \Rightarrow H_2}(\{v\}) \neq \emptyset\}$. That is, those nodes that are not deleted by the application of either rule.

Definition D.34. A critical pair $\Phi : H_1 \leftarrow G \Rightarrow H_2$ is **strongly joinable** iff it is **joinable** without deleting any of the persistent nodes, and the persistent nodes are identified. That is, there is a graph M and derivations $H_1 \Rightarrow_{\mathcal{R}}^* M \leftarrow_{\mathcal{R}}^* H_2$ such that $\forall v \in Persist_\Phi, tr_{G \Rightarrow H_1 \Rightarrow^* M}(\{v\}) = tr_{G \Rightarrow H_2 \Rightarrow^* M}(\{v\}) \neq \emptyset$.

Theorem D.7 (Critical Pair Lemma). A graph transformation system T is **locally confluent** if all its **critical pairs** are **strongly joinable**.

Remark D.5. The reverse direction of this theorem is false, as this would contradict the undecidability of checking for confluence. If we find a non-joinable critical pair, we have non-confluence, and if we have all critical pairs joinable, but not all strongly, we can draw no conclusions.

D.8 Rooted Graph Transformation

We fix some common label alphabet $\mathcal{L} = (\mathcal{L}_V, \mathcal{L}_E)$, and allow rules to have a partially labelled interface again.

Definition D.35. Let G be a **partially labelled graph**, and $P_G \subseteq V_G$ be a set of **root nodes**. Then a **rooted partially labelled graph** is the tuple $\widehat{G} = (G, P_G)$.

Definition D.36. Given two **rooted partially labelled graphs** \widehat{G}, \widehat{H} , a **partially labelled graph morphism** $g : G \rightarrow H$ is a **rooted labelled graph morphism** $\widehat{G} \rightarrow \widehat{H}$ iff $g_V(P_G) \subseteq P_H$. A morphism $g : \widehat{G} \rightarrow \widehat{H}$ is **injective/surjective** iff the underlying graph morphism is injective/surjective. **Inclusion morphisms** and **subgraphs** are defined in the obvious way.

Definition D.37. We say that **rooted partially labelled graphs** \widehat{G}, \widehat{H} are **isomorphic** iff there exists an **injective, surjective** morphism $g : \widehat{G} \rightarrow \widehat{H}$ such that $g^{-1} : \widehat{H} \rightarrow \widehat{G}$ is also a morphism, and we write $\widehat{G} \cong \widehat{H}$. This naturally gives rise to **equivalence classes** $[\widehat{G}]$: the **countably** many rooted partially labelled abstract graphs over some fixed \mathcal{L} .

Definition D.38. **Direct derivations** on **rooted totally labelled graphs** are defined analogously as for **totally labelled graphs**, but with the following modifications to the rule application process (Definition D.15):

1. The root nodes of the **intermediate graph** are $P_G \setminus g_V(P_L \setminus P_K)$.
2. The root nodes of the **result graph** are $P_D \cup h_V(P_R \setminus P_K)$.

We write $\widehat{G} \Rightarrow_{r,g} \widehat{M}$ for a successful application of r to \widehat{G} using match g , obtaining result $\widehat{H} \cong \widehat{M}$. We call this a **direct derivation**. Definitions D.18 and D.19 are analogous.

Theorem D.8 (Rooted Derivation Uniqueness). The **result graph** of a **direct derivation** is **unique up to isomorphism** and is **totally labelled**.

Definition D.39. A **rooted graph transformation system** $\widehat{T} = (\mathcal{L}, \widehat{\mathcal{R}})$, consists of a label alphabet \mathcal{L} , and a **finite** set $\widehat{\mathcal{R}}$ of rules over \mathcal{L} .

Proposition D.5. Given a **rooted graph transformation system** $\widehat{T} = (\mathcal{L}, \widehat{\mathcal{R}})$, then one can always decide if $\widehat{G} \Rightarrow_{\widehat{\mathcal{R}}} \widehat{H}$.

Definition D.40. Given a **rooted graph transformation system** $\widehat{T} = (\mathcal{L}, \widehat{\mathcal{R}})$, a subalphabet of **non-terminals** \mathcal{N} , and a **start graph** \widehat{S} over \mathcal{L} , then a **rooted graph grammar** is the system $\widehat{G} = (\mathcal{L}, \mathcal{N}, \widehat{\mathcal{R}}, \widehat{S})$.

Definition D.41. Given a **rooted graph grammar** \widehat{G} as defined above, we say that a graph \widehat{G} is **terminally labelled** iff $l(V) \cap \mathcal{N}_V = \emptyset$ and $m(E) \cap \mathcal{N}_E = \emptyset$. Thus, we can define the **graph language**:

$$L(\widehat{G}) = \{[\widehat{G}] \mid \widehat{S} \Rightarrow_{\widehat{\mathcal{R}}}^* \widehat{G}, \widehat{G} \text{ terminally labelled}\}$$

D.9 Edge Replacement Grammars

One can describe edge replacement grammars in terms of DPO-grammars.

Definition D.42. An **edge replacement** (DPO-)grammar is a tuple $\mathbf{G} = (\mathcal{L}, \mathcal{N}, \mathcal{R}, S)$ where $\mathcal{L}_V = \{\square\}$, $\mathcal{N}_V = \emptyset$, $S = \bullet \xrightarrow{a} \bullet$ for some $a \in \mathcal{N}_E$, and the rules in \mathcal{R} are of the form given in Figure D.5 for some $a \in \mathcal{N}_E$ and arbitrary graph R over \mathcal{L} .

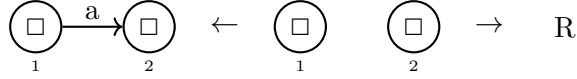

Figure D.5: Edge Replacement Rule

Theorem D.9 (Decidable Membership Problem). The **membership problem** for **edge replacement** grammars is in NP . Moreover, there exists a grammar such that the problem is NP -complete.

Corollary D.1. There exists a **recursively enumerable** set of graphs that cannot be generated by an **edge replacement** grammar. Moreover, the **edge replacement** grammars generate a **recursive** class of languages.

Appendix E

Graph Theory

In standard literature, ‘graph theory’ is the mathematical study of ‘graphs’, where in this context a graph is a finite set of vertices with (directed) edges between them, without parallel edges. We will present this theory in terms of the more general notion of a (labelled) graph from Appendix D. The definitions and theorems in this appendix have been adapted from [104], [105], Chapter 1 of [106], and Chapter 3 of [107].

E.1 Basic Definitions

Definition E.1. Given a concrete graph G , $v \in V_G$, we define the:

1. **Incoming degree:** $\text{indeg}_G(v) = |t_G^{-1}(\{v\})|$;
2. **Outgoing degree:** $\text{outdeg}_G(v) = |s_G^{-1}(\{v\})|$;
3. **Degree:** $\text{deg}_G(v) = \text{indeg}_G(v) + \text{outdeg}_G(v)$;
4. **Neighbourhood:** $N_G(v) = s_G(t_G^{-1}(\{v\})) \cup t_G(s_G^{-1}(\{v\}))$;
5. **Closed neighbourhood:** $N_G[v] = N_G(v) \cup \{v\}$.

Definition E.2. Given a concrete graph G , $v \in V_G$, we:

1. Say $v \in V_G$ is a **leaf node** iff $\text{outdeg}_G(v) = 0$;
2. Say $u, v \in V_G$ are **adjacent** iff $\{u, v\} \subseteq N[u] \cap N[v]$;
3. Say $e \in E_G$ is **proper** iff $s_G(e) \neq t_G(e)$.

Definition E.3. We say two proper edges $e, f \in E_G$ are **parallel** iff $[s_G(e) = s_G(f) \text{ and } t_G(e) = t_G(f)]$ or $[s_G(e) = t_G(f) \text{ and } s_G(e) = t_G(f)]$.

Definition E.4. Let G be a concrete graph. Then:

1. An **undirected walk** of length k is a non-empty, finite sequence of alternating vertices and edges in G : $\langle v_0, e_0, v_1, e_1, \dots, e_{k-1}, v_k \rangle$, such that for each e_i ($0 \neq i < k$), $[s_G(e_i) = v_i \text{ and } t_G(e_i) = v_{i+1}]$ or $[s_G(e_i) = v_{i+1} \text{ and } t_G(e_i) = v_i]$;

2. A **walk** is an undirected walk such that for each e_i ($0 \leq i < k$), $s_G(e_i) = v_i$ and $t_G(e_i) = v_{i+1}$;
3. We call a (undirected) walk **closed** iff $v_0 = v_k$;
4. If the vertices v_i of a **walk** are all **distinct** (except possibly $v_0 = v_k$), we call the walk a **path**;
5. A **closed walk** is called a **cycle**; a graph with no cycles is **acyclic**. Similarly, a **closed undirected walk** is called an **undirected cycle**.

Definition E.5. A graph is called **connected** iff there is an undirected walk between every pair of distinct vertices. A **connected component** of a concrete graph G is a **maximal** connected subgraph.

Theorem E.1 (Graph Decomposition). Every concrete graph G has a unique decomposition into **connected components**.

Definition E.6. Given a concrete graph G , $v \in V_G$ we define the:

1. **Children:** $\text{children}_G(v) = t_G(s_G^{-1}(\{v\}))$;
2. **Parents:** $\text{parents}_G(v) = s_G(t_G^{-1}(\{v\}))$.

u is a **child** of v iff $u \in \text{children}_G(v)$, and a **parent** iff $u \in \text{parents}_G(v)$.

Proposition E.1. Given a concrete graph G , $v \in V_G$. Then:

1. $\text{children}_G(v) \subseteq N_G(v)$ and $\text{parents}_G(v) \subseteq N_G(v)$;
2. $|\text{children}_G(v)| \leq \text{outdeg}_G(v)$ and $|\text{parents}_G(v)| \leq \text{indeg}_G(v)$.

E.2 Classes of Graphs

Definition E.7. We say a graph class is of **bounded degree** iff there exists some $b \in \mathbb{N}$ such that for all graphs G in the class, $\forall v \in V_G, \text{deg}(v) \leq b$.

Definition E.8. A graph is called **discrete** iff it has no edges.

Definition E.9. A **tree** is a non-empty connected graph without undirected cycles such that every node has at most one incoming edge. Moreover:

1. A **linked list** is a **tree** such that every node has outgoing degree at most 1;
2. A **binary tree** is a **tree** such that every node has outgoing degree at most 2;
3. A **full binary tree** is a **binary tree** such that every node has either 0 or 2 children;
4. A **perfect binary tree** is a **full binary tree** such that every **maximal path** is the same length;
5. A **forest** is a graph where each **connected component** is a **tree**.

Proposition E.2. A **tree** is a graph containing a node from which there is a unique **directed path** to each node in the graph.

Definition E.10. A $n \times m$ -**grid graph** is a graph with underlying unlabelled graph isomorphic to (V, E, s, t) where $V = \mathbb{Z}_n \times \mathbb{Z}_m$, $E = (\mathbb{Z}_2 \times V) \setminus \{(0, i, m-1), (1, n-1, j) \mid i \in \mathbb{Z}_n, j \in \mathbb{Z}_m\}$, $s(d, i, j) = (i, j)$, and $t(d, i, j) = (i + d, j + 1 - d)$. We call such a graph **square** iff $n = m$.

Definition E.11. An n -**star graph** is a graph with underlying unlabelled graph isomorphic to (V, E, s, t) where $V = \mathbb{Z}_{n+1}$, $E = \mathbb{Z}_n$, and:

$$s(i) = \begin{cases} n & \text{if } i \equiv 0 \pmod{2} \\ i & \text{otherwise} \end{cases} \quad t(i) = \begin{cases} n & \text{if } i \equiv 1 \pmod{2} \\ i & \text{otherwise} \end{cases}$$

An example linked list, perfect binary tree, square grid graph, and star graph can be found in Figure 3.7.

Bibliography

- [1] H. Ehrig, M. Pfender and H. Schneider, ‘Graph-grammars: An algebraic approach’, in *Proc. 14th Annual Symposium on Switching and Automata Theory (SWAT 1973)*, P. Lewis and J. Brzozowski, Eds., IEEE, 1973, pp. 167–180. DOI: 10.1109/SWAT.1973.11.
- [2] H. Ehrig, ‘Introduction to the algebraic theory of graph grammars (a survey)’, in *Proc. International Workshop on Graph-Grammars and Their Application to Computer Science and Biology*, V. Claus, H. Ehrig and G. Rozenberg, Eds., ser. Lecture Notes in Computer Science, vol. 73, Springer, 1979, pp. 1–69. DOI: 10.1007/BFb0025714.
- [3] A. Corradini, U. Montanari, F. Rossi, H. Ehrig, R. Heckel and M. Löwe, ‘Algebraic approaches to graph transformation. Part I: Basic concepts and double pushout approach’, in *Handbook of Graph Grammars and Computing by Graph Transformation, Volume 1: Foundations*, G. Rozenberg, Ed. World Scientific, 1997, pp. 163–245. DOI: 10.1142/9789812384720_0003.
- [4] H. Ehrig, R. Heckel, M. Korff, M. Löwe, L. Ribeiro, A. Wagner and A. Corradini, ‘Algebraic approaches to graph transformation. Part II: Single pushout approach and comparison with double pushout approach’, in *Handbook of Graph Grammars and Computing by Graph Transformation, Volume 1: Foundations*, G. Rozenberg, Ed. World Scientific, 1997, pp. 247–312. DOI: 10.1142/9789812384720_0004.
- [5] H. Ehrig, K. Ehrig, U. Prange and G. Taentzer, *Fundamentals of algebraic graph transformation*, ser. Monographs in Theoretical Computer Science. An EATCS Series. Springer, 2006. DOI: 10.1007/3-540-31188-2.
- [6] A. Corradini, F. Rossi and F. Parisi-Presicce, ‘Logic programming as hypergraph rewriting’, in *Proc. 4th International Joint Conference on Theory and Practice of Software Development (TAPSOFT ’91)*, S. Abramsky and T. Maibaum, Eds., ser. Lecture Notes in Computer Science, vol. 493, Springer, 1991, pp. 275–295. DOI: 10.1007/3-540-53982-4_16.

- [7] A. Corradini, H. Ehrig, H.-J. Kreowski and G. Rozenberg, Eds., *Proc. first international conference on graph transformation (ICGT 2002)*, vol. 2505, ser. Lecture Notes in Computer Science, Springer, 2002. DOI: 10.1007/3-540-45832-8.
- [8] H. Ehrig, G. Engels, F. Parisi-Presicce and G. Rozenberg, Eds., *Proc. second international conference on graph transformation (ICGT 2004)*, vol. 3256, ser. Lecture Notes in Computer Science, Springer, 2004. DOI: 10.1007/b100934.
- [9] A. Corradini, H. Ehrig, U. Montanari, L. Ribeiro and G. Rozenberg, Eds., *Proc. third international conference on graph transformation (ICGT 2006)*, vol. 4178, ser. Lecture Notes in Computer Science, Springer, 2006. DOI: 10.1007/11841883.
- [10] H. Dörr, *Efficient graph rewriting and its implementation*, ser. Lecture Notes in Computer Science. Springer, 1995, vol. 922. DOI: 10.1007/BFb0031909.
- [11] C. Bak, ‘GP 2: Efficient implementation of a graph programming language’, PhD thesis, Department of Computer Science, University of York, UK, 2015. [Online]. Available: <https://etheses.whiterose.ac.uk/12586/>.
- [12] A. Habel and D. Plump, ‘Relabelling in graph transformation’, in *Proc. First International Conference on Graph Transformation (ICGT 2002)*, A. Corradini, H. Ehrig, H.-J. Kreowski and G. Rozenberg, Eds., ser. Lecture Notes in Computer Science, vol. 2505, Springer, 2002, pp. 135–147. DOI: 10.1007/3-540-45832-8_12.
- [13] —, ‘ \mathcal{M}, \mathcal{N} -adhesive transformation systems’, in *Proc. 6th International Conference on Graph Transformation (ICGT 2012)*, H. Ehrig, G. Engels, H.-J. Kreowski and G. Rozenberg, Eds., ser. Lecture Notes in Computer Science, vol. 7562, Springer, 2012, pp. 218–233. DOI: 10.1007/978-3-642-33654-6_15.
- [14] M. Dodds and D. Plump, ‘Graph transformation in constant time’, in *Proc. Third International Conference on Graph Transformation (ICGT 2006)*, A. Corradini, H. Ehrig, U. Montanari, L. Ribeiro and G. Rozenberg, Eds., ser. Lecture Notes in Computer Science, vol. 4178, Springer, 2006, pp. 367–382. DOI: 10.1007/11841883_26.
- [15] D. Plump, ‘Checking graph-transformation systems for confluence’, in *Manipulation of Graphs, Algebras and Pictures: Essays Dedicated to Hans-Jörg Kreowski on the Occasion of His 60th Birthday*, F. Drewes, A. Habel, B. Hoffmann and D. Plump, Eds., ser. Electronic Communications of the EASST. 2010, vol. 26. DOI: 10.14279/tuj.eceasst.26.367.
- [16] —, ‘Hypergraph rewriting: Critical pairs and undecidability of confluence’, in *Term Graph Rewriting*, M. Sleep, M. Plasmeijer and M. van Eekelen, Eds. John Wiley and Sons, 1993, pp. 201–213.

- [17] H. Ehrig, L. Lambers and F. Orejas, ‘Efficient conflict detection in graph transformation systems by essential critical pairs’, *Electronic Notes in Theoretical Computer Science*, vol. 211, pp. 17–26, 2008. DOI: 10.1016/j.entcs.2008.04.026.
- [18] I. Hristakiev, ‘Confluence analysis for a graph programming language’, PhD thesis, Department of Computer Science, University of York, UK, 2018. [Online]. Available: <https://etheses.whiterose.ac.uk/20255/>.
- [19] L. Lambers, J. Kosiol, D. Strüber and G. Taentzer, ‘Exploring conflict reasons for graph transformation systems’, in *Proc. 12th International Conference on Graph Transformation (ICGT 2019)*, E. Guerra and F. Orejas, Eds., ser. Lecture Notes in Computer Science, vol. 11629, Springer, 2019, pp. 75–92. DOI: 10.1007/978-3-030-23611-3_5.
- [20] M. Dodds, ‘Graph transformation and pointer structures’, PhD thesis, Department of Computer Science, University of York, UK, 2008. [Online]. Available: <https://www.cs.york.ac.uk/plasma/publications/pdf/DoddsThesis.08.pdf>.
- [21] H. Ehrig, U. Golas, A. Habel, L. Lambers and F. Orejas, ‘ \mathcal{M} -adhesive transformation systems with nested application conditions. Part 1: Parallelism, concurrency and amalgamation’, *Mathematical Structures in Computer Science*, vol. 24, no. 4, p. 240406, 2014. DOI: 10.1017/S0960129512000357.
- [22] G. Campbell, B. Courtehouste and D. Plump, ‘Linear-time graph algorithms in GP2’, in *Proc. 8th Conference on Algebra and Coalgebra in Computer Science (CALCO 2019)*, M. Roggenbach and A. Sokolova, Eds., ser. Leibniz International Proceedings in Informatics (LIPIcs), To appear, vol. 139, Schloss Dagstuhl–Leibniz-Zentrum für Informatik, 2019.
- [23] R. Farrow, K. Kennedy and L. Zucconi, ‘Graph grammars and global program data flow analysis’, in *Proc. 17th Annual Symposium on Foundations of Computer Science (SFCS 1976)*, E. McCluskey and W. Semon, Eds., IEEE, 1976, pp. 42–56. DOI: 10.1109/SFCS.1976.17.
- [24] G. Campbell, ‘Efficient graph rewriting’, BSc Thesis, Department of Computer Science, University of York, UK, 2019. [Online]. Available: <https://cdn.gjcampbell.co.uk/2019/BSc-Project.pdf>, Erratum-ibid. Campbell [108].
- [25] G. Campbell, J. Romo and D. Plump, ‘Improving the GP2 compiler’, Department of Computer Science, University of York, UK, Tech. Rep., 2019. [Online]. Available: <https://cdn.gjcampbell.co.uk/2019/Improved-GP2-Compiler.pdf>.

- [26] C. Bak and D. Plump, ‘Rooted graph programs’, in *Proc. 7th International Workshop on Graph Based Tools (GraBaTs 2012)*, C. Krause and B. Westfechtel, Eds., ser. Electronic Communications of the EASST, vol. 54, 2012. DOI: 10.14279/tuj.eceasst.54.780.
- [27] F. Drewes, H.-J. Kreowski and A. Habel, ‘Hyperedge replacement graph grammars’, in *Handbook of Graph Grammars and Computing by Graph Transformation, Volume 1: Foundations*, G. Rozenberg, Ed. World Scientific, 1997, pp. 95–162. DOI: 10.1142/9789812384720_0002.
- [28] J. Engelfriet and G. Rozenberg, ‘Node replacement graph grammars’, in *Handbook of Graph Grammars and Computing by Graph Transformation, Volume 1: Foundations*, G. Rozenberg, Ed. World Scientific, 1997, pp. 1–94. DOI: 10.1142/9789812384720_0001.
- [29] M. Löwe, M. Korff and A. Wagner, ‘An algebraic framework for the transformation of attributed graphs’, in *Term Graph Rewriting*, M. Sleep, M. Plasmeijer and M. van Eekelen, Eds. John Wiley and Sons, 1993, pp. 185–199.
- [30] A. Corradini, U. Montanari and F. Rossi, ‘Graph processes’, *Fundamenta Informaticae*, vol. 26, no. 3–4, pp. 241–265, 1996. DOI: 10.3233/FI-1996-263402.
- [31] M. Berthold, I. Fischer and M. Koch, ‘Attributed graph transformation with partial attribution’, Technical University of Berlin, Germany, Tech. Rep., 2000.
- [32] R. Heckel, J. Küster and G. Taentzer, ‘Confluence of typed attributed graph transformation systems’, in *Proc. First International Conference on Graph Transformation (ICGT 2002)*, A. Corradini, H. Ehrig, H.-J. Kreowski and G. Rozenberg, Eds., ser. Lecture Notes in Computer Science, vol. 2505, Springer, 2002, pp. 161–176. DOI: 10.1007/3-540-45832-8_14.
- [33] H. Ehrig, U. Prange and G. Taentzer, ‘Fundamental theory for typed attributed graph transformation’, in *Proc. Second International Conference on Graph Transformation (ICGT 2004)*, H. Ehrig, G. Engels, F. Parisi-Presicce and G. Rozenberg, Eds., ser. Lecture Notes in Computer Science, vol. 3256, Springer, 2004, pp. 161–177. DOI: 10.1007/978-3-540-30203-2_13.
- [34] I. Hristakiev and D. Plump, ‘Attributed graph transformation via rule schemata: Church-rosser theorem’, in *Software Technologies: Applications and Foundations – STAF 2016 Collocated Workshops, Revised Selected Papers*, P. Milazzo, D. Varró and M. Wimmer, Eds., ser. Lecture Notes in Computer Science, vol. 9946, Springer, 2016, pp. 145–160. DOI: 10.1007/978-3-319-50230-4_11.

- [35] C. Peuser and A. Habel, ‘Composition of \mathcal{M}, \mathcal{N} -adhesive categories with application to attribution of graphs’, in *Graph Computation Models Selected Revised Papers from GCM 2015*, D. Plump, Ed., ser. Electronic Communications of the EASST, vol. 73, 2016. DOI: 10.14279/tuj.eceasst.73.1035.
- [36] R. Geiß, G. Batz, D. Grund, S. Hack and A. Szalkowski, ‘GrGen: A fast SPO-based graph rewriting tool’, in *Proc. Third International Conference on Graph Transformation (ICGT 2006)*, A. Corradini, H. Ehrig, U. Montanari, L. Ribeiro and G. Rozenberg, Eds., ser. Lecture Notes in Computer Science, vol. 4178, Springer, 2006, pp. 383–397. DOI: 10.1007/11841883_27.
- [37] G. Campbell, J. Romo and D. Plump, ‘Fast graph programs’, Department of Computer Science, University of York, UK, Tech. Rep., 2018. [Online]. Available: <https://cdn.gjccampbell.co.uk/2018/Fast-Graph-Programs.pdf>.
- [38] J. Hartmanis and R. Stearns, ‘On the computational complexity of algorithms’, *Transactions of the American Mathematical Society*, vol. 117, pp. 285–306, 1965. DOI: 10.1090/S0002-9947-1965-0170805-7.
- [39] K. Weihrauch, *Computable analysis: An introduction*, ser. Texts in Theoretical Computer Science. An EATCS Series. Springer, 2013. DOI: 10.1007/978-3-642-56999-9.
- [40] K. Gödel, ‘Über formal unentscheidbare sätze der principia mathematica und verwandter systeme i’, *Monatshefte für Mathematik und Physik*, vol. 38, no. 1, pp. 173–198, 1931. DOI: 10.1007/BF01700692.
- [41] B. Courcelle and J. Engelfriet, *Graph structure and monadic second-order logic: A language-theoretic approach*, ser. Encyclopedia of mathematics and its applications. Cambridge University Press, 2012, vol. 138. DOI: 10.1017/CBO9780511977619.
- [42] T. Uesu, ‘A system of graph grammars which generates all recursively enumerable sets of labelled graphs’, *Tsukuba Journal of Mathematics*, vol. 2, pp. 11–26, 1978. DOI: 10.21099/tkbjm/1496158502.
- [43] M. Newman, ‘On theories with a combinatorial definition of "equivalence"’, *Annals of Mathematics*, vol. 43, no. 2, pp. 223–243, 1942. DOI: 10.2307/1968867.
- [44] D. Plump, ‘Termination of graph rewriting is undecidable’, *Fundamenta Informaticae*, vol. 33, no. 2, pp. 201–209, 1998. DOI: 10.3233/FI-1998-33204.

- [45] —, ‘Confluence of graph transformation revisited’, in *Processes, Terms and Cycles: Steps on the Road to Infinity: Essays Dedicated to Jan Willem Klop on the Occasion of His 60th Birthday*, A. Middeldorp, V. van Oostrom, F. van Raamsdonk and R. de Vrijer, Eds., ser. Lecture Notes in Computer Science. Springer, 2005, vol. 3838, pp. 280–308. DOI: 10.1007/11601548_16.
- [46] D. Knuth and P. Bendix, ‘Simple word problems in universal algebras’, in *Computational Problems in Abstract Algebras*, J. Leech, Ed., Pergamon Press, 1970, pp. 263–297. DOI: 10.1016/B978-0-08-012975-4.50028-X.
- [47] G. Huet, ‘Confluent reductions: Abstract properties and applications to term rewriting systems’, *Journal of the ACM*, vol. 27, no. 4, pp. 797–821, 1980. DOI: 10.1145/322217.322230.
- [48] F. Baader and T. Nipkow, *Term rewriting and all that*. Cambridge University Press, 1998.
- [49] Terese, *Term rewriting systems*, ser. Cambridge Tracts in Theoretical Computer Science. Cambridge University Press, 2003, vol. 55.
- [50] O. Runge, C. Ermel and G. Taentzer, ‘AGG 2.0 – new features for specifying and analyzing algebraic graph transformations’, in *Proc. 4th International Symposium on Applications of Graph Transformations with Industrial Relevance (AGTIVE 2011)*, A. Schürr, D. Varró and G. Varró, Eds., ser. Lecture Notes in Computer Science, vol. 7233, Springer, 2011, pp. 81–88. DOI: 10.1007/978-3-642-34176-2_8.
- [51] M. Hannachi, I. Rodriguez, K. Drira, H. Pomares and E. Saul, ‘GMTE: A tool for graph transformation and exact/inexact graph matching’, in *Proc. 9th IAPR-TC-15 International Workshop on Graph-Based Representations in Pattern Recognition (GbRPR 2013)*, W. Kropatsch, N. Artner, Y. Haxhimusa and X. Jiang, Eds., ser. Lecture Notes in Computer Science, vol. 7877, Springer, 2013, pp. 71–80. DOI: 10.1007/978-3-642-38221-5_8.
- [52] J. Glauert, J. Kennaway and M. Sleep, ‘Dactl: An experimental graph rewriting language’, in *Proc. 4th International Workshop on Graph Grammars and Their Application to Computer Science (1990)*, H. Ehrig, H.-J. Kreowski and G. Rozenberg, Eds., ser. Lecture Notes in Computer Science, vol. 532, Springer, 1991, pp. 378–395. DOI: 10.1007/BFb0017401.
- [53] D. Plump, ‘The design of GP 2’, in *Proc. 10th International Workshop on Reduction Strategies in Rewriting and Programming (WRS 2011)*, S. Escobar, Ed., ser. Electronic Proceedings in Theoretical Computer Science, vol. 82, Open Publishing Association, 2012, pp. 1–16. DOI: 10.4204/EPTCS.82.1.

- [54] A. Agrawal, G. Karsai, S. Neema, F. Shi and A. Vizhanyo, ‘The design of a language for model transformations’, *Software & Systems Modeling*, vol. 5, no. 3, pp. 261–288, 2006. DOI: 10.1007/s10270-006-0027-7.
- [55] A. Ghamarian, M. de Mol, A. Rensink, E. Zambon and M. Zimakova, ‘Modelling and analysis using GROOVE’, *International Journal on Software Tools for Technology Transfer*, vol. 14, no. 1, pp. 15–40, 2012. DOI: 10.1007/s10009-011-0186-x.
- [56] E. Jakumeit, S. Buchwald and M. Kroll, ‘GrGen.NET – the expressive, convenient and fast graph rewrite system’, *International Journal on Software Tools for Technology Transfer*, vol. 12, no. 3–4, pp. 263–271, 2010. DOI: 10.1007/s10009-010-0148-8.
- [57] T. Arendt, E. Biermann, S. Jurack, C. Krause and G. Taentzer, ‘Henshin: Advanced concepts and tools for in-place EMF model transformations’, in *Proc. 13th International Conference on Model Driven Engineering Languages and Systems (MODELS 2010)*, D. Petriu, N. Rouquette and Ø. Haugen, Eds., ser. Lecture Notes in Computer Science, vol. 6394, Springer, 2010, pp. 121–135. DOI: 10.1007/978-3-642-16145-2_9.
- [58] A. Schürr, A. Winter and A. Zündorf, ‘The PROGRES approach: Language and environment’, in *Handbook of Graph Grammars and Computing by Graph Transformation, Volume 2: Applications, Languages and Tools*, H. Ehrig, G. Engels, H.-J. Kreowski and G. Rozenberg, Eds. World Scientific, 1999, pp. 551–603. DOI: 10.1142/9789812815149_0014.
- [59] M. Fernández, H. Kirchner, I. Mackie and B. Pinaud, ‘Visual modelling of complex systems: Towards an abstract machine for PORGY’, in *Proc. 10th Conference on Computability in Europe (CiE 2014)*, A. Beckmann, E. Csuhaj-Varjú and K. Meer, Eds., ser. Lecture Notes in Computer Science, vol. 8493, Springer, 2014, pp. 183–193. DOI: 10.1007/978-3-319-08019-2_19.
- [60] A. Habel and D. Plump, ‘Computational completeness of programming languages based on graph transformation’, in *Proc. 4th International Conference on Foundations of Software Science and Computation Structures (FOSSACS 2001)*, F. Honsell and M. Miculan, Eds., ser. Lecture Notes in Computer Science, vol. 2030, Springer, 2001, pp. 230–245. DOI: 10.1007/3-540-45315-6_15.
- [61] D. Plump, ‘The graph programming language GP’, in *Proc. Third International Conference on Algebraic Informatics (CAI 2009)*, S. Bozapalidis and G. Rahonis, Eds., ser. Lecture Notes in Computer Science, vol. 5725, Springer, 2009, pp. 99–122. DOI: 10.1007/978-3-642-03564-7_6.

- [62] —, ‘Reasoning about graph programs’, in *Proc. 9th International Workshop on Computing with Terms and Graphs (TERMGRAPH 2016)*, A. Corradini and H. Zantema, Eds., ser. Electronic Proceedings in Theoretical Computer Science, vol. 225, Open Publishing Association, 2016, pp. 35–44. DOI: 10.4204/EPTCS.225.6.
- [63] A. Habel, J. Müller and D. Plump, ‘Double-pushout graph transformation revisited’, *Mathematical Structures in Computer Science*, vol. 11, no. 5, pp. 637–688, 2001. DOI: 10.1017/S0960129501003425.
- [64] C. Poskitt and D. Plump, ‘Hoare-style verification of graph programs’, *Fundamenta Informaticae*, vol. 118, no. 1–2, pp. 135–175, 2012. DOI: 10.3233/FI-2012-708.
- [65] —, ‘Verifying total correctness of graph programs’, in *Selected Revised Papers from the 4th International Workshop on Graph Computation Models (GCM 2012)*, R. Echahed, A. Habel and M. Mosbah, Eds., ser. Electronic Communications of the EASST, vol. 61, 2013. DOI: 10.14279/tuj.eceasst.61.827.
- [66] C. Poskitt, ‘Verification of graph programs’, PhD thesis, Department of Computer Science, University of York, UK, 2013. [Online]. Available: <https://etheses.whiterose.ac.uk/4700/>.
- [67] C. Poskitt and D. Plump, ‘Verifying monadic second-order properties of graph programs’, in *Proc. 7th International Conference on Graph Transformation (ICGT 2014)*, H. Giese and B. König, Eds., ser. Lecture Notes in Computer Science, vol. 8571, Springer, 2014, pp. 33–48. DOI: 10.1007/978-3-319-09108-2_3.
- [68] C. A. R. Hoare, ‘An axiomatic basis for computer programming’, *Communications of the ACM*, vol. 12, no. 10, pp. 576–580, 1969. DOI: 10.1145/363235.363259.
- [69] G. Manning and D. Plump, ‘The GP programming system’, in *Proc. 7th International Workshop on Graph Transformation and Visual Modeling Techniques (GT-VMT 2008)*, C. Ermel, R. Heckel and J. de Lara, Eds., ser. Electronic Communications of the EASST, vol. 10, 2008. DOI: 10.14279/tuj.eceasst.10.150.
- [70] I. Hristakiev and D. Plump, ‘Checking graph programs for confluence’, in *Software Technologies: Applications and Foundations – STAF 2017 Collocated Workshops, Revised Selected Papers*, M. Seidl and S. Zschaler, Eds., ser. Lecture Notes in Computer Science, vol. 10748, Springer, 2018, pp. 92–108. DOI: 10.1007/978-3-319-74730-9_8.
- [71] D. Plump, ‘From imperative to rule-based graph programs’, *Journal of Logical and Algebraic Methods in Programming*, vol. 88, pp. 154–173, 2017. DOI: 10.1016/j.jlamp.2016.12.001.
- [72] G. Plotkin, ‘A structural approach to operational semantics’, *The Journal of Logic and Algebraic Programming*, vol. 60–61, pp. 17–139, 2004. DOI: 10.1016/j.jlap.2004.05.001.

- [73] E. Dijkstra, ‘A constructive approach to the problem of program correctness’, *BIT Numerical Mathematics*, vol. 8, no. 3, pp. 174–186, 1968. DOI: 10.1007/BF01933419.
- [74] —, ‘Chapter I: Notes on structured programming’, in *Structured Programming*, J. Dahl, E. Dijkstra and C. Hoare, Eds. Academic Press, 1972, pp. 1–82.
- [75] N. Wirth, ‘Program development by stepwise refinement’, *Communications of the ACM*, vol. 14, no. 4, pp. 221–227, 1971. DOI: 10.1145/362575.362577.
- [76] S. Arnborg, B. Courcelle, A. Proskurowski and D. Seese, ‘An algebraic theory of graph reduction’, *Journal of the ACM*, vol. 40, no. 5, pp. 1134–1164, 1993. DOI: 10.1145/174147.169807.
- [77] H. Bodlaender and B. van Antwerpen-de Fluiter, ‘Reduction algorithms for graphs of small treewidth’, *Information and Computation*, vol. 167, no. 2, pp. 86–119, 2001. DOI: 10.1006/inco.2000.2958.
- [78] B. Courcelle, ‘The monadic second-order logic of graphs: Definable sets of finite graphs’, in *Proc. 14th International Workshop on Graph-Theoretic Concepts in Computer Science (WG ’88)*, J. van Leeuwen, Ed., ser. Lecture Notes in Computer Science, vol. 344, Springer, 1989, pp. 30–53. DOI: 10.1007/3-540-50728-0_34.
- [79] P. Fradet and D. L. Métayer, ‘Structured Gamma’, *Science of Computer Programming*, vol. 31, no. 2–3, pp. 263–289, 1998. DOI: 10.1016/S0167-6423(97)00023-3.
- [80] A. Bakewell, D. Plump and C. Runciman, ‘Specifying pointer structures by graph reduction’, Department of Computer Science, University of York, UK, Tech. Rep., 2003. [Online]. Available: <https://www.cs.york.ac.uk/plasma/publications/pdf/BakewellPlumpRuncimanReport.03.pdf>.
- [81] —, ‘Specifying pointer structures by graph reduction’, in *Proc. Second International Workshop on Applications of Graph Transformations with Industrial Relevance (AGTIVE 2003)*, J. Pfaltz, M. Nagl and B. Böhlen, Eds., ser. Lecture Notes in Computer Science, vol. 3062, Springer, 2004, pp. 30–44. DOI: 10.1007/978-3-540-25959-6_3.
- [82] J. Berstel, *Transductions and context-free languages*. Vieweg+Teubner, 1979. DOI: 10.1007/978-3-663-09367-1.
- [83] A.-C. Caron, ‘Linear bounded automata and rewrite systems: Influence of initial configurations on decision properties’, in *Proc. International Joint Conference on Theory and Practice of Software Development (TAPSOFT ’91). CAAP 1991*, S. Abramsky and T. Maibaum, Eds., ser. Lecture Notes in Computer Science, vol. 493, Springer, 1991, pp. 74–89. DOI: 10.1007/3-540-53982-4_5.

- [84] H. Ehrig and H.-J. Kreowski, ‘Applications of graph grammar theory to consistency, synchronization and scheduling in data base systems’, *Information Systems*, vol. 5, no. 3, pp. 225–238, 1980. DOI: 10.1016/0306-4379(80)90014-9.
- [85] F. Parisi-Presicce, ‘Modular system design applying graph grammars techniques’, in *Proc. 16th International Colloquium on Automata, Languages and Programming (ICALP 1989)*, G. Ausiello, M. Dezani-Ciancaglini and S. Rocca, Eds., ser. Lecture Notes in Computer Science, vol. 372, Springer, 1989, pp. 621–636. DOI: 10.1007/BFb0035788.
- [86] H. Ehrig, U. Golas, A. Habel, L. Lambers and F. Orejas, ‘ \mathcal{M} -adhesive transformation systems with nested application conditions. Part 2: Embedding, critical pairs and local confluence’, *Fundamenta Informaticae*, vol. 118, no. 1–2, pp. 35–63, 2012. DOI: 10.3233/FI-2012-705.
- [87] M. Frank, ‘Introduction to reversible computing: Motivation, progress, and challenges’, in *Proc. 2nd Conference on Computing Frontiers (CF ’05)*, M. Valero and A. Ramirez, Eds., ACM, 2005, pp. 385–390. DOI: 10.1145/1062261.1062324.
- [88] K. Gödel, *The consistency of the axiom of choice and of the generalized continuum hypothesis with the axioms of set theory*, Revised ed. Princeton University Press, 1940.
- [89] E. Mendelson, *Introduction to mathematical logic*, 6th ed., ser. Discrete Mathematics and Its Applications. CRC Press, 2015.
- [90] W. Sutherland, *Introduction to metric and topological spaces*, 2nd ed. Oxford University Press, 2009.
- [91] S. Awodey, *Category theory*, 2nd ed., ser. Oxford Logic Guides. Oxford University Press, 2010.
- [92] J. Howie, *Fundamentals of semigroup theory*, ser. LMS Monographs. Clarendon Press, 1995.
- [93] W. Weiss, ‘An introduction to set theory’, Department of Mathematics, University of Toronto, Lecture Notes, 2008. [Online]. Available: https://www.math.toronto.edu/weiss/set_theory.pdf.
- [94] J. Munkres, *Topology*, 2nd ed. Pearson, 2018.
- [95] J. Martin, *Introduction to languages and the theory of computation*, 4th ed. McGraw-Hill, 2011.
- [96] S. Lane, *Categories for the working mathematician*, 2nd ed., ser. Graduate Texts in Mathematics. Springer, 1978. DOI: 10.1007/978-1-4757-4721-8.
- [97] T. Leinster, *Basic category theory*, ser. Cambridge Studies in Advanced Mathematics. Cambridge University Press, 2014. DOI: 10.1017/CBO9781107360068.

- [98] D. Plump, ‘Computing by graph rewriting’, Habilitation Thesis, Universität Bremen, Fachbereich Mathematik und Informatik, 1999.
- [99] R. Book and F. Otto, *String-rewriting systems*, ser. Monographs in Computer Science. Springer, 1993. DOI: 10.1007/978-1-4613-9771-7.
- [100] G. Campbell, ‘Algebraic graph transformation: A crash course’, Department of Computer Science, University of York, UK, Tech. Rep., 2018. [Online]. Available: <https://cdn.gjccampbell.co.uk/2018/Graph-Transformation.pdf>.
- [101] D. Plump, ‘Computing by graph transformation: 2018/19’, Department of Computer Science, University of York, UK, Lecture Slides, 2019.
- [102] A. Habel and H.-J. Kreowski, ‘On context-free graph languages generated by edge replacement’, in *Proc. 2nd International Workshop on Graph-Grammars and Their Application to Computer Science (1982)*, H. Ehrig, M. Nagl and G. Rozenberg, Eds., ser. Lecture Notes in Computer Science, vol. 153, Springer, 1983, pp. 143–158. DOI: 10.1007/BFb0000104.
- [103] F. Drewes, ‘NP-completeness of k -connected hyperedge-replacement languages of order k ’, *Information Processing Letters*, vol. 45, no. 2, pp. 89–94, 1993. DOI: 10.1016/0020-0190(93)90221-T.
- [104] P. Johnson, ‘MAS341 graph theory’, School of Mathematics and Statistics, University of Sheffield, UK, Lecture Notes, 2018. [Online]. Available: <https://ptwiddle.github.io/MAS341-Graph-Theory-2017/lecturenotes/lecturenotes.pdf>.
- [105] V. Lozin, ‘Graph theory notes’, Institute of Mathematics, University of Warwick, UK, Lecture Notes, 2018. [Online]. Available: <https://homepages.warwick.ac.uk/~masgax/Graph-Theory-notes.pdf>.
- [106] J. Bang-Jensen and G. Gutin, *Digraphs: Theory, algorithms and applications*, 2nd ed., ser. Springer Monographs in Mathematics. Springer, 2009. DOI: 10.1007/978-1-84800-998-1.
- [107] S. Skiena, *The algorithm design manual*, 2nd ed. Springer, 2008. DOI: 10.1007/978-1-84800-070-4.
- [108] G. Campbell, ‘Errata for bsc thesis: Efficient graph rewriting’, Department of Computer Science, University of York, UK, Erratum, 2019. [Online]. Available: <https://cdn.gjccampbell.co.uk/2019/BSc-Project-Errata.pdf>.