

EXPLICIT PIERI INCLUSIONS

MARKUS HUNZIKER, JOHN A. MILLER, AND MARK SEPANSKI

CONTENTS

1. Introduction	1
2. Constructing Schur–Weyl Modules	4
3. Constructing the Pieri Inclusion for Removing One Box	6
4. Constructing the Pieri Inclusion for Removing Many Boxes	10
5. Generating Garnir Relations and Tools for Collapsing Sums	16
6. Showing the Pieri Inclusion Removing One Box is a $GL(V)$ -map	26
7. Showing the Pieri Inclusion Removing Many Boxes is a $GL(V)$ -map	36
8. Relating Pieri Inclusion Descriptions	59
9. The Image of a Highest Weight Vector and Computational Complexity	61
References	65

1. INTRODUCTION

1.1. Let $\lambda = (\lambda_1, \lambda_2, \dots)$ be a partition, i.e., a sequence of non-negative integers in weakly decreasing order. The number of nonzero parts λ_i is called the length of λ , denoted by $l(\lambda)$. If V is a complex vector space of dimension $n \leq l(\lambda)$, we can apply the Schur–Weyl functor \mathbb{S}_λ (as in [FH13]) to V to obtain an irreducible representation $\mathbb{S}_\lambda(V)$ of the general linear group $GL(V)$. It follows from Pieri’s formula for the product of an elementary symmetric polynomial and a Schur polynomial that the tensor product representation $\wedge^m(V) \otimes \mathbb{S}_\lambda(V)$ decomposes multiplicity-free into a direct sum of irreducible representations

$$\wedge^m(V) \otimes \mathbb{S}_\lambda(V) \cong \bigoplus_{\mu} \mathbb{S}_\mu(V),$$

where the sum is over all partitions μ with $l(\mu) \leq n$ whose Young diagram is obtained from the Young diagram of λ by adding exactly m boxes, at most one to each row. Since the decomposition is multiplicity-free, it is natural to ask for explicit descriptions of the embeddings $\Phi_m : \mathbb{S}_\mu(V) \hookrightarrow \wedge^m(V) \otimes \mathbb{S}_\lambda(V)$. Following [SW11], we call these embeddings (skew) Pieri inclusions.

1.2. Given a basis $\{e_1, e_2, \dots, e_n\}$ of V , the representation $\mathbb{S}_\lambda(V)$ is equipped with a canonical basis indexed by the set of semistandard tableaux of shape λ with fillings from the set $\{1, \dots, n\}$. In [Olv82], Olver gave an explicit description of the Pieri inclusions with respect to these canonical bases in the special case when $m = 1$. When $m > 1$, the Pieri inclusion Φ_m can be obtained by iteration of the special case [SW11, Corollary 1.8]. The main purpose of this paper is to give a new combinatorial description of Φ_m that (a) leads to a

more efficient algorithm and (b) can be given in a general closed form (avoiding iteration) for $m \geq 1$. In regard to (a), we will show that our algorithm achieves an exponential speed-up over Olver's algorithm when it is restricted to partitions with a bounded number of distinct parts. More precisely, if we fix a positive integer N and consider partitions λ that can be written in exponential notation as $\lambda = (1^{h_1}, 2^{h_2}, 3^{h_3}, \dots)$ with at most N nonzero exponents h_i , then our algorithm to compute the image of a highest weight vector under a Pieri inclusion $\Phi_1 : \mathbb{S}_\mu(V) \hookrightarrow V \otimes \mathbb{S}_\lambda(V)$ has a run-time complexity of $O(l(\lambda)^N)$, whereas Olver's algorithm has a run-time complexity of $\Omega(2^{l(\lambda)})$.

1.3. Our general formula for a Pieri inclusion $\Phi_m : \mathbb{S}_\mu(V) \hookrightarrow \wedge^m(V) \otimes \mathbb{S}_\lambda(V)$, where $\lambda \setminus \mu$ is a skew diagram with no two boxes in the same row, is as follows. If T is a semistandard tableau of shape μ with filling in $\{1, \dots, n\}$ and $e_T \in \mathbb{S}_\mu(V)$ is the corresponding basis element, then

$$\Phi_m(e_T) = \sum_P \frac{(-1)^P}{H(P)} P(T)$$

where the sum is over a certain set of “ m -paths” P which remove m boxes from the shape λ , $(-1)^P$ is a sign, $H(P)$ is a positive integer that is a product of certain “hook lengths.” We will write the path P acting on T as

$$P(T) = e_{Y_P} \otimes e_{T_P}$$

where $e_{Y_P} = e_{i_1} \wedge \dots \wedge e_{i_m} \in \wedge^m(V)$ is given by the entries of the boxes removed by P , and T_P is a (not necessarily semistandard) tableau of shape λ with fillings in $\{1, \dots, n\}$ such that

$$\{\text{numbers appearing in } T\} = \{\text{numbers appearing in } Y_P\} \cup \{\text{numbers appearing in } T_P\}$$

as a multi-set. All of this will be defined rigorously in Sections 3 and 4.

1.4. To illustrate how our formula works, we look at an example in the case when $n = 4$ and $m = 1$. Let $\lambda = (2, 1, 1, 1)$, and $\mu = (2, 1, 1)$. Then the Schur–Weyl module $\mathbb{S}_\lambda(V)$ appears as a summand in the decomposition of $\mathbb{S}_{(1)}(V) \otimes \mathbb{S}_{(2,1,1)}(V) = V \otimes \mathbb{S}_{(2,1,1)}$,

Consider the Pieri inclusion

$$\Phi_1 : \mathbb{S}_{(2,1,1)}(V) \hookrightarrow V \otimes \mathbb{S}_{(2,1,1)}(V).$$

By abuse of notation, we will identify semistandard tableaux and their corresponding basis vectors. We will compute

$$\Phi_1 \left(\begin{array}{|c|c|} \hline 1 & 1 \\ \hline 2 & \\ \hline 3 & \\ \hline 4 & \\ \hline \end{array} \right) = \sum_P \frac{(-1)^P}{H(P)} P \left(\begin{array}{|c|c|} \hline 1 & 1 \\ \hline 2 & \\ \hline 3 & \\ \hline 4 & \\ \hline \end{array} \right).$$

The sum is over all “1-paths” P on λ , that is, certain maps on the boxes in λ that removing a single box. Below we illustrate all such 1-paths with arrows, shading the boxes on which the path acts. We will view the box removed by a 1-path as being moved to the top of the diagram in a “zeroth row” of the diagram. We give the image up to a row permutation, so that it is semi-standard.

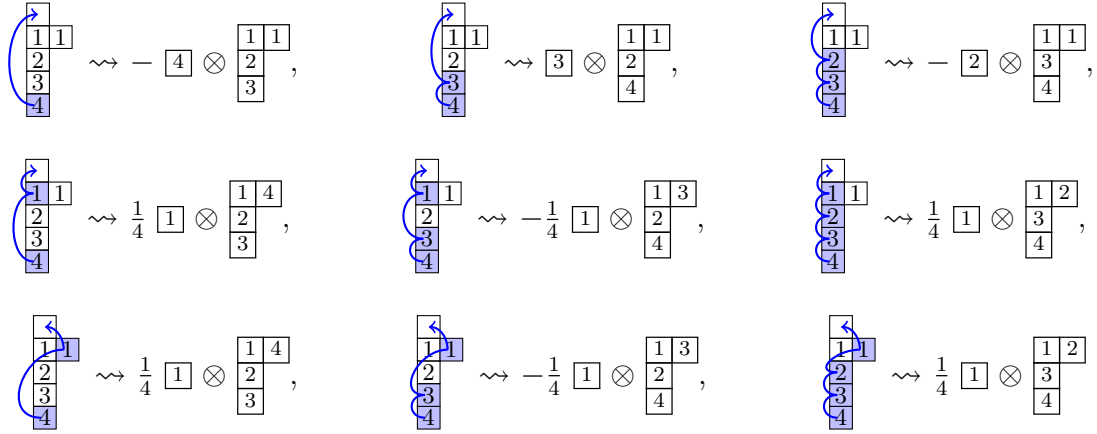

Thus, up to row permutations we have

$$\begin{aligned} \Phi_1 \left(\begin{array}{c} \boxed{1} \boxed{1} \\ \boxed{2} \\ \boxed{3} \\ \boxed{4} \end{array} \right) &= -\boxed{4} \otimes \begin{array}{c} \boxed{1} \boxed{1} \\ \boxed{2} \\ \boxed{3} \end{array} + \boxed{3} \otimes \begin{array}{c} \boxed{1} \boxed{1} \\ \boxed{2} \\ \boxed{4} \end{array} - \boxed{2} \otimes \begin{array}{c} \boxed{1} \boxed{1} \\ \boxed{3} \\ \boxed{4} \end{array} \\ &+ \frac{1}{2} \boxed{1} \otimes \begin{array}{c} \boxed{1} \boxed{4} \\ \boxed{2} \\ \boxed{3} \end{array} - \frac{1}{2} \boxed{1} \otimes \begin{array}{c} \boxed{1} \boxed{3} \\ \boxed{2} \\ \boxed{4} \end{array} + \frac{1}{2} \boxed{1} \otimes \begin{array}{c} \boxed{1} \boxed{2} \\ \boxed{3} \\ \boxed{4} \end{array}. \end{aligned}$$

1.5. In 1.4, all terms T_P that appeared were (after row permutations) semi-standard. We now compute an example where some of the terms that appear in the image are not semi-standard, and so must be straightened. Let Φ_1 be as in 1.4, we will compute

$$\Phi_1 \left(\begin{array}{c} \boxed{1} \boxed{2} \\ \boxed{2} \\ \boxed{3} \\ \boxed{4} \end{array} \right) = \sum_P \frac{(-1)^P}{H(P)} P \left(\begin{array}{c} \boxed{1} \boxed{2} \\ \boxed{2} \\ \boxed{3} \\ \boxed{4} \end{array} \right),$$

where the terms of the sum in the image are again indexed by the 1-paths on λ removing a single box, which we illustrate below. As before, we give the image up to row permutations and we now star the terms that need to be straightened.

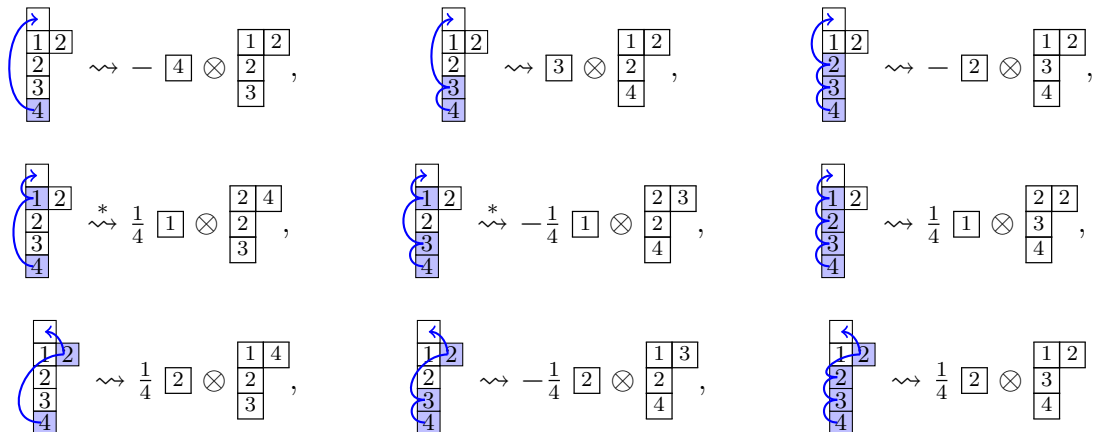

In this case, we must straighten the image of two of the 1-paths (starred), which we show in Section 3.8. After straightening we have, up to row permutations,

$$\begin{aligned} \Phi_1 \left(\begin{array}{|c|c|} \hline 1 & 2 \\ \hline 2 & \\ \hline 3 & \\ \hline 4 & \\ \hline \end{array} \right) &= - \boxed{4} \otimes \begin{array}{|c|c|} \hline 1 & 2 \\ \hline 2 & \\ \hline 3 & \\ \hline & \\ \hline \end{array} + \boxed{3} \otimes \begin{array}{|c|c|} \hline 1 & 2 \\ \hline 2 & \\ \hline 4 & \\ \hline & \\ \hline \end{array} - \frac{3}{4} \boxed{2} \otimes \begin{array}{|c|c|} \hline 1 & 2 \\ \hline & 3 \\ \hline & 4 \\ \hline & \\ \hline \end{array} \\ &+ \frac{1}{4} \boxed{1} \otimes \begin{array}{|c|c|} \hline 2 & 2 \\ \hline 3 & \\ \hline 4 & \\ \hline & \\ \hline \end{array} + \frac{1}{4} \boxed{2} \otimes \begin{array}{|c|c|} \hline 1 & 4 \\ \hline 2 & \\ \hline 3 & \\ \hline & \\ \hline \end{array} - \frac{1}{4} \boxed{2} \otimes \begin{array}{|c|c|} \hline 1 & 3 \\ \hline 2 & \\ \hline 4 & \\ \hline & \\ \hline \end{array}. \end{aligned}$$

For an example of two-box removal, see Section 4.5.

1.6. In results of Eisenbud, Fløstad, and Weyman [EFW11] and of Sam and Weyman [SW11], Pieri inclusions are used to compute pure free resolutions for classical groups. Sam has also built a package for Macaulay2 (PieriMaps) [Sam09] that computes Pieri inclusions explicitly using the algorithm from [SW11].

In [PW85], Weyman and Pragacz use Pieri inclusion maps to describe Lascoux resolutions. We use the explicit description of Pieri inclusions to give minimal free resolutions of modules of covariants (in the context of Weyl's fundamental theorems).

1.7. In Section 2 we construct the Schur–Weyl modules \mathbb{S}_λ . In Sections 3 and 4 we describe the construction of the Pieri inclusion in the one-box removal case (V) and m -box removal case ($\wedge^m(V)$), respectively. In Sections 6 and 7 we show that the Pieri inclusions are $GL(V)$ -maps in the one-box removal and m -box removal cases, respectively, with the tools for these proofs given in Section 5. In Section 9 we show the one-box removal map is the negative of Olver's description via the uniqueness of an equivariant map and, in a similar way, show that the m -box removal case is equal to iterating one-box removal. We also show in this section that the same description of Pieri inclusions gives a map in the case $\mathbb{S}_\mu(V) \leftrightarrow \text{Sym}^m(V) \otimes \mathbb{S}_\lambda(V)$ and we compare the computational complexity of the one-box removal description to that of Olver.

2. CONSTRUCTING SCHUR–WEYL MODULES

2.1. From now on, let $\lambda = (\lambda_1, \dots, \lambda_r)$ be a fixed partition of d . Let $\mathcal{T}_{\lambda,n}$ be the set of all tableau T with shape λ and arbitrary filling from the alphabet $\{1, \dots, n\}$. A tableau $T \in \mathcal{T}_{\lambda,n}$ is called semi-standard if the filling is non-decreasing across the rows and strictly increasing down the columns. Fix the canonical tableau T_0 of shape λ labeled with $\{1, \dots, d\}$, starting with the top left most box and filling across each row, so the first box of the first row is labeled 1, the first box of the second row is labeled $\lambda_1 + 1$, etc. Via this labeling, the symmetric group \mathfrak{S}_d acts on the set of tableau with shape λ with respect to any given alphabet.

Let

$$P = P_\lambda = \{\pi \in \mathfrak{S}_d : \pi \text{ preserves the rows of } T_0\}$$

and

$$Q = Q_\lambda = \{\sigma \in \mathfrak{S}_d : \sigma \text{ preserves the columns of } T_0\}.$$

As elements of the group algebra of \mathfrak{S}_d , $\mathbb{C}\mathfrak{S}_d$, define

$$A_\lambda = \sum_{\pi \in P} \pi \quad \text{and} \quad B_\lambda = \sum_{\sigma \in Q} (-1)^\sigma \sigma.$$

The Young Symmetrizer is then defined as $C_\lambda = A_\lambda B_\lambda$. Note this convention symmetrizes along rows first and antisymmetrizes along columns second.

2.2. From now on, fix a complex vector space V of dimension n . Let \mathfrak{S}_d also act on elements of $V^{\otimes d}$ by permuting the coordinates. In particular, C_λ acts on $V^{\otimes d}$. The corresponding Schur–Weyl module is $\mathbb{S}_\lambda = \mathbb{S}_\lambda(V^{\otimes d}) = C_\lambda \cdot V^{\otimes d}$. Clearly \mathbb{S}_λ is a $GL(V)$ -module. When the number of rows of λ is at most n , it is known that \mathbb{S}_λ is an irreducible representation of $GL(V)$ and that all (in-equivalent) polynomial irreducible representations are constructed this way.

Write $\{e_i\}_{1 \leq i \leq n}$ for the standard basis of V . For $T \in \mathcal{T}_{\lambda,n}$, define $e_T \in \mathbb{S}_\lambda$ by

$$e_T = C_\lambda \cdot ((e_{T_{11}} \otimes \cdots \otimes e_{T_{1\lambda_1}}) \otimes \cdots \otimes (e_{T_{N1}} \otimes \cdots \otimes e_{T_{N\lambda_N}}))$$

where $T_{i,j}$ is the entry in the i th row and j column of T starting from the top left. Clearly \mathbb{S}_λ is spanned by such elements, and it is known that a basis is given by the semistandard ones.

2.3. Let V_\bullet be the standard flag in V ,

$$V_\bullet : V_i = \text{span}\{e_1, \dots, e_i\} \quad (1 \leq i \leq n).$$

Let $B \subset GL(V)$ be the Borel subgroup given by

$$B = \{g \in GL(V) : gV_i \subset V_i \text{ for } 1 \leq i \leq n\}.$$

Throughout this paper, all highest weights are with respect to B . The highest weight vector of $\mathbb{S}_\lambda(V)$ is

$$e_{T_\lambda} = C_\lambda \cdot \underbrace{((e_1 \otimes \cdots \otimes e_1))}_{\lambda_1} \otimes \cdots \otimes \underbrace{((e_r \otimes \cdots \otimes e_r))}_{\lambda_r}.$$

That is, T_λ is the tableau of shape λ with all ones in the first row, all twos in the second row, etc. For example, if $\lambda = (5, 3, 3, 1, 1)$,

$$T_\lambda = \begin{array}{|c|c|c|c|c|} \hline 1 & 1 & 1 & 1 & 1 \\ \hline 2 & 2 & 2 & & \\ \hline 3 & 3 & 3 & & \\ \hline 4 & & & & \\ \hline 5 & & & & \\ \hline \end{array}$$

and

$$e_{T_\lambda} = C_\lambda \cdot (e_1 \otimes e_1 \otimes e_1 \otimes e_1 \otimes e_1 \otimes e_2 \otimes e_2 \otimes e_2 \otimes e_3 \otimes e_3 \otimes e_3 \otimes e_4 \otimes e_5).$$

2.4. For any subset A of boxes of T_0 , let w_A be the maximum width of a row containing an element of A . Let

$$\mathfrak{S}_A = \{\sigma \in \mathfrak{S}_d : \sigma \text{ preserves } A \text{ and fixes } T_0 \setminus A\}.$$

When $|A| > w_A$, define a Garnir operator as an element of $\mathbb{C}\mathfrak{S}_d$ by

$$G_A = \sum_{\sigma \in \mathfrak{S}_A} \sigma.$$

$$\begin{array}{ccc}
 \mathcal{F}_{\lambda,n} & \xrightarrow{\Phi_1} & V \otimes \mathcal{F}_{\lambda \setminus \{x\},n} \\
 \downarrow & & \downarrow \\
 \mathcal{F}_{\lambda,n}/\mathcal{R}_{\lambda,n} \cong \mathbb{S}_{\lambda}(V) & \xrightarrow{\Phi_1} & V \otimes \mathcal{F}_{\lambda \setminus \{x\},n}/\mathcal{R}_{\lambda,n} \cong V \otimes \mathbb{S}_{\lambda \setminus \{x\}}(V)
 \end{array}$$

3.3. We first introduce further notation. For a given shape λ , let $[b]$ denote the b th block, $[b](i)$ denote the i th row of the b th block, and $[b](i, j)$ denote the box in block b , row i , and column j , with block 1 and row 1 the lowest geometrically and column 1 the furthest left. We write

$$[b](i, j) \leq [c](k, l)$$

if $[b](i, j)$ is geometrically (weakly) lower than $[c](k, l)$, i.e. $b < c$ or $b = c$ and $i \leq k$. The strict inequality is defined in the natural way. We will extend this notation to compare boxes, rows, and blocks in the natural way. For a given $T \in \mathcal{F}_{\lambda,n}$, we denote the entry in box $[b](i, j)$ by $T_{[b](i,j)}$. For example, if

$$T = \begin{array}{cccccc}
 & 1 & 1 & 3 & 3 & 4 \\
 & 2 & 2 & & & \\
 & 3 & 4 & & & \\
 & 4 & 5 & & & \\
 & 6 & & & & \\
 & 7 & & & &
 \end{array}$$

then $T_{[1](2,1)} = 6$ and $T_{[3](1,5)} = 4$.

3.4. An evacuation route R is a selection of a string of boxes starting from the bottom of some block. For example an evacuation route on $(1^2, 3, 5^3, 7^2)$ is given by the shaded boxes in the diagram below.

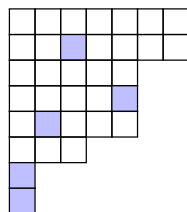

This example shows that an evacuation route does not need to contain a box from every row, however, it cannot skip rows within a block. This is best illustrated with a non-example. The shaded selection of boxes below is not an evacuation route on $(2, 3^2, 5^4, 7^2)$ since a box in row 3 (that is, the third row in the third block) is selected, while there is no box selected from row $[3](2)$.

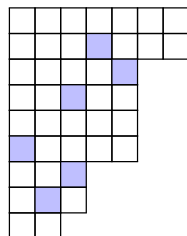

Formally, we have the following definition.

Definition (Evacuation Route). An evacuation route R starting at $[b_0]$ is a subset of boxes in T_0 such that R contains a box in row $[b_0](1)$, R contains at most one box per row, and if $[b](i, j) \in R$, then $[b](k, j_k) \in R$ for all $1 \leq k < i$ and some $1 \leq j_k \leq w_b$.

and let $H_{b_1}(P) = 1$. Then define

$$H(P) = \prod_{b=b_1}^n H_b(P).$$

Example. For the partition $(1, 3^2, 4^3, 6^2)$ and $X = \{[1](1, 1)\}$ (shaded),

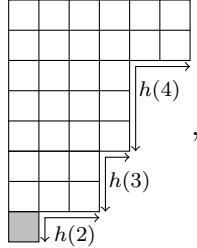

we have

$$h(2) = 3 - 1 + 1 = 3, \quad h(3) = 4 - 3 + 2 = 3, \quad h(4) = 6 - 4 + 3 = 5,$$

$$H(1) = 1, \quad H(2) = 3, \quad H(3) = 6, \quad \text{and} \quad H(4) = 11.$$

3.7. For $T \in \mathcal{F}_{\lambda,n}$, denote by α_1^P the entry in the box $P^{-1}(y_1) \in T$ and extend P to T by acting on the entries, with the image

$$P(T) = Y_P \otimes T_P \in V \otimes \mathcal{F}_{\lambda \setminus X, n},$$

where

$$Y_P = E_X \boxed{\alpha_1^P},$$

which in standard form notation is $e_{\alpha_1^P} \in V$, and $T_P \in \mathcal{F}_{\lambda \setminus X, n}$ is defined by $(T_P)_{[b](i,j)} = T_{P^{-1}([b](i,j))}$. We omit E_X and just write

$$\boxed{\alpha_1^P} \quad \text{in place of} \quad E_X \boxed{\alpha_1^P}$$

in the image of $P(T)$.

Definition. The map $\Phi_1 : \mathcal{F}_{\lambda,n} \rightarrow V \otimes \mathcal{F}_{\lambda \setminus X, n}$ is given by

$$\Phi_1(T) = \sum_P \frac{(-1)^P}{H(P)} P(T)$$

where the sum is over all 1-paths P removing X .

3.8. We now compute the straightening from Section 1.5. If

$$A_1 = \{[2](1, 1), [2], (1, 2), [1](2, 1)\} = \begin{array}{|c|c|} \hline \blacksquare & \blacksquare \\ \hline \blacksquare & \square \\ \hline \square & \square \\ \hline \end{array}$$

then we have, mod $\mathcal{R}_{(2,1,1),4}$,

$$\frac{1}{2} G_{A_1} \left(\begin{array}{|c|c|} \hline \boxed{2} & \boxed{4} \\ \hline \boxed{2} & \square \\ \hline \boxed{3} & \square \\ \hline \end{array} \right) = 2 \begin{array}{|c|c|} \hline \boxed{2} & \boxed{4} \\ \hline \boxed{2} & \square \\ \hline \boxed{3} & \square \\ \hline \end{array} + \begin{array}{|c|c|} \hline \boxed{2} & \boxed{2} \\ \hline \boxed{4} & \square \\ \hline \boxed{3} & \square \\ \hline \end{array}.$$

Then if

$$A_2 = \{[1](1, 1), [1](2, 1)\} = \begin{array}{|c|c|} \hline \square & \square \\ \hline \blacksquare & \square \\ \hline \square & \square \\ \hline \end{array},$$

we have, mod $\mathcal{R}_{(2,1,1),4}$,

$$G_{A_2} \left(\begin{array}{|c|c|} \hline 2 & 2 \\ \hline 4 & \\ \hline 3 & \\ \hline \end{array} \right) = \begin{array}{|c|c|} \hline 2 & 2 \\ \hline 4 & \\ \hline 3 & \\ \hline \end{array} + \begin{array}{|c|c|} \hline 2 & 2 \\ \hline 3 & \\ \hline 4 & \\ \hline \end{array}.$$

Thus, as elements of $\mathcal{F}_{(2,1,1),4}/\mathcal{R}_{(2,1,1),4}$ we have

$$\frac{1}{4} \boxed{1} \otimes \begin{array}{|c|c|} \hline 2 & 4 \\ \hline 2 & \\ \hline 3 & \\ \hline \end{array} = \frac{1}{8} \boxed{1} \otimes \begin{array}{|c|c|} \hline 2 & 2 \\ \hline 3 & \\ \hline 4 & \\ \hline \end{array}.$$

Similarly, as elements of $\mathcal{F}_{(2,1,1),4}/\mathcal{R}_{(2,1,1),4}$ we have

$$\frac{1}{4} \boxed{1} \otimes \begin{array}{|c|c|} \hline 2 & 3 \\ \hline 2 & \\ \hline 4 & \\ \hline \end{array} = -\frac{1}{8} \boxed{1} \otimes \begin{array}{|c|c|} \hline 2 & 2 \\ \hline 3 & \\ \hline 4 & \\ \hline \end{array}.$$

Note that in this example the terms that were straightened cancelled with each other and so did not appear in the image, this is not the case in general.

4. CONSTRUCTING THE PIERI INCLUSION FOR REMOVING MANY BOXES

4.1. Let $X = \{x_1 = [b_1](1, w_{b_1}), \dots, x_m = [b_m](i_m, w_{b_m})\}$ be a set of m boxes in λ with $x_i < x_{i+1}$ so that removing the boxes in X from T_0 gives a Young diagram and let $\lambda \setminus X$ be the associated partition. We call such a set X a removal set for T_0 (or for λ). As before, we will define the map $\Phi_m : \mathcal{F}_{\lambda,n} \rightarrow F_m \otimes \mathcal{F}_{\lambda \setminus X,n}$ on a basis, where $F_m = \bigwedge^m V$, and then show that Φ_m is a $GL(V)$ -map.

$$\begin{array}{ccc} \mathcal{F}_{\lambda,n} & \xrightarrow{\Phi_m} & F_m \otimes \mathcal{F}_{\lambda \setminus X,n} \\ \downarrow & & \downarrow \\ \mathcal{F}_{\lambda,n}/\mathcal{R}_{\lambda,n} \cong \mathbb{S}_\lambda(V) & \xrightarrow{\Phi_m} & F_m \otimes \mathcal{F}_{\lambda \setminus X,n}/\mathcal{R}_{\lambda,n} \cong F_m \otimes \mathbb{S}_{\lambda \setminus X}(V) \end{array}$$

4.2. Extending the notion of a 1-path, an m -path on λ is a map of boxes that moves boxes up the diagram via some associated evacuation route with m interlaced orbits. As with 1-paths, we treat m -paths as acting on general shapes, where the highest m boxes in R^P are “removed” by the m -path and viewed as being moved to the boxes $[N+1](1, 1), \dots, [N+1](m, 1)$ attached to the top of T_0 . An example of a 2-path is pictured below. We highlight only the boxes in the evacuation route.

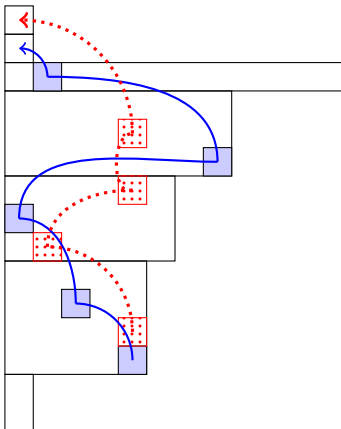

The interlacing property for m -paths is not so strict as the above example suggests. We require that an m -path interlaces orbits only within blocks while multiple orbits are present. This is illustrated further in the example below.

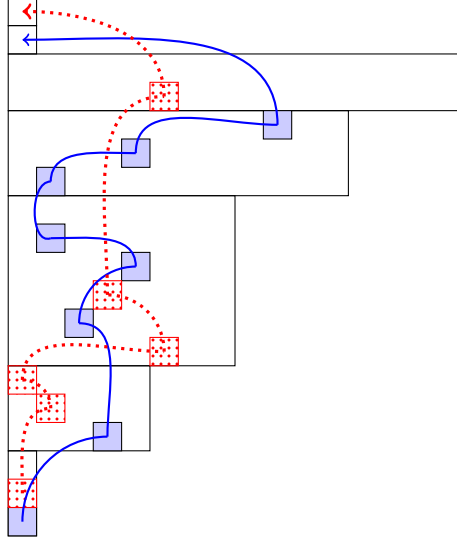

Formally, we have the following definition.

Definition (m-path). Let

$$X = \{x_1 = [b_1](1, w_{b_1}), \dots, x_m = [b_m](i_m, w_{b_m})\}$$

be a removal set for T_0 and

$$Y = \{y_1 := [N + 1](1, 1), \dots, y_m := [N + 1](m, 1)\},$$

where Y is viewed as block $N + 1$ attached to the top of T_0 . An

m -path P removing X

is a map of boxes

$$P : \lambda \cup Y \rightarrow \lambda \cup Y$$

along with an evacuation route $R = R^P$ such that the following hold.

- R starts at $[b_1]$. Note that R can intersect X , though this is not a requirement.
- P is geometrically increasing on rows, with P strictly increasing on R . That is, for all boxes $x \in \lambda \cup Y$, $x \leq P(x)$.
- If R_i is the orbit of x_i under $P^{\mathbb{N}}$, then $y_i \in R_i$ and $R \cup X \cup Y = \bigsqcup_{i=1}^m R_i$.
- If there are k distinct orbits in a block, then the first k rows of that block must be in different orbits. i.e., if $R_{i_1}^P, \dots, R_{i_k}^P$ intersect some block $[b]$, then for $j = 1, \dots, k$, up to relabeling, $R_{i_j}^P \cap [b](j) \neq \emptyset$.
- P preserves row order in R within blocks, and so interlaces orbits. That is, if $[b](i, j), [b](k, l) \in R$ with $i < k$ and $P([b](i, j)), P([b](k, l)) \in [b]$, then $P([b](i, j)) < P([b](k, l))$.
- P fixes those boxes not in R or X , i.e. $P = \text{id}_{\lambda \cup Y}$ except on $R \cup X$, and $P(R) = R \setminus X \cup Y$.

4.3. For an m -path P with evacuation route R^P , let h^P , $(-1)^P$, h_b^P , and $H(b)$ be defined as in Section 3.6. For $b = b_1 + 1, \dots, N$, let $H_b(P) = 1$ if $R^P \cap [b] = \emptyset$ and let $H_{b_1}(P) = 1$. If $b \geq b_1 + 1$ and $|R^P \cap [b]| = k_b \neq 0$, then let

$$H_b(P) = \prod_{i=1}^{k_b} (H(b) - (m - i)).$$

Define

$$H(P) = \prod_{b=b_1}^n H_b(P).$$

4.4. For $T \in \mathcal{F}_{\lambda,n}$, denote by α_i^P the entry in the box $P^{-1}(y_i) \in T$ and extend P to T by acting on the entries, with the image

$$P(T) = Y_P \otimes T_P \in F_m \otimes \mathcal{F}_{\lambda \setminus X, n} = \bigwedge^m V \otimes \mathcal{F}_{\lambda \setminus X, n},$$

where

$$Y_P = E_X \begin{array}{|c|} \hline \alpha_m^P \\ \hline \vdots \\ \hline \alpha_1^P \\ \hline \end{array}$$

which is standard form notation is $e_{\alpha_1^P} \wedge \dots \wedge e_{\alpha_m^P} \in \bigwedge^m V$, and $T_P \in \mathcal{F}_{\lambda \setminus X, n}$ is defined by $(T_P)_{[b](i,j)} = T_{P^{-1}([b](i,j))}$. As before, we omit E_X and just write

$$\begin{array}{|c|} \hline \alpha_m^P \\ \hline \vdots \\ \hline \alpha_1^P \\ \hline \end{array} \quad \text{in place of} \quad E_X \begin{array}{|c|} \hline \alpha_m^P \\ \hline \vdots \\ \hline \alpha_1^P \\ \hline \end{array}$$

in the image of $P(T)$.

Definition. The map $\Phi_m : \mathcal{F}_{\lambda,n} \rightarrow F_m \otimes \mathcal{F}_{\lambda \setminus X, n}$ is given by

$$\Phi_m(T) = \sum_P \frac{(-1)^P}{H(P)} P(T),$$

where the sum is over all m -paths P removing X .

4.5. We now compute an example of the Pieri inclusion when $m = 2$. Let $n = 6$, $\lambda = (2, 2, 1, 1, 1, 1)$, and $\mu = (2, 2, 1, 1)$. Then the Schur–Weyl module \mathbb{S}_λ appears as a summand in the decomposition of $\mathbb{S}_{(1,1)} \otimes \mathbb{S}_\mu$,

Consider the Pieri inclusion

$$\mathbb{S}_{(2,2,1,1,1,1)} \xrightarrow{\Phi_2} \mathbb{S}_{(1,1)} \otimes \mathbb{S}_{(2,2,1,1)}.$$

We will show the image of the highest weight vector under this map,

$$\Phi_2 \left(\begin{array}{c|c} 1 & 1 \\ \hline 2 & 2 \\ 3 & \\ \hline 4 & \\ 5 & \\ \hline 6 & \end{array} \right) = \sum_P \frac{(-1)^P}{H(P)} P \left(\begin{array}{c|c} 1 & 1 \\ \hline 2 & 2 \\ 3 & \\ \hline 4 & \\ 5 & \\ \hline 6 & \end{array} \right),$$

where the sum is over all m -paths P on λ removing $X = \{x_1 = [1](1, 1), x_2 = [1](2, 1)\}$. Below we illustrate all such paths with arrows, where we shade the boxes in the evacuation route, distinguishing the orbits of x_1 and x_2 . For paths hitting rows $[2](1)$ and 2, we only show the path that hits the first column of both rows, as the paths that hit the second column in either row will give the same result. As in the 1-box removal example, we give the images up to row permutations and we star the paths whose images require straightening.

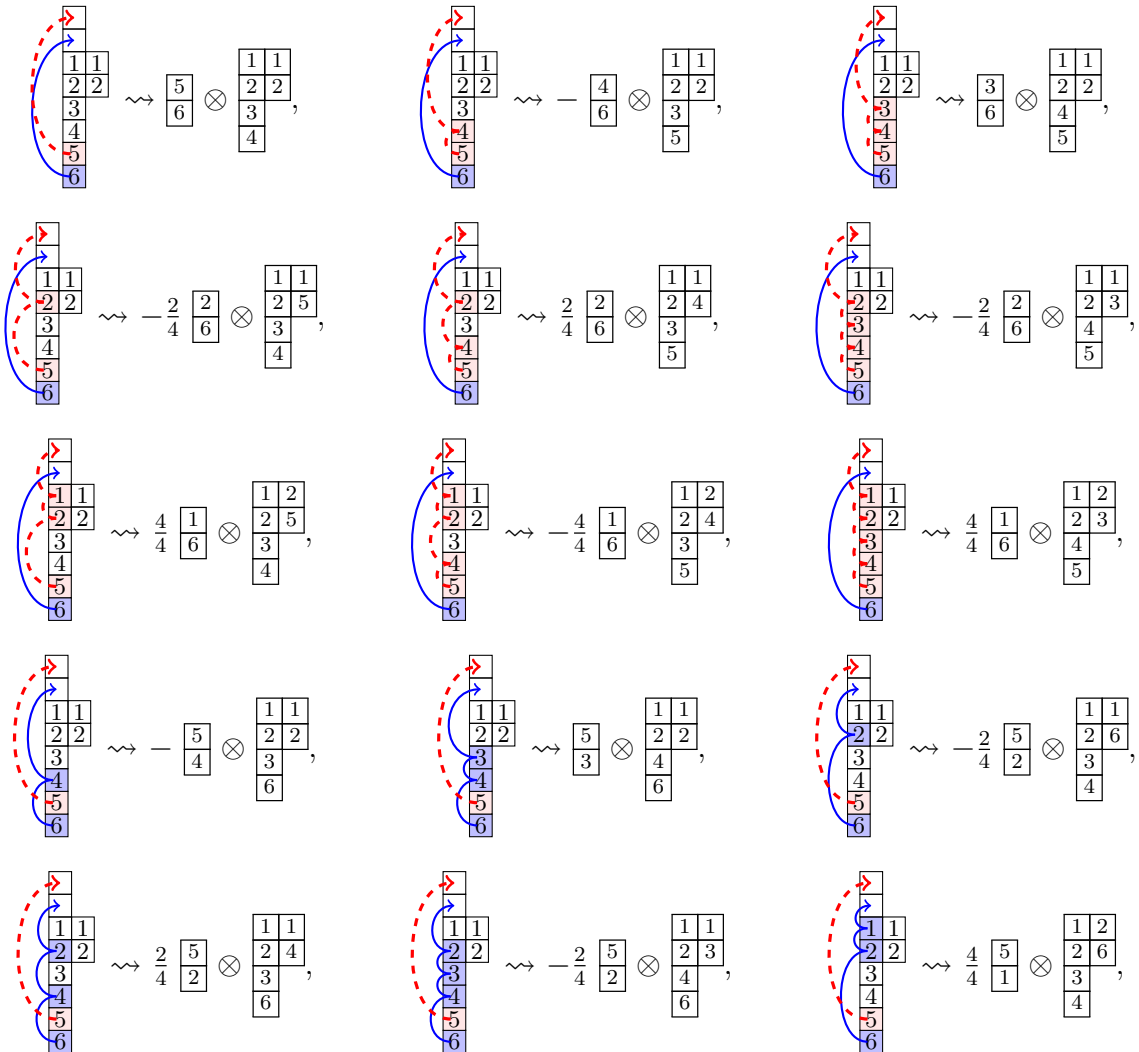

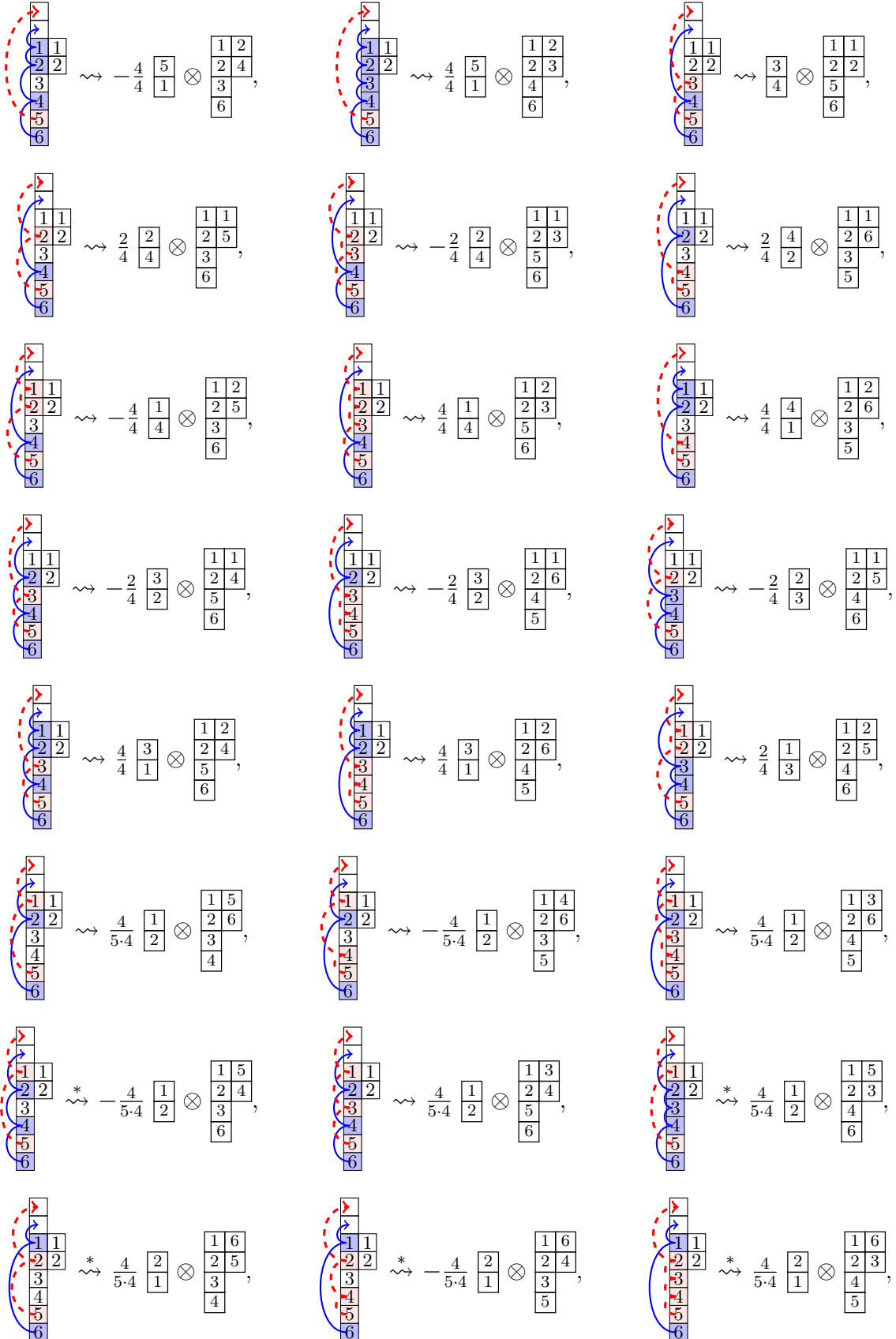

Recall that for all 2-paths P , $Y_P \in \bigwedge^2 V$, and so

$$\begin{array}{|c|} \hline \alpha \\ \hline \beta \\ \hline \end{array} = -\begin{array}{|c|} \hline \beta \\ \hline \alpha \\ \hline \end{array}.$$

Thus,

$$\begin{aligned} \Phi_2 \left(\begin{array}{|c|c|} \hline 1 & 1 \\ \hline 2 & 2 \\ \hline 3 & 3 \\ \hline 4 & 4 \\ \hline 5 & 5 \\ \hline 6 & 6 \\ \hline \end{array} \right) &= \begin{array}{|c|} \hline 5 \\ \hline 6 \\ \hline \end{array} \otimes \begin{array}{|c|c|} \hline 1 & 1 \\ \hline 2 & 2 \\ \hline 3 & 3 \\ \hline 4 & 4 \\ \hline \end{array} - \begin{array}{|c|} \hline 4 \\ \hline 6 \\ \hline \end{array} \otimes \begin{array}{|c|c|} \hline 1 & 1 \\ \hline 2 & 2 \\ \hline 3 & 3 \\ \hline 5 & 5 \\ \hline \end{array} + \begin{array}{|c|} \hline 3 \\ \hline 6 \\ \hline \end{array} \otimes \begin{array}{|c|c|} \hline 1 & 1 \\ \hline 2 & 2 \\ \hline 4 & 4 \\ \hline 5 & 5 \\ \hline \end{array} - \frac{1}{2} \begin{array}{|c|} \hline 2 \\ \hline 6 \\ \hline \end{array} \otimes \begin{array}{|c|c|} \hline 1 & 2 \\ \hline 2 & 5 \\ \hline 3 & 3 \\ \hline 4 & 4 \\ \hline \end{array} + \frac{1}{2} \begin{array}{|c|} \hline 2 \\ \hline 6 \\ \hline \end{array} \otimes \begin{array}{|c|c|} \hline 1 & 1 \\ \hline 2 & 4 \\ \hline 3 & 3 \\ \hline 5 & 5 \\ \hline \end{array} - \frac{1}{2} \begin{array}{|c|} \hline 2 \\ \hline 6 \\ \hline \end{array} \otimes \begin{array}{|c|c|} \hline 1 & 1 \\ \hline 2 & 3 \\ \hline 4 & 4 \\ \hline 5 & 5 \\ \hline \end{array} \\ &+ \begin{array}{|c|} \hline 1 \\ \hline 6 \\ \hline \end{array} \otimes \begin{array}{|c|c|} \hline 1 & 2 \\ \hline 2 & 5 \\ \hline 3 & 3 \\ \hline 4 & 4 \\ \hline \end{array} - \begin{array}{|c|} \hline 1 \\ \hline 6 \\ \hline \end{array} \otimes \begin{array}{|c|c|} \hline 1 & 2 \\ \hline 2 & 4 \\ \hline 3 & 3 \\ \hline 5 & 5 \\ \hline \end{array} + \begin{array}{|c|} \hline 1 \\ \hline 6 \\ \hline \end{array} \otimes \begin{array}{|c|c|} \hline 1 & 2 \\ \hline 2 & 3 \\ \hline 4 & 4 \\ \hline 5 & 5 \\ \hline \end{array} + \begin{array}{|c|} \hline 4 \\ \hline 5 \\ \hline \end{array} \otimes \begin{array}{|c|c|} \hline 1 & 1 \\ \hline 2 & 2 \\ \hline 3 & 3 \\ \hline 6 & 6 \\ \hline \end{array} - \begin{array}{|c|} \hline 3 \\ \hline 5 \\ \hline \end{array} \otimes \begin{array}{|c|c|} \hline 1 & 1 \\ \hline 2 & 2 \\ \hline 4 & 4 \\ \hline 6 & 6 \\ \hline \end{array} + \frac{1}{2} \begin{array}{|c|} \hline 2 \\ \hline 5 \\ \hline \end{array} \otimes \begin{array}{|c|c|} \hline 1 & 1 \\ \hline 2 & 6 \\ \hline 3 & 3 \\ \hline 4 & 4 \\ \hline \end{array} \\ &- \frac{1}{2} \begin{array}{|c|} \hline 2 \\ \hline 5 \\ \hline \end{array} \otimes \begin{array}{|c|c|} \hline 1 & 1 \\ \hline 2 & 4 \\ \hline 3 & 3 \\ \hline 6 & 6 \\ \hline \end{array} + \frac{1}{2} \begin{array}{|c|} \hline 2 \\ \hline 5 \\ \hline \end{array} \otimes \begin{array}{|c|c|} \hline 1 & 1 \\ \hline 2 & 3 \\ \hline 4 & 4 \\ \hline 6 & 6 \\ \hline \end{array} - \begin{array}{|c|} \hline 1 \\ \hline 5 \\ \hline \end{array} \otimes \begin{array}{|c|c|} \hline 1 & 2 \\ \hline 2 & 6 \\ \hline 3 & 3 \\ \hline 4 & 4 \\ \hline \end{array} + \begin{array}{|c|} \hline 1 \\ \hline 5 \\ \hline \end{array} \otimes \begin{array}{|c|c|} \hline 1 & 2 \\ \hline 2 & 4 \\ \hline 3 & 3 \\ \hline 6 & 6 \\ \hline \end{array} - \begin{array}{|c|} \hline 1 \\ \hline 5 \\ \hline \end{array} \otimes \begin{array}{|c|c|} \hline 1 & 2 \\ \hline 2 & 3 \\ \hline 4 & 4 \\ \hline 6 & 6 \\ \hline \end{array} + \begin{array}{|c|} \hline 3 \\ \hline 4 \\ \hline \end{array} \otimes \begin{array}{|c|c|} \hline 1 & 1 \\ \hline 2 & 5 \\ \hline 3 & 3 \\ \hline 6 & 6 \\ \hline \end{array} \\ &+ \frac{1}{2} \begin{array}{|c|} \hline 2 \\ \hline 4 \\ \hline \end{array} \otimes \begin{array}{|c|c|} \hline 1 & 1 \\ \hline 2 & 5 \\ \hline 3 & 3 \\ \hline 6 & 6 \\ \hline \end{array} - \frac{1}{2} \begin{array}{|c|} \hline 2 \\ \hline 4 \\ \hline \end{array} \otimes \begin{array}{|c|c|} \hline 1 & 1 \\ \hline 2 & 3 \\ \hline 5 & 5 \\ \hline 6 & 6 \\ \hline \end{array} - \frac{1}{2} \begin{array}{|c|} \hline 2 \\ \hline 4 \\ \hline \end{array} \otimes \begin{array}{|c|c|} \hline 1 & 1 \\ \hline 2 & 6 \\ \hline 3 & 3 \\ \hline 5 & 5 \\ \hline \end{array} - \begin{array}{|c|} \hline 1 \\ \hline 4 \\ \hline \end{array} \otimes \begin{array}{|c|c|} \hline 1 & 2 \\ \hline 2 & 5 \\ \hline 3 & 3 \\ \hline 6 & 6 \\ \hline \end{array} + \begin{array}{|c|} \hline 1 \\ \hline 4 \\ \hline \end{array} \otimes \begin{array}{|c|c|} \hline 1 & 2 \\ \hline 2 & 3 \\ \hline 5 & 5 \\ \hline 6 & 6 \\ \hline \end{array} - \begin{array}{|c|} \hline 1 \\ \hline 4 \\ \hline \end{array} \otimes \begin{array}{|c|c|} \hline 1 & 2 \\ \hline 2 & 6 \\ \hline 3 & 3 \\ \hline 5 & 5 \\ \hline \end{array} \\ &+ \frac{1}{2} \begin{array}{|c|} \hline 2 \\ \hline 3 \\ \hline \end{array} \otimes \begin{array}{|c|c|} \hline 1 & 1 \\ \hline 2 & 4 \\ \hline 5 & 5 \\ \hline 6 & 6 \\ \hline \end{array} + \frac{1}{2} \begin{array}{|c|} \hline 2 \\ \hline 3 \\ \hline \end{array} \otimes \begin{array}{|c|c|} \hline 1 & 1 \\ \hline 2 & 6 \\ \hline 4 & 4 \\ \hline 5 & 5 \\ \hline \end{array} - \frac{1}{2} \begin{array}{|c|} \hline 2 \\ \hline 3 \\ \hline \end{array} \otimes \begin{array}{|c|c|} \hline 1 & 1 \\ \hline 2 & 5 \\ \hline 4 & 4 \\ \hline 6 & 6 \\ \hline \end{array} - \begin{array}{|c|} \hline 1 \\ \hline 3 \\ \hline \end{array} \otimes \begin{array}{|c|c|} \hline 1 & 2 \\ \hline 2 & 4 \\ \hline 5 & 5 \\ \hline 6 & 6 \\ \hline \end{array} - \begin{array}{|c|} \hline 1 \\ \hline 3 \\ \hline \end{array} \otimes \begin{array}{|c|c|} \hline 1 & 2 \\ \hline 2 & 6 \\ \hline 4 & 4 \\ \hline 5 & 5 \\ \hline \end{array} + \frac{1}{2} \begin{array}{|c|} \hline 1 \\ \hline 3 \\ \hline \end{array} \otimes \begin{array}{|c|c|} \hline 1 & 2 \\ \hline 2 & 5 \\ \hline 4 & 4 \\ \hline 6 & 6 \\ \hline \end{array} \\ &+ \frac{2}{5} \begin{array}{|c|} \hline 1 \\ \hline 2 \\ \hline \end{array} \otimes \begin{array}{|c|c|} \hline 1 & 5 \\ \hline 2 & 6 \\ \hline 3 & 3 \\ \hline 4 & 4 \\ \hline \end{array} - \frac{2}{5} \begin{array}{|c|} \hline 1 \\ \hline 2 \\ \hline \end{array} \otimes \begin{array}{|c|c|} \hline 1 & 4 \\ \hline 2 & 6 \\ \hline 3 & 3 \\ \hline 5 & 5 \\ \hline \end{array} + \frac{2}{5} \begin{array}{|c|} \hline 1 \\ \hline 2 \\ \hline \end{array} \otimes \begin{array}{|c|c|} \hline 1 & 3 \\ \hline 2 & 6 \\ \hline 4 & 4 \\ \hline 5 & 5 \\ \hline \end{array} - \frac{1}{5} \begin{array}{|c|} \hline 1 \\ \hline 2 \\ \hline \end{array} \otimes \begin{array}{|c|c|} \hline 1 & 2 \\ \hline 3 & 5 \\ \hline 4 & 4 \\ \hline 6 & 6 \\ \hline \end{array} - \frac{1}{5} \begin{array}{|c|} \hline 1 \\ \hline 2 \\ \hline \end{array} \otimes \begin{array}{|c|c|} \hline 1 & 2 \\ \hline 3 & 4 \\ \hline 5 & 5 \\ \hline 6 & 6 \\ \hline \end{array} \\ &+ \frac{2}{5} \begin{array}{|c|} \hline 1 \\ \hline 2 \\ \hline \end{array} \otimes \begin{array}{|c|c|} \hline 1 & 4 \\ \hline 2 & 5 \\ \hline 3 & 3 \\ \hline 6 & 6 \\ \hline \end{array} + \frac{2}{5} \begin{array}{|c|} \hline 1 \\ \hline 2 \\ \hline \end{array} \otimes \begin{array}{|c|c|} \hline 1 & 3 \\ \hline 2 & 4 \\ \hline 5 & 5 \\ \hline 6 & 6 \\ \hline \end{array} - \frac{2}{5} \begin{array}{|c|} \hline 1 \\ \hline 2 \\ \hline \end{array} \otimes \begin{array}{|c|c|} \hline 1 & 3 \\ \hline 2 & 5 \\ \hline 4 & 4 \\ \hline 6 & 6 \\ \hline \end{array} + \frac{2}{5} \begin{array}{|c|} \hline 1 \\ \hline 2 \\ \hline \end{array} \otimes \begin{array}{|c|c|} \hline 1 & 2 \\ \hline 3 & 6 \\ \hline 4 & 4 \\ \hline 5 & 5 \\ \hline \end{array}.\end{aligned}$$

5. GENERATING GARNIR RELATIONS AND TOOLS FOR COLLAPSING SUMS

5.1. We will show that all Garnirs are generated by Garnirs of minimal size, i.e. those G_A with $|A| = w_A + 1$ (where w_A is as in Section 2.4). We then show that all Garnirs of minimal size are themselves generated by Garnirs over hooks, which are those G_A where A is of minimal size and consists of exactly a complete row and one other box. We start by formalizing the idea of a hook.

Definition (Hook). We say that $A \subset T_0$ is a hook if for some row $[b](r)$,

$$A = [b](r) \cup \{a_0\}$$

where

$$a_0 = \begin{cases} [b](r-1, 1) & \text{if } r \neq 1 \\ [b-1](h_{b-1}, 1) & \text{if } r = 1 \end{cases}.$$

That is,

$$A = \begin{array}{|c|c|c|} \hline & \overbrace{\hspace{2cm}}^{w_b} & \\ \hline & \dots & \\ \hline & & \\ \hline \end{array}$$

Theorem. *Let $T \in \mathcal{F}_{\lambda,n}$ and $A \subset T_0$ such that $|A| > w_A$. Then*

$$G_A(T) \in \langle G_{A'}(T') : T' \in \mathcal{F}_{\lambda,n}, A' \text{ is a hook} \rangle.$$

5.2. To prove Theorem 5.1, we first show that $G_A(T)$ is generated by Garnirs of minimal size for any $T \in \mathcal{F}_{\lambda,n}$ and any $A \subset T_0$ with $|A| > w_A$. We will also show that if $|A| > w_A + 1$, then $G_A(T)$ is generated by Garnirs over $A \setminus \{y\}$ for any $y \in A$.

Lemma. *Let $T \in \mathcal{F}_{\lambda,n}$. If $A \subset T_0$ with $|A| > w_A$, then for any $x \in T_0$ such that $|A \cup \{x\}| > w_{A \cup \{x_0\}}$,*

$$G_{A \cup \{x\}}(T) \in \langle G_A(T') : T' \in \mathcal{F}_{\lambda,n} \rangle.$$

Proof. Let $A \subset T_0$ with $|A| > w_A$ and $x \in T_0 \setminus A$. For all $y \in A \cup \{x\}$, let $\tau_{x,y}$ be the permutation that switches x and y and fixes the rest of $A \cup \{x\}$. Then for any $\sigma \in \mathfrak{S}_{A \cup \{x\}}$,

$$\sigma(y) = x \iff (\sigma\tau_{x,y})(x) = x \iff \sigma\tau_{x,y} \in \mathfrak{S}_A.$$

Then,

$$\begin{aligned} G_{A \cup \{x\}}(T) &= \sum_{\sigma \in \mathfrak{S}_{A \cup \{x\}}} \sigma T \\ &= \sum_{y \in A \cup \{x\}} \sum_{\substack{\sigma \in \mathfrak{S}_{A \cup \{x\}} \\ \text{s.t. } \sigma(y)=x}} \sigma T \\ &= \sum_{y \in A \cup \{x\}} \sum_{\substack{\sigma \in \mathfrak{S}_{A \cup \{x\}} \\ \text{s.t. } \sigma(y)=x}} (\sigma\tau_{x,y})(\tau_{x,y}T) \\ &= \sum_{y \in A \cup \{x\}} \sum_{\tilde{\sigma} \in \mathfrak{S}_A} \tilde{\sigma}(\tau_{x,y}T) \\ &= \sum_{y \in A \cup \{x\}} G_A(\tau_{x,y}T) \in \langle G_A(T') : T' \in \mathcal{F}_{\lambda,n} \rangle \end{aligned}$$

□

5.3. We now show that all Garnirs of minimal size are generated by Garnirs over a set consisting of a full row and a box below that row.

Lemma. *Let $T \in \mathcal{F}_{\lambda,n}$. If $A \subset T_0$ of minimal size, then*

$$G_A(T) \in \langle G_{A' \cup \{b_0\}}(T') : T' \in \mathcal{F}_{\lambda,n}, A' = [b](r) \text{ for some } [b](r) \subset T_0, b_0 < [b](r) \rangle.$$

Proof. Let $T \in \mathcal{F}_{\lambda,n}$ and $A \subset T_0$ such that $A \subset [b](r)$. Assume, without loss of generality, that $r \neq 1$ (else, replace $[b](r-1)$ in the following argument with $[b-1](h_{b-1})$). Let $B \subset T_0$ such that $B < [b](r)$, $B \not\subset [b](r-1)$, and $|A \cup B| = w_b + 1$. Assume $A \neq [b](r)$, i.e. $|B| \neq 1$. We will show that

$$G_{A \cup B}(T) \in \langle G_{A' \cup B'}(T') : T' \in \mathcal{F}_{\lambda,n}, A' = [b](r), |B'| = 1, B' < A \rangle.$$

Pick $x_0 \in [b](r) \setminus A$ and $b_0 \in B$.

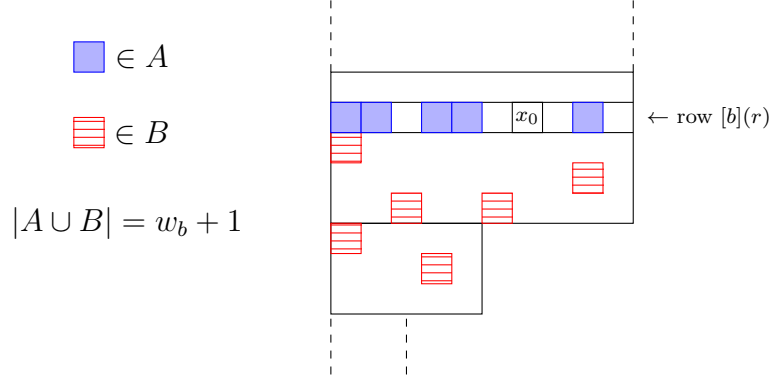

For all $x \in A \cup \{x_0\} \cup B$, define $\tau_{x_0, x}$ as before. Then for all $\sigma \in \mathfrak{S}_{A \cup \{x_0\} \cup B}$,

$$\sigma(x_0) = x \iff (\tau_{x_0, x} \sigma) x_0 = x_0 \iff \tau_{x_0, x} \sigma \in \mathfrak{S}_{A \cup B}$$

and

$$\sigma(x_0) = x \iff (\sigma \tau_{x_0, x}) x = x \iff \sigma \tau_{x_0, x} \in \mathfrak{S}_{A \cup B \cup \{x_0\} \setminus \{x\}}.$$

Then,

$$\begin{aligned}
G_{A \cup \{x_0\} \cup B}(T) &= \sum_{\sigma \in \mathfrak{S}_{A \cup \{x_0\} \cup B}} \sigma T \\
&= \sum_{a \in A \cup \{x_0\}} \sum_{\substack{\sigma \in \mathfrak{S}_{A \cup \{x_0\} \cup B}, \\ \sigma(x_0) = a}} \sigma T + \sum_{b \in B} \sum_{\substack{\sigma \in \mathfrak{S}_{A \cup \{x_0\} \cup B}, \\ \sigma(x_0) = b}} \sigma T \\
&= \sum_{a \in A \cup \{x_0\}} \sum_{\substack{\sigma \in \mathfrak{S}_{A \cup \{x_0\} \cup B}, \\ \sigma(x_0) = a}} \tau_{x_0, a} (\tau_{x_0, a} \sigma) T + \sum_{b \in B} \sum_{\substack{\sigma \in \mathfrak{S}_{A \cup \{x_0\} \cup B}, \\ \sigma(x_0) = b}} (\sigma \tau_{x_0, b}) \tau_{x_0, b} T \\
&= \sum_{a \in A \cup \{x_0\}} \sum_{\tilde{\sigma} \in \mathfrak{S}_{A \cup B}} \tau_{x_0, a} \tilde{\sigma} T + \sum_{b \in B} \sum_{\tilde{\sigma} \in \mathfrak{S}_{A \cup \{x_0\} \cup B \setminus \{b\}}} \tilde{\sigma} \tau_{x_0, b} T \\
&= \sum_{a \in A \cup \{x_0\}} \tau_{x_0, a} G_{A \cup B}(T) + \sum_{b \in B} G_{A \cup \{x_0\} \cup B \setminus \{b\}}(\tau_{x_0, b} T)
\end{aligned}$$

and as $\tau_{x_0, a}$ is a row permutation for all $a \in A \cup \{x_0\}$, up to row permutations we have

$$(5.3.1) \quad G_{A \cup \{x_0\} \cup B}(T) = |A \cup \{x_0\}| G_{A \cup B}(T) + \sum_{b \in B} G_{A \cup \{x_0\} \cup B \setminus \{b\}}(\tau_{x_0, b} T).$$

Solving for $G_{A \cup B}(T)$ in equation 5.3.1 we get

$$G_{A \cup B}(T) = \frac{1}{|A \cup \{x_0\}|} \left(G_{A \cup \{x_0\} \cup B}(T) - \sum_{b \in B} G_{A \cup \{x_0\} \cup B \setminus \{b\}}(\tau_{x_0, b} T) \right).$$

By Lemma 5.2, $G_{A \cup B \cup \{x_0\}}(T)$ is generated by Garnirs over $A \cup \{x_0\} \cup B \setminus \{b_0\}$. Thus $G_{A \cup B}(T)$ is generated by Garnirs over $A' \cup B'$, where $A' = A \cup \{x_0\}$, so that $|A' \cap [b](r)| = |A \cap [b](r)| + 1$, and $B' = B \setminus \{b\}$ for some $b \in B$, so that $|B'| = |B| - 1$. By induction, we get that

$$G_{A \cup B}(T) \in \langle G_{A' \cup B'}(T') : T' \in \mathcal{F}_{\lambda, n}, A' = [b](r), |B'| = 1 \rangle.$$

□

5.4. We now give a way to write $G_{A \cup B}(T)$ as above as a sum of 2-cycles, which will make our calculations easier throughout.

Lemma. *Let $A = [b](r)$ and $b_0 \in T_0 \setminus A$. Then for all $T \in \mathcal{F}_{\lambda, n}$,*

$$G_A(T) = w_b! \sum_{a \in A} \tau_{a, b_0} T \pmod{\mathcal{R}_{\lambda, n}}.$$

Proof.

$$\begin{aligned} G_A(T) &= \sum_{\sigma \in \mathfrak{S}_{A \cup \{b_0\}}} \sigma T \\ &= \sum_{\tilde{\sigma} \in \mathfrak{S}_A} \sum_{a \in A \cup \{b_0\}} \tilde{\sigma} \tau_{a, b_0} T \\ &= w_b! \sum_{a \in A \cup \{b_0\}} \tau_{a, b_0} T \pmod{\mathcal{R}_{\lambda, n}}, \end{aligned}$$

as all $\tilde{\sigma} \in \mathfrak{S}_A$ are row permutations and $|A| = w_b$. \square

5.5. To prove Theorem 5.1, it remains to show that all Garnirs of the form $G_{A \cup B}(T)$ where $A = [b](r)$ and $|B| = 1$, with $B < A$, are generated by Garnirs over hooks. We show that for any such A and B , $G_{A \cup B}(T)$ is generated by Garnirs over $A' \cup B'$ where A' is a full row and $|B'| = 1$ with $B' < A'$, and where the distance between A' and B' is less than the distance between A and B . Theorem 5.1 is then proved by iterating this until we get that $G_{A \cup B}(T)$ is generated (up to row permutation) by Garnirs over hooks.

Lemma. *Let $T \in \mathcal{F}_{\lambda, n}$, $A = [b](r)$, $B \subset T_0$ with $|B| = 1$ and $B < A$. Then*

$$G_{A \cup B}(T) \in \langle G_{A'}(T') : T' \in \mathcal{F}_{\lambda, n}, A' \text{ is a hook} \rangle.$$

Proof. Let $A = [b](r)$ and $B = \{b_0\}$ with $b_0 \in [c](s)$ and $[c](s) < [b](r)$. Let j be the number of rows between $[b](r)$ and $[c](s)$. Without loss of generality we will assume that $r > j + 1$ and $b_0 = [b](r - j - 1, 1)$. Then

$$\begin{aligned} G_{A \cup B}(T) &= \sum_{\sigma \in A \cup B} \sigma T \\ &= \sum_{\tilde{\sigma} \in S_A} \sum_{a \in A \cup B} \tilde{\sigma} \tau_{a, b_0} T \\ &= w_b! \sum_{a \in A \cup B} \tau_{a, b_0} T. \end{aligned}$$

We also have that for all $a \in A \cup B$,

$$G_{[b](r-j) \cup B}(\tau_{a, b_0} T) = w_b! \left(\tau_{a, b_0} T + \sum_{x \in [b](r-j)} \tau_{x, b_0} \tau_{a, b_0} T \right)$$

and hence

$$\tau_{a, b_0} T = \frac{1}{w_b!} G_{[b](r-j) \cup B}(\tau_{a, b_0} T) - \sum_{x \in [b](r-j)} \tau_{x, b_0} \tau_{a, b_0} T.$$

Now observe that for all $a \in A \cup B$ and all $x \in [b](r-j)$, $\tau_{x,b_0}\tau_{a,b_0}T = \tau_{a,x}\tau_{x,b_0}T$. Then,

$$\begin{aligned}
G_{A \cup B}(T) &= w_b! \sum_{a \in A \cup B} \tau_{a,b_0}T \\
&= w_b! \left(\sum_{a \in A \cup B} \frac{1}{w_b!} G_{[b](r-j) \cup B}(\tau_{a,b_0}T) - \sum_{x \in [b](r-j)} \tau_{x,b_0}\tau_{a,b_0}T \right) \\
&= \sum_{a \in A \cup B} G_{[b](r-j) \cup B}(\tau_{a,b_0}T) - w_b! \sum_{a \in A \cup B} \sum_{x \in [b](r-j)} \tau_{x,b_0}\tau_{a,b_0}T \\
&= \sum_{a \in A \cup B} G_{[b](r-j) \cup B}(\tau_{a,b_0}T) - w_b! \sum_{x \in [b](r-j)} \left(\tau_{x,b_0}T + \sum_{a \in A} \tau_{x,b_0}\tau_{a,b_0}T \right) \\
&= \sum_{a \in A \cup B} G_{[b](r-j) \cup B}(\tau_{a,b_0}T) - w_b! \sum_{x \in [b](r-j)} \left(\tau_{x,b_0}T + \sum_{a \in A} \tau_{a,x}\tau_{x,b_0}T \right) \\
&= \sum_{a \in A \cup B} G_{[b](r-j) \cup B}(\tau_{a,b_0}T) - w_b! \sum_{x \in [b](r-j)} G_{A \cup \{x\}}(\tau_{x,b_0}T).
\end{aligned}$$

□

So we have that for any $T \in \mathcal{F}_{\lambda,n}$ and any $A \subset T_0$ with $|A| > w_A$, $G_A(T)$ is generated by Garnirs over hooks.

5.6. The rest of this section is devoted to collapsing the sum in the image $\Phi_m(T)$. We first consider the 1-path case, where the idea is that the sum over all possible paths between two boxes can be collapsed to a single tableau, mod $\mathcal{R}_{\lambda \setminus X,n}$, with parity depending only on the number of rows between the two boxes. See Figure 5.6.1. We then generalize the result to 2-paths, before considering the m -path case.

Definition (σ_k^A). Let $A \subset T_0$ be a hook with $[b](r)$ the top row of A . Label the boxes in $[b](r)$ as a_1, \dots, a_{w_b} and let a_0 be the box in A below $[b](r)$. For $k = 0, \dots, w_b$, define σ_k^A to be the permutation of A that switches a_0 and a_k and is the identity otherwise. For $T \in \mathcal{F}_{\lambda,n}$ and $0 \leq k \leq w_b$, let $A_k = T_{a_k}$ and extend σ_k^A to act on the entries of T , so that $\sigma_k^A A_k = A_0$ and σ_k^A is the identity on T otherwise. Then, by Lemma 5.4,

$$G_A(T) = w_b! \sum_{k=0}^{w_b} \sigma_k^A T \quad \text{mod } \mathcal{R}_{\lambda,n}.$$

5.7. It will be useful to be able to identify those paths that are similar to a given m -path. Given an m -path P and two rows $[b](r)$ and $[c](s)$, a $([b](r), [c](s))$ -path extension of P is an m -path Q that is identical to P except on the interval of rows $([b](r), [c](s))$ and on any boxes whose image under P is in the interval of rows $([b](r), [c](s))$. In the row interval $([b](r), [c](s))$, Q can differ from P , and in fact can even act on different boxes.

- $P|_{R_{>[c](s)}^P} = Q|_{R_{>[c](s)}^P}$
- $P|_{R_{<[b](r)}^P \setminus I} = Q|_{R_{<[b](r)}^P \setminus I}$, where $I = \{x \in R_{<[b](r)}^P : P(x) \in ([b](r), [c](s))\}$.

5.8. For any $T \in \mathcal{F}_{\lambda, n}$, let

$$X = \{x_1 := [b_1](1, w_{b_1})\} \text{ and } Y = \{y_1 := [N+1](1, 1)\}$$

and let

$$z_1 := T_{[b_z](i_1, j_1)}$$

for some $1 \leq b_1 \leq b_z \leq N$, $1 \leq i_1 \leq h_{b_z}$, and $1 \leq j_1 \leq w_{b_z}$. Let $u := T_{[b_u](i_u, j_u)}$ for some $b_1 \leq b_u \leq b_z$, $1 \leq i_u \leq h_{b_u}$, and $1 \leq j_u \leq w_{b_u}$, and let P be any 1-path on λ removing X such that $P([b_u](i_u, j_u)) \in [b_z](1)$ and $P([b_z](i_1, j_1)) > [b_z](i_1)$, including the case $P([b_z](i_1, j_1)) = y_1$. Let

$$[P] = \{1\text{-paths } Q \text{ on } \lambda : Q \text{ is a } ([b_z](1), [b_z](i_1))\text{-path extension of } P \\ \text{with } Q([b_z](i_1, j_1)) = P([b_z](i_1, j_1))\}$$

and $T' \in \mathcal{F}_{\lambda \setminus X, n}$ be the unique tableau such that $T' = T_P$ on $(\lambda \setminus X)$, except on the interval of rows $([b_z](1), [b_z](i_1))$, where $T' = T$, except $T'_{[b_z](i_1, j_1)} = u$. We then have the following.

Lemma.

$$\sum_{Q \in [P]} Q(T) = (-1)^{i_1-1} \boxed{\alpha_1^P} \otimes T' \pmod{F_1 \otimes \mathcal{R}_{\lambda \setminus X, n}}.$$

Proof. Assume, without loss of generality, that $j_1 = 1$. We will show the case $b_u < b_z$, the case $b_u = b_z$ is similar. If $i_1 = 1$, then $[P] = \{P\}$, and so

$$\begin{aligned} \sum_{Q \in [P]} Q(T) &= P(T) \pmod{F_1 \otimes \mathcal{R}_{\lambda \setminus X, n}} \\ &= \boxed{\alpha_1^P} \otimes T' \pmod{F_1 \otimes \mathcal{R}_{\lambda \setminus X, n}}, \end{aligned}$$

as desired. Let $i_1 = 2$ and

$$A = \{a_1 := [b_z](1, k), \dots, a_{w_{b_z}} := [b_z](1, w_{b_z})\} \cup \{a_0 := [b_z](2, 1)\}.$$

Then by Lemma 5.4 we have the following (see Figure 5.8.1).

$$\begin{aligned} \sum_{Q \in [P]} Q(T) &= \sum_{k=1}^{w_{b_z}} \boxed{\alpha_1^P} \otimes \sigma_k^A T' \\ &= \boxed{\alpha_1^P} \otimes \left(\frac{1}{w_{b_z}!} G_A(T') - T' \right) \pmod{F_1 \otimes \mathcal{R}_{\lambda \setminus X, n}} \\ &= - \boxed{\alpha_1^P} \otimes T' \pmod{F_1 \otimes \mathcal{R}_{\lambda \setminus X, n}}. \end{aligned}$$

Now let $i_1 > 2$ and

$$B = \{b_1 := [b_z](i_1 - 1, k), \dots, b_{w_{b_z}} := [b_z](i_1 - 1, w_{b_z})\} \cup \{b_0 := [b_z](i_1, 1)\}.$$

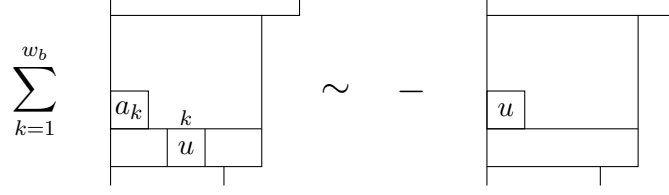

FIGURE 5.8.1

Then by Lemma 5.4 and induction applied to each entry in $(i_1 - 1)^{b_z}$, we have

$$\begin{aligned}
\sum_{Q \in [P]} Q(T) &= \sum_{k=1}^{w_{b_z}} (-1)^{i_1-2} \boxed{\alpha_1^P} \otimes \sigma_k^B T' \pmod{F_1 \otimes \mathcal{R}_{\lambda \setminus X, n}} \\
&= (-1)^{i_1-2} \boxed{\alpha_1^P} \otimes \left(\frac{1}{w_{b_z}!} G_B(T') - T' \right) \pmod{F_1 \otimes \mathcal{R}_{\lambda \setminus X, n}} \\
&= (-1)^{i_1-1} \boxed{\alpha_1^P} \otimes T' \pmod{F_1 \otimes \mathcal{R}_{\lambda \setminus X, n}}.
\end{aligned}$$

Thus the claim holds for $1 \leq i_1 \leq h_{b_z}$. \square

5.9. Lemma 5.8 also allows for calculations of sums of 2-paths, by applying the technique of the proof twice and “skipping” certain rows each time. That is, for any $T \in \mathcal{F}_{\lambda, n}$, let

$$\begin{aligned}
X &:= \{x_1 := [b_1](1, w_{b_1}), x_2 := [b_2](i_2, w_{b_2})\}, \\
Y &:= \{y_1 := [N+1](1, 1), y_2 := [N+1](2, 1)\}
\end{aligned}$$

and let

$$z_1 := T_{[b_z](i_1, j_1)}, \quad z_2 := T_{[b_z](i_2, j_2)}$$

for some $1 \leq b_1 \leq b_z \leq N$, $1 \leq i_2 < i_1 \leq h_{b_z}$, and $1 \leq j_1, j_2 \leq w_{b_z}$. Let

$$u_1 := T_{[b_{u_1}](i_{u_1}, j_{u_1})}, \quad u_2 := T_{[b_{u_2}](i_{u_2}, j_{u_2})}$$

for some $b_1 \leq b_{u_1}, b_{u_2} \leq b_z$, $1 \leq i_{u_1} \leq h_{b_{u_1}}$, $1 \leq j_{u_1} \leq w_{b_{u_1}}$, $1 \leq i_{u_2} \leq h_{b_{u_2}}$, and $1 \leq j_{u_2} \leq w_{b_{u_2}}$. If $b_{u_1} = b_{u_2}$, then we also assume that $i_{u_1} \neq i_{u_2}$. Let P be any 2-path on λ such that

$$\begin{aligned}
P([b_{u_1}](i_{u_1}, j_{u_1})) &\in [b_z](1), P([b_{u_2}](i_{u_2}, j_{u_2})) \in [b_z](2), \\
P([b_z](i_1, j_1)), P([b_z](i_2, j_2)) &> [b_z](i_1).
\end{aligned}$$

Assume, without loss of generality, that $P([b_z](i_1, j_1)), P([b_z](i_2, j_2)) \notin Y$. Let

$$\begin{aligned}
[P] &= \{2\text{-paths } Q \text{ on } \lambda : Q \text{ is a } ([b_z](1), [b_z](i_1))\text{-path extension of } P \\
&\text{with } Q([b_z](i_1, j_1)) = P([b_z](i_1, j_1)), Q([b_z](i_2, j_2)) = P([b_z](i_2, j_2))\}
\end{aligned}$$

and $T' \in \mathcal{F}_{\lambda \setminus X, n}$ be the unique tableau such that $T' = T_P$ on $(\lambda \setminus X)$, except on the interval of rows $([b_z](1), [b_z](i_1))$, where $T' = T$, except $T'_{[b_z](i_1, j_1)} = u$, $T'_{[b_z](i_2, j_2)} = v$. We then have the following.

Corollary.

$$\sum_{Q \in [P]} Q(T) = (-1)^{i_1-2+i_2-2} \boxed{\frac{\alpha_2^P}{\alpha_1^P}} \otimes T' \pmod{F_2 \otimes \mathcal{R}_{\lambda \setminus X, n}}.$$

Proof. Apply the techniques from the proof of Lemma 5.8 to get a sum of tableaux with u_1 in the box $[b_z](i_1, j_1)$, skipping row $[b_z](i_2)$, then apply the techniques again to get u_2 in the box $[b_z](i_2, j_2)$, skipping row $[b_z](i_2 - 1)$. \square

5.10. The same technique used above immediately generalizes to sums of m -path extensions. Fix $m > 2$. For any $T \in \mathcal{F}_{\lambda, n}$, let

$$X = \{x_1 = [b_1](1, w_{b_1}), \dots, x_m = [b_m](i_m, w_{b_m})\}$$

be a removal set and

$$z_k = T_{[b_z](i_k, j_k)} \quad \text{for } 1 \leq k \leq m$$

for some $1 \leq b_1 \leq b_z \leq N$, $1 \leq i_m < \dots < i_1 \leq h_{b_z}$, and $1 \leq j_k \leq w_{b_z}$ for $1 \leq k \leq m$. Let

$$u_k = T_{[b_{u_k}](i_{u_k}, j_{u_k})} \quad \text{for } 1 \leq k \leq m$$

for some $b_1 \leq b_{u_k} \leq b_z$, $1 \leq i_{u_k} \leq h_{b_{u_k}}$, $1 \leq j_{u_k} \leq w_{b_{u_k}}$. If $b_{u_k} = b_{u_l}$ for $k \neq l$, then we also assume that $i_{u_k} \neq i_{u_l}$. Let P be any m -path on λ such that, for $1 \leq k \leq m$,

$$P([b_{u_k}](i_{u_k}, j_{u_k})) \in [b_z](k)$$

and

$$P([b_z](i_k, j_k)) > [b_z](i_1).$$

Assume, without loss of generality, that $P([b_z](i_k, j_k)) \notin Y$ for $1 \leq k \leq m$. Let

$$[P] = \{m\text{-paths } Q \text{ on } \lambda : Q \text{ is a } ([b_z](1), [b_z](i_1))\text{-path extension of } P \\ \text{such that } Q([b_z](i_k, j_k)) = P([b_z](i_k, j_k)) \text{ for } 1 \leq k \leq m\}$$

and $T' \in \mathcal{F}_{\lambda \setminus X, n}$ be the unique tableau such that $T' = T_P$ on $(\lambda \setminus X)$ except on $([b_z](1), [b_z](i_2))$, where $T' = T$ except $T'_{[b_z](i_k, j_k)} = u_k$ for $1 \leq k \leq m$. We then have the following.

Corollary.

$$\sum_{Q \in [P]} Q(T) = (-1)^{i_1 - m + \dots + i_m - m} \begin{array}{|c|} \hline \alpha_m^P \\ \hline \vdots \\ \hline \alpha_1^P \\ \hline \end{array} \otimes T' \quad \text{mod } F_m \otimes \mathcal{R}_{\lambda \setminus X, n}$$

Proof. Assume, without loss of generality, that

$$\begin{aligned} i_1 &> i_2 \\ i_2 &> i_3 + 1 \\ &\vdots \\ i_{m-1} &> i_m + (m-1) - 1. \end{aligned}$$

Otherwise, the following goes through by skipping the appropriate rows. Apply the techniques from the proof of Lemma 5.8 to get a sum of tableaux with u_1 in the box $[b_z](i_1, j_1)$, skipping rows i_m^z, \dots, i_2^z . Then iterate the techniques again to get u_k in the box $[b_z](i_k, j_k)$, skipping rows $[b_z](i_m), \dots, [b_z](i_{k+1})$ and rows $[b_z](i_k - 1), \dots, [b_z](i_k - (k - 1))$. \square

6. SHOWING THE PIERI INCLUSION REMOVING ONE BOX IS A $GL(V)$ -MAP

6.1. For all of Section 6, fix $X = \{x_1 := [b_1](1, w_{b_1})\} \subset T_0$ to be removed. Let

$$\Phi_1 : \mathcal{F}_{\lambda, n} \rightarrow V \otimes \mathcal{F}_{\lambda \setminus X, n}$$

be as in Section 3.7.

Theorem. Φ_1 is a $GL(V)$ -map, i.e. Φ_1 descends to

$$\Phi_1 : \mathbb{S}_\lambda(V) \rightarrow F_1 \otimes \mathbb{S}_{\lambda \setminus X}(V)$$

and Φ_1 is $GL(V)$ -equivariant.

For each simple root vector α_i with respect the standard Cartan subalgebra, the action of e_{α_i} on a tableau T generates a sum of tableau \tilde{T} where each entry i in T is replaced by an $i + 1$. Similarly, for each $e_{-\alpha_i}$, where each entry i in T is replaced by an $i - 1$. As Φ_1 is a sum over 1-paths that move entries up the diagram, acting with e_{α_i} and applying Φ_1 to the sum is the same as the opposite order. As the simple root vectors generate $\mathfrak{gl}(V)$, Φ_1 is $\mathfrak{gl}(V)$ -equivariant.

To prove Theorem 6.1, it remains to show that

$$\Phi_1(\mathcal{R}_{\lambda, n}) \subset F_1 \otimes \mathcal{R}_{\lambda \setminus X, n}.$$

It is clear that Φ_1 preserves Property 2.5.1 as it is a sum over all 1-paths, and hence we must show that Property 2.5.2 holds, i.e. for all $T \in \mathcal{F}_{\lambda, n}$ and all $A \subset T_0$ with $|A| > w_A$,

$$(6.1.1) \quad \Phi_1(G_A(T)) \in F_1 \otimes \mathcal{R}_{\lambda \setminus X, n}.$$

By Theorem 5.1, it is enough to show that Equation 6.1.1 holds for all hooks A . If A is a hook, either A is completely contained in a block b , with $1 \leq b \leq N$, or A is contained in two blocks, b and $b + 1$, with $1 \leq b \leq N - 1$. We consider these two options separately.

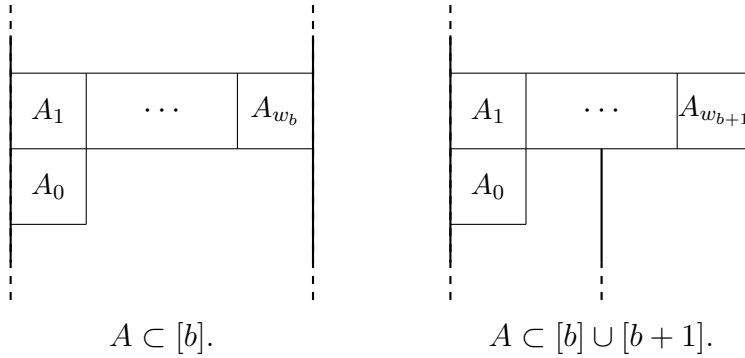

6.2. One Box Removal Preserves Garnirs for Hooks Contained in a Single Block.

We first show that Equation 6.1.1 holds for all hooks $A \subset [b]$, for some $1 \leq b \leq N$. For the rest of Section 6.2, fix $T \in \mathcal{F}_{\lambda, n}$ and

$$A = \{a_0 := [b](i_0, 1), a_1 := [b](i_0 + 1, 1), \dots, a_{w_b} := [b](i_0 + 1, w_b)\} \subset T_0$$

with $1 \leq i_0 < h_b$, so that $A \subset [b]$. Denote the entries of A in T by $A_k = T_{a_k}$ for $k = 0, 1, \dots, w_b$. Then by Lemma 5.4, mod $F_1 \otimes \mathcal{R}_{\lambda \setminus X, n}$ we have

$$\Phi_1(G_A(T)) = \sum_P \frac{(-1)^P}{H(P)} P \left(\sum_{\sigma \in S_A} \sigma T \right) = C \sum_P \sum_{k=0}^{w_b} \frac{(-1)^P}{H(P)} P(\sigma_k^A T),$$

where the sum is over all 1-paths P on λ removing X . The set of all $P_k := P(\sigma_k^A T)$ appearing in the image $\Phi_1(G_A(T))$ above is the union of the following disjoint sets.

The P_k s that miss A ,

$$(6.2.1) \quad \mathcal{T}_1 = \{P_k : R^P \cap A = \emptyset\}.$$

The P_k s that hit A and keep A in block b ,

$$(6.2.2) \quad \mathcal{T}_2 = \{P_k : R^P \cap A \neq \emptyset, P(A) \leq [b]\}.$$

The P_k s that hit A and move the entry A_i above block b , including $P(\sigma_k^A A_i) \in Y$,

$$(6.2.3) \quad \mathcal{T}_3 = \bigsqcup_{i=0}^{w_b} \mathcal{T}_3^i, \quad \text{where} \quad \mathcal{T}_3^i = \{P_k : R^P \cap A \neq \emptyset, P(\sigma_k^A A_i) > [b]\}.$$

We then have, mod $F_1 \otimes \mathcal{R}_{\lambda \setminus X, n}$,

$$\Phi_1(G_A(T)) = C \sum_P \sum_{k=0}^{w_b} \frac{(-1)^P}{H(P)} P(\sigma_k^A T) = C \sum_{j=1}^3 \sum_{P_k \in \mathcal{T}_j} \frac{(-1)^P}{H(P)} P_k.$$

We show that for each of the cases (6.2.1) - (6.2.3),

$$\sum_{P_k \in \mathcal{T}_j} \frac{(-1)^P}{H(P)} P_k \in F_1 \otimes \mathcal{R}_{\lambda \setminus X, n},$$

and hence Equation 6.1.1 holds for all hooks A with $A \subset [b]$.

Case (6.2.1). In this case we show that the sum over all paths that miss A is in $F_1 \otimes \mathcal{R}_{\lambda \setminus X, n}$, i.e.

$$\sum_{P_k \in \mathcal{T}_1} \frac{(-1)^P}{H(P)} P_k \in F_1 \otimes \mathcal{R}_{\lambda \setminus X, n}.$$

Proof. As P misses A for all $P_k \in \mathcal{T}_1$, $P|_A = \text{id}_A$, and thus

$$P(\sigma_k^A T) = Y_P \otimes \sigma_k^A T_P \text{ for all } 0 \leq k \leq w_b.$$

Then we have, mod $F_1 \otimes \mathcal{R}_{\lambda \setminus X, n}$,

$$\begin{aligned} \sum_{P_k \in \mathcal{T}_1} \frac{(-1)^P}{H(P)} P_k &= \sum_{P_0 \in \mathcal{T}_1} \sum_{k=0}^{w_b} \frac{(-1)^P}{H(P)} P(\sigma_k^A T) \\ &= \sum_{P_0 \in \mathcal{T}_1} \sum_{k=0}^{w_b} \frac{(-1)^P}{H(P)} \boxed{\alpha_1^P} \otimes \sigma_k^A T_P \\ &= \sum_{P_0 \in \mathcal{T}_1} \frac{1}{C_A} \frac{(-1)^P}{H(P)} \boxed{\alpha_1^P} \otimes G_A(T_P) \\ &= 0. \end{aligned}$$

□

Case (6.2.2). In this case we show that the sum over all paths that hit A and keep A in block b is in $F_1 \otimes \mathcal{R}_{\lambda \setminus X, n}$, i.e.

$$\sum_{P_k \in \mathcal{T}_2} \frac{(-1)^P}{H(P)} P_k \in F_1 \otimes \mathcal{R}_{\lambda \setminus X, n}.$$

Proof. For a 1-path P , let P^{-1} be the unique map of boxes

$$P^{-1} : \lambda \cup Y \rightarrow \lambda \cup Y$$

such that for all $x \in \lambda \cup Y$, $P^{-1}(P(x)) = x$. For all $k = 0, 1, \dots, w_b$, let

$$\tau_k^A := P \sigma_k^A P^{-1} \in S_{P(A)},$$

so that τ_k^A permutes $P(a_0)$ and $P(a_k)$ and is the identity otherwise. Extend τ_k^A to act on the entries of T_P . Then, mod $F_1 \otimes \mathcal{R}_{\lambda \setminus X, n}$,

$$\begin{aligned} \sum_{P_k \in \mathcal{T}_2} \frac{(-1)^P}{H(P)} P_k &= \sum_{P_0 \in \mathcal{T}_2} \sum_{k=0}^{w_b} \frac{(-1)^P}{H(P)} P(\sigma_k^A T) \\ &= \sum_{P_0 \in \mathcal{T}_2} \sum_{k=0}^{w_b} \frac{(-1)^P}{H(P)} P(\sigma_k^A P^{-1}(P(T))) \\ &= \sum_{P_0 \in \mathcal{T}_2} \sum_{k=0}^{w_b} \frac{(-1)^P}{H(P)} \boxed{\alpha_1^P} \otimes \tau_k^A T_P. \end{aligned}$$

Then as $P(A) \subset [b]$ and $|P(A)| = w_b + 1$, by the proof of Lemma 5.4 we have, mod $F_1 \otimes \mathcal{R}_{\lambda \setminus X, n}$,

$$\sum_{P_0 \in \mathcal{T}_2} \sum_{k=0}^{w_b} \frac{(-1)^P}{H(P)} \boxed{\alpha_1^P} \otimes \tau_k^A T_P = \sum_{P_0 \in \mathcal{T}_2} \frac{1}{C_A} \frac{(-1)^P}{H(P)} \boxed{\alpha_1^P} \otimes G_{P(A)} T_P = 0.$$

□

Remark. Notice that the proofs of Case (6.2.1) and Case (6.2.2) did not depend on removing a single box nor on A being contained in a single block, and so this will generalize to $m \geq 1$ for both options of a hook A .

Case (6.2.3). In this case we show that the sum over all paths that hit A and move the entry A_i above block b is in $F_1 \otimes \mathcal{R}_{\lambda \setminus X, n}$. We will assume that $b > b_1$, as the case $b \leq b_1$ can be treated similarly. It is enough to show that for each $i = 0, \dots, w_b$,

$$\sum_{P_k \in \mathcal{T}_3^i} \frac{(-1)^P}{H(P)} P_k \in F_1 \otimes \mathcal{R}_{\lambda \setminus X, n}.$$

We will show the case $i = 0$, with the cases $i = 1, \dots, w_b$ being similar.

Proof. For the rest of Case (6.2.3) let $\mathcal{T} := \mathcal{T}_3^0$ and, for any 1-path P , let $\tilde{h}^P := h^P - h_b^P$. Define the relation \sim on \mathcal{T} by

$$P_k \sim Q_j \iff Q \text{ is a } ([b](1), [b](i_0 + 1))\text{-path extension of } P.$$

It is clear that this defines an equivalence relation on \mathcal{T} , so that

$$\sum_{P_k \in \mathcal{T}} \frac{(-1)^P}{H(P)} P_k = \sum_{[P_k] \in \mathcal{T}/\sim} \sum_{Q_k \in [P_k]} \frac{(-1)^Q}{H(Q)} Q_k.$$

Pick $P_0 \in \mathcal{T}$ with $[b](i, 1) \in R^P$ for all $i = 1, \dots, i_0$, and let $[b_u](i_u, j_u) = P^{-1}([b](1, 1))$, with $u := T_{[b_u](i_u, j_u)}$.

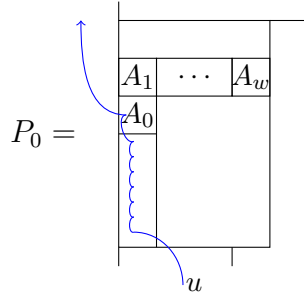

It is then enough to show that

$$\sum_{Q_k \in [P_0]} \frac{(-1)^{Q_k}}{H(Q_k)} Q_k \in F_1 \otimes \mathcal{R}_{\lambda \setminus X, n}.$$

In fact, as $\tilde{h}^Q = \tilde{h}^P$ and $H(Q) = H(P)$ for all $Q_k \in [P_0]$, it is enough to show that

$$\sum_{Q_k \in [P_0]} (-1)^{h_b^Q} Q_k \in F_1 \otimes \mathcal{R}_{\lambda \setminus X, n}.$$

Observe that $[P_0]$ can be written as the disjoint union

$$[P_0] = \bigsqcup_{i=1}^3 [P_0]_i,$$

where the $[P_0]_i$ are defined as follows.

The paths acting on $\sigma_0^A T$,

$$[P_0]_1 = \{Q_0 \in [P_0]\},$$

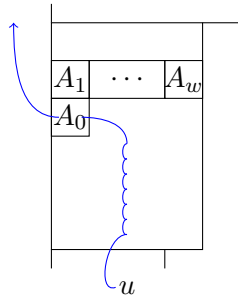

the paths acting on $\sigma_k^A T$, $k \neq 0$, that hit $a_0 = \sigma_k^a a_k$,

$$[P_0]_2 = \{Q_k \in [P_0] : k \neq 0, a_0 \in R^Q\},$$

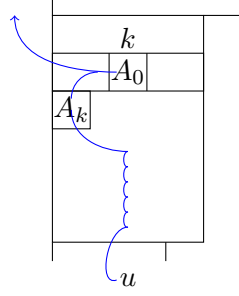

and the paths acting on $\sigma_k^A T$, $k \neq 0$, that miss $a_0 = \sigma_k^a a_k$,

$$[P_0]_3 = \{Q_k \in [P_0] : k \neq 0, a_0 \notin R^Q\},$$

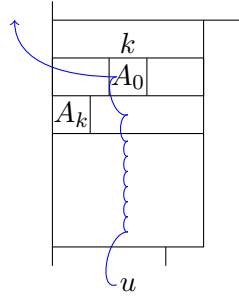

Let $T' \in \mathcal{F}_{\lambda \setminus X}$ be the unique tableau with $T' = T_P$ on $(\lambda \setminus X) \setminus [b]$ and $T' = T$ on $[b]$ except $T'_{a_0} = u$.

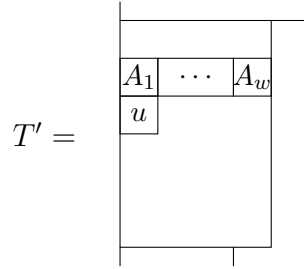

Then by Lemma 5.8 and applications of G_A , we have, mod $F_1 \otimes \mathcal{R}_{\lambda \setminus X, n}$,

$$\sum_{Q_0 \in [P_0]_1} (-1)^{h_b^Q} Q_0 = (-1)^{i_0 + i_0 - 1} \boxed{\alpha_1^P} \otimes T' = - \boxed{\alpha_1^P} \otimes T',$$

$$\sum_{Q_k \in [P_0]_2} (-1)^{h_b^Q} Q_k = (-1)^{i_0 + 1 + i_0 - 1} w_b \boxed{\alpha_1^P} \otimes T' = w_b \boxed{\alpha_1^P} \otimes T',$$

$$\sum_{Q_k \in [P_0]_3} (-1)^{h_b^Q} Q_k = (-1)^{i_0 + 1 + 1 + i_0 - 1} (w_b - 1) \boxed{\alpha_1^P} \otimes T' = -(w_b - 1) \boxed{\alpha_1^P} \otimes T'.$$

Now as

$$\sum_{Q_k \in [P_0]} (-1)^{h_b^Q} Q_k = \sum_{i=1}^3 \sum_{Q_k \in [P_0]_i} (-1)^{h_b^Q} Q_k,$$

we have, mod $F_1 \otimes \mathcal{R}_{\lambda \setminus X, n}$,

$$\sum_{Q_k \in [P_0]} (-1)^{h_b^Q} Q_k = (-1 + w_b - w_b + 1) \boxed{\alpha_1^P} \otimes T' = 0.$$

□

6.3. One Box Removal Preserves Garnirs for Hooks Contained in a Two Blocks.

We now show that Equation 6.1.1 holds for all hooks $A \subset [b] \cup [b+1]$ for some $1 \leq b \leq N-1$. For the rest of Section 6.3, fix $T \in \mathcal{T}_{\lambda, n}$ and

$$A = \{a_0 := [b](h_b, 1), a_1 := [b+1](1, 1), \dots, a_{w_{b+1}} := [b+1](1, w_{b+1})\} \subset T_0,$$

so that $A \subset [b] \cup [b+1]$. Denote the entries of A in T by $A_k = T_{a_k}$ for $k = 0, 1, \dots, w_{b+1}$. Then, by Lemma 5.4, mod $F_1 \otimes \mathcal{R}_{\lambda \setminus X, n}$ we have

$$\Phi_1(G_A(T)) = \sum_P \frac{(-1)^P}{H(P)} P \left(\sum_{\sigma \in S_A} \sigma T \right) = C \sum_P \sum_{k=0}^{w_{b+1}} \frac{(-1)^P}{H(P)} P(\sigma_k^A T),$$

where the sum is over all 1-paths P on λ removing X . The set of all $P_k := P(\sigma_k^A T)$ appearing in the image $\Phi_1(G_A(T))$ above is the union of the following disjoint sets.

The P_k s that miss A ,

$$(6.3.1) \quad \mathcal{T}_1 = \{P_k : R^P \cap A = \emptyset\}.$$

The P_k s that hit A and keep A in blocks b and $b+1$,

$$(6.3.2) \quad \mathcal{T}_2 = \{P_k : R^P \cap A \neq \emptyset, P(A) \leq [b+1]\}.$$

The P_k s that hit A and move the entry A_i above block $b+1$, including $P(\sigma_k^A A_i) \in Y$,

$$(6.3.3) \quad \mathcal{T}_3 = \bigsqcup_{i=0}^{w_{b+1}} \mathcal{T}_3^i \quad \text{where} \quad \mathcal{T}_3^i = \{P_k \in \mathcal{T}_3 : R^P \cap A \neq \emptyset, P(\sigma_k^A A_i) > [b+1]\}.$$

Then we have, mod $F_1 \otimes \mathcal{R}_{\lambda \setminus X, n}$,

$$\Phi_1(G_A(T)) = C \sum_P \sum_{k=0}^{w_{b+1}} \frac{(-1)^P}{H(P)} P(\sigma_k^A T) = C \sum_{j=1}^3 \sum_{P_k \in \mathcal{T}_j} \frac{(-1)^P}{H(P)} P_k.$$

We show that for each of the cases (6.3.1) - (6.3.3),

$$\sum_{P_k \in \mathcal{T}_j} \frac{(-1)^P}{H(P)} P_k \in F_1 \otimes \mathcal{R}_{\lambda \setminus X, n},$$

and hence Equation 6.1.1 holds for all hooks $A \subset [b] \cup [b+1]$.

Case (6.3.1) follows from the proof of Case (6.2.1) and Case (6.3.2) follows from the proof of Case (6.2.2). It remains to show Case (6.3.3).

Case (6.3.3). In this case we show that the sum over all paths that hit A and move the entry A_i above block $b+1$ is in $F_1 \otimes \mathcal{R}_{\lambda \setminus X, n}$. It is enough to show that for $i = 0, \dots, w_{b+1}$,

$$\sum_{P_k \in \mathcal{T}_3^i} \frac{(-1)^P}{H(P)} P_k \in F_1 \otimes \mathcal{R}_{\lambda \setminus X, n}.$$

We will show the case $i = 0$, with the cases $i = 1, \dots, w_{b+1}$ being similar.

Proof. Note that as we are considering paths that hit A in this case, we must have that $b \geq b_1 - 1$. We will consider the case $b = b_1 - 1$ (and hence $a_{w_{b+1}} = x_1$) and the case $b > b_1 - 1$ separately.

Subcase (6.3.3.1). We first show the case where $b = b_1 - 1$. We want to show that

$$\sum_{P_k \in \mathcal{T}_3^0} \frac{(-1)^P}{H(P)} P_k \in F_1 \otimes \mathcal{R}_{\lambda \setminus X, n}.$$

As $a_0 < x_1$, for all $P_k \in \mathcal{T}_3^0$ we must have $k \neq 0$. We can then write \mathcal{T}_3^0 as

$$\mathcal{T}_3^0 = \bigsqcup_{P_1 \in \mathcal{T}_3^0} \mathcal{T}_{P_1}$$

where

$$\mathcal{T}_{P_1} = \{Q_k \in \mathcal{T}_3^0 : Q \text{ is a } ([b+1](1), [b+1](1))\text{-path extension of } P\}.$$

It is then enough to show that for each $P_1 \in \mathcal{T}_3^0$,

$$\sum_{k=1}^{w_{b+1}} \frac{(-1)^P}{H(P)} P_1(\sigma_k^A T) \in F_1 \otimes \mathcal{R}_{\lambda \setminus X, n}.$$

For the rest of Subcase (6.3.3.1), fix a $P_1 \in \mathcal{T}_3^0$. We will show that

$$\sum_{k=1}^{w_{b+1}} P_1(\sigma_k^A T) \in F_1 \otimes \mathcal{R}_{\lambda \setminus X, n}.$$

Let $A' = A \setminus \{a_{w_{b+1}}\} \subset \lambda \setminus X$. As $|A'| = w_{b+1} > w_{b+1} - 1$, by the proof of Lemma 5.4 we have

$$\begin{aligned} \sum_{k=1}^{w_{b+1}} P_1(\sigma_k^A T) &= \sum_{k=1}^{w_{b+1}} \boxed{\alpha_1^P} \otimes \sigma_k^A(T_P) \\ &= \frac{1}{C_A} \boxed{\alpha_1^P} \otimes G_{A'}(T_P) \in F_1 \otimes \mathcal{R}_{\lambda \setminus X, n}. \end{aligned}$$

Subcase (6.3.3.2). We now show the case $b > b_1$. For the rest of Subcase (6.3.3.2), let $\mathcal{T} := \mathcal{T}_3^0$ and, for any 1-path P , define $\tilde{h}^P := h^P - h_b^P$ and

$$H(\tilde{P}) = \frac{H(P)}{H_b(P)H_{b+1}(P)}.$$

Define the relation \sim on \mathcal{T} by

$$P_k \sim Q_j \iff Q_j \text{ is a } ([b](1), [b+1](1))\text{-path extension of } P.$$

It is clear that this defines an equivalence relation on \mathcal{T} , so that

$$\sum_{P_k \in \mathcal{T}} \frac{(-1)^P}{H(P)} P_k = \sum_{[P_k] \in \mathcal{T}/\sim} \sum_{Q_k \in [P_k]} \frac{(-1)^Q}{H(Q)} Q_k.$$

Pick $P_0 \in \mathcal{T}$ with $[b](i, 1) \in R^P$ for all $i = 1, \dots, h_b$, and let $[b_u](i_u, j_u) = P^{-1}([b](1, 1))$ with $u := T_{[b_u](i_u, j_u)}$.

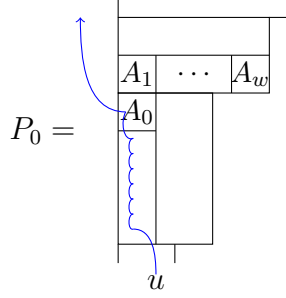

It is then enough to show that

$$\sum_{Q_k \in [P_0]} \frac{(-1)^{Q_k}}{H(Q_k)} Q_k \in F_1 \otimes \mathcal{R}_{\lambda \setminus X, n}.$$

In fact, as $\tilde{h}^Q = \tilde{h}^P$ and $H(\tilde{Q}) = H(\tilde{P})$ for all $Q_k \in [P_0]$, it is enough to show that

$$\sum_{Q_k \in [P_0]} \frac{(-1)^{h_b^Q}}{H_b(Q)H_{b+1}(Q)} Q_k \in F_1 \otimes \mathcal{R}_{\lambda \setminus X, n}.$$

Observe that $[P_0]$ can be written as the disjoint union

$$\mathcal{T} = \bigsqcup_{i=1}^6 [P_0]_i,$$

where the $[P_0]_i$ are defined as follows.

The paths acting on $\sigma_0^A T$,

$$[P_0]_1 = \{Q_0 \in [P_0]\},$$

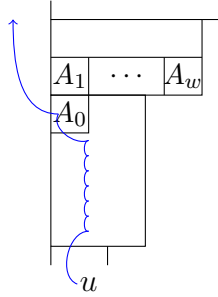

The paths acting on $\sigma_k^A T$, $k \neq 0$, that miss block b ,

$$[P_0]_2 = \{Q_k \in [P_0] : k \neq 0, R^Q \cap [b] = \emptyset\},$$

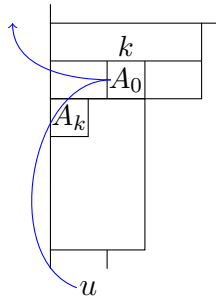

the paths acting on $\sigma_k^A T$, $k \neq 0$, that hit $a_0 = \sigma_k^a a_k$,

$$[P_0]_3 = \{Q_k \in [P_0] : k \neq 0, a_0 \in R^Q\},$$

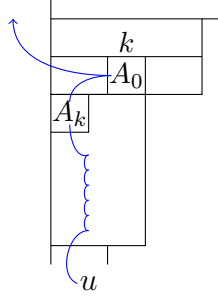

the paths acting on $\sigma_k^A T$, $k \neq 0$, that miss $a_0 = \sigma_k^a a_k$ but hit row $[b](h_b)$,

$$[P_0]_4 = \{Q_k \in [P_0] : k \neq 0, [b](h_b, j) \in R^Q \text{ for some } 2 \leq j \leq w_b\},$$

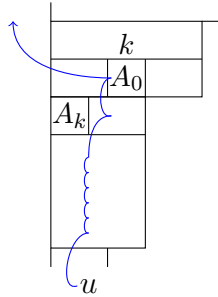

the paths acting on $\sigma_k^A T$, $k \neq 0$, that miss row $[b](h_b)$ and leave block b from an odd row,

$$[P_0]_5 = \{Q_k \in E^P : k \neq 0, Q([b](i, j)) = a_k \text{ for some } 1 \leq j \leq w_b, 1 \leq i < h_b, i \text{ odd}\}$$

and the paths acting on $\sigma_k^A T$, $k \neq 0$, that miss row $[b](h_b)$ and leave block b from an even row,

$$[P_0]_6 = \{Q_k \in E^P : k \neq 0, Q([b](i, j)) = a_k \text{ for some } 1 \leq j \leq w_b, 1 \leq i < h_b, i \text{ even}\}.$$

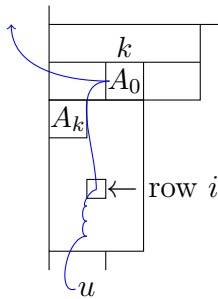

Let $T' \in \mathcal{F}_{\lambda \setminus X, n}$ be the unique tableau with $T' = T_P$ on $(\lambda \setminus X) \setminus ([b] \cup [b+1])$ and $T' = T$ on $[b] \cup [b+1]$ except $T'_{a_0} = u$,

and

$$\begin{aligned} \sum_{Q_k \in [P_0]_5} (-1)^{h_b^Q} Q_k &= \sum_{\substack{1 \leq i < h_b \\ i \text{ even}}} \frac{(-1)^{i+1+1+i-1+1}}{H(b)H(b+1)} \boxed{\alpha_1^P} \otimes T' \\ &= \sum_{\substack{1 \leq i < h_b \\ i \text{ even}}} \frac{1}{H(b)H(b+1)} \boxed{\alpha_1^P} \otimes T'. \end{aligned}$$

Then as $H(b+1) = H(b) + w_{b+1} - w_b + h_b$ and

$$\begin{aligned} \sum_{\substack{1 \leq i < h_b \\ i \text{ odd}}} \frac{1}{H(b)H(b+1)} \boxed{\alpha_1^P} \otimes T' + \sum_{\substack{1 \leq i < h_b \\ i \text{ even}}} \frac{1}{H(b)H(b+1)} \boxed{\alpha_1^P} \otimes T' \\ = \frac{h_b - 1}{H(b)H(b+1)} \boxed{\alpha_1^P} \otimes T' \end{aligned}$$

we get, mod $F_1 \otimes \mathcal{R}_{\lambda \setminus X, n}$,

$$\begin{aligned} \sum_{Q_k \in [P_0]} (-1)^{h_b^Q} Q_k &= \sum_{i=1, \dots, 6} \sum_{Q_k \in [P_0]_i} (-1)^{h_b^Q} Q_k \\ &= \frac{-H(b+1) + H(b) + w_{b+1} + 1 - w_b + h_b - 1}{H(b)H(b+1)} \boxed{\alpha_1^P} \otimes T' \\ &= 0. \end{aligned}$$

□

Thus Equation 6.1.1 holds for all hooks $A \subset [b] \cup [b+1]$, and so Theorem 6.1 holds.

7. SHOWING THE PIERI INCLUSION REMOVING MANY BOXES IS A $GL(V)$ -MAP

7.1. For all of section 7, fix a removal set $X = \{x_1 = [b_1](1, w_{b_1}), \dots, x_m = [b_m](i_m, w_{b_m})\} \subset \lambda$. Let

$$\Phi_m : \mathcal{F}_{\lambda, n} \rightarrow F_m \otimes \mathcal{F}_{\lambda \setminus X, n}$$

be as in 4.4.

Theorem. Φ_m is a $GL(V)$ -map, i.e. Φ_m descends to

$$\Phi_m : \mathbb{S}_\lambda(V) \rightarrow F_m \otimes \mathbb{S}_{\lambda \setminus X}(V)$$

and Φ_m is $GL(V)$ -equivariant.

As before, it is clear that Φ_m is $\mathfrak{gl}(V)$ -equivariant by construction. To prove Theorem 7.1, it remains to show that

$$\Phi_m(\mathcal{R}_{\lambda, n}) \subset F_m \otimes \mathcal{R}_{\lambda \setminus X, n}.$$

As before, it is clear that Φ_m preserves Property 2.5.1 as it is a sum over all m -paths, and hence we must show that Property 2.5.2 holds, i.e. for all $T \in \mathcal{F}_{\lambda, n}$ and all $A \subset T_0$ with $|A| > w_A$,

$$(7.1.1) \quad \Phi_m(G_A(T)) \in F_m \otimes \mathcal{R}_{\lambda \setminus X, n}.$$

We will show that Equation 7.1.1 holds for $m = 2$. The general case can then be shown using similar techniques since, by Theorem 5.1, it is enough to show that 7.1.1 holds only for

hooks, which consist of two rows and so can only intersect at most two orbits of any m -path. As before, there are two options for hooks in T_0 , which we consider separately. Note that as we are considering the case $m = 2$, we have the removal set

$$X = \{x_1 = [b_1](1, w_{b_1}), x_2 = [b_2](i_2, w_{b_2})\}.$$

7.2. Two Box Removal Preserves Garnirs for Hooks Contained in a Single Block.

We first show that Equation 7.1.1 holds when $m = 2$ for all hooks $A \subset [b]$, for some $1 \leq b \leq N$. For the rest of Section 7.2, fix $T \in \mathcal{F}_{\lambda, n}$ and let

$$A = \{a_0 := [b](i_0, 1), a_1 = [b](i_0 + 1, 1), \dots, a_{w_b} = [b](i_0 + 1, w_b)\} \subset T_0$$

with $1 \leq i_0 < h_b$, so that $A \subset [b]$. Denote the entries of A in T by $A_k = T_{a_k}$ for $k = 0, 1, \dots, w_b$. Then by Lemma 5.4, mod $F_2 \otimes \mathcal{R}_{\lambda \setminus X, n}$ we have

$$\begin{aligned} \Phi_2(G_A(T)) &= \sum_P \frac{(-1)^P}{H(P)} P \left(\sum_{\sigma \in S_A} \sigma T \right) \\ &= C \sum_P \sum_{k=0}^{w_b} \frac{(-1)^P}{H(P)} P(\sigma_k^A T), \end{aligned}$$

where the sum is over all 2-paths P on λ removing X . The set of all $P_k := P(\sigma_k^A T)$ appearing in the image $\Phi_2(G_A(T))$ above is the union of the following disjoint sets.

The P_k s that miss A ,

$$(7.2.1) \quad \mathcal{T}_1 = \{P_k : R^P \cap A = \emptyset\}.$$

The P_k s that hit A and keep A in block b ,

$$(7.2.2) \quad \mathcal{T}_2 = \{P_k : R^P \cap A \neq \emptyset, P(A) \subset [b]\}.$$

The P_k s that have exactly one orbit in $[b]$ and move A_i above $[b]$,

$$(7.2.3) \quad \begin{aligned} \mathcal{T}_3 &= \bigsqcup_{0 \leq i \leq w_b} \mathcal{T}_3^i, \text{ where} \\ \mathcal{T}_3^i &= \{P_k : \text{exactly one of } R_1, R_2 \text{ intersects } [b] \text{ and } P(\sigma_k A_i) > [b]\}. \end{aligned}$$

The P_k s that move A_i and A_j above $[b]$,

$$(7.2.4) \quad \begin{aligned} \mathcal{T}_4 &= \bigsqcup_{0 \leq i < j \leq w_b} \mathcal{T}_4^{i,j}, \text{ where} \\ \mathcal{T}_4^{i,j} &= \{P_k \in \mathcal{T}_4 : P(\sigma_k^A a_i) > [b] \text{ and } P(\sigma_k^A a_j) > [b]\}. \end{aligned}$$

The P_k s that move A_i and a box $z \in [b]$, with $z < A$, above $[b]$,

$$(7.2.5) \quad \begin{aligned} \mathcal{T}_5 &= \bigsqcup_{\substack{0 \leq i \leq w_b, z = [b](i_z, j_z), \\ 1 \leq i_z \leq i_0 - 1, 1 \leq j_z \leq w_b}} \mathcal{T}_5^{i,z}, \text{ where} \\ \mathcal{T}_5^{i,z} &= \{P_k \in \mathcal{T}_5 : P(\sigma_k^A a_i) > [b], P(z) > [b]\}. \end{aligned}$$

The P_k s that move A_i and a box $z \notin A$ in row i_0 above $[b]$,

$$(7.2.6) \quad \mathcal{T}_6 = \bigsqcup_{0 \leq i \leq w_b, 2 \leq j \leq w_b} \mathcal{T}_6^{i,j}, \text{ where}$$

$$\mathcal{T}_6^{i,j} = \{P_k \in \mathcal{T}_6 : P(\sigma_k^A a_i) > [b], P([b](i_0, j)) > [b]\}.$$

The P_k s that move A_i and a box in $[b]$ above A above $[b]$,

$$(7.2.7) \quad \mathcal{T}_7 = \bigsqcup_{\substack{0 \leq i \leq w_b \\ 1 \leq j \leq w_b}} \mathcal{T}_7^{i,j}, \text{ where}$$

$$\mathcal{T}_7^{i,j} = \{P_k \in \mathcal{T}_7 : P(\sigma_k^A A_i) > [b], [b](i_0 + 2, j) \in R^P\}.$$

Then we have, mod $F_2 \otimes \mathcal{R}_{\lambda \setminus X, n}$,

$$\Phi_2(G_A(T)) = C \sum_P \sum_{k=0}^{w_b} \frac{(-1)^P}{H(P)} P(\sigma_k^A T) = C \sum_{j=1, \dots, 7} \sum_{P_k \in \mathcal{T}_j} \frac{(-1)^P}{H(P)} P_k.$$

We show that for $j = 1, \dots, 7$,

$$\sum_{P_k \in \mathcal{T}_j} \frac{(-1)^P}{H(P)} P_k \in F_2 \otimes \mathcal{R}_{\lambda \setminus X, n},$$

and hence Equation 7.1.1 holds when $m = 2$ for all blocks $A \subset [b]$.

The proofs of Cases (7.2.1), (7.2.2), and (7.2.3) are similar to the proofs of Cases (6.2.1), (6.2.2), and (6.2.3), respectively. It remains to show the proofs of Cases (7.2.4) - (7.2.7). In each case we assume $b > b_1$, with the case $b = b_1$ being similar. We will also assume in each case that $A \cap X = \emptyset$, as if $A \cap X \neq \emptyset$ we may follow the proof of Subcase (6.3.3.1).

Case (7.2.4). In this case we show that the sum over all paths that move A_i and A_j above $[b]$ is in $F_2 \otimes \mathcal{R}_{\lambda \setminus X, n}$. Recall that

$$\mathcal{T}_4 = \bigsqcup_{0 \leq i < j \leq w_b} \mathcal{T}_4^{i,j},$$

where

$$\mathcal{T}_4^{i,j} = \{P_k \in \mathcal{T}_4 : P(\sigma_k^A a_i) > [b] \text{ and } P(\sigma_k^A a_j) > [b]\}.$$

It is enough to show that for $0 \leq i < j \leq w_b$,

$$\sum_{P_k \in \mathcal{T}_4^{i,j}} \frac{(-1)^P}{H(P)} P_k \in F_2 \otimes \mathcal{R}_{\lambda \setminus X, n}.$$

We will show the case $i = 0$ and $j = 1$, with rest being similar.

Proof. For the rest of Case (7.2.4) let $\mathcal{T} := \mathcal{T}_4^{0,1}$. Observe that for all $P_k \in \mathcal{T}$, either $k = 0$ or $k = 1$, as otherwise $\sigma_k^P A_0$ and $\sigma_k^A A_1$ are in the same row.

Next we will define for each $P_0 \in \mathcal{T}$ a unique $P'_1 \in \mathcal{T}$ that agrees with P except on $\{a_0, a_1\}$. The conditions on P'_1 will depend on whether or not P “removes” (i.e. maps to Y) either or both of a_0, a_1 . We want to construct P'_1 so that it sends A_0 and A_1 to the same place P does, but with the freedom to do so with either the orbit of x_1 or x_2 . For each $P_0 \in \mathcal{T}$, let $P'_1 \in \mathcal{T}$ such that $P' \equiv P$ except on $\{a_0, a_1\}$, and

- if $\{P(a_0), P(a_1)\} \cap Y = \emptyset$,

$$P'(\sigma_1^A a_0) = P(a_0) \text{ and } P'(\sigma_1^A(a_1)) = P(a_1).$$
- if $P(a_0) \in Y$ and $P(a_1) \notin Y$,

$$P'(\sigma_1^A a_0) \in Y \text{ and } P'(\sigma_1^A(a_1)) = P(a_1).$$
- if $P(a_0) \notin Y$ and $P(a_1) \in Y$,

$$P'(\sigma_1^A a_0) = P(a_0) \text{ and } P'(\sigma_1^A(a_1)) \in Y.$$
- if $\{P(a_0), P(a_1)\} = Y$,

$$\{P'(\sigma_1^A a_0), P'(\sigma_1^A(a_1))\} = Y.$$

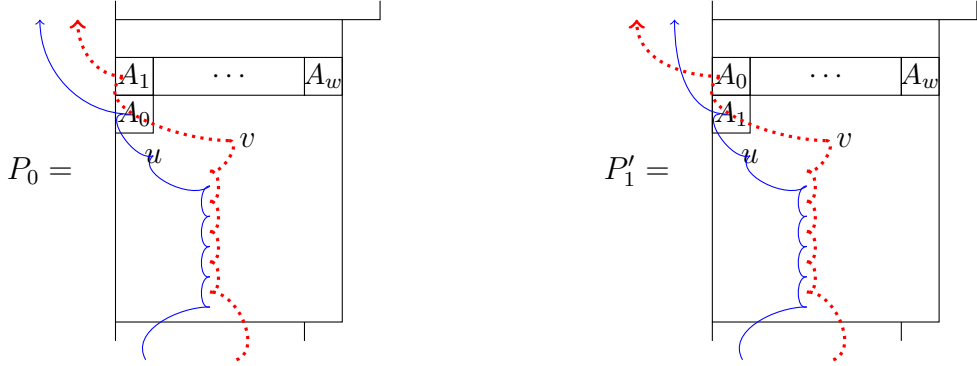

It is clear that for each $P_0 \in \mathcal{T}$ the choice of P'_1 is unique, and that all $Q_1 \in \mathcal{T}$ arise in such a way. Thus

$$\sum_{P_k \in \mathcal{T}} \frac{(-1)^P}{H(P)} P_k = \sum_{P_0 \in \mathcal{T}} \left(\frac{(-1)^P}{H(P)} P_0 + \frac{(-1)^{P'}}{H(P')} P'_1 \right)$$

As $(-1)^P = (-1)^{P'}$ and $H(P) = H(P')$, it is then enough to show that

$$\sum_{P_0 \in \mathcal{T}} P_0 + P'_1 \in F_2 \otimes \mathcal{R}_{\lambda \setminus X, n}.$$

We will in fact show that for each $P_0 \in \mathcal{T}$, $P_0 + P'_1 \in F_2 \otimes \mathcal{R}_{\lambda \setminus X, n}$. Pick P_0 and the corresponding $P'_1 \in \mathcal{T}$ and let $u = P^{-1}(a_0)$ and $v = P^{-1}(A_1)$. Let $T' \in \mathcal{F}_{\lambda \setminus X, n}$ be the unique tableau with $T' = T_P$ on $(\lambda \setminus X) \setminus \{[b](i_0), [b](i_0 + 1)\}$ and $T' = T$ on $\{[b](i_0), [b](i_0 + 1)\}$ except $T'_{a_0} = u$ and $T'_{a_1} = v$.

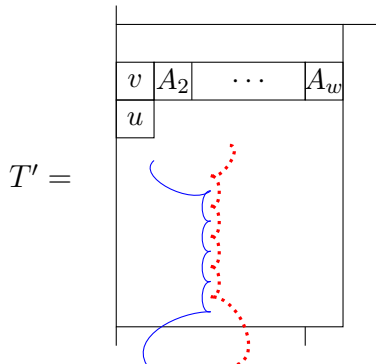

Then, mod $F_2 \otimes \mathcal{R}_{\lambda \setminus X, n}$ we have

$$P_0 + P'_1 = \left(\begin{array}{c|c} \alpha_2^P & \alpha_1^P \\ \hline \alpha_1^P & \alpha_2^P \end{array} \right) \otimes T' = 0.$$

□

Case (7.2.5). In this case we show that the sum over all paths that move A_i and a box $z \in [b]$, with $z < A$, above $[b]$ is in $F_2 \otimes \mathcal{R}_{\lambda \setminus X, n}$. Recall that

$$\mathcal{T}_5 = \bigsqcup_{\substack{0 \leq i \leq w_b, z = [b](i_z, j_z), \\ 1 \leq i_z \leq i_0 - 1, 1 \leq j_z \leq w_b}} \mathcal{T}_5^{i, z},$$

where

$$\mathcal{T}_5^{i, z} = \{P_k \in \mathcal{T}_5 : P(\sigma_k^A a_i) > [b], P(z) > [b]\}.$$

It is enough to show that

$$\sum_{P_k \in \mathcal{T}_5^{0, z}} \frac{(-1)^P}{H(P)} P_k \in F_2 \otimes \mathcal{R}_{\lambda \setminus X, n},$$

for some $z = [b](i_z, j_z)$ a fixed box with $Z = T_z$, $1 \leq i_z \leq i_0 - 1$ odd, and $1 \leq j_z \leq w_b$, with the other cases being similar.

Proof. For the rest of Case (7.2.5) let $\mathcal{T} := \mathcal{T}_5^{0, z}$ and, for any 2-path P , let $\tilde{h}^P := h^P - h_b^P$. Define the relation \sim on \mathcal{T} by

$$P_k \sim Q_j \iff Q \text{ is a } ([b](1), [b](i_0 + 1))\text{-path extension of } P \\ \text{and if } P(u) \in [b](1) \text{ for some box } u < [b], \text{ then } Q(u) \in [b](1).$$

It is clear that this defines an equivalence relation on \mathcal{T} , so that

$$\sum_{P_k \in \mathcal{T}_5^{0, z}} \frac{(-1)^P}{H(P)} P_k = \sum_{[P_k] \in \mathcal{T}/\sim} \sum_{Q_k \in [P_k]} \frac{(-1)^Q}{H(Q)} Q_k.$$

Pick $P_0 \in \mathcal{T}$ with $[b](i, 1) \in R^P$ for all $1 \leq i \neq i_z \leq i_0$, and let $[b_u](i_u, j_u) = P^{-1}([b](1, 1))$ and $[b_v](i_v, j_v) = P^{-1}([b](2, 1))$ with $u = T_{[b_u](i_u, j_u)}$ and $v = T_{[b_v](i_v, j_v)}$.

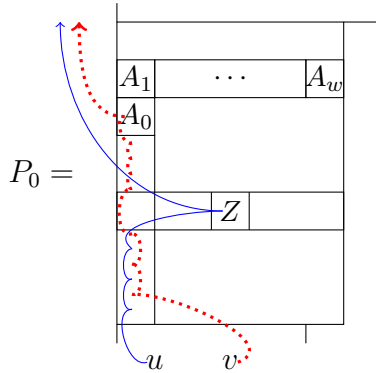

It is then enough to show that

$$\sum_{Q_k \in [P_0]} \frac{(-1)^Q}{H(Q)} Q_k \in F_2 \otimes \mathcal{R}_{\lambda \setminus X, n}.$$

In fact, as $\tilde{h}^Q = \tilde{h}^P$ and $H(Q) = H(P)$ for all $Q_k \in [P_0]$, it is enough to show that

$$\sum_{Q_k \in [P_0]} (-1)^{h_b^Q} Q_k \in F_2 \otimes \mathcal{R}_{\lambda \setminus X, n}.$$

Observe that $[P_0]$ can be written as the disjoint union

$$[P_0] = \bigsqcup_{i=1}^3 [P_0]_i,$$

where the $[P_0]_i$ are defined as follows.

The paths acting on $\sigma_0^A T$,

$$[P_0]_1 = \{Q_0 \in [P_0]\},$$

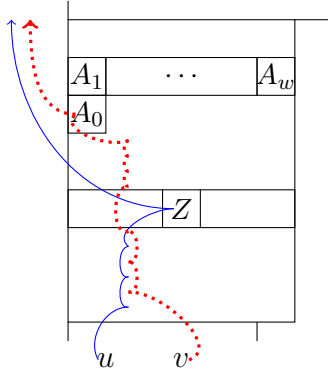

the paths acting on $\sigma_k^A T$, $k \neq 0$, that hit $a_0 = \sigma_k^A a_k$,

$$[P_0]_2 = \{Q_k \in [P_0] : k \neq 0, a_0 \in R^Q\},$$

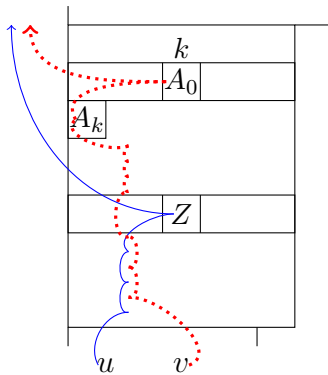

and the paths acting on $\sigma_k^A T$, $k \neq 0$, that miss $a_0 = \sigma_k^A a_k$,

$$[P_0]_3 = \{Q_k \in [P_0] : k \neq 0, a_0 \notin R^Q\}.$$

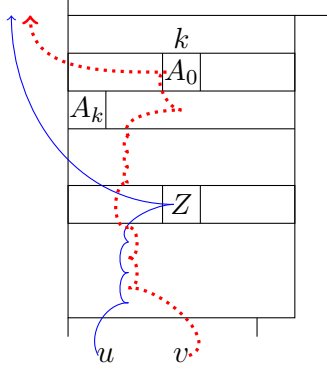

Let $T' \in \mathcal{F}_{\lambda \setminus X}$ be the unique tableau with $T' = T_P$ on $(\lambda \setminus X) \setminus [b]$ and $T' = T$ on $[b]$ except $T'_z = v$ and $T'_{a_0} = u$.

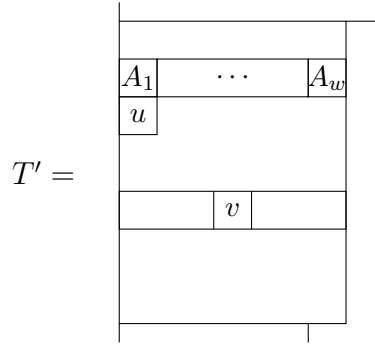

Then by Corollary 5.9 and applications of G_A we have, mod $F_2 \otimes \mathcal{R}_{\lambda \setminus X, n}$,

$$\begin{aligned} \sum_{Q_k \in [P_0]_1} (-1)^{h_b^Q} Q_k &= (-1)^{i_0 + i_0 - 2 + i_z - 2} \frac{\alpha_2^P}{\alpha_1^P} \otimes T' = - \frac{\alpha_2^P}{\alpha_1^P} \otimes T', \\ \sum_{Q_k \in [P_0]_2} (-1)^{h_b^Q} Q_k &= (-1)^{i_0 + 1 + i_0 - 2 + i_z - 2} (w_b) \frac{\alpha_2^P}{\alpha_1^P} \otimes T' = w_b \frac{\alpha_2^P}{\alpha_1^P} \otimes T', \\ \sum_{Q_k \in [P_0]_3} (-1)^{h_b^Q} Q_k &= (-1)^{i_0 + 1 + 1 + i_0 - 2 + i_z - 2} (w_b - 1) \frac{\alpha_2^P}{\alpha_1^P} \otimes T' = -w_b + 1 \frac{\alpha_2^P}{\alpha_1^P} \otimes T' \end{aligned}$$

So, mod $F_2 \otimes \mathcal{R}_{\lambda \setminus X, n}$ we have

$$\sum_{Q_k \in [P_0]} (-1)^{h_b^Q} Q_k = (-1 + w_b - w_b + 1) \frac{\alpha_2^P}{\alpha_1^P} \otimes T' = 0 \otimes T'.$$

□

Case (7.2.6). In this case we show that the sum over all paths that move A_i and a box $z \notin A$ in row i_0 above $[b]$ is in $F_2 \otimes \mathcal{R}_{\lambda \setminus X, n}$. Recall that

$$\mathcal{T}_6 = \bigsqcup_{0 \leq i \leq w_b, 2 \leq j \leq w_b} \mathcal{T}_6^{i,j},$$

where

$$\mathcal{T}_6^{i,j} = \{P_k \in \mathcal{T}_6 : P(\sigma_k^A a_i) > [b], P([b](i_0, j)) > [b]\}.$$

It is enough to show that

$$\sum_{P_k \in \mathcal{T}_6^{0,2}} \frac{(-1)^P}{H(P)} P_k \in F_2 \otimes \mathcal{R}_{\lambda \setminus X, n},$$

with the other cases being similar.

Proof. Let $z := [b](i_0, 2)$ and $Z := T_z$, and observe that $\mathcal{T}_6^{0,2}$ is the union of the following disjoint sets:

$$\begin{aligned} \mathcal{T}_6^{0,2,1} &= \{P_k \in \mathcal{T}_6^{0,2} : P(\sigma_k^A a_0), P(z) \notin Y\}, \\ \mathcal{T}_6^{0,2,2} &= \{P_k \in \mathcal{T}_6^{0,2} : P(\sigma_k^A a_0) \in Y, P(z) \notin Y\}, \\ \mathcal{T}_6^{0,2,3} &= \{P_k \in \mathcal{T}_6^{0,2} : P(z) \in Y, P(\sigma_k^A a_0) \notin Y\}, \text{ and} \\ \mathcal{T}_6^{0,2,4} &= \{P_k \in \mathcal{T}_6^{0,2} : P(\sigma_k^A a_0), P(z) \in Y\}. \end{aligned}$$

So it is enough to show that for $1 \leq i \leq 4$,

$$\sum_{P_k \in \mathcal{T}_6^{0,2,i}} \frac{(-1)^P}{H(P)} P_k \in F_2 \otimes \mathcal{R}_{\lambda \setminus X, n}.$$

Define the relation \sim^i on $\mathcal{T}_6^{0,2,i}$, for $1 \leq i \leq 4$, as follows.

- Define \sim^1 on $\mathcal{T}_6^{0,2,1}$ by

$$P_k \sim^1 Q_j \iff Q \text{ is a } ([b](1), [b](i_0 + 1))\text{-path extension of } P, \\ Q(\sigma_j^A A_0) = P(\sigma_k^A A_0), \text{ and } Q(Z) = P(Z).$$

- Define \sim^2 on $\mathcal{T}_6^{0,2,2}$ by

$$P_k \sim^2 Q_j \iff Q \text{ is a } ([b](1), [b](i_0 + 1))\text{-path extension of } P, \\ \text{and } Q(Z) = P(Z).$$

- Define \sim^3 on $\mathcal{T}_6^{0,2,3}$ by

$$P_k \sim^3 Q_j \iff Q \text{ is a } ([b](1), [b](i_0 + 1))\text{-path extension of } P, \\ \text{and } Q(\sigma_j^A A_0) = P(\sigma_k^A A_0).$$

- Define \sim^4 on $\mathcal{T}_6^{0,2,4}$ by

$$P_k \sim^4 Q_j \iff Q \text{ is a } ([b](1), [b](i_0 + 1))\text{-path extension of } P.$$

It is clear that, for $1 \leq i \leq 4$, \sim^i an equivalence relation on $\mathcal{T}_6^{0,2,i}$, so that

$$\sum_{P_k \in \mathcal{T}_6^{0,2,i}} \frac{(-1)^P}{H(P)} P_k = \sum_{[P_k] \in \mathcal{T}_6^{0,2,i} / \sim^i} \sum_{Q_k \in [P_k]} \frac{(-1)^Q}{H(Q)} Q_k.$$

Thus it is enough to show that for $1 \leq i \leq 4$,

$$\sum_{[P_k] \in \mathcal{T}_6^{0,2,i} / \sim^i} \sum_{Q_k \in [P_k]} \frac{(-1)^Q}{H(Q)} Q_k \in F_2 \otimes \mathcal{R}_{\lambda \setminus X, n}.$$

We will show the case $i = 1$, with the rest being similar. For the rest of Case (7.2.6), let $\mathcal{T} := \mathcal{T}_6^{0,2,1}$. For $l = 1, 2$, let \mathcal{T}_{x_l} be the set of all Q_k in \mathcal{T} such that the orbit of x_l intersects the first row in $[b]$,

$$\mathcal{T}_{x_l} = \{P_k \in \mathcal{T} : R_l^P \cap [b](1) \neq \emptyset\}.$$

As $a_0 = [b](i_0, 1)$ and $z = [b](i_0, 2)$ are in the same row, it must be that $1 \leq k \leq w_b$ for all $P_k \in \mathcal{T}$. Pick $P_1 \in \mathcal{T}$ with $[b](i, 1) \in R^P$ for all $i = 1, \dots, i_0 - 1$, and let $[b_u](i_u, j_u) = P^{-1}([b](1, 1))$ and $[b_v](i_v, j_v) = P^{-1}([b](2, 1))$ with $u = T_{[b_u](i_u, j_u)}$ and $v = T_{[b_v](i_v, j_v)}$.

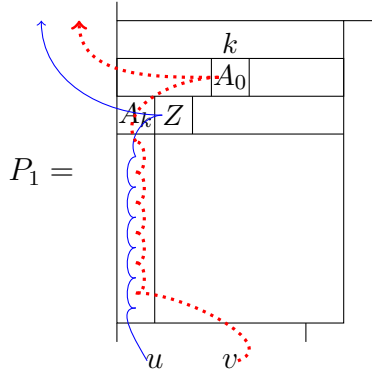

It is then enough to show that

$$\sum_{Q_k \in [P_1]} \frac{(-1)^Q}{H(Q)} Q_k \in F_2 \otimes \mathcal{R}_{\lambda \setminus X, n}.$$

In fact, as $(-1)^P = (-1)^Q$ and $H(Q) = H(P)$ for all $Q_k \in [P_1]$, it is enough to show that

$$\sum_{Q_k \in [P_1]} Q_k \in F_2 \otimes \mathcal{R}_{\lambda \setminus X, n}.$$

Assume, without loss of generality, that $P_1 \in \mathcal{T}_{x_1}$, and let $[P_1]_1 = [P_1] \cap \mathcal{T}_{x_1}$ and $[P_1]_2 = [P_1] \cap \mathcal{T}_{x_2}$, so that

$$[P_1] = [P_1]_{x_1} \bigsqcup [P_1]_{x_2}.$$

See Figure 7.2.1.

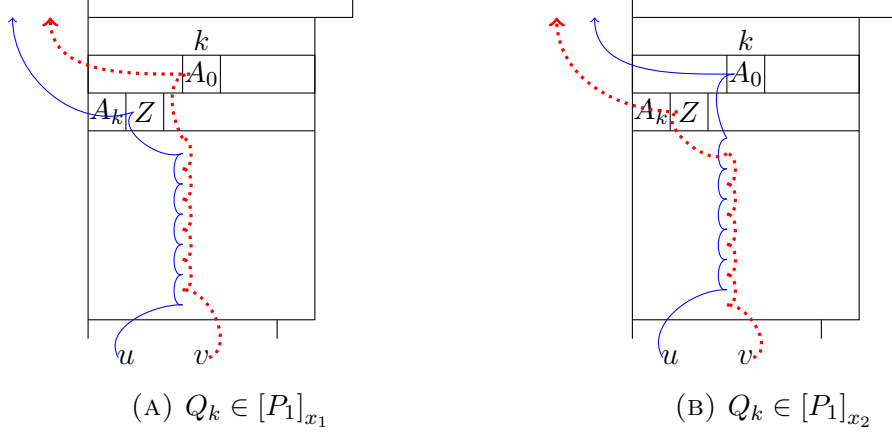
FIGURE 7.2.1. Pictured the case when i_0 is odd.

Let $T' \in \mathcal{F}_{\lambda \setminus X}$ be the unique tableau with $T' = T_P$ on $(\lambda \setminus X) \setminus [b]$ and $T' = T$ on $[b]$ except $T'_{a_0} = u$ and $T'_z = v$.

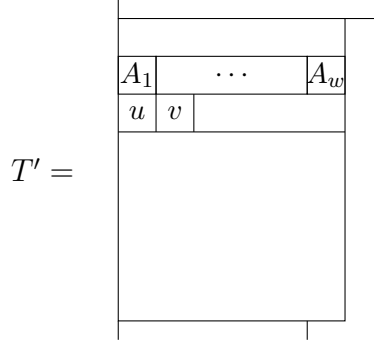

By the proof of Lemma 5.8, the result of Corollary 5.9 still holds when moving u and v to boxes in the same row, which we have here after applying G_A . This gives, mod $F_2 \otimes \mathcal{R}_{\lambda \setminus X, n}$,

$$\begin{aligned}
\sum_{Q_k \in [P_1]} Q_k &= \sum_{Q_k \in [P_1]_{x_1}} Q_k + \sum_{Q_k \in [P_1]_{x_2}} Q_k \\
&= (-1)^{i_0+1+1+2(i_0-1)} \frac{\alpha_2^P}{\alpha_1^P} \otimes T' + (-1)^{i_0+1+1+2(i_0-1)} \frac{\alpha_1^P}{\alpha_2^P} \otimes T' \\
&= 0.
\end{aligned}$$

□

Case (7.2.7). In this section we show that the sum over all paths that move A_i and a box in $[b]$ above A above $[b]$ is in $F_2 \otimes \mathcal{R}_{\lambda \setminus X, n}$. Note that for any such path, there must be a box $[b](i_0 + 2, j) \in R^P$. Recall that

$$\mathcal{T}_7 = \bigsqcup_{\substack{0 \leq i \leq w_b \\ 1 \leq j \leq w_b}} \mathcal{T}_7^{i,j},$$

where

$$\mathcal{T}_7^{i,j} = \{P_k \in \mathcal{T}_7 : P(\sigma_k^A A_i) > [b], [b](i_0 + 2, j) \in R^P\}.$$

For $l = 1, 2$, let \mathcal{T}_{7,x_l} be the set of all P_k in \mathcal{T}_7 such that the orbit of x_l intersects the first row in $[b]$,

$$\mathcal{T}_{7,x_l} = \{P_k \in \mathcal{T}_7 : R_l^P \cap [b](1) \neq \emptyset\}.$$

Then

$$\mathcal{T}_7 = \mathcal{T}_{7,x_1} \bigsqcup \mathcal{T}_{7,x_2},$$

and letting

$$\mathcal{T}_{7,x_l}^{i,j} = \mathcal{T}_{7,x_l} \cap \mathcal{T}_7^{i,j},$$

we have

$$\mathcal{T}_7 = \bigsqcup_{\substack{l=1,2, \\ 0 \leq i \leq w_b \\ 1 \leq j \leq w_b}} \mathcal{T}_{7,x_l}^{i,j}.$$

It is then enough to show that

$$\sum_{P_k \in \mathcal{T}_{7,x_1}^{0,1}} \frac{(-1)^P}{H(P)} P_k \in F_2 \otimes \mathcal{R}_{\lambda \setminus X, n},$$

with $z = [b](i_0 + 2, 1)$ and $Z = T_z$, with the other cases being similar.

Proof. For the rest of Case (7.2.7) let \mathcal{S} be the set of all $P_k \in \mathcal{T}_{7,x_1}^{0,1}$ that hit a box other than a_0 in row $[b](i_0)$,

$$\mathcal{S} := \{P_k \in \mathcal{T}_{7,x_1}^{0,1} : [b](i_0, j) \in R^P \text{ for some } 2 \leq j \leq w_b\},$$

and let $\mathcal{T} := \mathcal{T}_{7,x_1}^{0,1} \setminus \mathcal{S}$. One can show

$$\sum_{P_k \in \mathcal{S}} \frac{(-1)^P}{H(P)} P_k \in F_2 \otimes \mathcal{R}_{\lambda \setminus X, n}$$

by following the proof of Case (7.2.6). It remains to show

$$\sum_{P_k \in \mathcal{T}} \frac{(-1)^P}{H(P)} P_k \in F_2 \otimes \mathcal{R}_{\lambda \setminus X, n}.$$

Observe that \mathcal{T} is the union of the following disjoint sets:

$$\mathcal{T}^1 = \{P_k \in \mathcal{T} : P(\sigma_k^A A_0), P(Z) \notin Y\},$$

$$\mathcal{T}^2 = \{P_k \in \mathcal{T} : P(\sigma_k^A A_0) \in Y, P(Z) \notin Y\},$$

$$\mathcal{T}^3 = \{P_k \in \mathcal{T} : P(Z) \in Y, P(\sigma_k^A A_0) \notin Y\}, \text{ and}$$

$$\mathcal{T}^4 = \{P_k \in \mathcal{T} : P(\sigma_k^A A_0), P(Z) \in Y\}.$$

So, it is enough to show that for $1 \leq i \leq 4$,

$$\sum_{P_k \in \mathcal{T}^i} \frac{(-1)^P}{H(P)} P_k \in F_2 \otimes \mathcal{R}_{\lambda \setminus X, n}.$$

Define the relation \sim^i on \mathcal{T}^i , for $1 \leq i \leq 4$, as follows.

- Define \sim^1 on \mathcal{T}^1 by

$$P_k \sim^1 Q_j \iff Q \text{ is a } ([b](i_0), [b](i_0 + 1))\text{-path extension of } P, \\ Q(\sigma_j^A A_0) = P(\sigma_k^A A_0), \text{ and } Q(Z) = P(Z).$$

- Define \sim^2 on \mathcal{T}^2 by

$$P_k \sim^2 Q_j \iff Q \text{ is a } ([b](i_0), [b](i_0 + 1))\text{-path extension of } P, \\ \text{and } Q(Z) = P(Z).$$

- Define \sim^3 on \mathcal{T}^3 by

$$P_k \sim^3 Q_j \iff Q \text{ is a } ([b](i_0), [b](i_0 + 1))\text{-path extension of } P, \\ \text{and } Q(\sigma_j^A A_0) = P(\sigma_k^A A_0).$$

- Define \sim^4 on \mathcal{T}^4 by

$$P_k \sim^4 Q_j \iff Q \text{ is a } ([b](i_0), [b](i_0 + 1))\text{-path extension of } P.$$

It is clear that for $1 \leq i \leq 4$, \sim^i an equivalence relation on \mathcal{T}^i , so that

$$\sum_{P_k \in \mathcal{T}^i} \frac{(-1)^P}{H(P)} P_k = \sum_{[P_k] \in \mathcal{T}^i / \sim^i} \sum_{Q_k \in [P_k]} \frac{(-1)^Q}{H(Q)} Q_k.$$

Thus it is enough to show that for $1 \leq i \leq 4$,

$$\sum_{[P_k] \in \mathcal{T}^i / \sim^i} \sum_{Q_k \in [P_k]} \frac{(-1)^Q}{H(Q)} Q_k \in F_2 \otimes \mathcal{R}_{\lambda \setminus X, n}.$$

We will show the case $i = 1$, with the other cases being similar. Pick $P_0 \in \mathcal{T}^1$ with $A_1 \in R^P$ and let $u := P^{-1}(A_0)$ and $v := P^{-1}(A_1)$. (Note that in the example below, the image of Z can be in $[b]$.)

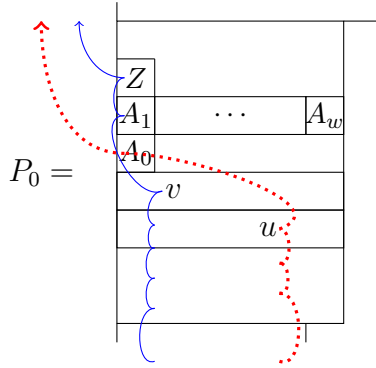

It is then enough to show that

$$\sum_{Q_k \in [P_0]} \frac{(-1)^Q}{H(Q)} Q_k \in F_2 \otimes \mathcal{R}_{\lambda \setminus X, n},$$

with the other cases being similar. In fact, as $(-1)^P = (-1)^Q$ and $H(Q) = H(P)$ for all $Q_k \in [P_0]$, it is enough to show that

$$\sum_{Q_k \in [P_0]} Q_k \in F_2 \otimes \mathcal{R}_{\lambda \setminus X, n}.$$

Let $[P_0]_1 = \{Q_0 \in [P_0]\}$ and $[P_0]_2 = \{Q_k \in [P_0] : 1 \leq k \leq w_b\}$, so that

$$[P_0] = [P_0]_1 \sqcup [P_0]_2.$$

(Note that in the examples below, the image of Z can be in $[b]$.)

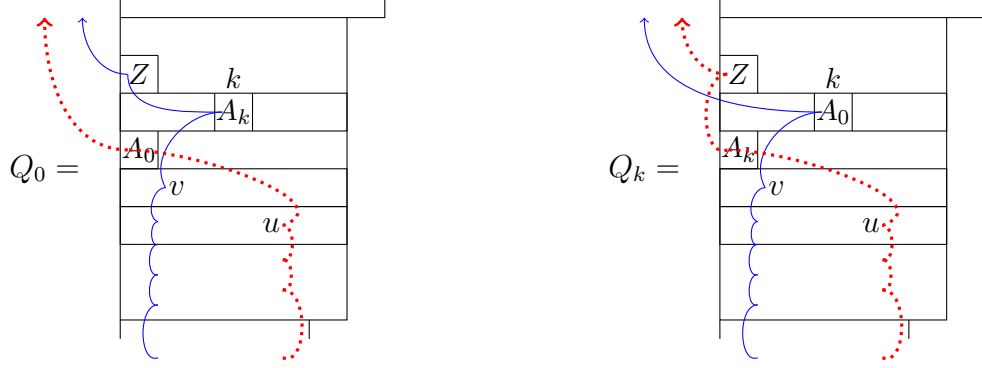

Let $T' \in \mathcal{F}_{\lambda \setminus X}$ be the unique tableau with $T' = T_P$ on $(\lambda \setminus X) \setminus \{([b](i_0), [b](i_0 + 2))\}$ and $T' = T$ on $([b](i_0), [b](i_0 + 2))$ except $T'_z = v$ and $T'_{a_0} = u$.

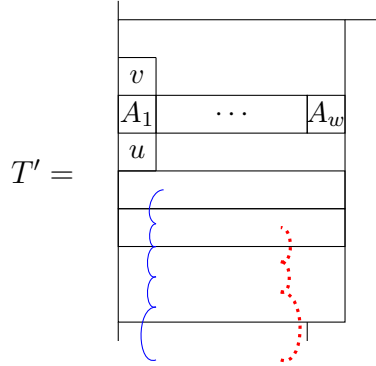

Then by Corollary 5.9 and applications of G_A we have, mod $F_2 \otimes \mathcal{R}_{\lambda \setminus X, n}$

$$\sum_{Q_k \in E^P} Q_k = \sum_{Q_k \in [P_0]_1} Q_k + \sum_{Q_k \in [P_0]_2} Q_k = - \begin{bmatrix} \alpha_2^P \\ \alpha_1^P \end{bmatrix} \otimes T' - \begin{bmatrix} \alpha_1^P \\ \alpha_2^P \end{bmatrix} \otimes T' = 0.$$

□

7.3. Two Box Removal Preserves Garnirs for Hooks Contained in Two Blocks.

We now show that Equation 7.1.1 holds when $m = 2$ for all hooks $A \subset [b] \cup [b + 1]$ for some $1 \leq b \leq N - 1$. For the rest of Section 7.3, fix $T \in \mathcal{F}_{\lambda, n}$ and let

$$A = \{a_0 := [b](h_b, 1), a_1 := [b + 1](1, 1), \dots, a_{w_{b+1}} := [b + 1](1, w_{b+1})\} \subset T_0$$

so that $A \subset [b] \cup [b+1]$. Denote the entries of A in T by $A_k = T_{a_k}$ for $k = 0, 1, \dots, w_{b+1}$. Then by Lemma 5.4, mod $F_2 \otimes \mathcal{R}_{\lambda \setminus X, n}$ we have

$$\begin{aligned} \Phi_2(G_A(T)) &= \sum_P \frac{(-1)^P}{H(P)} P \left(\sum_{\sigma \in S_A} \sigma T \right) \\ &= C \sum_P \sum_{k=0}^{w_{b+1}} \frac{(-1)^P}{H(P)} P(\sigma_k^A T), \end{aligned}$$

where the sum is over all 2-paths P on λ removing X . The set of all $P_k := P(\sigma_k^A T)$ appearing in the image $\Phi_2(G_A(T))$ above is the union of the following disjoint sets.

The P_k s that miss A ,

$$(7.3.1) \quad \mathcal{T}_1 = \{P_k : R^P \cap A = \emptyset\}.$$

The P_k s that hit A and keep A in $[b] \cup [b+1]$,

$$(7.3.2) \quad \mathcal{T}_2 = \{P_k : R^P \cap A \neq \emptyset, P(A) \leq [b+1]\}.$$

The P_k s that have exactly one orbit in $[b] \cup [b+1]$ and move A_i above $[b+1]$,

$$(7.3.3) \quad \begin{aligned} \mathcal{T}_3 &= \bigsqcup_{i=0}^{w_{b+1}} \mathcal{T}_3^i, \text{ where} \\ \mathcal{T}_3^i &= \{P_k \in \mathcal{T}_3 : \text{exactly one of } R_{x_1}^P, R_{x_2}^P, \text{ intersect } [b] \cup [b+1] \\ &\quad \text{and } P(\sigma_k^A A_i) > [b+1]\}. \end{aligned}$$

The P_k s that move A_i and A_j above $[b+1]$,

$$(7.3.4) \quad \begin{aligned} \mathcal{T}_4 &= \bigsqcup_{0 \leq i < j \leq w_{b+1}} \mathcal{T}_4^{i,j}, \text{ where} \\ \mathcal{T}_4^{i,j} &= \{P_k : P(\sigma_k^A A_i) > [b+1], \text{ and } P(\sigma_k^A A_j) > [b+1]\}. \end{aligned}$$

The P_k s that move A_i and a box Z in $[b]$ below A above $[b+1]$,

$$(7.3.5) \quad \begin{aligned} \mathcal{T}_5 &= \bigsqcup_{\substack{0 \leq i \leq w_{b+1} \\ z=[b](j,k), 1 \leq j < h_b \text{ and } 1 \leq k \leq w_b}} \mathcal{T}_5^{i,z}, \text{ where} \\ \mathcal{T}_5^{i,z} &= \{P_k : P(\sigma_k^A A_i) > [b+1], P(z) > [b+1]\}. \end{aligned}$$

The P_k s that move A_i and a box other than a_0 in row $[b](h_b)$ above $[b+1]$,

$$(7.3.6) \quad \begin{aligned} \mathcal{T}_6 &= \bigsqcup_{0 \leq i \leq w_{b+1}, 2 \leq j \leq w_b} \mathcal{T}_6^{i,j}, \text{ where} \\ \mathcal{T}_6^{i,j} &= \{P_k : P(\sigma_k^A A_i) > [b+1], P([b](h_b, j)) > [b+1]\}. \end{aligned}$$

The P_k s that move A_i and a box above A above $[b+1]$,

$$(7.3.7) \quad \begin{aligned} \mathcal{T}_7 &= \bigsqcup_{\substack{0 \leq i \leq w_{b+1} \\ 1 \leq j \leq w_{b+1}}} \mathcal{T}_7^{i,j}, \text{ where} \\ \mathcal{T}_7^{i,j} &= \{P_k : P(\sigma_k^A A_i) > [b+1], P([b+1](2, j)) \in R^P\}. \end{aligned}$$

Then we have

$$\begin{aligned}\Phi_2(G_A(T)) &= C \sum_P \sum_{k=0}^{w_{b+1}} \frac{(-1)^P}{H(P)} P(\sigma_k^A T) \pmod{F_2 \otimes \mathcal{R}_{\lambda \setminus X, n}} \\ &= C \sum_{j=1, \dots, 7} \sum_{P_k \in \mathcal{T}_j} \frac{(-1)^P}{H(P)} P_k \pmod{F_2 \otimes \mathcal{R}_{\lambda \setminus X, n}}.\end{aligned}$$

We show that for $1 \leq j \leq 7$,

$$\sum_{P_k \in \mathcal{T}_j} \frac{(-1)^P}{H(P)} P_k \in F_2 \otimes \mathcal{R}_{\lambda \setminus X, n},$$

and hence Equation 7.1.1 holds when $m = 2$ for all blocks $A \subset [b] \cup [b+1]$.

The proofs of Case (7.3.1) and Case (7.3.2) are similar to the proofs of Case (6.2.1) and Case (6.2.2), respectively. The proof of Case (7.3.3) is similar to the proof of Case (6.3.3), and goes through by observing that using the definition of $H(P)$ for a 2-path only adds and subtracts 1 in some of the terms. The proofs of Case (7.3.4) and Case (7.3.7) are similar to the proofs of Case (7.2.4) and Case (7.2.7), respectively, as these proofs did not depend on $H(P)$. It remains to show Case (7.3.5) and Case (7.3.6). In both cases we assume $b > b_1$ and $A \cap X = \emptyset$, as if $b = b_1$ or if $A \cap X \neq \emptyset$ we may follow the proof of Subcase (6.3.3.1).

Case (7.3.5). In this case we show that the sum over all paths that move A_i and a box Z in $[b]$ below A above $[b+1]$ is in $F_2 \otimes \mathcal{R}_{\lambda \setminus X, n}$. Recall that

$$\mathcal{T}_5 = \bigsqcup_{\substack{0 \leq i \leq w_{b+1} \\ z = [b](j, k), 1 \leq j < h_b \text{ and } 1 \leq k \leq w_b}} \mathcal{T}_5^{i, z},$$

where

$$\mathcal{T}_5^{i, z} = \{P_k : P(\sigma_k^A A_i) > [b+1], P(z) > [b+1]\}.$$

It is enough to show that

$$\sum_{P_k \in \mathcal{T}_5^{0, z}} \frac{(-1)^P}{H(P)} P_k \in F_2 \otimes \mathcal{R}_{\lambda \setminus X, n},$$

where $z = [b](i_z, j_z)$ is a fixed box with $1 \leq i_z \leq h_b - 1$ odd, $1 \leq j_z \leq w_{b+1}$, and $Z = T_z$, with the other cases being similar.

Proof. For the rest of Case (7.3.5), let $\mathcal{T} := \mathcal{T}_5^{0, z}$ and, for any 2-path P on λ removing X , let $\tilde{h}^P = h^P - h_b^P - h_{b+1}^P$ and $H(\tilde{P}) = \frac{H(P)}{H_b(P)H_{b+1}(P)}$. Observe that \mathcal{T} is the union of the following disjoint sets:

$$\begin{aligned}\mathcal{T}^1 &= \{P_k \in \mathcal{T} : P(\sigma_k^A a_0), P(z) \notin Y\}, \\ \mathcal{T}^2 &= \{P_k \in \mathcal{T} : P(\sigma_k^A a_0) \in Y, P(z) \notin Y\}, \\ \mathcal{T}^3 &= \{P_k \in \mathcal{T} : P(z) \in Y, P(\sigma_k^A a_0) \notin Y\}, \text{ and} \\ \mathcal{T}^4 &= \{P_k \in \mathcal{T} : P(\sigma_k^A a_0), P(z) \in Y\}.\end{aligned}$$

So it is enough to show that for $1 \leq i \leq 4$,

$$\sum_{P_k \in \mathcal{T}^i} \frac{(-1)^P}{H(P)} P_k \in F_2 \otimes \mathcal{R}_{\lambda \setminus X, n}.$$

Define the relation \sim^i on \mathcal{T}^i , for $1 \leq i \leq 4$, as follows. Define \sim^1 on \mathcal{T}^1 by

$$P_k \sim^1 Q_j \iff Q \text{ is a } ([b](1), [b+1](1))\text{-path extension of } P, \\ Q(\sigma_j^A a_0) = P(\sigma_k^A a_0), \text{ and } Q(z) = P(z).$$

Define \sim^2 on \mathcal{T}^2 by

$$P_k \sim Q_j \iff Q \text{ is a } ([b](1), [b+1](1))\text{-path extension of } P, \\ \text{and } Q(z) = P(z).$$

Define \sim^3 on \mathcal{T}^3 by

$$P_k \sim^3 Q_j \iff Q \text{ is a } ([b](1), [b+1](1))\text{-path extension of } P, \\ \text{and } Q(\sigma_j^A a_0) = P(\sigma_k^A a_0).$$

Define \sim^4 on \mathcal{T}^4 by

$$P_k \sim^4 Q_j \iff Q \text{ is a } ([b](1), [b+1](1))\text{-path extension of } P.$$

It is clear that for $1 \leq i \leq 4$, \sim^i an equivalence relation on \mathcal{T}^i , so that

$$\sum_{P_k \in \mathcal{T}^i} \frac{(-1)^P}{H(P)} P_k = \sum_{[P_k] \in \mathcal{T}^i / \sim^i} \sum_{Q_k \in [P_k]} \frac{(-1)^Q}{H(Q)} Q_k.$$

Thus it is enough to show that, for $1 \leq i \leq 4$,

$$\sum_{[P_k] \in \mathcal{T}^i / \sim^i} \sum_{Q_k \in [P_k]} \frac{(-1)^Q}{H(Q)} Q_k \in F_2 \otimes \mathcal{R}_{\lambda \setminus X, n}.$$

We will show the case $i = 1$, with the rest being similar. Pick $P_0 \in \mathcal{T}^1$ with $[b](i, 1) \in R^P$ for all $1 \leq i \neq i_z \leq h_b$, and let $[b_u](i_u, j_u) = P^{-1}([b](1, 1))$ and $[b_v](i_v, j_v) = P^{-1}([b](2, 1))$ with $u = T_{[b_u](i_u, j_u)}$ and $v = T_{[b_v](i_v, j_v)}$.

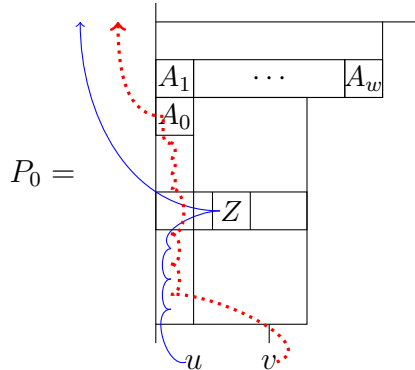

It is then enough to show that

$$\sum_{Q_k \in [P_0]} \frac{(-1)^Q}{H(Q)} Q_k \in F_2 \otimes \mathcal{R}_{\lambda \setminus X, n}.$$

In fact, as $\tilde{h}^Q = \tilde{h}^P$ and $H(\tilde{Q}) = H(\tilde{P})$ for all $Q_k \in [P_0]$, it is enough to show that

$$\sum_{Q_k \in [P_0]} \frac{(-1)^{h_b^Q + h_{b+1}^Q}}{H_b^Q H_{b+1}^Q} Q_k \in F_2 \otimes \mathcal{R}_{\lambda \setminus X, n}.$$

Observe that $[P_0]$ can be written as the disjoint union

$$[P_0] = \bigsqcup_{i=1}^7 [P_0]_i,$$

where the $[P_0]_i$ are defined as follows.

The paths acting on $\sigma_0 T$,

$$[P_0]_1 = \{Q_0 \in [P_0]\},$$

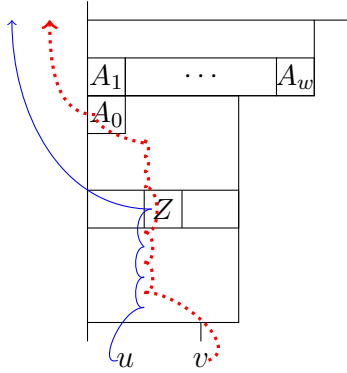

the paths acting on $\sigma_k^A T$, $k \neq 0$, that hit $\sigma_k^A a_k$,

$$[P_0]_2 = \{Q_k \in [P_0] : k \neq 0, a_0 \in R^Q\},$$

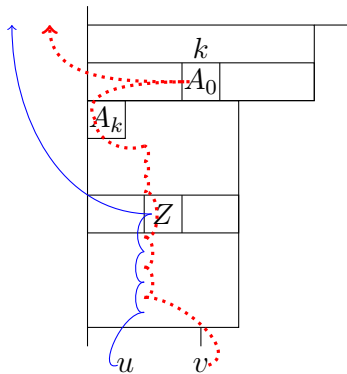

the paths acting on $\sigma_k^A T$, $k \neq 0$, that miss $\sigma_k^A a_k$ but hit row $[b](h_b)$,

$$[P_0]_3 = \{Q_k \in [P_0] : k \neq 0, [b](h_b, j) \in R^Q \text{ for some } 2 \leq j \leq w_b\},$$

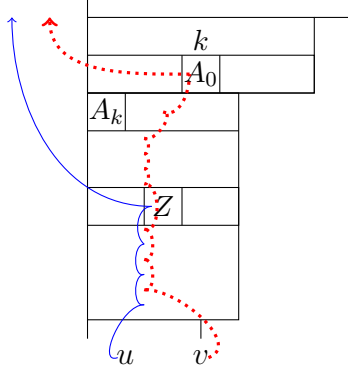

the paths acting on $\sigma_k^A T$, $k \neq 0$, that miss row $[b](h_b)$ with R_2^P leaving $[b]$ in a row above Z ,

$$[P_0]_4 = \{Q_k \in [P_0] : k \neq 0, Q([b](i, j)) = a_k \text{ for some } i_z < i < h_b, 1 \leq j \leq w_b\},$$

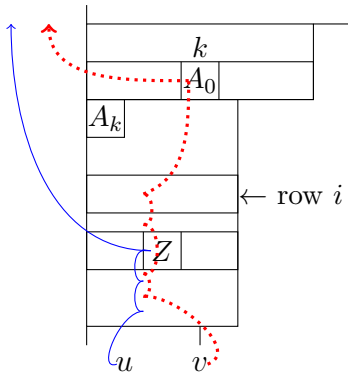

the paths acting on $\sigma_k^A T$, $k \neq 0$, that miss row $[b](h_b)$ with R_2^P leaving $[b]$ in an even row below Z ,

$$[P_0]_5 = \{Q_k \in [P_0] : k \neq 0, Q([b](i, j)) = \sigma_k^A a_0 \text{ for some } 1 \leq i < i_z, i \text{ even}, 1 \leq k \leq w_b\},$$

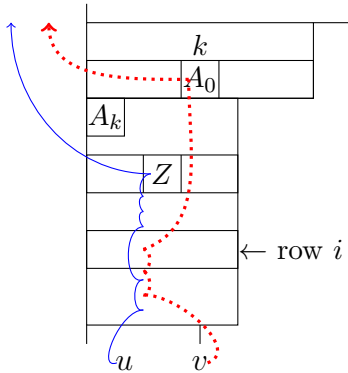

the paths acting on $\sigma_k^A T$, $k \neq 0$, that miss row $[b](h_b)$ with R_2^P leaving $[b]$ in an odd row below Z ,

$$[P_0]_6 = \{Q_k \in [P_0] : k \neq 0, Q([b](j, l)) = \sigma_k^A a_0 \text{ for some } 1 \leq i < i_z, i \text{ odd}, 1 \leq k \leq w_b\},$$

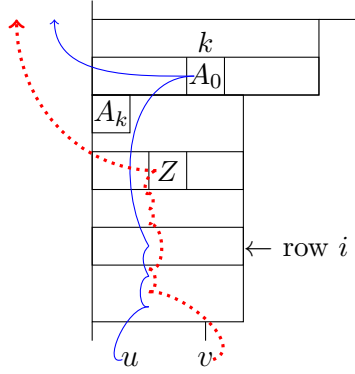

and the paths acting on $\sigma_k^A T$, $k \neq 0$, with R_2^P missing $[b]$,

$$[P_0]_7 = \{Q_k \in [P_0] : k \neq 0, R_2^P \cap [b] = \emptyset\}.$$

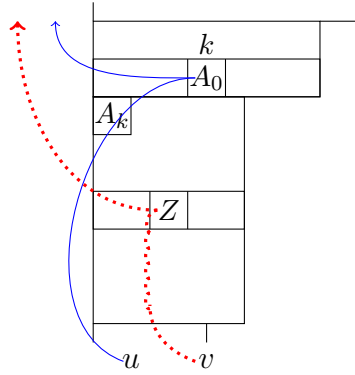

Let $T' \in \mathcal{F}_{\lambda \setminus X}$ be the unique tableau with $T' = T_P$ on $(\lambda \setminus X) \setminus [b] \cup [b+1]$ and $T' = T$ on $[b] \cup [b+1]$ except $T'_z = u$ and $T'_{a_0} = v$.

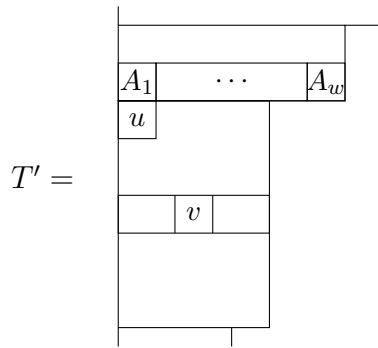

Then by Corollary 5.9 and applications of G_A we have, mod $F_2 \otimes \mathcal{R}_{\lambda \setminus X, n}$,

$$\begin{aligned} \sum_{Q_k \in [P_0]_1} \frac{(-1)^{h_b^Q + h_{b+1}^Q}}{H_b^Q H_{b+1}^Q} Q_k &= \frac{(-1)^{h_b + h_b - 2 + i_z - 2}}{H(b)(H(b) - 1)} \begin{array}{|c|} \hline A_0 \\ \hline Z \\ \hline \end{array} \otimes T' \\ &= \frac{-H(b+1) + 1}{H(b)(H(b) - 1)(H(b+1) - 1)} \begin{array}{|c|} \hline A_0 \\ \hline Z \\ \hline \end{array} \otimes T', \end{aligned}$$

$$\begin{aligned} \sum_{Q_k \in [P_0]_2} \frac{(-1)^{h_b^Q + h_{b+1}^Q}}{H_b^Q H_{b+1}^Q} Q_k &= \frac{(-1)^{h_b+1+h_b-2+i_z-2}(w_{b+1})}{H(b)(H(b)-1)(H(b+1)-1)} \boxed{\frac{A_0}{Z}} \otimes T' \\ &= \frac{w_{b+1}}{H(b)(H(b)-1)(H(b+1)-1)} \boxed{\frac{A_0}{Z}} \otimes T' \end{aligned}$$

$$\begin{aligned} \sum_{Q_k \in [P_0]_3} \frac{(-1)^{h_b^Q + h_{b+1}^Q}}{H_b^Q H_{b+1}^Q} Q_k &= \frac{(-1)^{h_b+1+1+h_b-2+i_z-2}(w_b-1)}{H(b)(H(b)-1)(H(b+1)-1)} \boxed{\frac{A_0}{Z}} \otimes T' \\ &= \frac{-w_b+1}{H(b)(H(b)-1)(H(b+1)-1)} \boxed{\frac{A_0}{Z}} \otimes T' \end{aligned}$$

$$\begin{aligned} \sum_{Q_k \in [P_0]_4} \frac{(-1)^{h_b^Q + h_{b+1}^Q}}{H_b^Q H_{b+1}^Q} Q_k &= \sum_{i=i_z+1}^{h_b-1} \frac{(-1)^{i+1+1+i-2+i_z-2+1}}{H(b)(H(b)-1)(H(b+1)-1)} \boxed{\frac{A_0}{Z}} \otimes T' \\ &= \frac{h_b-1-i_z}{H(b)(H(b)-1)(H(b+1)-1)} \boxed{\frac{A_0}{Z}} \otimes T' \end{aligned}$$

$$\begin{aligned} \sum_{Q_k \in [P_0]_5} \frac{(-1)^{h_b^Q + h_{b+1}^Q}}{H_b^Q H_{b+1}^Q} Q_k &= \sum_{\substack{1 \leq i < i_z, \\ i \text{ even}}} \frac{(-1)^{i_z+1+1+i_z-2+i-2+1}}{H(b)(H(b)-1)(H(b+1)-1)} \boxed{\frac{A_0}{Z}} \otimes T' \\ &= \sum_{\substack{1 \leq i < i_z, \\ i \text{ even}}} \frac{(-1)^{i+1}}{H(b)(H(b)-1)(H(b+1)-1)} \boxed{\frac{A_0}{Z}} \otimes T' \end{aligned}$$

$$\begin{aligned} \sum_{Q_k \in [P_0]_6} \frac{(-1)^{h_b^Q + h_{b+1}^Q}}{H_b^Q H_{b+1}^Q} Q_k &= \sum_{\substack{1 \leq i < i_z, \\ i \text{ odd}}} \frac{(-1)^{i_z+1+1+i_z-2+i-2+1}}{H(b)(H(b)-1)(H(b+1)-1)} \boxed{\frac{Z}{A_0}} \otimes T' \\ &= \sum_{\substack{1 \leq i < i_z, \\ i \text{ odd}}} \frac{(-1)^{i+2}}{H(b)(H(b)-1)(H(b+1)-1)} \boxed{\frac{A_0}{Z}} \otimes T' \end{aligned}$$

$$\begin{aligned} \sum_{Q_k \in [P_0]_7} \frac{(-1)^{h_b^Q + h_{b+1}^Q}}{H_b^Q H_{b+1}^Q} Q_k &= \frac{(-1)^{i_z+1+1+i_z-1}}{(H(b)-1)(H(b+1)-1)} \boxed{\frac{Z}{A_0}} \otimes T' \\ &= \frac{H(b)}{H(b)(H(b)-1)(H(b+1)-1)} \boxed{\frac{A_0}{Z}} \otimes T' \end{aligned}$$

Then as $H(b+1) = H(b) + w_{b+1} - w_b + h_b$ and

$$\begin{aligned} & \sum_{\substack{1 \leq i < i_z, \\ i \text{ even}}} \frac{(-1)^i}{H(b)(H(b)-1)(H(b+1)-1)} \boxed{\frac{A_0}{Z}} \otimes T' \\ & + \sum_{\substack{1 \leq i < i_z, \\ i \text{ odd}}} \frac{(-1)^{i+1}}{H(b)(H(b)-1)(H(b+1)-1)} \boxed{\frac{A_0}{Z}} \otimes T' \\ & = \frac{i_z - 1}{H(b)(H(b)-1)(H(b+1)-1)} \boxed{\frac{A_0}{Z}} \otimes T' \end{aligned}$$

we get, mod $F_2 \otimes \mathcal{R}_{\lambda \setminus X, n}$

$$\begin{aligned} & \sum_{Q_k \in [P_0]} \frac{(-1)^{h_b^Q + h_{b+1}^Q}}{H_b^Q H_{b+1}^Q} Q_k = \sum_{i=1, \dots, 7} \sum_{Q_k \in [P_0]_i} \frac{(-1)^{h_b^Q + h_{b+1}^Q}}{H_b^Q H_{b+1}^Q} Q_k \\ & = \frac{-H(b+1) + 1 + w_{b+1} - w_b + 1 + h_b - 1 - i_z - +i_z - 1 + H(b)}{H(b)(H(b)-1)(H(b+1)-1)} \boxed{\frac{A_0}{Z}} \otimes T' \\ & = 0 \end{aligned}$$

□

Case (7.3.6). In this case we show that the sum over all paths that move A_i and a box other than a_0 in row $[b](h_b)$ above $[b+1]$ is in $F_2 \otimes \mathcal{R}_{\lambda \setminus X, n}$. Recall that

$$\mathcal{T}_6 = \bigsqcup_{0 \leq i \leq w_{b+1}, 2 \leq j \leq w_b} \mathcal{T}_6^{i,j},$$

where

$$\mathcal{T}_6^{i,j} = \{P_k : P(\sigma_k^A A_i) > [b+1], P([b](h_b, j)) > [b+1]\}.$$

It is enough to show that

$$\sum_{P_k \in \mathcal{T}_6^{0,2}} \frac{(-1)^P}{H(P)} P_k \in F_2 \otimes \mathcal{R}_{\lambda \setminus X, n},$$

with the other cases being similar.

Proof. For the rest of Case (7.3.6), let $z = [b](h_b, 2)$ and $Z = T_z$, and observe that $\mathcal{T}_6^{0,2}$ is the union of the following disjoint sets.

$$\begin{aligned} \mathcal{T}_6^{0,2,1} &= \{P_k \in \mathcal{T}_6^{0,2} : P(\sigma_k^A a_0), P(z) \notin Y\}, \\ \mathcal{T}_6^{0,2,2} &= \{P_k \in \mathcal{T}_6^{0,2} : P(\sigma_k^A a_0) \in Y, P(z) \notin Y\}, \\ \mathcal{T}_6^{0,2,3} &= \{P_k \in \mathcal{T}_6^{0,2} : P(z) \in Y, P(\sigma_k^A a_0) \notin Y\}, \text{ and} \\ \mathcal{T}_6^{0,2,4} &= \{P_k \in \mathcal{T}_6^{0,2} : P(\sigma_k^A a_0), P(z) \in Y\}. \end{aligned}$$

So it is enough to show that for $1 \leq i \leq 4$,

$$\sum_{P_k \in \mathcal{T}_6^{0,2,i}} \frac{(-1)^P}{H(P)} P_k \in F_2 \otimes \mathcal{R}_{\lambda \setminus X, n}.$$

Now define the relation \sim^i on $\mathcal{T}_6^{0,2,i}$, for $1 \leq i \leq 4$, as follows.

- Define \sim^1 on $\mathcal{T}_6^{0,2,1}$ by

$$\begin{aligned} P_k \sim^1 Q_j &\iff Q \text{ is a } ([b](1), [b+1](1))\text{-path extension of } P, \\ &Q(\sigma_j^A A_0) = P(\sigma_k^A A_0), \text{ and } Q(Z) = P(Z), \text{ and} \\ &Q^{-1}(\sigma_j^A A_0) \text{ and } P^{-1}(\sigma_k^A A_0) \text{ are in the same row.} \end{aligned}$$

- Define \sim^2 on $\mathcal{T}_6^{0,2,2}$ by

$$\begin{aligned} P_k \sim^2 Q_j &\iff Q \text{ is a } ([b](1), [b+1](1))\text{-path extension of } P, \\ &Q(Z) = P(Z), \text{ and} \\ &Q^{-1}(\sigma_j^A A_0) \text{ and } P^{-1}(\sigma_k^A A_0) \text{ are in the same row.} \end{aligned}$$

- Define \sim^3 on $\mathcal{T}_6^{0,2,3}$ by

$$\begin{aligned} P_k \sim^3 Q_j &\iff Q \text{ is a } ([b](1), [b+1](1))\text{-path extension of } P, \\ &Q(\sigma_j^A A_0) = P(\sigma_k^A A_0), \text{ and} \\ &Q^{-1}(\sigma_j^A A_0) \text{ and } P^{-1}(\sigma_k^A A_0) \text{ are in the same row.} \end{aligned}$$

- Define \sim^4 on $\mathcal{T}_6^{0,2,4}$ by

$$\begin{aligned} P_k \sim^4 Q_j &\iff Q \text{ is a } ([b](1), [b+1](1))\text{-path extension of } P, \text{ and} \\ &Q^{-1}(\sigma_j^A A_0) \text{ and } P^{-1}(\sigma_k^A A_0) \text{ are in the same row.} \end{aligned}$$

It is clear that for $1 \leq i \leq 4$, \sim^i an equivalence relation on $\mathcal{T}_6^{0,2,i}$, so that

$$\sum_{P_k \in \mathcal{T}_6^{0,2,i}} \frac{(-1)^P}{H(P)} P_k = \sum_{[P_k] \in \mathcal{T}_6^{0,2,i} / \sim^i} \sum_{Q_k \in [P_k]} \frac{(-1)^Q}{H(Q)} Q_k.$$

Thus it is enough to show that for $1 \leq i \leq 4$,

$$\sum_{[P_k] \in \mathcal{T}_6^{0,2,i} / \sim^i} \sum_{Q_k \in [P_k]} \frac{(-1)^Q}{H(Q)} Q_k \in F_2 \otimes \mathcal{R}_{\lambda \setminus X, n}.$$

We will show the case $i = 1$, with the rest being similar. For the rest of Case (7.3.6), let $\mathcal{T} := \mathcal{T}_6^{0,2,1}$.

For $l = 1, 2$, let \mathcal{T}_{x_l} be the set of all Q_k in \mathcal{T} such that the orbit of x_l intersects the first row in $[b]$,

$$\mathcal{T}_{x_l} = \{P_k \in \mathcal{T} : R_l^P \cap [b](1) \neq \emptyset\}.$$

Note that as $a_0 = [b](h_b, 1)$ is in the same row as $z = [b](h_b, 2)$, it must be that $1 \leq k \leq w_b$ for all $P_k \in \mathcal{T}$. Pick $P_1 \in \mathcal{T}$ with $[b](i, 1) \in R^P$ for all $i = 1, \dots, h_b - 1$, and $P^{-1}(\sigma_1 A_0) \in [b](i)$ with i odd, and let $[b_u](i_u, j_u) = P^{-1}([b](1, 1))$ and $[b_v](i_v, j_v) = P^{-1}([b](2, 1))$ with $u = T_{[b_u](i_u, j_u)}$ and $v = T_{[b_v](i_v, j_v)}$.

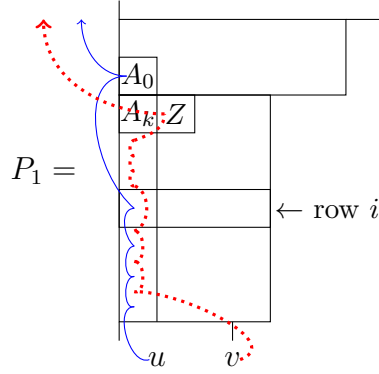

It is then enough to show that

$$\sum_{Q_k \in [P_1]} \frac{(-1)^Q}{H(Q)} Q_k \in F_2 \otimes \mathcal{R}_{\lambda \setminus X, n},$$

with the other cases being similar. In fact, as $(-1)^P = (-1)^Q$ and $H(Q) = H(P)$ for all $Q_k \in [P_1]$, it is enough to show that

$$\sum_{Q_k \in [P_1]} Q_k \in F_2 \otimes \mathcal{R}_{\lambda \setminus X, n}.$$

Without loss of generality, assume $P_1 \in \mathcal{T}_{x_1}$ and let $[P_1]_{x_1} = [P_1] \cap \mathcal{T}_{x_1}$ and $[P_1]_{x_2} = [P_1] \cap \mathcal{T}_{x_2}$, so that

$$[P_1] = [P_1]_{x_1} \sqcup [P_1]_{x_2}.$$

See Figure 7.3.1.

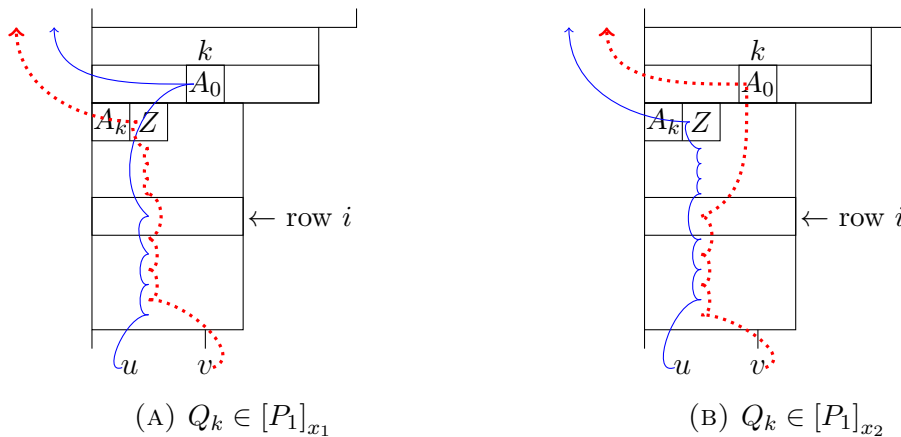
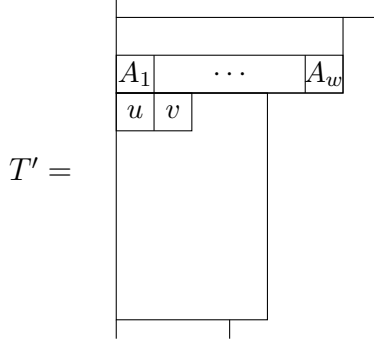

FIGURE 7.3.1

Let $T' \in \mathcal{F}_{\lambda \setminus X}$ be the unique tableau with $T' = T_P$ on $(\lambda \setminus X) \setminus ([b] \cup [b+1])$ and $T' = T$ on $[b] \cup [b+1]$ except $T'_z = v$ and $T'_{a_0} = u$.



As in the calculations for the proof of Case 7.2.6, by the proof of Lemma 5.8, the result of Corollary 5.9 still holds when moving u and v to boxes in the same row, which we have here after applying G_A . This gives, mod $F_2 \otimes \mathcal{R}_{\lambda \setminus X, n}$,

$$\begin{aligned} \sum_{Q_k \in [P_1]} Q_k &= \sum_{Q_k \in [P_1]_{x_1}} Q_k + \sum_{Q_k \in [P_1]_{x_2}} Q_k \\ &= (-1)^{h_b+1+1h_b-2+i-2+1} \frac{\alpha_2^P}{\alpha_1^P} \otimes T' + (-1)^{h_b+1+1h_b-2+i-2+1} \frac{\alpha_1^P}{\alpha_2^P} \otimes T' \\ &= 0 \otimes T'. \end{aligned}$$

□

Thus Equation 7.1.1 holds for all hooks $A \subset [b] \cup [b + 1]$, and so Theorem 7.1 holds for $m = 2$.

8. RELATING PIERI INCLUSION DESCRIPTIONS

8.1. In this section we show that our description of the Pieri inclusion removing one box is the negative of that given by Olver. We then show that iterating our description of the Pieri inclusion removing one box is equal to our description of the Pieri inclusion removing many boxes. Finally, we show that our description of the Pieri inclusion removing many boxes also describes the symmetric case.

Theorem. For $\tilde{\Phi}_1$ and Φ_1 as above,

$$\Phi_1 = -\tilde{\Phi}_1.$$

Proof. Let $T_\lambda \in \mathcal{T}_{\lambda, n}$ and $T_{\lambda \setminus X} \in \mathcal{T}_{\lambda \setminus X, n}$ be the diagrams corresponding to highest weight vectors as in Section 2.3. Then, in the image of T_λ , the coefficient of

$$\alpha \otimes T_{\lambda \setminus X}$$

where

$$\alpha = \sum_{i=b_1}^N h_i$$

is readily seen to be $-w_{b_1}$ in the image of Φ and w_{b_1} in the image of $\tilde{\Phi}_1$. By uniqueness of the Pieri inclusion up to scalar multiple (Schur's Lemma), we then have

$$\Phi = -\tilde{\Phi}_1.$$

□

8.2. Given removal set $X = \{x_1 = [b_1](1, w_{b_1}), \dots, x_m = [b_m](i_m, w_{b_m})\} \subset \lambda$, let Φ_1^m be the map given by composing the one box removal map where the column of removed boxes is extended by one each time, i.e. $\Phi_1^1 = \Phi_1$ and

$$\Phi_1^m(T) = \sum_P \frac{(-1)^P}{H(P)} P(\Phi_1^{m-1}(T))$$

where the sum is over all 1-paths P on $\lambda \setminus \{x_1, \dots, x_{m-1}\}$ removing x_m and

$$P(Y_Q \otimes T_Q) = Y_Q^P \otimes P(T_Q)$$

and Y_P is the box removed by from P from T_Q .

Lemma. Φ_1^m is a $GL(V)$ -map.

Proof. By the previous theorem this follows from the proof in [SW11, Corollary 1.8], where it is shown for the iteration of Olver's map. □

Let

$$\Phi_m : \mathbb{S}_\lambda(V) \rightarrow F_m \otimes \mathbb{S}_{\lambda \setminus X}(V)$$

be the Pieri inclusion constructed in Section 4.

Theorem. For Φ_1^m and Φ_m as above,

$$\Phi_1^m = \Phi_m.$$

Proof. Let $T_\lambda \in \mathcal{T}_{\lambda, n}$ and $T_{\lambda \setminus X} \in \mathcal{T}_{\lambda \setminus X, n}$ be the diagrams corresponding to highest weight vectors as in Section 2.3. Then in the image of T_λ , the coefficient of

$$\begin{array}{|c|} \hline \alpha_m \\ \hline \vdots \\ \hline \alpha_1 \\ \hline \end{array} \otimes T_{\lambda \setminus X}$$

where

$$\alpha_1 = \sum_{i=b_1}^N h_i$$

and

$$\alpha_k = \alpha_1 - (k - 1)$$

for $2 \leq k \leq m$ is readily seen to be $(-1)^m w_{b_1}^m$ in the image of both Φ_1^m and Φ_m . By uniqueness of the Pieri inclusion up to scalar multiple, we then have

$$\Phi_1^m = \Phi_m.$$

□

8.3. Define the map

$$\Phi'_m : \mathbb{S}_\lambda(V) \rightarrow S^m(V) \otimes \mathbb{S}_{\lambda \setminus X}(V)$$

just as we have defined Φ_m in Section 4 except for redefining, for all m -paths P on λ removing X ,

$$Y_P = E_X \boxed{\alpha_m^P \cdots \alpha_1^P}$$

which is standard form notation is $e_{\alpha_1^P} \cdots e_{\alpha_m^P} \in S^m V$.

Theorem. *The map*

$$\Phi'_m : \mathbb{S}_\lambda(V) \rightarrow S^m(V) \otimes \mathbb{S}_{\lambda \setminus X}(V)$$

is a $GL(V)$ -map.

Proof. As Φ_m is a $GL(V)$ -map, similar to [SW11, Corollary 1.8], this follows by the results of Sections 6 and 7 by keeping track of a sign. \square

9. THE IMAGE OF A HIGHEST WEIGHT VECTOR AND COMPUTATIONAL COMPLEXITY

9.1. In this section we use the Pieri inclusion Φ_1 constructed in Section 3 to give an optimal description of the image under a Pieri inclusion removing one box of a highest weight vector. Given a removal set $X = \{x_1 = [b_1](1, w_{b_1})\} \subset \lambda$, it is clear by the construction of 1-paths that for all 1-paths on λ removing X , $(T_\lambda)_P$ is semi-standard.

Define the relation \sim on the set of all 1-paths on λ removing X by

$$P \sim Q \iff R^Q \text{ and } R^P \text{ intersect the same set of rows.}$$

This clearly defines an equivalence relation. Let

$$[P] = \{Q : Q \sim P\}.$$

Then for all $Q \in [P]$ we have $(-1)^Q = (-1)^P$ and $H(Q) = H(P)$, and, when considering the image of a highest weight vector where each entry in a given row is the same,

$$Y_Q \otimes (T_\lambda)_Q = Y_P \otimes (T_\lambda)_P.$$

For distinct $[P]$ and $[P']$ we have (by construction) that $Y_P \otimes (T_\lambda)_P$ and $Y_{P'} \otimes (T_\lambda)_{P'}$ are linearly independent. Thus, $\Phi_1(T_\lambda)$ can be written as

$$\Phi_1(T_\lambda) = \sum_{[P_0]} \frac{(-1)^{P_0} |[P_0]|}{H(P_0)} P_0(T_\lambda)$$

where the sum is over all 1-paths P_0 on λ removing X which only hit boxes in the first column of λ . From the above, the terms in the image of $\Phi_1(T_\lambda)$ are linearly independent and do not require straightening, and so this description is optimal. Recall that such an example was computed in Section 1.4. To see the optimal description from this example, take only the first six terms shown.

9.2. For a given such 1-path P_0 , we now describe the corresponding term in the image of T_λ . Let $\{r_i\}_{1 \leq i \leq |R^{P_0}|}$ be the rows in λ that P_0 hits, so that $\lambda_i > \lambda_{i+1}$ and $r_{|R^{P_0}|} = [b_1](1)$. Then

$$|[P_0]| = \prod_{i=1}^{|P|} \lambda_{r_i}$$

and $(T_\lambda)_{P_0} \in \mathbb{S}_{\lambda \setminus X}$ has λ_1 ones in the first row, λ_2 twos in the first row, etc. except for each row r_i , $1 \leq i \leq |R^{P_0}|$, where the last entry in row r_i of $(T_\lambda)_{P_0}$ is

$$((T_\lambda)_{P_0})_{(r_i, \lambda_{r_i})} = r_{i+1}.$$

9.3. The second author has implemented this optimal description using Macaulay2, with the output given as a hash table, where one can quickly compute the image of the highest weight for very large examples. Figure 9.3.1 shows the timed computation for the image of a highest vector, where the partition is given as the first input of the function `oneboxremovalHW` and the second input of the function is the row (from the top of the tableau) of the box to be removed.

```
i12 : time oneboxremovalHW({10,10,10,10,10,10,10,7,7,7,7,7,3,3,3,3},18)
-- used 0.0283769 seconds

o12 = HashTable{{{0}, {0, 0, 0, 0, 0, 0, 0, 0, 0, 1}, {1, 1, 1, 1, 1, 1, 1, 1, 1, 2},
  {{0}, {0, 0, 0, 0, 0, 0, 0, 0, 0, 1}, {1, 1, 1, 1, 1, 1, 1, 1, 1, 2},
  {{0}, {0, 0, 0, 0, 0, 0, 0, 0, 0, 1}, {1, 1, 1, 1, 1, 1, 1, 1, 1, 2},
```

FIGURE 9.3.1. Computing the image of the highest weight for the inclusion $\mathbb{S}_{(10,10,10,10,10,10,10,7,7,7,7,7,3,3,3,3)} \rightarrow \mathbb{S}_{(1)} \otimes \mathbb{S}_{(10,10,10,10,10,10,10,7,7,7,7,7,3,3,3,2)}$.

9.4. We now describe the computational complexity of Φ_1 and compare this to the computational complexity of the one-box removal Pieri inclusion described by Olver. For a removal set $X = \{x_1 = [b_1](1, w_{b_1})\}$, let

$$\tilde{\Phi}_1 : \mathbb{S}_\lambda(V) \rightarrow V \otimes \mathbb{S}_{\lambda \setminus X}(V)$$

be the Pieri inclusion given by Olver (see [SW11, §1.2] and [Sam09, §4]).

Theorem. *Fix a positive integer N and consider partitions λ that have at most N blocks. Then our algorithm to compute the image of a highest weight vector under a Pieri inclusion $\Phi_1 : \mathbb{S}_\lambda(V) \hookrightarrow V \otimes \mathbb{S}_{\lambda \setminus X}(V)$ has a worst-case time complexity of $O(l(\lambda)^N)$. On the other hand, the algorithm to compute the image of a highest weight vector under a Pieri inclusion $\tilde{\Phi}_1 : \mathbb{S}_\lambda(V) \hookrightarrow V \otimes \mathbb{S}_{\lambda \setminus X}(V)$ has a worst-case time complexity of $\Omega(2^{l(\lambda)})$.*

Proof. Let $\lambda = (w_1^{h_1}, \dots, w_N^{h_N})$. We first consider the time complexity of the algorithm as given by Olver's construction. As in Section 9.1, when considering the image of a highest weight vector we only need to select paths on λ removing X that act on the first column of λ . From the description of the map $\tilde{\Phi}_1$ removing X in [SW11, §1.2], the number of such paths in the computation of $\tilde{\Phi}_1$ is equal to the number of choices of rows in λ above row $[b_1](1)$. Thus the complexity of the map $\tilde{\Phi}_1$ acting on a highest weight vector is

$$2^{b_1-1} \cdot \prod_{i=b_1+1}^N 2^{h_i} \leq \frac{1}{2} \cdot \prod_{i=1}^N 2^{h_i} = \frac{1}{2} \cdot 2^{\sum_{i=1}^N h_i} = \frac{1}{2} \cdot 2^{l(\lambda)}.$$

In the worst-case when $b_1 = 1$, the inequality is in fact an equality. Furthermore, the paths that act on the first column of λ using Olver's algorithm can result in tableaux which are not semi-standard, and so must be straightened. Hence the worst-case complexity of Olver's algorithm is $\Omega(2^{l(\lambda)})$.

The map Φ_1 removing X restricts the choices of rows to those which describe an evacuation route, and hence the number of 1-paths acting on the first column of λ in the computation of Φ_1 is equal to the number of choices of rows in λ above row $[b_1](1)$ made without skipping rows within blocks. It also clear from the definition of 1-paths that the image of a highest weight vector under a 1-path is semi-standard. Thus the complexity of the map Φ_1 acting on a highest weight vector is

$$h_{b_1} \cdot \prod_{i=b_1+1}^N (h_i + 1) < \prod_{i=1}^N (h_i + 1) \leq (l(\lambda) + 1)^N = \Theta(l(\lambda)^N).$$

□

Remark. Similar to the previous theorem, by restricting the maximum possible width of a block in λ we get that Φ_1 is an exponential speed up of $\tilde{\Phi}_1$ on the image of basis vectors (semi-standard tableaux) in \mathbb{S}_λ .

9.5. This exponential to polynomial speed up can be seen in the computation time for computing Pieri maps in Macaulay2, for which the second author has implemented the description of Φ_1 given in Section 3 within Sam's PieriMaps package [Sam09].

In Figure 9.5.1 below we show the timed computations for computing the map

$$\mathbb{S}_{(8,8,8)} \rightarrow \mathbb{S}_{(1)} \otimes \mathbb{S}_{(8,8,7)}.$$

Using Olver's algorithm (as built in to PieriMaps), the process was interrupted after an hour with no output. Using our algorithm implemented in PieriMaps, computing this map takes only 0.07 seconds.

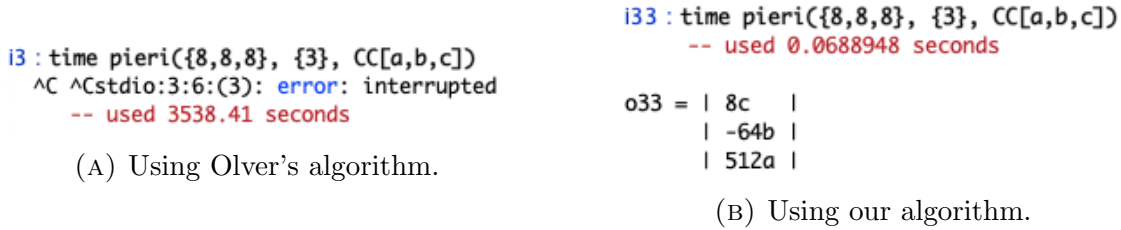
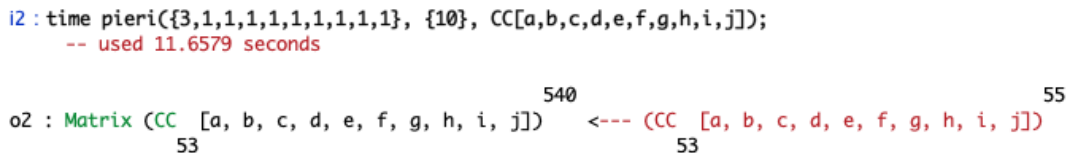

FIGURE 9.5.1. Computing the inclusion $\mathbb{S}_{(8,8,8)} \rightarrow \mathbb{S}_{(1)} \otimes \mathbb{S}_{(8,8,7)}$.

We can also see this exponential speed up for small examples with more than one block. In the figure below we show the computation time for the Pieri inclusion

$$\mathbb{S}_{(3,1,1,1,1,1,1,1,1,1)} \rightarrow \mathbb{S}_{(1)} \otimes \mathbb{S}_{(3,1,1,1,1,1,1,1,1)}$$

using Olver's algorithm.



Using Olver's algorithm this computation takes over eleven seconds, while with the new algorithm this computation (shown below) takes less than two seconds.

```
i31 : time pieri({3,1,1,1,1,1,1,1,1}, {10}, CC[a,b,c,d,e,f,g,h,i,j]);
      -- used 1.3184 seconds

o31 : Matrix CC [a, b, c, d, e, f, g, h, i, j] 540 <--- (CC [a, b, c, d, e, f, g, h, i, j]) 55
          53
```

REFERENCES

- [EFW11] David Eisenbud, Gunnar Fløystad, and Jerzy Weyman. The existence of equivariant pure free resolutions. *Annales de l'Institut Fourier*, 61(3):905–926, 2011. <https://arxiv.org/abs/0709.1529v5>.
- [FH13] William Fulton and Joe Harris. *Representation theory: a first course*, volume 129. Springer Science & Business Media, 2013.
- [Ful97] William Fulton. *Young tableaux: with applications to representation theory and geometry*, volume 35. Cambridge University Press, 1997.
- [Olv82] Peter J Olver. Differential hyperforms i. *University of Minnesota Mathematics Report*, pages 82–101, 1982. available at <http://www.math.umn.edu/~olver/>.
- [PW85] Piotr Pragacz and Jerzy Weyman. Complexes associated with trace and evaluation. another approach to lascoux's resolution. *Advances in Mathematics*, 57(2):163–207, 1985.
- [Sam09] Steven V Sam. Computing inclusions of schur modules. *Journal of Software for Algebra and Geometry*, 1(1):5–10, 2009.
- [SW11] Steven V Sam and Jerzy Weyman. Pieri resolutions for classical groups. *Journal of Algebra*, 329(1):222–259, 2011. <https://arxiv.org/abs/0907.4505v5>.

DEPARTMENT OF MATHEMATICS, BAYLOR UNIVERSITY, WACO, TX 76798
E-mail address: markus_hunziker@baylor.edu

DEPARTMENT OF MATHEMATICS, BAYLOR UNIVERSITY, WACO, TX 76798
E-mail address: john_miller5@baylor.edu

DEPARTMENT OF MATHEMATICS, BAYLOR UNIVERSITY, WACO, TX 76798
E-mail address: mark_sepanski@baylor.edu