

5/4-Approximation of Minimum 2-Edge-Connected Spanning Subgraph

Ali Çivril

November 19, 2019

Abstract

We provide a 5/4-approximation algorithm for the 2-edge connected spanning subgraph problem. This improves upon the previous best ratio of 4/3. The algorithm is based on applying local improvement steps on a starting solution provided by a standard ear decomposition. Unlike previous approaches, we consider modifications involving 5-ears together with 3-ears.

1 Introduction

Problems concerned with constructing a subgraph of a given graph satisfying certain connectivity requirements are among the most natural and occupy an important place in the field of approximation algorithms. In this paper, we consider the following fundamental connectivity problem in graphs: Given an undirected simple graph $G = (V, E)$, find a 2-edge-connected spanning subgraph of G with minimum number of edges. We briefly denote this problem by 2-ECSS. It has the following natural LP relaxation, where $\delta(S)$ denotes the set of edges with one end in the cut S and the other not in S .

$$\begin{aligned}
 & \text{minimize} && \sum_{e \in E} x_e && (EC) \\
 & \text{subject to} && \sum_{e \in \delta(S)} x_e \geq 2, && \forall \emptyset \subset S \subset V, \\
 & && 1 \geq x_e \geq 0, && \forall e \in E.
 \end{aligned}$$

The dual of this LP is as follows.

$$\begin{aligned}
 & \text{maximize} && 2 \sum_{\emptyset \subset S \subset V} y_S - \sum_{e \in E} z_e && (EC-D) \\
 & \text{subject to} && \sum_{S: e \in \delta(S)} y_S \leq 1 + z_e, && \forall e \in E, \\
 & && y_S \geq 0, && \forall \emptyset \subset S \subset V, \\
 & && z_e \geq 0, && \forall e \in E.
 \end{aligned}$$

This problem is a special case of many other network design problems, in particular the famous traveling salesman problem. It remains NP-hard and MAX SNP-hard even for subcubic graphs [3]. Thus, approximation algorithms have been sought. The first result beating the factor 2 came from Khuller and Vishkin [7], which is a $\frac{3}{2}$ -approximation algorithm. Cheriyan, Sebö and Szigeti [2] improved the factor to $\frac{17}{12}$. Vempala and Vetta [10], and Jothi, Raghavachari and Varadarajan

[6] claimed to have $\frac{4}{3}$ and $\frac{5}{4}$ approximations, respectively. Krysta and Kumar [8] went on to give a $(\frac{4}{3} - \epsilon)$ -approximation for some small $\epsilon > 0$ assuming the result of Vempala and Vetta [10]. A relatively recent paper by Sebö and Vygen [9] provides a $\frac{4}{3}$ -approximation algorithm given by using more elegant ear decompositions, and mentions that the aforementioned claimed approximation ratio $\frac{5}{4}$ has not appeared with a complete proof in a fully refereed publication. The result of Vempala and Vetta [10], which was initially incomplete, very recently re-appeared in [5]. Given this, it is not clear if the ratio $(\frac{4}{3} - \epsilon)$ by Krysta and Kumar [8] still holds. To the best of our knowledge, the ratio $\frac{4}{3}$ stands as the current best factor. A paper by Boyd, Fu and Sun [1] shows that the integrality gap α_{EC} of (EC) satisfies $\frac{8}{7} \leq \alpha_{EC} \leq \frac{5}{4}$ for the class of subcubic bridgeless graphs. Thus, we have in general $\frac{8}{7} \leq \alpha_{EC} \leq \frac{4}{3}$ by adding the result of Sebö and Vygen [9] that $\alpha_{EC} \leq \frac{4}{3}$.

We prove the following theorem.

Theorem 1. *There exists a polynomial-time $\frac{5}{4}$ -approximation algorithm for 2-ECSS. Furthermore, $\alpha_{EC} \leq \frac{5}{4}$.*

This improves the previous best factor $\frac{4}{3}$, and gives the new bounds $\frac{8}{7} \leq \alpha_{EC} \leq \frac{5}{4}$.

Our approach is based on a result of Frank [4], which states that certain ear decompositions can be computed efficiently. This was also previously used by Cheriyan, Sebö and Szigeti [2], and Sebö and Vygen [9] for 2-ECSS. These authors consider constructing finer ear decompositions beyond the one provided by the theorem of Frank. We do also construct a more sophisticated ear decomposition over the base solution, but this time including modifications involving 5-ears, too. More crucially in the analysis, we make use of a convex combination of two different lower bounds: one implied by an optimal ear decomposition with respect to the number of even ears; the other by the dual of the LP relaxation of the problem. This also allows us to bound the integrality gap.

2 Preliminaries

In this section, we collect facts that will be used in our analysis. If a result already appears in the literature, we cite it without giving a proof and refer the reader to the relevant paper.

We first make the assumption that the input graph G is 2-connected. The derived approximation ratio on each maximally 2-connected subgraph (i.e. *blocks*) of G also holds for G , since the optimal value for G is the sum of the optimal values for the blocks. Thus, we can run any algorithm on the blocks separately.

An *ear decomposition* of a graph $G = (V, E)$ is a partition of E into subgraphs, namely P_0, P_1, \dots, P_k such that P_0 is the trivial path of length 0, and for $i = 1, \dots, k$, P_i is either

1. a path with exactly both end vertices in $V(P_0) \cup V(P_1) \cup \dots \cup V(P_{i-1})$, or
2. a cycle with exactly one vertex in $V(P_0) \cup V(P_1) \cup \dots \cup V(P_{i-1})$.

An element of the set $\{P_1, \dots, P_k\}$ is called an *ear*. If it is of the first type above, it is called an *open ear*, otherwise a *closed ear*. Note that P_1 is always closed. The set of vertices of an ear, which are not end vertices are called the *internal vertices* of the ear. The set of internal vertices of an ear P_i is denoted by $\Delta(P_i)$. For a nonnegative integer ℓ , an ear with ℓ edges is called an ℓ -*ear* (i.e. $|\Delta(P_i)| = \ell - 1$). P_i is called an *even ear* if ℓ is even, an *odd ear* otherwise. A 1-ear is also called a *trivial ear*. An ℓ -ear with $\ell \geq 2$ such that none of its internal vertices is an end vertex of another p -ear with $p \geq 2$ is called a *pendant ear*. Note that if we disregard the trivial ears, all the internal vertices of a pendant ear have degree 2.

An *open ear decomposition* P_1, \dots, P_k is one in which all the ears P_2, \dots, P_k are open ears. It is well known by a result of Whitney [11] that a graph is 2-edge-connected if and only if it has an ear decomposition, and 2-connected if and only if it has an open ear decomposition. Given a 2-edge-connected graph $G = (V, E)$, let $\varphi(G)$ denote the minimum number of even ears over all possible ear decompositions.

Proposition 2. [4] *Given a 2-edge-connected graph $G = (V, E)$, one can compute an open ear decomposition with $\varphi(G)$ even ears in time $O(n^3)$.*

Based on this result, the following is given by Cheriyan, Sebö and Szigeti [2].

Proposition 3. [2] *Given a 2-connected graph $G = (V, E)$, an open ear decomposition of G with $\varphi(G)$ even ears can be computed in time $O(n^3)$.*

We call such an ear decomposition an *optimal ear decomposition*.

Let $OPT_{EC}(G)$ denote the optimum value of a 2-ECSS in G . Let $LP_{EC}(G)$ denote the optimum value of the LP (EC) on G . Obviously, we have $OPT_{EC}(G) \geq LP_{EC}(G)$. Define $L_\varphi(G) := n + \varphi(G) - 1$.

Proposition 4. [9] $LP_{EC}(G) \geq L_\varphi(G)$.

We will interpret the lower bound implied by $L_\varphi(G)$ as a sum distributed over ears. Given an optimal ear decomposition P_1, \dots, P_k , and an odd ear P_i , we set $L_\varphi(P_i) := |\Delta(P_i)|$. For an even ear P_j , we set $L_\varphi(P_j) := |\Delta(P_j)| + 1$.

Proposition 5.

$$L_\varphi(G) = \sum_{i=1}^k L_\varphi(P_i).$$

Proof. We argue inductively by considering the induction hypothesis on the solution obtained by removing a pendant ear. In the base case, there is a single pendant ear P_1 . By definition, if P_1 is an odd ear, then $L_\varphi(G) = n - 1 = L_\varphi(P_1)$. Similarly, if P_1 is an even ear, then $L_\varphi(G) = n = L_\varphi(P_1)$. As for the inductive step, let G' be the graph obtained by removing a pendant ear. If the removed pendant ear P_i is an odd ear, then $L_\varphi(G) = L_\varphi(G') + |\Delta(P_i)| = L_\varphi(G') + L_\varphi(P_i)$. If it is an even ear, then $L_\varphi(G) = L_\varphi(G') + |\Delta(P_i)| + 1 = L_\varphi(G') + L_\varphi(P_i)$. This establishes the result. \square

Given all these, we have

$$OPT_{EC}(G) \geq LP_{EC}(G) \geq L_\varphi(G) = \sum_{i=1}^k L_\varphi(P_i). \quad (1)$$

We will also use (EC-D) for lower bounding the optimum. In (EC-D), a cut S is synonymously called a *dual*. We will consider a feasible dual solution in which the dual values corresponding to certain vertices are positive, and all the others are 0. Abusing the notation, a dual consisting of a single vertex v is denoted by v instead of $\{v\}$, and denote the dual variable corresponding to v by y_v .

3 Approximating 2-ECSS

The algorithm consists of several phases to construct a finer ear decomposition. At each phase, it either performs certain operations improving the solution by edge interchanges, or it rearranges the

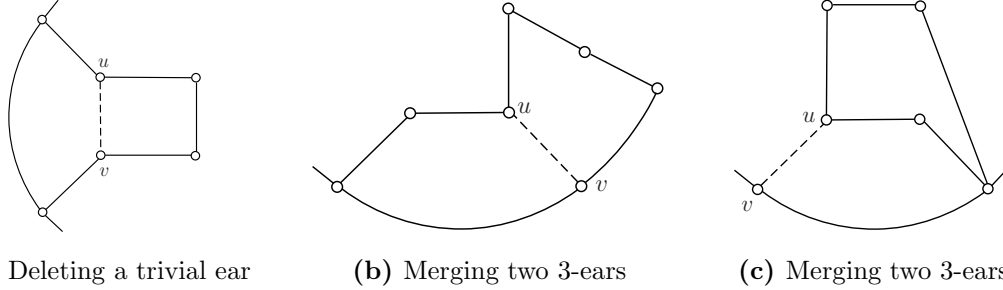

(a) Deleting a trivial ear (b) Merging two 3-ears (c) Merging two 3-ears
Figure 1: Examples of modifications to satisfy Condition (0) and Condition (1)

ears by terminating some and creating new ones. Instead of describing the algorithm in pseudocode, which would hinder the basic ideas behind it, we explain it by stating the conditions we require on the solution, which are successively stated to render the analysis more transparent. Each phase satisfies a condition, building on the solution filtered by the previous one so that configurations ruled out by previous cases are not considered in the foregoing one. In reality, it is possible to satisfy all the conditions together in an algorithmically more compact way, which is not the focus of this paper.

The algorithm starts by computing an optimal ear decomposition. Efficient implementation of this procedure is guaranteed by Proposition 3. Let F be the solution returned by this phase. Before stating all the conditions, we first assume that there are no trivial ears, which can be satisfied without changing the parities of the ears (see Figure 1a for an illustration):

(0) Let P be an ear on F . Let Q be another open ear on F . Then, there is no edge (u, v) of P such that u and v are the end vertices of Q .

Given an ear P and another ear Q , if at least one end vertex of P is in $\Delta(Q)$, we say that P touches Q via its end vertices, which are called *touched vertices* of Q , and Q is *touched by* P . Otherwise, we say that P and Q are *independent*, P is *independent of* Q , and vice versa.

(1) Let P_1 be a 3-ear on F . Let P_2 be another open 3-ear on F . Then, P_1 and P_2 are independent.

Consider a 3-ear P_1 and another open 3-ear P_2 touching P_1 . By assumption, the end vertices of P_2 cannot be adjacent vertices of P_1 . The algorithm checks if the deletion of an edge (u, v) of P_1 other than the middle edge can be performed without violating feasibility. After the deletion, merging of the 3-ears to form a 5-ear is performed, which does not change the number of even ears (see Figures 1b and Figure 1c for examples).

(2) Let P_1 be a 3-ear on F . Let P_2 be another open 3-ear on F . Then, no vertex in $\Delta(P_1)$ is adjacent to a vertex in $\Delta(P_2)$ via the edges in $E \setminus F$.

To satisfy this, we iterate over the edges $e = (u, v)$ such that

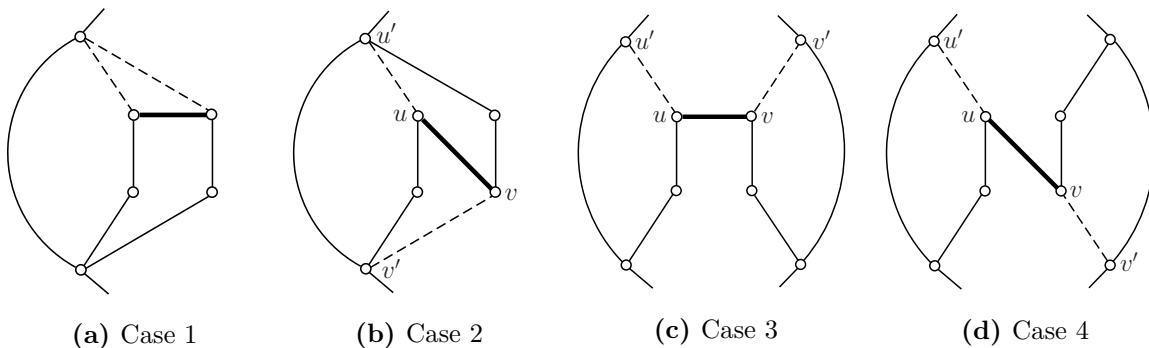

(a) Case 1 (b) Case 2 (c) Case 3 (d) Case 4

Figure 2: Modifications to satisfy Condition (2)

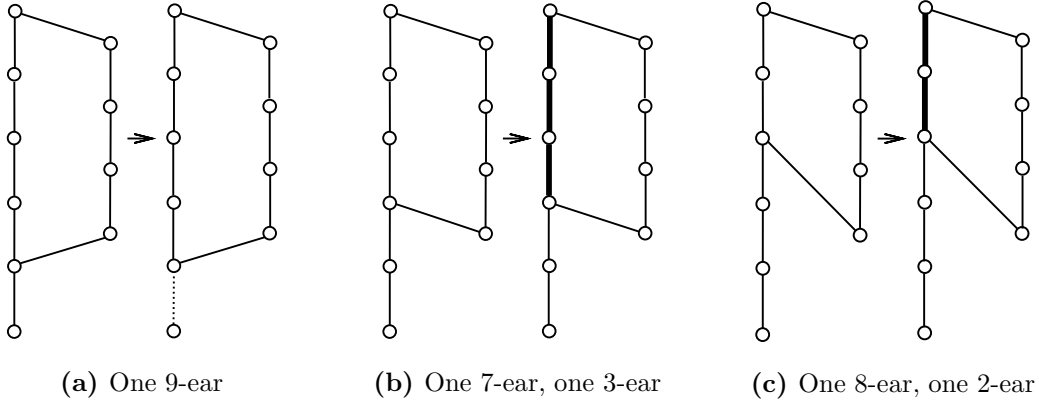

Figure 3: Modifications to satisfy Condition (3)

1. $e \notin F$, and
2. $u \in \Delta(P_1)$ and $v \in \Delta(P_2)$ for distinct 3-ears P_1 and P_2 .

It modifies F by performing what we call *improvement steps* via such e . Let the end vertices of P_1 and P_2 be u' and v' , adjacent to u and v , respectively. The algorithm checks if selecting e and deleting the edges (u, u') and (v, v') does not violate feasibility. If so, it performs the deletions and includes e into the solution (see Figure 2 for illustrations of all the cases for open ears, where the included edge is in bold). Note that this does not change the number of even ears on F .

In order to describe the remaining conditions more precisely, we consider a numbering of the vertices of a given 5-ear Q from 1 to 6, from one end vertex to the other. Number 2 and 5 are called the *side vertices* of Q .

(3) *Let Q_1 be a 5-ear on F . Let Q_2 be another open 5-ear on F . Then, Q_1 and Q_2 are independent.*

This condition is satisfied as follows. Given a 5-ear Q_1 , if there is a single touched vertex in $\Delta(Q_1)$, which is a side vertex, then we terminate the 5-ears and declare a new ear of length 9. If the difference of the coordinates of the touched vertices is 2, we declare two new ears, one being an 8-ear, the other a 2-ear. If this difference is 3, we declare one 7-ear and one 3-ear. We then run the phases ensuring Condition (1) and Condition (2) to handle the new 3-ears. See Figure 3 for example illustrations, and note that the cases occurring upon translation of the coordinates of the touched vertices can be handled likewise as described. In this figure, and in the following ones describing rearrangements and improvements, the new ears are depicted with solid lines of varying thickness, the disregarded edges are shown using dotted lines.

(4) *Let P be a 3-ear touching a 5-ear Q via an end vertex of Q . Then, the other touched vertex of Q is not a side vertex of Q .*

This is satisfied by terminating P and Q , and declaring a new 7-ear as in Figure 1c.

(5) *Let Q be a 5-ear on F . Let R be another open 3-ear independent of Q or an open 5-ear on F . Then, no side vertex of Q is adjacent to a vertex in $\Delta(R)$ via the edges in $E \setminus F$.*

Similar to the case of Condition (2), we iterate over the edges $e = (u, v)$ such that

1. $e \notin F$, and
2. u is a side vertex of Q and $v \in \Delta(R)$ for distinct ears Q (a 5-ear) and R (a 3-ear or a 5-ear).

We modify F by performing improvement steps via such e or rearrange the ears. All possible cases modulo the equivalence relation grouping the symmetric cases are depicted in Figure 4.

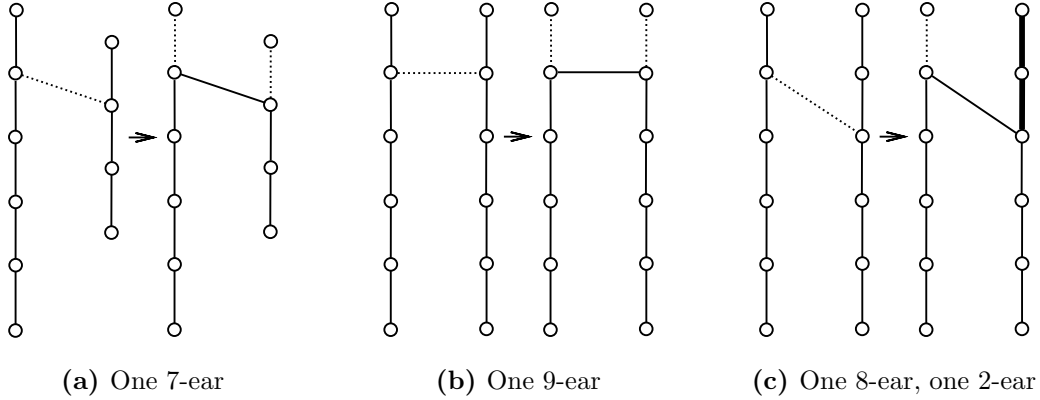

Figure 4: Modifications to satisfy Condition (5)

(6) Let Q be a 5-ear on F . Then, there is no set of 3-ears touching Q via more than 2 vertices. We consider the case in which two 3-ears touch Q via more than 2 vertices, and describe the rearrangement of the ears in Table 1 and Table 2, where we number the vertices of Q starting from the top end. In each case, we terminate Q , the two 3-ears touching Q , and declare at most two new ears. We denote the case in which the first 3-ear touches Q via a and b , and the second 3-ear touches Q via c and d by $(a, b).(c, d)$, where a, b, c, d take values in $\{1, 2, 3, 4, 5, 6\}$. Note that by definition, the coordinates of a 3-ear cannot be $(1, 6)$. By Condition (0), we have that the difference between the coordinates of a 3-ear is at least 2. By Condition (4), the tuples $(1, 5)$ and $(2, 6)$ cannot appear. Furthermore, we only consider the cases for which $a = 1$. It is easy to see that the rest is essentially the same by a translation of all the coordinates of the 3-ears. We also do not show

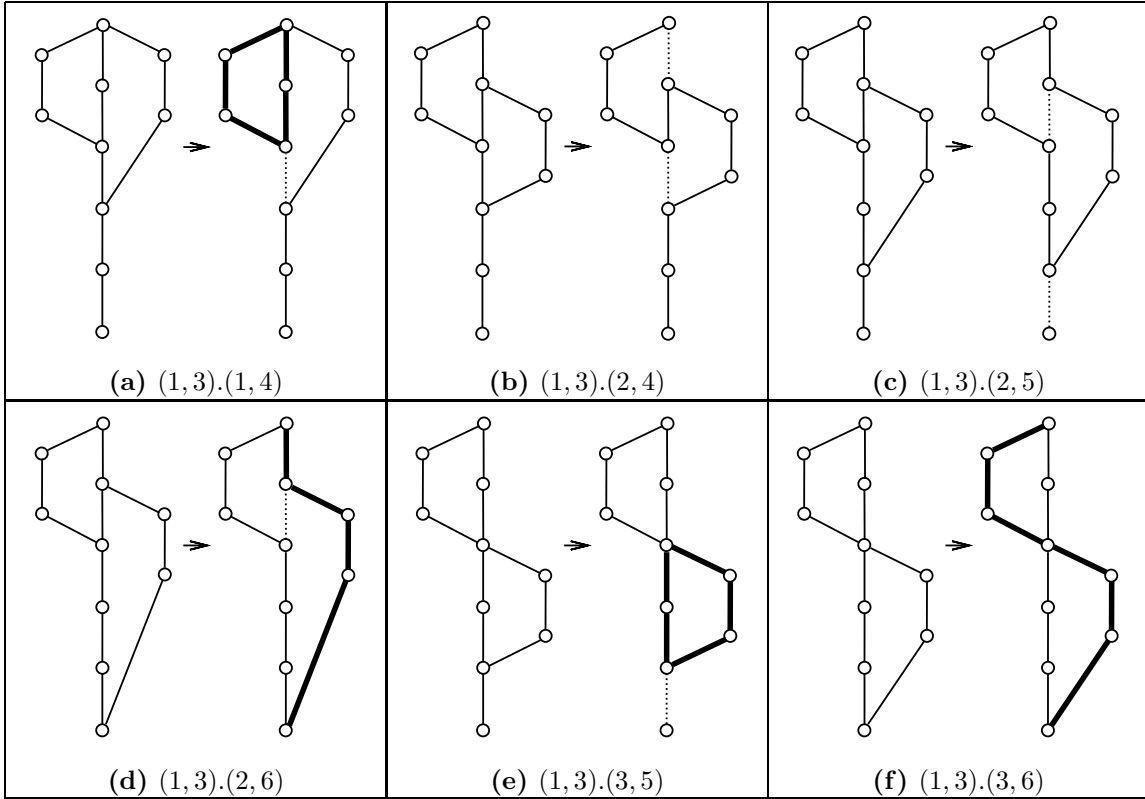

Table 1: Modifications to satisfy Condition (6), Part I

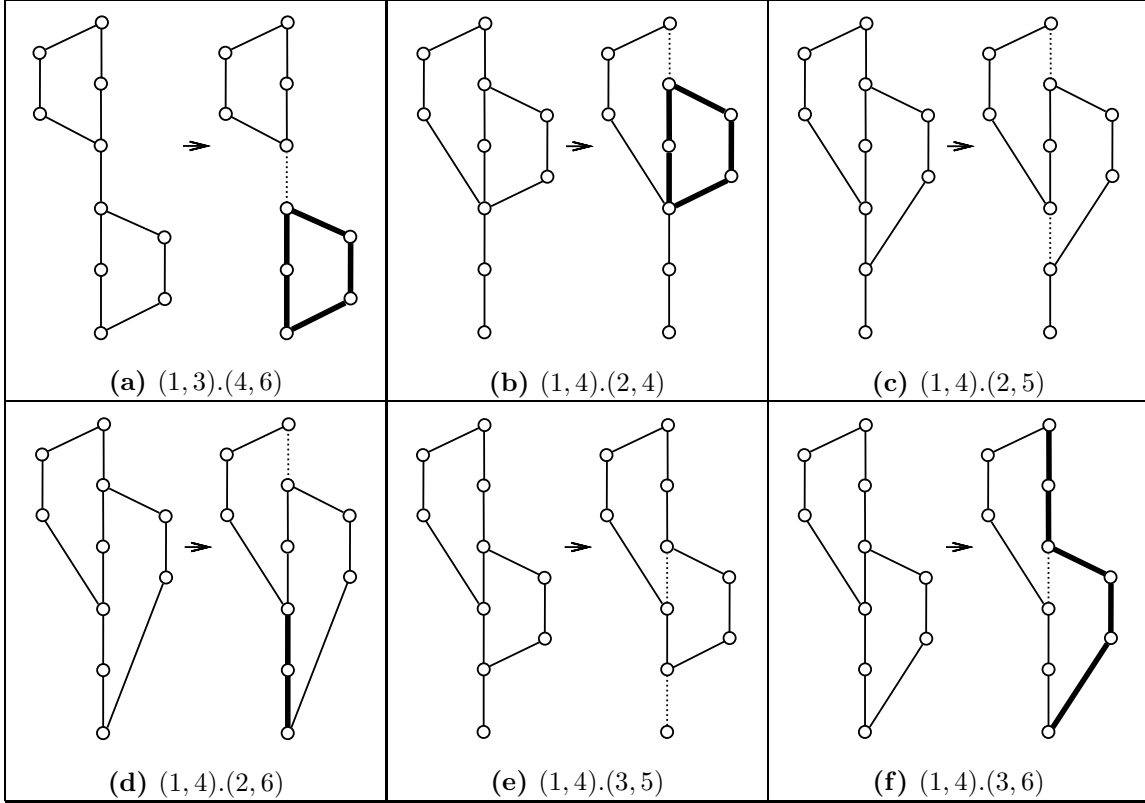

Table 2: Modifications to satisfy Condition (6), Part II

the case (1, 4).(4, 6), which is the same as (1, 3).(3, 6) when the vertices of Q are numbered starting from the bottom end. There are in total 12 cases. Notice that there are cases in which we declare new 5-ears. By construction however, there cannot be a set of 3-ears touching these 5-ears via more than 2 vertices so that the condition is still satisfied. In all other cases, an ear of length at least 6 is declared, possibly together with another one. If there is only one new ear, it is of length at least 9. If there are two new ears, their total length is at least 10.

(7) Let Q be a 5-ear on F touched by a set of 3-ears. Let further the set of touched vertices contain one end vertex of Q . Then, there are two non-adjacent vertices $u, v \in \Delta(Q)$, called free vertices, not adjacent to any inner vertex of a 3-ear or a 5-ear via the edges in $E \setminus F$.

By Condition (6), if there are at least two 3-ears touching Q , then the number of touched vertices

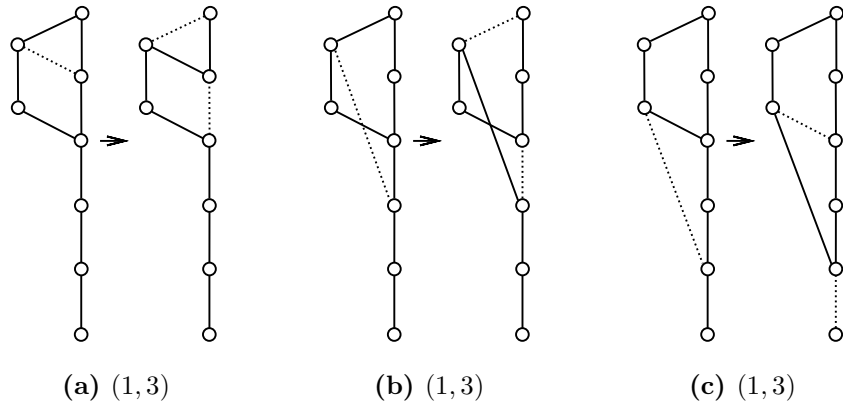

Figure 5: Modifications to satisfy Condition (7), Part I

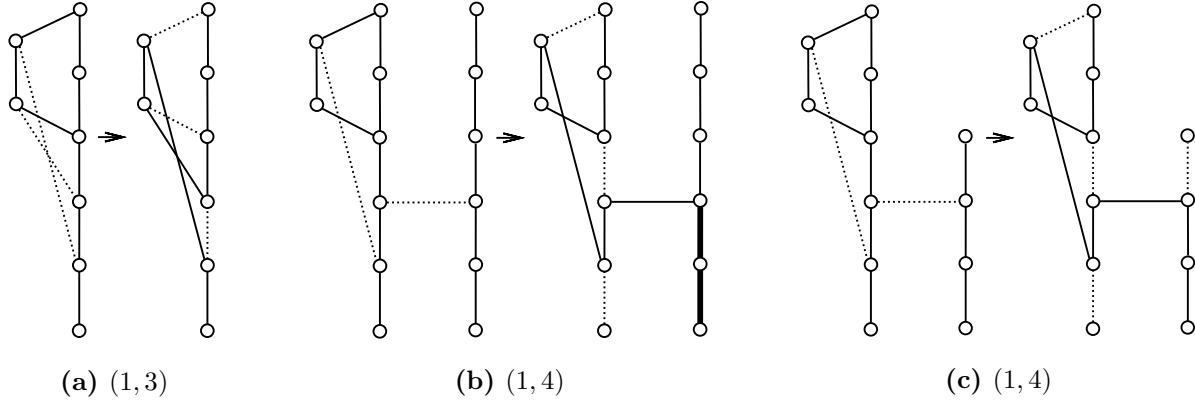

Figure 6: Modifications to satisfy Condition (7), Part II

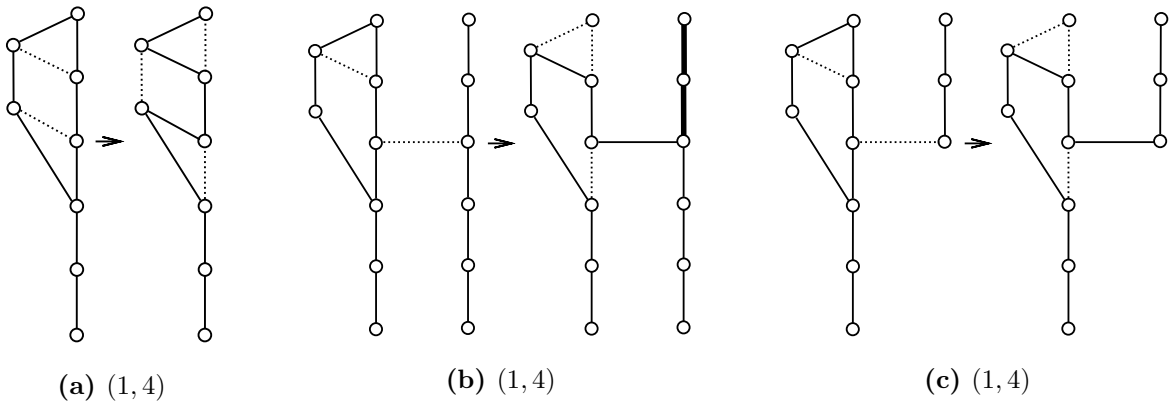

Figure 7: Modifications to satisfy Condition (7), Part III

of Q is at most 2. In other words, the 3-ears touching Q all touch via the same vertices. Thus, we consider improvement steps for the case of one 3-ear P touching Q via two vertices. From this phase on, instead of describing what the improvement steps do, we point out the possibility of an improvement on an instance which we call a *forbidden configuration*. Assuming without loss of generality that the touched end vertex of Q is 1, we list the forbidden configurations and the corresponding improvements for the cases in which the touched vertices are (1,3) and (1,4) in Figure 5, Figure 6, and Figure 7. Note that the cases in which an inner vertex of Q is adjacent to an inner vertex of another 5-ear, there is at least 3 vertices of that 5-ear on one side. In all of the cases, either a new 7-ear, or one 8-ear and one 2-ear, or one 10-ear and one 2-ear are created. Ruling out these forbidden cases, we see that there are two non-adjacent free vertices in $\Delta(Q)$.

(8) Let Q be a 5-ear touched by a set of 3-ears. Let further the touched vertices be in $\Delta(Q)$. Then, there is a vertex $u \in \Delta(Q)$, called the free vertex, not adjacent to any inner vertex of a 3-ear or a 5-ear via the edges in $E \setminus F$.

There are essentially two main cases in which the touched vertices are (2,4) and (2,5). We list the forbidden cases and the corresponding improvements in Figure 8 and Figure 9, where the possible lengths of the newly created ears are the same as in Condition (7).

(9) Let Q be a 5-ear touched by a set of 3-ears P_1, \dots, P_k . Let further the touched vertices be in $\Delta(Q)$. Then, no vertex in $\Delta(P_i)$ is adjacent to an inner vertex of a 5-ear via the edges in $E \setminus F$, for $i = 1, \dots, k$.

The setting is the same as in Condition (8). The forbidden configurations and improvements are shown in Figure 10, where one 10-ear and one 2-ear are created in each case.

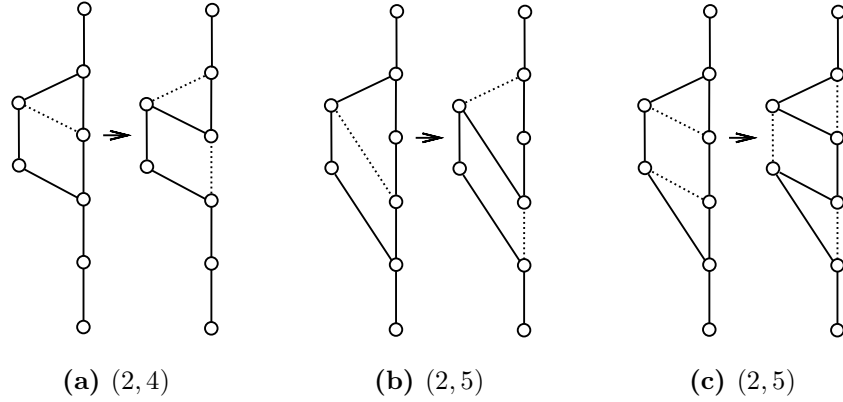

Figure 8: Modifications to satisfy Condition (8), Part I

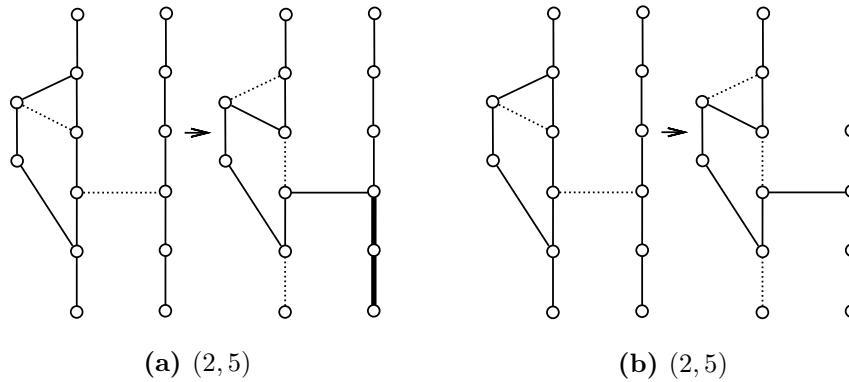

Figure 9: Modifications to satisfy Condition (8), Part II

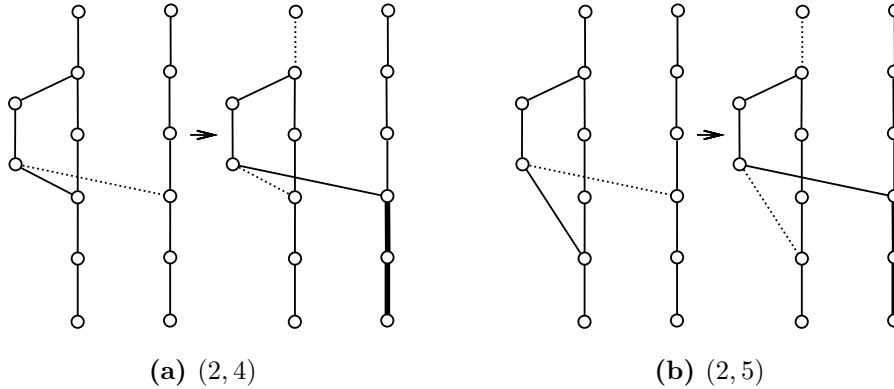

Figure 10: Modifications to satisfy Condition (9)

In any of the phases ensuring the conditions above, the rearrangement of the ears or the improvement steps do not create a configuration to be reconsidered in the phase so that the algorithm terminates. Furthermore, the maximum number of ears involved in any rearrangement or an improvement step is 3, implying that there are at most $O(n^3)$ operations performed in total.

4 Proof of Theorem 1

Let C be the total cost of the edges returned by the algorithm. All the operations performed to ensure Condition (3)-Condition (9) create either a single new ℓ -ear with $\ell \geq 7$, or two new ears of total length at least 10. In the latter case, let G' be the graph obtained by removing the inner vertices of these ears from G . Clearly, $L_\varphi(G) \geq L_\varphi(G') + 8$. Then, in order to establish $\frac{C}{L_\varphi(G)} \leq \frac{5}{4}$, it suffices to argue on the residual solution in G' :

$$\frac{C - 10}{L_\varphi(G) - 8} \leq \frac{C - 10}{L_\varphi(G')} \leq \frac{5}{4}.$$

Based on this assumption, we argue by giving a procedure, which at each step removes a set of ears from F starting from pendant ears until there remains only the trivial path of length 0. It will be the case that the ratio of the cost of the removed edges with the lower bound associated to the ears (which we call the *ear ratio*) is not more than $\frac{5}{4}$, establishing the approximation ratio. In doing this, we either use (1) or the fact that a feasible dual solution is a lower bound for the optimum, thus considering a convex combination of these two lower bounds.

If there is a pendant ℓ -ear P with $\ell \neq 3$, we remove P and note that for $\ell \geq 5$, $L_\varphi(P) \geq |\Delta(P)| = \ell - 1$ by definition so that the ear ratio satisfies $\frac{\ell}{\ell-1} \leq \frac{5}{4}$. If P is a 2-ear or a 4-ear, then we have $L_\varphi(P) = |\Delta(P)| + 1 = \ell$ so that the ear ratio is 1, i.e. P is optimally covered.

If there is a pendant 3-ear P not touching any 5-ear, we remove P , this time using the value of a feasible solution to $(EC-D)$ as a lower bound. We assign $y_u = y_v = 1$ for the distinct vertices $u, v \in \Delta(P)$, and $z_{(u,v)} = 1$. Notice that this is feasible in $(EC-D)$ by Condition (1) and Condition (2): There are no edges in $E - \{(u, v)\}$ that has to be set to a value greater than 0 to maintain feasibility. Then, the total dual value induced by P is $2 + 2 - 1 = 3$, which optimally covers it.

If a pendant 3-ear P touches a 5-ear Q , then we remove Q together with all the 3-ears touching Q . By Condition (6), the set of 3-ears do not touch Q via more than 2 vertices. Consider first the case in which one of the touched vertices of Q is an end vertex of Q . Then, by Condition (7), there are two non-adjacent free vertices $u, v \in \Delta(Q)$. Assigning $y_u = y_v = 1$ in $(EC-D)$, the total dual value induced by Q is 4, and the ear ratio is $\frac{5}{4}$. The ear ratio of the removed 3-ears is 1 by the same assignment in the previous paragraph. Note that by the definition of the free vertices, we can keep the values of the edge dual variables at 0 except those of the 3-ears.

Consider now the case in which the touched vertices of Q is in $\Delta(Q)$ and the number of 3-ears touching Q , which we denote by k is at least 2. Then, we have two possible configurations that are

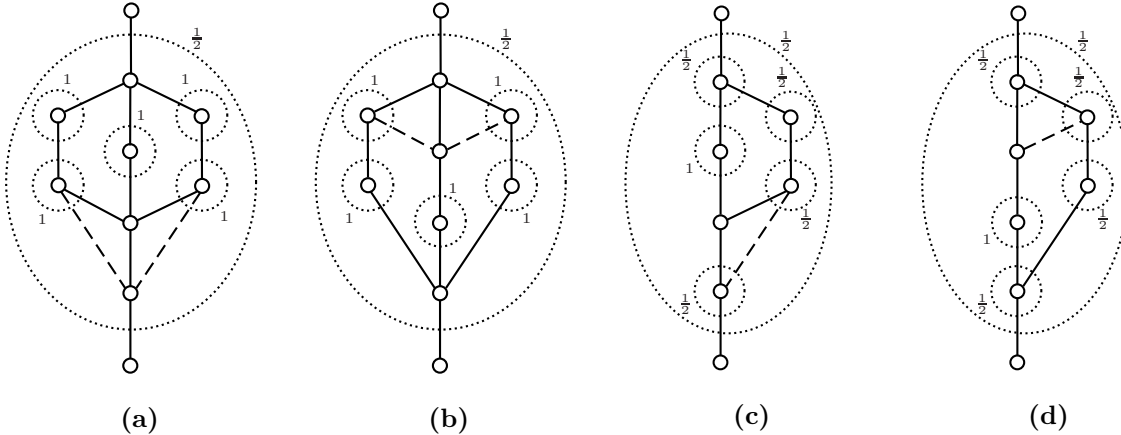

Figure 11: Configurations left out by Condition (8) and Condition (9)

not ruled out by Condition (8) and Condition (9), which are shown in Figure 11a and Figure 11b. In these figures, the edges not in F are shown using dashed lines, and the cuts corresponding to certain dual variables in $(EC-D)$ are shown using dotted lines. In both of the configurations, we use the same assignment for 3-ears as in the previous paragraph, leading to a total dual value of 3 for each. For the 5-ear Q , the free vertex whose existence is guaranteed by Condition (8) is assigned the value 1. The cut containing all the inner vertices of Q and the 3-ears is assigned the value $\frac{1}{2}$. Observe that this does not violate feasibility by Condition (9). The ratio of the total cost of the edges considered with the total dual value we have assigned then satisfies

$$\frac{3k+5}{3k+3} \leq \frac{11}{9} < \frac{5}{4}.$$

There remains the case in which the touched vertices of Q is in $\Delta(Q)$ and there is a single 3-ear P touching Q , which is depicted in Figure 11c and Figure 11d. In this case, the free vertex of Q is assigned the value 1, and the two side vertices take the value $\frac{1}{2}$. To maintain feasibility, the edge between the free vertex and one side vertex is assigned the value $\frac{1}{2}$. The inner vertices of P , and the cut containing all these vertices together with those of Q also take the value $\frac{1}{2}$. Notice that we can keep all the edge dual variables except the aforementioned one at 0 by the definition of the free vertex and the side vertices (i.e. Condition (4) and Condition (5)), together with Condition (9). The total cost of the edges is 8, whereas the total dual value is $(2 + 1 + 1 - \frac{1}{2}) + (1 + 1) + 1 = \frac{13}{2}$. The ratio satisfies $\frac{8}{13/2} = \frac{16}{13} < \frac{5}{4}$. This establishes the approximation ratio. Noting the inequality (1), the integrality gap of (EC) is also bounded by $\frac{5}{4}$, which completes the proof.

5 Tight example

A tight example for the algorithm is given in Figure 12. An optimal ear decomposition consists of a closed 10-ear together with all the $(k-2)$ 5-ears on which the algorithm does not perform any modifications. The cost of the solution returned by the algorithm is thus $5k$. An optimal solution is the Hamiltonian cycle of cost $4k+2$.

6 Final Remarks

For 2-ECSS, an optimal ear decomposition already gives a $\frac{3}{2}$ -approximation algorithm: In the argument we have used for the proof of Theorem 1, the ear ratio for a 3-ear is $\frac{3}{2}$. Noting that even ears are optimally covered, in order to get a $\frac{5}{4}$ -approximation, one should reduce to the case in which we only have 5-ears. The basic idea we have introduced is that in the case of 3-ears touching 5-ears, which is the main bottleneck, we can make sure by rearranging the ears and performing certain improvements, that there are enough free vertices to yield a large value for the dual of the natural LP relaxation. It is an important question if it is possible to generalize this approach to the problems with metric and general costs. The approximation factors $\frac{3}{2}$ and 2 in these cases, respectively, have resisted improvement over several decades. This would possibly involve a more general lower bound about ear decompositions as our approach gives a hint that using the LP relaxation alone might not be enough.

Acknowledgment

We would like to thank Christoph Hunkenschroder and Jens Vygen for giving information about the status of 2-ECSS.

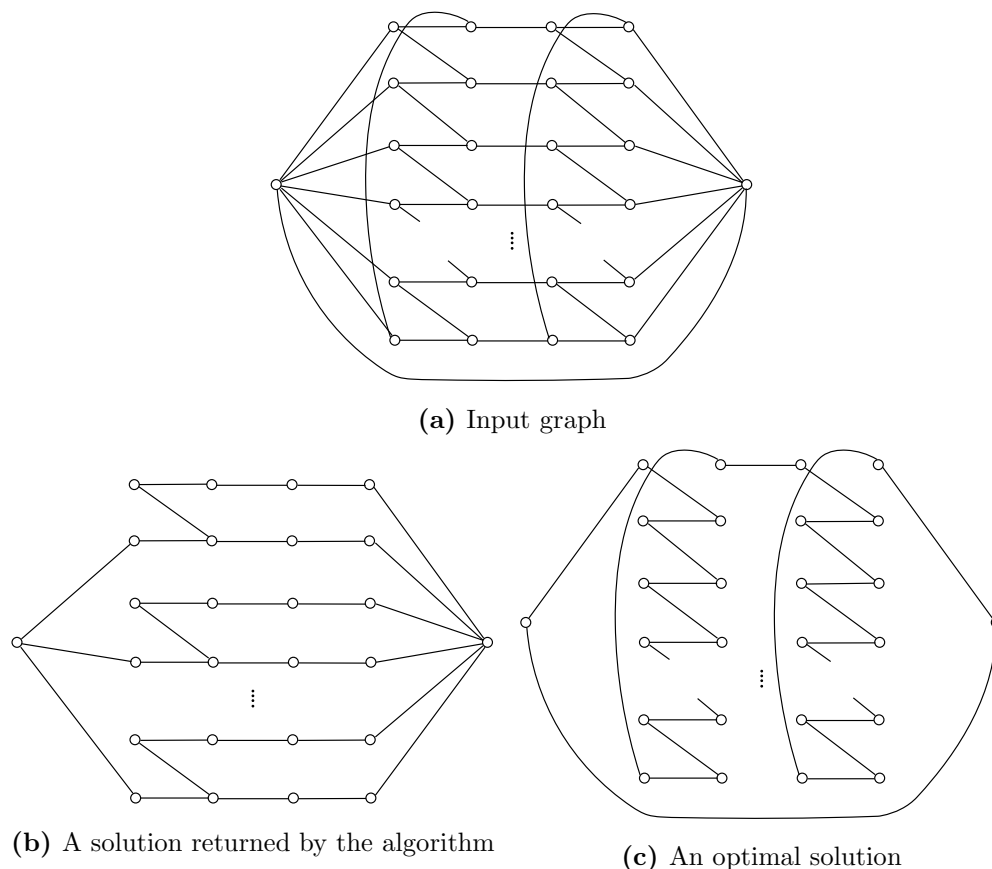

Figure 12: A tight example for the algorithm

References

- [1] S. C. Boyd, Y. Fu, and Y. Sun. A $5/4$ -approximation for subcubic 2EC using circulations and obliged edges. *Discrete Applied Mathematics*, 209:48–58, 2016.
- [2] J. Cheriyan, A. Sebö, and Z. Szigeti. Improving on the 1.5-approximation of a smallest 2-edge connected spanning subgraph. *SIAM J. Discrete Math.*, 14(2):170–180, 2001.
- [3] B. Csaba, M. Karpinski, and P. Krysta. Approximability of dense and sparse instances of minimum 2-connectivity, TSP and path problems. In *Proceedings of the Thirteenth Annual ACM-SIAM Symposium on Discrete Algorithms (SODA)*, pages 74–83, 2002.
- [4] A. Frank. Conservative weightings and ear-decompositions of graphs. *Combinatorica*, 13(1):65–81, 1993.
- [5] C. Hunkenschröder, S. Vempala, and A. Vetta. A $4/3$ -approximation algorithm for the minimum 2-edge connected subgraph problem. *ACM Trans. Algorithms*, 15(4):55:1–55:28, 2019.
- [6] R. Jothi, B. Raghavachari, and S. Varadarajan. A $5/4$ -approximation algorithm for minimum 2-edge-connectivity. In *Proceedings of the Fourteenth Annual ACM-SIAM Symposium on Discrete Algorithms (SODA)*, pages 725–734, 2003.
- [7] S. Khuller and U. Vishkin. Biconnectivity approximations and graph carvings. *J. ACM*, 41(2):214–235, 1994.

- [8] P. Krysta and V. S. A. Kumar. Approximation algorithms for minimum size 2-connectivity problems. In *18th Annual Symposium on Theoretical Aspects of Computer Science (STACS)*, pages 431–442, 2001.
- [9] A. Sebö and J. Vygen. Shorter tours by nicer ears: $7/5$ -approximation for the graph-TSP, $3/2$ for the path version, and $4/3$ for two-edge-connected subgraphs. *Combinatorica*, 34(5):597–629, 2014.
- [10] S. Vempala and A. Vetta. Factor $4/3$ approximations for minimum 2-connected subgraphs. In *Approximation Algorithms for Combinatorial Optimization, Third International Workshop (APPROX)*, pages 262–273, 2000.
- [11] H. Whitney. Nonseparable and planar graphs. *Trans. Amer. Math. Soc.*, 34:339–362, 1932.