

An algebraic axiomatisation of ZX-calculus

Quanlong Wang
University of Oxford
Cambridge Quantum Computing Ltd.

Abstract

In this paper we give an algebraic complete axiomatisation of ZX-calculus in the sense that there are only ring operations involved for phases, without any need of trigonometry functions such as \sin and \cos , in contrast to previous universally complete axiomatisations of ZX-calculus. With this algebraic axiomatisation of ZX-calculus, we are able to establish an invertible translation from ZH-calculus to ZX-calculus and to derive all the ZX-translated rules of ZH-calculus. As a consequence, we have a great benefit that all techniques obtained in ZH-calculus can be transplanted to ZX-calculus.

1 Introduction

The ZX-calculus was introduced by Coecke and Duncan [4] as a graphical language for quantum computing, based on the framework of compact closed categories. The core part of ZX-calculus is a pair of spiders (complementary observables) with strong complementarity [5]. The ZX-calculus can also be seen as a form of PROP [12], thus it is usually presented by generators and rewriting rules.

There are three important properties of ZX-calculus: soundness, universality and completeness. Soundness means all the ZX rewriting rules hold when interpreted by matrices. Universality means each matrix (linear map between finite dimensional Hilbert Spaces) can be represented by a ZX diagram. Finally, completeness means each diagrammatic equality can be derived from ZX rules if their corresponding matrix equality holds in finite dimensional Hilbert Spaces. The soundness and universality of ZX-calculus have been proved in [4]. The universal completeness of ZX-calculus (which means ZX-calculus is complete for the full pure qubit quantum mechanics instead of any part of it) was first given in [14] and then incorporated in [8]. The feature of this complete axiomatisation is that it has two new generators: the λ box and the triangle symbol (which first appeared in [9] as a short notation for some diagram composed of mere green and red nodes). Based on some results in [14], there came another universal complete axiomatisation of ZX-calculus [10] with only traditional generators as given in [4]. Thereafter, two more universal complete axiomatisations of ZX-calculus were presented [11], [15]. All of these universal complete axiomatisations of ZX-calculus have some non-algebraic rule involved with trigonometry functions such as \sin or \cos , which make such rule inconvenient for application purpose.

In this paper we give a new complete axiomatisation of ZX-calculus with purely algebraic rules, in the sense that there are only ring operations involved for phases. We obtain the completeness by deriving all the rules in [8] from this new set of algebraic rules. Furthermore, we give a simple translation from ZH-calculus [1] to ZX-calculus. Via this translation, we are able to derive all the ZX-translated ZH rules from the algebraic ZX rules. As a consequence, we have a great benefit that all techniques obtained in ZH-calculus can be transplanted to ZX-calculus.

2 Algebraic axiomatisation of ZX-calculus

The ZX-calculus is based on a compact closed PROP [12], which is a strict symmetric monoidal category whose objects are generated by one object, with a compact structure [6] as well. Each PROP can be described as a presentation in terms of generators and relations [3].

First we give the generators of ZX-calculus in the following table. Note that all the diagrams in this paper should be read from top to bottom.

$R_{Z,a}^{(n,m)} : n \rightarrow m$		
$H : 1 \rightarrow 1$		$\sigma : 2 \rightarrow 2$
$I : 1 \rightarrow 1$		$e : 0 \rightarrow 0$
$C_a : 0 \rightarrow 2$		$C_u : 2 \rightarrow 0$
$T : 1 \rightarrow 1$		$T^{-1} : 1 \rightarrow 1$

Table 1: Generators of ZX-calculus, where $m, n \in \mathbb{N}$, $a \in \mathbb{C}$, and e represents an empty diagram.

Also we define some diagrams as follows:

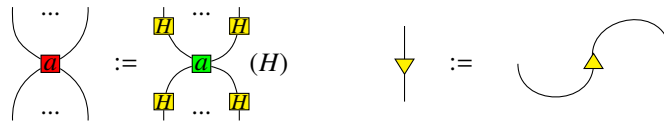

For simplicity, we make the following conventions:

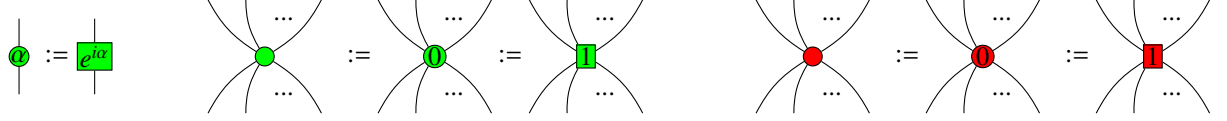

There is a standard interpretation $\llbracket \cdot \rrbracket$ for the ZX diagrams:

$$\llbracket \begin{array}{c} \overbrace{\quad\quad\quad}^n \\ \dots \\ \text{---} \\ \dots \\ \underbrace{\quad\quad\quad}_m \end{array} \rrbracket = |0\rangle^{\otimes m} \langle 0|^{\otimes n} + a |1\rangle^{\otimes m} \langle 1|^{\otimes n},$$

$$\llbracket \begin{array}{c} \overbrace{\quad\quad\quad}^n \\ \dots \\ \text{---} \\ \dots \\ \underbrace{\quad\quad\quad}_m \end{array} \rrbracket = |+\rangle^{\otimes m} \langle +|^{\otimes n} + a |-\rangle^{\otimes m} \langle -|^{\otimes n},$$

$$\llbracket \begin{array}{|c|} \hline \text{---} \\ \hline \end{array} \rrbracket = \frac{1}{\sqrt{2}} \begin{pmatrix} 1 & 1 \\ 1 & -1 \end{pmatrix}, \quad \llbracket \begin{array}{c} \vdots \\ \vdots \\ \vdots \\ \vdots \end{array} \rrbracket = 1, \quad \llbracket \begin{array}{|c|} \hline \text{---} \\ \hline \end{array} \rrbracket = \begin{pmatrix} 1 & 0 \\ 0 & 1 \end{pmatrix},$$

$$\llbracket \begin{array}{c} \text{---} \\ \text{---} \end{array} \rrbracket = \begin{pmatrix} 1 & 0 & 0 & 0 \\ 0 & 0 & 1 & 0 \\ 0 & 1 & 0 & 0 \\ 0 & 0 & 0 & 1 \end{pmatrix}, \quad \llbracket \begin{array}{c} \text{---} \\ \text{---} \end{array} \rrbracket = \begin{pmatrix} 1 \\ 0 \\ 0 \\ 1 \end{pmatrix}, \quad \llbracket \begin{array}{c} \text{---} \\ \text{---} \end{array} \rrbracket = (1 \ 0 \ 0 \ 1),$$

$$\llbracket D_1 \otimes D_2 \rrbracket = \llbracket D_1 \rrbracket \otimes \llbracket D_2 \rrbracket, \quad \llbracket D_1 \circ D_2 \rrbracket = \llbracket D_1 \rrbracket \circ \llbracket D_2 \rrbracket,$$

where

$$|0\rangle = \begin{pmatrix} 1 \\ 0 \end{pmatrix}, \quad \langle 0| = (1 \ 0), \quad |1\rangle = \begin{pmatrix} 0 \\ 1 \end{pmatrix}, \quad \langle 1| = (0 \ 1),$$

$$|+\rangle = \frac{1}{\sqrt{2}} \begin{pmatrix} 1 \\ 1 \end{pmatrix}, \quad \langle +| = \frac{1}{\sqrt{2}} (1 \ 1), \quad |-\rangle = \frac{1}{\sqrt{2}} \begin{pmatrix} 1 \\ -1 \end{pmatrix}, \quad \langle -| = \frac{1}{\sqrt{2}} (1 \ -1).$$

Now we give a purely algebraic set of rules for ZX-calculus in the sense that there are no trigonometry functions such as sin and cos involved.

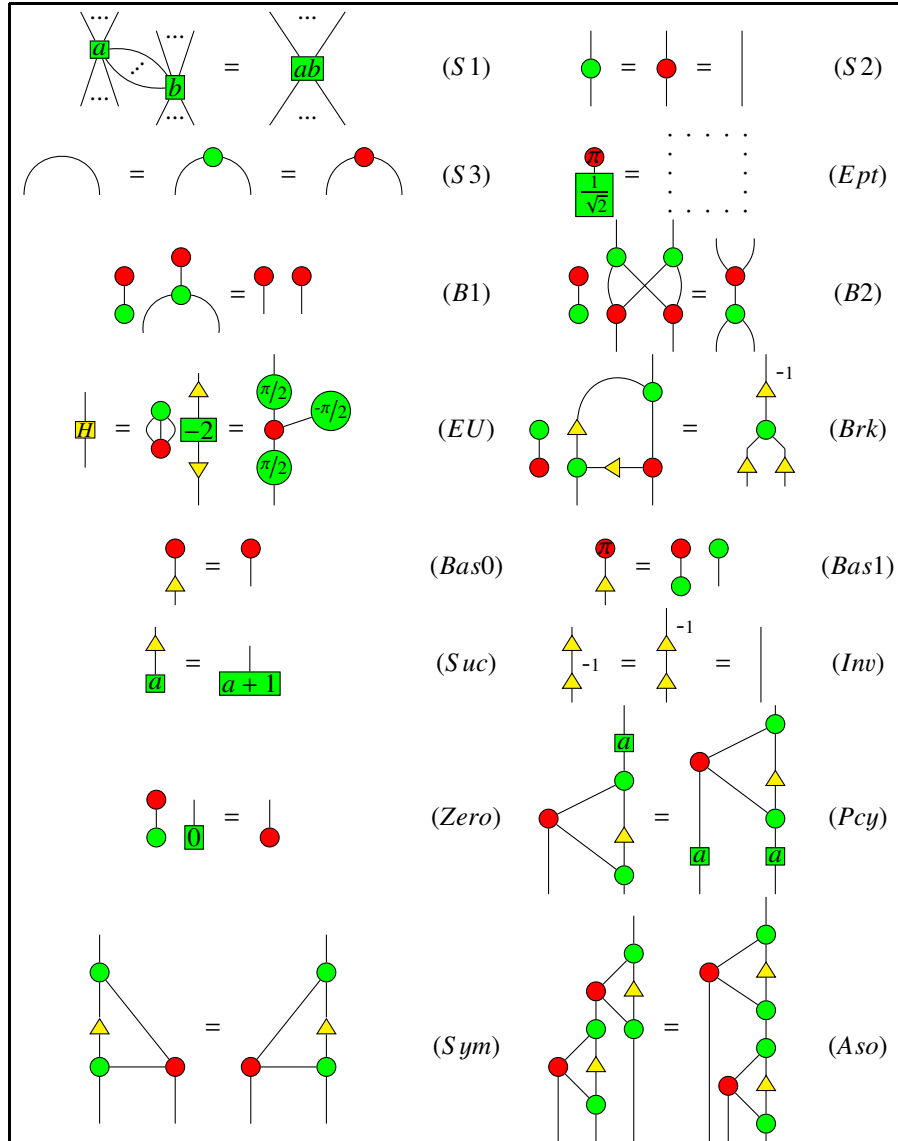

Figure 1: Algebraic rules, $a, b \in \mathbb{C}, \alpha \in [0, 2\pi)$.

It is a routine check that these rules are sound in the sense that they still hold under the standard interpretation $\llbracket \cdot \rrbracket$.

With the standard interpretation and the above rules, we can define the completeness of ZX-calculus.

Definition 2.1 The ZX-calculus is called complete if for any two diagrams D_1 and D_2 , $\llbracket D_1 \rrbracket = \llbracket D_2 \rrbracket$ must imply that $ZX \vdash D_1 = D_2$.

Below we give some useful properties following from Figure 1.

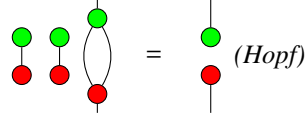
Lemma 2.2  (Hopf)

This has been proved in [2] based on rules (S1), (S2), (S3), (B1), (B2) and the definition of red spider.

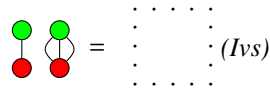
Lemma 2.3  (Ivs)

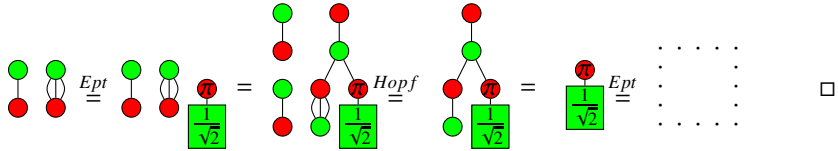
Proof:  □

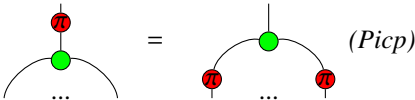
Lemma 2.4  (Picp)

This has been proved in [2] based on rules (S1), (S2), (S3), (B1), (B2) and the definition of red spider.

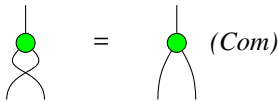
Lemma 2.5  (Com)

This has been proved in [2] based on rules (S1), (S2), (S3), (B1), (B2) and the definition of red spider.

Lemma 2.6 

Proof:  □

3 Proof of completeness

In this section, we prove that the rules in Figure 1 are complete for ZX-calculus. Since it is already proved in [8] that ZX-calculus is complete with the rules presented in Figure 2 and Figure 3, we only need to prove that all the rules in Figure 2 and 3 can be derived from rules in Figure 1.

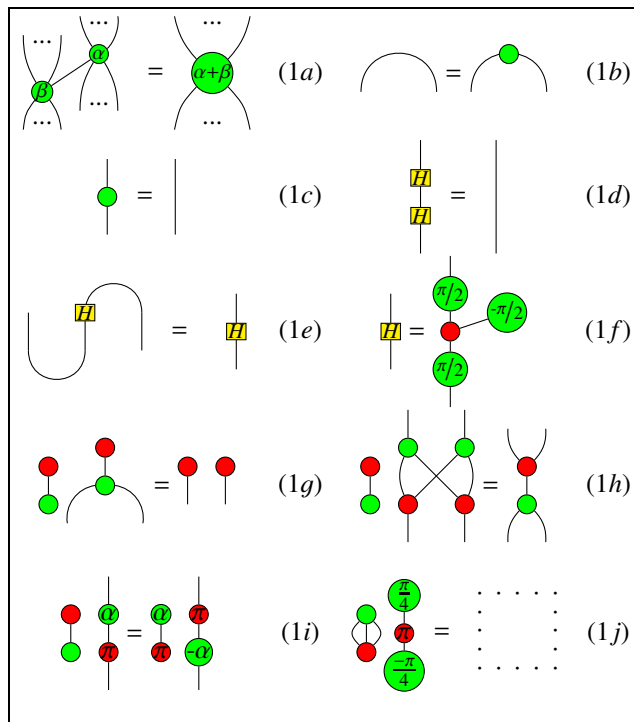

Figure 2: Previous ZX-calculus rules I, where $\alpha, \beta \in [0, 2\pi)$.

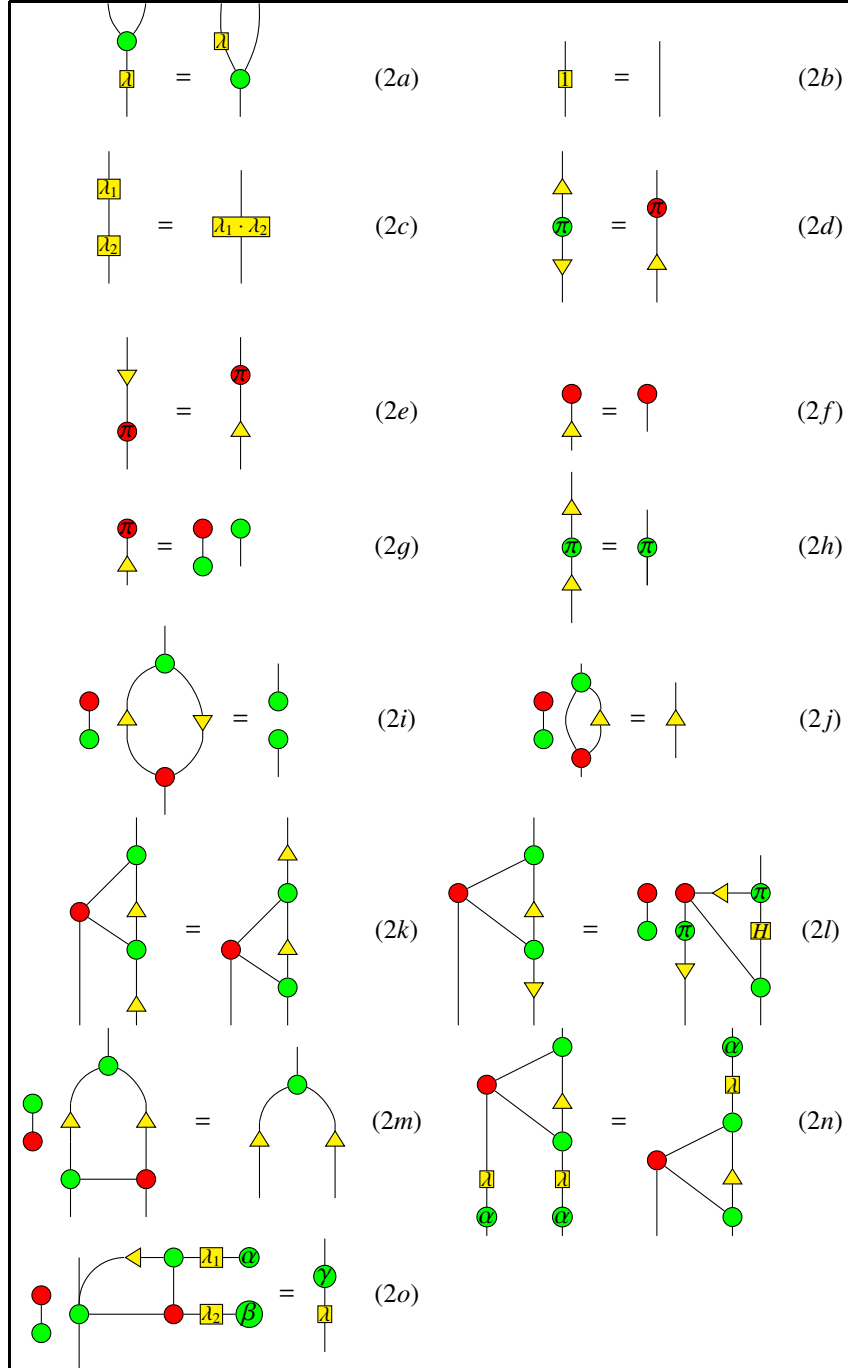
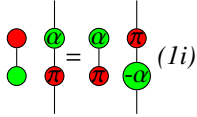
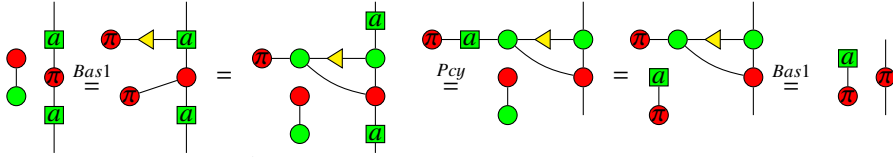

Figure 3: Previous ZX-calculus rules II, where $\lambda, \lambda_1, \lambda_2 \geq 0, \alpha, \beta, \gamma \in [0, 2\pi)$; in (AD'), $\lambda e^{i\gamma} = \lambda_1 e^{i\beta} + \lambda_2 e^{i\alpha}$.

Below we derive the rules in Figure 2 and 3 one by one.

First (1a), (1b) and (1c) follow directly from (S1), (S3) and (S2) respectively. (1d) follows clearly from (S2) and the definition of red spider. (1e) follows from (1d) and (S3). (1f) is just a part of (EU). (1g) and (1h) are exactly (B1) and (B2) respectively.

Proposition 3.1  (1i)

Proof: 

(1i) follows when setting $a = e^{i\alpha}$. □

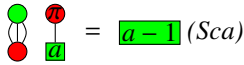
Lemma 3.2  (Sca)

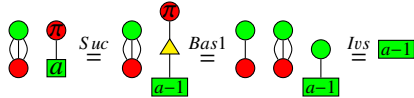
Proof: 

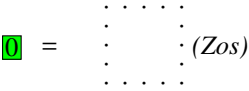
Corollary 3.3  (Zos)

Proof: Let $a = 1$ in (Sca) and use (Ivs) and Lemma 2.6. □

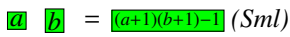
Lemma 3.4  (Sml)

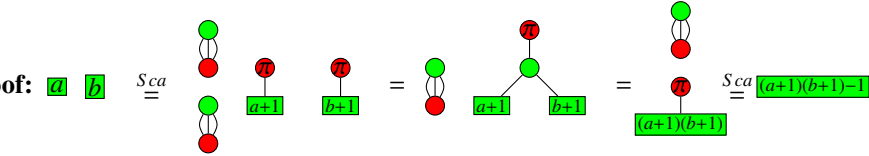
Proof: 

□

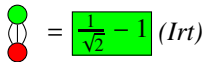
Lemma 3.5  (Irt)

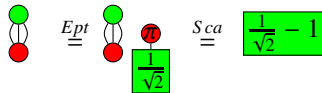

Proof: 

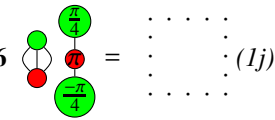
□

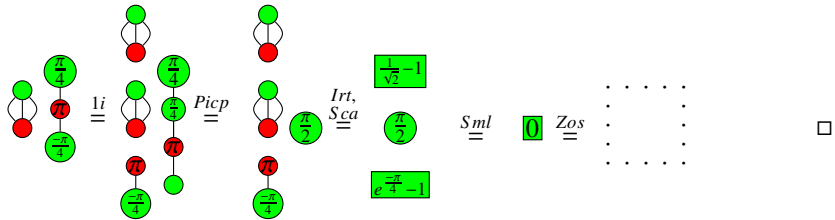
Proposition 3.6  = \dots (1j)

Proof:  \square

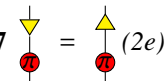
Note that $\begin{array}{|c} \square \\ \hline \square \end{array} = \begin{array}{|c} \square \\ \hline \square \end{array}$. Then (2a) and (2c) follow directly from (S1). (2b) directly follows from (S2).

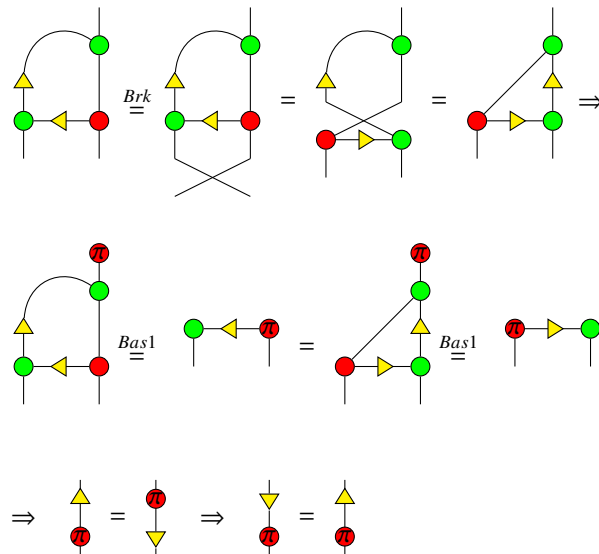

Proposition 3.7  =  (2e)

Proof:

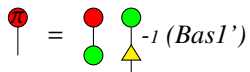

\square

(2f) and (2g) are exactly (Bas0) and (Bas1) respectively.

Lemma 3.8  =  $^{-1}$ (Bas1')

This can be directly obtained by plugging a triangle inverse on both sides of (Bas1).

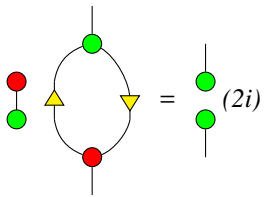
Proposition 3.9  $(2i)$

Proof:

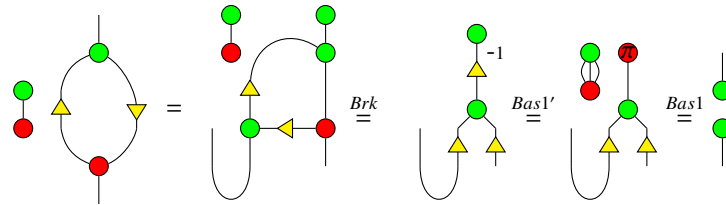

□

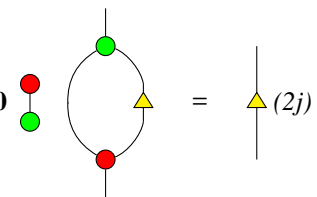
Proposition 3.10  $(2j)$

Proof:

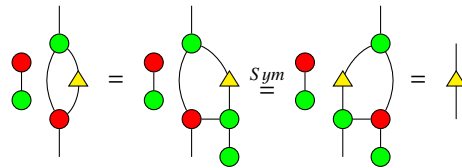

□

Corollary 3.11

 (1)

Proof:

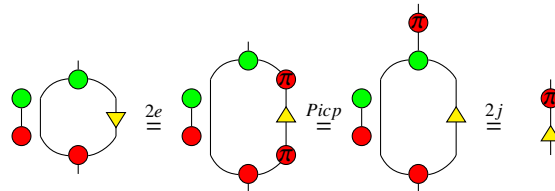

□

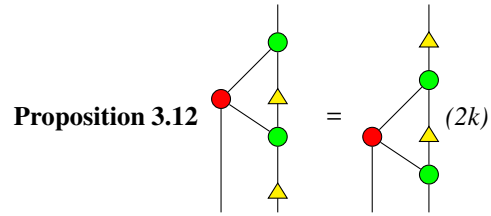

Proof:

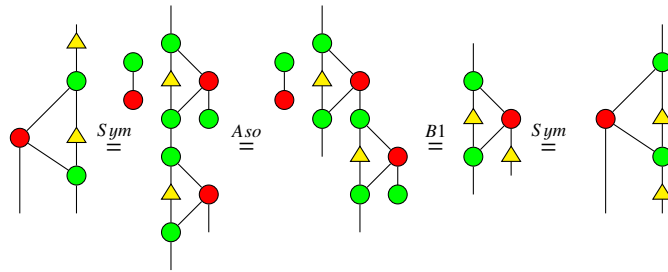

□

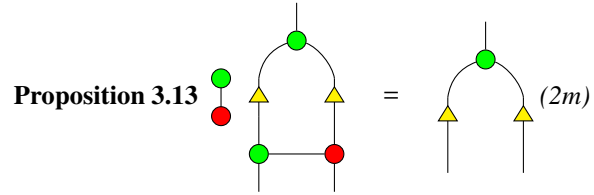

Proof:

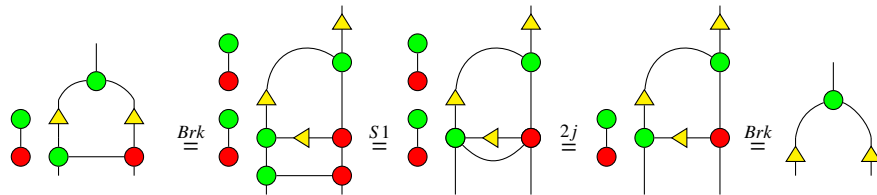

□

Corollary 3.14

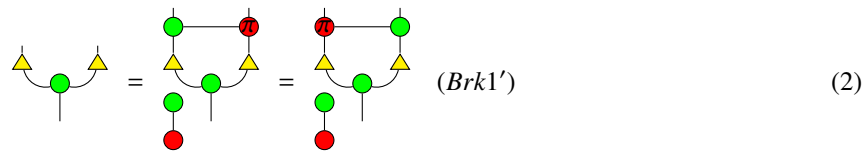

Proof:

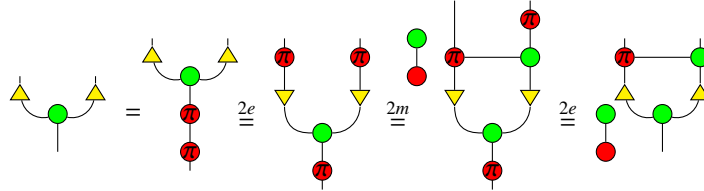

The other part can be proved by symmetry. □

(2n) is just the rule (Pcy).

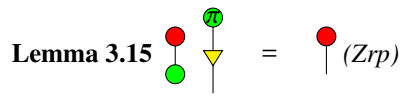

By the rule (Suc), it is clear that (Zrp) is equivalent to the rule (Zero).

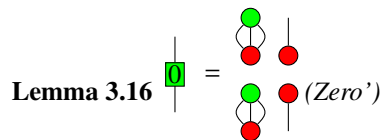

Proof:

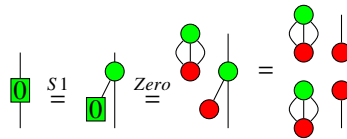

□

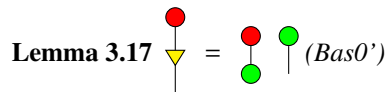

Proof:

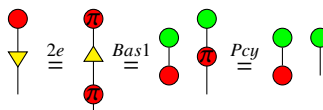

□

Lemma 3.18

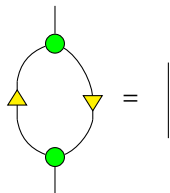

(3)

Proof:

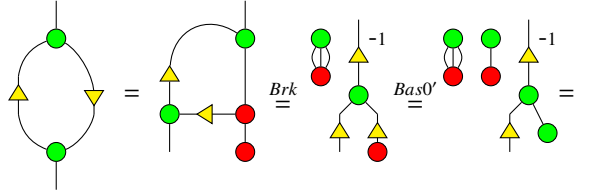

□

Lemma 3.19

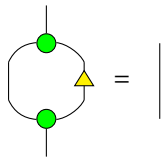

(4)

Proof:

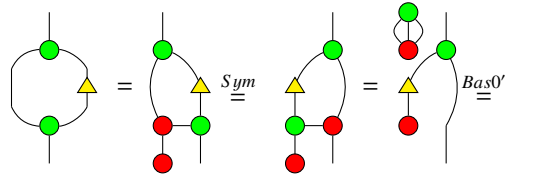

□

Lemma 3.20

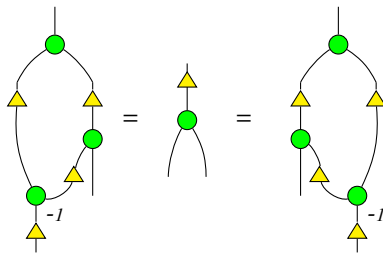

(5)

Proof:

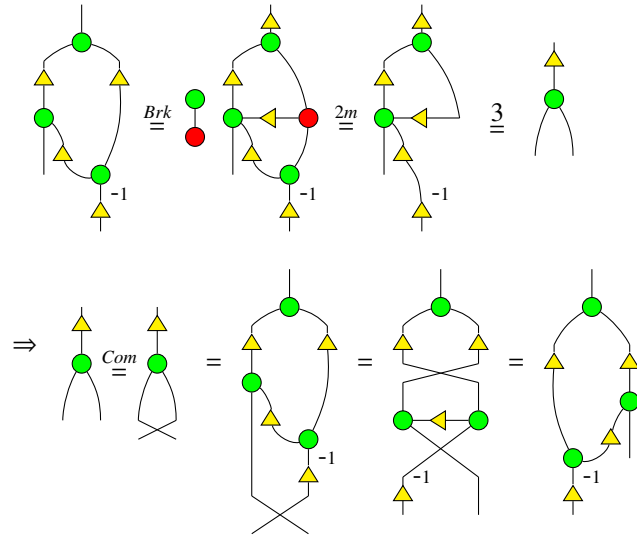

□

Lemma 3.21

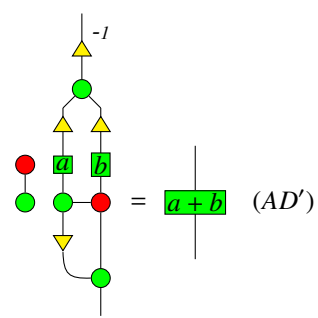

Proof: If $b \neq 0$, then

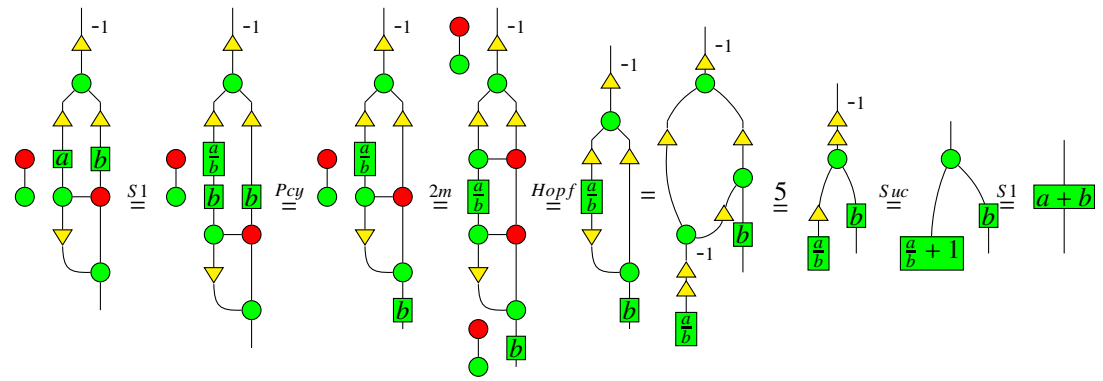

If $b = 0$, then

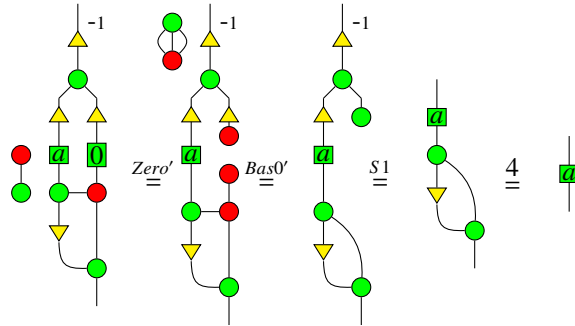

□

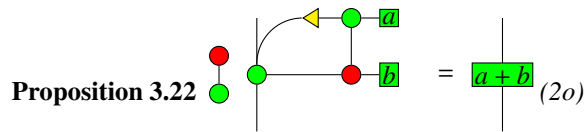

Proof:

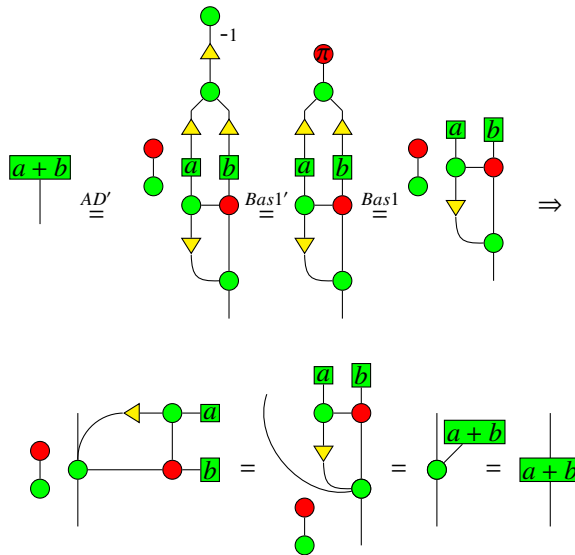

□

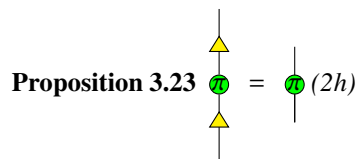

Proof:

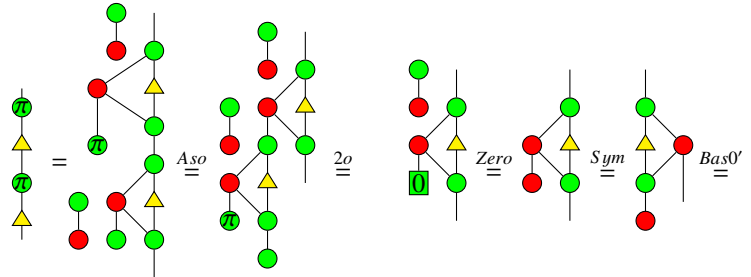

(2h) follows immediately. □

Clearly, (2h) is equivalent to $\triangleleft^{-1} = \begin{array}{c} \text{green circle} \\ \triangleleft \\ \text{green circle} \end{array}$ (IVT).

Corollary 3.24

$$\begin{array}{c} \text{red circle} \\ \triangleleft^{-1} \\ \triangleleft \end{array} = \begin{array}{c} \triangleleft^{-1} \\ \text{red circle} \end{array} \quad (6)$$

Proof:

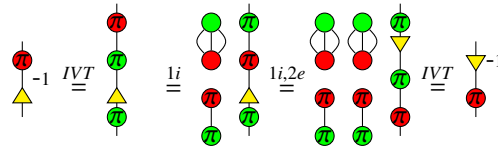

□

Proposition 3.25 $\begin{array}{c} \triangleleft \\ \text{green circle} \\ \triangleleft \end{array} = \begin{array}{c} \text{red circle} \\ \triangleleft \end{array} \quad (2d)$

Proof:

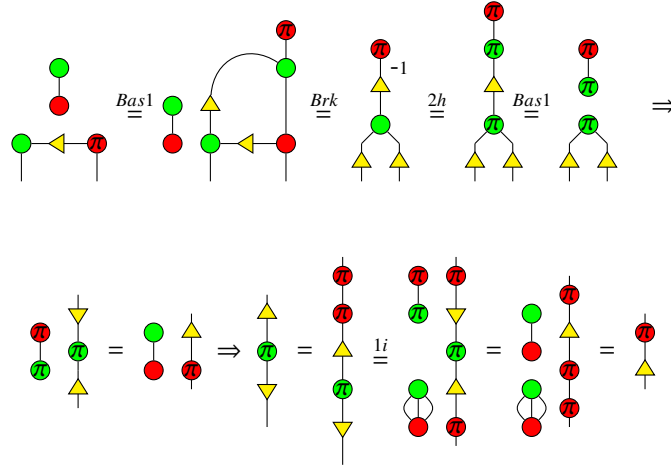

□

Lemma 3.26

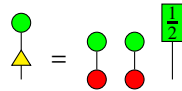

(7)

Proof:

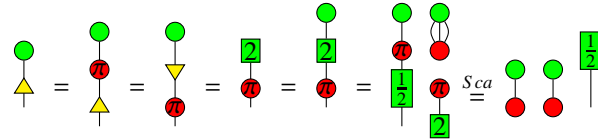

□

Lemma 3.27

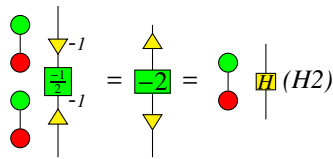

Proof:

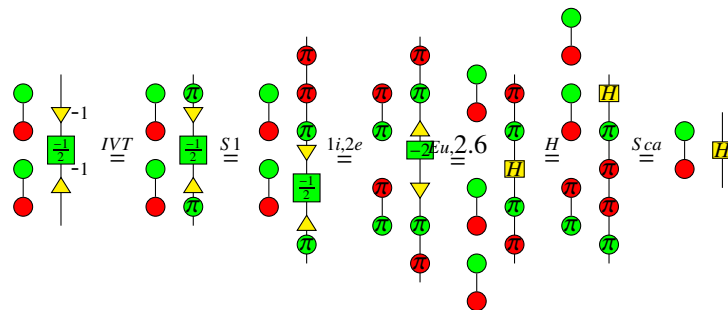

□

Lemma 3.28

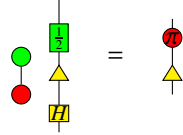

(8)

Proof:

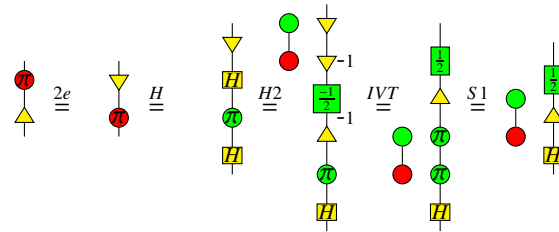

□

Proposition 3.29

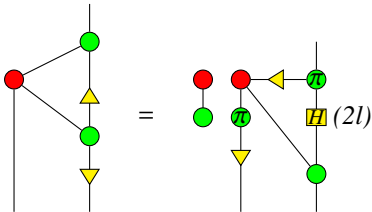

Proof:

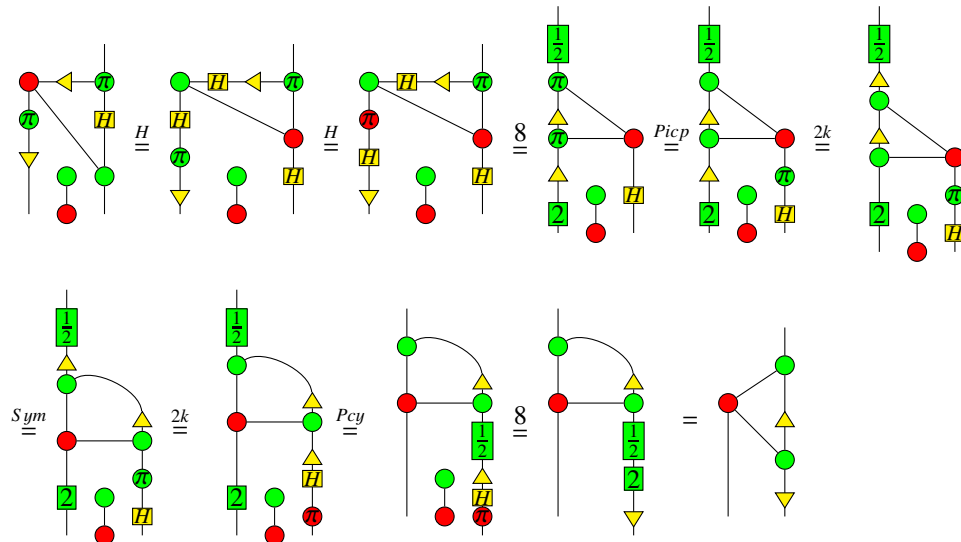

□

Now all the rules listed in Figure 2 and Figure 3 have been derived from Figure 1. So we have

Theorem 3.30 *ZX-calculus is complete for pure qubit quantum mechanics with the rules in Figure 1.*

4 From ZH-calculus to ZX-calculus

In this section, we translate ZH diagrams to ZX diagrams with the semantics preserved, then we prove that all the ZH rules translated in ZX can be derived from the ZX rules given in Figure 1.

The ZH-calculus is also based on a PROP, thus can be presented by generators and rewriting rules. First we list its generators as follows [1]:







$Z^{(n,m)} : n \rightarrow m$		$H_a^{(n,m)} : n \rightarrow m$	
$I : 1 \rightarrow 1$		$e : 0 \rightarrow 0$	
$C_a : 0 \rightarrow 2$		$C_u : 2 \rightarrow 0$	
$\sigma : 2 \rightarrow 2$			

Table 2: Generators of ZH-calculus, where $m, n \in \mathbb{N}$, $a \in \mathbb{C}$, and e represents an empty diagram.

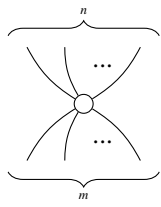
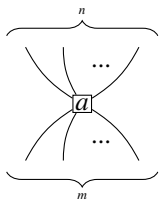
There is also a standard interpretation $[[\cdot]]$ for the ZH diagrams, here we only present the interpretation of the first two generators, as other generators are the same as that of ZX-calculus:

$$\left[\left[\begin{array}{c} \overbrace{\quad}^n \\ \dots \\ \text{dot} \\ \dots \\ \underbrace{\quad}_m \end{array} \right] \right] = |0\rangle^{\otimes m} \langle 0|^{\otimes n} + |1\rangle^{\otimes m} \langle 1|^{\otimes n},$$

$$\left[\left[\begin{array}{c} \overbrace{\quad\quad\quad}^n \\ \text{...} \\ \text{---} \\ \text{...} \\ \underbrace{\quad\quad\quad}_m \end{array} \right] \right] = \sum a^{i_1 \dots i_m j_1 \dots j_n} |i_1 \dots i_m\rangle \langle j_1 \dots j_n|.$$

It is clear that the white spider in ZH-calculus is just the phase free green spider in ZX-calculus. Thus we can give a semantics-preserving translation $\llbracket \cdot \rrbracket_{HX}$ from ZH-calculus to ZX-calculus via the translation of H-box:

$$\left[\left[\begin{array}{c} \overbrace{\quad\quad\quad}^n \\ \text{...} \\ \text{---} \\ \text{...} \\ \underbrace{\quad\quad\quad}_m \end{array} \right] \right]_{HX} = \begin{array}{c} \overbrace{\quad\quad\quad}^n \\ \text{...} \\ \text{---} \\ \text{...} \\ \underbrace{\quad\quad\quad}_m \end{array}$$

We make the convention that $\begin{array}{c} \overbrace{\quad\quad\quad}^n \\ \text{...} \\ \text{---} \\ \text{...} \\ \underbrace{\quad\quad\quad}_m \end{array} := \begin{array}{c} \overbrace{\quad\quad\quad}^n \\ \text{...} \\ \text{---} \\ \text{---} \\ \underbrace{\quad\quad\quad}_m \end{array} [1]$, then the ZH

rules is given as follows:

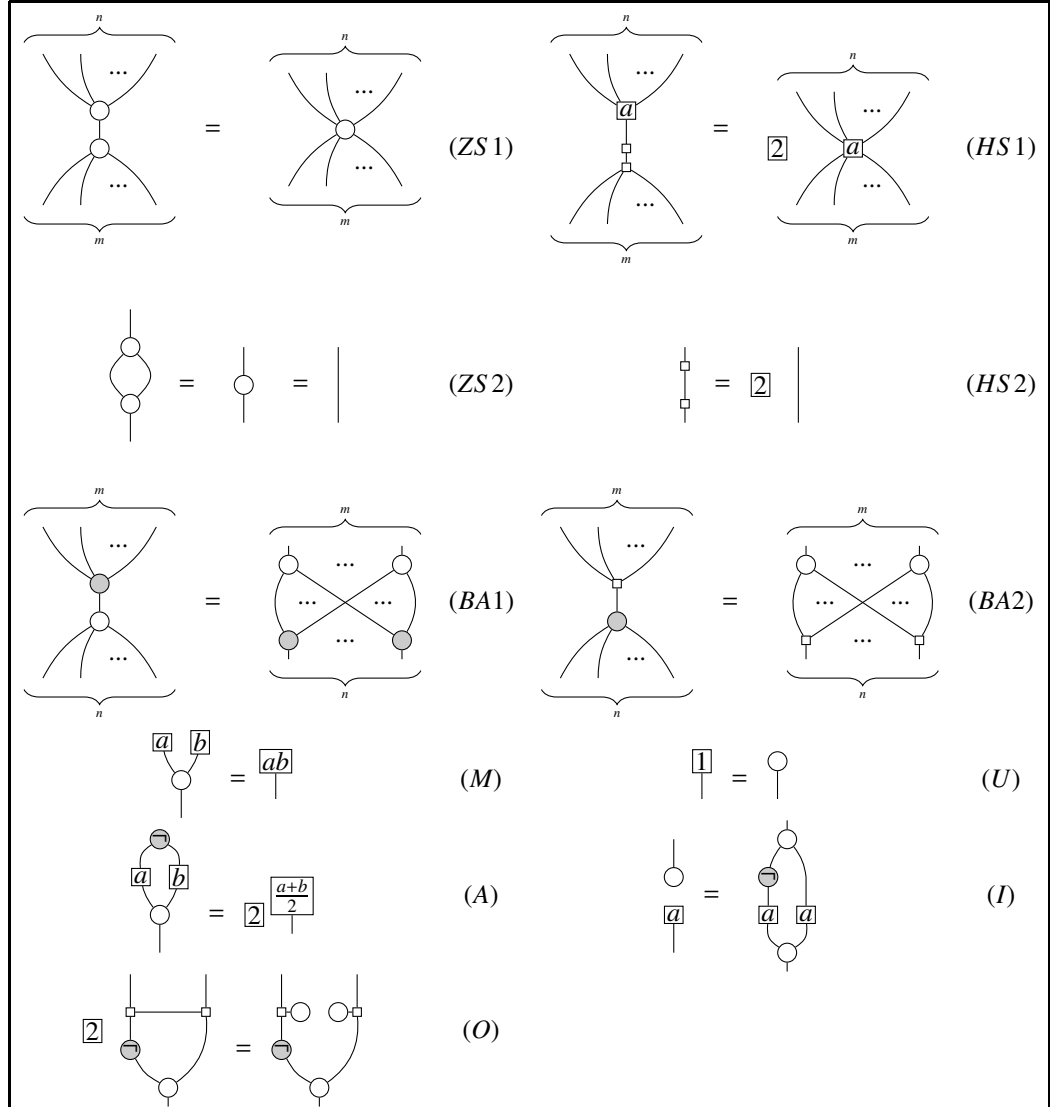
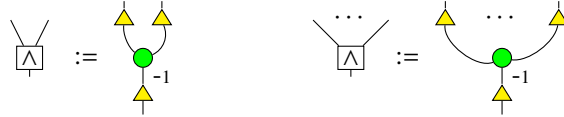

Figure 4: ZH rules, where $a, b \in \mathbb{C}$.

Now we derive the ZX-translated rules in Figure 4 from ZX rules.

The rules (ZS1), (ZS2), (M) and (U) just follow directly from the ZX rules (S1) and (S2). The rule (HS2) follows directly the ZX rule (S2) and the definition (H) of red spider. The ZH rule (BA1) is just a generalisation of the ZX rule (B2), which has been proved in ZX papers, for example [7]. Below we derive the remaining ZH rules

(HS1), (A) (I) and (O) individually. For simplicity, we use the following notation.



Lemma 4.1

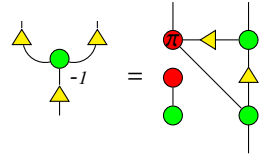

Proof:

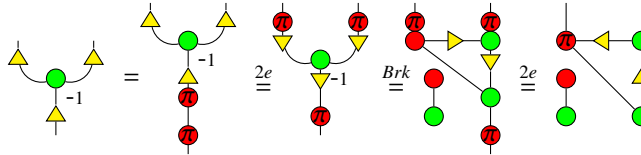

□

Lemma 4.2

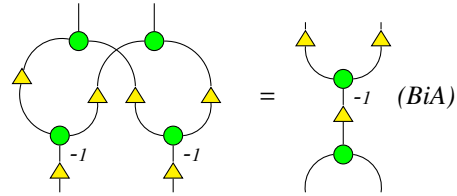

Proof:

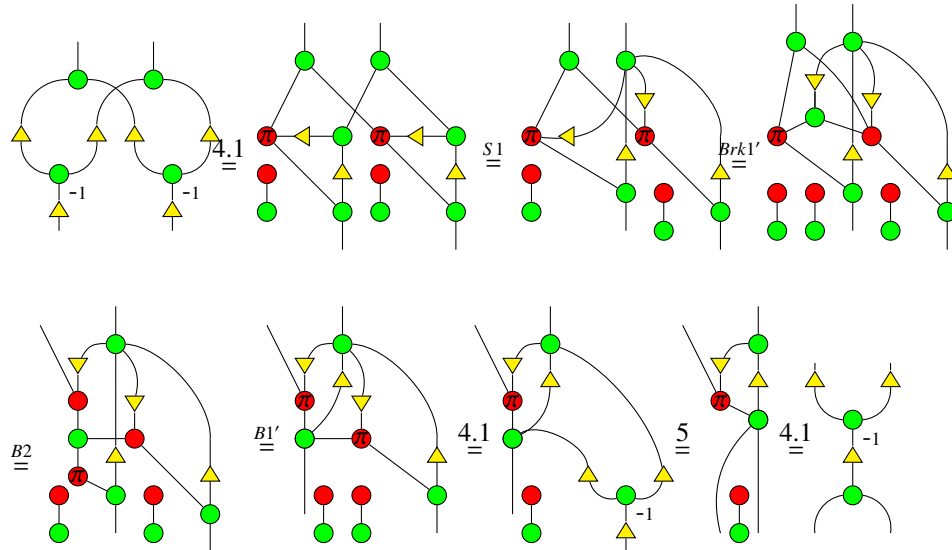

□

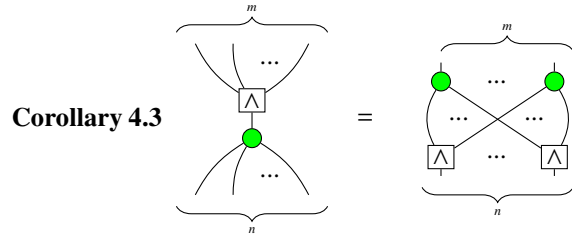

This can be proved by induction, see (L1) in [13].

Note that

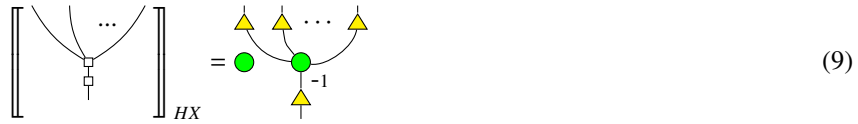

Proof:

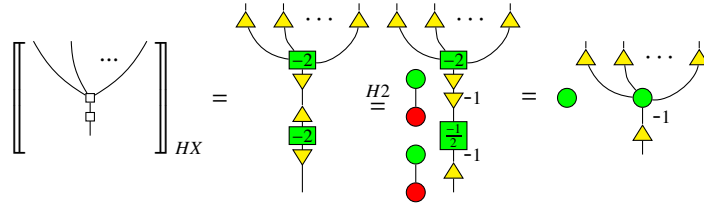

□

Then it is clear that the ZH rule (BA2) follows directly from equation 9 and Corollary 4.3.

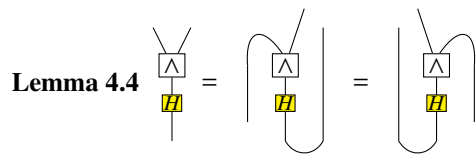

Proof:

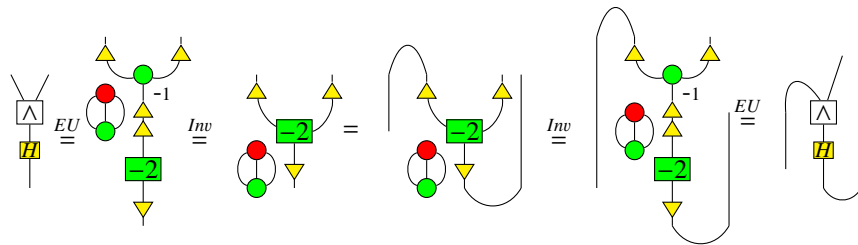

The other equality can be obtained by symmetry. □

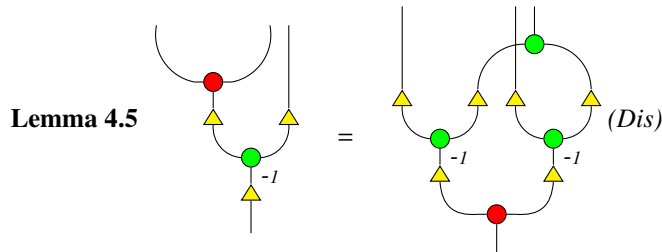

Proof:

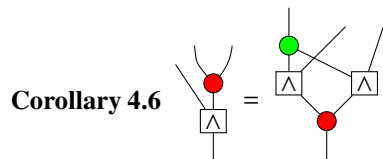
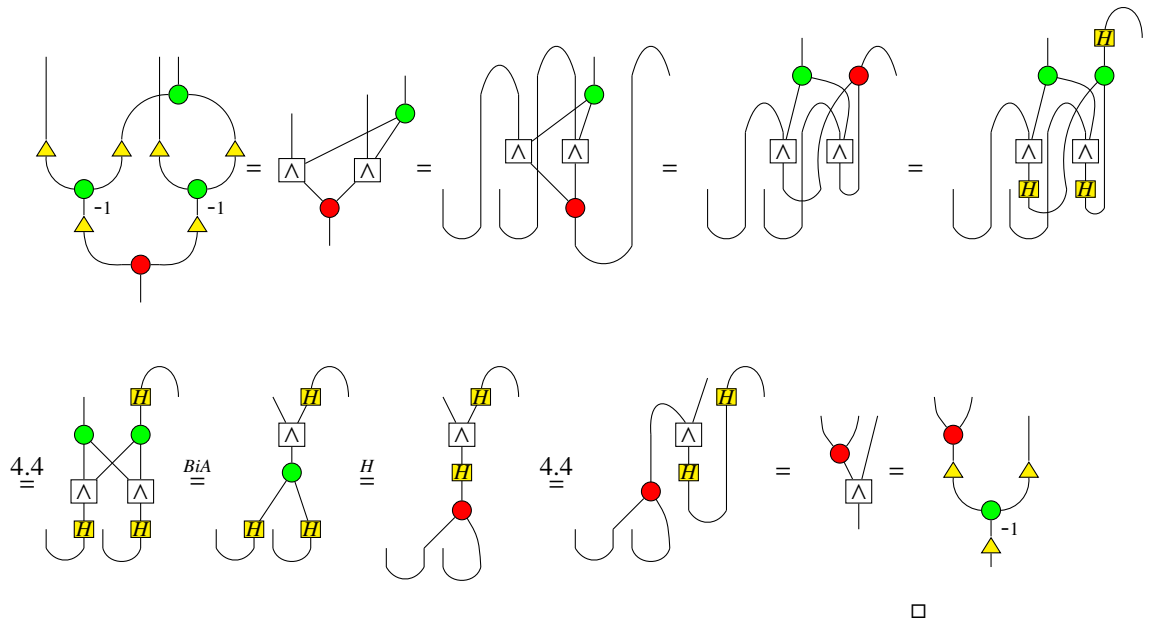

Proof:

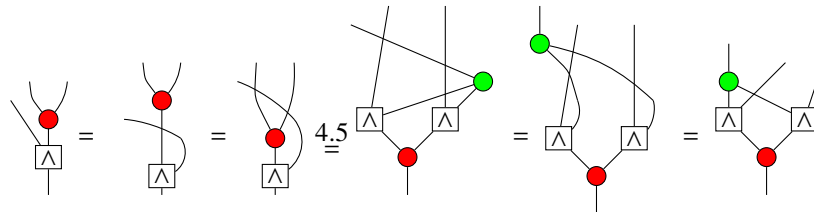

□

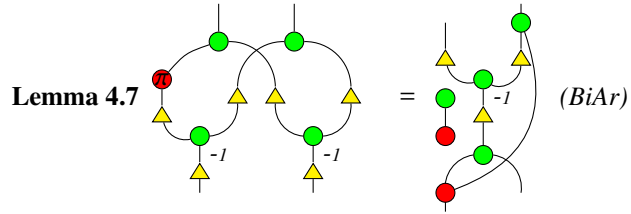

Proof:

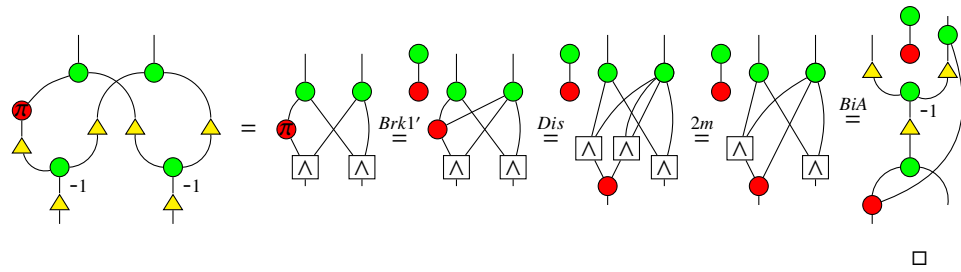

Proposition 4.8 (Derivation of (HS1))

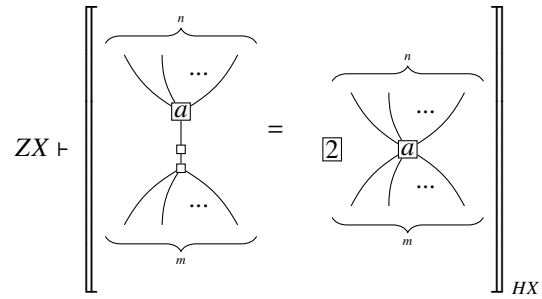

Proof:

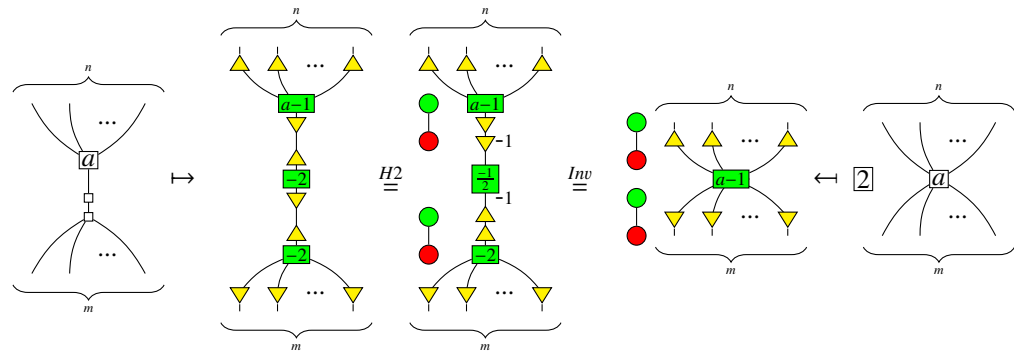

□

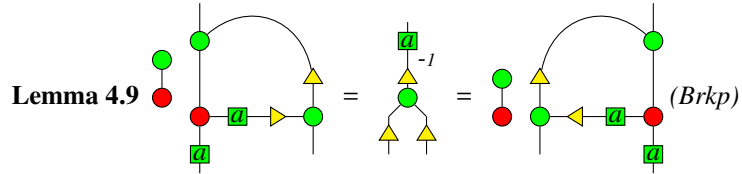
Lemma 4.9 

Proof:

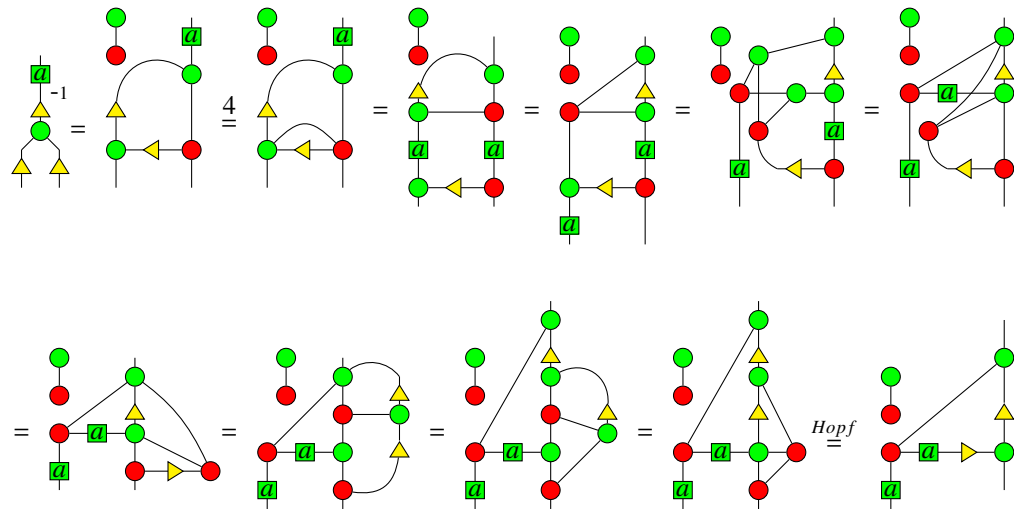

Therefore,

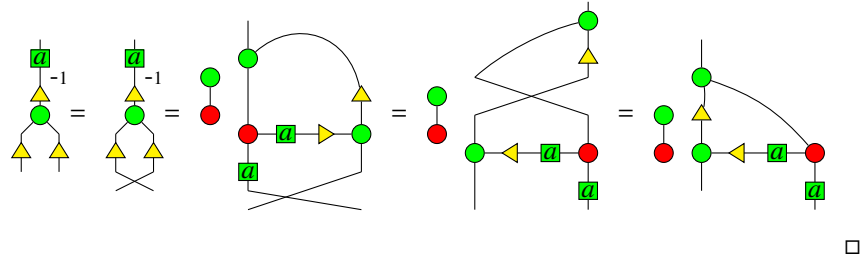

□

Proposition 4.10 (Derivation of (A))

$$ZX \vdash \left[\begin{array}{c} \text{Diagram with two circles and boxes } a, b \end{array} \right] = \left[\begin{array}{c} \text{Diagram with a box } \frac{a+b}{2} \end{array} \right]_{HX}$$

Proof: First we have

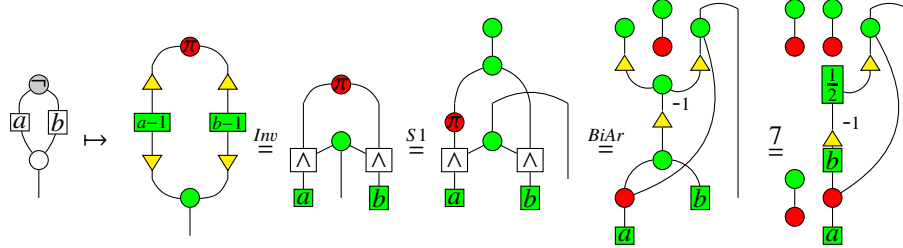

If $b = 0$, then

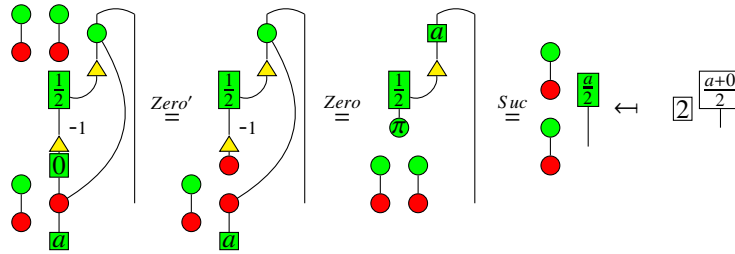

If $b \neq 0$, then we have

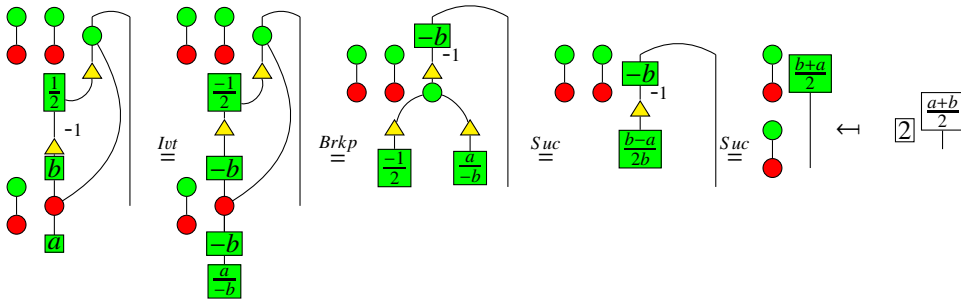

□

Proposition 4.11 (Derivation of (I))

$$ZX \vdash \left[\begin{array}{c} | \\ \circ \\ | \\ \hline a \\ | \end{array} \right] = \left[\begin{array}{c} | \\ \circ \\ | \\ \hline a \quad a \\ | \end{array} \right]_{HX}$$

Proof:

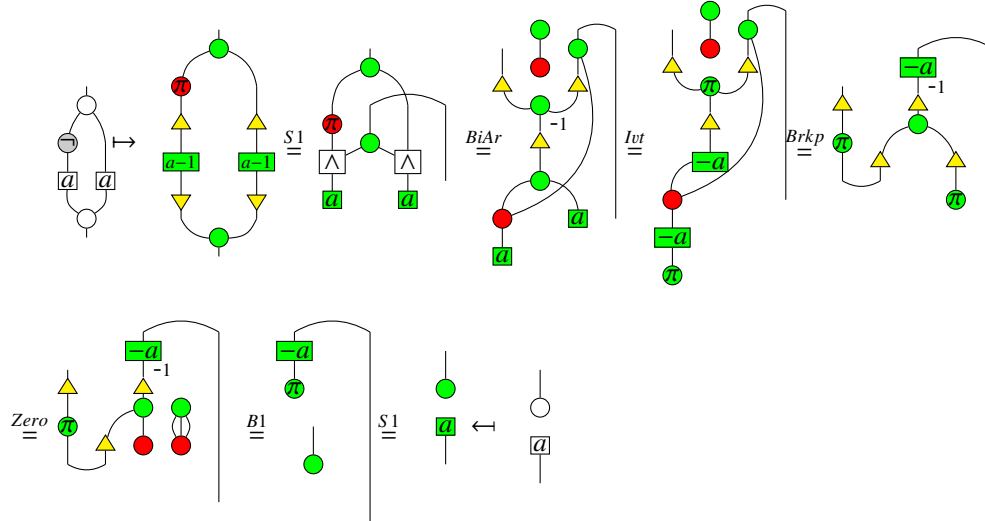

□

Proposition 4.12 (Derivation of (O))

$$ZX \vdash \left[\begin{array}{c} \text{Diagram 1} \\ \text{Diagram 2} \end{array} \right] = \left[\begin{array}{c} \text{Diagram 3} \\ \text{Diagram 4} \end{array} \right]_{HX}$$

Proof:

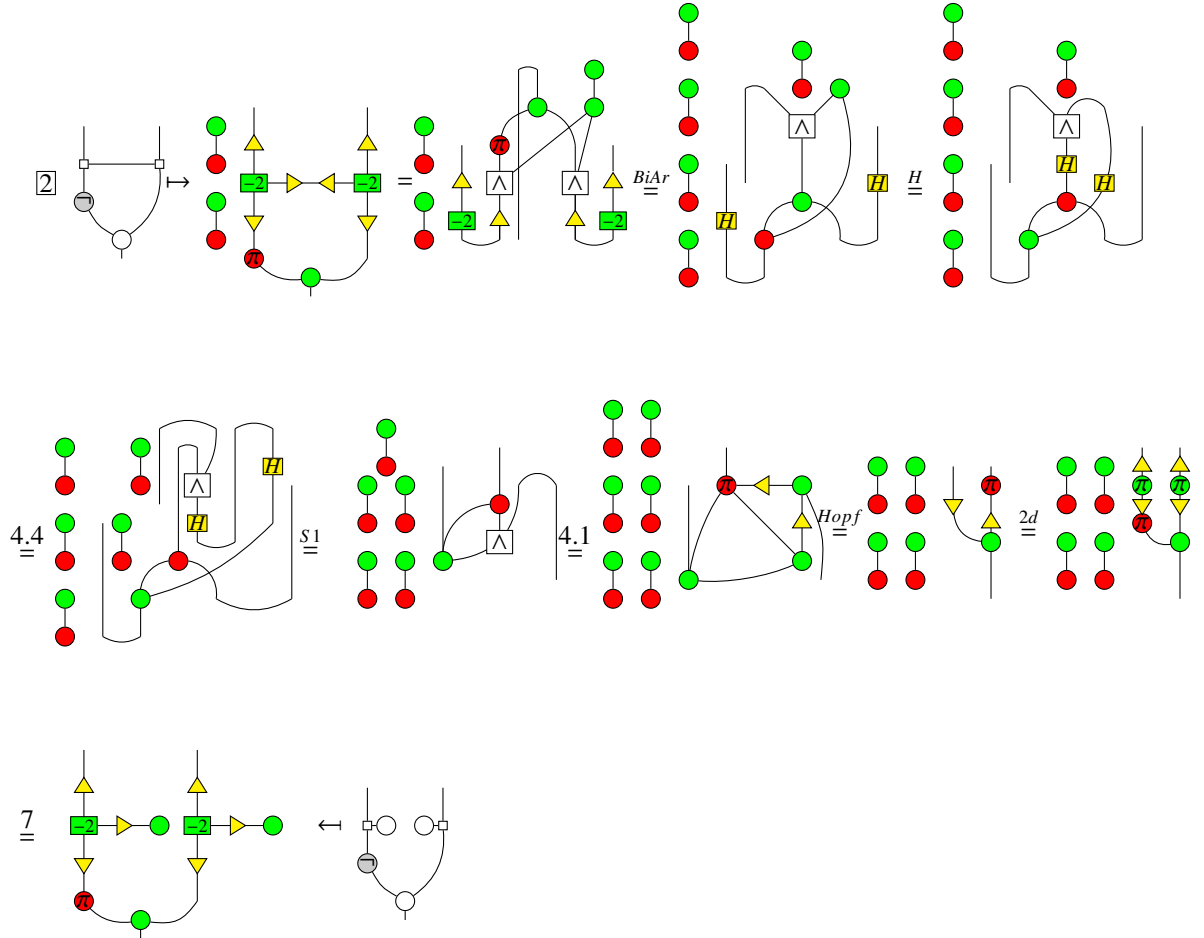

□

To sum up, we have

Theorem 4.13 *All the ZX-translated ZH rules can be derived from ZX rules.*

Acknowledgements

This work is supported by AFOSR grant FA2386-18-1-4028. The author would like to thank Aleks Kissinger for showing him the proof of the distribution rule in ZH-calculus. The author thanks Bob Coecke, Niel de Beaudrap and Konstantinos Meichanetzidis for useful discussions on the title of this paper.

References

- [1] Miriam Backens & Aleks Kissinger (2018): ZH: A Complete Graphical Calculus for Quantum Computations Involving Classical Non-linearity. In: *Proceedings of the 15th International Workshop on Quantum Physics and Logic, QPL 2018, Halifax, Canada, 3-7th June 2018.*, pp. 23–42. doi:10.4204/EPTCS.287.2.
- [2] Miriam Backens, Simon Perdrix & Quanlong Wang (2017): A Simplified Stabilizer ZX-calculus. *EPTCS* 236, pp. 1–20. doi:10.4204/EPTCS.236.1.
- [3] John C. Baez, Brandon Coya & Franciscus Rebro (2017): Props in Network Theory. arXiv:1707.08321.
- [4] Bob Coecke & Ross Duncan (2011): Interacting quantum observables: categorical algebra and diagrammatics. *New Journal of Physics* 13(4), p. 043016. Available at <http://stacks.iop.org/1367-2630/13/i=4/a=043016>. doi:10.1088/1367-2630/13/4/043016.
- [5] Bob Coecke, Ross Duncan, Aleks Kissinger & Quanlong Wang (2012): Strong Complementarity and Non-locality in Categorical Quantum Mechanics. In: *Proceedings of the 2012 27th Annual IEEE/ACM Symposium on Logic in Computer Science, LICS '12*, IEEE Computer Society, pp. 245–254. doi:10.1109/LICS.2012.35.
- [6] Bob Coecke & Aleks Kissinger (2017): Picturing quantum processes. Cambridge University Press.
- [7] Ross Duncan & Simon Perdrix (2009): Graph States and the Necessity of Euler Decomposition. *Mathematical Theory and Computational Practice* 5635, pp. 167–177. doi: 10.1007/978-3-642-03073-4_18.
- [8] Amar Hadzahasanovic, Kang Feng Ng & Quanlong Wang (2018): Two Complete Axiomatisations of Pure-state Qubit Quantum Computing. In: *Proceedings of the 33rd Annual ACM/IEEE Symposium on Logic in Computer Science, LICS '18*, ACM, pp. 502–511. doi:10.1145/3209108.3209128.
- [9] Emmanuel Jeandel, Simon Perdrix & Renaud Vilmart (2018): A Complete Axiomatisation of the ZX-Calculus for Clifford+T Quantum Mechanics. In: *Proceedings of the 33rd Annual ACM/IEEE Symposium on Logic in Computer Science, LICS '18*, ACM, New York, NY, USA, pp. 559–568, doi:10.1145/3209108.3209131. Available at <http://doi.acm.org/10.1145/3209108.3209131>.
- [10] Emmanuel Jeandel, Simon Perdrix & Renaud Vilmart (2018): Diagrammatic Reasoning Beyond Clifford+T Quantum Mechanics. In: *Proceedings of the 33rd Annual ACM/IEEE Symposium on Logic in Computer Science, LICS '18*, ACM, New York, NY,

USA, pp. 569–578, doi:10.1145/3209108.3209139. Available at <http://doi.acm.org/10.1145/3209108.3209139>.

- [11] Emmanuel Jeandel, Simon Perdrix & Renaud Vilmart (2019): A Generic Normal Form for ZX-Diagrams and Application to the Rational Angle Completeness. In: *34th Annual ACM/IEEE Symposium on Logic in Computer Science, LICS 2019, Vancouver, BC, Canada, June 24-27, 2019*, pp. 1–10, doi:10.1109/LICS.2019.8785754. Available at <https://doi.org/10.1109/LICS.2019.8785754>.
- [12] Saunders MacLane (1965): Categorical algebra. *Bulletin of the American Mathematical Society* 71(1), pp. 40–106. <https://projecteuclid.org:443/euclid.bams/1183526392>.
- [13] Anthony Munson, Bob Coecke & Quanlong Wang (2017): A note on AND-gates in ZX-calculus: QBC-completeness and phase gadgets. ArXiv:1910.06818.
- [14] Kang Feng Ng & Quanlong Wang (2017): A universal completion of the ZX-calculus. ArXiv:1706.09877.
- [15] Renaud Vilmart (2019): A Near-Minimal Axiomatisation of ZX-Calculus for Pure Qubit Quantum Mechanics. In: *34th Annual ACM/IEEE Symposium on Logic in Computer Science, LICS 2019, Vancouver, BC, Canada, June 24-27, 2019*, pp. 1–10, doi:10.1109/LICS.2019.8785765. Available at <https://doi.org/10.1109/LICS.2019.8785765>.