

# EvoZip: Efficient Compression of Large Collections of Evolutionary Trees

Balanand Jha, David Fernández-Baca, Akshay Deepak, and Kumar Abhishek

**Abstract**—Phylogenetic trees represent evolutionary relationships among sets of organisms. Popular phylogenetic reconstruction approaches typically yield hundreds to thousands of trees on a common leafset. Storing and sharing such large collection of trees requires considerable amount of space and bandwidth. Furthermore, the huge size of phylogenetic tree databases can make search and retrieval operations time-consuming. Phylogenetic compression techniques are specialized compression techniques that exploit redundant topological information to achieve better compression of phylogenetic trees. Here, we present *EvoZip*, a new approach for phylogenetic tree compression. On average, *EvoZip* achieves 71.6% better compression and takes 80.71% less compression time and 60.47% less decompression time than *TreeZip*, the current state-of-the-art algorithm for phylogenetic tree compression. While *EvoZip* is based on *TreeZip*, it betters *TreeZip* due to (a) an improved bipartition and support list encoding scheme, (b) use of Deflate compression algorithm, and (c) use of an efficient tree reconstruction algorithm. *EvoZip* is freely available online for use by the scientific community.

**Index Terms**—Phylogenetic compression, evolutionary tree, phylogenetic tree

## I. INTRODUCTION

A phylogeny (or phylogenetic tree or evolutionary tree) depicts the evolutionary relationships among a set of species [1], [2]. The study of evolutionary history of organisms has long played an important role in various scientific research areas like comparative genetics [3], drug discovery [4], systematics [5], forensic analysis [6], and species conservation [7]. Phylogenies are especially useful for identifying the fast evolving lineages of microorganisms, and tracing back the origin of a new microorganism helps formulate the ways to handle a new species based on the ways to handle its ancestors [8], [9], [10]. Estimating species turnover, which has been primarily responsible for a paradigm shift in a community ecology through prehistoric times, is another important application of phylogenetic analysis [11].

Most of the popular methods for phylogenetic reconstruction, e.g., maximum likelihood [12] and Bayesian inference based methods [13], [14], produce hundreds and thousands of trees representing plausible variants of phylogenies for a common set of taxa. Storing, mining, and sharing all these trees often requires large amount of space and time. For example, quite a few databases exist to store such large collections of phylogenetic trees running into gigabytes and terabytes [15],

[16], [17]. Storage and retrieval on such databases is time and space consuming. All this points towards the need of phylogenetic tree compression that is both time and space efficient.

While general purpose compression techniques can be applied for phylogenetic tree compression, the techniques fail to exploit the semantics of phylogenies, which limits their performance. TASPI [18] appears to be the first attempt at phylogenetic compression. It works by finding common subtrees among the set of input trees, replacing all repeated subtrees with a *reference* to its first occurrence. *TreeZip* [19] was a breakthrough in the field, greatly enhancing the compression ratio achieved by previous algorithms. It is the current state-of-the-art phylogenetic tree compression method. *TreeZip* works by finding common bipartitions in the input tree set and storing these bipartitions in a hash table. Only one bipartition is stored and its all other occurrences in all of the trees are replaced by a *reference* to the stored one. This hash table and the related data are encoded in the output file, which is much smaller than the original input file. The authors reported phylogenetic compression up to 2% [19], [20], [21].

Here we introduce *EvoZip*, a new approach for phylogenetic compression. *EvoZip* is based on *TreeZip*, but achieves better compression (up to 0.41%, an improvement of 85.45% over *TreeZip*) and is faster (an average improvement of 80.77% in compression time and 60.47% in decompression time) than *TreeZip*. While smaller compressed size appeals naturally, faster compression/decompression is also very important in real time scenarios such as on-the-fly query and retrieval operations in phylogenetic databases [15], [22], [23], where in response to the user queries, the stored trees need to be retrieved quickly. The improvement over *TreeZip* is primarily due to modifications in the encoding scheme, use of the DEFLATE compression algorithm [24], [25], and a faster tree reconstruction algorithm (used during the decompression stage). Further, *EvoZip* also supports internal node labels in Newick trees, a feature that is not supported by *TreeZip*.

The rest of the paper is organized as follows. In Sec. II, we review phylogenetic trees and their representation using the Newick format. In Sec. III we present a detailed description of the *TreeZip* algorithm. Section IV describes *EvoZip* algorithm highlighting its improvements over *TreeZip*. In Sec. V we compare *EvoZip* and *TreeZip* with respect to the compressed file size and compression/decompression time. Lastly in Sec. VI we conclude the paper and discuss the scope of future work.

Balanand Jha (corresponding author), Akshay Deepak, and Kumar Abhishek are with the Department of Computer Science & Engineering, National Institute of Technology Patna, India, e-mail: {balanand.cse.jrf, akshayd, kumar.abhishek}@nitp.ac.in.

David Fernández-Baca is with the Department of Computer Science, Iowa State University, USA, e-mail: fernande@iastate.edu.

## II. PHYLOGENETIC TREES AND THE NEWICK FORMAT

An evolutionary tree is a leaf-labeled rooted tree (see Fig. 1) where terminal nodes (leaves) represent taxa of interest and internal nodes represent ancestors. Evolutionary relationship are indicated by placing ancestors closer to the root node than any of their descendants. For example, in Fig. 1c,  $Y$  is an ancestor to both  $C$  and  $D$ , while  $X$  is an ancestor to all the three, i.e.,  $Y$ ,  $C$ , and  $D$ . Often the ancestors are not identified (as in Fig. 1a and 1b) due to a lack of information or interest. When identified, the tree has internal node labels too (as in Fig. 1c). Though commonly found as unweighted binary rooted trees, an evolutionary tree can be binary or  $n$ -ary, rooted or unrooted, and weighted (Fig. 1b) or unweighted (Fig. 1a) [1]. In all their variations, evolutionary trees are always unordered trees; i.e., the order of children (in rooted trees) or neighbors (in unrooted trees) does not matter. In this paper, a phylogenetic tree refers to a rooted phylogenetic tree, unless stated otherwise.

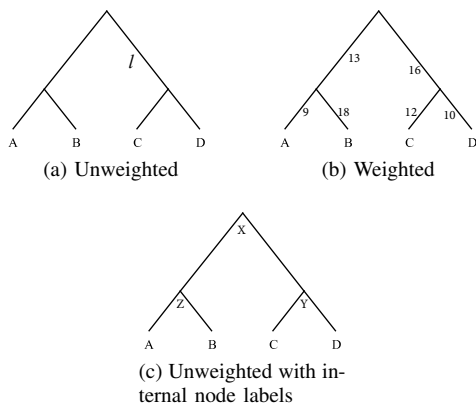

Fig. 1. Simple unweighted and weighted evolutionary trees

Every edge of a phylogenetic tree partitions the set of taxa into two disjoint subsets. For example, in Fig. 1a, the edge labeled  $l$  partitions the set of taxa into  $\{A, B\}$  and  $\{C, D\}$ . This *bipartition* induced by edge  $l$  is represented as  $AB|CD$ . The set of all bipartitions uniquely identifies a phylogenetic tree [19]. For example, the tree shown in Fig. 1 is uniquely identified by its bipartitions  $AB|CD$ ,  $A|BCD$ ,  $B|ACD$ ,  $C|ABD$ ,  $D|ABC$ . The last four bipartitions have a partition with a single leaf and are called “*trivial*”, because such bipartitions are present in every possible tree on the given set of taxa. For a given phylogenetic tree, either of the subsets of a bipartition uniquely identifies the bipartition. For example, either of  $\{A, B\}$  and  $\{C, D\}$  uniquely identifies the bipartition  $AB|CD$ . Hence, we represent a bipartition by just one of its subsets. To ensure uniqueness in the representation of a bipartition, we always choose the set of leaf nodes that are descendants of the bipartition edge. For example, in Fig. 1a, for the bipartition  $AB|CD$  induced by edge  $l$ , we choose  $CD$  to represent the bipartition. We define the *cardinality* of a bipartition as the number of leaf nodes that are descendants of the bipartition edge. For example, in Fig. 1a, for the bipartition  $AB|CD$  induced by edge  $l$ , and represented by  $CD$ , its cardinality is same as the cardinality of set  $\{C, D\}$ , i.e., two.

EvoZip, our proposed compression algorithm, takes as input phylogenetic trees represented using the popular Newick format<sup>1</sup>. The Newick format represents phylogenetic trees as strings, using parenthesis to delimit nodes, and commas to separate the children of a node. For example, the Newick representation of the tree shown in Fig. 1a is  $((A, B), (C, D));$ , where ‘;’ marks the end of the tree. Newick format can also represent weighted phylogenetic trees, where the weights — represented by real numbers — are placed just after a node separated by a colon. For example, the tree in Fig. 1b is a weighted tree. The corresponding Newick representation is  $((A : 9, B : 18) : 13, (D : 10, C : 12) : 16) : 10;$ . Apart from the terminal nodes, the internal nodes can also be labeled, which account for the name of a known ancestor. For example, for the tree in Fig. 1c, its Newick representation is  $((D, C)Y, (B, A)Z)X;$ . Since, all trees stored in Newick format are rooted and our work is about compressing trees in Newick format,

## III. THE TREEZIP ALGORITHM

TreeZip [19], [20], [21], is the current state-of-the-art algorithm for phylogenetic compression, works by exploiting redundancy among the bipartitions in large collections of phylogenetic trees on a common leafset. The key idea in TreeZip is to organize each bipartition from a collection of phylogenetic trees in a universal hash table, where each entry of a bipartition in the hash table also stores the list of trees containing that bipartition. Each of the input trees is parsed and the corresponding bipartitions are simultaneously inserted into the hash table. The compressed output file contains dataset properties such as the number of taxa, taxon labels (names of taxa or leaf nodes), and the number of trees, followed by bipartitions and their *support lists* (the list of trees containing the bipartition). The bipartitions and their support lists are encoded using a combination of run-length and delta encoding schemes. Next, we review TreeZip’s randomized universal hash function, along with its algorithm to create and populate the hash table, and TreeZip’s encoding schemes for bipartitions and support lists.

### A. TreeZip’s hash function

TreeZip adapts the idea of hashing bipartitions from Amenta et al.’s [26] randomized linear-time algorithm for generating a majority rule tree. We note that the authors of TreeZip have also used this idea in HashCS [27] — which generates the majority-rule tree for a collection of trees — and HashRF [28] — which constructs the Robinson-Foulds distance matrix [29] for a collection of trees.

For a given tree on  $n$  leaves, where an implicit ordering on the set of leaves is assumed, let  $B = (b_1 \dots b_n)$  be the  $n$ -bit bitstring representation of a bipartition in the tree. Here, bit  $b_i$  is set to 1 if the  $i^{\text{th}}$  taxon is present in the bipartition and 0 otherwise. In this regard, we define a special *root bipartition* corresponding to the root node as the bit string representation

<sup>1</sup><http://evolution.genetics.washington.edu/phylip/newicktree.html>

with every bit set to 1. The following universal hash function is used to hash bipartitions:

$$h(B) = \sum b_i a_i \text{ mod } m$$

where  $B = (b_1 \dots b_n)$  is the  $n$ -bit bitstring representation of the bipartition,  $m$  is a large prime number, and  $A = (a_1 \dots a_n)$  denotes a set of random integers between 0 and  $m - 1$ .

Clearly, the larger is the value of  $m$ , the smaller are the chances of two different bipartitions hashing to the same code. However, since  $m$  equals the number of bins in the hash table,  $m$  cannot be too large. To address this, two such hash functions,  $h_1$  and  $h_2$ , corresponding to  $m_1$  and  $m_2$ , are used to hash each of the bipartitions. While  $h_1$  determines the bin index in the hash table where the corresponding bipartition is stored,  $h_2$  is used to resolve a collision of two different bipartitions having a common  $h_1$  value, i.e., indexed in the same  $h_1^{\text{th}}$  bin of the hash table. With this, the probability of collision at the level of  $h_2$  becomes  $1/m_1 m_2$ . The value of  $m_1$  determines the size of the hash table, and can be adjusted depending on memory considerations. The value of  $m_2$  is chosen to be a very large number,  $m_2 \gg m_1$ , to minimize the probability of collision.

A nice property of the above hash function is that it can be computed for all the bipartitions in a tree in  $O(n)$  time, where  $n$  is the number of leaves. Compare this to the naive approach that will take  $O(n^2/w)$ , where  $w$  is the size of the machine word. This is possible because given the hash codes of the children of a node, the hash code of the parent node can be calculated in  $O(1)$  time. Let a node with bit string representation  $B$  have two children with  $B_L$  and  $B_R$  as their respective bitstring representations. Then, given  $h_1(B_L)$  and  $h_1(B_R)$ ,  $h_1(B)$  can be computed in  $O(1)$  time as:

$$h_1(B) = (h_1(B_L) + h_1(B_R)) \text{ mod } m_1$$

Same applies to the second hash function  $h_2$  as:

$$h_2(B) = (h_2(B_L) + h_2(B_R)) \text{ mod } m_2$$

Once the hash table is populated, it is encoded and written to the output file. For each bipartition, its bitstring representation and the support list are stored in the output file.

### B. Encoding bipartitions

As discussed previously, a bipartition is represented by the subset of leaf nodes that are descendants of the bipartition edge. Thus, in the bit string representation, only the bits corresponding to the leaf nodes present in this subset are turned ON. For example, the bitstring representation of a bipartition  $ABC|DEF$  is 000111. Such a bitstring representation is inherently highly redundant, so storing the bitstrings as such in the compressed file would not be space efficient. Hence, the authors apply run length encoding where they represented long runs of 0s and 1s as characters  $L$  and  $K$  respectively, followed by the respective counts of 0s and 1s. For single occurrences of 0s and 1s in the bitstring, they used symbols  $A$  and  $B$  respectively. For instance, consider bipartition  $ABCF|DE$  of the second tree in Fig. 2 having bitstring representation

000110. It has a continuous stretch of three 0s, two 1s, and a single 0. The first three 0s are encoded as  $L3$ , the next two 1s are encoded as  $K2$ , and finally the single 0 is encoded as  $A$ . The complete encoded bitstring representation of this bipartition is  $L3K2A$ . Table I shows bitstring representation and run length encoding of all the bipartitions of all the trees in the tree set shown in Fig. 2.

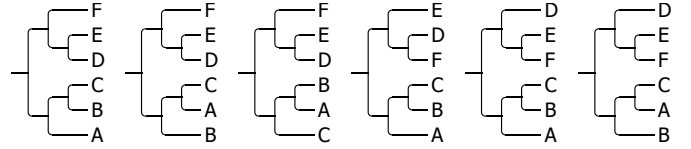

Fig. 2. A collection of six tree on a common leafset.

TABLE I  
LIST OF NON-TRIVIAL BIPARTITIONS OF TREES IN FIG. 2

Tree 0	Bitstring	RLE	Tree 1	Bitstring	RLE
ABC DEF	000111	L3K3	ABC DEF	000111	L3K3
BCI ADEF	100111	BL2K3	ACI BDEF	010111	ABAK3
ABCF IDE	000110	L3K2A	ABCF IDE	000110	L3K2A
Tree 2	Bitstring	RLE	Tree 3	Bitstring	RLE
ABC DEF	000111	L3K3	ABC DEF	000111	L3K3
ABIC DEF	001111	L2K4	BCI ADEF	100111	BL2K3
ABCF IDE	000110	L3K2A	ABCE IDF	000101	L3BAB
Tree 4	Bitstring	RLE	Tree 5	Bitstring	RLE
ABC DEF	000111	L3K3	ABC DEF	000111	L3K3
BCI ADEF	100111	BL2K3	ACI BDEF	010111	ABAK3
ABCD IEF	000011	L4K2	ABCD IEF	000011	L4K2

### C. Encoding Support Lists

The support list of a bipartition consists of the trees containing the bipartition. Here, each tree is represented by its identifier, its *tree id*, which is an integer. This list of integers is stored in the ascending order in the hash table where the corresponding bipartition is stored.

A particular bipartition may be present in some trees and absent in others. If a bipartition is present in majority of the trees, then storing the list of trees where the bipartition is absent can be more space-efficient than storing its support list. Motivated by this, Matthews et al. coin two terms, *in-set* and *out-set*. The in-set is the set of trees containing a particular bipartition and the out-set is its complement. Only the smaller of the two is stored in the output compressed file. A marker, “+” for in-set and “-” for out-set, is written in the output file to indicate the corresponding choice.

To store a list of tree ids, first the in-set/out-set marker is written followed by the first tree id. For subsequent tree ids, only the difference with respect to the previous tree id is written in the output file. To avoid the need of a special character to distinguish between subsequent entries in this list, the authors used a trick to distinguish the first digit of each entry by using letters A to J for the digits 0 to 9. For example, for the bipartition ABCD|IEF present in trees 4 and 5 in Fig.

2 and in Table II, the first tree id 4 is encoded in entirety as *E*. For the next tree id, 5, only its difference with respect to the previous tree id is encoded, i.e.,  $5 - 4 = 1$  is encoded as *B*. The final encoded list is *EB*. For each bipartition of the tree set shown in Fig. 2, Table II shows the corresponding bitstring representation, the run length encoded bitstring, its support list, and the delta encoded support list.

TABLE II  
LIST OF BIPARTITIONS AND THEIR SUPPORT LIST

Bipartition	Bitstring	RLE	Tree Ids	+/-	Support List
ABCDIEF	000011	L4K2	4,5	+	EB
ABCEIDF	000101	L3BAB	3	+	D
ABCIFDE	000110	L3K2A	0,1,2	+	ABB
ABCIDEF	000111	L3K3	0,1,2,3,4,5	-	0
ABICDEF	001111	L2K4	2	+	C
ACIBDEF	010111	ABAK3	1,5	+	BE
BCIADEF	100111	BL2K3	0,3,4	+	ADB

The Newick representation of the input trees and the contents of the final compressed file are shown in Table III. The first line of the output file contains the list of all the taxa in the input tree set. The second line stores the number of trees. The third line shows the total number of bipartitions in the entire tree set. The subsequent lines represent encoded bipartitions and the corresponding support list; each such line consists of four fields: the encoded bipartition, in-set/out-set marker, number of entries in the support list, and finally, the encoded support list.

TABLE III  
CONTENTS OF THE COMPRESSED FILE

(A,(B,C),(D,E),F);	1. TAXA A:B:C:D:E:F
(B,(A,C),(D,E),F);	2. NTREES 6
(C,(A,B),(D,E),F);	3. NBPARTITIONS 7
(A,(B,C),(D,E),F);	4. L4K2 +:2:EB
(A,(B,C),(E,F),D);	5. L3BAB +:1:D
(B,(A,C),(E,F),D);	6. L3K2A +:3:ABB
	7. L3K3 -:0:
	8. L2K4 +:1:C
	9. ABAK3 +:2:BE
	10. BL2K3 +:3:ADB

#### IV. THE EVOZIP ALGORITHM

EvoZip is based on TreeZip. EvoZip outperforms TreeZip, in terms of both compressed size and compression/decompression time, using the following ideas.

- **Improved encoding scheme of bipartitions:** The bipartition encoding scheme of EvoZip improves the encoding scheme of TreeZip by better utilization of character space by employing single byte values as markers for different categories of byte values during compression.
- **Improved encoding scheme of support lists:** EvoZip utilizes fixed-size delta encoding technique to compress the list of trees that contain a particular bipartition.
- **Use of Deflate compression algorithm:** EvoZip further compresses the encoded data using the Deflate compression algorithm [24], which combines LZ77 [30] and Huffman encoding [31].

- **Efficient tree reconstruction:** EvoZip improves on TreeZip’s decompression method by using Gusfield’s [32] algorithm for reconstructing phylogenetic trees from bipartitions during decompression.

Using the above ideas, EvoZip achieves average improvements, relative to TreeZip, of 71.60% on the compressed size of the output file and of 80.77% and 60.47% on the compression and decompression times, respectively. In the rest of this section, we discuss in detail the techniques used by EvoZip.

##### A. Improved bipartition encoding scheme

TreeZip’s encoding scheme was explained in Sec. III. For example, TreeZip encodes ‘0001101’ as ‘L3K2AB’. EvoZip improves upon the bipartition encoding of TreeZip in two ways. First, TreeZip encodes the count of consecutive zeroes (or ones) as a base 10 number, where each digit of the number is stored as a character. For the example mentioned, the ‘000’ part is encoded as character string ‘L3’, where ‘L’ is the marker character for zeros. This prevents the full utilization of a character space. EvoZip overcomes this limitation by encoding the count of consecutive zeros (or ones) as a base 2 number, where each digit of the number is encoded as a bit. This allows better utilization of a character space. For example, to encode 120, TreeZip uses three bytes whereas EvoZip takes only one byte, i.e.,  $120_{10} = 1111000_2$ , where each digit of 1111000 is encoded as a bit. Second, TreeZip’s run-length encoding of a bipartition becomes particularly inefficient for long sequences of non-consecutive zeros and ones. TreeZip encodes a single occurrence of zero (one) as the character ‘A’ (‘B’). Hence, TreeZip encodes ‘10101010’ as string ‘ABABABAB’. Again, this prevents the full utilization of the corresponding character space because to indicate a 0/1, one bit of space is sufficient. EvoZip overcomes this limitation by encoding sequences of non-consecutive zeros and ones as 8-bit sequences, where each character of the bit-string representation is represented by a bit. For example, TreeZip encodes ‘10101010’ as string ‘ABABABAB’, taking eight bytes, whereas EvoZip encodes each digit of ‘10101010’ as a single bit taking only one byte.

Figure 3 explains the bipartition encoding scheme of EvoZip with an example. There are three possibilities of consecutive 0s and 1s in a bipartition bitstring. There may be a long sequence of 0s, 1s, or a random stretch of non-consecutive sequence of 0s/1s. We indicate this using a single byte number as a marker. A 0 value indicates that the number in the next byte is the number of chunks of contiguous 0s in the bitstring. A 1 value indicates the same for 1s. Any other value indicates the number of 8-bit sequences of non-consecutive 0s/1s; these non-consecutive sequences are written just after. For simplicity, a bipartition bitstring is processed in chunks of 8-bit sequences. In this regard, only an 8-bit chunk of all 1s/0s is considered consecutive. For example, consider the bitstring shown in Fig. 3. Reading 8-bit chunks from left to right, we first encounter a subsequence of 40 zeros. This is encoded as ‘05’ taking two bytes. Here, ‘0’ indicates that the subsequence being encoded consists of 8-bit sequences of consecutive 0s

and ‘5’ indicates the number of consecutive 8-bit sequences of 0s. Next, we encounter a random stretch consisting of three 8-bit sequences of non-consecutive sequence of 0s/1s. To encode this, we set the marker as ‘3’ and write the subsequent random bits just after this marker. Next, we have 7 chunks of 1s and 15 chunks of 0s that are written just after following the “marker – count” pattern. EvoZip requires ten bytes to store this encoded bipartition. TreeZip encodes this bipartition as L44K2L2K3L2BAK3L3BAK57A120 (see Sec. III), requiring a total of 26 bytes. EvoZip has a gain of 16 bytes.

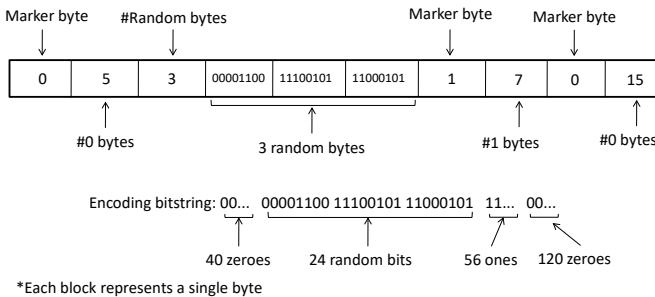

Fig. 3. Bipartition encoding scheme.

**B. Improved support list encoding scheme**

The *support list* of a bipartition is the list of trees having that bipartition. Each tree is represented by its unique integral identifier called *tree id*. Both TreeZip and EvoZip employ *delta encoding* [33]. The first tree id in a support list is stored as is. For each subsequent tree id, only its difference — i.e., its *delta* — with respect to the previous tree id is stored. TreeZip encodes the difference as a base 10 number, where each digit of the number is stored as a character. In contrast, EvoZip encodes it as a base 2 number, where each digit of the number is encoded as a bit. This results in a better utilization of space as was done while encoding bipartitions. First, EvoZip tries to encode the difference in a single byte. Only if the delta cannot be accommodated in a byte, i.e., if it exceeds the value of 255, EvoZip uses more bytes. This saves space when compared with a scheme that reserves a fixed number of bytes for storing each delta value.

For example, consider the support list shown in Fig. 4. The first tree id (345) fits in the first two bytes and is stored as such. For the next tree id 544, having a difference of 199 from previous tree id, its difference, i.e., 199, is stored in a single byte. For the next tree id 1599, with a difference of 1055 from the previous tree id, its difference, i.e., 1055, exceeds the capacity of a single byte (255). Hence, EvoZip sets the next byte to zero to indicate this event and stores the difference in the next two bytes. Further, the next two tree ids with a difference of 122 and 249 are stored in a single byte each. EvoZip takes a total of eight bytes to store this support list. TreeZip encodes this support list as D45B99B055B22C49 (see section III), which requires 16 bytes. In comparison, EvoZip achieves a gain of 8 bytes for the given example. This gain becomes increasingly larger as the number of trees and bipartitions increases.

Support list: 345, 544, 1599, 1721, 1970

Encoding:

345	199	0	1055	122	249
First Id (Without change)	544-345 (<255)	1599 - 544 = 1055 (>255)	(Two bytes)	1721 - 1599 (<255)	1970 - 1721 (<255)

Fig. 4. Support list encoding scheme.

**C. The Deflate algorithm**

The encoded bipartitions and support lists are written in an intermediate buffer. Though the space used by this buffer is much smaller than the space required to store the trees in the Newick format, it is further compressed with the use of the Deflate algorithm [24]. Deflate works by first compressing the input stream using the LZ77 [30] algorithm and then encoding this compressed stream using Huffman encoding [31]. A block diagram of the Deflate algorithm is shown in Fig. 5. We now briefly review the relevant aspects of LZ77 and Huffman encoding.

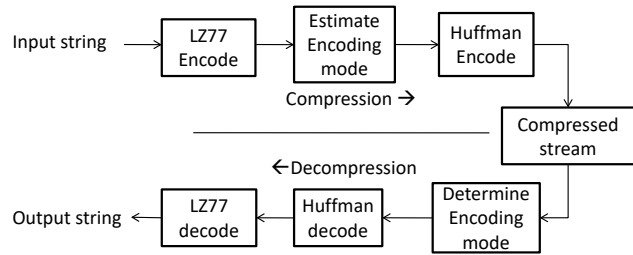

Fig. 5. Block diagram of deflate algorithm

1) *LZ77 algorithm*: The well-known LZ77 string compression algorithm [30] minimizes redundancy in the input stream by identifying repeatedly occurring substrings in the input stream, retaining only the first occurrence, and replacing all the other occurrences by a distance-length vector. This vector points to the start of the occurrence of a matched string by storing backward distance of the first symbol of the string from the current position. The length component of this vector tells how long is the matching string. A *sliding window* of fixed length limits the backward search distance (typically 32KB) for finding a match. The window is divided into two parts: (1) search buffer or dictionary and (2) look ahead buffer. The search buffer contains the part that has already been processed. New data to be searched is loaded into the look ahead buffer, which is compared with the data in the search buffer to find a match. In the Deflate algorithm, backward-distance and length are limited to 32K bytes and 258 bytes respectively [25].

2) *Huffman encoding*: Huffman encoding is a well known prefix based code for compressing bitstreams. The peculiarity of this algorithm is that it assigns variable length codes depending on the frequency of symbols in the input stream. Highly frequent symbols get smaller codes while those occurring less frequently get longer codes. It is called prefix based code because each symbol gets its own prefix code that is unique to that symbol only in that particular encoding instance, and no code is a prefix of another code. The unique prefix

nature of this code avoids the need of end of the character markers in the encoded string. The output stream from LZ77 is fed to the Huffman encoder. In order to determine a unique code for each character in the file, the algorithm first gets frequencies of each character and then constructs a Huffman tree. A Huffman tree is a binary tree having each character from the text as a leaf node. All the edges in the tree are labelled with either “0” or “1”. If a node has two descendant nodes, then the edge connecting the current node to its left descendant will be labelled as “0” and that of right descendant as “1”.

The bitstring representation of a character can be obtained from this tree by traversing the tree from the root node to the leaf of interest along the shortest path and appending the label of each edge in the path. Using this tree, the bitstring code for each symbol can be generated.

*Combining LZ77 and Huffman in ‘Deflate’:* The output of LZ77 algorithm is fed to the Huffman encoder, which breaks it into smaller blocks. Each of these blocks is encoded independently. The Huffman encoder in Deflate employs three modes of compression. Each block starts with a three bit header to indicate the mode of compression of the current block. The first bit indicates whether the current block is the last block of the data or not. It is set to true only for the last block of the data. The values of the next two bits denote the mode of compression used. The value 00 of these two bits indicate that the block contains incompressible data. The value 01 indicates that the block is compressed using a common Huffman code, which is available at the decoder end itself (also known as “fixed Huffman code”). Hence, the Huffman code table, which is required for reconstructing the Huffman code tree, need not be present in the encoded block. The value ‘10’ indicates that the block is compressed with Huffman code with dedicated tree for each block (also known as “dynamic Huffman code”). The Huffman code table must be sent in each block. A value of ‘11’ is reserved for unexpected situations (like errors) and is not used for encoding/decoding.

As discussed before, the LZ77 encoded stream consists of distance-length-literal triplets. The length and literal segments are encoded into a single Huffman tree while the distance is encoded in another Huffman tree. Each block of the compressed Huffman code stream contains three header bits followed by a pair of Huffman tables and the compressed stream. The size of a block is not fixed for compressed blocks (the blocks in which the block type indicator bits are anything other than 00), however, those blocks containing uncompressed data (indicator bits 00) are limited to 65,535 bytes. Once the limit has been reached, the current block must be terminated and a new block must begin.

3) *Tree reconstruction algorithm:* The tree reconstruction algorithm used by EvoZip is based on Gusfield’s [32]  $O(nm)$  time tree reconstruction algorithm, where  $n$  is the number of taxa and  $m$  is the number of bipartitions. To the best of our knowledge, Gusfield’s algorithm is the fastest algorithm for reconstructing trees from its constituent bipartitions. It is based on the following observation for deriving parent-descendant relationship among a set of bipartitions: if two bipartitions have a common leaf descendant (*overlapping bipartitions*),

the one with the higher cardinality is the parent of the other. Algorithm 1 describes the reconstruction algorithm. First the set of {non-trivial bipartitions  $\cup$  root bipartition} is sorted by ascending order of the cardinalities of bipartitions, the root bipartition appearing last in the sorted list (lines 1–2). The tree is reconstructed iteratively in terms of paths from leaf nodes to the root, each such a path being reconstructed in an iteration (lines 3–17). Two or more of such paths can overlap. While reconstructing a path, only the non-overlapping portion of a path that has not been constructed before, is constructed (lines 10–15). The construction of a path is stopped the moment an already constructed node – belonging to the overlapping part – is encountered in the leaf-to-root path (lines 7–9).

Figure 6 shows a sample five-taxon phylogenetic tree along with its non-trivial and root bipartitions. Figure 7 demonstrates the working of EvoZip (Algorithm 1) by reconstructing the sample tree of Fig. 6 using its bipartitions. The shaded and unshaded circles in Fig. 7 represent the leaf nodes and internal nodes respectively. The table in Fig. 6 shows the set of all bipartitions, represented by  $\beta$ , the cardinality of each bipartition, and the leaf descendants of each bipartition. Once EvoZip has sorted the set  $\beta$ , it creates an empty tree  $T$  to start with. Let  $L = \{A, B, C, D, E\}$  denote the set of all taxa of the tree shown in Fig. 6. EvoZip picks a single taxon  $A$  from  $L$  and creates a leaf node corresponding to  $A$  in  $T$ . A pointer  $c$  points towards  $A$ . In general, the pointer  $c$  always points to the current node whose parent is being searched for in the tree being constructed. Having created the leaf node  $A$  (see Fig. 7.1), EvoZip searches for the first bipartition  $B$  in the sorted set  $\beta$  containing leaf  $A$ , which happens to be  $B_2$  (see Fig. 6). So, it attaches  $A$  to  $B_2$  as its child and the pointer  $c$  now points to  $B_2$  (Fig. 7.2). Now, it searches for the next bipartition containing leaf  $A$ , which is  $B_3$ , so,  $B_2$  is attached to  $B_3$  as a child (Fig. 7.3). This completes the reconstruction of the path from leaf  $A$  to the root since no other bipartition in  $\beta$  contains  $A$ . Now, EvoZip takes the next taxa  $B$  from  $L$  and makes  $c$  point to it to indicate that  $B$  is the next node that has to be attached to its parent (Fig. 7.4). The first bipartition containing  $B$  is  $B_0$ , which is not yet present in  $T$ , so, a new internal node  $B_0$  is created and  $B$  is attached to  $B_0$  as a child.  $c$  now points to the parent of  $B$ , i.e.,  $B_0$  (Fig. 7.5). The next bipartition containing  $B$  is  $B_2$ . The internal node  $B_2$  already exists in  $T$ , i.e., the sub path from  $B_2$  to the root overlaps with an already constructed leaf-to-root path. Hence,  $B_0$  is now attached to  $B_2$  as its child and the reconstruction of the path from leaf  $B$  to the root is complete. This continues until paths from all the leaves to the root node have been reconstructed as shown in Fig. 7.

We were unable to determine the reconstruction algorithm used by TreeZip, hence, we are unable to comment on the extent to which the use of Gusfield’s algorithm helps EvoZip improve upon TreeZip. However, we would like to point out that, to the best of our knowledge, Gusfield’s algorithm [32] is the fastest approach for reconstructing a phylogenetic tree from its constituent bipartitions.

4) *Additional Utilities:* Apart from the above improvements over TreeZip, EvoZip also provides the following additional utility functionalities:

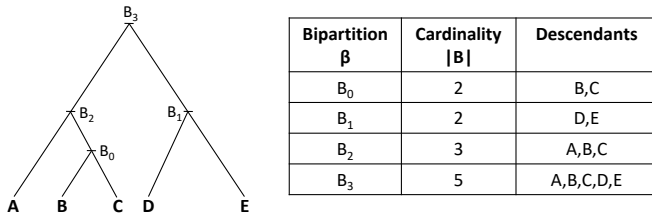

Fig. 6. Original tree and its non-trivial and root bipartitions for tree reconstruction example

**Algorithm 1** Tree reconstruction algorithm

- 1:  $\beta \leftarrow$  set of non-trivial bipartitions  $\cup$  root bipartition
- 2: Sort  $\beta$  on the basis of cardinality in the ascending order.  
Let  $\beta = \{B_0, B_1, \dots, B_k\}$  represent the sorted set, where  $B_k$  is the root bipartition.
- 3: **for** each taxon  $l$  **do**
- 4:   Create a leaf node corresponding to  $l$ . Let  $c$  point to the node.
- 5:   Find the first bipartition  $B \in \beta$  that contains  $l$
- 6:   **while**  $B$  exists **do**
- 7:     **if** a node exists for  $B$  **then**
- 8:       Make  $c$  child of that node
- 9:     **break**
- 10:   **else**
- 11:     Create a node for  $B$
- 12:     Make  $c$  child of that node
- 13:     Let  $c$  point to its parent
- 14:     Find the next bipartition  $B \in \beta$  that contains  $l$
- 15:   **end if**
- 16:   **end while**
- 17: **end for**

- **Internal node labels:** We have already discussed the importance of internal node labels in phylogenetic trees and their presence in Newick representation in Sec. I. While internal node labels are ignored by TreeZip, EvoZip retains them in the compressed file.
- **Preserving precision in branch lengths:** We observed that TreeZip only supports six digits of precision in branch lengths. If the precision exceeds this limit, it rounds-off the numbers to six digit precision numbers. EvoZip supports full precision for branch lengths.
- **Check for double collision:** While populating the hash table, the possibility of double collision is minuscule (less than one in  $10^{17}$  in our implementation). It is so small that we never encountered a double collision in all our experiments. The same observation was also supported in TreeZip [19]. Still, there remains a theoretical possibility of double collision, which, as discussed in Sec. III, can corrupt the compression output. EvoZip provides an option to check for double collision and any other error that may have crept. This is achieved by comparing the input trees with the decompressed trees. Since phylogenetic trees are unordered trees, comparison of two phylogenetic trees must ignore the order of nodes. For this we employ a phylogeny-specific canonical form for evolutionary trees

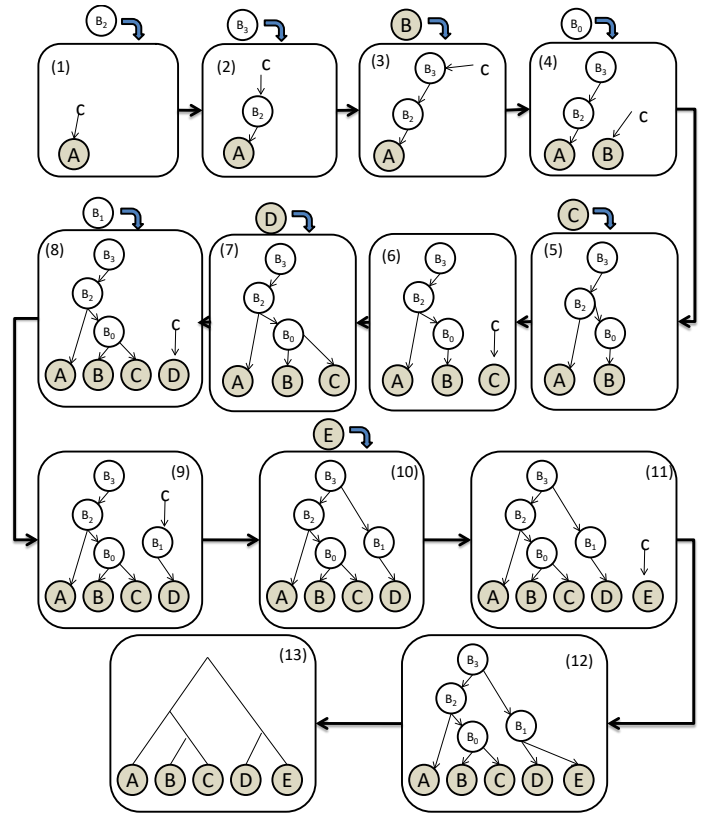

Fig. 7. Tree reconstruction steps in EvoZip. Shaded circles represent leaf nodes and unshaded circles represent internal nodes. Pointer  $c$  points to the current node whose parent is to be searched.

used in our earlier work on frequent subtree mining [2]. Canonicalization is achieved by assigning a virtual label to each internal node. The virtual label of an internal node  $v$  is the minimum label among all the leaf descendants of  $v$ . The children of an internal node are ordered from left to right based on the sequence in which they are encountered in an inorder depth first traversal, the left-most child being encountered first. A tree is in canonical form if, for every internal node, its children are ordered from left to right by their virtual labels. EvoZip checks for double collision by first canonicalizing the input and output (decompressed) trees, and then comparing their canonical forms. A mismatch of canonical forms indicates a double collision.

V. EXPERIMENTAL RESULTS AND DISCUSSION

Here we report on our experiments to compare EvoZip with TreeZip [19] with respect to the size of the compressed file and the time taken (compression time and decompression time). We performed our experiments on a Linux machine having 3.6 GHz Intel Core i7-4790 octa-core CPU with 8 GB RAM and 64 bit Ubuntu 16.04 LTS operating system. We evaluated EvoZip on the phylogenetic dataset used in a previous study by Pattengale et al. [34].

The test data consists of 17 sets of bootstrapped trees, each having around 10000 trees, constructed from single-gene and multi-gene DNA sequences, with 125-2,554 taxa. Their file



sizes range from 9.66 MB to 229.19 MB (see Table IV). In the subsequent discussion, each dataset is referred to by the number of taxa and the number of trees in the dataset separated by ‘/’.

While comparing EvoZip with TreeZip, we also report, under the heading ‘EvoZip w/o Deflate’, the corresponding values where EvoZip is used *without* the Deflate algorithm. This has been done to highlight the individual contributions of bipartition/support-list encoding schemes and the Deflate algorithm in EvoZip. All sizes are presented in KBs, while the time is in seconds. Despite repeated attempts, TreeZip was unable to produce results on datasets ‘1481/10000’, ‘1512/14485’, and ‘2000/10015’. Hence, the corresponding entries in Figures 8-14 and Tables V-IX are absent.

TABLE IV  
DATASET PROPERTIES

Sl.	#taxa	#trees	#bipartitions (All)	#bipartitions (Unique)	FileSize (MB)
1	125	10000	1230125	321	8.88
2	150	10000	1480150	11487	18.57
3	218	10000	2160218	23495	26.58
4	354	10000	3520354	170752	53.32
5	404	10000	4020404	73839	33.62
6	500	10000	4980500	43131	51.87
7	628	10000	6260628	75785	60.22
8	714	10000	7120714	61995	60.22
9	994	10150	10069794	65492	105.70
10	1288	12800	16462088	179531	143.68
11	1481	10000	14791481	720201	130.65
12	1512	14485	21873862	591498	229.19
13	1604	10455	16750514	353834	175.72
14	1908	10458	19934856	441188	179.22
15	2000	10015	20011970	763655	142.19
16	2308	10074	23232952	159121	211.07
17	2554	10112	25808378	472989	186.30

A. Compression Ratio

Figure 8 compares the original files and the files compressed by TreeZip and EvoZip. Table V give the corresponding values. On average, EvoZip produces 71.6% better compression than TreeZip. Figure 9 shows the same comparison on a relative scale.

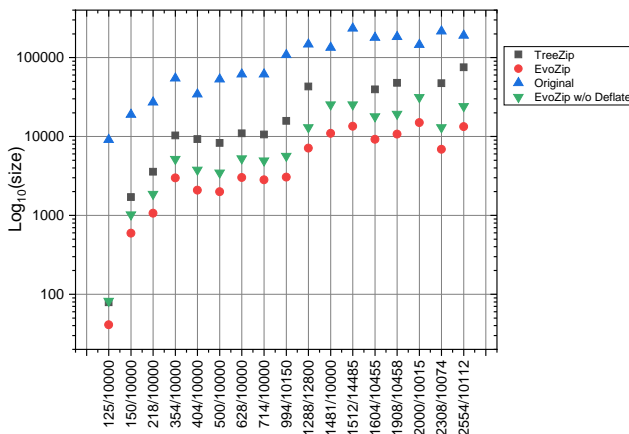

Fig. 8. Comparison of file size. The Y-axis shows size on a logarithmic scale.

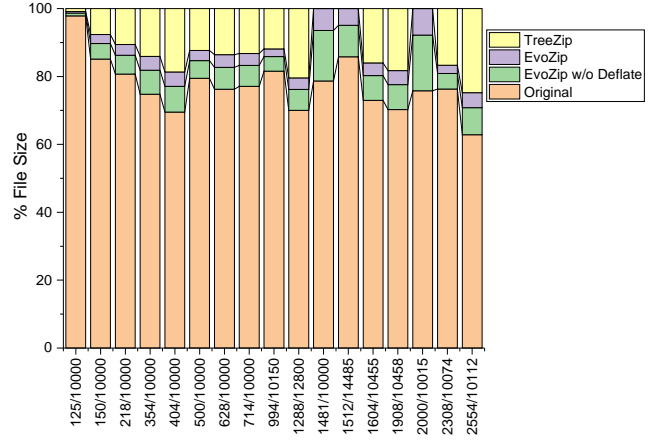

Fig. 9. Percentage comparison of file size

TABLE V  
FILE SIZE COMPARISON

Sl.	#taxa/trees	Size (KB)	TreeZip	EvoZip	EvoZip w/o Deflate
1	125/10000	9093	79	41	82
2	150/10000	19014	1701	595	1021
3	218/10000	27217	3567	1066	1862
4	354/10000	54600	10281	2979	5163
5	404/10000	34424	9256	2079	3771
6	500/10000	53116	8253	1997	3480
7	628/10000	61670	10970	3016	5256
8	714/10000	61670	10574	2816	4939
9	994/10150	108241	15728	3057	5659
10	1288/12800	147125	42940	7092	12998
11	1481/10000	133790	-	10924	25378
12	1512/14485	234689	-	13456	25332
13	1604/10455	179941	39519	9191	17975
14	1908/10458	183526	47776	10732	19232
15	2000/10015	145599	-	15025	31447
16	2308/10074	216139	47206	6867	13050
17	2554/10112	190776	75144	13353	24193

Figure 10 compares the percentage space savings of EvoZip and TreeZip computed as follows

$$\% \text{ Space saving} = \left( 1 - \frac{1}{\text{Compression ratio}} \right) \times 100$$

where, the compression ratio is computed as

$$\text{Compression ratio} = \frac{\text{Uncompressed size}}{\text{Compressed size}}$$

Corresponding values are given in Table VI. On average, TreeZip achieves 80.57% space saving while EvoZip achieves 94.99%. Table VII shows the corresponding values for the compression ratio, based on the above formula.

B. Compression/Decompression Time

Figures 11 and 12 compare compression and decompression times of EvoZip and TreeZip. The corresponding values are given in Tables VIII and IX respectively. EvoZip clearly beats TreeZip for all sets of bootstrap trees,. Note that EvoZip has better performance gain for compression time than decompression time against TreeZip (see Figures 13 and 14). This is because during decompression the time to reconstruct the



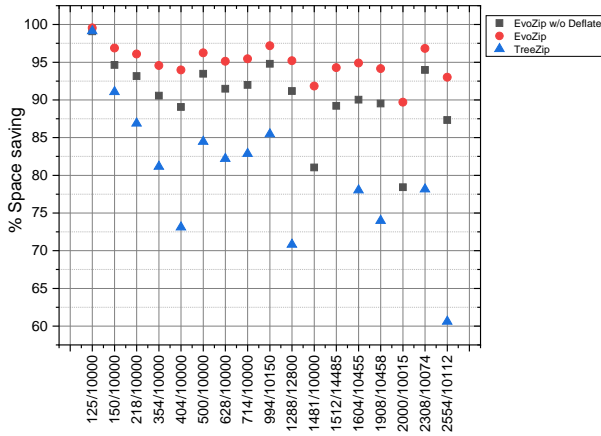

Fig. 10. Percentage space savings

TABLE VI  
COMPARISON OF PERCENTAGE SPACE SAVING

Sl.	#taxa/trees	TreeZip	EvoZip	EvoZip w/o Deflate
1	125/10000	99.1312	99.5491	99.09821
2	150/10000	91.05396	96.87073	94.63027
3	218/10000	86.89422	96.08333	93.15869
4	354/10000	81.17033	94.54396	90.54396
5	404/10000	73.11178	93.96061	89.04543
6	500/10000	84.46231	96.2403	93.4483
7	628/10000	82.21177	95.10945	91.47722
8	714/10000	82.8539	95.43376	91.99124
9	994/10150	85.46946	97.17575	94.77185
10	1288/12800	70.81393	95.17961	91.16534
11	1481/10000	-	91.83497	81.03147
12	1512/14485	-	94.26645	89.20614
13	1604/10455	78.0378	94.89221	90.01061
14	1908/10458	73.96772	94.15233	89.52083
15	2000/10015	-	89.68056	78.40164
16	2308/10074	78.15943	96.82288	93.96222
17	2554/10112	60.6114	93.00069	87.31864

trees from their constituent bipartitions dominates the overall decompression time. For the smallest dataset (having 125 taxa and 10000 trees), EvoZip (TreeZip) takes 0.391 (1.24944) seconds for compression, showing about 3.2 times improvement over TreeZip, and takes 1.028 (5.389062) seconds for decompression, showing about 5.24 times improvement over TreeZip. Similarly, for the second largest dataset (having 2308 taxa and 10074 trees), EvoZip (TreeZip) takes 12.586 (192.147) seconds for compression, a 15.27-fold improvement, and takes 299.611 (455.999) seconds for decompression, a 1.52-fold improvement over TreeZip. The compressed file sizes of these datasets using EvoZip (TreeZip) are 41KB (79KB) and 6867KB (47206KB) respectively. We cannot comment on the improvement in the compression time of the largest dataset (2554 taxa and 10112 trees) because, in repeated trials, TreeZip took an exceptionally long time for successful compression (2434 seconds), which is disproportionately high as compared to the time it took to compress other datasets (see Table VIII).

TABLE VII  
COMPRESSION RATIO

Sl.	#taxa/trees	TreeZip	EvoZip	EvoZip w/o Deflate
1	125/10000	115.10	221.78	110.89
2	150/10000	11.18	31.96	18.62
3	218/10000	7.63	25.53	14.62
4	354/10000	5.31	18.33	10.58
5	404/10000	3.72	16.56	9.13
6	500/10000	6.44	26.60	15.26
7	628/10000	5.62	20.45	11.73
8	714/10000	5.83	21.90	12.49
9	994/10150	6.88	35.41	19.13
10	1288/12800	3.43	20.75	11.32
11	1481/10000	-	12.25	5.27
12	1512/14485	-	17.44	9.26
13	1604/10455	4.55	19.58	10.01
14	1908/10458	3.84	17.10	9.54
15	2000/10015	-	9.69	4.63
16	2308/10074	4.58	31.48	16.56
17	2554/10112	2.54	14.29	7.89

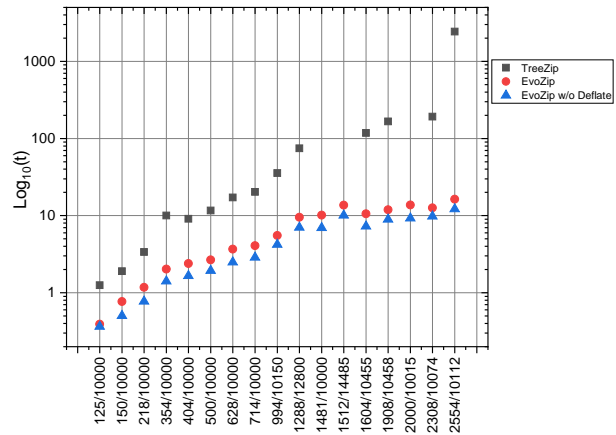

Fig. 11. Comparison of compression time. The time has been expressed on a logarithmic scale on Y-axis

## VI. CONCLUSIONS AND FUTURE WORK

Our results show that the proposed algorithm EvoZip improves significantly upon TreeZip, the state-of-the-art algorithm for phylogenetic compression, with respect to both compression ratio and compression time. The improvement is the result of (1) improved bipartition and support list encoding schemes, (2) the use of Deflate compression algorithm, and (3) the use of Gusfield's [32] efficient algorithm for phylogenetic tree reconstruction. EvoZip also provides some additional utilities not supported by TreeZip. The current implementation of EvoZip will be made available online at the time of publication for use by scientific community .

Currently, EvoZip supports only collections of phylogenetic trees with identical taxon sets. We plan to add support for heterogeneous tree collections where each tree can have a different sets of taxa. Mining frequent subtrees [2], [35] in a collection of heterogeneous trees can also be implemented. Further, a feature to construct the majority rule consensus tree from the compressed data, without reconstructing all the input trees, can also be implemented. This will reduce the processing time when only a consensus tree on a subset of taxa needs to

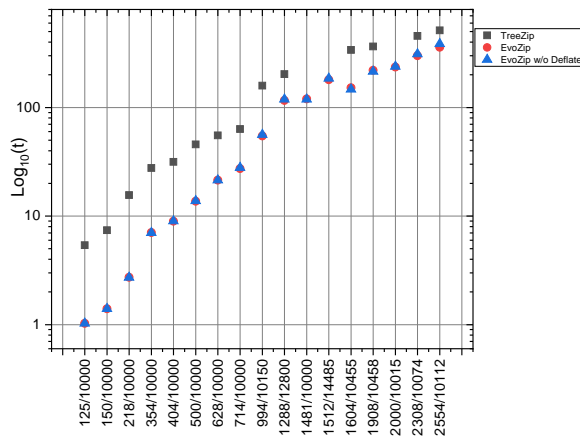

Fig. 12. Comparison of decompression time. The time has been expressed on a logarithmic scale on Y-axis

TABLE VIII  
COMPRESSION TIME

Sl.	#taxa/trees	TreeZip	EvoZip	EvoZip w/o Deflate
1	125/10000	1.24944	0.391	0.366
2	150/10000	1.90709	0.769	0.504
3	218/10000	3.36997	1.177	0.772
4	354/10000	10.0219	2.028	1.415
5	404/10000	9.06688	2.393	1.658
6	500/10000	11.6548	2.661	1.938
7	628/10000	17.1729	3.683	2.491
8	714/10000	20.3026	4.068	2.873
9	994/10150	35.5257	5.534	4.227
10	1288/12800	74.666	9.522	7.015
11	1481/10000	-	10.16	6.928
12	1512/14485	-	13.686	10.095
13	1604/10455	117.834	10.562	7.253
14	1908/10458	166.166	11.928	8.916
15	2000/10015	-	13.754	9.266
16	2308/10074	192.147	12.586	9.822
17	2554/10112	2434	16.324	12.183

be assessed rather than the extraction of the entire collection of trees (e.g., as in the case of STBase [15]). An option for stability analysis of phylogenetic trees [36] can also be incorporated when sequence data is also available along with the trees in order to weed-out any unstable tree from a large tree collection.

ACKNOWLEDGMENTS

This work was partially funded by Early Career Research grant from the Department of Science & Technology - Science & Engineering Research Board (DST-SERB), project file no. ECR/2016/001077, Government of India.

Akshay Deepak has been awarded Young Faculty Research Fellowship (YFRF) of Visvesvaraya PhD Programme of Ministry of Electronics & Information Technology, MeitY, Government of India. In this regard, he would like to acknowledge that this publication is an outcome of the R&D work undertaken in the project under the Visvesvaraya PhD Scheme of Ministry of Electronics & Information Technology, Government of India, being implemented by Digital India Corporation (formerly Media Lab Asia).

TABLE IX  
DECOMPRESSION TIME

Sl.	#taxa/trees	TreeZip	EvoZip	EvoZip w/o Deflate
1	125/10000	5.389062	1.028	1.027
2	150/10000	7.398401	1.397	1.398
3	218/10000	15.60293	2.731	2.723
4	354/10000	27.739307	7.054	7.023
5	404/10000	31.605248	8.978	8.982
6	500/10000	45.778981	13.689	13.82
7	628/10000	55.28115	21.419	21.458
8	714/10000	63.189929	27.33	27.949
9	994/10150	158.80178	54.651	56.291
10	1288/12800	203.04748	115.926	119.208
11	1481/10000	-	119.959	118.742
12	1512/14485	-	180.147	185.478
13	1604/10455	338.93075	151.661	147.265
14	1908/10458	363.87119	220.053	214.591
15	2000/10015	-	235.599	238.557
16	2308/10074	455.99994	299.611	310.969
17	2554/10112	513.3841	358.417	386.321

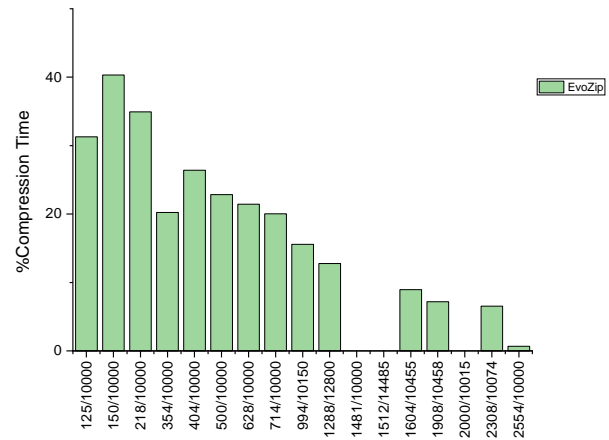

Fig. 13. Percentage compression time with respect to TreeZip. The above graph shows the compression time taken by EvoZip as percentage of the corresponding time taken by TreeZip.

REFERENCES

- [1] D. Baum, "Reading a phylogenetic tree: the meaning of monophyletic groups," *Nature Education*, vol. 1, no. 1, p. 190, 2008.
- [2] A. Deepak, D. Fernández-Baca, S. Tirthapura, M. J. Sanderson, and M. M. McMahon, "Evominer: frequent subtree mining in phylogenetic databases," *Knowledge and Information Systems*, vol. 41, no. 3, pp. 559–590, 2014.
- [3] D. E. Soltis and P. S. Soltis, "The role of phylogenetics in comparative genetics.," *Plant physiology*, vol. 132, pp. 1790–800, Aug 2003.
- [4] J. Warren, "Drug discovery: lessons from evolution," *British journal of clinical pharmacology*, vol. 71, no. 4, pp. 497–503, 2011.
- [5] K. De Queiroz and M. J. Donoghue, "Phylogenetic systematics and the species problem," *Cladistics*, vol. 4, no. 4, pp. 317–338, 1988.
- [6] J. Cracraft and R. W. Bybee, *Evolutionary science and society: educating a new generation*. BSCS, 2005.
- [7] S. M. Tsang, A. L. Cirranello, P. J. Bates, and N. B. Simmons, "The roles of taxonomy and systematics in bat conservation;" in *Bats in the anthropocene: Conservation of bats in a changing world*, pp. 503–538, Springer, Cham, 2016.
- [8] G. Suzán, G. E. García-Peña, I. Castro-Arellano, O. Rico, A. V. Rubio, M. J. Tolsá, B. Roche, P. R. Hosseini, A. Rizzoli, K. A. Murray, et al., "Metacommunity and phylogenetic structure determine wildlife and zoonotic infectious disease patterns in time and space," *Ecology and evolution*, vol. 5, no. 4, pp. 865–873, 2015.

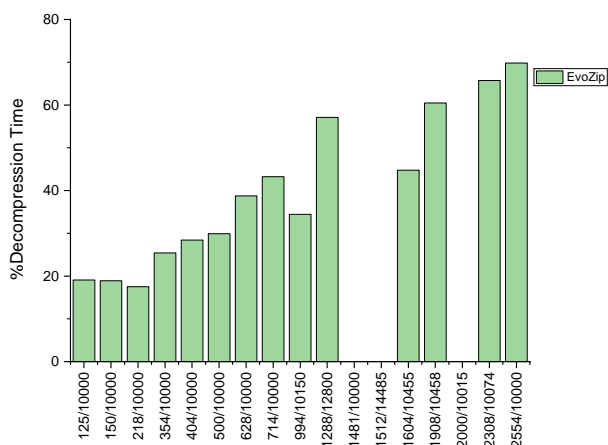

Fig. 14. Percentage decomposition time with respect to TreeZip. The above graph shows the compression time taken by EvoZip as percentage of the corresponding time taken by TreeZip.

[9] M. W. Allard, E. Strain, D. Melka, K. Bunning, S. M. Musser, E. W. Brown, and R. Timme, "Practical value of food pathogen traceability through building a whole-genome sequencing network and database," *Journal of clinical microbiology*, vol. 54, no. 8, pp. 1975–1983, 2016.

[10] M. Hoffmann, Y. Luo, S. R. Monday, N. Gonzalez-Escalona, A. R. Ottesen, T. Muruvanda, C. Wang, G. Kastanis, C. Keys, D. Janies, et al., "Tracing origins of the salmonella bareilly strain causing a food-borne outbreak in the united states," *The Journal of Infectious Diseases*, vol. 213, no. 4, pp. 502–508, 2015.

[11] J. D. Archibald, "The importance of phylogenetic analysis for the assessment of species turnover: A case history of paleocene mammals in north america," *Paleobiology*, vol. 19, no. 1, pp. 1–27, 1993.

[12] J. Felsenstein, "Evolutionary trees from dna sequences: a maximum likelihood approach," *Journal of molecular evolution*, vol. 17, no. 6, pp. 368–376, 1981.

[13] J. P. Huelsenbeck and F. Ronquist, "Mrbayes: Bayesian inference of phylogenetic trees," *Bioinformatics*, vol. 17, no. 8, pp. 754–755, 2001.

[14] F. Ronquist, M. Teslenko, P. Van Der Mark, D. L. Ayres, A. Darling, S. Höhna, B. Larget, L. Liu, M. A. Suchard, and J. P. Huelsenbeck, "Mrbayes 3.2: efficient bayesian phylogenetic inference and model choice across a large model space," *Systematic biology*, vol. 61, no. 3, pp. 539–542, 2012.

[15] M. M. McMahon, A. Deepak, D. Fernández-Baca, D. Boss, and M. J. Sanderson, "Stbase: One million species trees for comparative biology," *PLoS ONE*, vol. 10, pp. 1–17, 02 2015.

[16] H. Li, A. Coghlan, J. Ruan, L. J. Coin, J.-K. Heriche, L. Osmotherly, R. Li, T. Liu, Z. Zhang, L. Bolund, et al., "Treefam: a curated database of phylogenetic trees of animal gene families," *Nucleic acids research*, vol. 34, no. suppl\_1, pp. D572–D580, 2006.

[17] J. Huerta-Cepas, S. Capella-Gutierrez, L. P. Pryszcz, M. Marcet-Houben, and T. Gabaldón, "Phylomedb v4: zooming into the plurality of evolutionary histories of a genome," *Nucleic acids research*, vol. 42, no. D1, pp. D897–D902, 2013. Online: <http://phylomedb.org/>.

[18] R. S. Boyer, W. A. Hunt, and S. M. Nelesen, "A compressed format for collections of phylogenetic trees and improved consensus performance," in *International Workshop on Algorithms in Bioinformatics*, pp. 353–364, Springer, 2005.

[19] S. Matthews, S.-J. Sul, and T. L. Williams, "A novel approach for compressing phylogenetic trees," in *ISBRA*, pp. 113–124, Springer, 2010.

[20] S. J. Matthews, "Heterogeneous compression of large collections of evolutionary trees," *IEEE/ACM Transactions on Computational Biology and Bioinformatics (TCBB)*, vol. 12, no. 4, pp. 807–814, 2015.

[21] S. J. Matthews, S.-J. Sul, and T. L. Williams, "Treezip: A new algorithm for compressing large collections of evolutionary trees," in *Data Compression Conference (DCC), 2010*, pp. 544–544, IEEE, 2010.

[22] W. H. Piel, M. Donoghue, M. Sanderson, and L. Netherlands, "Treebase: a database of phylogenetic information," in *Proceedings of the 2nd International Workshop of Species 2000*, 2000.

[23] L. Nakhleh, D. Miranker, and F. Barbancon, "Requirements of phylogenetic databases," in *Bioinformatics and Bioengineering, 2003. Proceedings. Third IEEE Symposium on*, pp. 141–148, IEEE, 2003.

[24] S. Oswal, A. Singh, and K. Kumari, "Deflate compression algorithm," *International Journal of Engineering Research and General Science*, vol. 4, no. 1, pp. 430–436, 2016.

[25] P. Deutsch, "Deflate compressed data format specification version 1.3," tech. rep., 1996.

[26] N. Amenta, F. Clarke, and K. S. John, "A linear-time majority tree algorithm," in *WABI*, pp. 216–227, Springer, 2003.

[27] S.-J. Sul and T. L. Williams, "An experimental analysis of consensus tree algorithms for large-scale tree collections," in *International Symposium on Bioinformatics Research and Applications*, pp. 100–111, Springer, 2009.

[28] S.-J. Sul and T. L. Williams, "An experimental analysis of robinson-foulds distance matrix algorithms," in *European Symposium on Algorithms*, pp. 793–804, Springer, 2008.

[29] D. F. Robinson and L. R. Foulds, "Comparison of phylogenetic trees," *Mathematical biosciences*, vol. 53, no. 1-2, pp. 131–147, 1981.

[30] J. Ziv and A. Lempel, "A universal algorithm for sequential data compression," *IEEE Transactions on information theory*, vol. 23, no. 3, pp. 337–343, 1977.

[31] D. A. Huffman, "A method for the construction of minimum-redundancy codes," *Proceedings of the IRE*, vol. 40, no. 9, pp. 1098–1101, 1952.

[32] D. Gusfield, "Efficient algorithms for inferring evolutionary trees," *Networks*, vol. 21, no. 1, pp. 19–28, 1991.

[33] J. Mogul, B. Krishnamurthy, F. Douglass, A. Feldmann, Y. Goland, A. van Hoff, and D. Hellerstein, "Delta encoding in http," tech. rep., 2001.

[34] N. D. Pattengale, K. M. Swenson, and B. M. Moret, "Uncovering hidden phylogenetic consensus," in *International Symposium on Bioinformatics Research and Applications*, pp. 128–139, Springer, 2010.

[35] A. Ramu, T. Kahveci, and J. G. Burleigh, "A scalable method for identifying frequent subtrees in sets of large phylogenetic trees," *BMC bioinformatics*, vol. 13, no. 1, p. 256, 2012.

[36] S. I. Sheikh, T. Kahveci, S. Ranka, and J. Gordon Burleigh, "Stability analysis of phylogenetic trees," *Bioinformatics*, vol. 29, no. 2, pp. 166–174, 2012.



**Balanand Jha** is currently working as a senior research fellow in the Department of Computer Science & Engineering, National Institute of Technology Patna, India. His research areas include computational phylogenetics, ontologies, and computational biology.



**David Fernández-Baca** is a professor in the Department of Computer Science, Iowa State University, USA. His research interest includes combinatorial algorithms, phylogenetic tree construction, computational biology, and sensitivity analysis of optimization problems. <http://web.cs.iastate.edu/~fernande/>.



**Akshay Deepak** is an assistant professor in the Department of Computer Science and Engineering, National Institute of Technology Patna, India. He received his MS and PhD degrees in Computer Science from Iowa State University, USA. His research interest include data mining, machine learning, and computational biology. [http://www.nitp.ac.in/php/faculty\\_profile.php?id=akshayd@nitp.ac.in](http://www.nitp.ac.in/php/faculty_profile.php?id=akshayd@nitp.ac.in).



**Kumar Abhishek** is working as an Assistant Professor, Department of Computer Science and Engineering, National Institute of Technology Patna, India. His area of interest lies in RDF, Semantic Web, Ontology, Semantic Sensor Web, and Big data. [http://www.nitp.ac.in/php/faculty\\_profile.php?id=kumar.abhishek@nitp.ac.in](http://www.nitp.ac.in/php/faculty_profile.php?id=kumar.abhishek@nitp.ac.in)