

Optimal Control of Status Updates in a Multiple Access Channel with Stability Constraints

Zheng Chen, Nikolaos Pappas, Emil Björnson, and Erik G. Larsson

Abstract—In this work, we study peak-age-optimal scheduling with stability constraints in a multiple access channel (MAC) with two heterogeneous source nodes transmitting to a common destination. The first node has randomly arriving data packets and it is connected to a power grid. Another energy harvesting (EH) sensor node monitors the environment and sends status updates to the destination. We consider a *stationary* scheduling policy with random transmission decisions based on some probability distributions, and a *dynamic* policy where the decisions are made based on the observed network states in each time slot. With the stationary policy, we derive the average peak age of information (AoI) of the EH node and the stability condition of the grid-connected node, and optimize the transmission probabilities by minimizing the average peak age with stability constraint. The dynamic policy is developed by using Lyapunov optimization theory with the help of virtual queues. Simulation results show that the dynamic scheduling policy achieves lower average peak AoI compared to the stationary one, especially when the destination node have low multi-packet reception (MPR) capability. However, this advantage comes at the cost of frequent exchange of information between the nodes due to centralized scheduling.

Index Terms—Age of Information (AoI), Energy Harvesting, Random Access, Dynamic Scheduling, Lyapunov Optimization.

I. INTRODUCTION

The Age of Information (AoI) is a newly emerged metric and tool to capture the timeliness of reception and freshness of data [2]. The definition of AoI was first introduced in [3]–[5]. Consider a monitored source node which generates timestamped status updates, and transmits them through a wireless channel or through a network to a destination. The AoI that the destination has for the source is the elapsed time from the generation of the last received status update. Keeping the average AoI small corresponds to having fresh information. This notion has been extended to other metrics such as the value of information, cost of update delay, and non-linear AoI [6], [7].

In the early studies of AoI, the source nodes are either connected to the power-grid or have infinite battery, so their transmission decisions are not affected by the battery status.

Z. Chen, E. Björnson, and E. G. Larsson are with the Department of Electrical Engineering (ISY), Linköping University, 58183 Linköping, Sweden. Email: {zheng.chen, emil.bjornson, erik.g.larsson}@liu.se.

N. Pappas is with the Department of Science and Technology (ITN), Linköping University, 60174 Norrköping, Sweden. Email: nikolaos.pappas@liu.se.

A part of this work was presented in IEEE INFOCOM Workshops (AoI'19) [1]. This work was supported in part by ELLIIT, CENIIT, and the Swedish Foundation for Strategic Research (SSF).

Recently, some works have considered the AoI analysis and optimization in a network with an energy harvesting (EH) source node. The deployment of EH sensors is envisioned as an efficient solution for energy-efficient and self-sustainable networks, especially in the Internet of Things (IoT) networks where devices opportunistically transmit small amounts of data with low power consumption. Sensors with EH capabilities can convert ambient energy (e.g., solar power, or thermal energy) into electrical energy that can be used for sending status updates to the destination nodes.

A. Related Works

In [8], the authors consider the problem of optimizing the process of sending updates from an EH source to a receiver to minimize the time average age of updates. Similar analyses can be found in [9]–[17]. In [18], an erasure channel is considered between the EH-enabled transmitter and the destination. The transmitter sends coded status updates to the receiver in order to minimize the AoI. In [19], the authors consider the scenario where the timings of the status updates also carry an independent message. This information is transmitted through a receiver with EH capabilities and the trade-off between AoI and the information rate is studied.

The age-energy tradeoff is explored in [20], where a finite-battery source is charged intermittently by Poisson energy arrivals. In [21], the optimal status updating policy for an EH source with a noisy channel was investigated. The possibility of update failures is considered in [22], where an optimal online updating policy is proposed to minimize the average AoI, subject to an energy causality constraint at the sensor. The impact of a finite-size battery in the EH source node is investigated in [23].

In addition to the case with nodes harvesting ambient energy, some other works have considered wireless power transfer (WPT) to convert the received radio frequency signals to electric power [24]. In [25], the performance of a WPT-powered sensor network in terms of the average AoI was studied. The work in [26] considers freshness-aware IoT networks with EH-enabled IoT devices. More specifically, the optimal sampling policy for IoT devices that minimizes the long-term weighted sum-AoI is investigated.

In a network with multiple source nodes, assuming multi-packet reception (MPR) capability at the receiver, the transmissions from multiple source nodes will be successful with some probabilities, and those success probabilities depend on the received signal-to-interference-plus-noise ratio (SINR) [27],

[28]. A packet management strategy is considered in [29] in a network with N source nodes transmitting to a common receiver. Recently, some works have considered different types of traffic associated with different source nodes, e.g., some nodes generate time-sensitive status updates, and other nodes strive to achieve as large throughput as possible. The impact of heterogeneous traffic on the AoI and the optimal update policy has been investigated in [30], [31]. The work in [32] investigates Nash and Stackelberg equilibrium strategies for DSRC and WiFi coexisting networks, where DSRC and WiFi nodes are age-oriented and throughput-oriented, respectively.

In the current literature, the analysis and optimization of AoI is often based on some stationary scheduling policies, meaning that each node takes random activation decisions based on a predetermined probability distribution. In [33], dynamic programming based on a Markov Decision Process is applied in a cognitive radio network with an EH secondary user opportunistically transmitting status updates to its destination. Age-optimal scheduling policies in a network with time-varying channels have been studied in [34], where the channel state information is assumed to be available to the network scheduler. In [35], both randomized and dynamic policies have been considered to minimize the weighted sum AoI with throughput constraints in a network with one base station receiving information from M nodes. The drift-plus-penalty policy in this work is developed by Lyapunov optimization theory [36], [37], which is often used for developing dynamic scheduling algorithms to achieve queue stability with performance optimization. Such dynamic policies are able to make scheduling decisions based on the observed random events in each time slot (data arrivals, channel states etc.) and optimizes some long-term performance metric while achieving network stability.

B. Contributions

This work is the first one that studies a multiple access channel (MAC) where two source nodes with heterogeneous traffic and power supplies transmit to a common destination with MPR capability. We consider one grid-connected node that has bursty arrivals of regular data packets, and one EH sensor attempting to send the most fresh status updates to the destination.

We formulate an optimization problem that jointly considers the queue stability of the grid-connected node with peak age minimization of the EH node. We first consider an easy-to-implement stationary scheduling policy that makes random transmission decisions in each slot based on a stationary probability distribution. The average peak age and the stability condition are derived in closed-form, and the optimal transmission probabilities are found by solving a constrained optimization problem. Then we consider a dynamic policy that makes scheduling decision in each time slot based on the observed network status such as data queue size and battery status. We use the Lyapunov optimization theory to develop the dynamic policy, which stabilizes the data queue of the grid-connected user and minimizes the average peak AoI of

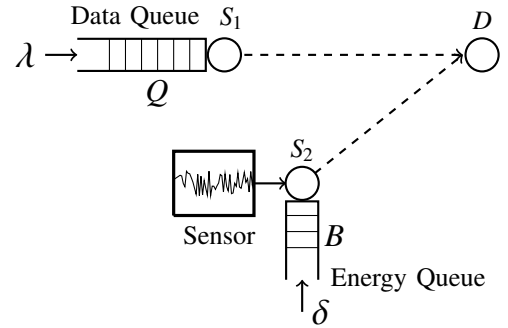

Fig. 1. The system model. One grid-connected source node and an energy-harvesting (EH) device share the same wireless channel to a common destination. The EH device is generating status updates to transmit to the destination.

the EH sensor. Simulation results show that the proposed dynamic scheduling policy has the advantage of achieving a lower average peak age than the stationary one. But it requires centralized scheduling with frequent exchange of information between the nodes. The performance difference between these two policies is smaller when the destination node has strong MPR capability.

Compared to the conference version [1], which studies the average AoI with stationary transmission probabilities, here we consider the average peak AoI as the main performance metric, and extend our analysis by investigating peak-age-optimal scheduling with both stationary and dynamic policies.

II. SYSTEM MODEL

We consider a time-slotted MAC where two source nodes with heterogeneous traffic intend to transmit to a common destination D , as shown in Fig. 1. The first node S_1 is connected to the power grid, thus its activities are not affected by any battery status. The data packets arrive at the queue of S_1 following a Bernoulli process with probability λ . Denote by $Q(t)$ the data queue size of node S_1 in time slot t , which has infinite capacity. The second node S_2 is not connected to a dedicated power source, but it can harvest energy from its environment. We assume that the battery charging process follows a Bernoulli process with probability δ , with $B(t)$ representing the number of energy units in the energy source (battery) at node S_2 in time slot t . The capacity of the battery is assumed to be infinite.

Note that the two source nodes generate different types of traffic. Node S_1 sends data packets that have been stored in its queue. The average delay to receive a packet from S_1 will be finite if the data queue is stable. Node S_2 always generates the most fresh sample of the status update and sends it to the destination when it decides to transmit, i.e., the status update transmitted at time slot t is generated right before this slot. We consider equal-sized data packets and the transmission of one packet occupies one time slot.

Let $a_1(t)$ and $a_2(t)$ represent two Bernoulli processes for the data arrivals at node S_1 and energy arrivals at node S_2 , respectively. We have $\lambda = \mathbb{E}[a_1(t)]$ and $\delta = \mathbb{E}[a_2(t)]$. We

consider an early departure late arrival model for the queue. The data queue of node S_1 updates by the following dynamic equation

$$Q(t+1) = \max[Q(t) - b_1(t), 0] + a_1(t), \quad (1)$$

where $b_1(t) = 1$ if the destination successfully receives a packet from S_1 in time slot t , otherwise $b_1(t) = 0$. In the case of an unsuccessful transmission from S_1 , the packet has to be re-transmitted in a future time slot. We assume that the receiver gives an instantaneous error-free acknowledgment (ACK) feedback of all the packets that were successful in a slot at the end of the slot. Then, S_1 removes the successfully transmitted packets from its buffer.

We assume that both nodes have fixed transmit power, and for S_2 the transmission of one status update consumes one energy unit from the battery. The same assumption can also be found in [13], [16], [22].¹ The battery buffer of S_2 evolves according to the following equation

$$B(t+1) = \max[B(t) - s(t), 0] + a_2(t), \quad (2)$$

where $s(t) = 1$ if node S_2 attempts to transmit a status update in time slot t , otherwise $s(t) = 0$.

When a status update is transmitted from S_2 , in case of a transmission failure, that packet is dropped without waiting for an ACK, and a new status update will be generated for its next attempted transmission.

A. Success Probability Definition

In this work, we assume MPR capability at the destination node D , which means that D can decode packets from multiple simultaneous transmissions which are interfering with each other. The transmission from one source node is successful if its received signal-to-interference-plus-noise ratio (SINR) at D exceeds a certain threshold [38].

We assume a block fading channel, where the fading coefficient remains constant during the period of one packet transmission (one time slot) and independently changes from one slot to another. The received SINR at each node i is given by

$$\text{SINR}_i = \frac{P_i |h_i|^2 \beta_i}{\sum_{j \in \mathcal{A} \setminus \{i\}} P_j |h_j|^2 \beta_j + \sigma^2},$$

where \mathcal{A} denotes the set of active transmitters; P_i denotes the transmission power of node i ; h_i denotes the small-scale channel fading from the transmitter i to the destination, which follows independent Rayleigh fading with $h_i \sim \mathcal{CN}(0, 1)$; β_i denotes the large-scale fading coefficient of link i ; σ^2 denotes the thermal noise power.²

¹This work can be extended to the case where one transmission consumes multiple energy units. We can consider the number of consumed energy units for each transmission as one big energy unit, and normalize the energy arrival process accordingly. Here, we consider fixed instead of adaptive power since power control is usually not a required feature in an Internet-of-Things (IoT) setup with low-power devices.

²The analysis in this work is only based on success probabilities. Therefore, other types of channel models can also be considered if the success probabilities can be derived analytically.

For the notational convenience, we define $p_{i/i}$ as the success probability of S_i , $i \in \{1, 2\}$ when only S_i is transmitting; and $p_{i/i,j}$ as the success probability of S_i when both S_i and S_j are transmitting. Denote by θ_i , $i = \{1, 2\}$, the SINR thresholds for having successful transmission. By utilizing the small-scale fading distribution, we can obtain the success probabilities as follows

$$p_{i/i} = \mathbb{P}\{\text{SINR}_i \geq \theta_i\} = \exp\left(-\frac{\theta_i \sigma^2}{P_i \beta_i}\right), \quad i = \{1, 2\}, \quad (3)$$

$$p_{i/i,j} = \mathbb{P}\{\text{SINR}_i \geq \theta_i\} = \frac{\exp\left(-\frac{\theta_i \sigma^2}{P_i \beta_i}\right)}{1 + \theta_i \frac{P_j \beta_j}{P_i \beta_i}}, \quad i = \{1, 2\}, j \neq i. \quad (4)$$

B. Scheduling Policies

Since the two source nodes share the same wireless channel, scheduling plays an important role. We define the scheduling policy space by $\Pi = \{U_i(t) \in \{0, 1\}, \forall t, i = \{1, 2\}\}$, where $U_i(t)$ is the scheduling decision of node i at slot t . The age of information (AoI) We aim at finding a scheduling policy $\pi \in \Pi$ (possibly stationary or dynamic) that minimizes the average peak age of node S_2 , denoted by \bar{A}_p , subject to the queue stability of node S_1 . The formal definition of \bar{A}_p and the stability condition will be given later in Section III. This problem offers a performance balance between the age-oriented EH node and the throughput-oriented grid-connected node.

The optimization problem is given by

$$\underset{\pi}{\text{minimize}} \quad \bar{A}_p \quad (5a)$$

$$\text{subject to} \quad \bar{Q} < \infty, \quad (5b)$$

where $\bar{Q} = \lim_{t \rightarrow \infty} \mathbb{E} \left[\frac{1}{t} \sum_{\tau=0}^{t-1} Q(\tau) \right]$. The constraint (5b) ensures that the data queue of S_1 is strongly stable.

We first consider a *stationary scheduling policy*, where the transmission decisions of both nodes follow some probability distributions, and they are independent of each other. Another option is to consider a *dynamic scheduling policy*, where the scheduling decision in each time slot is based on the observed network conditions in that slot, such as the queue size, the battery size etc. The details of these two scheduling policies will be given in Sections III and IV.

For both types of scheduling policies, the success probabilities in (3) and (4) are assumed to be known as side information to the network scheduler. It means that the scheduler does not need to know the current channel realization, so the scheduling decision in each slot is independent of the small-scale fading realization. In this work, we consider that the two nodes are at fixed locations. Our analysis can be easily extended to the case with users changing locations over time. Then, the side information needs to be updated whenever a node moves to a different location.

III. PERFORMANCE ANALYSIS AND OPTIMIZATION WITH A STATIONARY POLICY

The proposed stationary scheduling policy is described as follows:

- When the data queue of S_1 is not empty, it transmits a packet to the destination with probability q_1 .
- When S_2 has a non-empty battery, it generates a status update with probability q_2 and transmits it to the destination.³

With this policy, both $s(t)$ and $b_1(t)$ are binary processes following Bernoulli distributions, $s(t) = 1$ with probability q_2 , and $b_1(t) = 1$ with probability $q_1 \cdot \mathbb{P}[\text{SINR}_1 > \theta_1]$.

The advantage of a stationary scheduling policy is that it does not require centralized scheduling with exchange of information between the nodes. Once the success probabilities are computed, each node makes independent decisions without coordinating with each other.

In the remaining part of this section, we first characterize the stability condition of node S_1 and the average peak AoI of node S_2 , which can be given as functions of the transmission probabilities q_1 and q_2 . Then, this scheduling policy is optimized by finding the optimal transmission probabilities q_1 and q_2 that minimizes the average peak age of node S_2 under a stability constraint of node S_1 .

A. Stability Condition of Node S_1

The service probability of S_1 can be obtained by averaging the success probability over three different cases: when S_2 has empty battery, when S_2 has non-empty battery but decides not to transmit, and when S_2 decides to transmit. The service probability is

$$\begin{aligned} \mu &= \mathbb{P}[B(t) = 0] q_1 p_{1/1} + \mathbb{P}[B(t) \neq 0] q_1 (1 - q_2) p_{1/1} \\ &\quad + \mathbb{P}[B(t) \neq 0] q_1 q_2 p_{1/1,2} \\ &= q_1 p_{1/1} (1 - q_2 \mathbb{P}[B(t) \neq 0]) + q_1 \mathbb{P}[B(t) \neq 0] q_2 p_{1/1,2}. \end{aligned} \quad (6)$$

The queue of S_1 is stable if and only if $\lambda < \mu$. Stability implies that the queueing delay will be finite. Note that $B(t)$ can be modeled as a discrete time Markov chain, and it has a unique stationary distribution when the energy queue is stable. In the following we use $\mathbb{P}(B = 0)$ to represent $\mathbb{P}[B(t) = 0]$.

When the queue is stable, $Q(t)$ has a unique stationary distribution. The probability that the queue is non-empty is

$$\mathbb{P}[Q \neq 0] = \frac{\lambda}{\mu}. \quad (7)$$

This probability will be used in the average peak AoI analysis for node S_2 .

In this work, we consider the case where S_2 relies on energy harvesting to operate, but for comparison purposes, we also give the stability condition where S_2 is connected to the power grid.

1) *When S_2 relies on EH:* When node S_2 relies on EH to operate, recall that the energy arrival process at the EH node S_2 follows a Bernoulli process with probability δ . The evolution of the energy queue B can be modeled as a Discrete Time Markov Chain. When $\delta < q_2$, we have

$$\mathbb{P}(B \neq 0) = \frac{\delta}{q_2}. \quad (8)$$

³A similar status update generation model with EH-based users can be found in [34], [39].

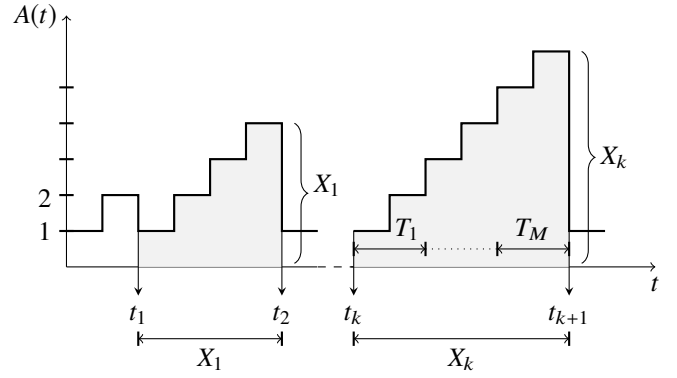

Fig. 2. Evolution of the AoI. t_k denotes the time when the destination received the k -th update. X_k is the number of time slots between the successful receptions of the k -th and the $(k + 1)$ -th status updates.

Note that when $\delta \geq q_2$, the Markov chain is not positive recurrent, thus it does not have a unique stationary distribution.

Plugging (8) into (6), we obtain

$$\mu = q_1 p_{1/1} (1 - \delta) + q_1 \delta p_{1/1,2}. \quad (9)$$

The stability condition $\lambda < \mu$ yields

$$q_1 > \frac{\lambda}{p_{1/1} (1 - \delta) + \delta p_{1/1,2}}. \quad (10)$$

From (10), we see that in order to have a stable queue at S_1 , the transmission probability q_1 needs to be higher than a threshold, and this threshold is independent of q_2 when $\delta < q_2$. This is because when $\delta < q_2$, how frequently S_2 is causing interference to the transmission of S_1 is limited by its energy arrivals, instead of q_2 .

Note that when $\lambda \geq p_{1/1} (1 - \delta) + \delta p_{1/1,2}$, the data queue of S_1 cannot be stabilized when assuming $q_2 > \delta$, because this assumption restricts the searching space of possible transmission probabilities. Thus, for $\lambda \geq p_{1/1} (1 - \delta) + \delta p_{1/1,2}$, we consider an approximate case where S_2 is connected to a power grid and find the stability condition in that case.

2) *When S_2 is connected to a power grid:* In this case, $\mathbb{P}(B \neq 0) = 1$, we have

$$\mu = q_1 (1 - q_2) p_{1/1} + q_1 q_2 p_{1/1,2}. \quad (11)$$

The queue is stable if and only if

$$q_1 > \frac{\lambda}{(1 - q_2) p_{1/1} + q_2 p_{1/1,2}}. \quad (12)$$

From the above inequality, we see that if $p_{1/1} > \lambda$ holds, we can always find q_1 and q_2 that satisfy the stability condition of S_1 .

B. Average Peak AoI of Node S_2

At time slot t , the AoI seen at the destination is defined by the difference between the current time t and the time slot $G(t)$ when the latest successfully received update was generated, given by

$$A(t) = t - G(t). \quad (13)$$

The AoI takes discrete integer numbers, i.e., $A(t) \in \{1, 2, \dots\}$, as shown in Fig. 2. Since each transmitted sample of node S_2 is always generated at the end of the previous slot, the AoI drops to 1 every time there is a successful reception of a status update at the destination. We have

$$A(t+1) = \begin{cases} 1 & \text{if successful reception at slot } t, \\ A(t) + 1 & \text{otherwise.} \end{cases} \quad (14)$$

Upon each successful reception of status update, the value of the AoI before dropping to 1 is counted as one peak.

Denote by \bar{A}_p the average peak AoI of the status updates from node S_2 . Let $T_s(t) = \mathbb{1}\{\text{successful reception at slot } t\}$ be the process representing the transmission success/failure in each slot, then (14) can be re-written as

$$A(t+1) = A(t) + 1 - T_s(t)A(t). \quad (15)$$

The average peak age is defined by

$$\bar{A}_p = \limsup_{t \rightarrow \infty} \frac{\mathbb{E} \left[\sum_{\tau=0}^{t-1} T_s(\tau) A(\tau) \right]}{\mathbb{E} \left[\sum_{\tau=0}^{t-1} T_s(\tau) \right]}. \quad (16)$$

Let X be a random variable (RV) denoting the time difference between two successful receptions of status updates. From Fig. 2, it is not difficult to establish the following relation

$$\bar{A}_p = \mathbb{E}[X]. \quad (17)$$

Between two successful receptions of status updates, there might be more than one attempted transmission. Let T_i represent the time difference between the $(i-1)$ -th and the i -th attempted transmissions, from Fig. 2, we have

$$X = \sum_{i=1}^M T_i, \quad (18)$$

where M is a RV representing the number of attempted transmissions between two successfully received status updates. Note that when $i = 1$, T_1 represents the time difference between the latest successfully received status update and the first attempted transmission after that. Since T_i is a stationary stochastic process, in the following we use $\mathbb{E}[T]$ to denote the expected value of T_i for an arbitrary i .

The average peak AoI becomes

$$\begin{aligned} \bar{A}_p &= \mathbb{E} \left[\sum_{i=1}^M T_i \right] = \sum_{m=1}^{\infty} m \mathbb{E}[T] \mathbb{P}(M = m) \\ &= \sum_{m=1}^{\infty} m \mathbb{E}[T] (1 - \bar{p}_2)^{m-1} \bar{p}_2 = \frac{\mathbb{E}[T]}{\bar{p}_2}, \end{aligned} \quad (19)$$

where \bar{p}_2 is the success probability of the transmission from S_2 , which is the weighted sum of $p_{2/2}$ and $p_{2/1,2}$. When the queue at S_1 is stable, we have

$$\bar{p}_2 = p_{2/2}(1 - q_1 \cdot \Pr[Q \neq 0]) + p_{2/1,2} q_1 \Pr[Q \neq 0] \quad (20)$$

$$= p_{2/2} - \frac{\lambda(p_{2/2} - p_{2/1,2})}{p_{1/1}(1 - \delta) + \delta p_{1/1,2}}, \quad (21)$$

which is independent of the transmission probabilities q_1 and q_2 . Therefore, maximizing the average peak AoI becomes equivalent to maximizing $\mathbb{E}[T]$ alone.

Since T is a discrete number representing the time difference between two consecutive attempted transmissions, the probability mass function of T is given by

$$\begin{aligned} \mathbb{P}(T = k) &= \mathbb{P}(B = 0) \sum_{l=1}^k (1 - \delta)^{k-l} \delta^l (1 - q_2)^{l-1} q_2 \\ &\quad + \mathbb{P}(B \neq 0) (1 - q_2)^{k-1} q_2. \end{aligned} \quad (22)$$

The first term is the probability that when the battery of S_2 is empty, S_2 does not attempt to transmit for $k-1$ consecutive slots, either because of no energy arrival or because it decides not to transmit. The second term is the probability that when the battery is non-empty, S_2 decides not to transmit for $k-1$ consecutive slots.

Since (22) involves $\mathbb{P}(B = 0)$, which depends on whether the energy queue B is stable. Here we consider two cases: when $\delta < q_2$ and when $\delta = 1$, respectively.

1) *When S_2 relies on EH:* When S_2 relies on harvested energy, recall that we have $\mathbb{P}(B \neq 0) = \frac{\delta}{q_2}$ when $\delta < q_2$. Let $A = \frac{\delta(1-q_2)}{1-\delta}$, after substituting $\mathbb{P}(B \neq 0) = \frac{\delta}{q_2}$ into (22), we have

$$\begin{aligned} \mathbb{P}(T = k) &= \left(1 - \frac{\delta}{q_2}\right) (1 - \delta)^k \frac{q_2}{1 - q_2} \sum_{l=1}^k A^l + \frac{\delta}{q_2} (1 - q_2)^{k-1} q_2 \\ &= \left(1 - \frac{\delta}{q_2}\right) \frac{q_2(1 - \delta)^k}{1 - q_2} \frac{A(1 - A^k)}{1 - A} + \delta(1 - q_2)^{k-1}. \end{aligned} \quad (23)$$

Then we obtain

$$\begin{aligned} \mathbb{E}[T] &= \sum_{k=1}^{\infty} k \mathbb{P}(T = k) \\ &= \frac{q_2 - \delta}{1 - q_2} \frac{A(1 - A(1 - \delta)^2)(1 - \delta)}{\delta^2(1 + A(1 - \delta)^2)} + \frac{\delta}{q_2}. \end{aligned} \quad (24)$$

The sum in (24) converges when $\delta > 0$.

2) *When S_2 is connected to a power grid:* In this case, since $\mathbb{P}(B \neq 0) = 1$, from (22) we have

$$\mathbb{P}(T = k) = (1 - q_2)^{k-1} q_2. \quad (25)$$

Then we obtain

$$\mathbb{E}[T] = \sum_{k=1}^{\infty} k \mathbb{P}(T = k) = \frac{1}{q_2}. \quad (26)$$

C. Peak Age Optimization with Stability Constraint

The optimal transmission probabilities can be determined by solving the following problem

$$\text{minimize}_{q_1, q_2} \quad \bar{A}_p \quad (27a)$$

$$\text{subject to} \quad \lambda < \mu, \quad (27b)$$

$$0 \leq q_1 \leq 1, \quad (27c)$$

$$0 \leq q_2 \leq 1, \quad (27d)$$

where μ is given in (9) when we assume $\delta < q_2$, otherwise μ is given in (11).

Theorem 1. *The solution to the optimization problem (27) is obtained as follows:*

- If $0 < \delta < \min \left\{ \frac{p_{1/1-\lambda}}{p_{1/1}-p_{1/1,2}}, 1 \right\}$, the optimal transmission probabilities are

$$q_1^* = \frac{\lambda}{p_{1/1}(1-\delta) + \delta p_{1/1,2}}, \quad (28)$$

$$q_2^* = \arg \max_{\delta < q_2 \leq 1} \mathbb{E}[T]. \quad (29)$$

- If $\delta \geq \min \left\{ \frac{p_{1/1-\lambda}}{p_{1/1}-p_{1/1,2}}, 1 \right\}$, the optimal transmission probabilities are

$$q_1^* = 1, \quad (30)$$

$$q_2^* = \min \left\{ \frac{p_{1/1} - \lambda}{p_{1/1} - p_{1/1,2}}, 1 \right\}. \quad (31)$$

Proof: See Appendix A. \square

IV. DYNAMIC SCHEDULING FOR PEAK AGE OPTIMIZATION WITH STABILITY CONSTRAINTS

In this section, we introduce the virtual queue technique from Lyapunov optimization to develop a dynamic scheduling policy that optimizes the average peak AoI of the EH node S_1 , subject to the stability condition of S_1 .

Let $\mathbf{U}(t) = (U_1(t), U_2(t))$ represent the scheduling decision in slot t , where $U_i = 1$ if node S_i is scheduled to transmit in time slot t , and $U_i = 0$ if S_i is inactive. For the two-user system we consider, there are four possible scheduling decisions, i.e., $\mathbf{U}(t) \in \{(1, 1), (1, 0), (0, 1), (0, 0)\}$.

In each slot t , depending on the scheduling decision $\mathbf{U}(t)$, the transmissions from S_1 and from S_2 will be successful with different probabilities. We define $b_i(t) = \mathbb{1}\{\text{SINR}_i(t) > \gamma|\mathbf{U}(t)\}$ as the successful transmission process of user i in time slot t given the scheduling decision $\mathbf{U}(t)$, and $p_i(t) = \mathbb{P}\{\text{SINR}_i(t) > \gamma|\mathbf{U}(t)\}$ as the conditional success probability. Note that when $U_i(t) = 0$, it is equivalent to having $\text{SINR}_i(t) = 0$ because when the signal power is zero, then we have $b_i(t) = 0$ and $p_i(t) = 0$. The relations between the conditional success probabilities $p_i(t)$ and the success probabilities defined in (3) and (4) are given by

$$p_1(t) = \begin{cases} p_{1/1,2} & \text{if } \mathbf{U}(t) = (1, 1), \\ p_{1/1} & \text{if } \mathbf{U}(t) = (1, 0), \\ 0 & \text{if } \mathbf{U}(t) = (0, 1), \\ 0 & \text{if } \mathbf{U}(t) = (0, 0), \end{cases} \quad (32)$$

$$p_2(t) = \begin{cases} p_{2/1,2} & \text{if } \mathbf{U}(t) = (1, 1), \\ 0 & \text{if } \mathbf{U}(t) = (1, 0), \\ p_{2/2} & \text{if } \mathbf{U}(t) = (0, 1), \\ 0 & \text{if } \mathbf{U}(t) = (0, 0). \end{cases} \quad (33)$$

In order to have a successful status update reception in slot t , node S_2 needs to have non-empty battery, it needs to be scheduled to transmit, and the transmission needs to be successful. Let $H(t) = \mathbb{1}\{B(t) > 0\}$ be the battery status

indicator. Recall that the successful transmission process of S_2 is defined by $b_2(t) = \mathbb{1}\{\text{SINR}_2(t) > \theta_2|\mathbf{U}(t)\}$. From the definition of the average peak age in (16), for the dynamic case we have

$$\bar{A}_p = \limsup_{t \rightarrow \infty} \frac{\mathbb{E} \left[\sum_{\tau=0}^{t-1} H(\tau) b_2(\tau) A(\tau) \right]}{\mathbb{E} \left[\sum_{\tau=0}^{t-1} H(\tau) b_2(\tau) \right]}. \quad (34)$$

It was proved in [34] that $\lim_{t \rightarrow \infty} \mathbb{E} \left[\frac{1}{t} \sum_{\tau=0}^{t-1} H(\tau) b_2(\tau) A(\tau) \right] = 1$ for any scheduling policy π that guarantees bounded age. This is an important property because it follows that minimizing the average peak age problem $\min_{\pi} \bar{A}_p$ is equivalent to the following problem

$$\text{maximize}_{x > 0, \pi} x \quad (35a)$$

$$\text{subject to } \liminf_{t \rightarrow \infty} \mathbb{E} \left[\frac{1}{t} \sum_{\tau=0}^{t-1} H(\tau) b_2(\tau) \right] \geq x, \quad (35b)$$

$$\bar{Q} < \infty, \quad (35c)$$

where x is an auxiliary variable. Note that the new problem is independent of the AoI in each time slot. We introduce a stochastic process $\alpha(t)$ which has time average $\lim_{t \rightarrow \infty} \mathbb{E} \left[\frac{1}{t} \sum_{\tau=0}^{t-1} \alpha(\tau) \right] = x$. The problem in (35) becomes

$$\text{maximize } \lim_{t \rightarrow \infty} \mathbb{E} \left[\frac{1}{t} \sum_{\tau=0}^{t-1} \alpha(\tau) \right] \quad (36a)$$

$$\text{subject to } \limsup_{t \rightarrow \infty} \mathbb{E} \left[\frac{1}{t} \sum_{\tau=0}^{t-1} (\alpha(\tau) - H(\tau) b_2(\tau)) \right] \leq 0, \quad (36b)$$

$$\bar{Q} < \infty, \quad (36c)$$

$$0 \leq \alpha(t) \leq \alpha_{\max}, \quad (36d)$$

$$\mathbf{U}(t) \in \{(1, 1), (1, 0), (0, 1), (0, 0)\}. \quad (36e)$$

This is a standard stochastic optimization problem. The inequality condition in (36b) can be transformed into a queue stability problem with the help of virtual queues. The rectangular constraint $0 \leq \alpha(t) \leq \alpha_{\max}$ is to make the auxiliary variable bounded, where α_{\max} is a suitably large constant.⁴ Using the well-known drift-plus-penalty technique, we can develop a dynamic scheduling algorithm as described in Algorithm 1.

This algorithm clearly requires centralized scheduling. In each slot, the network nodes report their local status information (queue size and battery size) to a centralized network scheduler. Then, the scheduling decisions are computed at the scheduler and communicated back to the nodes.

Theorem 2. *The dynamic scheduling algorithm guarantees that the data queue at node S_1 is strongly stable. The time average expected value of $\alpha(t)$ and queue backlog $Q(t)$ satisfy:*

$$\limsup_{t \rightarrow \infty} \frac{1}{t} \sum_{\tau=0}^{t-1} \mathbb{E}[Q(\tau)] \leq \frac{C + V}{1 - \lambda}, \quad (37)$$

⁴When adding the rectangular constraint $0 \leq \alpha(t) \leq \alpha_{\max}$ to the stochastic optimization problem, α_{\max} should be chosen large enough to contain the optimal time average utility, i.e., $0 \leq \alpha_{\text{opt}} \leq \alpha_{\max}$.

Algorithm 1 Dynamic Scheduling Algorithm (DSA)

- 1) Initialization: $Q(0) = 0$, $B(0) = 0$, $Z(0) = 0$. Choose appropriate values for the constant parameters α_{\max} and V . Set $t = 1$.
- 2) At current slot t , the network scheduler observes $Q(t)$, $Z(t)$ and $H(t)$, and make scheduling decision $\mathbf{U}(t)$ by solving

$$\underset{\mathbf{U}(t)}{\text{maximize}} \quad Z(t)H(t)p_2(t) + Q(t)p_1(t),$$

where $p_1(t)$ and $p_2(t)$ are given in (32) and (33).

- 3) The auxiliary variable $\alpha(t)$ is chosen as

$$\alpha(t) = \begin{cases} \alpha_{\max} & \text{if } Z(t) \leq V, \\ 0 & \text{otherwise.} \end{cases}$$

- 4) Update the data queue $Q(t)$, the energy queue $B(t)$, and the virtual queue $Z(t)$ as

$$Q(t+1) = \max[Q(t) - b_1(t), 0] + a_1(t),$$

$$B(t+1) = \max[B(t) - s(t), 0] + a_2(t),$$

$$Z(t+1) = \max[Z(t) + \alpha(t) - H(t)b_2(t), 0],$$

where $s(t) = \mathbb{1}\{U_2(t) = 1\}$, $H(t) = \mathbb{1}\{B(t) > 0\}$, and $b_i(t) = \mathbb{1}\{\text{SINR}_i(t) > \gamma | \mathbf{U}(t)\}$, $\forall i = 1, 2$.

- 5) Repeat steps 2–5 for the next slot $t + 1$.
-

$$\limsup_{t \rightarrow \infty} \frac{1}{t} \sum_{\tau=0}^{t-1} \mathbb{E}[\alpha(\tau)] \geq \alpha_{\text{opt}} - \frac{C}{V}, \quad (38)$$

where $C = \frac{\alpha_{\max}^2 + \lambda^2 + 2}{2}$, α_{opt} is the optimal solution to the problem defined in (36), V is a constant parameter that affects the tradeoff between the performance optimization and the queue congestion.

Proof: See Appendix B. \square

Combining (37) and (38), the theorem shows that with larger V and smaller α_{\max} , the time average of $\alpha(t)$ approaches the optimum point. However, larger V increases the congestion in the queue backlog and also increases the time for the algorithm to converge. Recall that α_{\max} must be chosen sufficiently large such that $0 \leq \alpha_{\text{opt}} \leq \alpha_{\max}$. When the constraint in (36b) is satisfied, we have $\bar{\alpha} \leq 1$ because $H(t) = \{0, 1\}$ and $b_2(t) = \{0, 1\}$. Then, $\alpha_{\max} = 1$ is a suitably large value to guarantee that the optimal solution α_{opt} is a feasible solution in the constraint (36d).

This dynamic scheduling algorithm can be easily extended to the case with $K > 1$ energy harvesting nodes, while the scheduling decision space grows exponentially with K .

V. SIMULATION RESULTS

In this section, we evaluate the performance of the stationary and dynamic policies through simulations and compare the average peak AoI obtained with these two policies.

Since our analytical results of the delay and AoI do not require any specific propagation/path loss model, the parameters we use in this section are: $\frac{P_1\beta_1}{\sigma^2} = 10$ dB, $\frac{P_2\beta_2}{\sigma^2} = 12$ dB, $\theta_1 =$

$\theta_2 = 2$ dB, which gives success probabilities: $p_{1/1} = 0.8534$, $p_{1/1,2} = 0.243$, $p_{2/2} = 0.905$, $p_{2/1,2} = 0.4524$. In the dynamic policy, we choose $V = 50$ and $\alpha_{\max} = 1$. The simulation results are obtained after 5×10^4 time slots.⁵

A. Impact of Data Arrival Rate λ

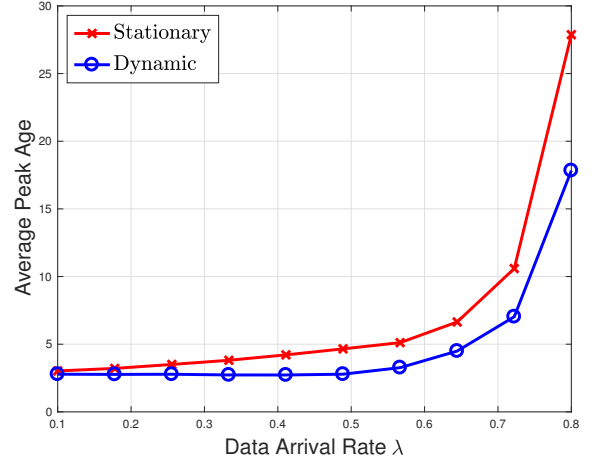

Fig. 3. Average peak AoI vs. data arrival probability λ , obtained with stationary and dynamic policies. Energy arrival probability $\delta = 0.4$.

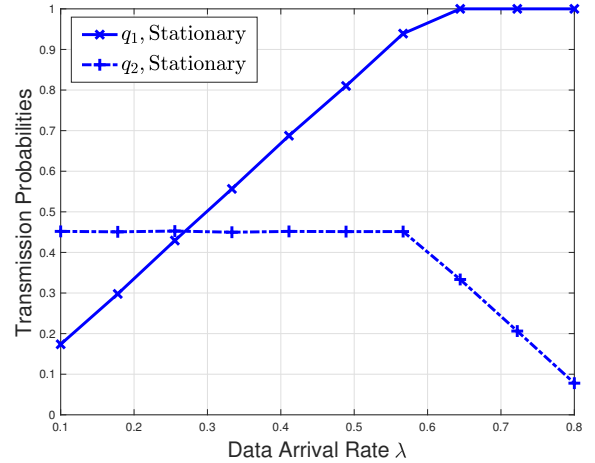

Fig. 4. Optimal transmission probabilities vs. data arrival probability λ , when the stationary scheduling policy is applied. Energy arrival probability $\delta = 0.4$.

In Fig. 3, we plot the average peak AoI obtained with the two proposed scheduling policies, for different values of the data arrival probability λ . These policies are optimal among stationary and dynamic policies. Note that the stability limit of node S_1 depends on its maximum service probability. Since $p_{1/1} = 0.8534$, for any data arrival rate that satisfies $\lambda < p_{1/1}$, we can always stabilize the queue of S_1 by limiting the

⁵We choose sufficiently long simulation time to make sure that the Markov chains reach their steady state distributions.

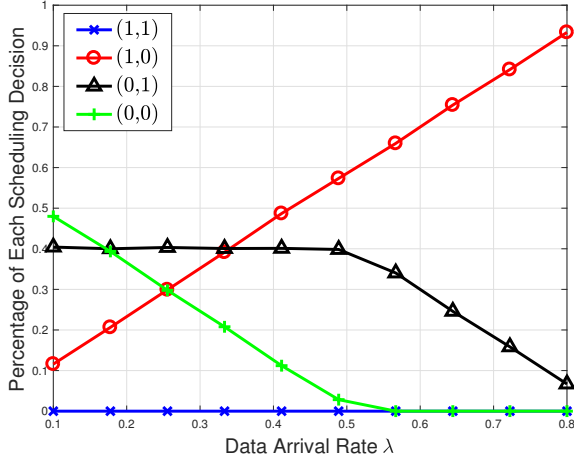

Fig. 5. Percentages of slots for each transmission decision vs. data arrival probability λ , when the dynamic policy is applied. Same parameters with Fig. 3.

transmission opportunities of S_2 . From Fig. 3, we observe that the dynamic scheduling policy achieves lower average peak AoI than the stationary one. To explain the reason behind this observation, we show in Fig. 4 the optimal transmission probabilities with the stationary policy, and in Fig. 5 we show the percentage of time slots associated with each possible scheduling decision in the dynamic case. First, from Fig. 4 we see that the optimal transmission probability of S_1 with the stationary policy increases with λ until it reaches 1. This is expected as higher data arrival probability requires more frequent transmissions from node S_1 . However, the optimal transmission probability of node S_2 first remains constant for small values of λ , then decreases with λ . This is because when λ is small, the optimal transmission probability of node S_2 is independent of λ , as shown in (29).

As we can see from Fig. 5, with the dynamic scheduling policy, the percentage for the scheduling decision $\mathbf{U}(t) = (1, 1)$ is 0, meaning that the two nodes are never active at the same time. This is because when both nodes are interfering with each other, the success probabilities $p_{1/1,2}$ and $p_{2/1,2}$ are much lower than in the case with only one active node. In this case, it is better to schedule at most one active node in each time slot, and this cannot be achieved by the stationary policy as the transmission decisions are random. We can also observe that the percentage of scheduling $(0, 1)$ remains the same when the data arrival probability is low, and then it decreases with λ . This is so because when the data arrival probability is high, node S_1 needs to be scheduled more often in order to satisfy the stability condition.

B. Impact of Energy Arrival Rate δ

In Fig. 6, we present a comparison of the average peak AoI obtained with both scheduling policies, when the data arrival probability is fixed. The results are presented for different values of the energy arrival probability δ . We also observe the

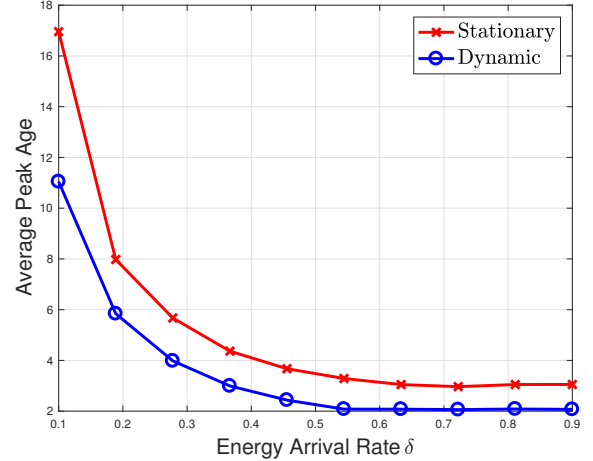

Fig. 6. Average peak AoI vs. energy arrival probability δ , obtained with stationary and dynamic policies. Data arrival probability $\lambda = 0.4$.

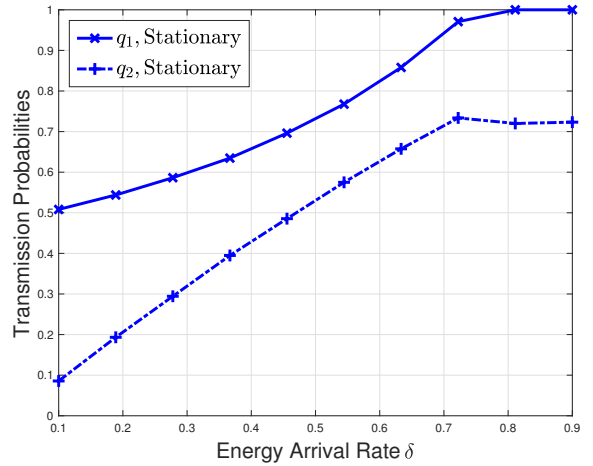

Fig. 7. Optimal transmission probabilities vs. energy arrival probability δ , when the stationary scheduling policy is applied. Data arrival probability $\lambda = 0.4$.

advantage of using the dynamic scheduling policy, especially when the energy arrival probability is low.

From Fig. 7, we see that with the stationary policy, the optimal transmission probabilities for both nodes increase with δ first, then remain the same. This is because when $\delta < \min \left\{ \frac{p_{1/1-\lambda}}{p_{1/1}-p_{1/1,2}}, 1 \right\}$, the optimal transmission probability q_2 is higher when the energy arrival probability is higher. In order to keep the queue of S_1 stable, the transmission probability of node S_1 also needs to be higher. When $\delta > \min \left\{ \frac{p_{1/1-\lambda}}{p_{1/1}-p_{1/1,2}}, 1 \right\}$, from Theorem 1, the optimal transmission probabilities for both nodes are independent of λ .

C. Special Case: $\delta = 1$

To show the impact of the energy limitation on the age, we present in Fig. 8 the average peak AoI of node S_2 when it is connected to the power grid, i.e., $H(t) = 1, \forall t$. Compared to the

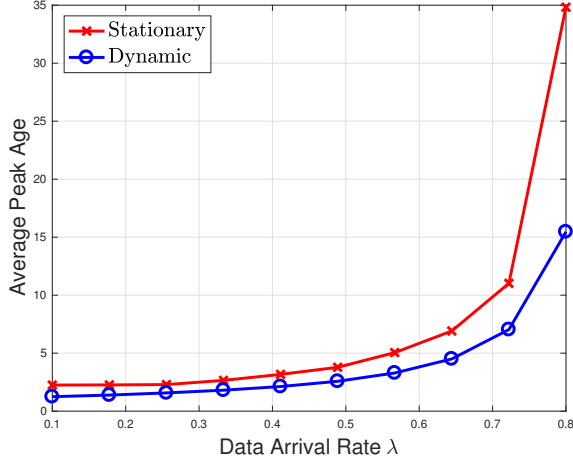

Fig. 8. Average peak AoI vs. data arrival probability λ , obtained with stationary and dynamic policies. Energy arrival probability $\delta = 1$.

results in Fig. 3, we see that for both scheduling policies, the average peak age is smaller when node S_2 does not have energy limitation, especially when λ is low. This is because when the data arrival probability is low, the required service probability of node S_1 with a stable queue is small. Node S_2 could transmit more often if it would not have any energy limitation, which results in reduced age. On the other hand, when the data arrival probability λ is high, node S_2 should not transmit too often in order to satisfy the queue stability condition of S_1 . Then, the age of the status updates is mainly limited by the transmission decisions of S_2 instead of its battery status.

D. Impact of MPR capability

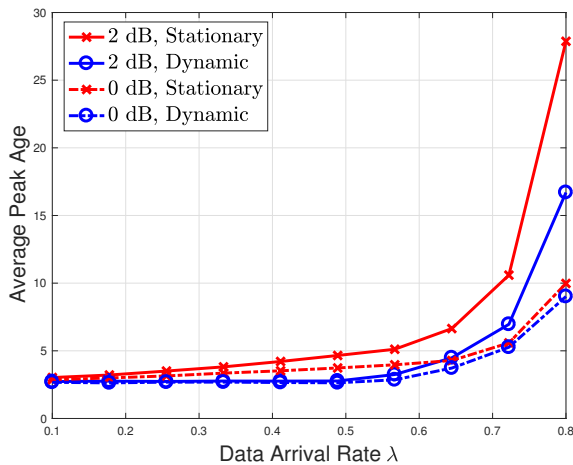

Fig. 9. Average peak AoI vs. data arrival probability λ , obtained with stationary and dynamic policies. Energy arrival probability $\delta = 0.4$.

The SINR thresholds for successful transmission affect the success probabilities when both nodes are active. When considering $\theta_1 = \theta_2 = 0$ dB, we have the following success

probabilities: $p_{1/1} = 0.99$, $p_{1/1,2} = 0.383$, $p_{2/2} = 0.994$, $p_{2/1,2} = 0.609$. In Fig. 9, we compare the average peak AoI obtained with $\theta_1 = \theta_2 = 0$ dB and $\theta_1 = \theta_2 = 2$ dB. By comparing the difference between the two policies, we notice that when θ_1 and θ_2 are high, the advantage of the dynamic policy is more profound. This is because with high SINR thresholds, the success probabilities $p_{1/1,2}$ and $p_{2/1,2}$ when both nodes are active are very low, which means that the destination node has very weak MPR capability. The dynamic policy can avoid scheduling both nodes transmitting at the same time, thus achieving higher service probabilities for both nodes. On the other hand, with lower θ_1 and θ_2 , the difference between these two policies becomes much smaller. It means that if the destination node has strong MPR capability, the optimized stationary policy is a good option because it can be easily implemented in a distributed manner and the achieved average peak age is close-to-optimal.

VI. CONCLUSIONS

In this work, we studied the peak-age-optimal scheduling in a multiple access channel where two source nodes with different power supplies generate heterogeneous traffic. One grid-connected source node has bursty data arrivals and another node with EH capability sends fresh status updates to a common destination. An optimization problem was formulated to minimize the average peak AoI of the energy harvesting node with respect to the stability condition of the grid-connected node. We solved this problem by considering a stationary scheduling policy with random access decisions and a dynamic scheduling algorithm by using the Lyapunov optimization framework. Simulations results showed that the dynamic policy clearly outperforms the stationary one when the destination node has weak MPR capability, but it requires centralized scheduling with exchange of information in every slot. On the other hand, the stationary policy is easy to implement in a distributed way, and the performance difference between these two policies becomes smaller when the destination node has stronger MPR capability.

APPENDIX

A. Proof of Theorem 1

When S_2 relies on EH and assuming $q_2 > \delta$, the optimal value of q_1 is the minimum value of q_1 that guarantees queue stability of S_1 . From (10) we have

$$q_1^* = \frac{\lambda}{p_{1/1}(1-\delta) + \delta p_{1/1,2}}. \quad (39)$$

From (19) and (24), we see that the optimal value of q_2 is the one that maximizes $\mathbb{E}[T]$ in (24) with the additional assumption $q_2 > \delta$. Then we have

$$q_2^* = \arg \max_{\delta < q_2 \leq 1} \mathbb{E}[T]. \quad (40)$$

Since the optimal probability q_1^* in (10) cannot be larger than 1, we have $\lambda < p_{1/1}(1-\delta) + \delta p_{1/1,2}$, which corresponds to $\delta < \frac{p_{1/1}-\lambda}{p_{1/1}-p_{1/1,2}}$. Combining with $0 < \delta < 1$, the condition for

which we can find the optimal transmission probabilities by using (39) and (40) is

$$0 < \delta < \min \left\{ \frac{p_{1/1} - \lambda}{p_{1/1} - p_{1/1,2}}, 1 \right\}. \quad (41)$$

When $\delta \geq \min \left\{ \frac{p_{1/1} - \lambda}{p_{1/1} - p_{1/1,2}}, 1 \right\}$, the optimal values of q_1 and q_2 cannot be found by (39) and (40), because the assumption of $q_2 > \delta$ reduces the searching space of the optimal transmission probabilities. When $q_2 \leq \delta$, since the energy queue size does not have a unique stationary distribution, it is equivalent to the system with S_2 connected to a power grid. Then, we can disregard the energy queue and search for the optimal transmission probabilities without energy limitation.

When S_2 is connected to a power grid, from (19) and (26) we see that the average peak AoI is inversely proportional to q_2 . Thus, the optimal value of q_2 is the maximum value of q_2 that satisfies the queue stability condition in (12). From (12) we have

$$q_2 < \frac{p_{1/1} - \lambda/q_1}{p_{1/1} - p_{1/1,2}}. \quad (42)$$

The maximum value of q_2 is achieved when $q_1 = 1$. Thus, we have the optimal transmission probabilities when S_2 does not have energy limitation, given by

$$q_1^* = 1, \quad (43)$$

$$q_2^* = \min \left\{ \frac{p_{1/1} - \lambda}{p_{1/1} - p_{1/1,2}}, 1 \right\}. \quad (44)$$

This result shows that without energy limitation, both nodes should transmit as often as possible while respecting the queue stability condition at S_1 .

Summarizing the results in (39), (40), (43), (44), and the respective conditions, we obtain Theorem 1.

B. Proof of Theorem 2

The condition in (36b) can be transformed into a queue stability problem. We define the virtual queue $Z(t)$ that updates by the following equation:

$$Z(t+1) = \max[Z(t) + \alpha(t) - H(t)b_2(t), 0], \quad (45)$$

with $0 \leq \alpha(t) \leq \alpha_{\max}$. We define $\Theta(t) = [Z(t), Q(t)]$ and consider the Lyapunov function $\mathcal{L}(\Theta(t)) = \frac{1}{2}Q^2(t) + \frac{1}{2}Z^2(t)$ and the one-slot conditional Lyapunov drift is given by

$$\Delta(t) = \mathbb{E}[\mathcal{L}(\Theta(t+1)) - \mathcal{L}(\Theta(t)) | \Theta(t)]. \quad (46)$$

From (45) and the queue evolution $Q(t+1) = \max[Q(t) - b_1(t), 0] + a_1(t)$, the Lyapunov drift is bounded by

$$\begin{aligned} \Delta(t) \leq & \frac{\mathbb{E}[\alpha^2(t) + H^2(t)b_2^2(t) + a_1^2(t) + b_1^2(t) | \Theta(t)]}{2} \\ & + \mathbb{E}[Q(t)(a_1(t) - b_1(t)) | \Theta(t)] \\ & + \mathbb{E}[Z(t)(\alpha(t) - H(t)b_2(t)) | \Theta(t)]. \end{aligned} \quad (47)$$

We know that $\mathbb{E}[a_1(t) | \Theta(t)] = \mathbb{E}[a_1(t)] = \lambda$, $\mathbb{E}[\alpha(t) | \Theta(t)] \leq \alpha_{\max}$, $\mathbb{E}[H(t)b_2(t) | \Theta(t)] \leq 1$, and $\mathbb{E}[b_1(t) | \Theta(t)] \leq 1$. Define $C = \frac{\alpha_{\max}^2 + \lambda^2 + 2}{2}$, we have

$$\begin{aligned} \Delta(t) \leq & C + \mathbb{E}[Q(t)(a_1(t) - b_1(t)) | \Theta(t)] \\ & + \mathbb{E}[Z(t)(\alpha(t) - H(t)b_2(t)) | \Theta(t)]. \end{aligned} \quad (48)$$

Since $p_i(t) = \mathbb{E}[b_i(t)]$ for $i = \{1, 2\}$, the drift-plus-penalty is bounded by

$$\begin{aligned} \Delta(t) - V\mathbb{E}[\alpha(t) | \Theta(t)] \leq & C - \mathbb{E}[Z(t)H(t)p_2(t) + Q(t)p_1(t) | \Theta(t)] \\ & + \mathbb{E}[\alpha(t)(Z(t) - V) | \Theta(t)] + \lambda Q(t), \end{aligned} \quad (49)$$

where V is a constant parameter representing the relative weight on performance optimization.

We consider opportunistically optimizing the conditional expectation of the upper bound on the drift-plus-penalty, which results in the following two sub-problems:

- Observe $Z(t)$, $H(t)$ and $Q(t)$, choose the scheduling decision that maximizes $Z(t)H(t)p_2(t) + Q(t)p_1(t)$;
- Choose $0 \leq \alpha(t) \leq \alpha_{\max}$ that minimizes $\alpha(t)(Z(t) - V)$, which gives

$$\alpha(t) = \begin{cases} \alpha_{\max} & \text{if } Z(t) \leq V, \\ 0 & \text{otherwise.} \end{cases}$$

Then we obtain the dynamic scheduling algorithm described in Algorithm 1.

In the following, we show that this algorithm stabilizes the network and achieves arbitrarily close performance to the optimal solution of (36). Consider an alternative S-only policy, there exists $\epsilon > 0$ such that the resulting values $b_1^*(t)$, $b_2^*(t)$, $H^*(t)$ and $\alpha^*(t)$ of the S-only policy satisfy:

$$\mathbb{E}[b_1^*(t)] \geq \lambda + \epsilon, \quad (50)$$

$$\mathbb{E}[H^*(t)b_2^*(t)] - \mathbb{E}[\alpha^*(t)] \geq \epsilon, \quad (51)$$

$$\mathbb{E}[\alpha^*(t)] = \alpha^*(\epsilon), \quad (52)$$

where $0 \leq \alpha^*(\epsilon) \leq \alpha^{\text{opt}}$ is a sub-optimal solution to the stochastic optimization problem defined in (36). Plugging them into the right-hand side of (49), and taking iterated expectations on both side, we have

$$\begin{aligned} \mathbb{E}[\mathcal{L}(\Theta(t+1))] - \mathbb{E}[\mathcal{L}(\Theta(t))] - V\mathbb{E}[\alpha(t)] \\ \leq C - \epsilon\mathbb{E}[Q(t)] - \epsilon\mathbb{E}[Z(t)] - V\alpha^*(\epsilon). \end{aligned} \quad (53)$$

This inequality holds for any value of ϵ that is bounded by $0 \leq \epsilon \leq 1 - \lambda$. Summing over $\tau = 0, \dots, t-1$, after rearranging terms, we obtain

$$\begin{aligned} \sum_{\tau=0}^{t-1} \mathbb{E}[Q(\tau)] + \sum_{\tau=0}^{t-1} \mathbb{E}[Z(\tau)] \leq t \frac{C + V(\mathbb{E}[\alpha(t)] - \alpha^*(\epsilon))}{\epsilon} \\ - \frac{\mathbb{E}[\mathcal{L}(\Theta(t))] - \mathbb{E}[\mathcal{L}(\Theta(0))]}{\epsilon}. \end{aligned} \quad (54)$$

Neglecting the non-negative terms, dividing both sides by t yields:

$$\begin{aligned} \frac{1}{t} \sum_{\tau=0}^{t-1} \mathbb{E}[Q(\tau)] \leq \frac{C + V(\mathbb{E}[\alpha(t)] - \alpha^*(\epsilon))}{\epsilon} \\ + \frac{\mathbb{E}[\mathcal{L}(\Theta(0))]}{t\epsilon}. \end{aligned} \quad (55)$$

Since $\mathbb{E}[\alpha(t)] \leq \alpha^{\text{opt}}$ where α^{opt} is the optimal solution, taking limitation as $t \rightarrow \infty$, we have

$$\limsup_{t \rightarrow \infty} \frac{1}{t} \sum_{\tau=0}^{t-1} \mathbb{E}[Q(t)] \leq \frac{C + V(\alpha^{\text{opt}} - \alpha^*(\epsilon))}{\epsilon}. \quad (56)$$

This shows that the queue of S_1 is strongly stable. Furthermore, knowing that $0 \leq \alpha^{\text{opt}} < 1$ because $\mathbb{E}[H(t)b_2(t)] \leq 1$, and $0 \leq \alpha^*(\epsilon) \leq \alpha^{\text{opt}}$, the queue backlog is bounded by

$$\limsup_{t \rightarrow \infty} \frac{1}{t} \sum_{\tau=0}^{t-1} \mathbb{E}[Q(t)] \leq \frac{C + V}{\epsilon}. \quad (57)$$

Since this inequality holds for any value of ϵ bounded by $0 \leq \epsilon \leq 1 - \lambda$, we have

$$\limsup_{t \rightarrow \infty} \frac{1}{t} \sum_{\tau=0}^{t-1} \mathbb{E}[Q(t)] \leq \frac{C + V}{1 - \lambda}. \quad (58)$$

The second part of Theorem 2 follows from (53), when $\epsilon \rightarrow 0$, summing over $\tau = 0, \dots, t-1$, after rearranging terms, we have

$$\frac{1}{t} \sum_{\tau=0}^{t-1} \mathbb{E}[\alpha(t)] \geq \frac{\mathbb{E}[\mathcal{L}(\Theta(t))] - \mathbb{E}[\mathcal{L}(\Theta(0))] - tC}{tV} + \alpha^{\text{opt}} \quad (59)$$

$$\geq -\frac{\mathbb{E}[\mathcal{L}(\Theta(0))]}{tV} - \frac{C}{V} + \alpha^{\text{opt}} \quad (60)$$

Taking limitation as $t \rightarrow \infty$, we have

$$\limsup_{t \rightarrow \infty} \frac{1}{t} \sum_{\tau=0}^{t-1} \mathbb{E}[\alpha(t)] \geq \alpha^{\text{opt}} - \frac{C}{V}. \quad (61)$$

REFERENCES

- [1] Z. Chen, N. Pappas, E. Björnson, and E. G. Larsson, "Age of information in a multiple access channel with heterogeneous traffic and an energy harvesting node," in *IEEE Conf. on Computer Commun. Workshops (INFOCOM WKSHPs)*, Apr. 2019.
- [2] A. Kosta, N. Pappas, and V. Angelakis, "Age of information: A new concept, metric, and tool," *Foundations and Trends® in Networking*, vol. 12, no. 3, pp. 162–259, 2017.
- [3] E. Altman, R. El-Azouzi, D. S. Menasche, and Y. Xu, "Forever young: Aging control for hybrid networks," in *Proc. of the ACM Intl. Symposium on Mobile Ad Hoc Networking and Computing*, ser. Mobihoc '19. New York, NY, USA: ACM, 2019, pp. 91–100.
- [4] S. Kaul, M. Gruteser, V. Rai, and J. Kenney, "Minimizing age of information in vehicular networks," in *IEEE Commun. Society Conf. on Sensor, Mesh and Ad Hoc Commun. and Networks (SECON)*, June 2011.
- [5] S. Kaul, R. Yates, and M. Gruteser, "Real-time status: How often should one update?" in *IEEE Conf. on Computer Commun. (INFOCOM)*, Mar. 2012.
- [6] A. Kosta, N. Pappas, A. Ephremides, and V. Angelakis, "Age and value of information: Non-linear age case," in *IEEE Intl. Symposium on Information Theory (ISIT)*, June 2017.
- [7] Y. Sun and B. Cyr, "Sampling for data freshness optimization: Non-linear age functions," *Journal of Commun. and Networks*, vol. 21, no. 3, pp. 204–219, June 2019.
- [8] B. T. Bacinoglu, E. T. Ceran, and E. Uysal-Biyikoglu, "Age of information under energy replenishment constraints," in *Information Theory and Applications Workshop (ITA)*, Feb. 2015.
- [9] R. D. Yates, "Lazy is timely: Status updates by an energy harvesting source," in *IEEE Intl. Symposium on Information Theory (ISIT)*, June 2015.
- [10] A. Arafa and S. Ulukus, "Age minimization in energy harvesting communications: Energy-controlled delays," in *51st Asilomar Conf. on Signals, Systems, and Computers*, Oct. 2017.
- [11] —, "Age-minimal transmission in energy harvesting two-hop networks," in *IEEE Global Commun. Conf. (GLOBECOM)*, Dec. 2017.
- [12] X. Wu, J. Yang, and J. Wu, "Optimal status update for age of information minimization with an energy harvesting source," *IEEE Trans. on Green Commun. and Networking*, vol. 2, no. 1, pp. 193–204, March 2018.
- [13] B. T. Bacinoglu and E. Uysal-Biyikoglu, "Scheduling status updates to minimize age of information with an energy harvesting sensor," in *IEEE Intl. Symposium on Information Theory (ISIT)*, June 2017.
- [14] A. Arafa, J. Yang, and S. Ulukus, "Age-minimal online policies for energy harvesting sensors with random battery recharges," in *IEEE Intl. Conf. on Commun. (ICC)*, May 2018.
- [15] A. Arafa, J. Yang, S. Ulukus, and H. V. Poor, "Age-minimal online policies for energy harvesting sensors with incremental battery recharges," in *Information Theory and Applications Workshop (ITA)*, Feb. 2018.
- [16] S. Farazi, A. G. Klein, and D. R. Brown, "Average age of information for status update systems with an energy harvesting server," in *IEEE Conf. on Computer Commun. Workshops (INFOCOM WKSHPs)*, Apr. 2018.
- [17] G. Stamatakis, N. Pappas, and A. Traganitis, "Control of status updates for energy harvesting devices that monitor processes with alarms," vol. abs/1907.03826, 2019. [Online]. Available: <http://arxiv.org/abs/1907.03826>
- [18] A. Baknina and S. Ulukus, "Coded status updates in an energy harvesting erasure channel," in *52nd Annual Conf. on Information Sciences and Systems (CISS)*, Mar. 2018.
- [19] A. Baknina, S. Ulukus, O. Ozel, J. Yang, and A. Yener, "Sensing information through status updates," in *IEEE Intl. Symposium on Information Theory (ISIT)*, June 2018.
- [20] B. T. Bacinoglu, Y. Sun, E. Uysal-Biyikoglu, and V. Mutlu, "Achieving the age-energy tradeoff with a finite-battery energy harvesting source," in *IEEE Intl. Symposium on Information Theory (ISIT)*, June 2018.
- [21] S. Feng and J. Yang, "Optimal status updating for an energy harvesting sensor with a noisy channel," in *IEEE Conf. on Computer Commun. Workshops (INFOCOM WKSHPs)*, Apr. 2018.
- [22] —, "Minimizing age of information for an energy harvesting source with updating failures," in *IEEE Intl. Symposium on Information Theory (ISIT)*, June 2018.
- [23] B. T. Bacinoglu, Y. Sun, E. Uysal, and V. Mutlu, "Optimal status updating with a finite-battery energy harvesting source," *Journal of Commun. and Networks*, vol. 21, no. 3, pp. 280–294, June 2019.
- [24] Z. Chen, N. Pappas, and M. Kountouris, "Energy harvesting in delay-aware cognitive shared access networks," in *IEEE Intl. Conf. on Commun. Workshops (ICC Workshops)*, May 2017.
- [25] I. Krikidis, "Average age of information in wireless powered sensor networks," vol. 8, no. 2, pp. 628–631, Apr. 2019.
- [26] M. A. Abd-Elmagid, N. Pappas, and H. S. Dhillon, "On the role of age-of-information in Internet of Things," *IEEE Commun. Magazine*, to appear, 2019.
- [27] S. Ghez, S. Verdu, and S. Schwartz, "Stability properties of slotted Aloha with multipacket reception capability," *IEEE Trans. on Automatic Control*, vol. 33, no. 7, pp. 640–649, Jul. 1988.
- [28] V. Naware, G. Mergen, and L. Tong, "Stability and delay of finite-user slotted aloha with multipacket reception," *IEEE Trans. on Inform. Theory*, vol. 51, no. 7, pp. 2636–2656, Jul. 2005.
- [29] A. Kosta, N. Pappas, A. Ephremides, and V. Angelakis, "Age of information performance of multiaccess strategies with packet management," *Journal of Commun. and Networks*, vol. 21, no. 3, pp. 244–255, June 2019.
- [30] G. Stamatakis, N. Pappas, and A. Traganitis, "Controlling status updates in a wireless system with heterogeneous traffic and AoI constraints," in *IEEE Global Commun. Conf. (GLOBECOM)*, Dec. 2019.
- [31] A. Kosta, N. Pappas, A. Ephremides, and V. Angelakis, "Age of information and throughput in a shared access network with heterogeneous traffic," in *IEEE Global Commun. Conf. (GLOBECOM)*, Dec. 2018.
- [32] S. Gopal and S. K. Kaul, "A game theoretic approach to DSRC and WiFi coexistence," in *IEEE Conf. on Computer Commun. Workshops (INFOCOM WKSHPs)*, Apr. 2018.
- [33] S. Leng and A. Yener, "Age of information minimization for an energy harvesting cognitive radio," *IEEE Trans. on Cognitive Commun. and Networking*, vol. 5, no. 2, pp. 427–439, June 2019.
- [34] R. Talak, S. Karaman, and E. Modiano, "Optimizing age of information in wireless networks with perfect channel state information," in *Intl. Symposium on Modeling and Optimization in Mobile, Ad Hoc, and Wireless Networks (WiOpt)*, May 2018.

- [35] I. Kadota, A. Sinha, and E. Modiano, "Scheduling algorithms for optimizing age of information in wireless networks with throughput constraints," *IEEE/ACM Trans. on Networking*, vol. 27, no. 4, pp. 1359–1372, Aug 2019.
- [36] L. Georgiadis, M. J. Neely, and L. Tassiulas, "Resource allocation and cross-layer control in wireless networks," *Foundations and Trends® in Networking*, vol. 1, no. 1, pp. 1–144, 2006.
- [37] M. J. Neely, "Stochastic network optimization with application to communication and queueing systems," *Synthesis Lectures on Communication Networks*, vol. 3, no. 1, pp. 1–211, 2010.
- [38] A. Dua, "Random access with multi-packet reception," *IEEE Transactions on Wireless Communications*, vol. 7, no. 6, pp. 2280–2288, June 2008.
- [39] R. Talak, S. Karaman, and E. Modiano, "Optimizing information freshness in wireless networks under general interference constraints," in *ACM Intl. Symposium on Mobile Ad Hoc Networking and Computing*, ser. Mobihoc '18. New York, NY, USA: ACM, 2018.