

Optimizing Information Freshness in a Multiple Access Channel with Heterogeneous Devices

Zheng Chen, Nikolaos Pappas, Emil Björnson, and Erik G. Larsson

In this work, we study age-optimal scheduling with stability constraints in a multiple access channel with two heterogeneous source nodes transmitting to a common destination. The first node is connected to a power grid and it has randomly arriving data packets. Another energy harvesting (EH) sensor monitors a stochastic process and sends status updates to the destination. We formulate an optimization problem that aims at minimizing the average age of information (AoI) of the EH node subject to the queue stability condition of the grid-connected node. First, we consider a *Probabilistic Random Access* (PRA) policy where both nodes make independent transmission decisions based on some fixed probability distributions. We show that with this policy, the average AoI is equal to the average peak AoI, if the EH node only sends freshly generated samples. In addition, we derive the optimal solution in closed form, which reveals some interesting properties of the considered system. Furthermore, we consider a *Drift-Plus-Penalty* (DPP) policy and develop AoI-optimal and peak-AoI-optimal scheduling algorithms using the Lyapunov optimization theory. Simulation results show that the DPP policy outperforms the PRA policy in various scenarios, especially when the destination node has low multi-packet reception capabilities.

Index Terms—Age of Information, Energy Harvesting, Lyapunov Optimization, Multiple Access Channel, Random Access, Scheduling.

I. INTRODUCTION

THE Age of Information (AoI) is a newly emerged metric and tool to capture the timeliness and freshness of data reception [2]–[6]. Consider a monitored source node which generates time-stamped status updates, and transmits them through a wireless channel or through a network to a destination. The AoI that the destination has for the source is the elapsed time since the generation of the last received update. Keeping the average AoI small corresponds to having fresh information, which is critical for time-sensitive applications in the Internet of Things (IoT) scenarios and future wireless systems [7], [8]. This notion has been extended to other metrics such as the value of information, cost of update delay, and non-linear AoI [9], [10].

The deployment of energy harvesting (EH) sensors is envisioned as an efficient solution for energy-efficient and self-sustainable networks, especially in the IoT networks where devices opportunistically transmit small amounts of data with low power consumption [11]. Sensors with EH capabilities can convert ambient energy (e.g., solar power or thermal energy) into electrical energy that can be used for sending status updates to the destination nodes.

Though AoI analysis and optimization have been investigated in many different systems and scenarios, prior works in the literature consider either single access channel or multiple access channel (MAC) with orthogonal scheduling. In our work, we expand the current literature to the case with a MAC channel and multi-packet reception capabilities at the receiver side. Studying age-optimal status updating with EH

nodes, especially with the presence of interference in a MAC channel, is a non-trivial task.

A. Related Works

In [12], the authors consider the problem of optimizing the process of sending updates from an EH source to minimize the time average age of updates. Similar analysis can be found in [13]–[20]. In [21], an erasure channel is considered where an EH-enabled transmitter sends coded status updates to the receiver to minimize the AoI. In [22], an EH transmitter is assumed to encode a message into the timings of the status updates. The age-energy tradeoff is explored in [23], where a finite-battery source is charged intermittently by Poisson energy arrivals. The timeliness-distortion tradeoff of an EH-powered system is investigated in [24]. In [25], the optimal status updating policy for an EH source with a noisy channel is investigated. The possibility of update failures is considered in [26].

In addition to the case with nodes harvesting ambient energy, some other works have considered wireless power transfer (WPT) to convert the received radio frequency signals to electric power. In [27], the performance of a WPT-powered sensor network in terms of the average AoI was studied. The work in [28] considers freshness-aware IoT networks with EH-enabled IoT devices. More specifically, the optimal sampling policy for IoT devices that minimizes the long-term weighted sum-AoI is investigated.

In a network with multiple source nodes, assuming multi-packet reception (MPR) capabilities at the receiver, the transmissions from multiple source nodes will be successful with some probabilities that depend on the received signal-to-interference-plus-noise ratio (SINR) [29], [30]. Recently, some works have considered different types of traffic associated with different source nodes, e.g., some nodes generate time-sensitive status updates, and other nodes strive to achieve as large throughput as possible. The impact of heterogeneous

Z. Chen, E. Björnson, and E. G. Larsson are with the Department of Electrical Engineering, Linköping University, 58183 Linköping, Sweden. Email: {zheng.chen, emil.bjornson, erik.g.larsson}@liu.se.

N. Pappas is with the Department of Science and Technology, Linköping University, 60174 Norrköping, Sweden. Email: nikolaos.pappas@liu.se.

A part of this work was presented in IEEE INFOCOM Workshops (AoI'19) [1]. This work was supported in part by ELLIIT, CENIIT, and the Swedish Foundation for Strategic Research (SSF).

traffic on the AoI and the optimal update policy has been investigated in [31]. The work in [32] investigates Nash and Stackelberg equilibrium strategies for DSRC and WiFi coexisting networks, where DSRC and WiFi nodes are age-oriented and throughput-oriented, respectively.

In [33], dynamic programming based on a Markov Decision Process is applied in a cognitive radio network with an EH secondary user opportunistically transmitting status updates to its destination. Age-optimal scheduling policies in a network with general interference constraints are studied in [34]. In [35], several policies are considered to solve a weighted AoI minimization problem with throughput constraints. In [36], the sampling cost is taken into consideration in an age-optimal sampling and scheduling problem. The Drift-Plus-Penalty (DPP) policy considered in [34]–[36] is developed from the Lyapunov optimization theory [37], [38], which is often used for solving stochastic network optimization problems with stability constraints.

B. Contributions

We consider a time-slotted MAC where one grid-connected user has random data arrivals and one EH sensor sends status updates to a common destination. This model is the smallest non-trivial instance of a heterogeneous network with various types of devices and different performance characteristics. The main contributions of this works are summarized as follows.

- 1) We formulate an optimization problem that jointly considers the age minimization of the EH node with the queue stability of the grid-connected node. Two approaches are applied to solve this problem, namely the probabilistic random access (PRA) policy and the DPP policy.
- 2) We show that with the PRA policy, the average AoI of the EH node is equal to the average peak AoI (or PAoI), which is inversely proportional to the throughput of the EH node. The optimal transmit probabilities are derived in closed form.
- 3) Simulation results show that the DPP policy clearly outperforms the PRA policy by achieving lower average AoI and PAoI, especially when the destination node has low MPR capabilities, which is an expected result. Another interesting observation is that with the DPP policy, minimizing the AoI does not give the same solution as minimizing the PAoI, while with the PRA policy, these two optimization problems are equivalent.

Compared to the conference version in [1], which studies only the average AoI with the PRA policy, in this journal version, we consider both average AoI and PAoI optimization problems and extend our analysis by investigating age-optimal scheduling with both PRA and DPP policies.

II. SYSTEM MODEL

We consider a time-slotted MAC where two heterogeneous source nodes intend to transmit to a common destination D , as shown in Fig. 1. The first node S_1 is connected to a power grid, thus its activities are not battery-constrained. The data packets arrive at the queue of S_1 following a Bernoulli process with

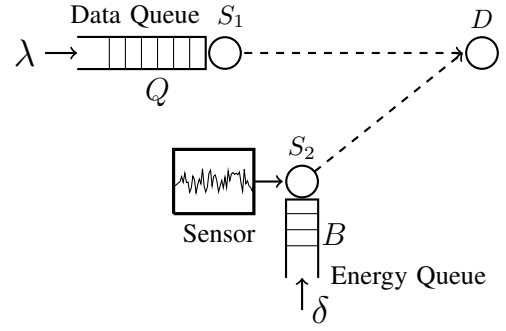

Fig. 1: The system model. One grid-connected source node and an EH sensor share the same wireless channel to a common destination. The EH sensor is generating status updates to transmit to the destination.

probability λ . Denote by $Q(t)$ the data queue size of node S_1 in time slot t , which has infinite capacity.¹ The second node S_2 is not connected to a dedicated power source, but it can harvest energy from the environment. We assume that the battery charging process follows a Bernoulli process with probability δ , with $B(t)$ representing the number of energy units in the energy source (battery) at node S_2 in time slot t . The capacity of the battery is assumed to be infinite.²

The two source nodes generate different types of data traffic which are associated with different performance goals. Node S_1 sends data packets that have been stored in its queue. The average delay to receive a packet from S_1 will be finite if the data queue is stable. Node S_2 always generates the freshest sample of the status update and sends it to the destination when it decides to transmit, i.e., the status update transmitted at time slot t is generated right before the transmission and we assume that the sampling is instantaneous. We consider equal-sized data packets and the transmission of one packet occupies one time slot.

Let $\{a_1(t)\}$ and $\{a_2(t)\}$ represent the Bernoulli processes for the data arrivals at node S_1 and energy arrivals at node S_2 , respectively. We have $\lambda = \mathbb{E}[a_1(t)]$ and $\delta = \mathbb{E}[a_2(t)]$. We consider an early-departure-late-arrival model and first-come-first-served principle for the queue. The data queue of node S_1 is updated following the equation

$$Q(t+1) = \max[Q(t) - b_1(t), 0] + a_1(t), \quad (1)$$

where $b_1(t) = 1$ if the destination successfully receives a packet from S_1 in time slot t , otherwise $b_1(t) = 0$. In the case of an unsuccessful transmission from S_1 , the packet has to be re-transmitted in a future time slot. We assume that the receiver gives an instantaneous error-free acknowledgment

¹Our work can handle the case of a finite queue, by replacing the probability of the queue being empty by the new expression with the finite queue size. When considering a finite-capacity queue, the packet dropping probability is a more relevant metric than the stability, which will result in a different problem formulation with more elaborated expressions. This specific consideration will not bring much useful insights into this problem, as the general observations can still hold.

²The infinite battery size is a common assumption in the literature, such as [14], [15], [17], [21], [25]. Considering a finite battery size will only make the expressions more elaborated without bringing more values to this problem.

(ACK) feedback of all the packets that were successful in a slot at the end of the slot. Then, S_1 removes the successfully transmitted packets from its queue.

We assume that both nodes have a fixed transmit power, and for S_2 the transmission of one status update consumes one energy unit from the battery. The same assumption is also made in [16], [19], [26]. The battery queue of S_2 evolves according to the equation

$$B(t+1) = \max[B(t) - u_2(t), 0] + a_2(t), \quad (2)$$

where $u_2(t) = 1$ if node S_2 attempts to transmit a status update in time slot t , otherwise $u_2(t) = 0$. When an update is transmitted from S_2 , in case of a transmission failure, the packet is dropped, and a new update will be generated for its next attempted transmission.

A. PHY Model and Success Probabilities

Since both source nodes are transmitting to a common destination, we assume MPR capabilities at the destination node D , which means that D can decode packets from multiple simultaneous transmissions that are interfering with each other. The transmission from one source node is successful if its received signal-to-interference-plus-noise ratio (SINR) at D exceeds a certain threshold [29].

We assume a block fading channel, where the fading coefficient remains constant during one time slot and independently changes from one slot to another. The received SINR at node i is given by

$$\text{SINR}_i = \frac{|h_i|^2 \tilde{\beta}_i}{\sum_{j \in \mathcal{A} \setminus \{i\}} |h_j|^2 \tilde{\beta}_j + 1},$$

where \mathcal{A} denotes the set of active transmitters; h_i denotes the small-scale channel fading of node i , which follows i.i.d. $\mathcal{CN}(0, 1)$ distribution; $\tilde{\beta}_i$ denotes the large-scale fading of link i , normalized over the transmit power and noise variance.

We define $p_{i/i}$ as the success probability of S_i , $i \in \{1, 2\}$, when only S_i is transmitting, and $p_{i/i,j}$ as the success probability of S_i when both S_i and S_j are transmitting and interfering with each other. Denote by θ_i the SNR/SINR threshold for successful transmission. Using the small-scale fading distribution, we have

$$p_{i/i} = \mathbb{P}\{\text{SINR}_i \geq \theta_i\} = \exp\left(-\theta_i/\tilde{\beta}_i\right), \quad i = \{1, 2\}, \quad (3)$$

$$p_{i/i,j} = \mathbb{P}\{\text{SINR}_i \geq \theta_i\} = \frac{\exp\left(-\theta_i/\tilde{\beta}_i\right)}{1 + \theta_i \tilde{\beta}_j/\tilde{\beta}_i}, \quad i = \{1, 2\}, j \neq i. \quad (4)$$

Note that our analysis holds for any specific channel model, and the analysis on the AoI and stability only requires the success probabilities.

B. Age of Information

At time slot t , the AoI seen at the destination is defined by the difference between the current time t and the time slot $G(t)$ when the latest successfully received update was

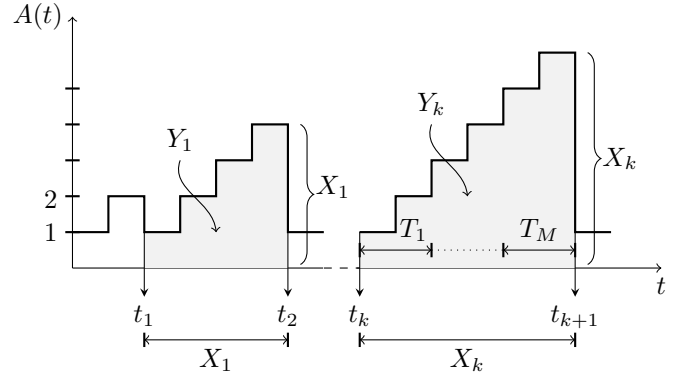

Fig. 2: Evolution of the AoI. t_k denotes the time when the destination received the k -th update. Y_k is the total area below the AoI step line between t_k and t_{k+1} . X_k is the number of time slots between the successful receptions of the k -th and the $(k+1)$ -th status updates.

generated. Following the standard definition [2], [3], the AoI at slot t is given by

$$A(t) = t - G(t). \quad (5)$$

As we consider slotted transmissions, the AoI takes integer values, i.e., $A(t) \in \{1, 2, \dots\}$, as shown in Fig. 2. Since each transmitted update by node S_2 is always generated at the end of the previous slot, the AoI drops to 1 when there is a successful reception of a status update at the destination. The evolution of the AoI between two consecutive slots can be written as

$$A(t+1) = \begin{cases} 1 & \text{if successful reception at slot } t, \\ A(t) + 1 & \text{otherwise.} \end{cases} \quad (6)$$

The average AoI is defined as

$$\bar{A} = \limsup_{t \rightarrow \infty} \mathbb{E} \left[\frac{1}{t} \sum_{\tau=0}^{t-1} A(\tau) \right]. \quad (7)$$

Upon each successful reception of a status update, the value of the AoI before dropping to 1 is counted as one peak. Let $T_s(t) = \mathbb{1}\{\text{successful reception at slot } t\}$ be the process representing the transmission success/failure in each slot. Then (6) can be written as

$$A(t+1) = A(t) + 1 - T_s(t)A(t). \quad (8)$$

When $T_s(t) = 1$, there is a peak value at slot t . The average PAoI is defined by

$$\bar{A}_p = \limsup_{t \rightarrow \infty} \frac{\mathbb{E} \left[\sum_{\tau=0}^{t-1} T_s(\tau) A(\tau) \right]}{\mathbb{E} \left[\sum_{\tau=0}^{t-1} T_s(\tau) \right]}. \quad (9)$$

C. Problem Formulation

Since both source nodes share the same wireless channel, scheduling plays an important role. We define the scheduling policy space by $\Pi = \{u_i(t) \in \{0, 1\}, \forall t, i = \{1, 2\}\}$, where $u_i(t)$ is the scheduling decision of node i at slot t . $u_i(t) = 1$ means that node S_i is scheduled to transmit in time slot t , and $u_i(t) = 0$ means that node S_i is inactive.

We aim at finding an optimal scheduling policy $\pi \in \Pi$ that minimizes the average age of node S_2 , while keeping the data queue of S_1 stable. We consider both average AoI and average PAoI as the age-performance metric. The optimization problem is defined by

$$\underset{\pi \in \Pi}{\text{minimize}} \quad \bar{A} \quad (10a)$$

$$\text{subject to} \quad \bar{Q} < \infty, \quad (10b)$$

where $\bar{Q} = \limsup_{t \rightarrow \infty} \mathbb{E} \left[\frac{1}{t} \sum_{\tau=0}^{t-1} Q(\tau) \right]$ is the time-average expectation of the queue size. The constraint in (10b) ensures that the data queue of S_1 is strongly stable. This problem is feasible if and only if $\lambda < p_{1/1}$.³

The stability condition of node S_1 depends on its service probability. The activity and battery status of node S_2 can affect the interference that it causes to S_1 . In such way, the AoI of node S_2 and the queue stability of node S_2 are coupled. Due to the random energy arrivals and the interference between the two users, this age-optimal scheduling problem is more difficult to solve than in the case with orthogonal scheduling and without EH.

To solve this problem, we first consider a random access policy, where the transmission actions of both nodes follow some fixed probability distributions, and they are independent of each other. Another option is to consider the DPP policy, where the scheduling decision in each time slot is based on the observed network state in that slot, such as the queue size and battery size. The details of these two policies will be presented in Sections III and IV.

III. PROBABILISTIC RANDOM ACCESS POLICY

First, we consider a decentralized probabilistic policy with random transmission decisions at both nodes following some stationary probability distributions. The PRA policy is described as follows:

- When the data queue of S_1 is not empty, it transmits a packet to the destination with probability q_1 .
- When S_2 has a non-empty battery, it generates a status update with probability q_2 and transmits it to the destination.

With this policy, each node makes independent decisions without coordinating with each other.⁴ To solve the age minimization problem with stability constraint, we first characterize the stability condition of node S_1 . Then, we derive the average AoI and average PAoI of node S_2 , which are given as functions of the probabilities q_1 , q_2 , δ , and λ .

A. Stability Analysis of Node S_1

The service probability of S_1 represents the probability of transmission success when S_1 attempts to transmit a packet. It can be obtained by averaging the success probabilities over

three cases: S_2 has empty battery, S_2 has non-empty battery but decides not to transmit, and S_2 decides to transmit. The service probability of S_1 is

$$\begin{aligned} \mu &= \mathbb{P}[B(t) = 0] q_1 p_{1/1} + \mathbb{P}[B(t) \neq 0] q_1 (1 - q_2) p_{1/1} \\ &\quad + \mathbb{P}[B(t) \neq 0] q_1 q_2 p_{1/1,2} \\ &= q_1 p_{1/1} (1 - q_2 \mathbb{P}[B(t) \neq 0]) + q_1 \mathbb{P}[B(t) \neq 0] q_2 p_{1/1,2}. \end{aligned} \quad (11)$$

The queue of S_1 is stable if and only if $\lambda < \mu$. Stability implies that the queueing delay will be finite. When the queue at S_1 is stable, $Q(t)$ has a unique stationary distribution. The probability of a non-empty queue is

$$\mathbb{P}[Q(t) \neq 0] = \frac{\lambda}{\mu}. \quad (12)$$

This probability will be used in the average AoI and PAoI analysis for node S_2 .

1) When S_2 relies on EH

Recall that the energy arrival process at the EH node S_2 follows a Bernoulli process with probability δ . The evolution of the energy queue $B(t)$ can be modeled as a Discrete Time Markov Chain, and it has a unique stationary distribution when the energy queue is stable. When $\delta < q_2$, we have

$$\mathbb{P}[B(t) \neq 0] = \frac{\delta}{q_2}. \quad (13)$$

Plugging (13) into (11), we obtain

$$\mu = q_1 p_{1/1} (1 - \delta) + q_1 \delta p_{1/1,2}. \quad (14)$$

The stability condition $\lambda < \mu$ yields

$$q_1 > \frac{\lambda}{p_{1/1} (1 - \delta) + \delta p_{1/1,2}}. \quad (15)$$

From (15), we see that in order to have a stable queue at S_1 , the transmit probability q_1 needs to be higher than a threshold, and this threshold is independent of q_2 when $\delta < q_2$. This is because when $\delta < q_2$, how frequently S_2 is causing interference to the transmission of S_1 is only limited by the energy arrival probability.

Note that when $\lambda \geq p_{1/1} (1 - \delta) + \delta p_{1/1,2}$, we cannot find any probability $q_1 \in [0, 1]$ that satisfies the stability condition in (15), if we keep the assumption of $\delta < q_2$. Therefore, we consider the case when $\delta \geq q_2$. In this case, the energy queue is unstable because its associated Markov chain is not positive recurrent, thus the energy queue size does not have a unique stationary distribution.⁵ Then, we can disregard the energy queue and consider the system as if S_2 were connected to a power grid. In the remainder of this section, we always divide our analysis into two parts: (1) when S_2 relies on EH and $\delta < q_2$; (2) when S_2 is connected to a power grid.

³When $\lambda < p_{1/1}$, we can always find a scheduling policy that satisfies the queue stability condition by reducing the transmissions of the EH node.

⁴Note that the considered PRA policy serves as a baseline of stationary randomized scheduling policies, and it is not guaranteed to be the best policy in this category.

⁵When the energy queue does not have a unique stationary distribution, asymptotically the probability of returning to the zero state (empty energy queue) is zero, i.e., $\mathbb{P}[B = 0] = 0$. Therefore, from the practical perspective, the battery will always be charged in the long term if the energy queue is unstable.

2) When S_2 is connected to a power grid

In this case, $\mathbb{P}[B(t) \neq 0] = 1$. From (11), we have

$$\mu = q_1 p_{1/1} (1 - q_2) + q_1 q_2 p_{1/1,2}. \quad (16)$$

The queue is stable if and only if

$$q_1 > \frac{\lambda}{p_{1/1}(1 - q_2) + q_2 p_{1/1,2}}. \quad (17)$$

From the above inequality, if $p_{1/1} > \lambda$ and $p_{1/1} > p_{1/1,2}$ holds, we can always find q_1 and q_2 that satisfy the stability condition of S_1 .

Combining the two cases, we obtain the following lemma.

Lemma 1. *The service probability of node S_1 is given by*

$$\mu = q_1 p_{1/1} (1 - \min\{\delta, q_2\}) + q_1 p_{1/1,2} \cdot \min\{\delta, q_2\}. \quad (18)$$

The queue at S_1 is stable if and only if

$$q_1 > \frac{\lambda}{p_{1/1} - \min\{\delta, q_2\} \cdot (p_{1/1} - p_{1/1,2})}. \quad (19)$$

B. Average AoI of Node S_2

For a period of N time slots where K successful updates occur, from Fig. 2, the average AoI can be computed as

$$A_N = \frac{1}{N} \sum_{k=1}^K Y_k = \frac{K}{N} \frac{1}{K} \sum_{k=1}^K Y_k. \quad (20)$$

Let X be a random variable (RV) denoting the time difference between two successful receptions of status updates. We have $\lim_{N \rightarrow \infty} \frac{K}{N} = \frac{1}{\mathbb{E}[X]}$. Meanwhile, $\frac{1}{K} \sum_{k=1}^K Y_k$ is the arithmetic mean of Y , which converges almost surely to $\mathbb{E}[Y]$ when $K \rightarrow \infty$. Then we have the average AoI as

$$\bar{A} = \lim_{N \rightarrow \infty} A_N = \frac{\mathbb{E}[Y]}{\mathbb{E}[X]}. \quad (21)$$

From Fig. 2, we observe the relation between Y_k and X_k as follows

$$Y_k = \sum_{m=1}^{X_k} m = \frac{1}{2} X_k (X_k + 1). \quad (22)$$

Then, we obtain

$$\bar{A} = \frac{\mathbb{E}\left[\frac{X_k^2}{2} + \frac{X_k}{2}\right]}{\mathbb{E}[X]} = \frac{\mathbb{E}[X^2]}{2\mathbb{E}[X]} + \frac{1}{2}. \quad (23)$$

The average AoI with the PRA policy is given as follows.

Theorem 1. *With the PRA policy, when the queue at node S_1 is stable, i.e., $\lambda < \mu$, the average AoI of node S_2 is*

$$\bar{A} = \frac{1}{\bar{p}_2 \cdot \min\{\delta, q_2\}}, \quad (24)$$

where \bar{p}_2 is the success probability of node S_2 , given as

$$\bar{p}_2 = p_{2/2} - \frac{(p_{2/2} - p_{2/1,2})\lambda}{p_{1/1} - \min\{\delta, q_2\} \cdot (p_{1/1} - p_{1/1,2})}. \quad (25)$$

Proof: See Appendix A. \square

Remark 1. *When $\delta < q_2$, the average AoI is limited by the energy arrival probability δ . Otherwise, if S_2 is constantly charged, the average AoI depends on the energy departure probability q_2 . The average AoI of the EH node is inversely proportional to its throughput.*

C. Optimization Problem

The average AoI optimization problem is defined by

$$\text{minimize}_{q_1, q_2} \frac{1}{\bar{p}_2 \cdot \min\{\delta, q_2\}} \quad (26a)$$

$$\text{subject to } \mu > \lambda, \quad (26b)$$

$$q_1, q_2 \in [0, 1], \quad (26c)$$

where the service probability μ is given in (18). The problem is feasible if and only if $\lambda < p_{1/1}$. Depending on the data and energy arrival rates, the stability condition leads to different sub-cases where the optimal values of q_1 and q_2 are given in the following lemma.

Lemma 2. *The optimal transmit probabilities can be obtained in the following two cases:*

- If $0 < \delta < \min\left\{\frac{p_{1/1} - \lambda}{p_{1/1} - p_{1/1,2}}, 1\right\}$, there exists $\delta < q_2 \leq 1$ that satisfies the queue stability condition. The optimal solution is

$$q_1^* > \frac{\lambda}{p_{1/1}(1 - \delta) + \delta p_{1/1,2}}, \quad (27)$$

$$q_2^* > \delta. \quad (28)$$

- If $\delta \geq \min\left\{\frac{p_{1/1} - \lambda}{p_{1/1} - p_{1/1,2}}, 1\right\}$, the stability condition implies $q_2 \leq \lambda$. The optimal solution is

$$q_1^* = 1, \quad (29)$$

$$q_2^* = \min\left\{\frac{p_{1/1} - \lambda}{p_{1/1} - p_{1/1,2}}, \delta\right\} - \xi, \quad (30)$$

where $\xi > 0$ is a sufficiently small positive value to ensure that the service probability of node S_1 is strictly larger than the arrival probability.

Proof: See Appendix B. \square

Remark 2. *Since $q_1^* = 1$ is a special case of the optimal solution given in (27), the minimum AoI of node S_2 is always achieved by letting node S_1 transmit with probability 1, and choosing the largest q_2 that guarantees the stability of S_1 .*

D. Average PAoI of Node S_2

From Fig. 2, it is straightforward to establish the relation

$$\bar{A}_p = \mathbb{E}[X] = \frac{\mathbb{E}[T]}{\bar{p}_2}, \quad (31)$$

which follows from (46). After substituting (59) into (31), we obtain

$$\bar{A}_p = \frac{1}{\bar{p}_2 \cdot \min\{\delta, q_2\}}, \quad (32)$$

which is the same as the average AoI given in (24).

Summarizing our results in this section, we have the same finding as in Lemma 1 in [34].

Remark 3. *In a MAC, when a source node (with EH or not) always generates a fresh sample of the status update before transmitting to the destination, with the PRA policy, the average AoI is the same as the average PAoI, which is inversely proportional to the throughput (average number of successfully transmitted packets per slot) of this source node.*

IV. DRIFT-PLUS-PENALTY POLICY

In this section, we consider a DPP policy using the Lyapunov optimization framework [38]. Let $\mathbf{U}(t) = (u_1(t), u_2(t))$ represent the scheduling decision in slot t . For the two-user system we consider, there are four possible scheduling decisions, i.e., $\mathbf{U}(t) \in \{(1, 1), (1, 0), (0, 1), (0, 0)\}$.

In each slot t , depending on the scheduling decision $\mathbf{U}(t)$, the transmissions from the two source nodes will be successful with different probabilities. We define the event $\mathcal{S} = \text{“transmission success”}$. Then we have $b_i(t) = \mathbb{1}\{\mathcal{S}|\mathbf{U}(t)\}$ as the successful transmission process of user i in slot t given the scheduling decision $\mathbf{U}(t)$, and $p_i(t) = \mathbb{P}[\mathcal{S}|\mathbf{U}(t)]$ as the conditional success probability. Then we have

$$p_1(t) = \begin{cases} p_{1/1,2} & \text{if } \mathbf{U}(t) = (1, 1), \\ p_{1/1} & \text{if } \mathbf{U}(t) = (1, 0), \\ 0 & \text{if } \mathbf{U}(t) = (0, 1), \\ 0 & \text{if } \mathbf{U}(t) = (0, 0). \end{cases} \quad (33)$$

$$p_2(t) = \begin{cases} p_{2/1,2} & \text{if } \mathbf{U}(t) = (1, 1), \\ 0 & \text{if } \mathbf{U}(t) = (1, 0), \\ p_{2/2} & \text{if } \mathbf{U}(t) = (0, 1), \\ 0 & \text{if } \mathbf{U}(t) = (0, 0). \end{cases} \quad (34)$$

Though we showed that the average AoI and PAoI are the same with the PRA policy, this might not hold for other policies. Therefore, in this section, we will solve the average AoI and PAoI optimization problems separately.

A. Average AoI Optimization

In order to have a successful status update reception, S_2 needs to have non-empty battery to be able to transmit, and the transmission needs to be successful. Let $H(t) = \mathbb{1}\{B(t) > 0\}$ indicate the battery status. Recall that the successful transmission process of S_2 is defined by $b_2(t) = \mathbb{1}\{\mathcal{S}|\mathbf{U}(t)\}$. The average AoI updates as follows:

$$A(t+1) = A(t) + 1 - H(t)b_2(t)A(t). \quad (35)$$

The AoI optimization problem is formulated as

$$\text{minimize } \limsup_{t \rightarrow \infty} \mathbb{E} \left[\frac{1}{t} \sum_{\tau=0}^{t-1} A(\tau+1) \right] \quad (36a)$$

$$\text{subject to } \bar{Q} < \infty, \quad (36b)$$

$$\mathbf{U}(t) \in \{(1, 1), (1, 0), (0, 1), (0, 0)\}. \quad (36c)$$

Denote by $\Phi(t) = [A(t), H(t), Q(t)]$ the network state at slot t , which consists of the AoI and battery status of node S_2 , and the data queue size of node S_1 . We consider the quadratic Lyapunov function $\mathcal{L}(\Phi(t)) = \frac{1}{2}Q^2(t)$ and the following one-slot conditional Lyapunov drift

$$\Delta(t) = \mathbb{E}[\mathcal{L}(\Phi(t+1)) - \mathcal{L}(\Phi(t))|\Phi(t)]. \quad (37)$$

We consider an AoI-related penalty function

$$P(t) = V\mathbb{E}[A(t+1)|\Phi(t)], \quad (38)$$

where V is a constant parameter that determines the weight on the penalty function.

Algorithm 1 DPP Algorithm for AoI Minimization

- 1) Initialization: $Q(0) = 0$, $A(0) = 0$ and $B(0) = 0$. Set $t = 1$ and choose appropriate value for V .
- 2) At slot t , the network scheduler observes $Q(t)$, $A(t)$ and $H(t)$, and makes scheduling decision $\mathbf{U}(t)$ by solving

$$\text{maximize}_{\mathbf{U}(t)} p_1(t)Q(t) + Vp_2(t)H(t)A(t),$$

where $p_1(t)$ and $p_2(t)$ are given in (33) and (34).

- 3) Update the data queue $Q(t)$, the energy queue $B(t)$, and the AoI $A(t)$ as

$$\begin{aligned} Q(t+1) &= \max[Q(t) - b_1(t), 0] + a_1(t), \\ B(t+1) &= \max[B(t) - u_2(t), 0] + a_2(t), \\ A(t+1) &= A(t) + 1 - H(t)b_2(t)A(t), \end{aligned}$$

where $b_i(t) = \mathbb{1}\{\mathcal{S}|\mathbf{U}(t)\}$ and $H(t) = \mathbb{1}\{B(t) > 0\}, \forall i = 1, 2$.

- 4) Repeat steps 2–3 for the next slot $t+1$.
-

Lemma 3. *The DPP function $\Delta(t) + P(t)$ is upper bounded by*

$$\begin{aligned} \Delta(t) + P(t) &\leq \frac{\lambda^2 + 1}{2} + \lambda Q(t) + V[A(t) + 1] \\ &\quad - \mathbb{E}[p_1(t)Q(t) + Vp_2(t)H(t)A(t)|\Phi(t)]. \end{aligned} \quad (39)$$

Proof: See Appendix C. \square

We intend to greedily minimize the DPP upper bound, by opportunistically minimizing the term inside the conditional expectation in every slot. This means that in each slot t , we check for all possible values of the scheduling decision $\mathbf{U}(t)$, and choose the one that maximizes $p_1(t)Q(t) + p_2(t)H(t)A(t)$.

The details of the DPP algorithm for AoI optimization are presented in Algorithm 1. In every slot, the network nodes report their local status information (queue size, battery size, AoI) to a centralized network scheduler. Then, the scheduling decisions are computed at the scheduler and communicated back to the nodes.

B. Average PAoI Optimization

From the definition of the average PAoI in (9) and $T_s(t) = H(t) \cdot b_2(t)$, we have

$$\bar{A}_p = \limsup_{t \rightarrow \infty} \frac{\mathbb{E} \left[\sum_{\tau=0}^{t-1} H(\tau)b_2(\tau)A(\tau) \right]}{\mathbb{E} \left[\sum_{\tau=0}^{t-1} H(\tau)b_2(\tau) \right]}. \quad (40)$$

It was shown in [34] that $\lim_{t \rightarrow \infty} \mathbb{E} \left[\frac{1}{t} \sum_{\tau=0}^{t-1} H(\tau)b_2(\tau)A(\tau) \right] = 1$ for any scheduling policy that guarantees bounded age. The average PAoI minimization problem $\min \bar{A}_p$ is equivalent to

$$\text{maximize}_{x>0} x \quad (41a)$$

$$\text{subject to } \liminf_{t \rightarrow \infty} \mathbb{E} \left[\frac{1}{t} \sum_{\tau=0}^{t-1} H(\tau)b_2(\tau) \right] \geq x, \quad (41b)$$

$$\bar{Q} < \infty, \quad (41c)$$

where x is an auxiliary variable. Unlike the case with average AoI optimization in the previous section, the new problem is independent of the AoI in each time slot. Note that the solution to this optimization problem also maximizes the throughput of node S_2 under stability condition of node S_1 . *This suggests that with the DPP policy, throughput-optimal scheduling also minimizes the average PAoI, but not necessarily minimizes the average AoI.*

We introduce a stochastic process $\alpha(t)$ which has time average $\lim_{t \rightarrow \infty} \mathbb{E} \left[\frac{1}{t} \sum_{\tau=0}^{t-1} \alpha(\tau) \right] = x$. The problem in (41) becomes

$$\text{maximize} \quad \lim_{t \rightarrow \infty} \mathbb{E} \left[\frac{1}{t} \sum_{\tau=0}^{t-1} \alpha(\tau) \right] \quad (42a)$$

$$\text{subject to} \quad \limsup_{t \rightarrow \infty} \mathbb{E} \left[\frac{1}{t} \sum_{\tau=0}^{t-1} (\alpha(\tau) - H(\tau)b_2(\tau)) \right] \leq 0, \quad (42b)$$

$$\bar{Q} < \infty, \quad (42c)$$

$$0 \leq \alpha(t) \leq \alpha_{\max}, \quad (42d)$$

$$\mathbf{U}(t) \in \{(1, 1), (1, 0), (0, 1), (0, 0)\}. \quad (42e)$$

The inequality condition in (42b) can be transformed into a queue stability problem with the help of virtual queues. We define the virtual queue $Z(t)$ that updates by the following equation:

$$Z(t+1) = \max[Z(t) + \alpha(t) - H(t)b_2(t), 0]. \quad (43)$$

The rectangular constraint $0 \leq \alpha(t) \leq \alpha_{\max}$ is to make the auxiliary variable bounded, where α_{\max} is a sufficiently large constant.⁶ Similar to the AoI optimization case, the DPP algorithm for the PAoI optimization problem is described in Algorithm 2.

Lemma 4. *The DPP algorithms for both AoI and PAoI optimization problems guarantee that the data queue at node S_1 is strongly stable. The queue backlog $Q(t)$ of S_1 satisfies:*

$$\limsup_{t \rightarrow \infty} \frac{1}{t} \sum_{\tau=0}^{t-1} \mathbb{E}[Q(\tau)] \leq \frac{C+V}{\epsilon}. \quad (44)$$

This inequality holds for any value of ϵ bounded by $0 \leq \epsilon \leq \min\{p_{1/1} - \lambda, \delta \cdot p_{2/1,2}\}$. Here, $C = \frac{\lambda^2+1}{2}$ for the case with AoI optimization and $C = \frac{\alpha_{\max}^2 + \lambda^2 + 2}{2}$ for the case with PAoI optimization. V is a constant weight that affects the tradeoff between the performance optimization and the queue congestion.

Proof: See Appendix D. \square

C. Discussion on Further Extension

If there are multiple AoI-oriented and throughput-oriented nodes in the system, we can formulate an optimization

⁶Denote by α_{opt} the optimal solution to the stochastic optimization problem defined in (42) over all possible scheduling policies. When adding the rectangular constraint $0 \leq \alpha(t) \leq \alpha_{\max}$ to the problem, α_{\max} should be chosen large enough to ensure $0 \leq \alpha_{\text{opt}} \leq \alpha_{\max}$. More details can be found in [38].

Algorithm 2 DPP Algorithm for PAoI Minimization

- 1) Initialization: $Q(0) = 0$, $B(0) = 0$, $Z(0) = 0$. Choose α_{\max} and V . Set $t = 1$.
- 2) At slot t , the network scheduler observes $Q(t)$, $Z(t)$ and $H(t)$, and makes decision $\mathbf{U}(t)$ by solving

$$\text{maximize}_{\mathbf{U}(t)} \quad Z(t)H(t)p_2(t) + Q(t)p_1(t),$$

where $p_1(t)$ and $p_2(t)$ are given in (33) and (34).

- 3) The auxiliary variable $\alpha(t)$ is chosen by

$$\alpha(t) = \begin{cases} \alpha_{\max} & \text{if } Z(t) \leq V, \\ 0 & \text{otherwise.} \end{cases}$$

- 4) Update all queues by

$$\begin{aligned} Q(t+1) &= \max[Q(t) - b_1(t), 0] + a_1(t), \\ B(t+1) &= \max[B(t) - u_2(t), 0] + a_2(t), \\ Z(t+1) &= \max[Z(t) + \alpha(t) - H(t)b_2(t), 0]. \end{aligned}$$

- 5) Repeat steps 2–4 for the next slot $t + 1$.
-

problem with the weighted sum of the average AoI as the objective function and include as constraints the stability conditions for the throughput-oriented users. This problem can still be solved by using the standard Lyapunov optimization approach. The computational complexity of the DPP algorithm will depend on the scheduling decision space, which grows exponentially with K . However, in the PRA policy, since we have throughput-oriented users with bursty traffic, we face interaction among the queues. To characterize in closed-form the stable throughput in such setup is a well-known difficult problem for more than three users [39].

V. SIMULATION RESULTS

In this section, we evaluate the performance of the proposed PRA and DPP policies through simulations and compare the average AoI and PAoI obtained with these two policies.

Since our analytical results do not depend on any specific channel model, the success probabilities we use in the simulations are divided into two cases: 1) strong MPR, $p_{1/1} = 0.95$, $p_{1/1,2} = 0.63$, $p_{2/2} = 0.924$, $p_{2/1,2} = 0.41$; 2) weak MPR, $p_{1/1} = 0.924$, $p_{1/1,2} = 0.515$, $p_{2/2} = 0.882$, $p_{2/1,2} = 0.3$.⁷ For the PRA policy, we choose $\xi = 0.001$. For the DPP policy, we choose $V = 200$ and $\alpha_{\max} = 1$. We have chosen sufficiently long simulation time (10^6 slots) to make sure that the Markov chains reach their steady state behaviors.

A. Average AoI Comparison

In Fig. 3, we compare the average AoI obtained with both policies, for different values of the data arrival probability λ . First, we observe that the DPP policy always achieves lower average AoI than the PRA policy. The difference is more significant when the data arrival probability is larger.

⁷The success probabilities are obtained by considering $\bar{\beta}_1 = 12$ dB for node S_1 and $\bar{\beta}_1 = 10$ dB for node S_2 , with SNR/SINR threshold -1 dB for the strong MPR case and 1 dB for the weak MPR case.

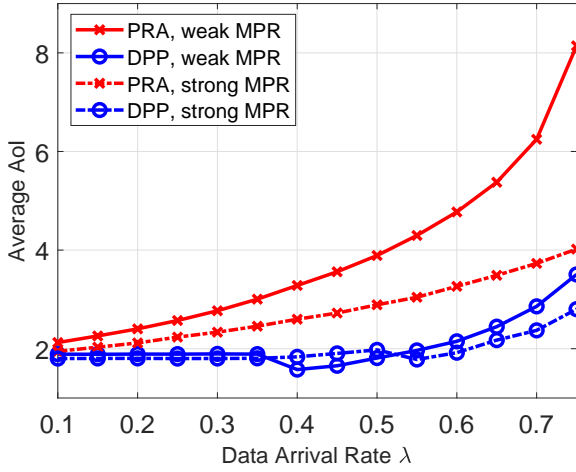

Fig. 3: Average AoI vs. data arrival probability λ . Energy arrival probability $\delta = 0.6$.

Second, the performance of the DPP policy is divided into two regimes. When λ reaches a certain point, the average AoI has a sudden drop, and then increases with λ . To understand this phenomenon, in Fig. 4 we present the percentage of each scheduling decision obtained with the DPP policy, when the destination node has weak and strong MPR capabilities, respectively. We see that in the case with weak MPR (in Fig. 4(a)), the two nodes are never active at the same time. However, in the strong MPR case as shown in Fig. 4(b), the probability of having two concurrent transmissions (the blue curve) starts to be non-zero after λ reaches a certain point. One common observation from these two figures is that, when $\lambda \simeq 0.4$, there is a turning point where the percentage of both nodes being idle becomes 0, i.e., there are no idle slots in the channel. It means that the DPP policy makes full use of the transmission opportunities in the channel without wasting any slot.

Note that the non-smoothness of the curves in Fig. 3 and Fig. 4(b) is not because of insufficient simulation time, but comes from the performance-congestion tradeoff in the DPP policy. Since the parameter V determines how much weight we put on the penalty function, in Fig. 5 we show the effect of V on the time-average AoI. We see that larger V gives smaller long-term average AoI, but the required time to reach the desired point also increases. For the value we choose, 10^6 slots are sufficient for the DPP algorithm to converge.

In Fig. 6, we show the relation between the average AoI and the energy arrival probability δ . Also here, the DPP policy performs significantly better than the PRA policy, especially when the destination node has weak MPR capabilities. Another interesting observation is, for both policies, with high data arrival probability, e.g., $\lambda = 0.7$, the average AoI becomes independent of δ after δ reaches a certain threshold. This is because when λ is large, q_2 should be small enough to satisfy the stability condition of node S_1 . Then the age performance of S_2 is mainly limited by the energy departure process instead of by the arrivals.

Note that existing works such as [30], [39] have studied

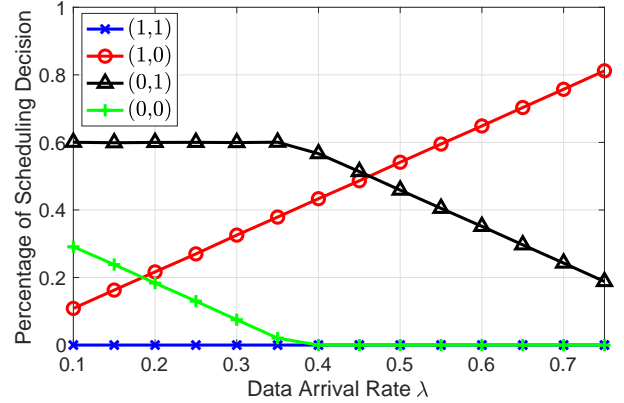

(a) Weak MPR

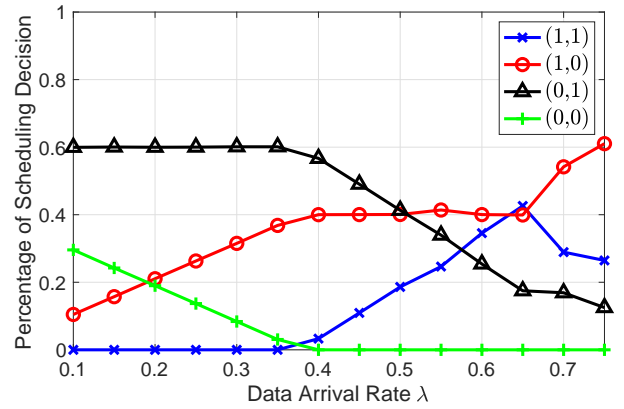

(b) Strong MPR

Fig. 4: Percentage of time slots for each scheduling decision vs. data arrival probability λ , when the DPP policy is applied. Energy arrival probability $\delta = 0.6$.

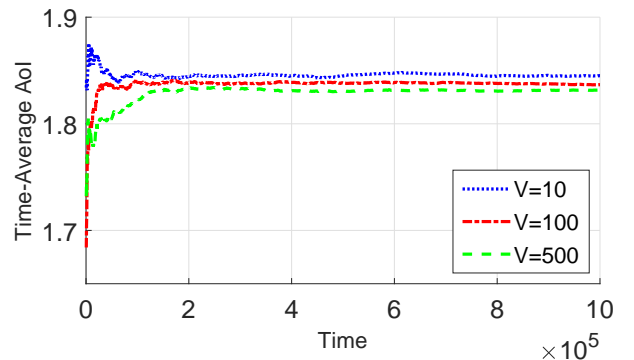
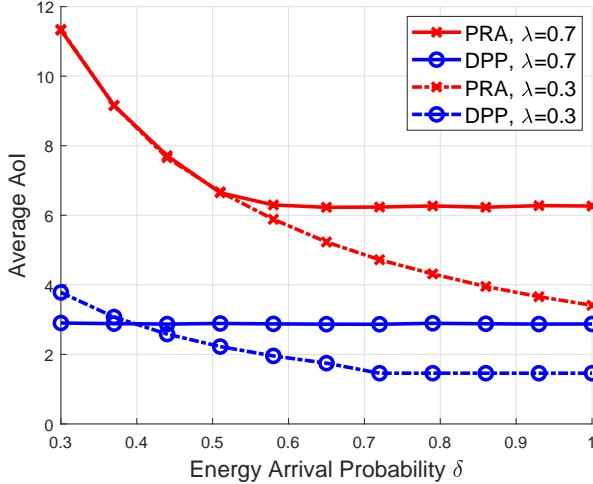
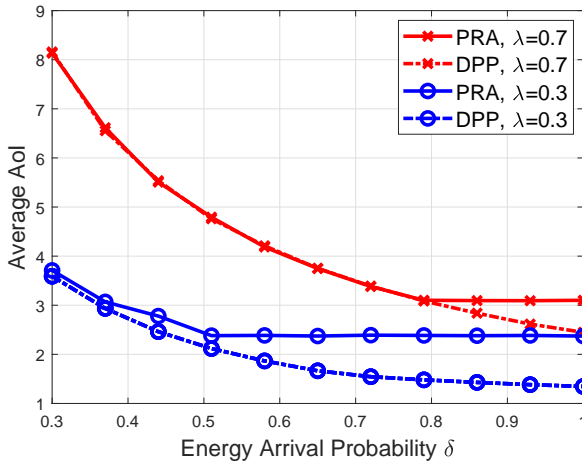

Fig. 5: Time-average expected AoI vs. time for different values of V . Data arrival probability $\lambda = 0.75$, energy arrival probability $\delta = 0.6$. Strong MPR.

the stability region in two-user MAC with random access and MPR capabilities, which can provide a theoretical explanation for our findings from the stable throughput perspective. In these references, the weak/strong MPR capabilities correspond to $\frac{p_{1/1,2}}{p_{1/1}} + \frac{p_{2/1,2}}{p_{2/2}} \leq 1$. In the weak MPR case, the stable throughput of the random access MAC channel becomes a



(a) Weak MPR



(b) Strong MPR

Fig. 6: Average AoI vs. energy arrival probability δ . Data arrival probability $\lambda = \{0.3, 0.7\}$.

non-convex set, while it is a convex set for the strong MPR case. *Convexity of the stable throughput region determines when a parallel concurrent transmission scheme is preferable to a time-sharing scheme.* Here, we observe that in the weak MPR case, the optimal strategy is to schedule one user at a time, which is not the case for the strong MPR.

B. Average PAoI Comparison

In Fig. 7, we plot the average PAoI obtained with both policies as a function of the data arrival probability λ . First, we see that the DPP policy still outperforms the PRA policy in most cases. Second, with the DPP policy (the blue curves), when λ increases, the average PAoI first remains the same, then increases with λ . This is because when λ is small, the DPP algorithm will not allocate many transmission slots to node S_1 . The EH node S_2 will have more chances for transmitting status updates when the battery is non-empty.

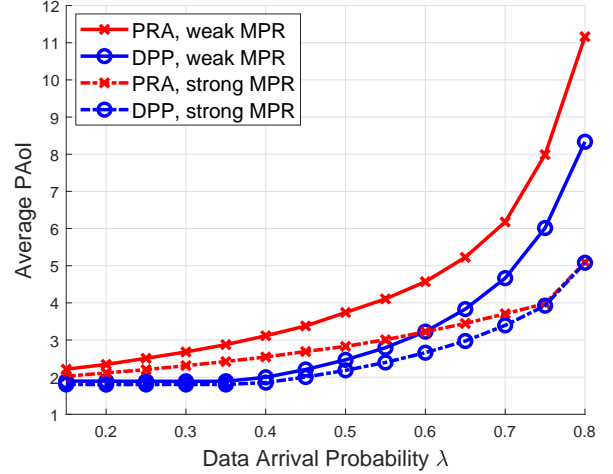

Fig. 7: Average PAoI vs. data arrival probability λ . Energy arrival probability $\delta = 0.6$.

Then the age of node S_2 is only limited by the energy arrivals. A third observation is that when λ is high, with strong MPR, the performances of these two policies become the same, which is different than what we have observed in Fig. 3.

In Fig. 8, we present the average PAoI obtained with both policies for different values of the data and energy arrival probabilities. Similar to the previous results, we observe the advantage of the DPP policy, especially in the case with low MPR capabilities. The only exceptional case when the PRA policy performs as good as the DPP policy is when both λ and δ are very high, and with strong MPR capabilities at the destination node, as shown in Fig. 8(b). Recall that for both policies, PAoI-optimal scheduling is also throughput-optimal. *This observation suggests that with strong MPR and high data and energy arrival probabilities, the two policies achieve the same optimal throughput.*

Comparing the results in Fig. 6 and in Fig. 8, we see that when λ is small, e.g., $\lambda = 0.3$, the average AoI and PAoI achieved with the DPP policy are very close. However, when λ is large, e.g., $\lambda = 0.7$, the average PAoI obtained with the DPP policy is obviously higher than the average AoI. This observation shows that with the DPP policy, PAoI-optimal scheduling is not equivalent to AoI-optimal in the general case.

VI. CONCLUSIONS

We studied age-optimal scheduling in a MAC with two heterogeneous source nodes generating different types of data traffic. One grid-connected node has bursty data arrivals and another node with EH capabilities sends fresh status updates to a common destination. An optimization problem was formulated to minimize the average age of the EH node with respect to the queue stability of the grid-connected node. We solved this problem by considering a PRA policy with independent and random transmission decisions, and a DPP policy developed by using Lyapunov optimization. We derived the optimal solution with the PRA policy in closed form, and proved that the average AoI is the same as the average PAoI. For the DPP

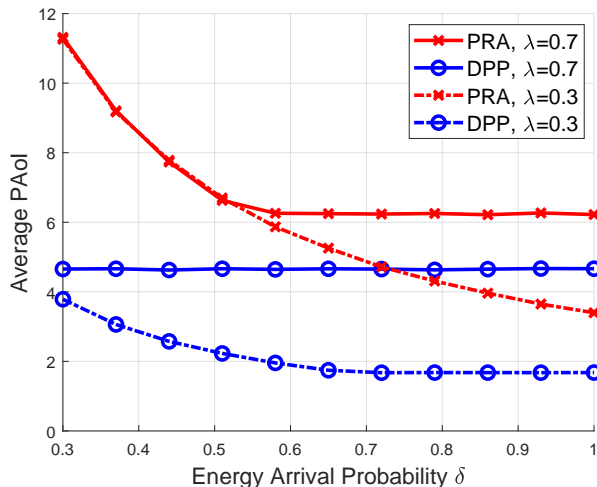

(a) Weak MPR

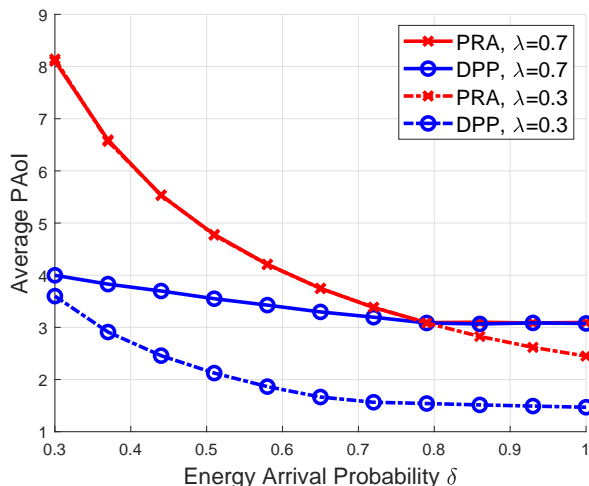

(b) Strong MPR

Fig. 8: Average PAoI vs. energy arrival probability δ .

policy, we proposed two dynamic scheduling algorithms for the AoI and PAoI optimization problems, and showed that the PAoI-optimal scheduling is also throughput-optimal, but not AoI-optimal. Simulation results showed that the DPP policy significantly outperforms the PRA policy, especially when the destination node has weak MPR capabilities.

APPENDIX

A. Proof of Theorem 1

Between two successful receptions of status updates, there might be more than one attempted transmission. Let T_i represent the time difference between the $(i-1)$ -th and the i -th attempted transmissions, from Fig. 2, we have

$$X = \sum_{i=1}^M T_i, \quad (45)$$

where M is a RV representing the number of attempted transmissions between two successfully received status updates.

Note that when $i = 1$, T_1 represents the time difference between the latest successfully received update and the first attempted transmission after that. Since T_i is a stationary stochastic process, in the following we use $\mathbb{E}[T]$ to denote the expected value of T_i for an arbitrary i . The expected values of X can be obtained by using the probability mass function of a geometric distribution, which gives

$$\mathbb{E}[X] = \sum_{m=1}^{\infty} m \mathbb{E}[T] (1 - \bar{p}_2)^{m-1} \bar{p}_2 = \frac{\mathbb{E}[T]}{\bar{p}_2}, \quad (46)$$

where \bar{p}_2 is the success probability of the transmission from S_2 , which is the weighted sum of $p_{2/2}$ and $p_{2/1,2}$. When the queue at S_1 is stable, we have

$$\begin{aligned} \bar{p}_2 &= p_{2/2} (1 - q_1 \cdot \mathbb{P}[Q(t) \neq 0]) + p_{2/1,2} q_1 \mathbb{P}[Q(t) \neq 0] \\ &= p_{2/2} - \frac{(p_{2/2} - p_{2/1,2}) \lambda}{p_{1/1} - \min\{\delta, q_2\} \cdot (p_{1/1} - p_{1/1,2})}. \end{aligned} \quad (47)$$

For the second moment of X , we start from

$$X^2 = \left(\sum_{i=1}^M T_i \right)^2 = \sum_{i=1}^M T_i^2 + \sum_{i=1}^M \sum_{j=1, j \neq i}^M T_i T_j. \quad (48)$$

Taking conditional expectation of both sides, we get

$$\mathbb{E}[X^2 | M] = M \mathbb{E}[T^2] + M(M-1) (\mathbb{E}[T])^2. \quad (49)$$

Then we have

$$\begin{aligned} \mathbb{E}[X^2] &= \sum_{m=1}^{\infty} \mathbb{E}[X^2 | m] (1 - \bar{p}_2)^{m-1} \bar{p}_2 \\ &= \frac{\mathbb{E}[T^2]}{\bar{p}_2} + (\mathbb{E}[T])^2 \frac{2(1 - \bar{p}_2)}{\bar{p}_2^2}. \end{aligned} \quad (50)$$

Here, the sum converges when $\bar{p}_2 > 0$. Substituting (46) and (50) into (23), the average AoI becomes

$$\bar{A} = \frac{\mathbb{E}[T^2]}{2\mathbb{E}[T]} + \frac{\mathbb{E}[T](1 - \bar{p}_2)}{\bar{p}_2} + \frac{1}{2}. \quad (51)$$

Since T is a discrete number representing the time difference between two consecutive attempted transmissions, the probability mass function of T is given by

$$\begin{aligned} \mathbb{P}[T = k] &= \mathbb{P}[B(t) = 0] \sum_{l=1}^{k-1} (1 - \delta)^{l-1} \delta (1 - q_2)^{k-l-1} q_2 \\ &\quad + \mathbb{P}[B(t) \neq 0] (1 - q_2)^{k-1} q_2. \end{aligned} \quad (52)$$

The first term is the probability that when the battery of S_2 is empty, S_2 does not attempt to transmit for $k-1$ consecutive slots, either because of no energy arrival or because it decides not to transmit. The second term is the probability that when the battery is non-empty, S_2 decides not to transmit for $k-1$ consecutive slots.

Since (52) involves $\mathbb{P}[B(t) = 0]$, as mentioned previously, our analysis will be given in two cases: when $\delta < q_2$ and when $\delta = 1$, respectively.

1) When S_2 relies on EH and $\delta < q_2$

Recall that we have $\mathbb{P}[B(t) \neq 0] = \frac{\delta}{q_2}$ when $\delta < q_2$. After substituting $\mathbb{P}[B(t) \neq 0] = \frac{\delta}{q_2}$ into (52), we have

$$\begin{aligned} P(T = k) &= \left(1 - \frac{\delta}{q_2}\right) q_2 (1 - q_2)^{k-2} \delta \sum_{l=1}^{k-1} \left(\frac{1 - \delta}{1 - q_2}\right)^{l-1} \\ &\quad + \frac{\delta}{q_2} (1 - q_2)^{k-1} q_2 \\ &= (q_2 - \delta) (1 - q_2)^{k-2} \delta \sum_{l=1}^{k-1} \left(\frac{1 - \delta}{1 - q_2}\right)^{l-1} \\ &\quad + \delta (1 - q_2)^{k-1}. \end{aligned} \quad (53)$$

After some simplification, we can obtain

$$\mathbb{E}[T] = \sum_{k=1}^{\infty} k \mathbb{P}[T = k] = \frac{1}{\delta}. \quad (54)$$

Similarly, we have

$$\mathbb{E}[T^2] = \sum_{k=1}^{\infty} k^2 \mathbb{P}[T = k] = \frac{2 - \delta}{\delta^2}. \quad (55)$$

2) When S_2 is connected to a power grid

In this case, we have $\mathbb{P}[B(t) \neq 0] = 1$. From (52) we get

$$\mathbb{P}[T = k] = (1 - q_2)^{k-1} q_2, \quad (56)$$

$$\mathbb{E}[T] = \sum_{k=1}^{\infty} k \mathbb{P}[T = k] = \frac{1}{q_2}, \quad (57)$$

$$\mathbb{E}[T^2] = \sum_{k=1}^{\infty} k^2 \mathbb{P}[T = k] = \frac{2 - q_2}{q_2^2}. \quad (58)$$

Combining these two cases, we have that

$$\mathbb{E}[T] = \frac{1}{\min\{q_2, \delta\}}, \quad (59)$$

$$\mathbb{E}[T^2] = \frac{2 - \min\{q_2, \delta\}}{\min\{q_2, \delta\}^2}. \quad (60)$$

Substituting (59) and (60) into (51), we obtain Theorem 1.

B. Proof of Lemma 2

When S_2 relies on EH and assuming $\delta < q_2$, the average AoI is $1/(\delta \cdot \bar{p}_2)$, which is independent of q_1 and q_2 as it can be seen from (47). Thus, the optimal value of q_2 can be any value within the range $(\delta, 1]$. From the queue stability condition given in (15), we have

$$q_1 > \frac{\lambda}{p_{1/1}(1 - \delta) + \delta p_{1/1,2}}. \quad (61)$$

Since the probability q_1 cannot be larger than 1, we have $\lambda < p_{1/1}(1 - \delta) + \delta p_{1/1,2}$, which corresponds to $\delta < \frac{p_{1/1} - \lambda}{p_{1/1} - p_{1/1,2}}$. Combining with the condition $0 \leq \delta \leq 1$, we have

$$0 < \delta < \min\left\{\frac{p_{1/1} - \lambda}{p_{1/1} - p_{1/1,2}}, 1\right\}. \quad (62)$$

If this condition is satisfied, the optimal transmit probabilities are $q_1^* > \frac{\lambda}{p_{1/1}(1 - \delta) + \delta p_{1/1,2}}$ and $q_2^* > \delta$.

If $\delta \geq \min\left\{\frac{p_{1/1} - \lambda}{p_{1/1} - p_{1/1,2}}, 1\right\}$, the optimal values of q_1 cannot be found by (61) because the threshold exceeds 1. Thus, the

queue stability implies that $\delta \geq q_2$. In this case, we can disregard the energy queue and consider the system as if S_2 was connected to a power grid. Then the AoI optimization problem becomes

$$\text{minimize}_{q_1, q_2} \frac{1}{q_2 \bar{p}_2} \quad (63a)$$

$$\text{subject to } q_1(1 - q_2)p_{1/1} + q_1 q_2 p_{1/1,2} > \lambda, \quad (63b)$$

$$0 \leq q_1 \leq 1, \quad (63c)$$

$$0 \leq q_2 \leq \delta. \quad (63d)$$

Since the average AoI is inversely proportional to q_2 , the optimal value of q_2 is the maximum value of $q_2 \in [0, \delta]$ that satisfies the queue stability condition in (63b). Then we have

$$q_2 < \frac{p_{1/1} - \lambda/q_1}{p_{1/1} - p_{1/1,2}}. \quad (64)$$

The maximum value of q_2 is achieved when $q_1 = 1$. Then we obtain the optimal solution as $q_1^* = 1$ and $q_2^* = \min\left\{\frac{p_{1/1} - \lambda}{p_{1/1} - p_{1/1,2}}, \delta\right\} - \xi$, where $\xi > 0$ is a small positive value to ensure that the service probability is strictly larger than the arrival probability.

C. Proof of Lemma 3

From the queue evolution $Q(t+1) = \max[Q(t) - b_1(t), 0] + a_1(t)$, the Lyapunov drift is bounded by

$$\begin{aligned} \Delta(t) &\leq \frac{1}{2} \mathbb{E}[a_1(t)^2 + b_1(t)^2 | \Phi(t)] \\ &\quad + \mathbb{E}[Q(t)(a_1(t) - b_1(t)) | \Phi(t)]. \end{aligned} \quad (65)$$

From $\mathbb{E}[a_1(t) | \Phi(t)] = \mathbb{E}[a_1(t)] = \lambda$ and $\mathbb{E}[b_1(t)^2 | \Phi(t)] \leq 1$, we have

$$\Delta(t) \leq \frac{\lambda^2 + 1}{2} + \lambda Q(t) - \mathbb{E}[Q(t)b_1(t) | \Phi(t)]. \quad (66)$$

Adding the penalty term $V \mathbb{E}[A(t+1) | \Phi(t)]$, with $A(t+1) = A(t) + 1 - H(t)b_2(t)A(t)$ and $p_i(t) = \mathbb{E}[b_i(t)]$ for $i = \{1, 2\}$, we obtain the upper bound for the DPP as in (39).

D. Proof of Lemma 4

1) Proof for queue stability with PAoI optimization

We define $\Theta(t) = [Z(t), Q(t)]$ and consider the Lyapunov function $\mathcal{L}(\Theta(t)) = \frac{1}{2}Q(t)^2 + \frac{1}{2}Z(t)^2$. The one-slot conditional Lyapunov drift is given by

$$\Delta(t) = \mathbb{E}[\mathcal{L}(\Theta(t+1)) - \mathcal{L}(\Theta(t)) | \Theta(t)]. \quad (67)$$

From (1) and (43), the Lyapunov drift is bounded by

$$\begin{aligned} \Delta(t) &\leq \frac{\mathbb{E}[\alpha(t)^2 + H(t)^2 b_2(t)^2 + a_1(t)^2 + b_1(t)^2 | \Theta(t)]}{2} \\ &\quad + \mathbb{E}[Q(t)(a_1(t) - b_1(t)) | \Theta(t)] \\ &\quad + \mathbb{E}[Z(t)(\alpha(t) - H(t)b_2(t)) | \Theta(t)]. \end{aligned} \quad (68)$$

We know that $\mathbb{E}[a_1(t) | \Theta(t)] = \lambda$, $\mathbb{E}[\alpha(t) | \Theta(t)] \leq \alpha_{\max}$, $\mathbb{E}[H(t)^2 b_2(t)^2 | \Theta(t)] \leq 1$, and

$\mathbb{E}[b_1(t)^2 | \Theta(t)] \leq 1$. Define $C = \frac{\alpha_{\max}^2 + \lambda^2 + 2}{2}$, we have

$$\begin{aligned} \Delta(t) &\leq C + \lambda Q(t) - \mathbb{E}[Q(t)b_1(t) | \Theta(t)] \\ &\quad + \mathbb{E}[Z(t)(\alpha(t) - H(t)b_2(t)) | \Theta(t)]. \end{aligned} \quad (69)$$

Since $p_i(t) = \mathbb{E}[b_i(t)]$ for $i = \{1, 2\}$, the drift-plus-penalty is bounded by

$$\Delta(t) - V\mathbb{E}[\alpha(t)|\Theta(t)] \leq C + \lambda Q(t) + \mathbb{E}[\alpha(t)(Z(t) - V)|\Theta(t)] \\ + \mathbb{E}[Z(t)H(t)p_2(t) + Q(t)p_1(t)|\Theta(t)], \quad (70)$$

where V denotes the weight on the penalty function.

We consider opportunistically minimizing the conditional expectation of the upper bound on the DPP, which results in the following two sub-problems:

- Observe $Z(t)$, $H(t)$ and $Q(t)$, choose the scheduling decision that maximizes $Z(t)H(t)p_2(t) + Q(t)p_1(t)$;
- Choose $0 \leq \alpha(t) \leq \alpha_{\max}$ that minimizes $\alpha(t)(Z(t) - V)$, which gives

$$\alpha(t) = \begin{cases} \alpha_{\max} & \text{if } Z(t) \leq V, \\ 0 & \text{otherwise.} \end{cases}$$

Then we obtain the DPP algorithm described in Algorithm 2.

In the following, we show that this algorithm stabilizes the network. Consider an alternative S-only policy that makes stationary randomized decisions independent of the queue backlog, there exists $\epsilon > 0$ such that the resulting values $p_1^*(t)$, $p_2^*(t)$, $H^*(t)$ and $\alpha^*(t)$ of the S-only policy satisfy:

$$\mathbb{E}[p_1^*(t)] = p_1^* \geq \lambda + \epsilon, \quad (71)$$

$$\mathbb{E}[H^*(t)p_2^*(t)] - \mathbb{E}[\alpha^*(t)] \geq \epsilon, \quad (72)$$

$$\mathbb{E}[\alpha^*(t)] = \alpha_{sr}(\epsilon). \quad (73)$$

Here, $0 \leq \alpha_{sr}(\epsilon) \leq \alpha_{\text{opt}}$ is a feasible solution to the problem defined in (42) that can be achieved by an S-only policy. The conditions in (71) and (72) are feasible for any ϵ bounded by $0 \leq \epsilon \leq \min\{p_{1/1} - \lambda, \delta \cdot p_{2/1,2}\}$, if $\lambda < p_{1/1}$ holds.

Since our DPP algorithm minimizes the right-hand side of (70) in every slot, after taking iterated expectations on both sides, any alternative policy (S-only or not) would result in larger value for the expectation of the right-hand side of (70). Then we have

$$\mathbb{E}[\mathcal{L}(\Theta(t+1))] - \mathbb{E}[\mathcal{L}(\Theta(t))] - V\mathbb{E}[\alpha(t)] \\ \leq C - \epsilon\mathbb{E}[Q(t)] - \epsilon\mathbb{E}[Z(t)] - V\alpha_{sr}(\epsilon). \quad (74)$$

Summing over $\tau = 0, \dots, t-1$, after rearranging terms, we obtain

$$\sum_{\tau=0}^{t-1} \mathbb{E}[Q(\tau)] + \sum_{\tau=0}^{t-1} \mathbb{E}[Z(\tau)] \leq t \frac{C + V(\mathbb{E}[\alpha(t)] - \alpha_{sr}(\epsilon))}{\epsilon} \\ - \frac{\mathbb{E}[\mathcal{L}(\Theta(t))] - \mathbb{E}[\mathcal{L}(\Theta(0))]}{\epsilon}. \quad (75)$$

After neglecting the non-negative terms and dividing both sides by t , we get

$$\frac{1}{t} \sum_{\tau=0}^{t-1} \mathbb{E}[Q(\tau)] \leq \frac{C + V(\mathbb{E}[\alpha(t)] - \alpha_{sr}(\epsilon))}{\epsilon} \\ + \frac{\mathbb{E}[\mathcal{L}(\Theta(0))]}{t\epsilon}. \quad (76)$$

Since $\mathbb{E}[\alpha(t)] \leq \alpha_{\text{opt}}$ where α_{opt} is the optimal solution over all scheduling policies, taking the limit $t \rightarrow \infty$, we obtain

$$\limsup_{t \rightarrow \infty} \frac{1}{t} \sum_{\tau=0}^{t-1} \mathbb{E}[Q(\tau)] \leq \frac{C + V(\alpha_{\text{opt}} - \alpha_{sr}(\epsilon))}{\epsilon}. \quad (77)$$

This shows that the queue of S_1 is strongly stable. Furthermore, knowing that $0 \leq \alpha_{\text{opt}} < 1$ because $\mathbb{E}[H(t)b_2(t)] \leq 1$, and $0 \leq \alpha_{sr}(\epsilon) \leq \alpha_{\text{opt}}$, the queue backlog is bounded by

$$\limsup_{t \rightarrow \infty} \frac{1}{t} \sum_{\tau=0}^{t-1} \mathbb{E}[Q(\tau)] \leq \frac{C + V}{\epsilon}. \quad (78)$$

This inequality holds for any value of ϵ bounded by $0 \leq \epsilon \leq \min\{p_{1/1} - \lambda, \delta \cdot p_{2/1,2}\}$.

2) Proof for queue stability with AoI optimization

Same as in the PAoI optimization case, we consider an alternative S-only policy that satisfies $\mathbb{E}[p_1^*(t)] \geq \lambda + \epsilon$. From the DPP bound in (39), following similar steps as in Appendix D1, we have

$$\mathbb{E}[\mathcal{L}(\Phi(t+1))] - \mathbb{E}[\mathcal{L}(\Phi(t))] + V\mathbb{E}[H_2(t)p_2(t)A(t)] \\ \leq C - \epsilon\mathbb{E}[Q(t)] + V\mathbb{E}[A(t) + 1 - A(t+1)]. \quad (79)$$

After neglecting some non-negative terms, we obtain

$$\epsilon\mathbb{E}[Q(t)] \leq C + V + V\mathbb{E}[A(t) - A(t+1)] + \mathbb{E}[\mathcal{L}(\Phi(t))] \\ - \mathbb{E}[\mathcal{L}(\Phi(t+1))]. \quad (80)$$

Summing over $\tau = 0, \dots, t-1$, dividing both sides by $t \cdot \epsilon$, and taking the limit $t \rightarrow \infty$, we obtain the same inequality as in (44).

REFERENCES

- [1] Z. Chen, N. Pappas, E. Björnson, and E. G. Larsson, "Age of information in a multiple access channel with heterogeneous traffic and an energy harvesting node," in *IEEE Conf. on Computer Commun. Workshops (INFOCOM WKSHPs)*, Apr. 2019.
- [2] A. Kosta, N. Pappas, and V. Angelakis, "Age of information: A new concept, metric, and tool," *Foundations and Trends® in Networking*, vol. 12, no. 3, pp. 162–259, 2017.
- [3] Y. Sun, I. Kadota, R. Talak, and E. Modiano, "Age of information: A new metric for information freshness," *Synthesis Lectures on Communication Networks*, vol. 12, no. 2, pp. 1–224, 2019.
- [4] E. Altman, R. El-Azouzi, D. S. Menasche, and Y. Xu, "Forever young: Aging control for hybrid networks," in *Proc. of the ACM Intl. Symposium on Mobile Ad Hoc Networking and Computing*. New York, NY, USA: ACM, 2019, pp. 91–100.
- [5] S. Kaul, M. Gruteser, V. Rai, and J. Kenney, "Minimizing age of information in vehicular networks," in *IEEE Commun. Society Conf. on Sensor, Mesh and Ad Hoc Commun. and Networks (SECON)*, June 2011.
- [6] S. Kaul, R. Yates, and M. Gruteser, "Real-time status: How often should one update?" in *IEEE Conf. on Computer Commun. (INFOCOM)*, Mar. 2012.
- [7] B. Zhou and W. Saad, "Joint status sampling and updating for minimizing age of information in the internet of things," *IEEE Transactions on Communications*, vol. 67, no. 11, pp. 7468–7482, 2019.
- [8] W. Saad, M. Bennis, and M. Chen, "A vision of 6G wireless systems: Applications, trends, technologies, and open research problems," *IEEE Network*, vol. 34, no. 3, pp. 134–142, 2020.
- [9] Y. Sun and B. Cyr, "Sampling for data freshness optimization: Non-linear age functions," *Journal of Commun. and Networks*, vol. 21, no. 3, pp. 204–219, June 2019.
- [10] X. Zheng, S. Zhou, Z. Jiang, and Z. Niu, "Closed-form analysis of non-linear age of information in status updates with an energy harvesting transmitter," *IEEE Transactions on Wireless Communications*, vol. 18, no. 8, pp. 4129–4142, 2019.
- [11] M. A. Abd-Elmagid, N. Pappas, and H. S. Dhillon, "On the role of age of information in the Internet of Things," *IEEE Commun. Magazine*, vol. 57, no. 12, pp. 72–77, 2019.

- [12] B. T. Bacinoglu, E. T. Ceran, and E. Uysal-Biyikoglu, "Age of information under energy replenishment constraints," in *Information Theory and Applications Workshop (ITA)*, Feb. 2015.
- [13] R. D. Yates, "Lazy is timely: Status updates by an energy harvesting source," in *IEEE Intl. Symposium on Information Theory (ISIT)*, June 2015.
- [14] A. Arafa and S. Ulukus, "Age minimization in energy harvesting commun.: Energy-controlled delays," in *51st Asilomar Conf. on Signals, Systems, and Computers*, Oct. 2017.
- [15] X. Wu, J. Yang, and J. Wu, "Optimal status update for age of information minimization with an energy harvesting source," *IEEE Trans. on Green Commun. and Networking*, vol. 2, no. 1, pp. 193–204, March 2018.
- [16] B. T. Bacinoglu and E. Uysal-Biyikoglu, "Scheduling status updates to minimize age of information with an energy harvesting sensor," in *IEEE Intl. Symposium on Information Theory (ISIT)*, June 2017.
- [17] A. Arafa, J. Yang, and S. Ulukus, "Age-minimal online policies for energy harvesting sensors with random battery recharges," in *IEEE Intl. Conf. on Commun. (ICC)*, May 2018.
- [18] A. Arafa, J. Yang, S. Ulukus, and H. V. Poor, "Age-minimal online policies for energy harvesting sensors with incremental battery recharges," in *Information Theory and Applications Workshop (ITA)*, Feb. 2018.
- [19] S. Farazi, A. G. Klein, and D. R. Brown, "Average age of information for status update systems with an energy harvesting server," in *IEEE Conf. on Computer Commun. Workshops (INFOCOM WKSHPS)*, Apr. 2018.
- [20] G. Stamatakis, N. Pappas, and A. Traganitis, "Control of status updates for energy harvesting devices that monitor processes with alarms," in *IEEE Globecom Workshops*, 2019.
- [21] A. Baknina and S. Ulukus, "Coded status updates in an energy harvesting erasure channel," in *52nd Annual Conf. on Information Sciences and Systems (CISS)*, Mar. 2018.
- [22] A. Baknina, S. Ulukus, O. Ozel, J. Yang, and A. Yener, "Sending information through status updates," in *IEEE Intl. Symposium on Information Theory (ISIT)*, June 2018.
- [23] B. T. Bacinoglu, Y. Sun, E. Uysal, and V. Mutlu, "Optimal status updating with a finite-battery energy harvesting source," *Journal of Commun. and Networks*, vol. 21, no. 3, pp. 280–294, June 2019.
- [24] Y. Dong, P. Fan, and K. B. Letaief, "Energy harvesting powered sensing in iot: Timeliness versus distortion," *IEEE Internet of Things Journal*, vol. 7, no. 11, pp. 10897–10911, 2020.
- [25] S. Feng and J. Yang, "Optimal status updating for an energy harvesting sensor with a noisy channel," in *IEEE Conf. on Computer Commun. Workshops (INFOCOM WKSHPS)*, Apr. 2018.
- [26] —, "Minimizing age of information for an energy harvesting source with updating failures," in *IEEE Intl. Symposium on Information Theory (ISIT)*, June 2018.
- [27] I. Krikidis, "Average age of information in wireless powered sensor networks," *IEEE Wireless Commun. Letters*, vol. 8, no. 2, pp. 628–631, Apr. 2019.
- [28] M. A. Abd-Elmagid, H. S. Dhillon, and N. Pappas, "A reinforcement learning framework for optimizing age of information in RF-powered communication systems," *IEEE Trans. on Commun.*, 2020.
- [29] S. Ghez, S. Verdu, and S. Schwartz, "Stability properties of slotted Aloha with multipacket reception capability," *IEEE Trans. on Automatic Control*, vol. 33, no. 7, pp. 640–649, Jul. 1988.
- [30] V. Naware, G. Mergen, and L. Tong, "Stability and delay of finite-user slotted aloha with multipacket reception," *IEEE Trans. on Inform. Theory*, vol. 51, no. 7, pp. 2636–2656, Jul. 2005.
- [31] G. Stamatakis, N. Pappas, and A. Traganitis, "Optimal policies for status update generation in an IoT device with heterogeneous traffic," *IEEE Internet of Things Journal*, 2020.
- [32] S. Gopal and S. K. Kaul, "A game theoretic approach to dsrc and wifi coexistence," in *IEEE Conference on Computer Commun. Workshops (INFOCOM WKSHPS)*, 2018, pp. 565–570.
- [33] S. Leng and A. Yener, "Age of information minimization for an energy harvesting cognitive radio," *IEEE Trans. on Cognitive Commun. and Networking*, vol. 5, no. 2, pp. 427–439, June 2019.
- [34] R. Talak, S. Karaman, and E. Modiano, "Optimizing information freshness in wireless networks under general interference constraints," *IEEE/ACM Trans. on Networking*, vol. 28, no. 1, pp. 15–28, 2020.
- [35] I. Kadota, A. Sinha, and E. Modiano, "Scheduling algorithms for optimizing age of information in wireless networks with throughput constraints," *IEEE/ACM Trans. on Networking*, vol. 27, no. 4, pp. 1359–1372, Aug 2019.
- [36] E. Fountoulakis, N. Pappas, M. Codreanu, and A. Ephremides, "Optimal sampling cost in wireless networks with age of information constraints," in *IEEE Conf. on Computer Commun. Workshops (INFOCOM WKSHPS)*, 2020.
- [37] L. Georgiadis, M. J. Neely, and L. Tassiulas, "Resource allocation and cross-layer control in wireless networks," *Foundations and Trends® in Networking*, vol. 1, no. 1, pp. 1–144, 2006.
- [38] M. J. Neely, "Stochastic network optimization with application to communication and queueing systems," *Synthesis Lectures on Communication Networks*, vol. 3, no. 1, pp. 1–211, 2010.
- [39] I. Dimitriou and N. Pappas, "Stable throughput and delay analysis of a random access network with queue-aware transmission," *IEEE Trans. on Wireless Commun.*, vol. 17, no. 5, pp. 3170–3184, 2018.