

# Flavor structures of charged fermions and massive neutrinos

Zhi-zhong Xing<sup>a,b,c</sup>

<sup>a</sup>*Institute of High Energy Physics, Chinese Academy of Sciences, Beijing 100049, China*

<sup>b</sup>*School of Physical Sciences, University of Chinese Academy of Sciences, Beijing 100049, China*

<sup>c</sup>*Center of High Energy Physics, Peking University, Beijing 100871, China*

---

## Abstract

Most of the free parameters in the Standard Model (SM) — a quantum field theory which has successfully elucidated the behaviors of strong, weak and electromagnetic interactions of all the known fundamental particles, come from the lepton and quark flavors. The discovery of neutrino oscillations has proved that the SM is incomplete, at least in its lepton sector; and thus the door of opportunity is opened to exploring new physics beyond the SM and solving a number of flavor puzzles. In this review article we give an overview of important progress made in understanding the mass spectra, flavor mixing patterns, CP-violating effects and underlying flavor structures of charged leptons, neutrinos and quarks in the past twenty years. After introducing the standard pictures of fermion mass generation, flavor mixing and CP violation in the SM extended with the presence of massive Dirac or Majorana neutrinos, we briefly summarize current experimental knowledge about the flavor parameters of quarks and leptons. Various ways of describing flavor mixing and CP violation are discussed, the renormalization-group evolution of flavor parameters is illuminated, and the matter effects on neutrino oscillations are interpreted. Taking account of possible extra neutrino species, we propose a standard parametrization of the  $6 \times 6$  flavor mixing matrix and comment on the phenomenological aspects of heavy, keV-scale and light sterile neutrinos. We pay particular attention to those novel and essentially model-independent ideas or approaches regarding how to determine the Yukawa textures of Dirac fermions and the effective mass matrix of Majorana neutrinos, including simple discrete and continuous flavor symmetries. An outlook to the future development in unraveling the mysteries of flavor structures is also given.

*Keywords:* lepton, quark, neutrino oscillation, fermion mass, flavor mixing, CP violation, lepton number violation, sterile neutrino, Yukawa texture, flavor symmetry

*PACS:* 11.10.Hi, 12.15.-y, 12.15.Ff, 12.60.-i, 14.60.Pq, 14.60.St, 23.40.-s, 23.40.Bw, 95.35.+d

---

## Contents

<b>1</b>	<b>Introduction</b>	<b>4</b>
1.1	A brief history of lepton and quark flavors . . . . .	4
1.2	A short list of the unsolved flavor puzzles . . . . .	8

---

*Email address:* xingzz@ihep.ac.cn (Zhi-zhong Xing)

*Preprint submitted to Physics Reports*

*April 27, 2020*

arXiv:1909.09610v4 [hep-ph] 24 Apr 2020

<b>2</b>	<b>The standard picture of fermion mass generation</b>	<b>15</b>
2.1	The masses of charged leptons and quarks . . . . .	15
2.1.1	The electroweak interactions of fermions . . . . .	15
2.1.2	Yukawa interactions and quark flavor mixing . . . . .	17
2.2	Dirac and Majorana neutrino mass terms . . . . .	19
2.2.1	Dirac neutrinos and lepton flavor violation . . . . .	19
2.2.2	Majorana neutrinos and lepton number violation . . . . .	21
2.2.3	The canonical seesaw mechanism and others . . . . .	23
2.3	A diagnosis of the origin of CP violation . . . . .	27
2.3.1	The Kobayashi-Maskawa mechanism . . . . .	27
2.3.2	Baryogenesis via thermal leptogenesis . . . . .	31
2.3.3	Strong CP violation in a nutshell . . . . .	35
<b>3</b>	<b>Current knowledge about the flavor parameters</b>	<b>39</b>
3.1	Running masses of charged leptons and quarks . . . . .	39
3.1.1	On the concepts of fermion masses . . . . .	39
3.1.2	Running masses of three charged leptons . . . . .	40
3.1.3	Running masses of six quarks . . . . .	42
3.2	The CKM quark flavor mixing parameters . . . . .	44
3.2.1	Determination of the CKM matrix elements . . . . .	44
3.2.2	The Wolfenstein parameters and CP violation . . . . .	47
3.3	Constraints on the neutrino masses . . . . .	49
3.3.1	Some basics of neutrino oscillations . . . . .	49
3.3.2	Neutrino mass-squared differences . . . . .	51
3.3.3	The absolute neutrino mass scale . . . . .	54
3.4	The PMNS lepton flavor mixing parameters . . . . .	59
3.4.1	Flavor mixing angles and CP-violating phases . . . . .	59
3.4.2	The global-fit results and their implications . . . . .	63
3.4.3	Some constant lepton flavor mixing patterns . . . . .	65
<b>4</b>	<b>Descriptions of flavor mixing and CP violation</b>	<b>68</b>
4.1	Rephasing invariants and commutators . . . . .	68
4.1.1	The Jarlskog invariants of CP violation . . . . .	68
4.1.2	Commutators of fermion mass matrices . . . . .	70
4.2	Unitarity triangles of leptons and quarks . . . . .	72
4.2.1	The CKM unitarity triangles of quarks . . . . .	72
4.2.2	The PMNS unitarity triangles of leptons . . . . .	74
4.3	Euler-like parametrizations of $U$ and $V$ . . . . .	75
4.3.1	Nine distinct Euler-like parametrizations . . . . .	75
4.3.2	Which parametrization is favored? . . . . .	80
4.4	The effective PMNS matrix in matter . . . . .	82
4.4.1	Sum rules and asymptotic behaviors . . . . .	82
4.4.2	Differential equations of $\tilde{U}$ . . . . .	87

4.5	Effects of renormalization-group evolution . . . . .	89
4.5.1	RGEs for the Yukawa coupling matrices . . . . .	89
4.5.2	Running behaviors of quark flavors . . . . .	93
4.5.3	Running behaviors of massive neutrinos . . . . .	97
<b>5</b>	<b>Flavor mixing between active and sterile neutrinos</b>	<b>101</b>
5.1	A parametrization of the $6 \times 6$ flavor mixing matrix . . . . .	101
5.1.1	The interplay between active and sterile neutrinos . . . . .	101
5.1.2	The Jarlskog invariants for active neutrinos . . . . .	105
5.1.3	On the (3+2) and (3+1) flavor mixing scenarios . . . . .	107
5.2	The seesaw-motivated heavy Majorana neutrinos . . . . .	109
5.2.1	Naturalness and testability of seesaw mechanisms . . . . .	109
5.2.2	Reconstruction of the neutrino mass matrices . . . . .	111
5.2.3	On lepton flavor violation of charged leptons . . . . .	113
5.3	keV-scale sterile neutrinos as warm dark matter . . . . .	115
5.3.1	On the keV-scale sterile neutrino species . . . . .	115
5.3.2	A possibility to detect keV-scale sterile neutrinos . . . . .	117
5.4	Anomaly-motivated light sterile neutrinos . . . . .	120
5.4.1	The anomalies hinting at light sterile neutrinos . . . . .	120
5.4.2	Some possible phenomenological consequences . . . . .	122
<b>6</b>	<b>Possible Yukawa textures of quark flavors</b>	<b>124</b>
6.1	Quark flavor mixing in the quark mass limits . . . . .	124
6.1.1	Quark mass matrices in two extreme cases . . . . .	124
6.1.2	Some salient features of the CKM matrix . . . . .	125
6.2	Quark flavor democracy and its breaking effects . . . . .	127
6.2.1	$S_3$ and $S_{3L} \times S_{3R}$ flavor symmetry limits . . . . .	127
6.2.2	Breaking of the quark flavor democracy . . . . .	129
6.2.3	Comments on the Friedberg-Lee symmetry . . . . .	131
6.3	Texture zeros of quark mass matrices . . . . .	133
6.3.1	Where do texture zeros come from? . . . . .	133
6.3.2	Four- and five-zero quark flavor textures . . . . .	135
6.3.3	Comments on the stability of texture zeros . . . . .	138
6.4	Towards building a realistic flavor model . . . . .	139
6.4.1	Hierarchies and $U(1)$ flavor symmetries . . . . .	139
6.4.2	Model building based on $A_4$ flavor symmetry . . . . .	141
<b>7</b>	<b>Possible charged-lepton and neutrino flavor textures</b>	<b>144</b>
7.1	Reconstruction of the lepton flavor textures . . . . .	144
7.1.1	Charged leptons and Dirac neutrinos . . . . .	144
7.1.2	The Majorana neutrino mass matrix . . . . .	149
7.1.3	Breaking of $\mu$ - $\tau$ reflection symmetry . . . . .	152
7.2	Zero textures of massive Majorana neutrinos . . . . .	157

7.2.1	Two- and one-zero flavor textures of $M_\nu$ . . . . .	157
7.2.2	The Fritzsche texture on the seesaw . . . . .	160
7.2.3	Seesaw mirroring between $M_\nu$ and $M_R$ . . . . .	163
7.3	Simplified versions of seesaw mechanisms . . . . .	165
7.3.1	The minimal seesaw mechanism . . . . .	165
7.3.2	The minimal type-(I+II) seesaw scenario . . . . .	168
7.3.3	The minimal inverse seesaw scenario . . . . .	170
7.4	Flavor symmetries and model-building approaches . . . . .	172
7.4.1	Leptonic flavor democracy and $S_3$ symmetry . . . . .	172
7.4.2	Examples of $A_4$ and $S_4$ flavor symmetries . . . . .	174
7.4.3	Generalized CP and modular symmetries . . . . .	176

## 8 Summary and outlook 181

### 1. Introduction

#### 1.1. A brief history of lepton and quark flavors

The history of particle physics can be traced back to the discovery of the electron by Joseph Thomson in 1897 [1]. Since then particle physicists have been trying to answer an age-old but fundamentally important question posed by Gottfried Leibniz in 1714: *Why is there something rather than nothing?* Although a perfect answer to this question has not been found out, great progress has been made in understanding what the Universe is made of and how it works, both microscopically and macroscopically. Among many milestones in this connection, the biggest and most marvelous one is certainly the Standard Model (SM) of particle physics.

The SM is a renormalizable quantum field theory consisting of two vital parts: the electroweak part which unifies electromagnetic and weak interactions based on the  $SU(2)_L \times U(1)_Y$  gauge groups [2, 3, 4], and the quantum chromodynamics (QCD) part which describes the behaviors of strong interactions based on the  $SU(3)_c$  gauge group [5, 6, 7]. Besides the peculiar spin-zero Higgs boson and some spin-one *force-mediating* particles — the photon, gluons,  $W^\pm$  and  $Z^0$  bosons, the SM contains a number of spin-half *matter* particles — three charged leptons ( $e, \mu, \tau$ ), three neutrinos ( $\nu_e, \nu_\mu, \nu_\tau$ ), six quarks ( $u, c, t$  and  $d, s, b$ ), and their antiparticles. Fig. 1 provides a schematic illustration of these elementary particles and their interactions allowed by the SM, in which each of the fermions is usually referred to as a “flavor”, an intriguing term inspired by and borrowed from different flavors of ice cream <sup>1</sup>. It is straightforward to see

- why the photon, gluons and neutrinos are massless. The reason is simply that they have no direct coupling with the Higgs field. While the unbroken  $U(1)_{em}$  and  $SU(3)_c$  gauge symmetries respectively preserve the photon and gluons to be massless, there is no fundamental symmetry or conservation law to dictate the neutrino masses to vanish. But today there is solid evidence for solar [9, 10, 11, 12], atmospheric [13], reactor [14, 15] and accelerator

---

<sup>1</sup>This term was first used by Harald Fritzsch and Murray Gell-Mann to distinguish one kind of quark from another, when they ate ice cream at a Baskin Robbins ice-cream store in Pasadena in 1971 [8].

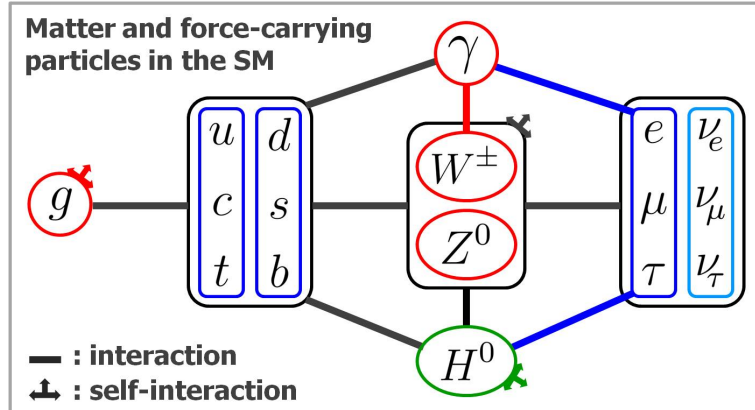

Figure 1: An illustration of the elementary particles and their interactions in the SM, in which the thick lines mean that the relevant particles are coupled with each other. Note that the Higgs field, gluon fields and weak vector boson fields have their own self-interactions, respectively.

[16, 17, 18] neutrino (or antineutrino) oscillations, convincing us that the elusive neutrinos *do* possess tiny masses and their flavors are mixed [19]. This is certainly a striking signal of new physics beyond the SM.

- why flavor mixing and weak CP violation can occur in the quark sector. The reason is simply that the three families of quarks interact with both the Higgs boson and the weak vector bosons, leading to a nontrivial mismatch between mass and flavor eigenstates of the three families of quarks as described by the  $3 \times 3$  Cabibbo-Kobayashi-Maskawa (CKM) matrix [20, 21]. The latter accommodates three flavor mixing angles and one CP-violating phase which determine the strengths of flavor conversion and CP nonconservation.

So *fermion mass, flavor mixing* and *CP violation* constitute three central concepts of flavor physics. But the SM itself does not make any quantitative predictions for the values of fermion masses, flavor mixing angles and CP-violating phases, and hence any deeper understanding of such flavor issues must go beyond the scope of the SM.

Within the framework of the SM, the quark flavors take part in both electroweak and strong interactions, the charged-lepton flavors are sensitive to the electroweak interactions, and the neutrino flavors are only subject to the weak interactions. These particles can therefore be produced and detected in proper experimental environments. Table 1 is a list of some important milestones associated with the discoveries of lepton and quark flavors. The discoveries of  $W^\pm$ ,  $Z^0$  and  $H^0$  bosons have also been included in Table 1, simply because their interactions with charged fermions and massive neutrinos help define the *flavor* eigenstates of such matter particles. Some immediate comments are in order.

(1) The history of flavor physics has been an interplay between experimental discoveries and theoretical developments. For instance, the existence of the positron was predicted by Paul Dirac in 1928 [47] and 1931 [48], at least two years before it was observed in 1933. The pion was predicted by Hideki Yukawa in 1935 [49], and it was experimentally discovered in 1947. The

Table 1: Some important milestones associated with the experimental discoveries of lepton or quark flavors and the effects of parity and CP violation. The discoveries of  $W^\pm$ ,  $Z^0$  and  $H^0$  bosons are also listed here as a reference.

	Experimental discoveries	Discoverers or collaborations
1897	electron	J. J. Thomson [1]
1917	proton (up and down quarks)	E. Rutherford [22]
1932	neutron (up and down quarks)	J. Chadwick [23]
1933	positron	C. D. Anderson [24]
1936	muon	C. D. Anderson, S. H. Neddermeyer [25]
1947	pion (up and down quarks)	C. M. G. Lattes, et al. [26]
1947	Kaon (strange quark)	G. D. Rochester, C.C. Butler [27]
1956	electron antineutrino	C. L. Cowan, et al. [28]
1957	Parity violation	C. S. Wu, et al. [29]; R. L. Garwin, et al. [30]
1962	muon neutrino	G. Danby, et al. [31]
1964	CP violation in $s$ -quark decays	J. H. Christenson, et al. [32]
1974	charmonium (charm quark)	J. J. Aubert, et al. [33]; J. E. Augustin, et al. [34]
1975	tau	M. L. Perl, et al. [35]
1977	bottomonium (bottom quark)	S. W. Herb, et al. [36]
1983	weak $W^\pm$ bosons	G. Arnison, et al. [37]
1983	weak $Z^0$ boson	G. Arnison, et al. [38]
1995	top quark	F. Abe, et al. [39]; S. Abachi, et al. [40]
2000	tau neutrino	K. Kodama, et al. [41]
2001	CP violation in $b$ -quark decays	B. Aubert, et al. [42]; K. Abe, et al. [43]
2012	Higgs boson $H^0$	G. Aad, et al. [44]; S. Chatrchyan, et al. [45]
2019	CP violation in $c$ -quark decays	R. Aaij et al. [46]

electron antineutrino was first conjectured by Wolfgang Pauli in 1930 and later embedded into the effective field theory of the beta decays by Enrico Fermi in 1933 [50] and 1934 [51], but it was not observed until 1956. The quark model proposed independently by Murray Gell-Mann [52] and George Zweig [53] in 1964 was another success on the theoretical side, which helped a lot in organizing a variety of the mesons and baryons observed in the 1960's.

(2) The observation of parity violation in weak interactions was a great breakthrough and confirmed Tsung-Dao Lee and Chen-Ning Yang's revolutionary conjecture in this connection [54], and it subsequently led to the two-component theory of neutrinos [55, 56, 57] and the V–A structure of weak interactions [58, 59]. Such theoretical progress, together with the Brout-Englert-Higgs (BEH) mechanism [60, 61, 62, 63], helped to pave the way for Sheldon Glashow's work in 1961 [2] and the Weinberg-Salam model of electroweak interactions in 1967 [3, 4]. After the renormalizability of this model was proved by Gerard 't Hooft in 1971 [64, 65], it became the standard electroweak theory of particle physics and proved to be greatly successful.

(3) Among other things, the presence of weak neutral currents and the suppression of flavor-changing neutral currents are two salient features of the SM. The former was experimentally verified by the Gargamelle Neutrino Collaboration in 1973 [66], and the latter was theoretically ex-

plained with the help of the Glashow-Iliopoulos-Maiani (GIM) mechanism [67]. At that time the prerequisite for the GIM mechanism to work was the existence of a fourth quark [68] and its Cabibbo-like mixing with the down and strange quarks [20, 69]. Both of these two conjectures turned out to be true after the charm quark was discovered in 1974.

(4) The observation of CP violation in the  $K^0$ - $\bar{K}^0$  system was another great milestone in particle physics, as it not only motivated Andrei Sakharov to put forward the necessary conditions that a baryon-generating interaction must satisfy to produce the observed baryon-antibaryon asymmetry of the Universe in 1967 [70], but also inspired Makoto Kobayashi and Toshihide Maskawa to propose a three-family mechanism of quark flavor mixing which can naturally accommodate weak CP violation in 1973 [21]. This mechanism was by no means economical at that time because its validity required the existence of three new hypothetical flavors — charm, bottom and top, but it was finally proved to be the correct source of CP violation within the SM.

In the lepton sector the elusive neutrinos have been an active playground to promote new ideas and explore new physics. It was Ettore Majorana who first speculated that a neutrino might be its own antiparticle [71], and his speculation has triggered off a long search for the neutrinoless double-beta ( $0\nu 2\beta$ ) decays mediated by the Majorana neutrinos since the pioneering calculation of the  $0\nu 2\beta$  decay rates was done in 1939 [72]. In 1957, Bruno Pontecorvo challenged the two-component neutrino theory by assuming that the electron neutrino should be a massive Majorana fermion and the lepton-number-violating transition  $\nu_e \leftrightarrow \bar{\nu}_e$  could take place [73] in a way similar to the  $K^0 \leftrightarrow \bar{K}^0$  oscillation [74]. Soon after the discovery of the muon neutrino in 1962, Ziro Maki, Masami Nakagawa and Shoichi Sakata proposed a two-flavor neutrino mixing picture to link  $\nu_e$  and  $\nu_\mu$  with their mass eigenstates  $\nu_1$  and  $\nu_2$  [75]. That is why the  $3 \times 3$  neutrino mixing matrix is commonly referred to as the Pontecorvo-Maki-Nakagawa-Sakata (PMNS) matrix.

The year 1968 can be regarded as the beginning of the *neutrino oscillation* era, simply because the solar  $^8\text{B}$  neutrino deficit was first observed by Raymond Davis in the Homestake experiment via the radiochemical reaction  $\nu_e + {}^{37}\text{Cl} \rightarrow e^- + {}^{37}\text{Ar}$  [9] and the two-flavor neutrino oscillation probabilities were first formulated by Pontecorvo [76, 77]. Since then the flavor oscillations of neutrinos or antineutrinos have convincingly been detected in a number of underground experiments, as partially listed in Table 2<sup>2</sup>. Some brief comments are in order.

(a) Some theorists have made important contributions towards understanding the production of solar neutrinos and their oscillation behaviors inside the Sun, leading to a final solution to the long-standing solar neutrino problem in 2002. For example, John Bahcall’s pioneering work in establishing the Standard Solar Model (SSM) has exercised a profound and far-reaching influence on the development of neutrino astrophysics [80, 81, 82]; and the description of how neutrinos oscillate in medium, known as the Mikheyev-Smirnov-Wolfenstein (MSW) matter effect [83, 84], was a remarkable theoretical milestone in neutrino physics.

(b) The unexpected observation of a neutrino burst from the Supernova 1987A explosion in the Large Magellanic Cloud opened a new window for neutrino astronomy. On the other hand, the observations of a number of high-energy extraterrestrial neutrino events ranging from about 30 TeV to about 1 PeV at the IceCube detector [85, 86] confirmed the unique role of cosmic

---

<sup>2</sup>For the sake of simplicity, here only the neutrino (or antineutrino) oscillation experiments that were recognized by the 2002 and 2015 Nobel Prizes or the 2016 Breakthrough Prize in Fundamental Physics are listed.

Table 2: Some key milestones associated with the experimental discoveries of neutrino or antineutrino oscillations.

	Neutrino sources and oscillations	Discoverers or collaborations
1968	solar neutrinos ( $\nu_e \rightarrow \nu_e$ )	R. Davis, et al. [9]
1987	supernova antineutrinos ( $\bar{\nu}_e$ )	K. Hirata, et al. [78]; R. M. Bionta, et al. [79]
1998	atmospheric neutrinos ( $\nu_\mu \rightarrow \nu_\mu$ )	Y. Fukuda, et al. [13]
2001	solar neutrinos ( $\nu_e \rightarrow \nu_e, \nu_\mu, \nu_\tau$ )	Q. R. Ahmad, et al. [10, 12]; S. Fukuda, et al. [11]
2002	reactor antineutrinos ( $\bar{\nu}_e \rightarrow \bar{\nu}_e$ )	K. Eguchi, et al. [14]
2002	accelerator neutrinos ( $\nu_\mu \rightarrow \nu_\mu$ )	M. H. Ahn, et al. [16]
2011	accelerator neutrinos ( $\nu_\mu \rightarrow \nu_e$ )	K. Abe, et al. [17, 18]
2012	reactor antineutrinos ( $\bar{\nu}_e \rightarrow \bar{\nu}_e$ )	F. P. An, et al. [15]

neutrinos as a messenger in probing the depth of the Universe which is opaque to light.

(c) A careful combination of currently available neutrino oscillation data allows us to determine two independent neutrino mass-squared differences and three neutrino mixing angles to a very good degree of accuracy in the standard three-flavor scheme, although the ordering of three neutrino masses has not been fully fixed and the strength of leptonic CP violation remains undetermined [19]. These achievements have motivated a great quantity of elaborate theoretical efforts towards unraveling the mysteries of neutrino mass generation and flavor mixing dynamics, but a convincing quantitative model of this kind has not been obtained [87].

In short, there exist three families of leptons and quarks in nature, and their existence fits in well with the framework of the SM. The fact that three kinds of neutrinos possess finite but tiny masses has been established on solid ground, but it ought not to spoil the core structure of the SM. Moreover, quark flavor mixing effects, neutrino flavor oscillations and CP violation in the weak charged-current interactions associated with quarks have all been observed, and some effort has also been made to search for leptonic CP violation in  $\nu_\mu \rightarrow \nu_e$  versus  $\bar{\nu}_\mu \rightarrow \bar{\nu}_e$  oscillations [88]. All these developments are open to both benign and malign interpretations: on the one hand, the SM and its simple extension to include neutrino masses and lepton flavor mixing are very successful in understanding what we have observed; on the other hand, the SM involves too many flavor parameters which have to be experimentally determined rather than theoretically predicted.

### 1.2. A short list of the unsolved flavor puzzles

Within the three-flavor scheme of quarks and leptons, there are totally twenty (or twenty-two) flavor parameters provided massive neutrinos are the Dirac (or Majorana) fermions<sup>3</sup>. These parameters include six quark masses, three charged-lepton masses, three neutrino masses, three quark flavor mixing angles and one CP-violating phase in the CKM matrix, three lepton flavor mixing angles and one (or three) CP-violating phase(s) in the PMNS matrix. One may therefore classify the unsolved flavor puzzles into three categories, corresponding to three central concepts in flavor physics— fermion masses, flavor mixing and CP violation.

<sup>3</sup>Note that a peculiar phase parameter characterizing possible existence of *strong* CP violation in QCD is not taken into account here, but its physical meaning will be discussed in section 2.3.3.



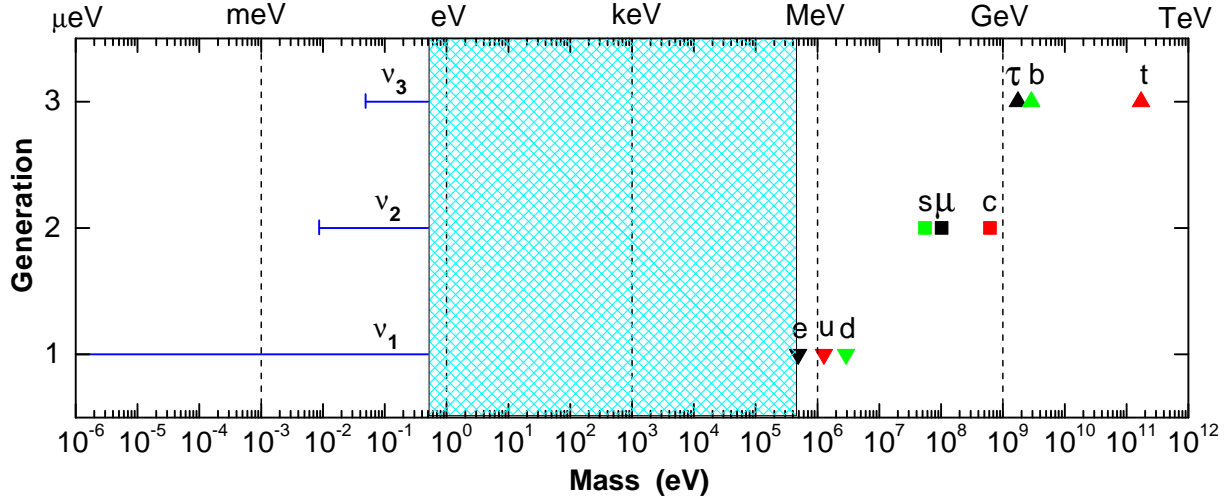

Figure 2: A schematic illustration of flavor “hierarchy” and “desert” problems in the SM fermion mass spectrum at the energy scale  $M_Z$  [89], where the central values of charged-lepton and quark masses are quoted from Refs. [90, 91], and the allowed ranges of three neutrino masses with a normal ordering are cited from Refs. [92, 93].

*Category (1): the puzzles associated with fermion masses.* Within the SM, the masses of nine charged fermions are expressed as the products of their respective Yukawa coupling eigenvalues and the vacuum expectation value of the neutral Higgs field, while the masses of three neutrinos are vanishing as a straightforward consequence of the model’s simple and economical structure. In particular, the neutrinos are chosen to be only *left-handed* for no good theoretical reason within the SM; and hence introducing the right-handed neutrino states is undoubtedly a natural way to generate nonzero neutrino masses beyond the SM. For example, the difference between baryon number  $B$  and lepton number  $L$  is the only anomaly-free global symmetry of the SM [94, 95], and it can be promoted to a local  $B - L$  symmetry of electroweak interactions by naturally introducing three right-handed neutrinos [96, 97, 98, 99]. The right-handed neutrino states also appear as a natural and necessary ingredient in some grand unification theories (GUTs) with the left-right [100, 101, 102] or  $SO(10)$  gauge symmetry [103, 104]. Since the Yukawa coupling matrices of  $Q = -1$  leptons,  $Q = +2/3$  quarks and  $Q = -1/3$  quarks are completely undetermined in the SM, one is left with no quantitative predictions for their masses and no interpretation of the observed mass spectrum as shown in the right panel of Fig. 2<sup>4</sup>. Therefore, we wonder

- why there is a very strong mass hierarchy in the charged-lepton and quark sectors (namely,  $m_e \ll m_\mu \ll m_\tau$ ,  $m_u \ll m_c \ll m_t$  and  $m_d \ll m_s \ll m_b$ ), although all of them originate from the BEH mechanism and Yukawa interactions. In other words, we have not found out a compelling reason why the mass spectrum of nine charged fermions has a span of nearly six orders of magnitudes. This puzzle can be referred to as the *flavor hierarchy* problem.

<sup>4</sup>Here only the *normal* neutrino mass ordering (i.e.,  $m_1 < m_2 < m_3$ ) is considered for the purpose of illustration, and it is actually favored over the *inverted* one (i.e.,  $m_3 < m_1 < m_2$ ) at the  $3\sigma$  level [92, 93].

- why there is a *flavor desert* between the neutral and charged fermion masses, spanning about six orders of magnitude. A conservative upper limit on the neutrino masses should be of  $O(0.1)$  eV to  $O(1)$  eV [19], although the latest Planck constraint on the sum of three neutrino masses sets an even more stringent upper bound 0.12 eV at the 95% confidence level [105]. Such flavor “hierarchy” and “desert” issues might hint at the Majorana nature of massive neutrinos, a kind of new physics far beyond the SM. Namely, the origin of neutrino masses is very likely to be considerably different from that of charged-fermion masses.
- what the real mechanism of neutrino mass generation is. It is often argued that a pure Dirac neutrino mass term, just like the mass term of three charged leptons, would be compatible with ‘t Hooft’s *naturalness criterion* [106] but inconsistent with Gell-Mann’s *totalitarian principle* [107]<sup>5</sup>. On the one hand, switching off such a tiny mass term *does* allow for lepton flavor conservation in the classical regime of an SM-like system if non-perturbative quantum effects are not taken into account [87, 110], and hence its presence seems not to be unnatural. But on the other hand, a right-handed  $(SU(2)_L)$  singlet neutrino field and its charge-conjugated counterpart can form a new Majorana neutrino mass term which is not forbidden by any fundamental symmetry, and thus a combination of this term and the Dirac neutrino mass term would dictate massive neutrinos to have the Majorana nature. The canonical seesaw mechanism [111, 112, 113, 114, 115] and its various variations were proposed along this line of thought, and their basic idea is to ascribe the small masses of three known neutrinos to the existence of some unknown heavy degrees of freedom.
- whether the twelve independent mass parameters can be (partly) correlated with one another in a theoretical framework beyond the SM. A viable left-right symmetric [100, 101, 102],  $SO(10)$  [103, 104] or  $SU(5)$  [116] GUT is possible to establish an intrinsic link between leptons and quarks. In this connection both lepton and baryon numbers are nonconservative [87, 110], implying that the proton might be unstable and massive neutrinos should be the Majorana particles. A typical example is the so-called Georgi-Jarlskog mass relations at the GUT scale [117]:  $m_b = m_\tau$ ,  $m_\mu = 3m_s$  and  $m_d = 3m_e$ . Quantum corrections to such tree-level mass relations are absolutely necessary so as to confront them with the values of charged-lepton and quark masses at low energies.

In addition, the strange “flavor desert” shown in Fig. 2 is so suggestive that it might hide one or more *sterile* neutrinos in the keV mass range [89]<sup>6</sup> — a good candidate for warm dark matter in the Universe [118, 119, 120, 121]. If such new but relatively light degrees of freedom exist, the origin of their masses will certainly be another flavor puzzle.

---

<sup>5</sup>The naturalness criterion tells us that “at any energy scale  $\mu$ , a set of parameters  $\alpha_i(\mu)$  describing a system can be small, if and only if, in the limit  $\alpha_i(\mu) \rightarrow 0$  for each of these parameters, the system exhibits an enhanced symmetry” [106]. In contrast, the totalitarian principle claims that “everything not forbidden is compulsory” [107]. Of course, these two kinds of criteria and some other *empirical* guiding principles for model building beyond the SM may not always work and thus should not be overstated [108, 109].

<sup>6</sup>Here “sterile” means that such a hypothetical neutrino species does not directly take part in the standard weak interactions, but it may mix with the normal (or “active”) neutrinos and thus participate in weak interactions and neutrino oscillations in an indirect way.

*Category (2): the puzzles associated with flavor mixing patterns.* If the SM is minimally extended by allowing its three neutrinos to be massive, then one may treat lepton flavor mixing and quark flavor mixing on the same footing. The puzzling phenomena of flavor mixing and CP violation come from a nontrivial mismatch between the mass and flavor eigenstates of three-family leptons or quarks, and such a mismatch stems from the fact that lepton or quark fields can interact with both scalar and gauge fields (as illustrated in Fig. 1). After transforming all the flavor eigenstates into the mass eigenstates, the flavor mixing and CP-violating effects of leptons and quarks can only manifest themselves in the weak charged-current interactions, described respectively by the PMNS matrix  $U$  and the CKM matrix  $V$ :

$$\mathcal{L}_{cc} = \frac{g}{\sqrt{2}} \left[ \overline{(e \ \mu \ \tau)}_L \gamma^\mu U \begin{pmatrix} \nu_1 \\ \nu_2 \\ \nu_3 \end{pmatrix}_L W_\mu^- + \overline{(u \ c \ t)}_L \gamma^\mu V \begin{pmatrix} d \\ s \\ b \end{pmatrix}_L W_\mu^+ \right] + \text{h.c.} . \quad (1)$$

Note that  $U$  and  $V$  are commonly defined, by convention or for some reason, to be associated respectively with  $W^-$  and  $W^+$ . Note also that the SM dictates the  $3 \times 3$  CKM matrix  $V$  to be exactly unitary, but whether the  $3 \times 3$  PMNS matrix  $U$  is unitary or not depends on the mechanism of neutrino mass generation — its unitarity will be slightly violated if the three light neutrinos mix with some extra degrees of freedom (e.g., this is the case in the canonical seesaw mechanism to be discussed in sections 2.2.3 and 5.2.2). Here we assume  $U$  to be unitary, given the fact that current neutrino oscillation data and electroweak precision measurements have left little room for the observable effects of possible unitarity violation (i.e., below  $\mathcal{O}(10^{-2})$  [122, 123, 124]). In this situation one may parametrize  $U$  in terms of three flavor mixing angles and one (or three) physical CP-violating phase(s) in a “standard” way as advocated by the Particle Data Group [19], corresponding to the Dirac (or Majorana) nature of the neutrinos:

$$\begin{aligned} U &= \begin{pmatrix} 1 & 0 & 0 \\ 0 & c_{23} & s_{23} \\ 0 & -s_{23} & c_{23} \end{pmatrix} \begin{pmatrix} c_{13} & 0 & s_{13}e^{-i\delta_\nu} \\ 0 & 1 & 0 \\ -s_{13}e^{i\delta_\nu} & 0 & c_{13} \end{pmatrix} \begin{pmatrix} c_{12} & s_{12} & 0 \\ -s_{12} & c_{12} & 0 \\ 0 & 0 & 1 \end{pmatrix} P_\nu \\ &= \begin{pmatrix} c_{12}c_{13} & s_{12}c_{13} & s_{13}e^{-i\delta_\nu} \\ -s_{12}c_{23} - c_{12}s_{13}s_{23}e^{i\delta_\nu} & c_{12}c_{23} - s_{12}s_{13}s_{23}e^{i\delta_\nu} & c_{13}s_{23} \\ s_{12}s_{23} - c_{12}s_{13}c_{23}e^{i\delta_\nu} & -c_{12}s_{23} - s_{12}s_{13}c_{23}e^{i\delta_\nu} & c_{13}c_{23} \end{pmatrix} P_\nu , \end{aligned} \quad (2)$$

in which  $c_{ij} \equiv \cos \theta_{ij}$  and  $s_{ij} \equiv \sin \theta_{ij}$  (for  $ij = 12, 13, 23$ ) with  $\theta_{ij}$  lying in the first quadrant,  $\delta_\nu$  is the irreducible CP-violating phase which is usually referred to as the Dirac phase, and  $P_\nu \equiv \text{Diag}\{e^{i\rho}, e^{i\sigma}, 1\}$  is a diagonal phase matrix containing two independent phase parameters  $\rho$  and  $\sigma$ . The latter may have physical meaning only when massive neutrinos are the Majorana particles. The same parametrization is applicable to the CKM matrix  $V$  with three flavor mixing angles ( $\vartheta_{12}$ ,  $\vartheta_{13}$  and  $\vartheta_{23}$ ) and one physical CP-violating phase  $\delta_q$  [125, 126, 127]. The phase parameters  $\delta_\nu$  and  $\delta_q$  signify CP violation in neutrino oscillations and that in quark decays, respectively. The allowed  $3\sigma$  ranges of six flavor mixing angles are plotted in Fig. 3 for illustration, where the present experimental data on quark decays [19] and neutrino oscillations [93] have been input and the normal neutrino mass ordering has been taken. Some open questions are in order.

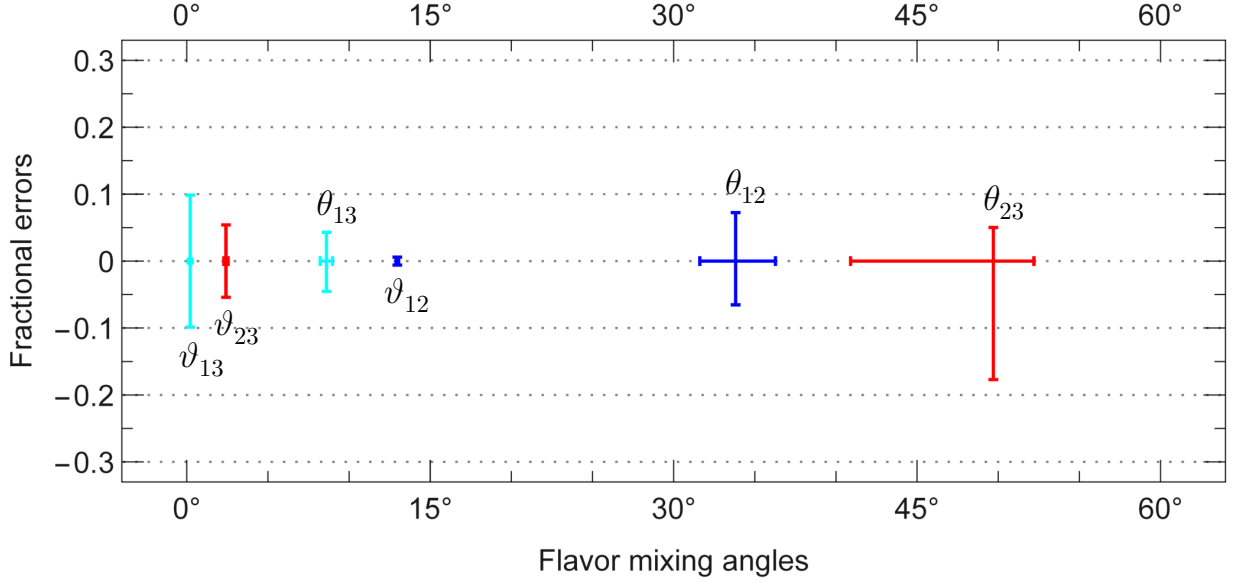

Figure 3: A schematic illustration of the  $3\sigma$  ranges of three lepton flavor mixing angles ( $\theta_{12}$ ,  $\theta_{13}$  and  $\theta_{23}$ ) and three quark flavor mixing angles ( $\vartheta_{12}$ ,  $\vartheta_{13}$  and  $\vartheta_{23}$ ) constrained by current experimental data on quark decays [19] and neutrino oscillations [93], respectively. Here only the normal neutrino mass ordering is taken into account, simply because it is favored over the inverted neutrino mass order at the  $3\sigma$  level [92, 93]. The fractional errors of each mixing angle measure the relative uncertainties around its best-fit value.

- How to interpret the observed quark flavor mixing pattern. In view of  $\vartheta_{12} \simeq 13^\circ$ ,  $\vartheta_{13} \simeq 0.21^\circ$  and  $\vartheta_{23} \simeq 2.4^\circ$  as shown in Fig. 3 for quark flavor mixing, we expect that the CKM matrix  $V$  is nearly an identity matrix with small off-diagonal perturbations. Namely,  $V = I + \mathcal{O}(\lambda) + \mathcal{O}(\lambda^2) + \dots$ , with  $\lambda \simeq \sin \vartheta_{12} \simeq 0.22$  being the Wolfenstein expansion parameter used to describe the hierarchical structure of  $V$  [128]. The latter is expected to have something to do with the strong mass hierarchies of up- and down-type quarks illustrated by Fig. 2 (i.e.,  $m_u/m_c \sim m_c/m_t \sim \lambda^4$  and  $m_d/m_s \sim m_s/m_b \sim \lambda^2$ ). For example, the interesting empirical relation  $\sin \vartheta_{12} \simeq \sqrt{m_d/m_s}$  can be derived from a very simple texture of quark mass matrices [129, 130, 131]. To fully understand potential correlations between quark mass ratios and flavor mixing angles, it is necessary to determine the corresponding structures of Yukawa coupling matrices with the help of a theoretical guiding principle or a phenomenological organizing principle, such as the discrete [132, 133] and continuous [134] flavor symmetries or the Fritzsch-like zero textures [135, 136]. So far a unique and convincing solution to the quark flavor mixing problem has been lacking [137].
- How to explain the observed lepton flavor mixing pattern. The recent best-fit values of three lepton flavor mixing angles are  $\theta_{12} \simeq 33.5^\circ$ ,  $\theta_{13} \simeq 8.4^\circ$  and  $\theta_{23} \simeq 47.9^\circ$  [92] (or  $\theta_{12} \simeq 33.8^\circ$ ,  $\theta_{13} \simeq 8.6^\circ$  and  $\theta_{23} \simeq 49.7^\circ$  [93]) in the case of a normal neutrino mass ordering, considerably different from their counterparts in the quark sector. Given the fact of  $m_e/m_\mu \sim m_\mu/m_\tau \sim \lambda^2$ , it is naively expected that contributions of the charged-lepton mass ratios to the lepton flavor mixing angles should be insignificant. If the large lepton mixing angles are ascribed to a

weak neutrino mass hierarchy (i.e., the ratios  $m_1/m_2$  and  $m_2/m_3$  are relatively large and even close to one in the normal neutrino mass ordering), then the texture of the neutrino mass matrix should have a weak hierarchy too. A more popular conjecture is that the PMNS matrix  $U$  might be dominated by a constant flavor mixing pattern  $U_0$  and corrected by a small perturbation matrix  $\Delta U$ . Namely,  $U = U_0 + \Delta U$ . In the literature some interesting patterns of  $U_0$ , such as the so-called “democratic” [138, 139] and “tribimaximal” [140, 141, 142] mixing patterns, have been proposed to account for current neutrino oscillation data and build viable neutrino mass models. Although  $U_0$  can be specified by imposing certain flavor symmetries on the charged-lepton and neutrino mass matrices, how to specify the symmetry-breaking part  $\Delta U$  is highly nontrivial. The latter is usually associated with many unknown parameters which are experimentally inaccessible for the time being, and hence they have to be put into a hidden dustbin in most of the present model-building exercises [143, 144, 145, 146]. The variety of such models on the market makes it difficult to judge which flavor symmetry is really true or closer to the truth.

- Whether there exists a kind of correlation between lepton and quark flavor mixing parameters. In a given GUT framework it is in general possible to establish some relations between lepton and quark Yukawa coupling matrices, from which one may partly link the mass and flavor mixing parameters in one sector to those in the other sector. For instance, the so-called quark-lepton complementarity relations  $\theta_{12} + \vartheta_{12} = \pi/4$  and  $\theta_{23} \pm \vartheta_{23} = \pi/4$  have been put into consideration in some literature [147, 148], although they are dependent both on the energy scales and on the parametrization forms of  $U$  and  $V$  [149, 150, 151, 152].

Note again that  $U$  and  $V$  are associated respectively with  $W^-$  and  $W^+$ , as emphasized above. This fact might put a question mark against some attempts to establish a straightforward relationship between  $U$  and  $V$ , such as the aforementioned quark-lepton complementarity relations.

*Category (3): the puzzles associated with CP violation.* CP violation means that matter and antimatter are distinguishable, so are a kind of reaction and its CP-conjugated process. Within the SM the effects of CP violation naturally manifest themselves in weak interactions via a nontrivial complex phase — denoted as the Kobayashi-Maskawa phase  $\delta_q$  — residing in the CKM quark flavor mixing matrix  $V$  [21]. Given the fact that neutrinos are massive and lepton flavors are mixed, CP violation is also expected to show up in the lepton sector. The most natural source of leptonic CP violation should be the nontrivial complex phase(s) of the PMNS matrix  $U$ . Corresponding to the Dirac or Majorana nature of massive neutrinos,  $U$  may contain a single CP-violating phase denoted by  $\delta_\nu$  or three ones denoted as  $\delta_\nu, \rho$  and  $\sigma$ . While  $\delta_\nu$  is sometimes called the Dirac phase,  $\rho$  and  $\sigma$  are often referred to as the Majorana phases because they are closely associated with lepton number violation and have nothing to do with those lepton-number-conserving processes such as neutrino-neutrino and antineutrino-antineutrino oscillations. In cosmology CP violation is one of the crucial ingredients for viable baryogenesis mechanisms to explain the mysterious dominance of matter (baryons) over antimatter (antibaryons) in today’s Universe [70]. Some open issues about CP violation in the weak interactions are in order.

- A failure of the SM to account for the observed baryon-antibaryon asymmetry of the Universe. In spite of  $\delta_q \simeq 71^\circ$  in the standard parametrization of  $V$  [19], strongly hierarchical

quark masses as compared with the electroweak symmetry breaking scale shown in Fig. 2 and very small flavor mixing angles make the *overall* effect of CP violation coming from the SM's quark sector highly suppressed [153]. On the other hand, the mass of the Higgs boson (i.e.,  $M_H \simeq 125$  GeV [19]) is large enough to make a sufficiently strong first-order electroweak phase transition *impossible* to happen within the SM [154, 155, 156, 157]. For these two reasons, one has to go beyond the SM to look for new sources of CP violation and realize the idea of baryogenesis in a different way. One typical example of this kind is baryogenesis via leptogenesis [158] based on the canonical seesaw mechanism, and another one is the Affleck-Dine mechanism with the help of supersymmetry [159].

- The true origin and strengths of leptonic CP violation. It is certainly reasonable to attribute the effects of leptonic CP violation to the nontrivial complex phase(s) of the PMNS matrix  $U$ , but the origin of such phases depends on the mechanism of neutrino mass generation. If a seesaw mechanism is responsible for generating the tiny Majorana neutrino masses of three active neutrinos, for instance, the CP-violating phases of  $U$  are expected to originate from the complex phases associated with those heavy degrees of freedom and the relevant Yukawa interactions via the unique dimension-five Weinberg operator [160] and the corresponding seesaw formula. In this case, however, whether there exists a direct connection between leptonic CP violation at low energies and viable leptogenesis at a superhigh-energy scale is strongly model-dependent [161]. Current neutrino oscillation data have excluded  $\delta_\nu = 0$  and  $\pi$  at the  $2\sigma$  confidence level [88] and provided a preliminary preference for  $\delta_\nu \sim 3\pi/2$  at the  $1\sigma$  confidence level [92, 93], but how to determine or constrain the Majorana phases  $\rho$  and  $\sigma$  remains completely unclear because a convincing phenomenon of lepton number violation has never been observed.
- Whether CP violation in the lepton sector is correlated with that in the quark sector. Such a question is basically equivalent to asking whether there exists some intrinsic correlation between the lepton and quark sectors, so that the two sectors share some flavor properties regarding mass generation, flavor mixing and CP violation. In this connection a robust GUT framework should help, although there is still a long way to go. From a phenomenological point of view, one may certainly conjecture something like  $\delta_q + \delta_\nu = 3\pi/2$  or  $2\pi$  with the help of current experimental data [19, 92, 93]. But this sort of quark-lepton complementarity relation for the CP-violating phases suffers from the same problem as those for the flavor mixing angles, and hence it might not be suggestive at all.

Besides the issues of CP violation in the weak interactions, there is also the problem of *strong* CP violation in the SM — a nontrivial topological term in the Lagrangian of QCD which breaks the original CP symmetry of the Lagrangian and is characterized by the strong-interaction vacuum angle  $\theta$  [94, 95, 162, 163]. This angle, combined with a chiral quark mass phase [164] via the chiral anomaly [165, 166], leads us to an effective angle  $\bar{\theta}$ . With the help of the experimental upper limit on the neutron electric dipole moment [167], the magnitude of  $\bar{\theta}$  is constrained to be smaller than  $10^{-10}$ . Given its period  $2\pi$ , why is the parameter  $\bar{\theta}$  extremely small instead of  $\mathcal{O}(1)$ ? Such a fine-tuning issue constitutes the strong CP problem in particle physics, and the most popular solution to this problem is the Peccei-Quinn theory [168, 169].

All in all, the discovery of the long-expected Higgs boson at the Large Hadron Collider (LHC) in 2012 [44, 45] implies that the Yukawa interactions *do* exist and should be responsible for the mass generation of charged leptons and quarks within the SM. On the other hand, a series of successful neutrino oscillation experiments have helped establish the basic profiles of tiny neutrino masses and significant lepton flavor mixing effects, as outlined above. To deeply understand the origin of flavor mixing and CP violation in both quark and lepton sectors, including the possible Majorana nature of massive neutrinos, it is desirable and important to summarize where we are standing today and where we are going tomorrow. In particular, a comparison between the flavor issues in lepton and quark sectors must be enlightening. The future precision flavor experiments, such as the super-*B* factory [170], an upgrade of the LHCb detector [171] and a variety of neutrino experiments [19], will help complete the flavor phenomenology and even shed light on the underlying flavor theory which is anticipated to be more fundamental and profound than the SM. Such a theory is most likely to take effect at a superhigh-energy scale (e.g., the GUT scale), and thus whether it is experimentally testable depends on whether it can successfully predict a number of quantitative relationships among the low-energy observables.

The present article is intended to review some important progress made in understanding flavor structures and CP violation of charged fermions and massive neutrinos in the past twenty years. We plan to focus on those striking and essentially model-independent ideas, approaches and results regarding the chosen topics, and outline possible ways to proceed at this frontier of particle physics in the next ten years. The remaining parts of this work are organized as follows. In section 2 we go over the standard pictures of fermion mass generation, flavor mixing and weak CP violation in a minimal version of the SM extended with the presence of massive Dirac or Majorana neutrinos. Section 3 provides a brief summary of our current numerical knowledge about the flavor mixing parameters of quarks and leptons, and section 4 is devoted to the descriptions of flavor mixing patterns and CP violation phenomenology. In section 5 the light and heavy sterile neutrinos are introduced, and the effects of their mixing with active neutrinos are described. Sections 6 and 7 are devoted to possible flavor textures and symmetries of charged fermions and massive neutrinos, respectively. In section 8 we summarize the main content of this article, make some concluding remarks and give an outlook to the future developments in this exciting field.

## 2. The standard picture of fermion mass generation

### 2.1. The masses of charged leptons and quarks

#### 2.1.1. The electroweak interactions of fermions

Let us concentrate on the Lagrangian of electroweak interactions in the SM, denoted as  $\mathcal{L}_{\text{EW}}$ , which is based on the  $\text{SU}(2)_L \times \text{U}(1)_Y$  gauge symmetry group and the Higgs mechanism [3, 4]. The latter is crucial to trigger spontaneous symmetry breaking  $\text{SU}(2)_L \times \text{U}(1)_Y \rightarrow \text{U}(1)_{\text{em}}$ , such that three of the four gauge bosons and all the nine charged fermions acquire nonzero masses.

The Lagrangian  $\mathcal{L}_{\text{EW}}$  consists of four parts: (1) the kinetic term of the gauge fields and their self-interactions, denoted as  $\mathcal{L}_{\text{G}}$ ; (2) the kinetic term of the Higgs doublet and its potential and interactions with the gauge fields, denoted as  $\mathcal{L}_{\text{H}}$ ; (3) the kinetic term of the fermion fields and their interactions with the gauge fields, denoted as  $\mathcal{L}_{\text{F}}$ ; (4) the Yukawa interactions between the

Table 3: The main quantum numbers of leptons and quarks associated with the electroweak interactions in the SM, where  $q_i$  and  $q'_i$  (for  $i = 1, 2, 3$ ) represent the *flavor* eigenstates of up- and down-type quarks, respectively;  $l_\alpha$  and  $\nu_\alpha$  (for  $\alpha = e, \mu, \tau$ ) denote the *flavor* eigenstates of charged leptons and neutrinos, respectively. They can therefore be distinguished from the corresponding *mass* eigenstates (namely,  $u, c, t$  for up-type quarks;  $d, s, b$  for down-type quarks;  $e, \mu, \tau$  for charged leptons; and  $\nu_1, \nu_2, \nu_3$  for neutrinos) in an unambiguous way. In addition,  $Q = I_3 + Y$  holds.

Fermion doublets or singlets	Weak isospin $I_3$	Hypercharge $Y$	Electric charge $Q$
$Q_{iL} \equiv \begin{pmatrix} q_i \\ q'_i \end{pmatrix}_L$ (for $i = 1, 2, 3$ )	$\begin{pmatrix} +1/2 \\ -1/2 \end{pmatrix}$	+1/6	$\begin{pmatrix} +2/3 \\ -1/3 \end{pmatrix}$
$\ell_{\alpha L} \equiv \begin{pmatrix} \nu_\alpha \\ l_\alpha \end{pmatrix}_L$ (for $\alpha = e, \mu, \tau$ )	$\begin{pmatrix} +1/2 \\ -1/2 \end{pmatrix}$	-1/2	$\begin{pmatrix} 0 \\ -1 \end{pmatrix}$
$U_{iR} \equiv (q_i)_R$ (for $i = 1, 2, 3$ )	0	+2/3	+2/3
$D_{iR} \equiv (q'_i)_R$ (for $i = 1, 2, 3$ )	0	-1/3	-1/3
$E_{\alpha R} \equiv (l_\alpha)_R$ (for $\alpha = e, \mu, \tau$ )	0	-1	-1

fermion fields and the Higgs doublet, denoted as  $\mathcal{L}_Y$ . To be explicit [172],

$$\begin{aligned}
-\mathcal{L}_G &= \frac{1}{4} (W^{i\mu\nu} W_{\mu\nu}^i + B^{\mu\nu} B_{\mu\nu}), \\
\mathcal{L}_H &= (D^\mu H)^\dagger (D_\mu H) - \mu^2 H^\dagger H - \lambda (H^\dagger H)^2, \\
\mathcal{L}_F &= \overline{Q}_L i \not{D} Q_L + \overline{\ell}_L i \not{D} \ell_L + \overline{U}_R i \not{\partial}' U_R + \overline{D}_R i \not{\partial}' D_R + \overline{E}_R i \not{\partial}' E_R, \\
-\mathcal{L}_Y &= \overline{Q}_L Y_u \widetilde{H} U_R + \overline{Q}_L Y_d H D_R + \overline{\ell}_L Y_l H E_R + \text{h.c.},
\end{aligned} \tag{3}$$

in which  $W_{\mu\nu}^i \equiv \partial_\mu W_\nu^i - \partial_\nu W_\mu^i + g \varepsilon^{ijk} W_\mu^j W_\nu^k$  with  $W_\mu^i$  (for  $i = 1, 2, 3$ ),  $g$  and  $\varepsilon^{ijk}$  being the  $SU(2)_L$  gauge fields, the corresponding coupling constant and the three-dimensional Levi-Civita symbol, respectively;  $B_{\mu\nu} \equiv \partial_\mu B_\nu - \partial_\nu B_\mu$  with  $B_\mu$  being the  $U(1)_Y$  gauge field;  $H \equiv (\phi^+, \phi^0)^T$  denotes the Higgs doublet which has a hypercharge  $Y(H) = +1/2$  and contains two scalar fields  $\phi^+$  and  $\phi^0$ ;  $\widetilde{H}$  is defined as  $\widetilde{H} \equiv i\sigma_2 H^*$  with  $\sigma_2$  being the second Pauli matrix;  $Q_L$  and  $\ell_L$  stand respectively for the  $SU(2)_L$  doublets of left-handed quark and charged-lepton fields;  $U_R$ ,  $D_R$  and  $E_R$  stand respectively for the  $SU(2)_L$  singlets of right-handed up-type quark, down-type quark and charged-lepton fields;  $Y_u$ ,  $Y_d$  and  $Y_l$  are the corresponding Yukawa coupling matrices. In Table 3 we summarize the main quantum numbers of leptons and quarks associated with the electroweak interactions in the SM. Note that a sum of all the three families in the flavor space is automatically implied in  $\mathcal{L}_F$  and  $\mathcal{L}_Y$ . Moreover, in  $\mathcal{L}_F$  we have defined  $\not{D} \equiv D_\mu \gamma^\mu$  and  $\not{\partial}' \equiv \partial'_\mu \gamma^\mu$  with  $D_\mu \equiv \partial_\mu - ig\tau^i W_\mu^i - ig'YB_\mu$  and  $\partial'_\mu \equiv \partial_\mu - ig'YB_\mu$  being the gauge covariant derivatives, in which  $\tau_i \equiv \sigma_i/2$  (for  $i = 1, 2, 3$ ) and  $Y$  stand respectively for the generators of gauge groups  $SU(2)_L$  and  $U(1)_Y$  with  $g$  and  $g'$  being the respective gauge coupling constants. Note also that  $\mu^2 < 0$  and  $\lambda > 0$  are required in  $\mathcal{L}_H$  so as to obtain a nontrivial vacuum expectation value of the Higgs field (i.e.,  $v = \sqrt{-\mu^2/\lambda}$ ) by minimizing the corresponding scalar potential  $V(H) = \mu^2 H^\dagger H + \lambda (H^\dagger H)^2$ .



By fixing the vacuum of this theory at  $\langle H \rangle \equiv \langle 0|H|0 \rangle = (0, v/\sqrt{2})^T$ , spontaneous gauge symmetry breaking (i.e.,  $SU(2)_L \times U(1)_Y \rightarrow U(1)_{\text{em}}$ ) will happen for  $\mathcal{L}_{\text{EW}} = \mathcal{L}_G + \mathcal{L}_H + \mathcal{L}_F + \mathcal{L}_Y$ . The physical gauge boson fields turn out to be  $W_\mu^\pm = (W_\mu^1 \mp iW_\mu^2)/\sqrt{2}$ ,  $Z_\mu = \cos\theta_w W_\mu^3 - \sin\theta_w B_\mu$  and  $A_\mu = \sin\theta_w W_\mu^3 + \cos\theta_w B_\mu$ , where  $\theta_w = \arctan(g'/g)$  is the weak mixing angle. As a result, the tree-level masses of the Higgs boson  $H^0$ , the charged weak bosons  $W^\pm$  and the neutral weak boson  $Z^0$  are given by  $M_H = \sqrt{2}\lambda v$ ,  $M_W = gv/2$  and  $M_Z = \sqrt{g^2 + g'^2}v/2$ , respectively. Note that the photon  $\gamma$  remains massless because the electromagnetic gauge symmetry  $U(1)_{\text{em}}$  is unbroken. Once an effective four-fermion interaction with the Fermi coupling constant  $G_F$  (e.g., the elastic scattering process  $e^- + \nu_e \rightarrow e^- + \nu_e$  via the weak charged-current interaction mediated by  $W^-$ ) is taken into account at low energies, one may easily establish the correspondence relation  $G_F/\sqrt{2} = g^2/(8M_W^2)$ . Given  $M_W \simeq 80.4$  GeV and  $G_F \simeq 1.166 \times 10^{-5}$  GeV $^{-2}$  [19], for example, we obtain  $v = (\sqrt{2}G_F)^{-1/2} \simeq 246$  GeV and  $g \simeq 0.65$ . The latter value means that the intrinsic coupling of weak interactions is actually not small, and the fact that weak interactions are really feeble at low energies is mainly because their mediators  $W^\pm$  and  $Z^0$  are considerably massive [173].

After spontaneous electroweak symmetry breaking, the term  $\mathcal{L}_F$  in Eq. (3) allows one to fix the weak charged- and neutral-current interactions of both leptons and quarks. Namely,

$$\mathcal{L}_{\text{cc}} = \frac{g}{\sqrt{2}} \left[ \sum_i \bar{q}_{iL} \gamma^\mu q'_{iL} W_\mu^+ + \sum_\alpha \bar{l}_{\alpha L} \gamma^\mu \nu_{\alpha L} W_\mu^- \right] + \text{h.c.}, \quad (4a)$$

$$\begin{aligned} \mathcal{L}_{\text{nc}} = \frac{g}{2 \cos\theta_w} & \left[ \sum_i \left\{ \bar{q}_i \gamma^\mu (\zeta_V^u - \zeta_A^u \gamma_5) q_i + \bar{q}'_i \gamma^\mu (\zeta_V^d - \zeta_A^d \gamma_5) q'_i \right\} Z_\mu \right. \\ & \left. + \sum_\alpha \left\{ \bar{l}_\alpha \gamma^\mu (\zeta_V^l - \zeta_A^l \gamma_5) l_\alpha + \bar{\nu}_{\alpha L} \gamma^\mu \nu_{\alpha L} \right\} Z_\mu \right], \quad (4b) \end{aligned}$$

in which the subscripts  $i$  and  $\alpha$  run over  $(1, 2, 3)$  and  $(e, \mu, \tau)$ , respectively;  $\zeta_V^u = 1/2 - 4 \sin^2 \theta_w/3$ ,  $\zeta_V^d = -1/2 + 2 \sin^2 \theta_w/3$  and  $\zeta_V^l = -1/2 + 2 \sin^2 \theta_w$  with  $\sin^2 \theta_w \simeq 0.231$  at the energy scales around  $M_Z$  [19], and  $\zeta_A^u = -\zeta_A^d = -\zeta_A^l = 1/2$ . Since the three neutrinos are exactly left-handed and massless in the SM, they are quite lonely. In other words, these Weyl particles only interact with  $W^\pm$  and  $Z^0$ , as described in the above two equations.

### 2.1.2. Yukawa interactions and quark flavor mixing

Now we focus on the Yukawa-interaction term  $\mathcal{L}_Y$  in Eq. (3). It leads us to the charged-lepton and quark mass terms after spontaneous gauge symmetry breaking:

$$-\mathcal{L}_{\text{mass}} = \sum_i \sum_j \left[ \bar{q}_{iL} (M_u)_{ij} q_{jR} + \bar{q}'_{iL} (M_d)_{ij} q'_{jR} \right] + \sum_\alpha \sum_\beta \bar{l}_{\alpha L} (M_l)_{\alpha\beta} l_{\beta R} + \text{h.c.}, \quad (5)$$

where the Latin and Greek subscripts run respectively over  $(1, 2, 3)$  and  $(e, \mu, \tau)$ , and the three mass matrices are given by  $M_u = Y_u v/\sqrt{2}$ ,  $M_d = Y_d v/\sqrt{2}$  and  $M_l = Y_l v/\sqrt{2}$  with  $v \simeq 246$  GeV being the vacuum expectation value of the Higgs field. The structures of these mass matrices are not predicted by the SM, and hence they should be treated as three arbitrary  $3 \times 3$  matrices. At least two things can be done in this regard.

- The polar decomposition theorem in mathematics makes it always possible to transform  $M_u$  into a (positive definite) Hermitian mass matrix  $H_u$  multiplied by a unitary matrix  $R_u$  on its right-hand side,  $M_u = H_u R_u$ . Similarly, one has  $M_d = H_d R_d$  and  $M_l = H_l R_l$  with  $H_{d,l}$  being Hermitian (and positive definite) and  $R_{d,l}$  being unitary. Such transformations are equivalent to choosing a new set of right-handed quark and charged-lepton fields (i.e.,  $q_R \rightarrow R_u q_R$ ,  $q'_R \rightarrow R_d q'_R$  and  $l_R \rightarrow R_l l_R$ ), but they do not alter the rest of the Lagrangian  $\mathcal{L}_{EW}$  in which there are no flavor-changing right-handed currents [174].
- The three mass matrices in Eq. (5) can be diagonalized by the bi-unitary transformations

$$\begin{aligned}
O_u^\dagger M_u O'_u &= D_u \equiv \text{Diag}\{m_u, m_c, m_t\}, \\
O_d^\dagger M_d O'_d &= D_d \equiv \text{Diag}\{m_d, m_s, m_b\}, \\
O_l^\dagger M_l O'_l &= D_l \equiv \text{Diag}\{m_e, m_\mu, m_\tau\},
\end{aligned} \tag{6}$$

which are equivalent to transforming the flavor eigenstates of quarks and charged leptons to their mass eigenstates. Namely,

$$\begin{pmatrix} q_1 \\ q_2 \\ q_3 \end{pmatrix}_L = O_u \begin{pmatrix} u \\ c \\ t \end{pmatrix}_L, \quad \begin{pmatrix} q'_1 \\ q'_2 \\ q'_3 \end{pmatrix}_L = O_d \begin{pmatrix} d \\ s \\ b \end{pmatrix}_L, \quad \begin{pmatrix} l_e \\ l_\mu \\ l_\tau \end{pmatrix}_L = O_l \begin{pmatrix} e \\ \mu \\ \tau \end{pmatrix}_L, \tag{7}$$

and three similar transformations hold for the right-handed fields. Note that all the kinetic terms of the charged-fermion fields in Eq. (3) keep invariant under the above transformations, simply because  $O_u^{(\prime)}$ ,  $O_d^{(\prime)}$  and  $O_l^{(\prime)}$  are all unitary. Substituting Eq. (7) into Eqs. (4a) and (4b), we find that the neutral-current interactions described by  $\mathcal{L}_{nc}$  keep flavor-diagonal, but a family mismatch appears in the quark sector of  $\mathcal{L}_{cc}$ . The latter leads us to the famous CKM quark flavor mixing matrix  $V = O_u^\dagger O_d$  as shown in Eq. (1) in the basis of quark mass eigenstates. A pseudo-mismatch may also appear in the lepton sector of  $\mathcal{L}_{cc}$ , but it can always be absorbed by a redefinition of the left-handed fields of three massless neutrinos in the SM. Only when the neutrinos have finite and nondegenerate masses, the PMNS lepton flavor mixing matrix  $U = O_l^\dagger O_\nu$  can really show up in the weak charged-current interactions in the basis of lepton mass eigenstates.

Now that the CKM matrix  $V = O_u^\dagger O_d$  depends on both  $M_u$  and  $M_d$  through  $O_u$  and  $O_d$ , it will not be calculable unless the flavor structures of these two mass matrices are known. Unfortunately, the SM itself makes no prediction for the textures of  $M_u$  and  $M_d$ , but it *does* predict  $V$  to be exactly unitary — a very good news for the phenomenology of quark flavor mixing and CP violation.

Eq. (6) tells us that the texture of a fermion mass matrix is hard to be fully reconstructed from the corresponding mass and flavor mixing parameters, since it always involves some *unphysical* degrees of freedom associated with the right-handed fermion fields. In the quark sector, for instance,  $M_u = O_u D_u O_u^{\prime\dagger}$  and  $M_d = O_d D_d O_d^{\prime\dagger}$  inevitably involve the contributions from unphysical  $O'_u$  and  $O'_d$ . For this reason it is sometimes more convenient to diagonalize Hermitian  $M_f M_f^\dagger$  instead of arbitrary  $M_f$  (for  $f = u, d, l, \nu$ ) from a phenomenological point of view [137]. That is,

$$O_f^\dagger M_f M_f^\dagger O_f = D_f^2 \equiv \text{Diag}\{\lambda_1, \lambda_2, \lambda_3\}, \tag{8}$$

where  $\lambda_i$  (for  $i = 1, 2, 3$ ) denote the real and positive eigenvalues of  $M_f M_f^\dagger$ , and the unitary matrices related with the right-handed fields do not appear anymore <sup>7</sup>. The characteristic equation of  $M_f M_f^\dagger$  (i.e.,  $\det[M_f M_f^\dagger - \lambda I] = 0$  with  $I$  being the  $3 \times 3$  identity matrix) can be expressed as

$$\lambda^3 - \text{tr}[M_f M_f^\dagger] \lambda^2 + \frac{(\text{tr}[M_f M_f^\dagger])^2 - \text{tr}[M_f M_f^\dagger]^2}{2} \lambda - \det[M_f M_f^\dagger] = 0, \quad (9)$$

and its roots are just  $\lambda_1, \lambda_2$  and  $\lambda_3$ . The latter are related to the three matrix invariants as follows:  $a \equiv \det[M_f M_f^\dagger] = \lambda_1 \lambda_2 \lambda_3$ ,  $b \equiv \text{tr}[M_f M_f^\dagger] = \lambda_1 + \lambda_2 + \lambda_3$  and  $c \equiv \text{tr}[M_f M_f^\dagger]^2 = \lambda_1^2 + \lambda_2^2 + \lambda_3^2$ . As a result, we obtain

$$\begin{aligned} \lambda_1 &= \frac{1}{3}x_0 - \frac{1}{3}\sqrt{x_0^2 - 3y_0} \left[ z_0 + \sqrt{3(1 - z_0^2)} \right], \\ \lambda_2 &= \frac{1}{3}x_0 - \frac{1}{3}\sqrt{x_0^2 - 3y_0} \left[ z_0 - \sqrt{3(1 - z_0^2)} \right], \\ \lambda_3 &= \frac{1}{3}x_0 + \frac{2}{3}z_0 \sqrt{x_0^2 - 3y_0}, \end{aligned} \quad (10)$$

where  $x_0 \equiv b$ ,  $y_0 \equiv (b^2 - c)/2$  and

$$z_0 \equiv \cos \left[ \frac{1}{3} \arccos \frac{2x_0^3 - 9x_0 y_0 + 27a}{2\sqrt{(x_0^2 - 3y_0)^3}} \right]. \quad (11)$$

These generic formulas are useful for studying some specific textures of fermion mass matrices, and they can also find applications in calculating the effective neutrino masses both in matter [177] and in the renormalization-group evolution from one energy scale to another [178].

## 2.2. Dirac and Majorana neutrino mass terms

### 2.2.1. Dirac neutrinos and lepton flavor violation

A simple extension of the SM is to introduce three right-handed neutrino fields  $N_{\alpha R}$  with vanishing weak isospin and hypercharge (i.e.,  $I_3 = Y = 0$ ) <sup>8</sup>, corresponding to the existing left-handed neutrino fields  $\nu_{\alpha L}$  (for  $\alpha = e, \mu, \tau$ ). In terms of the left- and right-handed column vectors  $\nu_L$  and  $N_R$  with  $\nu_{\alpha L}$  and  $N_{\alpha R}$  being their respective components, a new kinetic term of the form  $\overline{N}_R i \not{\partial} N_R$  should be added to  $\mathcal{L}_F$  in Eq. (3), and a new Yukawa interaction term of the form

$$-\mathcal{L}_{\text{Dirac}} = \overline{\ell}_L Y_\nu \widetilde{H} N_R + \text{h.c.} \quad (12)$$

<sup>7</sup>If the three neutrinos are massive and have the Majorana nature, the corresponding mass matrix  $M_\nu$  is symmetric and thus can be diagonalized by a transformation  $O_\nu^\dagger M_\nu O_\nu^* = D_\nu \equiv \text{Diag}\{m_1, m_2, m_3\}$  with  $O_\nu$  being unitary [175, 176].

<sup>8</sup>In this connection one might prefer to use  $\nu_{\alpha R}$  to denote the right-handed neutrino fields. While this notation is fine for the case of *pure* Dirac neutrinos, it will be somewhat ambiguous (and even misleading) when discussing the hybrid neutrino mass terms and the seesaw mechanism in section 2.2.3. That is why we choose to use the notation  $N_{\alpha R}$  for the right-handed neutrino fields throughout this article.

should be added to  $\mathcal{L}_Y$  in Eq. (3). Then spontaneous electroweak symmetry breaking leads us to the Dirac neutrino mass term

$$-\mathcal{L}'_{\text{Dirac}} = \bar{\nu}_L M_D N_R + \text{h.c.} , \quad (13)$$

where  $M_D = Y_\nu v / \sqrt{2}$ . This Dirac mass matrix can be diagonalized by a bi-unitary transformation  $O_\nu^\dagger M_D O'_\nu = D_\nu \equiv \text{Diag}\{m_1, m_2, m_3\}$  with  $m_i$  being the neutrino masses (for  $i = 1, 2, 3$ ), which is equivalent to transforming the flavor eigenstates of left- and right-handed neutrino fields to their mass eigenstates in the following way:

$$\begin{pmatrix} \nu_e \\ \nu_\mu \\ \nu_\tau \end{pmatrix}_L = O_\nu \begin{pmatrix} \nu_1 \\ \nu_2 \\ \nu_3 \end{pmatrix}_L , \quad \begin{pmatrix} N_e \\ N_\mu \\ N_\tau \end{pmatrix}_R = O'_\nu \begin{pmatrix} \nu_1 \\ \nu_2 \\ \nu_3 \end{pmatrix}_R . \quad (14)$$

Needless to say, each  $\nu_i$  with mass  $m_i$  is a four-component Dirac spinor which satisfies the Dirac equation. Eq. (14) allows us to use the mass eigenstates of three Dirac neutrinos to rewrite their kinetic terms  $\bar{\nu}_L i \not{\partial} \nu_L + \bar{N}_R i \not{\partial} N_R$  and the weak interactions  $\mathcal{L}_{\text{cc}}$  and  $\mathcal{L}_{\text{nc}}$  in Eqs. (4a) and (4b). It is straightforward to check that  $\mathcal{L}_{\text{nc}}$  is always flavor-diagonal, but a nontrivial family mismatch occurs in the lepton sector of  $\mathcal{L}_{\text{cc}}$ . Combining the transformations made in Eqs. (7) and (14), we arrive at the PMNS lepton flavor mixing matrix  $U = O'_\nu O_\nu$ , as shown in Eq. (1) in the basis of lepton mass eigenstates. So  $U \neq I$  measures the violation of lepton flavors.

In many cases it is more convenient to work in the basis where the flavor eigenstates of three charged leptons are identical with their mass eigenstates (i.e.,  $M_l = D_l$  is not only diagonal but also real and positive, and thus  $O_l = I$  holds). This flavor basis is especially useful for the study of neutrino oscillations, for the reason that each neutrino flavor is identified with the associated charged lepton in either its production or detection. In this case the mass and flavor eigenstates of three neutrinos are related with each other via the PMNS matrix  $U = O_\nu$ , as follows:

$$\begin{pmatrix} \nu_e \\ \nu_\mu \\ \nu_\tau \end{pmatrix}_L = \begin{pmatrix} U_{e1} & U_{e2} & U_{e3} \\ U_{\mu1} & U_{\mu2} & U_{\mu3} \\ U_{\tau1} & U_{\tau2} & U_{\tau3} \end{pmatrix} \begin{pmatrix} \nu_1 \\ \nu_2 \\ \nu_3 \end{pmatrix}_L . \quad (15)$$

The unitarity of  $U$  is guaranteed if massive neutrinos have the Dirac nature. But the pure Dirac neutrino mass term in Eq. (12), together with  $\mathcal{L}_Y$  in Eq. (3), puts the mass generation of all the elementary fermions in the SM on the same footing. This treatment is too simple to explain why there exists a puzzling flavor ‘‘desert’’ in the fermion mass spectrum as illustrated by Fig. 2, if the origin of neutrino masses is theoretically the same as that of charged fermions.

If a global phase transformation is made for charged-lepton and neutrino fields (i.e.,  $l_{\alpha L}(x) \rightarrow e^{i\Phi} l_{\alpha L}(x)$ ,  $l_{\alpha R}(x) \rightarrow e^{i\Phi} l_{\alpha R}(x)$ ,  $\nu_{\alpha L}(x) \rightarrow e^{i\Phi} \nu_{\alpha L}(x)$  and  $N_{\alpha R}(x) \rightarrow e^{i\Phi} N_{\alpha R}(x)$ , where  $\Phi$  is an arbitrary spacetime- and family-independent phase parameter), it will be easy to find that the leptonic kinetic terms and Eqs. (4a), (4b), (5) and (13) are all invariant up to non-perturbative anomalies [94, 95]. This invariance is just equivalent to lepton number conservation. That is why in the perturbative regime one is allowed to define lepton number  $L = +1$  for charged leptons and Dirac neutrinos (i.e.,  $e, \mu, \tau$  and  $\nu_e, \nu_\mu, \nu_\tau$ ), and lepton number  $L = -1$  for their antiparticles. Hence normal neutrino-neutrino and antineutrino-antineutrino oscillations are lepton-number-conserving.

### 2.2.2. Majorana neutrinos and lepton number violation

In principle, a neutrino mass term can be constructed by using the left-handed fields  $\nu_{\alpha L}$  of the SM and their charge-conjugate counterparts  $(\nu_{\alpha L})^c \equiv C\bar{\nu}_{\alpha L}^T$  (for  $\alpha = e, \mu, \tau$ ), in which the charge-conjugation matrix  $C$  satisfies  $C\gamma_\mu^T C^{-1} = -\gamma_\mu$ ,  $C\gamma_5^T C^{-1} = \gamma_5$  and  $C^{-1} = C^\dagger = C^T = -C$  [172]<sup>9</sup>. Such a Majorana neutrino mass term is possible because the neutrino fields  $(\nu_{\alpha L})^c = (\nu_\alpha^c)_R$  are actually right-handed [180]. To be explicit<sup>10</sup>,

$$-\mathcal{L}'_{\text{Majorana}} = \frac{1}{2}\bar{\nu}_L M_\nu (\nu_L)^c + \text{h.c.}, \quad (16)$$

in comparison with the Dirac mass term in Eq. (12). Note that Eq. (16) is not invariant under a global phase transformation  $\nu_{\alpha L}(x) \rightarrow e^{i\Phi}\nu_{\alpha L}(x)$  with  $\Phi$  being an arbitrary spacetime- and family-independent phase, and hence lepton number is not a good quantum number in this connection. That is why Eq. (16) has been referred to as the Majorana neutrino mass term. Such a mass term is apparently forbidden by the  $SU(2)_L \times U(1)_Y$  gauge symmetry in the SM, but it can naturally stem from the dimension-five Weinberg operator [160] in the seesaw mechanisms [181].

Note also that the Majorana neutrino mass matrix  $M_\nu$  must be symmetric. To prove this point, one may take account of the fact that the mass term in Eq. (16) is a Lorentz scalar and hence its transpose keeps unchanged. As a result,  $\bar{\nu}_L M_\nu (\nu_L)^c = [\bar{\nu}_L M_\nu (\nu_L)^c]^T = -\bar{\nu}_L C^T M_\nu^T \bar{\nu}_L^T = \bar{\nu}_L M_\nu^T (\nu_L)^c$  holds. We are therefore left with  $M_\nu^T = M_\nu$ . This symmetric mass matrix can be diagonalized by a transformation  $O_\nu^\dagger M_\nu O_\nu^* = D_\nu$  with  $O_\nu$  being unitary. Consequently,

$$\begin{pmatrix} \nu_e \\ \nu_\mu \\ \nu_\tau \end{pmatrix}_L = O_\nu \begin{pmatrix} \nu_1 \\ \nu_2 \\ \nu_3 \end{pmatrix}_L, \quad \begin{pmatrix} \nu_e^c \\ \nu_\mu^c \\ \nu_\tau^c \end{pmatrix}_R = O_\nu^* \begin{pmatrix} \nu_1^c \\ \nu_2^c \\ \nu_3^c \end{pmatrix}_R, \quad (17)$$

from which one can easily verify

$$\begin{pmatrix} \nu_1 \\ \nu_2 \\ \nu_3 \end{pmatrix} = O_\nu^\dagger \begin{pmatrix} \nu_e \\ \nu_\mu \\ \nu_\tau \end{pmatrix}_L + O_\nu^T \begin{pmatrix} \nu_e^c \\ \nu_\mu^c \\ \nu_\tau^c \end{pmatrix}_R = \left\{ O_\nu^T \begin{pmatrix} \nu_e^c \\ \nu_\mu^c \\ \nu_\tau^c \end{pmatrix}_R + O_\nu^\dagger \begin{pmatrix} \nu_e \\ \nu_\mu \\ \nu_\tau \end{pmatrix}_L \right\}^c = \begin{pmatrix} \nu_1^c \\ \nu_2^c \\ \nu_3^c \end{pmatrix}. \quad (18)$$

Now that the Majorana condition  $\nu_i^c = \nu_i$  holds (for  $i = 1, 2, 3$ ) [71], the three neutrinos must be the Majorana fermions — they are their own antiparticles in the basis of the mass eigenstates. In the basis where the charged-lepton mass matrix  $M_l$  is diagonal, real and positive, the PMNS matrix  $U = O_\nu$  describes the effects of neutrino flavor mixing as shown in Eq. (15). So the Majorana neutrinos lead us to both lepton number violation and lepton flavor violation.

The Majorana nature of massive neutrinos implies that they can mediate the rare neutrinoless double-beta ( $0\nu 2\beta$ ) decays of some nuclei,  $(A, Z) \rightarrow (A, Z+2) + 2e^-$ , where the atomic mass number  $A$  and the atomic number  $Z$  are both even [72]. Due to the mysterious nuclear pairing force, such

<sup>9</sup>One may obtain these conditions for  $C$  in the basis of neutrino mass eigenstates by requiring  $(\nu_i)^c \equiv C\bar{\nu}_i^T$  to satisfy the same Dirac equation as  $\nu_i$  (for  $i = 1, 2, 3$ ) do [179].

<sup>10</sup>Because of electric charge conservation, it is impossible for charged leptons or quarks to have a similar Majorana mass term. So the Majorana nature is unique to massive neutrinos among all the fundamental fermions.

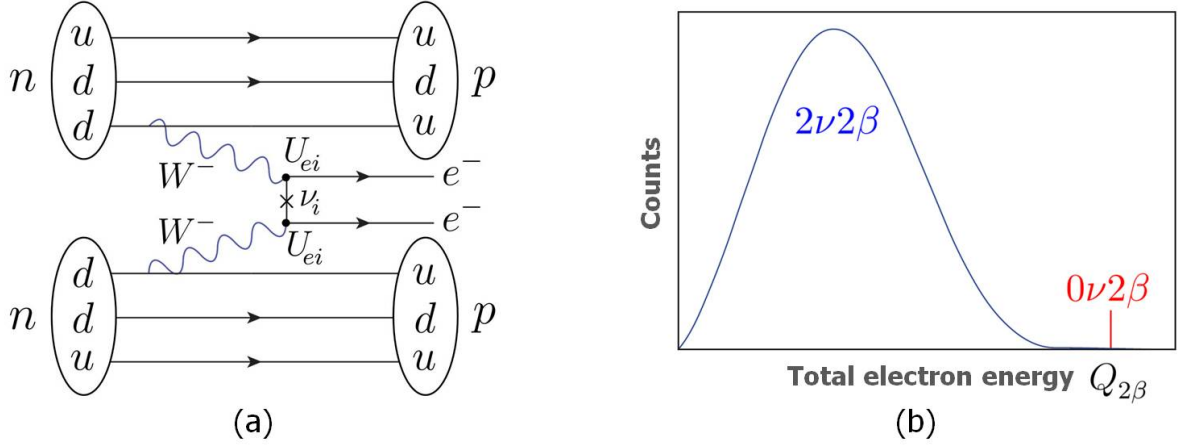

Figure 4: (a) A Feynman diagram of the lepton-number-violating  $0\nu 2\beta$  decay  $(A, Z) \rightarrow (A, Z + 2) + 2e^-$ , which is equivalent to the simultaneous decays of two neutrons into two protons and two electrons mediated by the light Majorana neutrinos  $\nu_i$  (for  $i = 1, 2, 3$ ); (b) a schematic illustration of the energy spectra of  $2\nu 2\beta$  and  $0\nu 2\beta$  decays, in which  $Q_{2\beta}$  is the energy released (i.e., the  $Q$ -value).

an even-even nucleus  $(A, Z)$  is lighter than its nearest neighbor  $(A, Z + 1)$  but heavier than its second nearest neighbor  $(A, Z + 2)$ . So the single-beta ( $\beta$ ) decay  $(A, Z) \rightarrow (A, Z + 1) + e^- + \bar{\nu}_e$  is kinematically forbidden but the double-beta ( $2\nu 2\beta$ ) decay  $(A, Z) \rightarrow (A, Z + 2) + 2e^- + 2\bar{\nu}_e$  may take place [182], and the latter is equivalent to two simultaneous  $\beta$  decays of two neutrons residing in the nucleus  $(A, Z)$ . Then the  $0\nu 2\beta$  transition is likely to happen, as illustrated in Fig. 4, provided the neutrinos in the final state are their own antiparticles and can therefore be interchanged. The decay rate of this  $0\nu 2\beta$  process is usually expressed as  $\Gamma_{0\nu 2\beta} = G_{0\nu 2\beta} |M_{0\nu 2\beta}|^2 |\langle m \rangle_{ee}|^2$ , where  $G_{0\nu 2\beta} \propto Q_{2\beta}^5$  stands for the two-body phase-space factor of  $\mathcal{O}(10^{-25}) \text{ yr}^{-1} \text{ eV}^{-2}$  [183],  $M_{0\nu 2\beta}$  is the relevant nuclear matrix element, and

$$\langle m \rangle_{ee} = m_1 U_{e1}^2 + m_2 U_{e2}^2 + m_3 U_{e3}^2 \quad (19)$$

denotes the effective Majorana mass of the electron neutrino. In Eq. (19) the neutrino mass  $m_i$  comes from the helicity suppression factor  $m_i/E$  for the exchange of a virtual Majorana neutrino  $\nu_i$  between two ordinary  $\beta$  decay modes, where  $E$  represents the corresponding energy transfer. Given the parametrization of the  $3 \times 3$  PMNS matrix  $U$  in Eq. (2), one may always arrange the phase parameters of  $P_\nu$  such that  $|\langle m \rangle_{ee}|$  only contains two irreducible Majorana phases.

In practice an experimental search of the rare  $0\nu 2\beta$  decay depends not only on the magnitude of  $\langle m \rangle_{ee}$  but also on a proper choice of the isotopes. There are three important criteria for choosing the even-even nuclei suitable for the  $0\nu 2\beta$  measurement: (a) a high  $Q_{2\beta}$  value to make the  $0\nu 2\beta$ -decay signal as far away from the  $2\nu 2\beta$ -decay background as possible; (b) a high isotopic abundance to allow the detector to have a sufficiently large mass; and (c) the compatibility with a suitable detection technique and the detector's mass scalability [184]. Historically, the first  $2\nu 2\beta$  decay mode observed in the laboratory was  $^{82}\text{Se} \rightarrow ^{82}\text{Kr} + 2e^- + 2\bar{\nu}_e$  [185]; but today one is paying more attention to the  $0\nu 2\beta$  decays  $^{76}\text{Ge} \rightarrow ^{76}\text{Se} + 2e^-$ ,  $^{136}\text{Xe} \rightarrow ^{136}\text{Ba} + 2e^-$ ,  $^{130}\text{Te} \rightarrow ^{130}\text{Xe} + 2e^-$ , and so on

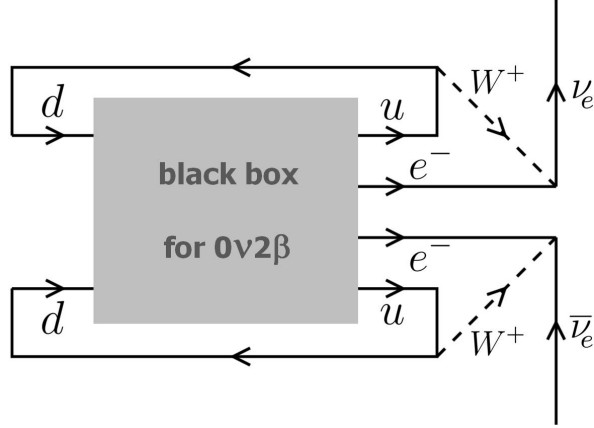

Figure 5: The lepton-number-violating  $\bar{\nu}_e \rightarrow \nu_e$  conversion induced by a “black box” [190] which is responsible for the quark-level  $dd \rightarrow uue^-e^-$  transition and the  $0\nu 2\beta$  decay.

[186]. In particular, the GERDA [187], EXO [188] and KamLAND-Zen [189] Collaborations have set an upper bound on the effective Majorana neutrino mass  $|\langle m \rangle_{ee}| < 0.06 - 0.2$  eV at the 90% confidence level [93], where the uncertainty comes mainly from the uncertainties in calculating the relevant nuclear matrix elements.

Note that a  $0\nu 2\beta$  decay mode can always induce the lepton-number-violating  $\bar{\nu}_e \rightarrow \nu_e$  transition as shown in Fig. 5, which corresponds to an effective electron-neutrino mass term at the four-loop level, no matter whether the decay itself is mediated by the light Majorana neutrino  $\nu_i$  (for  $i = 1, 2, 3$ ) or by other possible new particles or interactions in the “black box”. This observation, known as the Schechter-Valle theorem [190], warrants the statement that a measurement of the  $0\nu 2\beta$  decay will definitely verify the Majorana nature of massive neutrinos. In fact, it has been shown that there is no continuous or discrete symmetry which can naturally protect a vanishing Majorana neutrino mass and thus the nonexistence of  $0\nu 2\beta$  transitions to all orders in a perturbation theory [191, 192]. So the Majorana nature of massive neutrinos is expected to be a sufficient and necessary condition for the existence of  $0\nu 2\beta$  decays [186]. An explicit calculation of the short-range-“black-box”-operator-induced Majorana neutrino mass in Fig. 5 yields a result of  $\mathcal{O}(10^{-28})$  eV [193, 194], which is too small to have any quantitative impact.

While an observable  $0\nu 2\beta$  decay is most likely to be mediated by the three known light Majorana neutrinos, it is also possible that such a lepton-number-violating process takes place via a kind of new particle or interaction hidden in the “black box” in Fig. 5. Typical examples of this kind include the hypothetical heavy (seesaw-motivated) Majorana neutrinos, light (anomaly-motivated) sterile neutrinos, Higgs triplets, Majorons or new particles in some supersymmetric or left-right symmetric theories [195, 196].

### 2.2.3. The canonical seesaw mechanism and others

Extending the SM by introducing three right-handed neutrino fields  $N_{\alpha R}$  (for  $\alpha = e, \mu, \tau$ ) and their charge-conjugate counterparts  $(N_{\alpha R})^c$ , whose weak isospin and hypercharge are both zero, one may not only write out a Dirac mass term like that in Eq. (13) but also a Majorana mass term

analogous to that in Eq. (16). Namely,

$$\begin{aligned}
-\mathcal{L}'_{\text{hybrid}} &= \overline{\nu_L} M_D N_R + \frac{1}{2} \overline{(N_R)^c} M_R N_R + \text{h.c.} \\
&= \frac{1}{2} \overline{\begin{bmatrix} \nu_L & (N_R)^c \end{bmatrix}} \begin{pmatrix} 0 & M_D \\ M_D^T & M_R \end{pmatrix} \begin{bmatrix} (\nu_L)^c \\ N_R \end{bmatrix} + \text{h.c.} ,
\end{aligned} \tag{20}$$

where  $M_R$  is symmetric, and the relation  $\overline{(N_R)^c} M_D^T (\nu_L)^c = \overline{\nu_L} M_D N_R$  has been used. Note that the second term in Eq. (20) is allowed by the  $\text{SU}(2)_L \times \text{U}(1)_Y$  gauge symmetry, but it violates the lepton number conservation. The  $6 \times 6$  mass matrix in Eq. (20) is apparently symmetric, and thus it can be diagonalized by a  $6 \times 6$  unitary matrix in the following way:

$$\begin{pmatrix} O & R \\ S & Q \end{pmatrix}^\dagger \begin{pmatrix} 0 & M_D \\ M_D^T & M_R \end{pmatrix} \begin{pmatrix} O & R \\ S & Q \end{pmatrix}^* = \begin{pmatrix} D_\nu & 0 \\ 0 & D_N \end{pmatrix} , \tag{21}$$

where  $D_\nu \equiv \text{Diag}\{m_1, m_2, m_3\}$ ,  $D_N \equiv \text{Diag}\{M_1, M_2, M_3\}$ , and the  $3 \times 3$  submatrices  $O$ ,  $R$ ,  $S$  and  $Q$  satisfy the unitarity conditions

$$\begin{aligned}
OO^\dagger + RR^\dagger &= SS^\dagger + QQ^\dagger = I , \\
O^\dagger O + S^\dagger S &= R^\dagger R + Q^\dagger Q = I , \\
OS^\dagger + RQ^\dagger &= O^\dagger R + S^\dagger Q = 0 .
\end{aligned} \tag{22}$$

Then the six neutrino flavor eigenstates can be expressed in terms of the corresponding neutrino mass eigenstates as follows:

$$\begin{pmatrix} \nu_e \\ \nu_\mu \\ \nu_\tau \end{pmatrix}_L = O \begin{pmatrix} \nu_1 \\ \nu_2 \\ \nu_3 \end{pmatrix}_L + R \begin{pmatrix} N_1^c \\ N_2^c \\ N_3^c \end{pmatrix}_L , \quad \begin{pmatrix} N_e \\ N_\mu \\ N_\tau \end{pmatrix}_R = S^* \begin{pmatrix} \nu_1^c \\ \nu_2^c \\ \nu_3^c \end{pmatrix}_R + Q^* \begin{pmatrix} N_1 \\ N_2 \\ N_3 \end{pmatrix}_R . \tag{23}$$

It is straightforward to check that the Majorana conditions  $\nu_i^c = \nu_i$  and  $N_i^c = N_i$  (for  $i = 1, 2, 3$ ) hold, and thus the six neutrinos are all the Majorana particles.

In the basis where the flavor eigenstates of three charged leptons are identical with their mass eigenstates, one may substitute the expression of  $\nu_{\alpha L}$  in Eq. (23) into the Lagrangian of the standard weak charged-current interactions in Eq. (4a). As a result,

$$\mathcal{L}_{\text{cc}} = \frac{g}{\sqrt{2}} \overline{(e \ \mu \ \tau)_L} \gamma^\mu \left[ U \begin{pmatrix} \nu_1 \\ \nu_2 \\ \nu_3 \end{pmatrix}_L + R \begin{pmatrix} N_1 \\ N_2 \\ N_3 \end{pmatrix}_L \right] W_\mu^- + \text{h.c.} , \tag{24}$$

where  $U = O$  is just the PMNS flavor mixing matrix in the chosen basis. It becomes transparent that  $U$  and  $R$  are responsible for the charged-current interactions of three known neutrinos  $\nu_i$  and three new neutrinos  $N_i$  (for  $i = 1, 2, 3$ ), respectively. These two  $3 \times 3$  matrices are correlated with each other via  $UU^\dagger + RR^\dagger = I$ , and hence  $U$  is not exactly unitary unless  $R$  vanishes (i.e., unless  $\nu_i$  and  $N_i$  are completely decoupled). Taking account of both Fig. 4 and Eq. (24), we find that the  $0\nu 2\beta$  decay  $(A, Z) \rightarrow (A, Z + 2) + 2e^-$  can now be mediated by the exchanges of both  $\nu_i$



and  $N_i$  between two  $\beta$  decay modes, whose coupling matrix elements are  $U_{ei}$  and  $R_{ei}$  respectively. Which contribution is more important depends on the details of a realistic neutrino mass model of this kind and the corresponding nuclear matrix elements [197, 198], and this issue will be briefly discussed in section 5.2.3.

Note that the hybrid neutrino mass terms in Eq. (20) allow us to naturally explain why the three known neutrinos have tiny masses. The essential point is that the mass scale of  $M_R$  can be far above that of  $M_D$  which is characterized by the vacuum expectation value of the Higgs field due to  $M_D = Y_\nu v / \sqrt{2}$ , simply because the right-handed neutrino fields are the  $SU(2)_L \times U(1)_Y$  singlets and thus have nothing to do with electroweak symmetry breaking. In this case one may follow the effective field theory approach to integrate out the heavy degrees of freedom and then obtain an effective Majorana mass term for the three light neutrinos as described by Eq. (16) [172], in which the neutrino mass matrix  $M_\nu$  is given by the well-known seesaw formula [111, 112, 113, 114, 115]

$$M_\nu \simeq -M_D M_R^{-1} M_D^T \quad (25)$$

in the leading-order approximation. Here let us derive this result directly from Eq. (21) by taking into account  $m_i \ll M_i$  or equivalently  $R \sim S \sim \mathcal{O}(M_D/M_R)$ , which are expected to be extremely small in magnitude. Therefore, Eq. (21) leads us to

$$\begin{aligned} M_D &= OD_\nu S^T + RD_N Q^T \simeq RD_N Q^T, \\ M_R &= SD_\nu S^T + QD_N Q^T \simeq QD_N Q^T, \end{aligned} \quad (26)$$

together with the *exact* seesaw relation between light and heavy neutrinos:

$$OD_\nu O^T + RD_N R^T = 0. \quad (27)$$

The effective light Majorana neutrino mass matrix turns out to be of the form given in Eq. (25):

$$M_\nu \equiv OD_\nu O^T = -RD_N R^T = -RD_N Q^T (QD_N Q^T)^{-1} QD_N R^T \simeq -M_D M_R^{-1} M_D^T, \quad (28)$$

where the approximations made in Eq. (26) have been used. Such a seesaw formula, which holds up to the accuracy of  $\mathcal{O}(M_D^2/M_R^2)$  [199, 200], is qualitatively attractive since it naturally attributes the smallness of the mass scale of  $M_\nu$  to the largeness of the mass scale of  $M_R$  as compared with the fulcrum of this seesaw — the mass scale of  $M_D$ . Inversely, Eq. (25) can be expressed as

$$M_R \simeq -M_D^T M_\nu^{-1} M_D. \quad (29)$$

That is why studying the origin of neutrino masses at low energies may open a striking window to explore new physics at very high energy scales. For instance, the lepton-number-violating and CP-violating decays of heavy Majorana neutrinos  $N_i$  might result in a net lepton-antilepton asymmetry in the early Universe, and the latter could subsequently be converted to a net baryon-antibaryon asymmetry via the sphaleron-induced  $(B+L)$ -violating process [154]. Such an elegant baryogenesis-via-leptogenesis mechanism [158] is certainly a big bonus of the seesaw mechanism, and it will be briefly introduced in section 2.3.2.

Besides the aforementioned seesaw scenario, which is usually referred to as the canonical or Type-I seesaw mechanism, there are two other typical seesaw scenarios which also ascribe the tiny masses of three known neutrinos to the existence of heavy degrees of freedom and lepton number violation [181]. It is therefore meaningful to summarize all of them and make a comparison.

- Type-I seesaw. The SM is extended by introducing three right-handed neutrino fields  $N_{\alpha R}$  (for  $\alpha = e, \mu, \tau$ ) with a sufficiently high mass scale and allowing for lepton number violation [111, 112, 113, 114, 115]. The  $SU(2)_L \times U(1)_Y$  gauge-invariant Yukawa-interaction and mass terms in the lepton sector are written as

$$-\mathcal{L}_{\text{lepton}} = \bar{\ell}_L Y_l H E_R + \bar{\ell}_L Y_\nu \tilde{H} N_R + \frac{1}{2} \overline{(N_R)^c} M_R N_R + \text{h.c.} . \quad (30)$$

Integrating out the heavy degrees of freedom [172], one is left with an effective dimension-five Weinberg operator for the light neutrinos:

$$\frac{\mathcal{L}_{\text{d=5}}}{\Lambda_{\text{SS}}} = \frac{1}{2} \bar{\ell}_L \tilde{H} Y_\nu M_R^{-1} Y_\nu^T \tilde{H}^T (\ell_L)^c + \text{h.c.} , \quad (31)$$

in which  $\Lambda_{\text{SS}}$  denotes the seesaw (cut-off) scale. After spontaneous electroweak symmetry breaking, Eq. (31) leads us to the effective Majorana neutrino mass term in Eq. (16) and the approximate seesaw relation in Eq. (25) with  $M_D = Y_\nu v / \sqrt{2}$ .

- Type-II seesaw. An  $SU(2)_L$  Higgs triplet  $\Delta$  with a sufficiently high mass scale  $M_\Delta$  is added into the SM and lepton number is violated by interactions of this triplet with both the lepton doublet and the Higgs doublet [201, 202, 203, 204, 205, 206]:

$$-\mathcal{L}_{\text{lepton}} = \bar{\ell}_L Y_l H E_R + \frac{1}{2} \bar{\ell}_L Y_\Delta \Delta i \sigma_2 (\ell_L)^c - \lambda_\Delta M_\Delta H^T i \sigma_2 \Delta H + \text{h.c.} , \quad (32)$$

where  $Y_\Delta$  and  $\lambda_\Delta$  stand for the Yukawa coupling matrix and the scalar coupling coefficient, respectively. Integrating out the heavy degrees of freedom, we obtain

$$\frac{\mathcal{L}_{\text{d=5}}}{\Lambda_{\text{SS}}} = -\frac{\lambda_\Delta}{M_\Delta} \bar{\ell}_L \tilde{H} Y_\Delta \tilde{H}^T (\ell_L)^c + \text{h.c.} , \quad (33)$$

from which Eq. (16) and the seesaw formula  $M_\nu = \lambda_\Delta Y_\Delta v^2 / M_\Delta$  for the Majorana neutrino mass matrix can be derived after spontaneous gauge symmetry breaking.

- Type-III seesaw. Three  $SU(2)_L$  fermion triplets  $\Sigma_\alpha$  (for  $\alpha = e, \mu, \tau$ ) with a sufficiently high mass scale are added into the SM and lepton number is violated by the relevant Majorana mass term [207, 208]:

$$-\mathcal{L}_{\text{lepton}} = \bar{\ell}_L Y_l H E_R + \bar{\ell}_L \sqrt{2} Y_\Sigma \tilde{H} \Sigma^c + \frac{1}{2} \text{Tr} (\bar{\Sigma} M_\Sigma \Sigma^c) + \text{h.c.} , \quad (34)$$

where  $Y_\Sigma$  and  $M_\Sigma$  stand respectively for the Yukawa coupling matrix and the heavy Majorana mass matrix. Integrating out the heavy degrees of freedom, we are left with

$$\frac{\mathcal{L}_{\text{d=5}}}{\Lambda_{\text{SS}}} = \frac{1}{2} \bar{\ell}_L \tilde{H} Y_\Sigma M_\Sigma^{-1} Y_\Sigma^T \tilde{H}^T (\ell_L)^c + \text{h.c.} , \quad (35)$$

from which the effective light Majorana neutrino mass term in Eq. (16) and the corresponding seesaw formula  $M_\nu \simeq -M_D M_\Sigma^{-1} M_D^T$  with  $M_D = Y_\Sigma v / \sqrt{2}$  can be figured out after spontaneous electroweak symmetry breaking.

In all these three cases, the small mass scale of  $M_\nu$  is attributed to the heavy mass scale of those new degrees of freedom. Note that only in the Type-II seesaw scenario the light neutrinos do not mix with the heavy degrees of freedom, and thus the transformation used to diagonalize  $M_\nu$  is exactly unitary. In the Type-I or Type-III seesaw scenario, however, the mixing between light and heavy degrees of freedom will generally give rise to unitarity violation of the  $3 \times 3$  PMNS matrix  $U$ , as shown in Eq. (24). But fortunately current electroweak precision measurements and neutrino oscillation data have constrained  $U$  to be unitary at the  $O(10^{-2})$  level [122, 123, 124].

In the literature there are some variations and extensions of the above seesaw scenarios, including the so-called *inverse* seesaw [209, 210], *multiple* seesaw [211, 212] and *cascade* seesaw [213] mechanisms which are intended to lower the mass scales of heavy degrees of freedom in order to soften the seesaw-induced hierarchy problem [214, 215, 216] and enhance their experimental testability. Of course, the energy scale of a given seesaw mechanism should not be too low; otherwise, it would unavoidably cause the problem of unnaturalness in model building [181, 217].

At this point it is worth mentioning that there actually exists an interesting alternative to the popular seesaw approach for generating tiny masses of the neutrinos at the tree level. As remarked by Weinberg in 1972, “in theories with spontaneously broken gauge symmetries, various masses or mass differences may vanish in zeroth order as a consequence of the representation content of the fields appearing in the Lagrangian. These masses or mass differences can then be calculated as finite higher-order effects” [218]. Such an approach allows one to go beyond the SM and *radiatively* generate tiny (typically Majorana) neutrino masses at the loop level. The first example of this kind is the well-known Zee model [219],

$$-\mathcal{L}_{\text{lepton}} = \bar{\ell}_L Y_l H E_R + \bar{\ell}_L Y_S S^- i\sigma_2 \ell_L^c + \tilde{\Phi}^T F S^+ i\sigma_2 \tilde{H} + \text{h.c.} , \quad (36)$$

where  $S^\pm$  denote the charged  $SU(2)_L$  scalar singlets,  $\Phi$  stands for a new  $SU(2)_L$  scalar doublet with the same quantum number as the SM Higgs doublet  $H$ ,  $Y_S$  is an antisymmetric matrix, and  $F$  is a mass parameter. After spontaneous gauge symmetry breaking, one is left with  $M_l = Y_l v / \sqrt{2}$  and  $M_\nu = 0$  at the tree level. Nonzero Majorana neutrino masses can be radiatively generated via the one-loop correction, which is equivalent to a dimension-seven Weinberg-like operator. Taking the  $M_l = D_l$  basis and assuming  $M_S \gg M_H \sim M_\Phi \sim F$  and  $\langle \Phi \rangle \sim \langle H \rangle$ , one may make an estimate

$$(M_\nu)_{\alpha\beta} \sim \frac{M_H}{16\pi^2} \cdot \frac{m_\alpha^2 - m_\beta^2}{M_S^2} (Y_S)_{\alpha\beta} , \quad (37)$$

where the subscripts  $\alpha$  and  $\beta$  run over  $e, \mu$  and  $\tau$ . The smallness of  $M_\nu$  is therefore attributed to the smallness of  $Y_S$  and especially the largeness of  $M_S$ . Although the original version of the Zee model has been ruled out by current neutrino oscillation data, its extensions or variations at one or more loops can survive and thus have stimulated the enthusiasm of many researchers in this direction (see Ref. [220] for a recent and comprehensive review).

### 2.3. A diagnosis of the origin of CP violation

#### 2.3.1. The Kobayashi-Maskawa mechanism

Let us consider a minimal extension of the SM into which three right-handed neutrino fields are introduced. In this case one only needs to add two extra terms to the Lagrangian of electroweak

Table 4: The properties of gauge fields and their combinations under C, P and CP transformations, where  $\mathbf{x} \rightarrow -\mathbf{x}$  is automatically implied for the relevant fields under P and CP.

	$B_\mu$	$W_\mu^1$	$W_\mu^2$	$W_\mu^3$	$X_\mu^\pm$	$Y_\mu^\pm$	$B_{\mu\nu}$	$W_{\mu\nu}^1$	$W_{\mu\nu}^2$	$W_{\mu\nu}^3$
C	$-B_\mu$	$-W_\mu^1$	$W_\mu^2$	$-W_\mu^3$	$-X_\mu^\mp$	$-Y_\mu^\pm$	$-B_{\mu\nu}$	$-W_{\mu\nu}^1$	$W_{\mu\nu}^2$	$-W_{\mu\nu}^3$
P	$B^\mu$	$W^{1\mu}$	$W^{2\mu}$	$W^{3\mu}$	$X^{\pm\mu}$	$Y^{\pm\mu}$	$B^{\mu\nu}$	$W^{1\mu\nu}$	$W^{2\mu\nu}$	$W^{3\mu\nu}$
CP	$-B^\mu$	$-W^{1\mu}$	$W^{2\mu}$	$-W^{3\mu}$	$-X^{\mp\mu}$	$-Y^{\pm\mu}$	$-B^{\mu\nu}$	$-W^{1\mu\nu}$	$W^{2\mu\nu}$	$-W^{3\mu\nu}$

Table 5: The properties of scalar fields and fermion-fermion currents under C, P and CP transformations, in which  $\mathbf{x} \rightarrow -\mathbf{x}$  is automatically implied for the relevant fields under P and CP.

	$\phi^\pm$	$\phi^0$	$\partial_\mu\phi^\pm$	$\partial_\mu\phi^0$	$\bar{\psi}_1(1 \pm \gamma_5)\psi_2$	$\bar{\psi}_1\gamma_\mu(1 \pm \gamma_5)\psi_2$	$\bar{\psi}_1\gamma_\mu(1 \pm \gamma_5)\partial^\mu\psi_2$
C	$\phi^\mp$	$\phi^{0*}$	$\partial_\mu\phi^\mp$	$\partial_\mu\phi^{0*}$	$\bar{\psi}_2(1 \pm \gamma_5)\psi_1$	$-\bar{\psi}_2\gamma_\mu(1 \mp \gamma_5)\psi_1$	$\bar{\psi}_2\gamma_\mu(1 \mp \gamma_5)\partial^\mu\psi_1$
P	$\phi^\pm$	$\phi^0$	$\partial^\mu\phi^\pm$	$\partial^\mu\phi^0$	$\bar{\psi}_1(1 \mp \gamma_5)\psi_2$	$\bar{\psi}_1\gamma^\mu(1 \mp \gamma_5)\psi_2$	$\bar{\psi}_1\gamma^\mu(1 \mp \gamma_5)\partial_\mu\psi_2$
CP	$\phi^\mp$	$\phi^{0*}$	$\partial^\mu\phi^\mp$	$\partial^\mu\phi^{0*}$	$\bar{\psi}_2(1 \mp \gamma_5)\psi_1$	$-\bar{\psi}_2\gamma^\mu(1 \pm \gamma_5)\psi_1$	$\bar{\psi}_2\gamma^\mu(1 \pm \gamma_5)\partial_\mu\psi_1$

interactions in Eq. (3): one is the kinetic term of the right-handed neutrinos, and the other is the Yukawa-interaction term of all the neutrinos. Namely,

$$\mathcal{L}_F \rightarrow \mathcal{L}'_F = \mathcal{L}_F + \bar{N}_R i \not{\partial} N_R, \quad -\mathcal{L}_Y \rightarrow -\mathcal{L}'_Y = -\mathcal{L}_Y + \bar{\ell}_L Y_\nu \tilde{H} N_R. \quad (38)$$

Our strategy of diagnosing the origin of weak CP violation is essentially the same as Kobayashi and Maksawa did in 1973 [21]: the first step is to make proper definitions of CP transformations for all the relevant gauge, Higgs and fermion fields, and the second step is to examine whether  $\mathcal{L}_G$ ,  $\mathcal{L}_H$ ,  $\mathcal{L}'_F$  and  $\mathcal{L}'_Y$  are formally invariant under CP transformations. The term which does not respect CP invariance is just the source of CP violation. Note that one may make the diagnosis of CP violation either before or after spontaneous electroweak symmetry breaking, because the latter has nothing to do with CP transformations in the SM and its minimal extensions. In the following we do the job before the Higgs field acquires its vacuum expectation value.

(1) The properties of gauge fields  $B_\mu$  and  $W_\mu^i$  (for  $i = 1, 2, 3$ ) under C, P and CP transformations are listed in Table 4 [172, 221, 222], from which one may easily figure out how the combinations  $X_\mu^\pm \equiv gW_\mu^\pm / \sqrt{2} = g(W_\mu^1 \mp iW_\mu^2)/2$  and  $Y_\mu^\pm \equiv \pm g'YB_\mu + gW_\mu^3/2$  transform under C, P and CP, and how the gauge field tensors  $B_{\mu\nu}$  and  $W_{\mu\nu}^i$  transform under C, P and CP. Then it is straightforward to verify that  $\mathcal{L}_G$  in Eq. (3) is formally CP-invariant.

(2) The properties of scalar fields  $\phi^\pm$  and  $\phi^0$  under C, P and CP transformations are listed in Table 5, implying that the Higgs doublet transforms under CP as follows:

$$H(t, \mathbf{x}) = \begin{pmatrix} \phi^+ \\ \phi^0 \end{pmatrix} \xrightarrow{\text{CP}} H^*(t, -\mathbf{x}) = \begin{pmatrix} \phi^- \\ \phi^{0*} \end{pmatrix}. \quad (39)$$

As a result, the  $H^\dagger H$  and  $(H^\dagger H)^2$  terms of  $\mathcal{L}_H$  in Eq. (3) are trivially CP-invariant. To see how the  $(D^\mu H)^\dagger(D_\mu H)$  term of  $\mathcal{L}_H$  transforms under CP, let us explicitly write out

$$D_\mu H = \left( \partial_\mu - ig\tau^k W_\mu^k - ig' Y B_\mu \right) H = \begin{pmatrix} \partial_\mu \phi^+ - iX_\mu^+ \phi^0 - iY_\mu^+ \phi^+ \\ \partial_\mu \phi^0 - iX_\mu^- \phi^+ + iY_\mu^- \phi^0 \end{pmatrix}, \quad (40)$$

where  $X_\mu^\pm$  and  $Y_\mu^\pm$  have been defined above and their transformations under CP have been shown in Table 4. With the help of Tables 4 and 5, it is very easy to show that the term

$$\begin{aligned} (D^\mu H)^\dagger (D_\mu H) &= \partial^\mu \phi^- \partial_\mu \phi^+ - i\partial^\mu \phi^- X_\mu^+ \phi^0 - i\partial^\mu \phi^- Y_\mu^+ \phi^+ + iX^{-\mu} \phi^{0*} \partial_\mu \phi^+ + X^{-\mu} X_\mu^+ |\phi^0|^2 \\ &\quad + X^{-\mu} \phi^{0*} Y_\mu^+ \phi^+ + iY^{+\mu} \phi^- \partial_\mu \phi^+ + Y^{+\mu} X_\mu^+ \phi^- \phi^0 + Y^{+\mu} Y_\mu^+ |\phi^+|^2 + \partial^\mu \phi^{0*} \partial_\mu \phi^0 \\ &\quad - i\partial^\mu \phi^{0*} X_\mu^- \phi^+ + i\partial^\mu \phi^{0*} Y_\mu^- \phi^0 + iX^{+\mu} \phi^- \partial_\mu \phi^0 + X^{+\mu} X_\mu^- |\phi^+|^2 - X^{+\mu} \phi^- Y_\mu^- \phi^0 \\ &\quad - iY^{-\mu} \phi^{0*} \partial_\mu \phi^0 - Y^{-\mu} X_\mu^- \phi^{0*} \phi^+ + Y^{-\mu} Y_\mu^- |\phi^0|^2 \end{aligned} \quad (41)$$

is also CP-invariant. Therefore,  $\mathcal{L}_H$  in Eq. (3) proves to be formally invariant under CP.

(3) The properties of some typical spinor bilinears of fermion fields under C, P and CP transformations are listed in Table 5 [172]<sup>11</sup>. To examine how the six terms of  $\mathcal{L}'_F$  are sensitive to CP transformations, let us express them in a more transparent way:

$$\begin{aligned} \mathcal{L}'_F &= \left[ \bar{\ell}_L i \not{D} \ell_L + \bar{E}_R i \not{\partial}' E_R + \bar{N}_R i \not{\partial} N_R \right] + \left[ \bar{Q}_L i \not{D} Q_L + \bar{U}_R i \not{\partial}' U_R + \bar{D}_R i \not{\partial} D_R \right] \\ &= \sum_\alpha \left[ \overline{(v_\alpha \ l_\alpha)}_L \gamma^\mu \left( i\partial_\mu + g\tau^k W_\mu^k - \frac{1}{2} g' B_\mu \right) \begin{pmatrix} v_\alpha \\ l_\alpha \end{pmatrix}_L + \bar{l}_{\alpha R} \gamma^\mu (i\partial_\mu - g' B_\mu) l_{\alpha R} + \bar{N}_{\alpha R} i \gamma^\mu \partial_\mu N_{\alpha R} \right] \\ &\quad + \sum_i \left[ \overline{(q_i \ q'_i)}_L \gamma^\mu \left( i\partial_\mu + g\tau^k W_\mu^k + \frac{1}{6} g' B_\mu \right) \begin{pmatrix} q_i \\ q'_i \end{pmatrix}_L \right. \\ &\quad \left. + \bar{q}_{iR} \gamma^\mu \left( i\partial_\mu + \frac{2}{3} g' B_\mu \right) q_{iR} + \bar{q}'_{iR} \gamma^\mu \left( i\partial_\mu - \frac{1}{3} g' B_\mu \right) q'_{iR} \right] \\ &= \sum_\alpha \left[ \bar{l}_\alpha \gamma^\mu P_L X_\mu^- v_\alpha + \bar{v}_\alpha \gamma^\mu P_L X_\mu^+ l_\alpha + \bar{v}_\alpha \gamma^\mu P_L (i\partial_\mu + Y_\mu^-) v_\alpha + \bar{l}_\alpha \gamma^\mu P_L (i\partial_\mu - Y_\mu^+) l_\alpha \right. \\ &\quad \left. + \bar{N}_\alpha \gamma^\mu P_R i\partial_\mu N_\alpha + \bar{l}_\alpha \gamma^\mu P_R (i\partial_\mu - g' B_\mu) l_\alpha \right] \\ &\quad + \sum_i \left[ \bar{q}'_i \gamma^\mu P_L X_\mu^- q_i + \bar{q}_i \gamma^\mu P_L X_\mu^+ q'_i + \bar{q}_i \gamma^\mu P_L (i\partial_\mu + Y_\mu^+) q_i + \bar{q}'_i \gamma^\mu P_L (i\partial_\mu - Y_\mu^-) q'_i \right. \\ &\quad \left. + \bar{q}_{iR} \gamma^\mu P_R \left( i\partial_\mu + \frac{2}{3} g' B_\mu \right) q_{iR} + \bar{q}'_{iR} \gamma^\mu P_R \left( i\partial_\mu - \frac{1}{3} g' B_\mu \right) q'_{iR} \right], \end{aligned} \quad (42)$$

in which  $q_i$  and  $q'_i$  (for  $i = 1, 2, 3$ ) stand respectively for the up- and down-type quark fields,  $P_L \equiv (1 - \gamma_5)/2$  and  $P_R \equiv (1 + \gamma_5)/2$  serve as the chiral projection operators, while  $X_\mu^\pm$  and  $Y_\mu^\pm$

<sup>11</sup>In the Dirac-Pauli representation a free Dirac spinor  $\psi(t, \mathbf{x})$  transforms under C, P and T as  $\psi(t, \mathbf{x}) \xrightarrow{C} C \bar{\psi}^T(t, \mathbf{x})$ ,  $\psi(t, \mathbf{x}) \xrightarrow{P} \mathcal{P} \psi(t, -\mathbf{x})$  and  $\psi(t, \mathbf{x}) \xrightarrow{T} \mathcal{T} \psi(-t, \mathbf{x})$  with  $C = i\gamma_2 \gamma_0$ ,  $\mathcal{P} = \gamma_0$  and  $\mathcal{T} = \gamma_1 \gamma_3$ . The spinor bilinears of lepton and quark fields can then be derived, and those associated with the electroweak interactions are given in Table 5.

have been defined above. Taking account of the relevant CP transformations listed in Tables 4 and 5, we immediately find that  $\mathcal{L}'_F$  is formally CP-invariant.

(4) Now it becomes clear that only the Yukawa interactions are likely to be the origin of CP violation. To see whether  $\mathcal{L}'_Y$  is sensitive to CP transformations of the scalar and fermion fields, we write out its explicit expression as follows:

$$\begin{aligned}
-\mathcal{L}'_Y &= \bar{\ell}_L Y_l H E_R + \bar{\ell}_L Y_\nu \tilde{H} N_R + \bar{Q}_L Y_u \tilde{H} U_R + \bar{Q}_L Y_d H D_R + \text{h.c.} \\
&= \sum_\alpha \sum_\beta \left[ (Y_l)_{\alpha\beta} \overline{(v_\alpha \ l_\alpha)_L} \begin{pmatrix} \phi^+ \\ \phi^0 \end{pmatrix} l_{\beta R} + (Y_\nu)_{\alpha\beta} \overline{(v_\alpha \ l_\alpha)_L} \begin{pmatrix} \phi^{0*} \\ -\phi^- \end{pmatrix} N_{\beta R} + \text{h.c.} \right] \\
&\quad + \sum_i \sum_j \left[ (Y_u)_{ij} \overline{(q_i \ q'_i)_L} \begin{pmatrix} \phi^{0*} \\ -\phi^- \end{pmatrix} q_{jR} + (Y_d)_{ij} \overline{(q_i \ q'_i)_L} \begin{pmatrix} \phi^+ \\ \phi^0 \end{pmatrix} q'_{jR} + \text{h.c.} \right] \\
&= \sum_\alpha \sum_\beta \left[ (Y_l)_{\alpha\beta} (\bar{v}_\alpha P_R l_\beta \phi^+ + \bar{l}_\alpha P_R l_\beta \phi^0) + (Y_\nu)_{\alpha\beta} (\bar{v}_\alpha P_R \nu_\beta \phi^{0*} - \bar{l}_\alpha P_R \nu_\beta \phi^-) + \text{h.c.} \right] \\
&\quad + \sum_i \sum_j \left[ (Y_u)_{ij} (\bar{q}_i P_R q_j \phi^{0*} - \bar{q}'_i P_R q_j \phi^-) + (Y_d)_{ij} (\bar{q}_i P_R q'_j \phi^+ + \bar{q}'_i P_R q'_j \phi^0) + \text{h.c.} \right], \quad (43)
\end{aligned}$$

where the Latin subscripts  $i$  and  $j$  run over (1, 2, 3) for quark fields, and the Greek subscripts  $\alpha$  and  $\beta$  run over ( $e, \mu, \tau$ ) for lepton fields. Given the CP transformations listed in Table 5, we find

$$\begin{aligned}
-\mathcal{L}'_Y \xrightarrow{\text{CP}} &\sum_\alpha \sum_\beta \left[ (Y_l)^*_{\alpha\beta} (\bar{v}_\alpha P_R l_\beta \phi^+ + \bar{l}_\alpha P_R l_\beta \phi^0) + (Y_\nu)^*_{\alpha\beta} (\bar{v}_\alpha P_R \nu_\beta \phi^{0*} - \bar{l}_\alpha P_R \nu_\beta \phi^-) + \text{h.c.} \right] \\
&+ \sum_i \sum_j \left[ (Y_u)^*_{ij} (\bar{q}_i P_R q_j \phi^{0*} - \bar{q}'_i P_R q_j \phi^-) + (Y_d)^*_{ij} (\bar{q}_i P_R q'_j \phi^+ + \bar{q}'_i P_R q'_j \phi^0) + \text{h.c.} \right], \quad (44)
\end{aligned}$$

in which  $\mathbf{x} \rightarrow -\mathbf{x}$  is implied for the fields under consideration. A comparison between Eqs. (43) and (44) indicates that  $\mathcal{L}'_Y$  is not formally invariant under CP unless the conditions

$$Y_u^* = Y_u, \quad Y_d^* = Y_d, \quad Y_l^* = Y_l, \quad Y_\nu^* = Y_\nu \quad (45)$$

are satisfied. In other words, the Yukawa coupling matrices  $Y_u, Y_d, Y_l$  and  $Y_\nu$  must all be real to assure  $\mathcal{L}'_Y$  to be CP-invariant. Since these coupling matrices are not constrained by the SM itself or by its simple extensions, they should in general be complex and can therefore accommodate CP violation. Although some trivial phases of  $Y_f$  (for  $f = u, d, l, \nu$ ) can always be rotated away by redefining the phases of the relevant right-handed fields, it is impossible to make both  $Y_u$  and  $Y_d$  real if there are three families of quarks [21]. The same conclusion can be drawn for three families of charged leptons and Dirac neutrinos.

Of course, one may simply diagonalize  $Y_u, Y_d, Y_l$  and  $Y_\nu$  to eliminate all the phase information associated with the Yukawa interactions. In this case a kind of mismatch will appear in the weak charged-current interactions, as described by the CKM quark flavor mixing matrix  $V$  and the PMNS lepton flavor mixing matrix  $U$  in Eq. (1). The irreducible phases of  $U$  and  $V$  are just the sources of weak CP violation. One can therefore conclude that weak CP violation arises naturally from the very fact that the fields of three-family fermions interact with both gauge and scalar fields in the SM or its straightforward extensions.

Note that we have assumed massive neutrinos to be the Dirac particles in the above diagnosis of CP violation. At low energies an effective Majorana neutrino mass term of the form shown in Eq. (16) is more popular from a theoretical point of view, because it can naturally stem from the seesaw mechanisms. To examine how this term transforms under CP, let us reexpress it as follows:

$$-\mathcal{L}'_{\text{Majorana}} = \frac{1}{2} \sum_{\alpha} \sum_{\beta} \left[ (M_{\nu})_{\alpha\beta} \bar{\nu}_{\alpha} P_{\text{R}} (\nu_{\beta})^c + (M_{\nu})_{\alpha\beta}^* \overline{(\nu_{\alpha})^c} P_{\text{L}} \nu_{\beta} \right], \quad (46)$$

where the subscripts  $\alpha$  and  $\beta$  run over  $(e, \mu, \tau)$ , and the symmetry of  $M_{\nu}$  has been taken into account. The C transformations of a neutrino field  $\nu_{\alpha}$  and its charge-conjugate counterpart  $(\nu_{\alpha})^c$  are simply  $\nu_{\alpha} \rightarrow (\nu_{\alpha})^c$  and  $(\nu_{\alpha})^c \rightarrow \nu_{\alpha}$ ; and their P transformations are  $\nu_{\alpha} \rightarrow \gamma_0 \nu_{\alpha}$  and  $(\nu_{\alpha})^c \rightarrow \gamma_0 (\nu_{\alpha})^c$  in the Dirac-Pauli representation [172], where  $\mathbf{x} \rightarrow -\mathbf{x}$  is implied. As a result,

$$-\mathcal{L}'_{\text{Majorana}} \xrightarrow{\text{CP}} \frac{1}{2} \sum_{\alpha} \sum_{\beta} \left[ (M_{\nu})_{\alpha\beta} \overline{(\nu_{\alpha})^c} P_{\text{L}} \nu_{\beta} + (M_{\nu})_{\alpha\beta}^* \bar{\nu}_{\alpha} P_{\text{R}} (\nu_{\beta})^c \right]. \quad (47)$$

So CP invariance for this effective Majorana neutrino mass term requires  $M_{\nu}^* = M_{\nu}$ . As discussed in section 2.2.2, the nontrivial phases of  $M_{\nu}$  may lead to CP violation in the weak charged-current interactions and affect some lepton-number-violating processes (e.g., the  $0\nu 2\beta$  decays).

### 2.3.2. Baryogenesis via thermal leptogenesis

In particle physics every kind of particle has a corresponding antiparticle, and the CPT theorem dictates them to have the same mass and lifetime but the opposite charges. Given this particle-antiparticle symmetry, the standard Big Bang cosmology predicts that the Universe should have equal amounts of matter and antimatter. However, all the available data point to the fact that the observable Universe is predominantly composed of baryons rather than antibaryons (i.e.,  $n_{\bar{\text{B}}} = 0$  holds today for the number density of antibaryons). The latest Planck measurements of the cosmic microwave background (CMB) anisotropies yield the baryon density  $\Omega_{\text{b}} h^2 = 0.0224 \pm 0.0001$  at the 68% confidence level [105]. It can be translated into the baryon-to-photon ratio

$$\eta \equiv \frac{n_{\text{B}}}{n_{\gamma}} \simeq 273 \times 10^{-10} \Omega_{\text{b}} h^2 \simeq (6.12 \pm 0.03) \times 10^{-10}, \quad (48)$$

which exactly lies in the narrow range of  $5.8 \times 10^{-10} < \eta < 6.6 \times 10^{-10}$  determined from recent measurements of the primordial abundances of the light element isotopes based on the Big Bang nucleosynthesis (BBN) theory [19]. Given the fact that the moment for the BBN to happen ( $t \gtrsim 1$  s) is so different from the time for the CMB to form ( $t \sim 3.8 \times 10^5$  yr), such a good agreement between the values of  $\eta$  extracted from these two epochs is especially amazing.

It is therefore puzzling how the Universe has evolved from  $n_{\text{B}} = n_{\bar{\text{B}}} \neq 0$  in the very beginning to  $n_{\text{B}}/n_{\gamma} \sim 6 \times 10^{-10}$  and  $n_{\bar{\text{B}}} = 0$  today. To illustrate why the standard cosmological model is unable to explain this puzzle, let us consider  $n_{\text{B}} = n_{\bar{\text{B}}}$  at temperatures  $T \gtrsim 1$  GeV. As the Universe expanded and cooled to  $T \lesssim 1$  GeV, the baryon-antibaryon pair annihilated into two photons and led us to  $n_{\text{B}}/n_{\gamma} = n_{\bar{\text{B}}}/n_{\gamma} \sim 10^{-18}$  [223], a value far below the observed value of  $\eta$  in Eq. (48). The dynamical origin of an acceptable baryon-antibaryon asymmetry in the observable Universe, which must be

beyond the scope of the standard Big Bang cosmology, is referred to as *baryogenesis*. A successful baryogenesis model is required to satisfy the three necessary ‘‘Sakharov conditions’’ [70]<sup>12</sup>:

- *Baryon number (B) violation.* If  $B$  were preserved by all the fundamental interactions, the Universe with an initial baryon-antibaryon symmetry would not be able to evolve to any imbalance between matter (baryons) and antimatter (antibaryons). Although both lepton number  $L$  and baryon number  $B$  are accidentally conserved at the classical level of the SM, they are equally violated at the non-perturbative level and hence only  $(B - L)$  is exactly invariant when the axial anomaly and nontrivial vacuum structures of non-Abelian gauge theories are taken into account [94, 95].
- *C and CP violation.* Since a baryon ( $B$ ) is converted into its antiparticle ( $-B$ ) under the charge-conjugation transformation, C violation is needed in order to create a net imbalance between baryons and antibaryons. In fact, the baryon number operator is odd under C but even under P and T transformations<sup>13</sup>, and thus CP violation is also a necessary condition to assure that a net baryon number excess can be generated from a  $B$ -violating reaction and its CP-conjugate process. Fortunately, both C and CP symmetries are violated in weak interactions within the SM and its reasonable extensions.
- *Departure from thermal equilibrium.* Given a net baryon number excess in the very early Universe, whether it can survive today or not depends on its evolution with temperature  $T$ . If the whole system stayed in thermal equilibrium and was described by a density operator  $\rho = \exp(-\mathcal{H}/T)$  with  $\mathcal{H}$  being the Hamiltonian which is invariant under CPT, then the equilibrium average of the baryon number operator  $\mathcal{B}$  would lead us to

$$\begin{aligned} \langle \mathcal{B} \rangle_T &= \text{Tr} [\mathcal{B} \exp(-\mathcal{H}/T)] \\ &= \text{Tr} [(CPT) \mathcal{B} (CPT)^{-1} (CPT) \exp(-\mathcal{H}/T) (CPT)^{-1}] \\ &= \text{Tr} [(-\mathcal{B}) \exp(-\mathcal{H}/T)] = -\langle \mathcal{B} \rangle_T . \end{aligned} \quad (49)$$

So  $\langle \mathcal{B} \rangle_T = 0$  would hold in thermal equilibrium, implying the disappearance of a net baryon number excess [223, 225]. That is why a successful baryogenesis model necessitates the departure of relevant baryon-number-violating interactions from thermal equilibrium. Fortunately, this can be the case in practice when the interaction rates are smaller than the Hubble expansion rate of the Universe [226].

<sup>12</sup>Note that Sakharov’s seminal paper was mainly focused on the first two conditions [70], and the third one was actually emphasized by Lev Okun and Yakov Zeldovich in 1975 [224].

<sup>13</sup>The baryon number operator is a Lorentz scalar defined as  $\mathcal{B} = \int d^3\mathbf{x} \sum_i [\psi_i^\dagger(t, \mathbf{x}) \psi_i(t, \mathbf{x})]$ , where the subscript  $i$  runs over all the quark flavors (i.e.,  $i = u, c, t$  and  $d, s, b$ ). Note that each quark flavor has a baryon number  $1/3$  and a color factor 3, and thus they are cancelled out in this definition. Given the C, P and T transformation properties of a free Dirac spinor in section 2.3.1, it is straightforward to show  $\psi_i^\dagger(t, \mathbf{x}) \psi_i(t, \mathbf{x}) \xrightarrow{C} -\psi_i^\dagger(t, \mathbf{x}) \psi_i(t, \mathbf{x})$ ,  $\psi_i^\dagger(t, \mathbf{x}) \psi_i(t, \mathbf{x}) \xrightarrow{P} \psi_i^\dagger(t, -\mathbf{x}) \psi_i(t, -\mathbf{x})$  and  $\psi_i^\dagger(t, \mathbf{x}) \psi_i(t, \mathbf{x}) \xrightarrow{T} \psi_i^\dagger(-t, \mathbf{x}) \psi_i(-t, \mathbf{x})$ . This explains why baryon number  $B = \langle \mathcal{B} \rangle$  is odd under C, CP and CPT transformations.



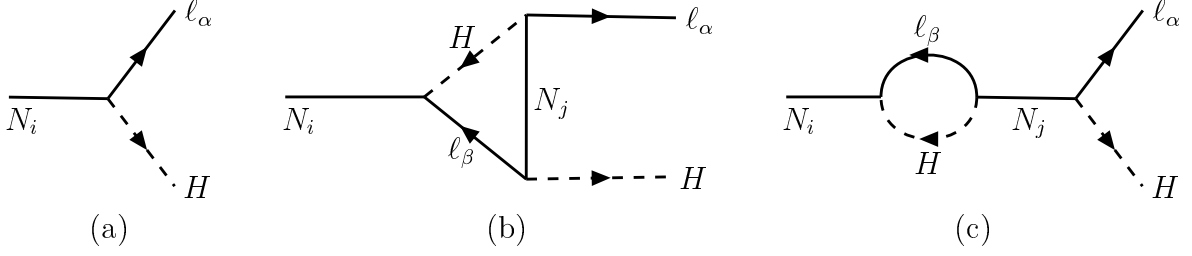

Figure 6: Feynman diagrams for the lepton-number-violating and CP-violating decays  $N_i \rightarrow \ell_\alpha + H$  at the tree and one-loop levels, where the Latin and Greek subscripts run over  $(1, 2, 3)$  and  $(e, \mu, \tau)$ , respectively. Note that each heavy Majorana neutrino  $N_i$  is its own antiparticle.

There are actually a number of baryogenesis mechanisms on the market, among which the typical ones include electroweak baryogenesis [154, 155, 156, 157], GUT baryogenesis [225], the Affleck-Dine mechanism [159, 227] and baryogenesis via leptogenesis [158]. Here we focus only on the canonical leptogenesis mechanism based on the canonical seesaw mechanism for generating tiny masses of three known neutrinos, and refer the reader to a few comprehensive reviews of other leptogenesis scenarios and recent developments in Refs. [172, 228, 229].

In the most popular (canonical or Type-I) seesaw mechanism described in section 2.2.3 and shown in Eqs. (30) and (31), one makes a minimal extension of the SM by including three right-handed neutrino fields  $N_{\alpha R}$  (for  $\alpha = e, \mu, \tau$ ) and permitting lepton number violation. Without loss of generality, it is always possible to choose a basis where the flavor eigenstates of these three degrees of freedom are identical with their mass eigenstates (i.e.,  $M_R = D_N \equiv \text{Diag}\{M_1, M_2, M_3\}$  is diagonal, real and positive). Since the masses of three heavy Majorana neutrinos  $N_i$  are expected to be far above the electroweak symmetry breaking scale (i.e.,  $M_i \gg v \simeq 246 \text{ GeV}$ ), the lepton-number-violating decays of  $N_i$  into the lepton doublet  $\ell_\alpha$  and the Higgs doublet  $H$  can take place via the Yukawa interactions at the tree level with the one-loop self-energy and vertex corrections as shown in Fig. 6 [158, 230, 231, 232]. The interference between the tree-level and one-loop diagrams result in a CP-violating asymmetry between the decay rates of  $N_i \rightarrow \ell_\alpha + H$  and its CP-conjugate process  $N_i \rightarrow \bar{\ell}_\alpha + \bar{H}$  [172, 233]:

$$\begin{aligned} \varepsilon_{i\alpha} &\equiv \frac{\Gamma(N_i \rightarrow \ell_\alpha + H) - \Gamma(N_i \rightarrow \bar{\ell}_\alpha + \bar{H})}{\sum_\alpha [\Gamma(N_i \rightarrow \ell_\alpha + H) + \Gamma(N_i \rightarrow \bar{\ell}_\alpha + \bar{H})]} \\ &= \frac{1}{8\pi(Y_\nu^\dagger Y_\nu)_{ii}} \sum_{j \neq i} \left\{ \text{Im} \left[ (Y_\nu^*)_{\alpha i} (Y_\nu)_{\alpha j} (Y_\nu^\dagger Y_\nu)_{ij} \right] \mathcal{F}(x_{ji}) + \text{Im} \left[ (Y_\nu^*)_{\alpha i} (Y_\nu)_{\alpha j} (Y_\nu^\dagger Y_\nu)_{ij}^* \right] \mathcal{G}(x_{ji}) \right\}, \quad (50) \end{aligned}$$

where the asymmetry has been normalized to the total decay rate so as to make the relevant Boltzmann equations linear in flavor space [228],  $x_{ji} \equiv M_j^2/M_i^2$  is defined, the loop functions  $\mathcal{F}$  and  $\mathcal{G}$  read as  $\mathcal{F}(x) = \sqrt{x} \{1 + 1/(1-x) + (1+x) \ln[x/(1+x)]\}$  and  $\mathcal{G}(x) = 1/(1-x)$  for a given variable  $x$ , and the Latin (or Greek) subscripts run over 1, 2 and 3 (or  $e, \mu$  and  $\tau$ ). Provided all the interactions in the era of leptogenesis are blind to lepton flavors, then one only needs to pay attention to

the total flavor-independent CP-violating asymmetry

$$\varepsilon_i = \sum_{\alpha} \varepsilon_{i\alpha} = \frac{1}{8\pi(Y_{\nu}^{\dagger}Y_{\nu})_{ii}} \sum_{j \neq i} \text{Im} \left[ (Y_{\nu}^{\dagger}Y_{\nu})_{ij}^2 \right] \mathcal{F}(x_{ji}). \quad (51)$$

Note that Eqs. (50) and (51) will be invalid if the masses of any two heavy Majorana neutrinos are nearly degenerate. In this special case the one-loop self-energy corrections can *resonantly* enhance the CP-violating asymmetry, leading to a result of the form [234, 235, 236, 237]:

$$\varepsilon'_i = \frac{\text{Im} \left[ (Y_{\nu}^{\dagger}Y_{\nu})_{ij}^2 \right]}{(Y_{\nu}^{\dagger}Y_{\nu})_{ii}(Y_{\nu}^{\dagger}Y_{\nu})_{jj}} \cdot \frac{(M_i^2 - M_j^2)M_i\Gamma_j}{(M_i^2 - M_j^2)^2 + M_i^2\Gamma_j^2}, \quad (52)$$

in which  $i \neq j$ ,  $\Gamma_i$  and  $\Gamma_j$  denote the decay widths of  $N_i$  and  $N_j$ , and  $|M_i - M_j| \sim \Gamma_i \sim \Gamma_j$  holds. Note again that this result is only applicable to the case of two nearly degenerate heavy Majorana neutrinos. For instance, it is found possible to achieve a successful *resonant* leptogenesis scenario in the minimal type-I seesaw model [238, 239] with  $M_1 \sim M_2$  for a quite wide range of energy scales (see, e.g., Refs. [240, 241, 242, 243]).

The CP-violating asymmetry between  $N_i \rightarrow \ell_{\alpha} + H$  and  $N_i \rightarrow \bar{\ell}_{\alpha} + \bar{H}$  decays in the early Universe provides a natural possibility of generating an intriguing lepton-antilepton asymmetry. But to prevent the resultant CP-violating asymmetry from being washed out by the inverse decays of  $N_i$  and various  $\Delta L = 1$  and  $\Delta L = 2$  scattering processes, the decays of  $N_i$  must be out of thermal equilibrium. In other words, the decay rates  $\Gamma(N_i \rightarrow \ell_{\alpha} + H)$  must be smaller than the Hubble expansion rate of the Universe at temperature  $T \simeq M_i$ . Defining an asymmetry between the lepton number density  $n_L$  and the antilepton number density  $n_{\bar{L}}$  as  $Y_L \equiv (n_L - n_{\bar{L}})/s$ , where  $s$  stands for the entropy density of the Universe, one would naively expect that this quantity depends linearly on the CP-violating asymmetry  $\varepsilon_i$  (or  $\varepsilon_{i\alpha}$  in the flavor-dependent case). Of course, an exact description of the lepton-antilepton asymmetry resorts to solving a full set of Boltzmann equations for the time evolution of relevant particle number densities [226, 228, 230, 232, 244, 245, 246]. Given the mass hierarchy  $M_1 \ll M_2 < M_3$ , for example, the lepton-number-violating interactions of the lightest heavy Majorana neutrino  $N_1$  may be rapid enough to wash out the lepton-antilepton number asymmetry originating from  $\varepsilon_2$  and  $\varepsilon_3$ . In this case only the CP-violating asymmetry  $\varepsilon_1$  will survive and contribute to thermal leptogenesis.

Note that  $\varepsilon_i$  and  $\varepsilon_{i\alpha}$  correspond to the “unflavored” and “flavored” leptogenesis scenarios, respectively. As for the unflavored leptogenesis, the Yukawa interactions of charged leptons are not taken into consideration, because the equilibrium temperature of heavy Majorana neutrinos is expected to be high enough that such interactions cannot distinguish one lepton flavor from another. In other words, all the relevant Yukawa interactions are blind to lepton flavors. When the equilibrium temperature decreases and lies in one of the flavored ranges shown in Fig. 7, however, the associated Yukawa interactions of charged leptons become faster than the (inverse) decays of  $N_i$  or equivalently comparable to the expansion rate of the Universe [228, 233, 241, 244, 246, 247, 248, 249]. In this case the flavor effects must be taken into account, and that is why the corresponding leptogenesis scenario is referred to as *flavored* leptogenesis which depends on the CP-violating asymmetries  $\varepsilon_{i\alpha}$  (for  $\alpha = e, \mu, \tau$ ).

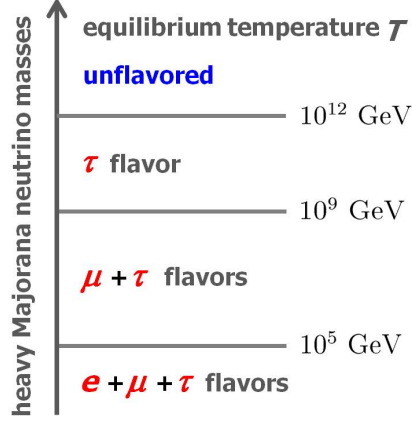

Figure 7: A schematic illustration of the equilibrium temperature intervals of heavy Majorana neutrinos associated with the *unflavored* and *flavored* leptogenesis scenarios.

In the epoch of leptogenesis with temperature ranging from  $10^2$  GeV to  $10^{12}$  GeV, the non-perturbative ( $B - L$ )-conserving sphaleron interactions were in thermal equilibrium and thus very efficient in converting a net lepton-antilepton asymmetry  $Y_L$  to a net baryon-antibaryon asymmetry  $Y_B \equiv (n_B - n_{\bar{B}})/s$ . Such a conversion can be expressed as [226, 250]

$$\begin{aligned} \left. \frac{n_B}{s} \right|_{\text{equilibrium}} &= c \left. \frac{n_B - n_L}{s} \right|_{\text{equilibrium}} = -c \left. \frac{n_L}{s} \right|_{\text{initial}} , \\ \left. \frac{n_{\bar{B}}}{s} \right|_{\text{equilibrium}} &= c \left. \frac{n_{\bar{B}} - n_{\bar{L}}}{s} \right|_{\text{equilibrium}} = -c \left. \frac{n_{\bar{L}}}{s} \right|_{\text{initial}} , \end{aligned} \quad (53)$$

where  $c = (8N_f + 4N_H)/(22N_f + 13N_H)$  with  $N_H$  and  $N_f$  being the numbers of the Higgs doublets and fermion families, respectively. Therefore, one has  $c = 28/79$  in the SM with  $N_H = 1$  and  $N_f = 3$ . The relations in Eq. (53) immediately lead us to  $Y_B = -cY_L$ , so the final baryon-antibaryon asymmetry  $Y_B$  is determined by the initial lepton-antilepton asymmetry  $Y_L$  — an elegant picture of baryogenesis via leptogenesis as illustrated by Fig. 8. Note that  $Y_L$  must be negative to yield a positive  $Y_B$ , in order to account for the observed value of  $\eta$  given in Eq. (48) through the relation  $\eta = sY_B/n_\gamma \simeq 7.04Y_B$  [172]. The evolution of  $Y_L$  and  $Y_B$  with temperature  $T$  can be calculated by solving the relevant Boltzmann equations.

### 2.3.3. Strong CP violation in a nutshell

Different from the standard electroweak theory in which the gauge fields are coupled to the chiral currents of fermion fields, the QCD sector of the SM is not so easy to break C, P and CP symmetries because the gluon fields are coupled to the vector currents. But a topological  $\theta$ -vacuum term is actually allowed in the Lagrangian of QCD, and it is odd under P and T transformations and thus CP-violating. Given the fact that CP violation has never been observed in any strong interactions, why such a CP-violating  $\theta$ -term should in principle exist in the SM turns out to be a puzzling theoretical issue — the so-called *strong CP problem*.

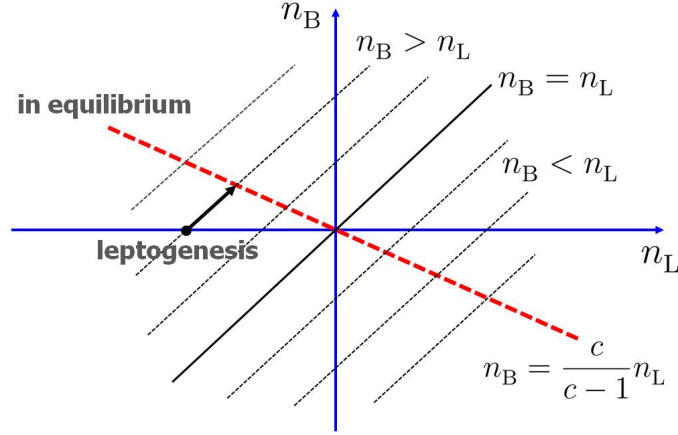

Figure 8: A schematic illustration of the relationship between baryon number density  $n_B$  and lepton number density  $n_L$ . The sphaleron processes change both lepton number  $L$  and baryon number  $B$  along the dotted lines with  $(B - L)$  conservation. The red thick dashed line satisfies the condition  $n_B = c(n_B - n_L)$  as described by Eq. (53), and it should finally be reached if the sphaleron interactions are in thermal equilibrium. The black arrow represents a successful example of leptogenesis, from initial  $n_B = 0$  but  $n_L \neq 0$  to final  $n_B \neq 0$  (and  $n_L \neq 0$ ).

Let us consider the Lagrangian of QCD for quark and gluon fields in the *flavor* basis, including the topological  $\theta$ -vacuum term, as follows:

$$\begin{aligned} \mathcal{L}_{\text{QCD}} = & \sum_i (\bar{q}_i i \not{D} q_i + \bar{q}'_i i \not{D} q'_i) - \sum_i \sum_j [\bar{q}_{iL} (M_u)_{ij} q_{jR} + \bar{q}'_{iL} (M_d)_{ij} q'_{jR} + \text{h.c.}] \\ & - \frac{1}{4} G_{\mu\nu}^a G^{a\mu\nu} + \theta \frac{g_s^2}{32\pi^2} G_{\mu\nu}^a \tilde{G}^{a\mu\nu}, \end{aligned} \quad (54)$$

in which  $\not{D} \equiv D_\mu \gamma^\mu$  has been defined,  $D_\mu = \partial_\mu - ig_s A_\mu^a \lambda_a / 2$  is the gauge covariant derivative of QCD with  $g_s$  being the strong coupling constant,  $A_\mu^a$  being the gluon fields and  $\lambda_a$  being the Gell-Mann matrices (for  $a = 1, 2, \dots, 8$ ),  $G_{\mu\nu}^a$  denote the  $SU(3)_c$  gauge field strengths of gluons,  $\tilde{G}^{a\mu\nu} = \varepsilon^{\mu\nu\alpha\beta} G_{\alpha\beta}^a / 2$  with  $\varepsilon^{\mu\nu\alpha\beta}$  being the four-dimensional Levi-Civita symbol, and the subscripts  $i$  and  $j$  run over  $(1, 2, 3)$  for up- and down-type quarks as specified in Table 3. Note that the topological  $\theta$ -vacuum term is irrelevant to the classical equations of motion and perturbative expansions of QCD, but it may produce non-perturbative effects associated with the existence of color instantons [251] which describe the quantum-mechanical tunneling between inequivalent vacua of QCD and help solve the  $U(1)_A$  problem [94, 95, 162, 163, 164, 165, 166]. Therefore, the physics of QCD *does* depend on the mysterious  $\theta$  parameter in some aspects [252].

One may follow Eq. (6) to diagonalize the quark mass matrices in Eq. (54), and this treatment is equivalent to transforming the flavor eigenstates of six quarks into their mass eigenstates, including both left- and right-handed fields. The quark mass term turns out to be

$$-\mathcal{L}_{q\text{-mass}} = \overline{(u \ c \ t)_L} D_u \begin{pmatrix} u \\ c \\ t \end{pmatrix}_R + \overline{(d \ s \ b)_L} D_d \begin{pmatrix} d \\ s \\ b \end{pmatrix}_R + \text{h.c.}, \quad (55)$$

where  $D_u \equiv \text{Diag}\{m_u, m_c, m_t\}$  and  $D_d \equiv \text{Diag}\{m_d, m_s, m_b\}$ . In this case weak CP violation hidden in the second term of  $\mathcal{L}_{\text{QCD}}$  (i.e., the Yukawa-interaction term) has shifted to the charged-current interactions as described by the Kobayashi-Maskawa mechanism in section 2.3.1. It is straightforward to show that the first and third terms of  $\mathcal{L}_{\text{QCD}}$  are also CP-invariant, but the fourth term of  $\mathcal{L}_{\text{QCD}}$  is apparently odd under P and T due to its close association with the completely anti-symmetric Levi-Civita symbol  $\varepsilon^{\mu\nu\alpha\beta}$  [221]. Hence the topological  $\theta$ -vacuum term in Eq. (54) is C-invariant but CP-violating. In other words, it should be a source of CP violation in QCD.

Now let us make the chiral transformations  $\psi_i \rightarrow \exp(i\alpha_i\gamma_5)\psi_i$  for the quark fields, where the subscript  $i$  runs over all the six quark flavors (namely,  $i = u, c, t$  and  $d, s, b$ ). Given the fact that  $\exp(i\alpha_i\gamma_5) = \cos\alpha_i + i\gamma_5 \sin\alpha_i$  can be proved by using the Taylor expansion, it is easy to show  $\psi_{iL} \rightarrow \exp(-i\alpha_i)\psi_{iL}$  and  $\psi_{iR} \rightarrow \exp(+i\alpha_i)\psi_{iR}$  under the chiral transformations, which are equivalent to  $m_i \rightarrow m_i \exp(2i\alpha_i)$ . The latter means

$$\arg(\det D_u) + \arg(\det D_d) \longrightarrow \arg(\det D_u) + \arg(\det D_d) + 2 \sum_i \alpha_i, \quad (56a)$$

$$\arg(\det M_u) + \arg(\det M_d) \longrightarrow \arg(\det M_u) + \arg(\det M_d) + 2 \sum_i \alpha_i, \quad (56b)$$

where Eq. (6) has been taken into account in obtaining Eq. (56b). That is why the quark mass term of  $\mathcal{L}_{\text{QCD}}$  explicitly breaks the chiral symmetry. Note that the topological  $\theta$ -vacuum term in Eq. (54) is also sensitive to the above chiral transformations through the well-known Adler-Bell-Jackiw chiral anomaly relation [165, 166]

$$\partial_\mu (\bar{\psi}_i \gamma^\mu \gamma_5 \psi_i) = 2im_i \bar{\psi}_i \gamma_5 \psi_i + \frac{g_s^2}{16\pi} G_{\mu\nu}^a \tilde{G}^{a\mu\nu}, \quad (57)$$

from which one can obtain [252, 253, 254]

$$\theta \longrightarrow \theta - 2 \sum_i \alpha_i. \quad (58)$$

Eqs. (56b) and (58) tell us that the combination

$$\bar{\theta} \equiv \theta + \arg(\det M_u) + \arg(\det M_d) \quad (59)$$

must be invariant under chiral transformations of the quark fields. Then the Lagrangian of QCD in Eq. (54) can be rewritten, in the standard quark mass basis, as

$$\mathcal{L}'_{\text{QCD}} = \sum_i (\bar{\psi}_i i\not{D} - m_i) \psi_i - \frac{1}{4} G_{\mu\nu}^a G^{a\mu\nu} + \bar{\theta} \frac{\alpha_s}{8\pi} G_{\mu\nu}^a \tilde{G}^{a\mu\nu}, \quad (60)$$

where  $i$  runs over all the six quark mass eigenstates, and  $\alpha_s \equiv g_s^2/(4\pi)$  is the QCD analog of the fine-structure constant in quantum electrodynamics (QED).

The observable  $\bar{\theta}$  depends on the phase structures of quark mass matrices  $M_u$  and  $M_d$ , as shown in Eq. (59) [255]. Because of  $\det M_u \propto \det D_u \propto m_u m_c m_t$ , the determinant of  $M_u$  vanishes in the  $m_u \rightarrow 0$  limit. In this case the phase of  $\det M_u$  (or that of  $\det D_u$ ) is arbitrary, and thus it can be

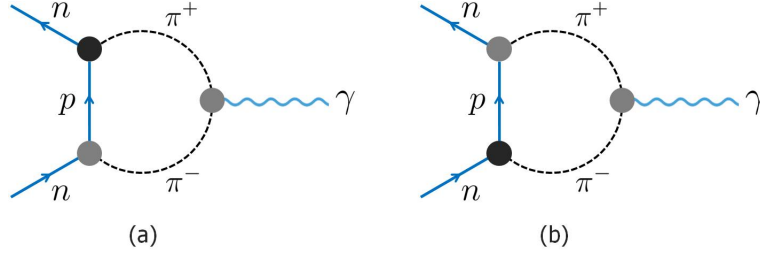

Figure 9: The dominant hadron-level diagrams for the neutron electric dipole moment, in which the gray  $\pi np$  coupling vertices are CP-conserving and the black  $\pi np$  coupling vertex is CP-violating. The latter is proportional to the effective strong CP-violation parameter  $\bar{\theta}$  in QCD.

properly arranged to cancel out the strong-interaction vacuum angle  $\theta$  such that  $\bar{\theta} \rightarrow 0$ . The same is true in the  $m_d \rightarrow 0$  limit. Hence QCD would be a CP-conserving theory if one of the six quarks were massless. But current experimental data have definitely ruled out the possibility of  $m_u = 0$  or  $m_d = 0$  [19]. Given its period  $2\pi$  (i.e.,  $\bar{\theta}$  ranging from 0 to  $2\pi$ ), the magnitude of  $\bar{\theta}$  is naturally expected to be of  $O(1)$ . But the experimental upper limit on the neutron electric dipole moment  $d_n < 2.9 \times 10^{-26} e \text{ cm}$  [167] has provided a stringent constraint  $|\bar{\theta}| < 2 \times 10^{-10}$  in lattice QCD via the linear dependence of  $\bar{\theta}$  on  $d_n$  (i.e.,  $d_n \sim -1.5 \times 10^{-16} \bar{\theta} e \text{ cm}$  [256, 257, 258, 259, 260]), as illustrated in Fig. 9. Why is  $\bar{\theta}$  so tiny rather than  $O(1)$ ? In other words, why is *strong* CP violation not strong at all? The smallness of  $\bar{\theta}$  seems to be favored by 't Hooft's naturalness criterion [106] in the sense that switching off this tiny parameter will eliminate strong CP violation and thus enhance the symmetry of QCD. But remember that  $\bar{\theta}$  consists of both QCD and electroweak contributions in general, and hence they have to cancel each other out in a perfect way so as to arrive at a vanishing or vanishingly small value of  $\bar{\theta}$ . Such a fine-tuning issue is strongly unnatural and hence constitutes the strong CP problem in particle physics.

There are quite a number of theoretical solutions to this long-standing problem [253, 254, 261], among which the most popular ones should be the Peccei-Quinn mechanism [168, 169] and its variations which predict the existence of axions or axion-like particles [262, 263, 264, 265, 266, 267, 268]. Such hypothetical particles are of particular interest today in cosmology and astrophysics because they could be a possible component of cold dark matter [121, 261]. Another intriguing approach for solving the strong CP problem is to conjecture that the CP symmetry in QCD is spontaneously but softly broken, leading to a nonzero but sufficiently small  $\bar{\theta}$  which is even calculable in terms of the model parameters [269, 270, 271, 272, 273, 274].

In principle a comparison between the strengths of weak and strong CP violation in the SM should make sense, but in practice it is very difficult to choose a proper measure for either of them. The issue involves both the reference energy scales and the flavor parameters which directly determine or indirectly affect the magnitude of CP violation. For illustration, let us consider [275]

$$\begin{aligned} \text{CP}_{\text{weak}} &\sim \frac{1}{\Lambda_{\text{EW}}^6} (m_u - m_c)(m_c - m_t)(m_t - m_u)(m_d - m_s)(m_s - m_b)(m_b - m_d) \mathcal{J}_q \sim 10^{-13}, \\ \text{CP}_{\text{strong}} &\sim \frac{1}{\Lambda_{\text{QCD}}^6} m_u m_c m_t m_d m_s m_b \sin \bar{\theta} \sim 10^4 \sin \bar{\theta} < 10^{-6}, \end{aligned} \quad (61)$$

in which  $\Lambda_{\text{EW}} \sim 10^2 \text{ GeV}$ ,  $\Lambda_{\text{QCD}} \sim 0.2 \text{ GeV}$ ,  $\mathcal{J}_q \simeq 3.2 \times 10^{-5}$  is the Jarlskog invariant of weak CP violation [19], and the sine function of  $\bar{\theta}$  has been adopted to take account of the periodicity in its values<sup>14</sup>. Eq. (61) implies that weak CP violation would vanish if the masses of any two quarks of the same electric charge were degenerate, and strong CP violation would vanish if one of the six quarks were massless or  $\sin \bar{\theta} \rightarrow 0$  held. The remarkable suppression of weak CP violation in the SM makes it impossible to explain the observed baryon-antibaryon asymmetry of the Universe, and hence a new source of CP violation beyond the SM (e.g., CP violation in the lepton sector, especially the one associated with the existence of heavy Majorana neutrinos as discussed in section 2.3.2) is necessary and welcome in this connection.

### 3. Current knowledge about the flavor parameters

#### 3.1. Running masses of charged leptons and quarks

##### 3.1.1. On the concepts of fermion masses

Roughly speaking, a particle's *mass* is its inertial energy when it exists at rest. That is why a massless particle has no way to exist at rest and has to move at the speed of light. Given the chirality or handedness of a massive fermion, it must exist in both left- and right-handed states. The reason is simply that the field operators responsible for the nonzero mass of a fermion must be bilinear products of the spinor fields which flip the handedness [177]. Within the SM the masses of nine charged fermions are generated via their Yukawa interactions with the Higgs field after the latter acquires its vacuum expectation value (i.e., after spontaneous electroweak symmetry breaking), while the three neutrinos are exactly massless because the model unfairly dictates them to be purely left-handed and forbids them to have anything to do with the Higgs field. So the origin of neutrino masses must be beyond the scope of the SM.

The mass parameter of a fundamental fermion characterizes one of its most important properties and has profound meaning. The physical mass of a lepton (either a charged lepton or a neutrino) is defined to be the *pole* of its propagator, and thus such a mass parameter can be directly and unambiguously measured. In comparison, the up, down, strange, charm and bottom quarks are always confined inside hadrons and hence they are not observed as free particles. But the top quark has no time to form the top-flavored hadrons or ( $t\bar{t}$ )-quarkonium bound states, because its lifetime ( $\simeq 4.7 \times 10^{-25} \text{ s}$ ) is much shorter than the typical time scale of strong interactions (i.e.,  $\Lambda_{\text{QCD}}^{-1} \simeq 3.3 \times 10^{-24} \text{ s}$ ). That is why the pole mass of the top quark can be directly measured, although its value is unavoidably ambiguous up to an amount proportional to  $\Lambda_{\text{QCD}} \simeq 0.2 \text{ GeV}$  because of the non-perturbative QCD effect [278, 279].

Note that the mass parameters of both leptons and quarks appearing in the full Lagrangian of the SM have different meanings. For example, the Lagrangian of QCD in Eq. (60) can make finite predictions for physical quantities only after renormalization — a procedure invoking a divergence-subtraction scheme and requiring the introduction of a scale parameter  $\mu$ . In this way

---

<sup>14</sup>Note that running the heavy quark masses  $m_c$ ,  $m_b$  and  $m_t$  down to the QCD scale might not make sense [276]. If only the up- and down-quark masses are taken into account, one may propose  $\text{CP}_{\text{strong}} \sim m_u m_d \sin \bar{\theta} / \Lambda_{\text{QCD}}^2$  as an alternative measure of the strength of strong CP violation [277].

the relevant quark masses are referred to as the *running* (or renormalized) masses which depend on both  $\mu$  and the renormalization scheme adopted to define the QCD perturbation theory, and this dependence reflects the fact that a bare quark is actually surrounded by a cloud of gluons and quark-antiquark pairs. Similarly, the running mass of a charged lepton includes the “clothing” induced by QED effects. Taking advantage of the most commonly used  $\overline{\text{MS}}$  scheme — the modified minimal subtraction scheme [280, 281], one may determine the *running* mass of a given fermion evolving with the energy scale  $\mu$  and establish its relationship with the pole mass [19].

As discussed in section 2.3.3, the QCD Lagrangian has a chiral symmetry in the limit where all the quark masses are vanishing. This symmetry is spontaneously broken by dynamical chiral symmetry breaking effects at the scale  $\Lambda_\chi \simeq 1$  GeV, and explicitly broken by finite quark masses. One may use  $\Lambda_\chi \simeq 1$  GeV to distinguish between light and heavy quarks, whose running masses are respectively below and above this scale. That is why up, down and strange quarks are categorized into the light quarks, and their running masses are also referred to as the *current* quark masses. The latter certainly have nothing to do with the so-called *constituent* quark masses defined in the context of a particular non-relativistic quark or hadron model.

### 3.1.2. Running masses of three charged leptons

Now let us consider the pole masses of three charged leptons. Their values have been determined to an unprecedented degree of accuracy [19]:

$$\begin{aligned} M_e &= (0.5109989461 \pm 0.0000000031) \text{ MeV} , \\ M_\mu &= (105.6583745 \pm 0.0000024) \text{ MeV} , \\ M_\tau &= (1776.86 \pm 0.12) \text{ MeV} . \end{aligned} \quad (62)$$

Taking account of these values, one finds that the so-called Koide mass relation [282]

$$K_{\text{pole}} \equiv \frac{M_e + M_\mu + M_\tau}{(\sqrt{M_e} + \sqrt{M_\mu} + \sqrt{M_\tau})^2} = \frac{2}{3} \quad (63)$$

is satisfied up to the accuracy of  $O(10^{-5})$ . Whether such an amazing equality has a deeper meaning remains to be seen. By calculating the one-loop self-energy corrections of QED, one may obtain a relationship between the running masses  $m_\alpha(\mu)$  in the  $\overline{\text{MS}}$  scheme and the corresponding pole masses  $M_\alpha$  for three charged leptons [283]:

$$m_\alpha(\mu) = M_\alpha \left[ 1 - \frac{\alpha_{\text{em}}(\mu)}{\pi} \left( 1 + \frac{3}{2} \ln \frac{\mu}{m_\alpha(\mu)} \right) \right] , \quad (64)$$

where the subscript  $\alpha$  runs over  $e$ ,  $\mu$  and  $\tau$ , and  $\alpha_{\text{em}}(\mu)$  is the fine-structure constant of QED whose value depends on the energy scale  $\mu$ . Given  $\alpha_{\text{em}}(0) \simeq 1/137$  and  $\alpha_{\text{em}}(M_W) \simeq 1/128$  for example [19], it is easy to imagine and evaluate how the running mass of each charged lepton varies with the energy scales and deviates from the value of its pole mass. If the pole masses  $M_\alpha$  in Eq. (63) are replaced by the running masses  $m_\alpha(\mu)$ , then the Koide mass relation will become scale-dependent. In this case the corresponding quantity  $K(\mu)$  is expected to deviate from  $2/3$  to some extent. A



Table 6: The running masses of charged leptons at some typical renormalization scales in the SM [91], including  $\mu = 1$  TeV and  $\Lambda_{\text{VS}} \simeq 4 \times 10^{12}$  GeV (a cutoff scale which is presumably associated with the SM vacuum stability). The uncertainties of  $m_\alpha(\mu)$  are determined by those of  $M_\alpha$  (for  $\alpha = e, \mu, \tau$ ) in Eq. (62) when  $\mu \lesssim M_t$ , and they become increasingly large for  $\mu > M_t$  due to the pollution of uncertainties of the top-quark and Higgs-boson masses.

Scale $\mu$	$m_e(\mu)$ (MeV)	$m_\mu(\mu)$ (MeV)	$m_\tau(\mu)$ (MeV)
$M_W$	$0.4885557 \pm 0.0000017$	$102.92094 \pm 0.00021$	$1748.25 \pm 0.12$
$M_Z$	$0.4883266 \pm 0.0000017$	$102.87267 \pm 0.00021$	$1747.43 \pm 0.12$
$M_H$	$0.4877512 \pm 0.0000018$	$102.75147 \pm 0.00022$	$1745.38 \pm 0.12$
$M_t$	$0.4871589 \pm 0.0000018$	$102.62669 \pm 0.00023$	$1743.26 \pm 0.12$
1 TeV	$0.49170 \pm 0.00014$	$103.584 \pm 0.030$	$1759.66 \pm 0.52$
$\Lambda_{\text{VS}}$	$0.4820 \pm 0.0016$	$101.55 \pm 0.34$	$1725.4 \pm 5.9$

numerical exercise shows that the ratio of  $K(M_Z)$  to  $K_{\text{pole}}$  is about  $1 + 0.2\%$  [284], where the correction is roughly of order  $\alpha_{\text{em}}(\mu)/\pi$  as expected from Eq. (64).

The running masses of three charged leptons at a number of typical energy scales have been calculated by using the renormalization-group equations (RGEs) [90, 91, 285], with both the input of the observed Higgs mass [19] and the consideration of the matching relations for the decoupling of heavy particles from the SM and the decoupling of lighter fermions from the low-energy effective theory [286, 287]. Here we quote some numerical results from Ref. [91] and list them in Table 6. One can see that the strong mass hierarchy  $m_e \ll m_\mu \ll m_\tau$  exists at every reference scale, and it strongly suggests the existence of a special flavor basis in which the  $3 \times 3$  charged-lepton mass matrix  $M_l$  exhibits a “rank-one” limit with  $m_e = m_\mu = 0$  and  $m_\tau = C_l$  [288]:

$$M_l^{(\text{H})} = C_l \begin{pmatrix} 0 & 0 & 0 \\ 0 & 0 & 0 \\ 0 & 0 & 1 \end{pmatrix}, \quad (65)$$

where “H” means the “hierarchy” basis. In this case a realistic texture of  $M_l$  can be obtained by introducing some proper perturbative corrections to  $M_l^{(\text{H})}$ , such that  $e$  and  $\mu$  leptons directly acquire their finite masses. Note that  $M_l^{(\text{H})}$  is actually equivalent to another “rank-one” mass matrix, the so-called flavor “democracy” or Bardeen-Cooper-Schrieffer (BCS) pattern [137]

$$M_l^{(\text{D})} = \frac{C_l}{3} \begin{pmatrix} 1 & 1 & 1 \\ 1 & 1 & 1 \\ 1 & 1 & 1 \end{pmatrix}, \quad (66)$$

because these two matrices are related with each other through a simple orthogonal transformation  $O_*^T M_l^{(\text{D})} O_* = M_l^{(\text{H})}$ , where

$$O_* = \frac{1}{\sqrt{6}} \begin{pmatrix} \sqrt{3} & 1 & \sqrt{2} \\ -\sqrt{3} & 1 & \sqrt{2} \\ 0 & -2 & \sqrt{2} \end{pmatrix}. \quad (67)$$

Eq. (66) implies that the Yukawa interactions responsible for the mass generation of three charged leptons have the same (or a universal) strength, but there is a clear mass gap between the first two families ( $m_e = m_\mu = 0$ ) and the third family ( $m_\tau = C_l$ ) — an interesting phenomenon which has also been observed in the BCS theory of superconductivity and in the nuclear pairing force [289]. Such a flavor democracy or  $S_{3L} \times S_{3R}$  symmetry represents a new starting point of view for model building; namely, the finite masses of  $e$  and  $\mu$  may naturally arise from spontaneous or explicit breaking of the  $S_{3L} \times S_{3R}$  flavor symmetry [132, 133, 137].

### 3.1.3. Running masses of six quarks

There are several theoretical ways to determine the masses of three light quarks  $u$ ,  $d$  and  $s$ , including the lattice gauge theory, chiral perturbation theory and QCD sum rules [19]. Among them, the lattice-QCD simulation provides the most reliable determination of the strange quark mass  $m_s$  and the average of up and down quark masses  $(m_u + m_d)/2$  [290, 291, 292]. A combination of this approach and the chiral perturbation theory allows us to pin down the isospin-breaking effects and thus determine the individual values of  $u$  and  $d$  masses [293, 294]. In the  $\overline{\text{MS}}$  scheme and at the renormalization scale  $\mu = 2$  GeV, the results  $m_u = (2.32 \pm 0.10)$  MeV,  $m_d = (4.71 \pm 0.09)$  MeV and  $m_s = (92.9 \pm 0.7)$  MeV have been obtained [19].

The chiral perturbation theory is a powerful technique to extract the mass ratios of three light quarks in a scale-independent way. With the help of the  $\overline{\text{MS}}$  scheme, one may obtain [129]

$$\begin{aligned} \frac{m_u}{m_d} &= \frac{2m_{\pi^0}^2 - m_{\pi^+}^2 + m_{K^+}^2 - m_{K^0}^2}{m_{K^0}^2 - m_{K^+}^2 + m_{\pi^+}^2} \simeq 0.56 , \\ \frac{m_s}{m_d} &= \frac{m_{K^0}^2 + m_{K^+}^2 - m_{\pi^+}^2}{m_{K^0}^2 - m_{K^+}^2 + m_{\pi^+}^2} \simeq 20.2 , \end{aligned} \quad (68)$$

in the lowest-order approximation of the chiral perturbation theory. These results are essentially consistent with those obtained from the lattice-QCD simulation. If the uncertainty associated with the value of  $m_s/m_d$  is taken into account, a more conservative estimate yields  $m_s/m_d = 17 \cdots 22$ . This result is particularly interesting from a point of view of model building, because both the Cabibbo quark mixing angle  $\vartheta_C \equiv \vartheta_{12}$  [20] and the ratio  $|V_{td}|/|V_{ts}|$  of the CKM matrix  $V$  [21] are expected to be  $\sqrt{m_d/m_s} \simeq 0.22$  to a relatively good degree of accuracy in a class of textures of quark mass matrices [129, 130, 131, 135, 136, 137].

At the renormalization scale  $\mu = 2$  GeV, the Particle Data Group has recommended the following benchmark values for the *current* masses of  $u$ ,  $d$  and  $s$  quarks [19, 293, 295, 296, 297, 298]:

$$\begin{aligned} m_u(2 \text{ GeV}) &= 2.16_{-0.26}^{+0.49} \text{ MeV} , \\ m_d(2 \text{ GeV}) &= 4.67_{-0.17}^{+0.48} \text{ MeV} , \\ m_s(2 \text{ GeV}) &= 93_{-5}^{+11} \text{ MeV} . \end{aligned} \quad (69)$$

To calculate the  $\overline{\text{MS}}$  masses of these three light quarks at the renormalization scale  $\mu = 1$  GeV, one just needs to multiply the results given in Eq. (69) by a common factor 1.35. The ratios  $m_u/m_d$  and  $m_d/m_s$  are therefore independent of the energy scales.

Since the masses of charm and bottom quarks are far above the QCD scale  $\Lambda_{\text{QCD}} \simeq 0.2 \text{ GeV}$ , their values can be extracted from the study of masses and decays of hadrons containing one or two heavy quarks, where both perturbative contributions and non-perturbative effects should be taken into account. The useful theoretical techniques for calculating the spectroscopy of heavy hadrons include the heavy quark effective theory, lattice gauge theory, QCD sum rules and non-relativistic QCD. In the  $\overline{\text{MS}}$  scheme the Particle Data Group has recommended the following benchmark values for running masses of the charm and bottom quarks [19]:

$$\begin{aligned} m_c(m_c) &= 1.27 \pm 0.02 \text{ GeV} , \\ m_b(m_b) &= 4.18_{-0.02}^{+0.03} \text{ GeV} . \end{aligned} \quad (70)$$

Similar to the pole mass of a charged lepton, the pole mass of a heavy quark can also be defined as the position of the pole in its propagator in the perturbation theory of QCD. It should be noted that the full quark propagators actually have no pole for  $c$  and  $b$  quarks because they are confined in hadrons. That is the reason why the concept of ‘‘pole mass’’ becomes invalid in the non-perturbative regime, and it is seldom used for the three light quarks [90, 91]. The relation between the pole mass  $M_q$  of a heavy quark and its running mass  $m_q$  (for  $q = c, b, t$ ) has been calculated to the level of three-loop [299, 300, 301, 302] and four-loop QCD corrections [303, 304], but for the sake of simplicity we only quote the one-loop analytical result

$$M_q = m_q(m_q) \left[ 1 + \frac{4\alpha_s(m_q)}{3\pi} \right] , \quad (71)$$

where  $\alpha_s(\mu)$  is the strong-interaction coupling constant analogous to the fine-structure constant  $\alpha_{\text{em}}(\mu)$  of QED. Note that the higher-order corrections in the expression of  $M_q$  should not be neglected when doing a numerical calculation of the pole mass of a heavy quark, because a sum of their contributions is comparable in size and has the same sign as the one-loop term shown above. Given the running masses in Eq. (70), one finds the pole masses  $M_c = (1.67 \pm 0.07) \text{ GeV}$  and  $M_b = (4.78 \pm 0.06) \text{ GeV}$  for charm and bottom quarks, respectively [19].

In view of the fact that the top quark is too short-lived to form any hadrons, its pole mass can be directly measured from the kinematics of  $t\bar{t}$  events. The following value is an average of the LHC and Tevatron measurements of  $M_t$  as recommended by the Particle Data Group [19]:

$$M_t = (172.9 \pm 0.4) \text{ GeV} . \quad (72)$$

On the other hand, the running mass of the top quark can be extracted from a measurement of the cross-section of  $t\bar{t}$  events with the help of some theoretical calculations. In this case the Particle Data Group has advocated the benchmark value  $m_t(m_t) = 160.0_{-4.3}^{+4.8} \text{ GeV}$  [19], where the error bar remains much larger than the uncertainty associated with  $\Lambda_{\text{QCD}}$ . This result is in good agreement with that in Eq. (72), of course, as they are related with each other through Eq. (71) with the inclusion of higher-order QCD corrections [303, 304].

Table 7 provides a list of running quark masses at a few typical energy scales<sup>15</sup>, where the given values of quark masses in Eqs. (69), (70) and (72) have been adopted as the inputs. Given

<sup>15</sup>In the SM the so-called ‘‘mass’’ of a fermion at an energy scale above  $v \simeq 246 \text{ GeV}$  is usually defined as the product of its Yukawa coupling eigenvalue at this scale and  $v/\sqrt{2}$ , where the vacuum expectation value  $v$  is treated as a constant and only the Yukawa coupling parameter evolves with the energy scale [305].

Table 7: The running masses of quarks at some typical energy scales in the SM [91], including  $\mu = 1$  TeV and  $\Lambda_{\text{VS}} \simeq 4 \times 10^{12}$  GeV (a cutoff scale which is presumably associated with the SM vacuum stability). Here the benchmark values of quark masses given in Eqs. (69), (70) and (72) are input after their error bars are symmetrized.

Scale $\mu$	$m_u(\mu)$ (MeV)	$m_d(\mu)$ (MeV)	$m_s(\mu)$ (MeV)	$m_c(\mu)$ (GeV)	$m_b(\mu)$ (GeV)	$m_t(\mu)$ (GeV)
$M_W$	$1.25 \pm 0.22$	$2.72 \pm 0.19$	$54.1 \pm 4.7$	$0.63 \pm 0.02$	$2.89 \pm 0.03$	...
$M_Z$	$1.24 \pm 0.22$	$2.69 \pm 0.19$	$53.5 \pm 4.6$	$0.62 \pm 0.02$	$2.86 \pm 0.03$	...
$M_H$	$1.20 \pm 0.21$	$2.62 \pm 0.18$	$52.1 \pm 4.5$	$0.61 \pm 0.02$	$2.78 \pm 0.03$	...
$M_t$	$1.17 \pm 0.20$	$2.55 \pm 0.18$	$50.8 \pm 4.4$	$0.59 \pm 0.02$	$2.71 \pm 0.03$	...
1 TeV	$1.05 \pm 0.18$	$2.29 \pm 0.16$	$45.6 \pm 4.0$	$0.53 \pm 0.02$	$2.39 \pm 0.02$	$148.5 \pm 1.0$
$\Lambda_{\text{VS}}$	$0.54 \pm 0.10$	$1.20 \pm 0.09$	$24.0 \pm 2.1$	$0.27 \pm 0.01$	$1.16 \pm 0.02$	$83.4 \pm 1.0$

an arbitrary reference energy scale, the up- and down-type quarks exhibit strong mass hierarchies (i.e.,  $m_u \ll m_c \ll m_t$  and  $m_d \ll m_s \ll m_b$ ), respectively. This observation implies that it makes sense to consider the rank-one ‘‘hierarchy’’ basis

$$M_u^{(\text{H})} = C_u \begin{pmatrix} 0 & 0 & 0 \\ 0 & 0 & 0 \\ 0 & 0 & 1 \end{pmatrix}, \quad M_d^{(\text{H})} = C_d \begin{pmatrix} 0 & 0 & 0 \\ 0 & 0 & 0 \\ 0 & 0 & 1 \end{pmatrix}, \quad (73)$$

and the corresponding ‘‘democracy’’ basis

$$M_u^{(\text{D})} = \frac{C_u}{3} \begin{pmatrix} 1 & 1 & 1 \\ 1 & 1 & 1 \\ 1 & 1 & 1 \end{pmatrix}, \quad M_d^{(\text{D})} = \frac{C_d}{3} \begin{pmatrix} 1 & 1 & 1 \\ 1 & 1 & 1 \\ 1 & 1 & 1 \end{pmatrix}, \quad (74)$$

where  $C_u = m_t$  and  $C_d = m_b$ . Why the charged leptons and quarks of the same electric charge have strongly hierarchical mass spectra as illustrated by Fig. 2? Such a flavor hierarchy problem has not been satisfactorily solved in particle physics.

### 3.2. The CKM quark flavor mixing parameters

#### 3.2.1. Determination of the CKM matrix elements

The  $3 \times 3$  CKM quark flavor mixing matrix  $V$  defined in Eq. (1) can be explicitly expressed as

$$V = \begin{pmatrix} V_{ud} & V_{us} & V_{ub} \\ V_{cd} & V_{cs} & V_{cb} \\ V_{td} & V_{ts} & V_{tb} \end{pmatrix}. \quad (75)$$

Since  $V$  is exactly unitary in the SM, its nine matrix elements satisfy the following normalization and orthogonality conditions:

$$\sum_{\alpha} (V_{\alpha i}^* V_{\alpha j}) = \delta_{ij}, \quad \sum_i (V_{\alpha i}^* V_{\beta i}) = \delta_{\alpha\beta}, \quad (76)$$

where the Greek and Latin subscripts run over the up-type quarks ( $u, c, t$ ) and the down-type quarks ( $d, s, b$ ), respectively. The constraints in Eq. (76) are so strong that one may make use of four independent parameters to fully describe the CKM matrix  $V$ . From an experimental point of view, however, all the elements of  $V$  should better be independently measured so as to test its unitarity as accurately as possible.

The nine CKM matrix elements  $|V_{\alpha i}|$  (for  $\alpha = u, c, t$  and  $i = d, s, b$ ) have been directly measured in numerous high-precision quark-flavor experiments with the help of proper theoretical inputs. For the sake of simplicity, here we follow the Particle Data Group's recommendations to list the updated central values and error bars of  $|V_{\alpha i}|$  and go over the main quark-flavor-changing channels used to extract such numerical results [19].

- $|V_{ud}| = 0.97420 \pm 0.00021$ . This element has been determined to the highest degree of accuracy from the study of superallowed  $0^+ \rightarrow 0^+$  nuclear  $\beta$  decays [306], and its uncertainties mainly stem from the nuclear Coulomb distortions and radiative corrections. A precise measurement of the decay mode  $\pi^+ \rightarrow \pi^0 + e^+ + \nu_e$  allows one to determine  $|V_{ud}|$  without involving any uncertainties from the nuclear structures, and in this way an impressive result  $|V_{ud}| = 0.9728 \pm 0.0030$  has been achieved from the PIBETA experiment [307].
- $|V_{us}| = 0.2243 \pm 0.0005$ . This element is determined from measuring some semileptonic  $K$ -meson decays, such as  $K^+ \rightarrow \pi^0 + e^+ + \nu_e$  and  $K^- \rightarrow \pi^0 + \mu^- + \bar{\nu}_\mu$ , where the main uncertainties are associated with the relevant form factors. Another way to determine  $|V_{us}|$  is to measure leptonic decays of  $K^\pm$  and  $\pi^\pm$  mesons, such as  $K^+ \rightarrow \mu^+ + \nu_\mu$  and  $\pi^- \rightarrow \mu^- + \bar{\nu}_\mu$ . The point is that  $|V_{us}|/|V_{ud}|$  can be extracted from the ratio of these two decay rates, in which the ratio of the decay constants  $f_K/f_\pi$  can be reliably evaluated by means of lattice QCD.
- $|V_{cd}| = 0.218 \pm 0.004$ . This element can similarly be extracted from some semileptonic and leptonic decays of  $D$  mesons, such as  $D^0 \rightarrow \pi^- + \mu^+ + \nu_\mu$  and  $D^+ \rightarrow \mu^+ + \nu_\mu$ , in which the relevant form factors and decay constants are determined with the help of lattice QCD. Although both  $|V_{cd}|$  and  $|V_{us}|$  will be reduced to  $\sin \vartheta_C$  in the two-flavor quark-mixing approximation, the experimental and theoretical uncertainties associated with the value of  $|V_{cd}|$  are much larger than those associated with the value of  $|V_{us}|$ .
- $|V_{cs}| = 0.997 \pm 0.017$ . This element is geometrically located at the center of the  $3 \times 3$  CKM matrix  $V$ , and it can be determined by measuring leptonic  $D_s$  decays and semileptonic  $D$  decays (e.g.,  $D_s^+ \rightarrow \mu^+ + \nu_\mu$ ,  $D_s^+ \rightarrow \tau^+ + \nu_\tau$  and  $D^0 \rightarrow K^- + e^+ + \nu_e$ ) with the help of lattice QCD calculations in evaluating the relevant decay constants and form factors. In comparison with  $|V_{ud}|$ , the value of  $|V_{cs}|$  involves much larger uncertainties.
- $|V_{cb}| = 0.0422 \pm 0.0008$ . This element has been determined from precision measurements of the inclusive and exclusive semileptonic decays of  $B$  mesons to  $D$  mesons, such as  $B_d^0 \rightarrow D^{*-} + \mu^+ + \nu_\mu$  and  $B_u^- \rightarrow D^0 + e^- + \bar{\nu}_e$ , where the relevant hadronic matrix elements are evaluated by means of the heavy-quark effective theory. Historically, the smallness of  $|V_{cb}|$  as compared with  $|V_{us}|$  and  $|V_{cd}|$  motivated Lincoln Wolfenstein to propose a novel parametrization of  $V$  which properly reflects its hierarchical structure [128].

- $|V_{ub}| = 0.00394 \pm 0.00036$ . This element is the smallest one among the nine elements of the CKM matrix  $V$ , and it can be extracted from measuring the charmless semileptonic  $B$ -meson decays (e.g.,  $B_d^0 \rightarrow \pi^- + \mu^+ + \nu_\mu$ ). It is also possible to determine  $|V_{ub}|$  from leptonic  $B$  decays, such as  $B_u^+ \rightarrow \tau^+ + \nu_\tau$ . In this connection lattice QCD and light-cone QCD sum rules are useful techniques to help evaluate the relevant form factors and decay constants. The recent LHCb measurement of the ratio of the rates of  $\Lambda_b \rightarrow p^+ + \mu^- + \bar{\nu}_\mu$  and  $\Lambda_b \rightarrow \Lambda_c^+ + \mu^- + \bar{\nu}_\mu$  decays allows one to directly extract  $|V_{ub}/V_{cb}| = 0.083 \pm 0.006$  [308], a remarkable result in good agreement with the separate measurements of  $|V_{ub}|$  and  $|V_{cb}|$ . In addition, it is worth pointing out that  $|V_{ub}|/|V_{cb}| \simeq \sqrt{m_u/m_c}$  has been predicted in a class of quark mass matrices (see, e.g., Refs. [135, 309] and section 6). Although this simple relation is not in good agreement with current experimental data, it remains quite instructive and suggestive for further attempts of model building in this connection.
- $|V_{td}| = 0.0081 \pm 0.0005$ . This element is unlikely to be precisely determined from the top-quark decay modes, and hence it is usually extracted from the top-mediated box diagrams of  $B_d^0$ - $\bar{B}_d^0$  mixing and from the loop-mediated rare decays of  $B$  and  $K$  mesons (e.g.,  $B_u^+ \rightarrow \rho^+ + \gamma$  and  $K^+ \rightarrow \pi^+ + \nu_\mu + \bar{\nu}_\mu$ ). The relevant hadronic matrix elements can be evaluated with the help of lattice QCD, but the theoretical uncertainties remain quite large.
- $|V_{ts}| = 0.0394 \pm 0.0023$ . This element can similarly be extracted from the top-mediated box diagrams of  $B_s^0$ - $\bar{B}_s^0$  mixing and from the loop-mediated rare decays of  $B$  and  $K$  mesons, such as  $B_s^0 \rightarrow \mu^+ + \mu^-$ ,  $B_d^0 \rightarrow K^{*0} + \gamma$  and  $K^+ \rightarrow \pi^+ + \nu_\mu + \bar{\nu}_\mu$ . It involves less theoretical uncertainties to determine  $|V_{td}/V_{ts}|$  from the ratio of  $\Delta m_d$  to  $\Delta m_s$ , where  $\Delta m_q$  denotes the mass difference between the heavy and light mass eigenstates of  $B_q^0$  and  $\bar{B}_q^0$  mesons (for  $q = d$  and  $s$ ). The numerical result  $|V_{td}/V_{ts}| = 0.210 \pm 0.008$  [19] is consistent very well with the value of  $\sqrt{m_d/m_s}$  for a number of quark mass textures in the  $m_t \rightarrow \infty$  limit [275].
- $|V_{tb}| = 1.019 \pm 0.025$ . This element is the largest one among the nine elements of the CKM matrix  $V$ , and it can be directly determined from the cross section of the single top-quark production if the unitarity of  $V$  is not assumed. But for the time being this approach unavoidably involves large experimental and theoretical uncertainties. The value of  $|V_{tb}|$  given above is an average of the CDF and D0 measurements at the Tevatron and the ATLAS and CMS measurements at the LHC.

Note that the CKM matrix elements  $|V_{ai}|$  have been treated as constants below the energy scale  $\mu = M_W$ , although they are scale-dependent and evolve appreciably through the RGEs [310, 311, 312, 313, 314, 315, 316] when  $\mu$  is far above the electroweak scale. Given the above values of  $|V_{ai}|$  extracted from those independent measurements, one may test the normalization conditions of  $V$  to a great extent [19]. For example,

$$\begin{aligned}
|V_{ud}|^2 + |V_{us}|^2 + |V_{ub}|^2 &= 0.9994 \pm 0.0005, \\
|V_{cd}|^2 + |V_{cs}|^2 + |V_{cb}|^2 &= 1.043 \pm 0.034, \\
|V_{ud}|^2 + |V_{cd}|^2 + |V_{td}|^2 &= 0.9967 \pm 0.0018, \\
|V_{us}|^2 + |V_{cs}|^2 + |V_{ts}|^2 &= 1.046 \pm 0.034.
\end{aligned} \tag{77}$$

Once the direct measurement of  $|V_{tb}|$  is further improved in the future precision experiments, the unitarity of  $V$  will be tested to a much better degree of accuracy.

### 3.2.2. The Wolfenstein parameters and CP violation

Now that the off-diagonal elements of the CKM matrix  $V$  exhibit a clear hierarchy, one may consider to expand them by using a small parameter. Here let us parametrize  $V$  in terms of the popular Wolfenstein parameters [128]:

$$V_{us} = \lambda, \quad V_{cb} = A\lambda^2, \quad V_{ub} = A\lambda^3(\rho - i\eta), \quad (78)$$

where  $\lambda \simeq \sin \vartheta_C \simeq 0.2$  serves as the series expansion parameter. In such a phase convention the other six matrix elements of  $V$  can be exactly figured out with the help of Eq. (76) [317], but in most cases it is more useful to take advantage of an approximate expression of  $V$ . Up to the accuracy of  $\mathcal{O}(\lambda^6)$ , we obtain [318, 319, 320]

$$V = \begin{pmatrix} 1 - \frac{1}{2}\lambda^2 & \lambda & A\lambda^3(\rho - i\eta) \\ -\lambda & 1 - \frac{1}{2}\lambda^2 & A\lambda^2 \\ A\lambda^3(1 - \rho - i\eta) & -A\lambda^2 & 1 \end{pmatrix} + \frac{1}{2}\lambda^4 \begin{pmatrix} -\frac{1}{4} & 0 & 0 \\ A^2\lambda[1 - 2(\rho + i\eta)] & -\frac{1}{4}(1 + 4A^2) & 0 \\ A\lambda(\rho + i\eta) & A[1 - 2(\rho + i\eta)] & -A^2 \end{pmatrix} + \mathcal{O}(\lambda^6). \quad (79)$$

Then it is straightforward to find that  $1 - V_{tb} \simeq V_{ud} - V_{cs} \simeq A^2\lambda^4/2$  holds, and so on. One may therefore arrive at  $|V_{tb}| > |V_{ud}| > |V_{cs}|$  as a parametrization-independent result. Moreover [320],

$$\begin{aligned} |V_{us}|^2 - |V_{cd}|^2 &= |V_{cb}|^2 - |V_{ts}|^2 = |V_{td}|^2 - |V_{ub}|^2 \simeq A^2\lambda^6(1 - 2\rho), \\ |V_{us}|^2 - |V_{cb}|^2 &= |V_{cd}|^2 - |V_{ts}|^2 = |V_{tb}|^2 - |V_{ud}|^2 \simeq \lambda^2(1 - A^2\lambda^2), \end{aligned} \quad (80)$$

as a consequence of Eq. (76), and thus we are left with the inequalities  $|V_{us}| > |V_{cd}|$ ,  $|V_{cb}| > |V_{ts}|$  and  $|V_{td}| > |V_{ub}|$  if  $\rho < 0.5$  is constrained. Such fine structures of the CKM matrix  $V$  will be tested once its nine elements are determined to a sufficiently high degree of accuracy.

When CP violation is concerned in the precision measurements of various  $B$ -meson decays, it proves to be very convenient to introduce two modified Wolfenstein parameters which are independent of the phase convention of the CKM matrix  $V$  [318]:

$$\bar{\rho} + i\bar{\eta} = -\frac{V_{ub}^* V_{ud}}{V_{cb}^* V_{cd}} \simeq (\rho + i\eta) \left(1 - \frac{1}{2}\lambda^2\right). \quad (81)$$

In the complex plane the parameters  $(\bar{\rho}, \bar{\eta})$  describe the vertex of the *rescaled* CKM unitarity triangle corresponding to the orthogonality relation  $V_{ub}^* V_{ud} + V_{cb}^* V_{cd} + V_{tb}^* V_{td} = 0$ , as illustrated in

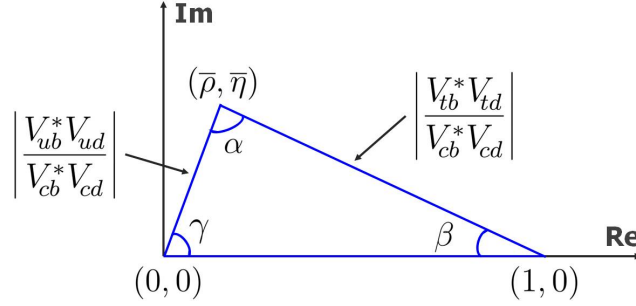

Figure 10: The rescaled CKM unitarity triangle defined by the orthogonality relation  $V_{ub}^* V_{ud} + V_{cb}^* V_{cd} + V_{tb}^* V_{td} = 0$  in the complex plane, where the vertex parameters  $(\bar{\rho}, \bar{\eta})$  are expressed in Eq. (81).

Fig. 10. The three inner angles of this triangle, defined as

$$\begin{aligned}
\alpha &\equiv \arg\left(-\frac{V_{tb}^* V_{td}}{V_{ub}^* V_{ud}}\right) \simeq \arctan\left[\frac{\eta}{\eta^2 - \rho(1 - \rho)}\right], \\
\beta &\equiv \arg\left(-\frac{V_{cb}^* V_{cd}}{V_{tb}^* V_{td}}\right) \simeq \arctan\left(\frac{\eta}{1 - \rho}\right), \\
\gamma &\equiv \arg\left(-\frac{V_{ub}^* V_{ud}}{V_{cb}^* V_{cd}}\right) \simeq \arctan\left(\frac{\eta}{\rho}\right),
\end{aligned} \tag{82}$$

have been measured in a number of CP-violating  $B$ -meson decays. Among them, the angle  $\beta$  has been most precisely determined from the BaBar [321], Belle [322] and LHCb [323] measurements of CP violation in the  $B^0 \rightarrow \bar{B}^0 \rightarrow J/\psi + K_S$  decay mode and related processes, and its world-average result is  $\sin 2\beta = 0.691 \pm 0.017$  [324]. The angle  $\alpha$  can be extracted from CP violation in some charmless  $B$ -meson decays, such as  $B \rightarrow \pi + \pi$ ,  $\rho + \pi$  and  $\rho + \rho$ , and its world-average value is  $\alpha = 84.5_{-5.2}^{+5.9}$  [19]. In addition, the result  $\gamma = 73.5_{-5.1}^{+4.2}$  has been obtained from the interference between two different tree-level amplitudes of some  $B$ -meson decays [19], such as  $B_u^+ \rightarrow D^0 + K^-$  and  $B_u^- \rightarrow \bar{D}^0 + K^-$  with  $D^0$  and  $\bar{D}^0$  decaying to the same final state.

A global analysis of currently available experimental data allows one to determine the Wolfenstein parameters as follows [19]:

$$\lambda = 0.22453 \pm 0.00044, \quad A = 0.836 \pm 0.015, \quad \bar{\rho} = 0.122_{-0.017}^{+0.018}, \quad \bar{\eta} = 0.355_{-0.011}^{+0.012}, \tag{83}$$

where the methodology developed by the CKMfitter Group [319] has been used. If one makes use of the analysis techniques advocated by the UTfit Collaboration [325], the values of the four Wolfenstein parameters will be slightly different from those listed in Eq. (83). Using the same global fit to constrain the nine elements of  $V$ , one obtains the central values and error bars of  $|V_{ai}|$  (for  $\alpha = u, c, t$  and  $i = d, s, b$ ) as listed in Table 8. It is obvious that these numerical results are more accurate and satisfy the expectations about the relative magnitudes of  $|V_{ai}|$  as indicated by Eq. (79), namely  $|V_{ub}| < |V_{td}| \ll |V_{ts}| < |V_{cb}| \ll |V_{cd}| < |V_{us}| \ll |V_{cs}| < |V_{ud}| < |V_{tb}|$ , simply because the unitarity requirement of  $V$  has been taken into account in the global fit.



Table 8: The central values and error bars of the CKM quark flavor mixing matrix elements  $|V_{\alpha i}|$  (for  $\alpha = u, c, t$  and  $i = d, s, b$ ) obtained from a global fit of the relevant experimental data and recommended by the Particle Data Group [19], where the unitarity of  $V$  is already implied.

	$d$	$s$	$b$
$u$	$0.97446 \pm 0.00010$	$0.22452 \pm 0.00044$	$0.00365 \pm 0.00012$
$c$	$0.22438 \pm 0.00044$	$0.97359 \pm 0.00011$	$0.04214 \pm 0.00076$
$t$	$0.00896 \pm 0.00024$	$0.04133 \pm 0.00074$	$0.999105 \pm 0.000032$

### 3.3. Constraints on the neutrino masses

#### 3.3.1. Some basics of neutrino oscillations

The *flavor* oscillation of massive neutrinos travelling in space, a spontaneous periodic change from one neutrino flavor  $\nu_\alpha$  to another  $\nu_\beta$  (for  $\alpha, \beta = e, \mu, \tau$ ), is a striking quantum phenomenon sensitive to the tiny neutrino mass-squared differences. In a realistic oscillation experiment the neutrino (or antineutrino) beam is produced at the source and measured at the detector via the weak charged-current interactions described by Eq. (1), where each neutrino flavor eigenstate  $\nu_\alpha$  can be expressed as a superposition of the three neutrino mass eigenstates  $\nu_i$  (for  $i = 1, 2, 3$ ). The latter travel as matter waves and may interfere with one another after they travel a distance and develop different phases due to their different masses  $m_i$ .

To be explicit, Eq. (1) tells us that a  $\nu_\alpha$  is produced from the  $W^+ + \alpha^- \rightarrow \nu_\alpha$  interactions, and a  $\nu_\beta$  is detected by means of the  $\nu_\beta \rightarrow W^+ + \beta^-$  interactions. The  $\nu_\alpha \rightarrow \nu_\beta$  flavor oscillation may take place after the  $\nu_i$  beam with an average energy  $E \gg m_i$  travels a proper distance  $L$  in vacuum. If the plane-wave expansion approximation is made, the amplitude of the  $\nu_\alpha \rightarrow \nu_\beta$  oscillation can simply be expressed as [326]

$$\begin{aligned}
 A(\nu_\alpha \rightarrow \nu_\beta) &= \sum_i [A(W^+ + \alpha^- \rightarrow \nu_i) \cdot \text{Propagation}(\nu_i) \cdot A(\nu_i \rightarrow W^+ + \beta^-)] \\
 &= \sum_i \left[ U_{\alpha i}^* \exp\left(-i \frac{m_i^2 L}{2E}\right) U_{\beta i} \right], \tag{84}
 \end{aligned}$$

where  $A(W^+ + \alpha^- \rightarrow \nu_i) = U_{\alpha i}^*$  and  $A(\nu_i \rightarrow W^+ + \beta^-) = U_{\beta i}$  describe the production of  $\nu_\alpha$  at the source and the detection of  $\nu_\beta$  at the detector, respectively. With the help of the unitarity of the PMNS lepton flavor mixing matrix  $U$ , the probability of  $\nu_\alpha \rightarrow \nu_\beta$  oscillations turns out to be

$$\begin{aligned}
 P(\nu_\alpha \rightarrow \nu_\beta) \equiv |A(\nu_\alpha \rightarrow \nu_\beta)|^2 &= \delta_{\alpha\beta} - 4 \sum_{i < j} \left[ \text{Re}(U_{\alpha i} U_{\beta j} U_{\alpha j}^* U_{\beta i}^*) \sin^2 \frac{\Delta m_{ji}^2 L}{4E} \right] \\
 &\quad + 2 \sum_{i < j} \left[ \text{Im}(U_{\alpha i} U_{\beta j} U_{\alpha j}^* U_{\beta i}^*) \sin \frac{\Delta m_{ji}^2 L}{2E} \right], \tag{85}
 \end{aligned}$$

where  $\Delta m_{ji}^2 \equiv m_j^2 - m_i^2$  (for  $i, j = 1, 2, 3$ ) are the neutrino mass-squared differences and satisfy  $\Delta m_{31}^2 - \Delta m_{32}^2 = \Delta m_{21}^2$ . The probability of  $\bar{\nu}_\alpha \rightarrow \bar{\nu}_\beta$  oscillations can easily be read off from Eq. (85)

by making the replacement  $U \rightarrow U^*$ . It is clear that only the neutrino mass-squared differences  $\Delta m_{ji}^2$  are observable in a neutrino-neutrino or antineutrino-antineutrino oscillation experiment<sup>16</sup>. Of course, Eq. (85) will get modified when neutrino (or antineutrino) oscillations happen in a dense-matter environment [83, 84], but the latter does not change the conclusion that the oscillations are in general only sensitive to six fundamental flavor parameters: two independent neutrino mass-squared differences (say,  $\Delta m_{21}^2$  and  $\Delta m_{31}^2$ ), three flavor mixing angles ( $\theta_{12}$ ,  $\theta_{13}$  and  $\theta_{23}$ ) and one CP-violating phase ( $\delta_\nu$ ). If the parametrization of  $U$  in Eq. (2) is substituted into Eq. (85), one will see that the two Majorana phases ( $\rho$  and  $\sigma$ ) are cancelled in  $P(\nu_\alpha \rightarrow \nu_\beta)$ . That is why these two phases can only be determined or constrained by detecting those lepton-number-violating processes, such as the  $0\nu 2\beta$  decays and neutrino-antineutrino oscillations.

When a neutrino beam propagates through a medium, the three neutrino flavors may interact with the electrons in the atoms and the quarks in the nucleons via both elastic and inelastic scattering reactions. The inelastic scattering and the elastic scattering off the forward direction will cause attenuation of the neutrino beam, but their cross sections are so tiny that the resulting attenuation effects are negligibly small in most cases. The elastic coherent forward scattering of the neutrinos with matter matters, because it will modify the vacuum behavior of neutrino oscillations. This kind of modification, which depends on the neutrino flavors and is CP-asymmetric between neutrinos and antineutrinos, is just the well-known MSW matter effect [83, 84]. In this case the effective Hamiltonian responsible for the evolution of three neutrino flavors in a medium consists of the vacuum term and a matter potential:

$$\mathcal{H}_m \equiv \frac{1}{2E} \bar{U} \begin{pmatrix} \bar{m}_1^2 & 0 & 0 \\ 0 & \bar{m}_2^2 & 0 \\ 0 & 0 & \bar{m}_3^2 \end{pmatrix} \bar{U}^\dagger = \frac{1}{2E} U \begin{pmatrix} m_1^2 & 0 & 0 \\ 0 & m_2^2 & 0 \\ 0 & 0 & m_3^2 \end{pmatrix} U^\dagger + \begin{pmatrix} V_{cc} + V_{nc} & 0 & 0 \\ 0 & V_{nc} & 0 \\ 0 & 0 & V_{nc} \end{pmatrix}, \quad (86)$$

where  $\bar{m}_i$  (for  $i = 1, 2, 3$ ) and  $\bar{U}$  stand respectively for the effective neutrino masses and flavor mixing matrix in matter, and the weak charged-current (cc) contribution from forward  $\nu_e$ - $e$  scattering and the weak neutral-current (nc) contribution from forward  $\nu_\alpha$ - $e$ ,  $\nu_\alpha$ - $p$  or  $\nu_\alpha$ - $n$  scattering (for  $\alpha = e, \mu, \tau$ ) to the matter potential are given by [83, 334, 335, 336, 337]

$$\begin{aligned} V_{cc} &= +\sqrt{2} G_F N_e, \\ V_{nc}^e &= -\frac{1}{\sqrt{2}} G_F N_e (1 - 4 \sin^2 \theta_w), \\ V_{nc}^p &= +\frac{1}{\sqrt{2}} G_F N_p (1 - 4 \sin^2 \theta_w), \\ V_{nc}^n &= -\frac{1}{\sqrt{2}} G_F N_n, \end{aligned} \quad (87)$$

where  $N_e$ ,  $N_p$  and  $N_n$  denote the number densities of electrons, protons and neutrons in matter. Given the fact of  $N_e = N_p$  for a normal (electrically neutral) medium, we are actually left with

<sup>16</sup>Note that the absolute neutrino mass terms can in principle show up in the probabilities of neutrino-antineutrino oscillations [73, 327, 328, 329, 330, 331, 332, 333] if massive neutrinos are the Majorana particles. But such lepton-number-violating processes are formidably suppressed by the tiny factors  $m_i^2/E^2$  in their probabilities, and thus there is no way to measure them in any realistic experiments.

$V_{\text{nc}} = V_{\text{nc}}^e + V_{\text{nc}}^p + V_{\text{nc}}^n = V_{\text{nc}}^n$ . Since this term is universal for the three neutrino flavors, it does not modify the behaviors of neutrino oscillations and hence can be neglected in the standard case <sup>17</sup>. The explicit relations between the effective quantities in matter ( $\tilde{m}_i$  and  $\tilde{U}$ ) and their counterparts in vacuum ( $m_i$  and  $U$ ) will be established in section 4.4. Here we just quote the simpler but more instructive results in the two-flavor framework with a single neutrino mass-squared difference  $\Delta m^2$  and a single flavor mixing angle  $\theta$  [83]:

$$\begin{aligned}\Delta\tilde{m}^2 &= \Delta m^2 \sqrt{(\cos 2\theta - r_m)^2 + \sin^2 2\theta}, \\ \tan 2\tilde{\theta} &= \frac{\sin 2\theta}{\cos 2\theta - r_m},\end{aligned}\tag{88}$$

where  $r_m = 2\sqrt{2} G_{\text{F}} N_e E / \Delta m^2$  is a dimensionless parameter measuring the strength of the matter potential, and the adiabatic approximation has been made [338]. Then the probabilities of two-flavor neutrino oscillations in matter can be expressed in the same way as those in vacuum:

$$\begin{aligned}\tilde{P}(v_\alpha \rightarrow v_\alpha) &= 1 - \sin^2 2\tilde{\theta} \sin^2 \frac{\Delta\tilde{m}^2 L}{4E}, \\ \tilde{P}(v_\alpha \rightarrow v_\beta) &= \sin^2 2\tilde{\theta} \sin^2 \frac{\Delta\tilde{m}^2 L}{4E},\end{aligned}\tag{89}$$

with  $\alpha \neq \beta$ . Eq. (88) tells us that there are two extremes for matter effects on neutrino oscillations:

- If  $r_m \rightarrow \cos 2\theta$  for proper values of  $E$  and  $N_e$ , then one has  $\tilde{\theta} \rightarrow \pi/4$  and  $\Delta\tilde{m}^2 \rightarrow \Delta m^2 \sin 2\theta$  no matter how small the genuine flavor mixing angle  $\theta$  in the first quadrant is. This matter-induced enhancement is known as the MSW resonance.
- If  $r_m \rightarrow \infty$  due to  $N_e \rightarrow \infty$  in dense matter, then  $\tilde{\theta} \rightarrow \pi/2$  and  $\Delta\tilde{m}^2 \rightarrow 2\sqrt{2} G_{\text{F}} N_e E \rightarrow \infty$  no matter what the initial values of  $\Delta m^2$  and  $\theta$  are. In this case quantum coherence gets lost, and hence there will be no neutrino oscillations.

Note that all the matter potential terms in Eq. (87) take the opposite signs when an antineutrino beam propagating in a medium is concerned. This means  $r_m \rightarrow -r_m$  in Eqs. (88) and (89) for two-flavor antineutrino oscillations in matter. That is why matter effects are CP-asymmetric for neutrino and antineutrino oscillations, and they might even result in a fake signal of CP or CPT violation in a realistic long-baseline oscillation experiment [339, 340].

### 3.3.2. Neutrino mass-squared differences

As listed in Table 2, a number of successful neutrino (antineutrino) oscillation experiments have been done, and they are sensitive to  $\Delta m_{21}^2$  and  $\Delta m_{31}^2$  in different ways. For example, solar <sup>8</sup>B-type  $\nu_e \rightarrow \nu_e$  oscillations with the MSW matter effects and medium-baseline reactor  $\bar{\nu}_e \rightarrow \bar{\nu}_e$

<sup>17</sup>However, this term should be taken into account when the three active neutrinos are slightly mixed with some new degrees of freedom (e.g., heavy or light sterile neutrinos) no matter whether the latter can directly take part in neutrino oscillations or not [122, 181].

Table 9: The neutrino mass-squared differences from a global analysis of current neutrino oscillation data, where the notations  $\delta m^2 \equiv \Delta m_{21}^2$  and  $\Delta m^2 \equiv m_3^2 - (m_1^2 + m_2^2)/2 = (\Delta m_{31}^2 + \Delta m_{32}^2)/2$  are used in Ref. [92], or  $\Delta m_{3i}^2 \equiv \Delta m_{31}^2 > 0$  for the normal mass ordering and  $\Delta m_{3i}^2 \equiv \Delta m_{32}^2 < 0$  for the inverted mass ordering are defined in Ref. [93].

	Normal mass ordering ( $m_1 < m_2 < m_3$ )			Inverted mass ordering ( $m_3 < m_1 < m_2$ )		
Capozzi <i>et al</i> [92]	Best fit	$1\sigma$ range	$3\sigma$ range	Best fit	$1\sigma$ range	$3\sigma$ range
$\delta m^2/10^{-5} \text{ eV}^2$	7.34	7.20 $\rightarrow$ 7.51	6.92 $\rightarrow$ 7.91	7.34	7.20 $\rightarrow$ 7.51	6.92 $\rightarrow$ 7.91
$ \Delta m^2 /10^{-3} \text{ eV}^2$	2.455	2.423 $\rightarrow$ 2.490	2.355 $\rightarrow$ 2.557	2.441	2.406 $\rightarrow$ 2.474	2.338 $\rightarrow$ 2.540
Esteban <i>et al</i> [93]	Best fit	$1\sigma$ range	$3\sigma$ range	Best fit	$1\sigma$ range	$3\sigma$ range
$\Delta m_{21}^2/10^{-5} \text{ eV}^2$	7.39	7.19 $\rightarrow$ 7.60	6.79 $\rightarrow$ 8.01	7.39	7.19 $\rightarrow$ 7.60	6.79 $\rightarrow$ 8.01
$ \Delta m_{3i}^2 /10^{-3} \text{ eV}^2$	2.525	2.494 $\rightarrow$ 2.558	2.431 $\rightarrow$ 2.622	2.512	2.481 $\rightarrow$ 2.546	2.413 $\rightarrow$ 2.606

oscillations are mainly sensitive to  $\Delta m_{21}^2$ ; while atmospheric  $\nu_\mu \rightarrow \nu_\mu$  and  $\bar{\nu}_\mu \rightarrow \bar{\nu}_\mu$  oscillations, short-baseline reactor  $\bar{\nu}_e \rightarrow \bar{\nu}_e$  oscillations and long-baseline accelerator  $\nu_\mu \rightarrow \nu_e$ ,  $\nu_\mu \rightarrow \nu_\mu$  and  $\nu_\mu \rightarrow \nu_\tau$  oscillations are primarily sensitive to  $\Delta m_{31}^2$  and  $\Delta m_{32}^2$  [341]. Given the convention of  $|U_{e1}| > |U_{e2}|$  or equivalently  $\cos \theta_{12} > \sin \theta_{12}$  [342]<sup>18</sup>, a global analysis of currently available neutrino (antineutrino) oscillation data has led us to Table 9 [92, 93], from which one can observe two possibilities for the neutrino mass spectrum:

- Normal ordering  $m_1 < m_2 < m_3$ , corresponding to  $\Delta m_{21}^2 > 0$  and  $\Delta m_{31}^2 \simeq \Delta m_{32}^2 > 0$ ;
- Inverted ordering  $m_3 < m_1 < m_2$ , corresponding to  $\Delta m_{21}^2 > 0$  and  $\Delta m_{31}^2 \simeq \Delta m_{32}^2 < 0$ ,

as schematically illustrated in Fig. 11. But the analyses made in Refs. [92, 93] have indicated that the normal neutrino mass ordering is favored over the inverted one at the  $3\sigma$  level, and whether such a preliminary result is true or not will be clarified by more precise atmospheric, reactor and accelerator neutrino (or antineutrino) oscillation experiments in the near future.

The unique reactor antineutrino oscillation experiment capable of probing the neutrino mass ordering will be the JUNO experiment with a 20-kiloton liquid-scintillator detector located in the Jiangmen city of Guangdong province in southern China, about 55 km away from the Yangjiang (17.4 GW<sub>th</sub>) and Taishan (18.4 GW<sub>th</sub>) reactor facilities which serve as the sources of electron antineutrinos [343]. It is aimed to measure the fine structure caused by  $\Delta m_{31}^2$  and  $\Delta m_{32}^2$  in the energy spectrum of reactor  $\bar{\nu}_e \rightarrow \bar{\nu}_e$  oscillations driven by  $\Delta m_{21}^2$  [344, 345, 346, 347, 348, 349]. To see this point in a more transparent way, let us start from the master formula given in Eq. (85) and

<sup>18</sup>This convention is equivalent to restricting  $\theta_{12}$  to the first octant (i.e.,  $0 \leq \theta_{12} \leq \pi/4$ ), as all the three flavor mixing angles are required to lie in the first quadrant for the standard parametrization of  $U$  in Eq. (2). In this case Eq. (88) tells us that a significant matter-induced enhancement can take place for solar  $\nu_e \rightarrow \nu_e$  oscillations if  $r_m > 0$  holds, by which the corresponding neutrino mass-squared difference  $\Delta m_{21}^2$  must be positive.

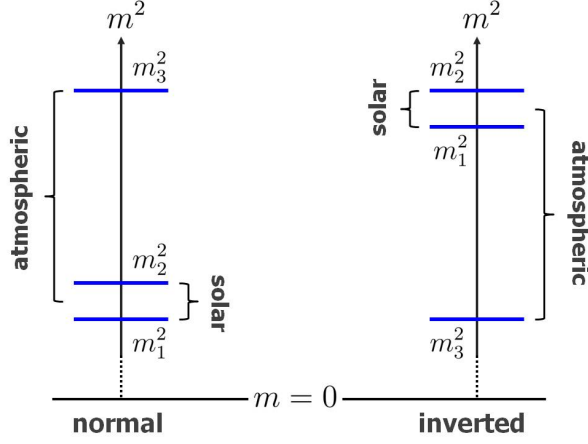

Figure 11: A schematic illustration of the normal or inverted neutrino mass ordering, where the smaller and larger mass-squared differences (i.e.,  $\delta m^2 \equiv m_2^2 - m_1^2 \simeq 7.3 \times 10^{-5} \text{ eV}^2$  and  $|\Delta m^2| \equiv |m_3^2 - (m_1^2 + m_2^2)/2| \simeq 2.4 \times 10^{-3} \text{ eV}^2$  [92]) are responsible for the dominant oscillations of solar and atmospheric neutrinos, respectively.

express the oscillation probability  $P(\bar{\nu}_e \rightarrow \bar{\nu}_e)$  as follows [350]:

$$\begin{aligned}
P(\bar{\nu}_e \rightarrow \bar{\nu}_e) &= 1 - 4 \left[ |U_{e1}|^2 |U_{e2}|^2 \sin^2 \frac{\Delta m_{21}^2 L}{4E} + |U_{e1}|^2 |U_{e3}|^2 \sin^2 \frac{\Delta m_{31}^2 L}{4E} + |U_{e2}|^2 |U_{e3}|^2 \sin^2 \frac{\Delta m_{32}^2 L}{4E} \right] \\
&= 1 - \sin^2 2\theta_{12} \cos^4 \theta_{13} \sin^2 \frac{\Delta m_{21}^2 L}{4E} - \frac{1}{2} \sin^2 2\theta_{13} \left( \sin^2 \frac{\Delta m_{31}^2 L}{4E} + \sin^2 \frac{\Delta m_{32}^2 L}{4E} \right) \\
&\quad - \frac{1}{2} \cos 2\theta_{12} \sin^2 2\theta_{13} \sin \frac{\Delta m_{21}^2 L}{4E} \sin \frac{(\Delta m_{31}^2 + \Delta m_{32}^2) L}{4E}, \tag{90}
\end{aligned}$$

in which the standard parametrization of  $U$  has been taken. The last oscillatory term in the above equation describes the fine interference effect [341, 345, 351, 352, 353, 354], simply because it is proportional to  $\sin[(\Delta m_{31}^2 + \Delta m_{32}^2)L/(4E)]$  and thus sensitive to the common (unknown) sign of  $\Delta m_{31}^2$  and  $\Delta m_{32}^2$ . It is this term that may cause a fine structure in the primary energy spectrum of  $P(\bar{\nu}_e \rightarrow \bar{\nu}_e)$  driven by  $\Delta m_{21}^2 L/(4E) \sim \pi/2$ , so the energy resolution of the JUNO detector must be good enough to measure it. Right now both the JUNO experiment's detector building and civil construction are underway, and its data taking is expected to commence in 2021 if everything goes well. After about six years of operation, this experiment will be able to pin down the neutrino mass ordering at the  $4\sigma$  confidence level.

On the other hand, the survival probabilities of atmospheric  $\nu_\mu \rightarrow \nu_\mu$  and  $\bar{\nu}_\mu \rightarrow \bar{\nu}_\mu$  oscillations depend respectively on  $\Delta m_{3i}^2 - 2\sqrt{2} G_F N_e E$  and  $\Delta m_{3i}^2 + 2\sqrt{2} G_F N_e E$  (for  $i = 1, 2$ ), where  $N_e$  denotes the number density of electrons in terrestrial matter and  $E$  is the average neutrino beam energy. Therefore, a resonant flavor conversion may happen at a specific pattern of neutrino energies and Earth-crossing paths. This matter-induced resonant conversion takes place only for neutrinos in the normal mass ordering — similar to the solar neutrino case, or only for antineutrinos in the inverted mass ordering. The proposed Hyper-Kamiokande detector [355], a 260-kiloton underground water Cherenkov detector, should be capable of discriminating the cross sections and kinematics of  $\nu_\mu$

and  $\bar{\nu}_\mu$  interactions with nuclei. So it is capable of identifying different detected event rates which reflect different neutrino mass hierarchies [341]. Note that the Hyper-Kamiokande detector is also the far detector, 295 km away from the J-PARK accelerator in Tokai, for a long-baseline experiment to measure  $\nu_\mu \rightarrow \nu_e$  and  $\bar{\nu}_\mu \rightarrow \bar{\nu}_e$  oscillations. In this case it has a good chance to pin down the neutrino mass ordering with the help of terrestrial matter effects. In comparison, the DUNE experiment [356] is another flagship of the next-generation long-baseline accelerator neutrino oscillation experiment which can also probe the neutrino mass ordering via matter effects in  $\nu_\mu \rightarrow \nu_e$  and  $\bar{\nu}_\mu \rightarrow \bar{\nu}_e$  oscillations. Taking advantage of its 40-kiloton liquid-argon far detector at the Sanford Underground Research Facility, which is 1300 km away from the  $\nu_\mu$  and  $\bar{\nu}_\mu$  sources at the Fermilab, a seven-year operation of the DUNE experiment may hopefully reach the  $5\sigma$  sensitivity to the true neutrino mass ordering for any possible values of  $\delta_\nu$  [357].

### 3.3.3. The absolute neutrino mass scale

Information about the absolute mass scale of three known neutrinos can in principle be achieved from the investigations of their peculiar roles in nuclear physics (e.g., the  $\beta$  decays,  $0\nu 2\beta$  decays, and captures of cosmic relic neutrinos on  $\beta$ -decaying nuclei), in Big Bang cosmology (e.g., the CMB anisotropies, baryon acoustic oscillations (BAOs), and amplitudes of the density fluctuations on small scales from the clustering of galaxies and the Lyman- $\alpha$  forest), in astrophysics and astronomy (e.g., the core-collapse supernovae and ultrahigh-energy cosmic rays) [358]. Here let us briefly summarize some currently available constraints on the neutrino masses from such non-oscillation measurements or observations.

(1) The effective electron-neutrino mass  $\langle m \rangle_e$  in the tritium  $\beta$  decay  ${}^3\text{H} \rightarrow {}^3\text{He} + e^- + \bar{\nu}_e$  with the  $Q$ -value  $Q = 18.6$  keV and the half-life  $T_{1/2} \simeq 12.3$  yr. The energy spectrum of the emitted electrons in this decay mode is described by

$$\frac{dN}{dE} \propto (Q - E) \sum_{i=1}^3 |U_{ei}|^2 \sqrt{(Q - E)^2 - m_i^2} \simeq (Q - E)^2 \left[ 1 - \frac{\langle m \rangle_e^2}{2(Q - E)^2} \right] \quad (91)$$

in the approximation  $Q - E \gg m_i$  [359, 360, 361], where the effective electron-neutrino mass term  $\langle m \rangle_e$  is simply defined as

$$\begin{aligned} \langle m \rangle_e &= \sqrt{m_1^2 |U_{e1}|^2 + m_2^2 |U_{e2}|^2 + m_3^2 |U_{e3}|^2} \\ &= \sqrt{(m_1^2 \cos^2 \theta_{12} + m_2^2 \sin^2 \theta_{12}) \cos^2 \theta_{13} + m_3^2 \sin^2 \theta_{13}}, \end{aligned} \quad (92)$$

which depends on the flavor mixing angles  $\theta_{12}$  and  $\theta_{13}$  in the standard parametrization of the  $3 \times 3$  PMNS matrix  $U$ . The latest experimental upper bound of  $\langle m \rangle_e$  is set by the KATRIN Collaboration:  $\langle m \rangle_e < 1.1$  eV at the 90% confidence level [362]. The final goal of this ‘‘direct measurement’’ experiment is to probe  $\langle m \rangle_e$  with the sensitivity of about 0.2 eV [359].

(2) The effective electron-neutrino mass  $\langle m \rangle_{ee}$  in the lepton-number-violating  $0\nu 2\beta$  decays, such as  ${}^{76}\text{Ge} \rightarrow {}^{76}\text{Se} + 2e^-$  and  ${}^{136}\text{Xe} \rightarrow {}^{136}\text{Ba} + 2e^-$ . The rate of a decay mode of this kind is proportional to  $|\langle m \rangle_{ee}|^2$ , where the expression of  $\langle m \rangle_{ee}$  has been given in Eq. (19) in the standard three-neutrino scheme. One may arrange the phase parameters of the PMNS matrix  $U$  in such a

way that  $U_{e2}$  is real and thus  $\langle m \rangle_{ee}$  can be reexpressed as

$$\langle m \rangle_{ee} = m_1 |U_{e1}|^2 \exp(i\phi_{e1}) + m_2 |U_{e2}|^2 + m_3 |U_{e3}|^2 \exp(i\phi_{e3}), \quad (93)$$

where the phase parameters  $\phi_{e1}$  and  $\phi_{e3}$  may vary in the  $[0, 2\pi)$  range. In the complex plane the above expression corresponds to a quadrangle as schematically illustrated by Fig. 12, where the vector of  $\langle m \rangle_{ee}$  connects two phase-related circles and looks like the ‘‘coupling rod’’ of a locomotive [363]. In the limit  $m_1 \rightarrow 0$  (normal mass ordering) or  $m_3 \rightarrow 0$  (inverted mass ordering), one of the sides vanishes and thus the quadrangle is reduced to a triangle [364]. Depending on the theoretical uncertainties of relevant nuclear matrix elements, an upper limit  $|\langle m \rangle_{ee}| < (0.06 \cdots 0.2)$  eV has been achieved from the GERDA [365], EXO [188] and KamLAND-Zen [189] experiments at the 90% confidence level. Note that the knowledge of  $|\langle m \rangle_{ee}|$  itself is not enough to precisely fix the absolute neutrino mass scale, because both  $\phi_{e1}$  and  $\phi_{e3}$  are completely unknown.

(3) The sum of three neutrino masses constrained by cosmology. The standard model of Big Bang cosmology, usually referred to as the  $\Lambda$ CDM model with  $\Lambda$  denoting the cosmological constant (or dark energy) and CDM standing for cold dark matter [19], tells us that the primordial neutrinos and antineutrinos were out of equilibrium and decoupled from the thermal bath soon after the rate of weak interactions was smaller than the Hubble expansion rate. This decoupling happened when the temperature of the Universe was about 1 MeV (i.e., when the Universe was only about one second old). Since then the Universe became transparent to relic neutrinos and antineutrinos, and the latter turned to form the cosmic neutrino background (C $\nu$ B). Given the C $\nu$ B temperature  $T_\nu \simeq 1.945$  K today, the average three-momentum of each relic neutrino is found to be  $\langle p_\nu \rangle \simeq 3.15T_\nu \simeq 5.5 \times 10^{-4}$  eV. So the relic neutrinos  $\nu_i$  and antineutrinos  $\bar{\nu}_i$  (for  $i = 1, 2, 3$ ) must be non-relativistic today if their masses  $m_i$  are larger than  $\langle p_\nu \rangle$ , and they contribute to the total energy density of the Universe in the following form [172, 366]<sup>19</sup>:

$$\Omega_\nu \equiv \frac{\rho_\nu}{\rho_c} = \frac{8\pi G_N}{3H^2} \sum_{i=1}^3 m_i (n_{\nu_i} + n_{\bar{\nu}_i}) \simeq \frac{1}{93.14 h^2 \text{ eV}} \sum_{i=1}^3 m_i, \quad (94)$$

where  $\rho_c$  and  $\rho_\nu$  stand respectively for the critical density of the Universe and the density of relic neutrinos and antineutrinos,  $G_N$  denotes the Newtonian constant of gravitation,  $H$  is the Hubble expansion rate,  $h$  represents the scale factor for  $H$ , and  $n_{\nu_i} = n_{\bar{\nu}_i} \simeq 56 \text{ cm}^{-3}$  is the average number density of relic  $\nu_i$  and  $\bar{\nu}_i$  (for  $i = 1, 2, 3$ ). The final full-mission Planck measurements of the CMB anisotropies [105], combined with the BAO measurements [369, 370, 371], strongly support the assumption of three neutrino families and set a stringent upper bound  $\Sigma_\nu \equiv m_1 + m_2 + m_3 < 0.12$  eV at the 95% confidence level. Taking account of  $h \simeq 0.68$ , we are therefore left with the upper bound  $\Omega_\nu < 2.8 \times 10^{-3}$ , which is far smaller than  $\Omega_b \simeq 5\%$  (baryon density),  $\Omega_{\text{CDM}} \simeq 26\%$  (CDM density) and  $\Omega_\Lambda \simeq 69\%$  ( $\Lambda$  density) of today’s Universe [19].

<sup>19</sup>If one of the neutrinos has a mass well below the value of  $\langle p_\nu \rangle$ , it must be keeping relativistic from the very early Universe till today. In this case its contribution to the sum of all the neutrino masses is negligibly small, and thus Eq. (94) remains acceptable. Here only the masses of three active neutrinos and three active antineutrinos are taken into account, because the Planck measurements have constrained the effective number of relativistic degrees of freedom to be  $N_{\text{eff}} = 2.96^{+0.34}_{-0.33}$  at the 95% confidence level [105], in good agreement with the result  $N_{\text{eff}} \simeq 3.046$  predicted by the standard cosmological model [367, 368].

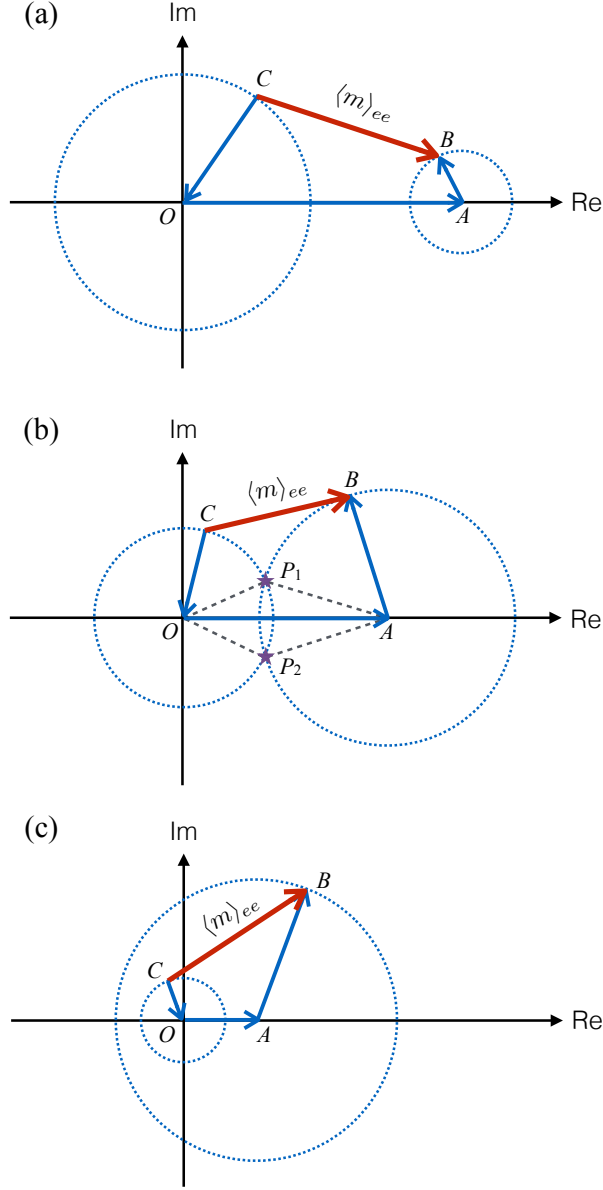

Figure 12: The coupling-rod diagrams for the effective  $0\nu 2\beta$  mass term  $\langle m \rangle_{ee} \equiv \overrightarrow{CB}$  in the complex plane, where  $\overrightarrow{OA} \equiv m_2 |U_{e2}|^2$ ,  $\overrightarrow{AB} \equiv m_1 |U_{e1}|^2 \exp(i\phi_{e1})$  and  $\overrightarrow{CO} \equiv m_3 |U_{e3}|^2 \exp(i\phi_{e3})$ . If the neutrino mass ordering is normal, all the three configurations of  $\langle m \rangle_{ee}$  are possible; but if it is inverted, then only configuration (c) is allowed [363].

With the help of a global fit of current neutrino oscillation data at the  $3\sigma$  level [92, 93], one may plot the correlation between  $|\langle m \rangle_{ee}|$  and  $\Sigma_\nu$  or that between  $\langle m \rangle_e$  and  $\Sigma_\nu$  by allowing the two unknown Majorana phases to vary in the  $[0, 2\pi)$  range. Fig. 13 shows the numerical result for the normal (red) or inverted (blue) neutrino mass ordering. Some discussions are in order.

- Given the very robust Planck constraint  $\Sigma_\nu < 0.12$  eV at the 95% confidence level [105],



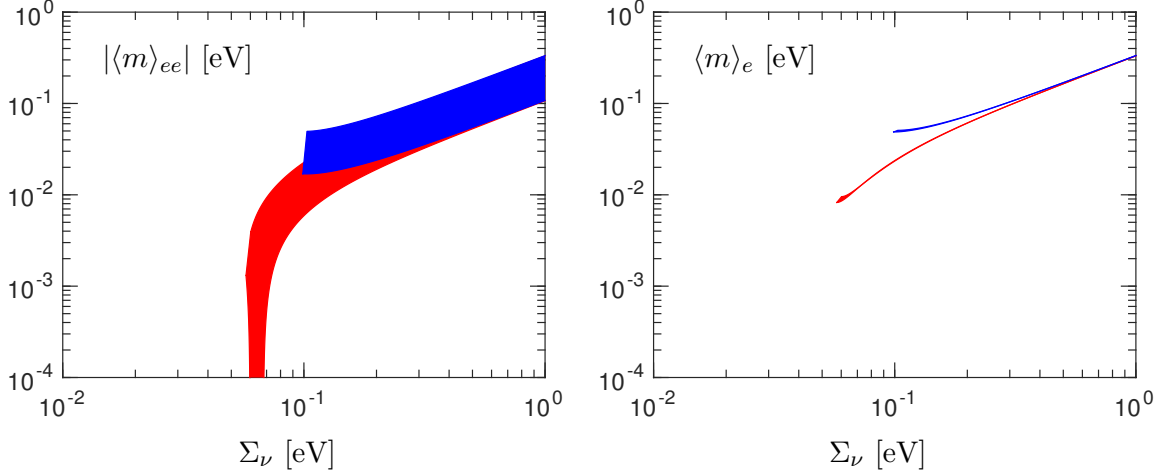

Figure 13: An illustration of the correlation between  $|\langle m \rangle_{ee}|$  and  $\Sigma_\nu$  (left panel) and that between  $\langle m \rangle_e$  and  $\Sigma_\nu$  (right panel) by using the  $3\sigma$  inputs of relevant neutrino mass-squared differences and flavor mixing parameters [92, 93]. Here the red (blue) region corresponds to the normal (inverted) neutrino mass ordering.

the possibility of an inverted neutrino mass spectrum is only marginally allowed. In fact, a preliminary and mild hint of the normal mass ordering has been observed from a global analysis of some available cosmological data [372, 373, 374, 375, 376, 377]<sup>20</sup>. The next-generation precision observations of the CMB (e.g., the CMB-S4 [379], Pixie [380] and CORE [381] projects) and large-scale structures (e.g., the DES [382], Euclid [383], LSST [384] and SKA [385] projects) in cosmology are expected to convincingly tell whether the inverted neutrino mass ordering is really not true, after all uncertainties from the relevant cosmological parameters are well understood and evaluated (see, e.g., a recent analysis of this kind in Ref. [386]).

- Note that a question mark has recently been put against the approximation in Eq. (94), which was made from the exact cosmic energy density of massive neutrinos in a  $\Lambda$ CDM model [387]. The argument is that a determination of the sum of neutrino masses and their ordering should be pursued by using the exact models respecting current neutrino oscillation data instead of taking some cosmological approximations like Eq. (94), because the latter might lead to an incorrect and nonphysical bound. The new analysis based on the exact models yields a consistent upper bound  $\Sigma_\nu \lesssim 0.26$  eV at the 95% confidence level [387]. This constraint is quite different from the one obtained by the Planck Collaboration [105] and some other groups, and hence further studies are needed to resolve such discrepancies and develop a reliable approach in this regard.

<sup>20</sup>Taking account of three particular possibilities of the neutrino mass spectrum case by case, an updated analysis of the Planck data based on the  $\Lambda$ CDM model has provided us with an upper bound  $\Sigma_\nu < 0.121$  eV for the nearly degenerate neutrino mass ordering,  $\Sigma_\nu < 0.146$  eV for the normal mass ordering, or  $\Sigma_\nu < 0.172$  eV for the inverted mass ordering at the 95% confidence level [378]. In this analysis the normal neutrino mass ordering is also found to be mildly preferred to the inverted one.

- In the case of a normal neutrino mass spectrum, there is a small parameter space in which the effective  $0\nu 2\beta$ -decay mass term  $\langle m \rangle_{ee}$  suffers from a significant cancellation and hence its magnitude becomes strongly suppressed — around or far below 1 meV [388, 389, 390]. A careful analysis shows that such a “disaster”, which means the loss of observability of the  $0\nu 2\beta$  decays in any realistic experiments, will not happen unless the smallest neutrino mass  $m_1$  is about a few meV and the Majorana phase  $\phi_{e1}$  is around  $\pi$  [391, 392, 393, 394] (see section 7.2.1 and Fig. 34 for some further discussions). If the next-generation  $0\nu 2\beta$ -decay experiments are able to probe  $|\langle m \rangle_{ee}|$  with a sensitivity of about 10 meV [183], then a null result will point to the normal neutrino mass ordering.

In comparison, the most promising  $\beta$ -decay experiment is the KATRIN experiment which aims to reach the sensitivity  $\langle m \rangle_e \sim 0.2$  eV [359]. A combination of the future measurements of  $\langle m \rangle_e$ ,  $|\langle m \rangle_{ee}|$  and  $\Sigma_\nu$  will be greatly helpful to pin down the absolute neutrino mass scale and test the self-consistency of the standard three-flavor scheme.

Note that the supernova neutrinos can also be used to probe or constrain the absolute neutrino mass scale with the help of a measurement of their delayed flight time compared to the massless photon, as first pointed out by Georgiy Zatsepin in 1968 [395]. An analysis of the neutrino burst from Supernova 1987A in the Large Magellanic Cloud has yielded an upper bound  $m_\nu < 5.7$  eV at the 95% confidence level [396], where the masses of three neutrinos are assumed to be nearly degenerate (i.e.,  $m_\nu \equiv m_1 \simeq m_2 \simeq m_3$ ). Given a future neutrino burst from a typical galactic core-collapse supernova at a distance of about 10 kpc from the Earth, for example, the delay of a neutrino’s flight time is expected to be

$$\Delta t \simeq 5.14 \text{ ms} \left( \frac{m_\nu}{\text{eV}} \right)^2 \left( \frac{10 \text{ MeV}}{E_\nu} \right)^2 \frac{D}{10 \text{ kpc}}, \quad (95)$$

in which  $E_\nu$  is the neutrino energy and  $D$  denotes the distance between the supernova and the detector. Some recent studies have shown that it is possible to achieve  $m_\nu < 0.8$  eV at the 95% confidence level for the Super-Kamiokande water Cherenkov detector [397] and for the JUNO liquid scintillator detector [343, 398]. Several methods for properly timing the neutrino and (or) antineutrino signals coming from a galactic supernova have recently been explored via the Monte Carlo simulations for the next-generation neutrino and (or) antineutrino detectors, including JUNO [399, 400], Hyper-Kamiokande [355] and IceCube Gen2 [401, 402, 403].

Another possibility is to utilize some fine atomic transitions as a powerful tool to determine the mass scale of three neutrinos and even their nature (i.e., Dirac or Majorana) [404, 405, 406]. The basic idea is to measure  $|e\rangle \rightarrow |g\rangle + \gamma + \nu_i + \bar{\nu}_j$  (for  $i, j = 1, 2, 3$ ), as illustrated in Fig. 14, where  $|e\rangle$  denotes the excited level in an atomic or molecular system such as Yb, and  $|g\rangle$  is the ground one. Such a transition can take place via an intermediate state, and useful information about the neutrino properties is encoded in the spectrum of the accompanying photon  $\gamma$  — a case like the spectrum of the emitted electrons in a nuclear  $\beta$ -decay experiment. Before and after the above transition with the radiative emission of a neutrino-antineutrino pair, the total energy of this system is conserved:  $E_{eg} = \omega + E_i + E_j$ , where  $E_{eg}$  represents the energy difference between  $|e\rangle$  and  $|g\rangle$ ,  $\omega$  stands for the energy of the emitted photon, and  $E_i$  (or  $E_j$ ) denotes the energy of the neutrino  $\nu_i$  (or  $\bar{\nu}_j$ ) with the mass  $m_i$  (or  $m_j$ ). There may exist six thresholds in the fine structure of

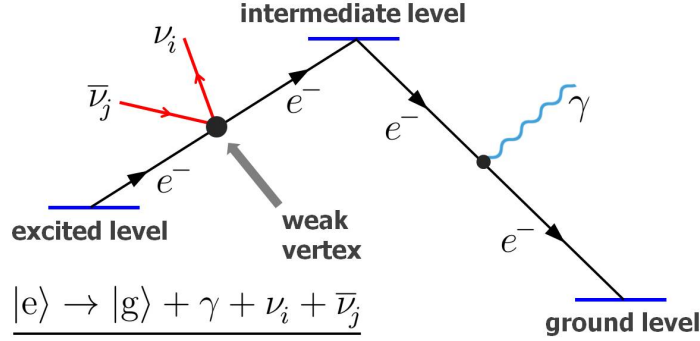

Figure 14: An illustration of the radiative emission of a neutrino-antineutrino pair at an atomic system, where the effective weak vertex includes the contributions from virtual  $W^-$  and  $Z^0$  bosons (i.e.,  $e^- \rightarrow \nu_i + W^{*-} \rightarrow \nu_i + \bar{\nu}_j + e^-$  involving the PMNS matrix elements  $U_{ei}U_{ej}^*$  (for  $i, j = 1, 2, 3$ ) and  $e^- \rightarrow e^- + Z^{*0} \rightarrow e^- + \nu_i + \bar{\nu}_i$  (for  $i = 1, 2, 3$ ), respectively, in the standard three-flavor scheme).

the outgoing photon energy spectrum due to the finite neutrino masses [407, 408, 409], located at the frequencies

$$\omega_{ij} = \frac{E_{\text{eg}}}{2} - \frac{(m_i + m_j)^2}{2E_{\text{eg}}}. \quad (96)$$

Since  $E_{\text{eg}} \sim O(1)$  eV,  $\omega_{ij}$  are therefore sensitive to the values of neutrino masses. An external laser with the frequency  $\omega$  can be used to trigger the transition under consideration, and a coherence enhancement of its transition rate is possible with the help of super-radiance phenomenon in quantum optics [410]. So far some impressive progress has been made in trying to carry out a feasible and efficient measurement of the atomic transition  $|e\rangle \rightarrow |g\rangle + \gamma + \nu_i + \bar{\nu}_j$  [411, 412].

### 3.4. The PMNS lepton flavor mixing parameters

#### 3.4.1. Flavor mixing angles and CP-violating phases

Different from the quark sector, in which all the CKM quark flavor mixing parameters can be determined from the relevant flavor-changing weak-interaction processes, the lepton sector has not provided us with enough space to look into the flavor conversions which depend on the PMNS matrix elements. Flavor oscillations of massive neutrinos are currently the only way for us to measure the three lepton flavor mixing angles ( $\theta_{12}$ ,  $\theta_{13}$  and  $\theta_{23}$ ) and the Dirac CP-violating phase ( $\delta_\nu$ ) in the standard parametrization of the PMNS matrix  $U$ , as given in Eq. (2).

(1) Determination of  $\theta_{12}$ . This angle dominates the flavor-changing strength in solar  $\nu_e \rightarrow \nu_e$  oscillations. For the purpose of illustration, let us take a look at the recent Borexino results shown in Fig. 15, where the data points of the survival probability  $P(\nu_e \rightarrow \nu_e)$  are  $0.57 \pm 0.09$  for the  $pp$  neutrinos with  $E = 0.267$  MeV (red),  $0.53 \pm 0.05$  for the  ${}^7\text{Be}$  neutrinos with  $E = 0.862$  MeV (blue),  $0.43 \pm 0.11$  for the  $pep$  neutrinos with  $E = 1.44$  MeV (cyan), and  $0.37 \pm 0.08$  for the  ${}^8\text{B}$  neutrinos with  $E = 8.1$  MeV (green) [413] in the assumption of the high-metallicity SSM [417]. Such results can easily be understood in the approximation of two-flavor neutrino oscillations, as illustrated in the following two examples.

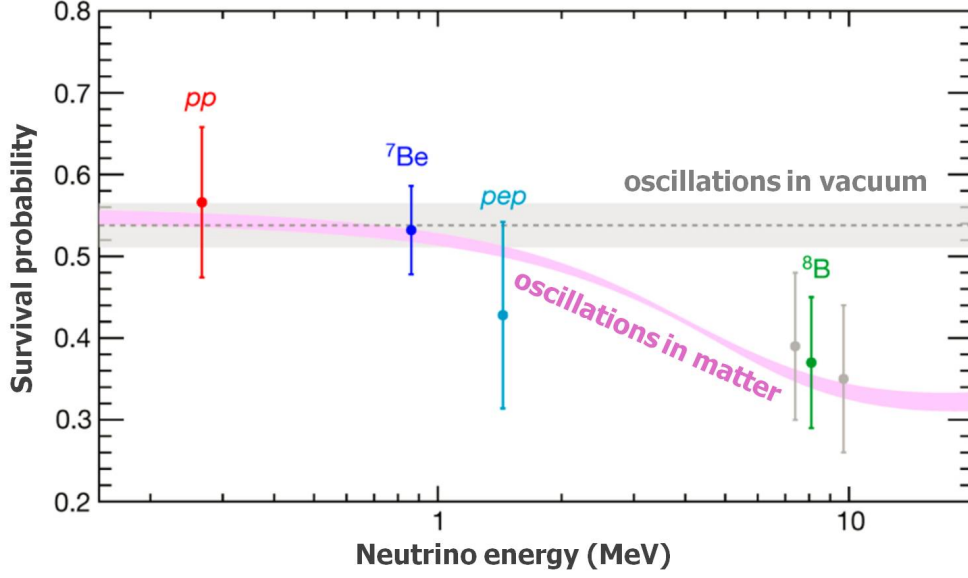

Figure 15: The survival probability of solar electron neutrinos measured in the Borexino experiment [413], where the pink band denotes the  $\pm 1\sigma$  prediction of  $\nu_e \rightarrow \nu_e$  oscillations in matter with the oscillation parameters quoted from Ref. [414], and the gray band corresponds to  $\nu_e \rightarrow \nu_e$  oscillations in vacuum with the oscillation parameters reported in Refs. [415, 416]. The data points represent the Borexino results for  $pp$  (red),  ${}^7\text{Be}$  (blue),  $pep$  (cyan) and  ${}^8\text{B}$  (green for the high-energy region, and gray for the separate sub-ranges of this region) in the assumption of the high-metallicity SSM [417], and their error bars include the experimental and theoretical uncertainties.

- Solar  $pp$  neutrinos mainly oscillate in vacuum as their energies are so small that  $\Delta m_{21}^2/(2E)$  is apparently dominant over the matter potential  $V_{\text{cc}} = \sqrt{2} G_{\text{F}} N_e \simeq 7.5 \times 10^{-6} \text{ eV}^2 \text{ MeV}^{-1}$  [418] for  $N_e \simeq 6 \times 10^{25} \text{ cm}^{-3}$  at the core of the Sun [419], if  $\Delta m_{21}^2 \simeq 7.3 \times 10^{-5} \text{ eV}^2$  is taken as a benchmark value in accordance with Table 9. Such a solar neutrino mass-squared difference corresponds to an oscillation length  $L_{\text{osc}} \equiv 4\pi E/\Delta m_{21}^2 \simeq 9 \text{ km}$ , which is too short as compared to the positional uncertainties associated with the production of solar neutrinos in the core area of the Sun [420]. In this case the probability of solar  $pp$  neutrino oscillations can safely approximate to

$$\bar{P}(\nu_e \rightarrow \nu_e) \simeq P(\nu_e \rightarrow \nu_e) \simeq \cos^4 \theta_{13} \left( 1 - \frac{1}{2} \sin^2 2\theta_{12} \right) + \sin^4 \theta_{13}, \quad (97)$$

which is distance-averaged over the oscillation factor and depends only on the flavor mixing angles  $\theta_{12}$  and  $\theta_{13}$ . Taking account of  $P(\nu_e \rightarrow \nu_e) \simeq 0.57$  that has been measured in the Borexino experiment and neglecting the small contribution from  $\theta_{13}$ , we are therefore left with  $\theta_{12} \simeq 34^\circ$ . The observed survival probability of solar  ${}^7\text{Be}$  neutrinos can be explained in a similar way.

- The oscillation behavior of solar  ${}^8\text{B}$  neutrinos with  $E \gtrsim 6 \text{ MeV}$  should be dominated by matter effects because  $\Delta m_{21}^2/(2E)$  is strongly suppressed as compared with the matter potential  $V_{\text{cc}} \simeq 7.5 \times 10^{-6} \text{ eV}^2 \text{ MeV}^{-1}$  at the core of the Sun. In this case the distance-averaged

probability of solar  $^8\text{B}$  neutrino oscillations reads [421]

$$\widetilde{P}(\nu_e \rightarrow \nu_e) \simeq \frac{1}{2} \cos^4 \theta_{13} \left( 1 + \cos 2\theta_{12} \cos 2\widetilde{\theta}_{12} \right) \simeq \cos^4 \theta_{13} \sin^2 \theta_{12}, \quad (98)$$

where the effective (matter-corrected) flavor mixing angle  $\widetilde{\theta}_{12}$  is related to  $\theta_{12}$  via Eq. (88), from which  $\widetilde{\theta}_{12} \simeq \pi/2$  can be obtained as a result of  $r_m \rightarrow \infty$  thanks to the dominance of  $V_{cc}$  over  $\Delta m_{21}^2/(2E)$ . In view of  $\widetilde{P}(\nu_e \rightarrow \nu_e) \simeq 0.37$  that has been measured in the Borexino experiment, one arrives at  $\theta_{12} \simeq 37^\circ$  from Eq. (98) by neglecting the small contribution from  $\theta_{13}$ . This approximate result is essentially consistent with the one extracted from Eq. (97), but it involves much larger uncertainties.

In fact, the Super-Kamiokande [11, 422] and SNO [10, 12, 423] experiments have measured the flux of solar  $^8\text{B}$  neutrinos to a much better degree of accuracy. Their results lead us to  $\theta_{12} \simeq 33^\circ$ .

Another reliable way to determine  $\theta_{12}$  is the measurement of  $\bar{\nu}_e \rightarrow \bar{\nu}_e$  oscillations in the KamLAND experiment [14, 424] — a long-baseline ( $\sim 180$  km) reactor antineutrino oscillation experiment by using the liquid scintillator antineutrino detector located in Kamioka. Such an average baseline length means that this experiment is mainly sensitive to the oscillation term driven by  $\Delta m_{21}^2 \simeq 7.3 \times 10^{-5} \text{ eV}^2$ , as one can see from Eq. (90). It is therefore straightforward to measure  $\theta_{12}$  in a way which is essentially free from terrestrial matter effects, if  $\theta_{13}$  is small enough. But the KamLAND measurement  $\tan^2 \theta_{12} = 0.56_{-0.07}^{+0.10}(\text{stat})_{-0.06}^{+0.10}(\text{syst})$  [424] leads us to a slightly larger value of  $\theta_{12}$  (i.e.,  $\theta_{12} \simeq 37^\circ$ ), in comparison with the result of  $\theta_{12}$  extracted from solar neutrino oscillations. This small discrepancy will be clarified in the upcoming JUNO medium-baseline reactor antineutrino oscillation experiment [343].

(2) Determination of  $\theta_{13}$ . This smallest neutrino mixing angle can be most accurately measured in a short-baseline reactor antineutrino oscillation experiment, such as the Daya Bay [15], RENO [425] and Double Chooz [426] experiments. Given  $L \sim 2$  km and  $E \sim 4$  MeV for this kind of experiment, Eq. (90) indicates that  $P(\bar{\nu}_e \rightarrow \bar{\nu}_e)$  is dominated by the oscillation terms driven by  $\Delta m_{31}^2$  and  $\Delta m_{32}^2$  because their magnitudes are around  $2.5 \times 10^{-3} \text{ eV}^2$  as extracted from atmospheric and accelerator-based neutrino oscillation experiments. Namely,

$$P(\bar{\nu}_e \rightarrow \bar{\nu}_e) \simeq 1 - \sin^2 2\theta_{13} \sin^2 \frac{\Delta m_{31}^2 L}{4E}, \quad (99)$$

in which  $\Delta m_{32}^2 \simeq \Delta m_{31}^2$  has been taken. So far the Daya Bay experiment has reported the most accurate result:  $\sin^2 2\theta_{13} = 0.0856 \pm 0.0029$  [415, 427], leading us to  $\theta_{13} \simeq 8.51^\circ$ . The smallness of  $\theta_{13}$  makes the two-flavor interpretations of solar and atmospheric neutrino oscillation data reasonably good, and this turns out to plunk for the light-hearted argument that there seems to exist an intelligent design of the neutrino oscillation parameters [428].

(3) Determination of  $\theta_{23}$ . This largest neutrino mixing angle was first determined by the Super-Kamiokande Collaboration in their atmospheric neutrino oscillation experiment [13]. Now that the atmospheric  $\nu_\mu$  and  $\bar{\nu}_\mu$  events are not monochromatic and the energy resolution of the Super-Kamiokande detector is not perfect either, it is necessary to average the  $\nu_\mu \rightarrow \nu_\mu$  (or  $\bar{\nu}_\mu \rightarrow \bar{\nu}_\mu$ ) oscillation probability around a reasonable energy range. On the other hand, the production and

detection regions of atmospheric neutrinos are certainly not point-like, and thus one has to average  $P(\nu_\mu \rightarrow \nu_\mu)$  or  $P(\bar{\nu}_\mu \rightarrow \bar{\nu}_\mu)$  around a reasonable path-length range [429]. In the two-flavor approximation the averaged probability turns out to be

$$P(\nu_\mu \rightarrow \nu_\mu) = P(\bar{\nu}_\mu \rightarrow \bar{\nu}_\mu) \simeq 1 - \frac{1}{2} \sin^2 2\theta_{23} , \quad (100)$$

where small terrestrial matter effects have been neglected. The original Super-Kamiokande measurement done in 1998 led us to  $\sin^2 2\theta_{23} > 0.82$  at the 90% confidence level [13], implying an unexpectedly large value of  $\theta_{23}$  as compared with its counterpart in the quark sector. A recent analysis of the available Super-Kamiokande data in the three-flavor scheme with matter effects points to  $\sin^2 \theta_{23} = 0.588_{-0.064}^{+0.031}$  for a normal neutrino mass spectrum, or  $\sin^2 \theta_{23} = 0.575_{-0.073}^{+0.036}$  for an inverted mass spectrum [430]. These results indicate a slight preference for  $\theta_{23}$  to lie in the second (upper) octant (i.e.,  $\theta_{23} > \pi/4$ ), although it is statistically not significant enough.

The fact that  $\theta_{23}$  is very close to  $\pi/4$  has also been observed in a number of long-baseline accelerator neutrino oscillation experiments, such as K2K with  $L \simeq 250$  km [16, 431], MINOS with  $L \simeq 735$  km [432, 433], T2K with  $L \simeq 295$  km [17, 18] and NO $\nu$ A with  $L \simeq 810$  km [434, 435]. This striking result has motivated a lot of model-building attempts based on discrete or continuous flavor symmetries [143, 144, 145, 146].

(4) Determination of  $\delta_\nu$ . This phase parameter of  $U$  is responsible for the strength of CP violation in neutrino oscillations, and it can be measured in a long-baseline  $\nu_\mu \rightarrow \nu_e$  oscillation experiment if terrestrial matter effects are well understood. To a quite good degree of accuracy, the probability of  $\nu_\mu \rightarrow \nu_e$  oscillations can be approximately expressed as [436]

$$\begin{aligned} P(\nu_\mu \rightarrow \nu_e) \simeq & \sin^2 2\theta_{13} \sin^2 \theta_{23} \frac{\sin^2 [(r_m - 1)\phi_{31}]}{(r_m - 1)^2} \\ & + \alpha \sin 2\theta_{12} \sin 2\theta_{13} \cos \theta_{13} \sin 2\theta_{23} \cos(\phi_{31} + \delta_\nu) \frac{\sin(r_m \phi_{31}) \sin[(r_m - 1)\phi_{31}]}{r_m (r_m - 1)} \\ & + \alpha^2 \sin^2 2\theta_{12} \cos^2 \theta_{23} \frac{\sin^2(r_m \phi_{31})}{r_m^2} , \end{aligned} \quad (101)$$

where  $r_m \equiv 2\sqrt{2}G_F N_e E / \Delta m_{31}^2$  and  $\phi_{31} \equiv \Delta m_{31}^2 L / (4E)$  are defined, and  $\alpha \equiv \Delta m_{21}^2 / \Delta m_{31}^2$  is a small expansion parameter. The probability of  $\bar{\nu}_\mu \rightarrow \bar{\nu}_e$  oscillations can be simply read off from Eq. (101) with the replacements  $\delta_\nu \rightarrow -\delta_\nu$  and  $r_m \rightarrow -r_m$ . It is obvious that the sign of  $\Delta m_{31}^2$  affects the behaviors of neutrino and antineutrino oscillations via the signs of  $r_m$ ,  $\alpha$  and  $\phi_{31}$ , making it possible to probe the neutrino mass ordering with the help of terrestrial matter effects. What is more important is to probe the CP-violating phase  $\delta_\nu$  by measuring  $\nu_\mu \rightarrow \nu_e$  and  $\bar{\nu}_\mu \rightarrow \bar{\nu}_e$  oscillations and distinguishing the genuine CP-violating effect from the matter-induced contamination. In the leading-order approximation with a baseline length  $L \lesssim 300$  km, Eq. (101) leads us to

$$\mathcal{A}_{\text{CP}} \equiv \frac{P(\nu_\mu \rightarrow \nu_e) - P(\bar{\nu}_\mu \rightarrow \bar{\nu}_e)}{P(\nu_\mu \rightarrow \nu_e) + P(\bar{\nu}_\mu \rightarrow \bar{\nu}_e)} \simeq -\frac{\sin 2\theta_{12} \sin \delta_\nu}{\sin \theta_{13} \tan \theta_{23}} \sin \phi_{21} + \text{matter contamination} , \quad (102)$$

where  $\phi_{21} \equiv \Delta m_{21}^2 L/(4E)$  is defined, and the matter contamination only shows up as the next-to-leading-order effect in a realistic experiment of this kind, such as the present T2K experiment and the future DUNE and Hyper-Kamiokande experiments.

The first combined analysis of  $\nu_\mu \rightarrow \nu_e$  and  $\bar{\nu}_\mu \rightarrow \bar{\nu}_e$  oscillations based on the T2K data has excluded the CP conservation hypothesis (i.e.,  $\delta_\nu = 0$  or  $\pi$ ) at the 90% confidence level, and yielded  $\delta_\nu \in [-3.13, -0.39]$  for the normal neutrino mass ordering at the same confidence level [437]. In comparison, a joint fit to the NO $\nu$ A data for  $\nu_\mu \rightarrow \nu_\mu$  and  $\nu_\mu \rightarrow \nu_e$  oscillations shows a slight preference for the normal neutrino mass ordering and gives the best-fit point  $\delta_\nu = 1.21\pi$  [438], essentially consistent with the T2K result. The preliminary indication of  $\delta_\nu \sim 3\pi/2$  (or equivalently  $-\pi/2$ ) extracted from the T2K and NO $\nu$ A measurements, together with the observation of  $\theta_{23} \simeq \pi/4$ , has stimulated a lot of interest in model building by means of some discrete flavor symmetries — especially the so-called  $\nu_\mu$ - $\nu_\tau$  reflection symmetry [439, 440].

For the time being there is no experimental information about the two Majorana phases of the PMNS lepton flavor mixing matrix  $U$ , simply because these two phase parameters are irrelevant to normal neutrino-neutrino and antineutrino-antineutrino oscillations. If massive neutrinos are really the Majorana particles, such CP-violating phases will play important roles in those lepton-number-violating processes, such as the  $0\nu 2\beta$  decays and neutrino-antineutrino oscillations.

### 3.4.2. The global-fit results and their implications

A global analysis of the available experimental data accumulated from solar, atmospheric, reactor and accelerator neutrino (or antineutrino) oscillation experiments in a “hierarchical” three-flavor scheme started from the beginning of the 1990s [441], where “hierarchical” means that  $\theta_{13}$  is small enough and thus solar and atmospheric neutrino oscillations can approximate to the two-flavor oscillations dominated respectively by  $\theta_{12}$  and  $\theta_{23}$ . It provides a very helpful tool to extract the fundamental parameters of neutrino oscillations by combining different experimental results or constraints, which are associated with different neutrino (or antineutrino) sources, different beam energies, different baseline lengths, different environmental media and different detection techniques, on a sound footing. Sometimes this kind of analysis is even possible to indirectly predict the allowed range of an unknown quantity before it is directly measured, and the successful examples in this connection include the top-quark mass, the Higgs-boson mass [442] and the size of the smallest neutrino mixing angle  $\theta_{13}$  [443, 444].

A state-of-the-art global analysis of current neutrino oscillation data has recently been done in Refs. [92] and [93] in the three-flavor scheme. The relevant outputs for the neutrino mass-squared differences and flavor mixing parameters are expressed in terms of the standard deviations  $N\sigma$  from a local or global  $\chi^2$  minimum (i.e.,  $N\sigma = \sqrt{\Delta\chi^2}$ ), as listed in Tables 9 and 10. Some comments on the implications of Table 10 are in order.

- Both  $\theta_{12}$  and  $\theta_{13}$  have been determined to a good degree of accuracy. The fact that  $\theta_{13}$  is not highly suppressed is certainly a good news to the next-generation reactor and accelerator experiments aiming to probe the neutrino mass ordering and (or) leptonic CP violation, as one can see in Eqs. (90) and (101). On the other hand, the best-fit value of  $\theta_{12}$  is quite close to a special number  $\arctan(1/\sqrt{2}) \simeq 35.3^\circ$ . The latter has stimulated a lot of model-building exercises based on some discrete flavor symmetry groups [143, 144, 145, 146].

Table 10: The three flavor mixing angles and one CP-violating phase extracted from a global analysis of current neutrino oscillation data, corresponding to the neutrino mass-squared differences listed in Table 9. Here the results quoted from Ref. [92] and Ref. [93] are presented in the same form for an easier comparison.

	Normal mass ordering ( $m_1 < m_2 < m_3$ )			Inverted mass ordering ( $m_3 < m_1 < m_2$ )		
Capozzi <i>et al</i> [92]	Best fit	$1\sigma$ range	$3\sigma$ range	Best fit	$1\sigma$ range	$3\sigma$ range
$\sin^2 \theta_{12}/10^{-1}$	3.04	2.91 $\rightarrow$ 3.18	2.65 $\rightarrow$ 3.46	3.03	2.90 $\rightarrow$ 3.17	2.64 $\rightarrow$ 3.45
$\sin^2 \theta_{13}/10^{-2}$	2.14	2.07 $\rightarrow$ 2.23	1.90 $\rightarrow$ 2.39	2.18	2.11 $\rightarrow$ 2.26	1.95 $\rightarrow$ 2.43
$\sin^2 \theta_{23}/10^{-1}$	5.51	4.81 $\rightarrow$ 5.70	4.30 $\rightarrow$ 6.02	5.57	5.33 $\rightarrow$ 5.74	4.44 $\rightarrow$ 6.03
$\delta_\nu/\pi$	1.32	1.14 $\rightarrow$ 1.55	0.83 $\rightarrow$ 1.99	1.52	1.37 $\rightarrow$ 1.66	1.07 $\rightarrow$ 1.92
Esteban <i>et al</i> [93]	Best fit	$1\sigma$ range	$3\sigma$ range	Best fit	$1\sigma$ range	$3\sigma$ range
$\sin^2 \theta_{12}/10^{-1}$	3.10	2.98 $\rightarrow$ 3.23	2.75 $\rightarrow$ 3.50	3.10	2.98 $\rightarrow$ 3.23	2.75 $\rightarrow$ 3.50
$\sin^2 \theta_{13}/10^{-2}$	2.24	2.17 $\rightarrow$ 2.31	2.04 $\rightarrow$ 2.44	2.26	2.20 $\rightarrow$ 2.33	2.07 $\rightarrow$ 2.46
$\sin^2 \theta_{23}/10^{-1}$	5.82	5.63 $\rightarrow$ 5.97	4.28 $\rightarrow$ 6.24	5.82	5.64 $\rightarrow$ 5.97	4.33 $\rightarrow$ 6.23
$\delta_\nu/\pi$	1.21	1.05 $\rightarrow$ 1.43	0.75 $\rightarrow$ 2.03	1.56	1.40 $\rightarrow$ 1.69	1.09 $\rightarrow$ 1.95

- Among the three flavor mixing angles,  $\theta_{23}$  involves the largest uncertainties for the time being. But it is interesting to see that the best-fit value of  $\theta_{23}$  is slightly larger than  $\pi/4$ , implying that this flavor mixing angle is likely to lie in the second (or upper) octant. The fact that  $\theta_{23}$  is very close to  $\pi/4$  is one of the most striking features of lepton flavor mixing, and it strongly suggests that there should exist a kind of discrete flavor symmetry behind the observed pattern of the PMNS matrix  $U$ .
- Another intriguing observation is that the CP-violating phase  $\delta_\nu$  deviates from 0 and  $\pi$  at a confidence level near  $2\sigma$ , and its best-fit value is located in the third quadrant. This preliminary result is rather encouraging, because it implies that the effect of CP violation in neutrino oscillations may be quite significant. Moreover,  $\delta_\nu$  seems to be close to (or not far away from) the special phase  $3\pi/2$ , which is also suggestive of a kind of flavor symmetry that underlies the observed pattern of lepton flavor mixing [440].

In short, a global analysis of the present neutrino oscillation data has provided us with quite a lot of information about the neutrino mass-squared differences and flavor mixing parameters. One is expecting to learn much more from the ongoing and upcoming precision oscillation experiments, in particular to pin down the sign of  $\Delta m_{31}^2$  (or  $\Delta m_{32}^2$ ), the octant of  $\theta_{23}$  and the value of  $\delta_\nu$  at a sufficiently high (e.g.,  $\gtrsim 5\sigma$ ) confidence level.

In Table 11 we list the  $3\sigma$  ranges of  $|U_{\alpha i}|$  (for  $\alpha = e, \mu, \tau$  and  $i = 1, 2, 3$ ) for the nine elements of the  $3 \times 3$  PMNS matrix  $U$ , as indicated by the global fit done in Ref. [93]. Some immediate



Table 11: The  $3\sigma$  ranges of the nine PMNS matrix elements  $U_{\alpha i}$  (for  $\alpha = e, \mu, \tau$  and  $i = 1, 2, 3$ ) in magnitude, which are obtained from a global fit of current neutrino oscillation data by assuming the unitarity of  $U$  [93].

	1	2	3
$e$	0.797 $\rightarrow$ 0.842	0.518 $\rightarrow$ 0.585	0.143 $\rightarrow$ 0.156
$\mu$	0.235 $\rightarrow$ 0.484	0.458 $\rightarrow$ 0.671	0.647 $\rightarrow$ 0.781
$\tau$	0.304 $\rightarrow$ 0.531	0.497 $\rightarrow$ 0.699	0.607 $\rightarrow$ 0.747

observations and discussions are in order.

- The smallest and largest elements of  $U$  in magnitude are  $|U_{e3}|$  and  $|U_{e1}|$ , respectively. In comparison, Table 8 shows that the smallest and largest elements of the CKM quark flavor mixing matrix  $V$  in magnitude are  $|V_{ub}|$  and  $|V_{tb}|$ , respectively. Since  $V$  and  $U$  are associated respectively with  $W^+$  and  $W^-$  in the weak charged-current interactions as one can see in Eq. (1), one should be cautious when making a direct comparison or a naive correlation between the structures of  $V$  and  $U$ .
- But it is obvious that the lepton flavor mixing pattern is quite different from the quark flavor mixing pattern. In particular,  $V$  can be treated as the identity matrix plus small corrections of  $O(\lambda)$  or smaller, while  $U$  does not exhibit a strong structural hierarchy. Instead,  $U$  exhibits an approximate  $\mu$ - $\tau$  permutation symmetry  $|U_{\mu i}| \simeq |U_{\tau i}|$  (for  $i = 1, 2, 3$ ). If  $|U_{\mu i}| = |U_{\tau i}|$  is required to hold exactly, then one will be left with either  $\theta_{23} = \pi/4$  and  $\theta_{13} = 0$  or  $\theta_{23} = \pi/4$  and  $\delta_\nu = \pm\pi/2$  in the standard parametrization of  $U$  [445, 446].
- That is why the PMNS matrix  $U$  has been speculated to have such a peculiar structure that its leading term is a constant matrix  $U_0$  containing at least two large but special flavor mixing angles, and it receives some small corrections described by  $\Delta U$  which may depend on the CP-violating parameters and mass ratios of charged leptons and (or) neutrinos [138, 139]. It is very common to specify  $U_0$  by invoking a kind of flavor symmetry in the lepton sector [143, 144, 145, 146]. In this case spontaneous or explicit breaking of such a flavor symmetry contributes to  $\Delta U$ , and thus  $U = U_0 + \Delta U$  can fit the experimental data.

Of course, it remains unknown whether the conjecture of  $U = U_0 + \Delta U$  is really true or not. One may also explain the large flavor mixing angles of  $U$  by directly relating them to the mass ratios of charged leptons and neutrinos, for example, in the Fritzsch-like zero textures of  $M_l$  and  $M_\nu$  [447, 448]. Although the approach based on flavor symmetries has been explored to a great extent in the past twenty years to achieve  $U \simeq U_0$ , it is hard to believe that the true pattern of  $U$  has nothing to do with  $m_e/m_\mu$ ,  $m_\mu/m_\tau$ ,  $m_1/m_2$  and  $m_2/m_3$  in general [449].

### 3.4.3. Some constant lepton flavor mixing patterns

Without going into details of any model building, let us focus on the possibility of  $U = U_0 + \Delta U$  and summarize a number of interesting patterns of  $U_0$  which have more or less had an impact on

our understanding of lepton flavor mixing and CP violation. Now that all the currently available information on  $U$  is from various neutrino oscillation experiments, here we simply choose the flavor basis shown in Eq. (15) to discuss the constant pattern  $U_0$  which links the flavor eigenstates of three neutrinos to their mass eigenstates.

(1) The “trimaximal” flavor mixing pattern [450], which assures each neutrino flavor eigenstate  $\nu_\alpha$  (for  $\alpha = e, \mu, \tau$ ) to receive equal and maximally allowed contributions in magnitude from the three neutrino mass eigenstates  $\nu_i$  (for  $i = 1, 2, 3$ ):

$$U_\omega = \frac{1}{\sqrt{3}} \begin{pmatrix} 1 & 1 & 1 \\ 1 & \omega & \omega^* \\ 1 & \omega^* & \omega \end{pmatrix}, \quad (103)$$

where  $\omega \equiv \exp(i2\pi/3)$  is the complex cube root of unity (i.e.,  $\omega^3 = 1$ ). It predicts  $\theta_{12} = \theta_{23} = 45^\circ$ ,  $\theta_{13} = \arctan(1/\sqrt{2}) \simeq 35.3^\circ$  and  $\delta_\nu = \pm 90^\circ$  in the standard parametrization of  $U$  given in Eq. (2) after a proper phase redefinition. Note that  $U_\omega$  is also unique in accommodating maximal CP violation in the lepton or quark sector [450, 451, 452] because it defines six congruent *regular* triangles in the complex plane and each of them has the maximal area equal to  $1/(12\sqrt{3})$ .

(2) The “democratic” flavor mixing pattern [138, 139], originating from the transpose of the orthogonal matrix  $O_*$  in Eq. (67) which has been used to diagonalize the flavor “democracy” texture of a fermion mass matrix<sup>21</sup>:

$$U_0 = \frac{1}{\sqrt{6}} \begin{pmatrix} \sqrt{3} & -\sqrt{3} & 0 \\ 1 & 1 & -2 \\ \sqrt{2} & \sqrt{2} & \sqrt{2} \end{pmatrix}. \quad (104)$$

It predicts  $\theta_{12} = 45^\circ$ ,  $\theta_{13} = 0^\circ$  and  $\theta_{23} = \arctan(\sqrt{2}) \simeq 54.7^\circ$  in the standard parametrization of  $U$  after a proper phase redefinition. An intuitive geometrical illustration of the special values of  $\theta_{12}$  and  $\theta_{23}$  is shown in Fig. 16. Note that the relationship between  $(\nu_e, \nu_\mu, \nu_\tau)$  and  $(\nu_1, \nu_2, \nu_3)$  in Eq. (104) involves the same mixing pattern as the well-known relationship between the light pseudoscalar mesons  $(\pi^0, \eta, \eta')$  and the quark-antiquark pairs  $(u\bar{u}, d\bar{d}, s\bar{s})$  in the quark model:  $\pi^0 = (u\bar{u} - d\bar{d})/\sqrt{2}$ ,  $\eta = (u\bar{u} + d\bar{d} - 2s\bar{s})/\sqrt{6}$  and  $\eta' = (u\bar{u} + d\bar{d} + s\bar{s})/\sqrt{3}$ . Whether such a similarity is suggestive of something deeper remains an open question.

(3) The “bimaximal” flavor mixing pattern [453, 454], which can be obtained from a product of two rotation matrices in the (2,3) and (1,2) planes with the same rotation angles  $\theta_{23} = \theta_{12} = 45^\circ$ :

$$U_0 = \frac{1}{2} \begin{pmatrix} \sqrt{2} & \sqrt{2} & 0 \\ -1 & 1 & \sqrt{2} \\ 1 & -1 & \sqrt{2} \end{pmatrix}. \quad (105)$$

Therefore, this simple ansatz predicts  $\theta_{12} = \theta_{23} = 45^\circ$  and  $\theta_{13} = 0^\circ$  in the standard parametrization.

<sup>21</sup>Note that this special flavor mixing pattern will become stable after small corrections to it (i.e., the term  $\Delta U$ ) are introduced by slightly breaking the flavor democracy of the corresponding fermion mass matrix [138, 139]. Its most salient feature should be  $\theta_{23} > 45^\circ$ .

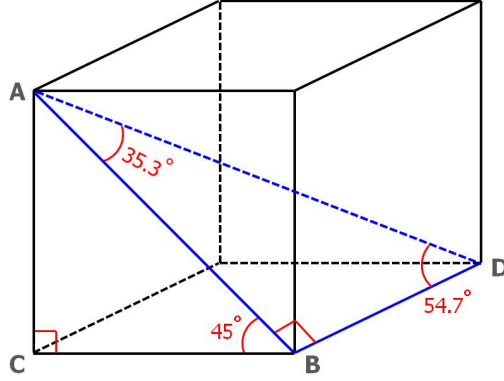

Figure 16: An intuitive geometrical illustration of  $\theta_{12} = \angle ABC = 45^\circ$  and  $\theta_{23} = \angle ADB = \arctan(\sqrt{2}) \simeq 54.7^\circ$  in the “democratic” flavor mixing pattern, or  $\theta_{12} = \angle BAD = \arctan(1/\sqrt{2}) \simeq 35.3^\circ$  and  $\theta_{23} = \angle ABC = 45^\circ$  in the “tribimaximal” flavor mixing pattern by using the right triangles  $\triangle ABC$  and  $\triangle ABD$  within a cube.

(4) The “tribimaximal” flavor mixing pattern [140, 141, 142], which has much in common with the aforementioned “democratic” flavor mixing pattern and thus can be viewed as a twisted form of Eq. (104) with the same entries<sup>22</sup>:

$$U_0 = \frac{1}{\sqrt{6}} \begin{pmatrix} -2 & \sqrt{2} & 0 \\ 1 & \sqrt{2} & -\sqrt{3} \\ 1 & \sqrt{2} & \sqrt{3} \end{pmatrix}. \quad (106)$$

It predicts  $\theta_{12} = \arctan(1/\sqrt{2}) \simeq 35.3^\circ$ ,  $\theta_{13} = 0^\circ$  and  $\theta_{23} = 45^\circ$  in the standard parametrization after a proper phase redefinition, where the special value of  $\theta_{12}$  can also find a simple geometrical interpretation in Fig. 16. One may see that the values of  $\theta_{12}$  and  $\theta_{23}$  predicted by Eq. (106) are very close to their best-fit results listed in Table 10. That is why this ansatz has attracted the most attention and praise in building neutrino mass models based on some discrete flavor symmetry groups, such as  $A_4$  [455, 456, 457, 458] and  $S_4$  [459, 460, 461, 462]. Its strange name comes from the fact that it can actually be obtained from the trimaximal flavor mixing pattern in Eq. (103) multiplied by a bimaximal (1,3)-rotation matrix on the right-hand side.

(5) The “hexagonal” flavor mixing pattern [463, 464, 465], which contains a special rotation angle  $\theta_{12} = 30^\circ$  equal to half of the external angle of the hexagon:

$$U_0 = \frac{1}{4} \begin{pmatrix} 2\sqrt{3} & 2 & 0 \\ -\sqrt{2} & \sqrt{6} & 2\sqrt{2} \\ \sqrt{2} & -\sqrt{6} & 2\sqrt{2} \end{pmatrix}. \quad (107)$$

This simple ansatz predicts  $\theta_{12} = 30^\circ$ ,  $\theta_{13} = 0^\circ$  and  $\theta_{23} = 45^\circ$  in the standard parametrization of  $U$ , and its phenomenological consequences on neutrino oscillations are quite similar to those of the tribimaximal flavor mixing pattern.

<sup>22</sup>Note that a very similar flavor mixing ansatz, which is equivalent to an interchange between the first and second columns of  $U_0$  in Eq. (106), was first conjectured by Wolfenstein in 1978 [451].

In the literature some more constant flavor mixing patterns, such as the “golden-ratio” pattern with  $\theta_{12} = \arctan[2/(1 + \sqrt{5})] \simeq 31.7^\circ$ ,  $\theta_{13} = 0^\circ$  and  $\theta_{23} = 45^\circ$  [466, 467] and the “tetra-maximal” mixing pattern with  $\theta_{12} = \arctan(2 - \sqrt{2}) \simeq 30.4^\circ$ ,  $\theta_{13} = \arcsin[(2 - \sqrt{2})/4] \simeq 8.4^\circ$ ,  $\theta_{23} = 45^\circ$  and  $\delta_\nu = \pm 90^\circ$  [468], have also been proposed. They are somewhat more complicated than those discussed above, although their entries remain to be simple functions of the integers 1, 2, 3, 5 and their square roots. After the measurement of an unsuppressed value of  $\theta_{13}$  in the Daya Bay reactor antineutrino oscillation experiment [15], a systematic survey of the constant flavor mixing patterns with nonzero  $\theta_{13}$  has been done in Ref. [469].

Of course, a simple constant flavor mixing pattern does not mean that it is really close to the truth or can easily be derived from a simple flavor symmetry model. For instance, a natural derivation of the “democratic” flavor mixing pattern as the leading term of a viable PMNS matrix  $U$  for massive Dirac neutrinos needs to introduce the flavor symmetry  $S_4 \times Z_2 \times Z'_2$  in a warped extra-dimensional model with a complicated custodial symmetry [470]. To simultaneously accommodate nonzero  $\theta_{13}$  and large  $\delta_\nu$ , a combination of proper flavor symmetry groups with generalized CP transformation has become quite popular in recent model-building exercises (see section 7.4.3 for some more discussions).

## 4. Descriptions of flavor mixing and CP violation

### 4.1. Rephasing invariants and commutators

#### 4.1.1. The Jarlskog invariants of CP violation

In the standard three-family scheme the phenomena of flavor mixing and CP violation are described by the  $3 \times 3$  PMNS matrix  $U$  in the lepton sector and the  $3 \times 3$  CKM matrix  $V$  in the quark sector, respectively, as shown by Eq. (1). Both of them involve some arbitrary phases because there always exists some freedom in redefining the phases of relevant lepton and quark fields. The moduli of  $U_{\alpha i}$  (for  $\alpha = e, \mu, \tau$  and  $i = 1, 2, 3$ ) or  $V_{\alpha i}$  (for  $\alpha = u, c, t$  and  $i = d, s, b$ ) are certainly rephasing-invariant, and thus they are physical observables.

There is a unique rephasing invariant of the PMNS matrix  $U$  or the CKM matrix  $V$ , the so-called Jarlskog invariant of CP violation [471, 472]:

$$\begin{aligned} \mathcal{J}_\nu \sum_\gamma \varepsilon_{\alpha\beta\gamma} \sum_k \varepsilon_{ijk} &= \text{Im} \left( U_{\alpha i} U_{\beta j} U_{\alpha j}^* U_{\beta i}^* \right), \\ \mathcal{J}_q \sum_\gamma \varepsilon_{\alpha\beta\gamma} \sum_k \varepsilon_{ijk} &= \text{Im} \left( V_{\alpha i} V_{\beta j} V_{\alpha j}^* V_{\beta i}^* \right), \end{aligned} \quad (108)$$

where the Latin and Greek subscripts for leptons or quarks are self-explanatory, and  $\varepsilon_{\alpha\beta\gamma}$  (or  $\varepsilon_{ijk}$ ) denotes the three-dimensional Levi-Civita symbol. Given the standard parametrization of  $U$  or  $V$  in Eq. (2), it is straightforward to obtain

$$\begin{aligned} \mathcal{J}_\nu &= \frac{1}{8} \sin 2\theta_{12} \sin 2\theta_{13} \sin 2\theta_{23} \cos \theta_{13} \sin \delta_\nu, \\ \mathcal{J}_q &= \frac{1}{8} \sin 2\vartheta_{12} \sin 2\vartheta_{13} \sin 2\vartheta_{23} \cos \vartheta_{13} \sin \delta_q. \end{aligned} \quad (109)$$

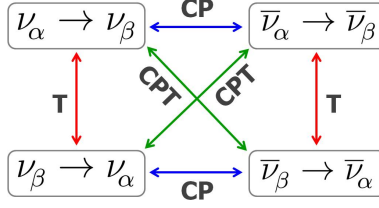

Figure 17: An illustration of different neutrino or antineutrino oscillations under CP, T and CPT transformations.

In view of the best-fit values of the CKM parameters given in Eq. (83) and the PMNS parameters listed in Table 10, we are left with  $\mathcal{J}_q \simeq A^2 \lambda^6 \bar{\eta} \simeq 3.2 \times 10^{-5}$  in the quark sector and  $\mathcal{J}_\nu \simeq -2.8 \times 10^{-2}$  in the lepton sector. These two rephasing invariants measure the strength of CP violation in quark decays and that in neutrino oscillations, respectively. To see this point in a more transparent way, let us compare Eq. (108) with Eqs. (82) and (85). Then we find

$$\begin{aligned} \tan \alpha &= -\frac{\mathcal{J}_q}{\text{Re}(V_{tb} V_{ud} V_{td}^* V_{ub}^*)}, \\ \tan \beta &= -\frac{\mathcal{J}_q}{\text{Re}(V_{cb} V_{td} V_{cd}^* V_{tb}^*)}, \\ \tan \gamma &= -\frac{\mathcal{J}_q}{\text{Re}(V_{ub} V_{cd} V_{ud}^* V_{cb}^*)}, \end{aligned} \quad (110)$$

for three inner angles of the CKM unitarity triangle shown in Fig. 10; and

$$P(\nu_\alpha \rightarrow \nu_\beta) = \delta_{\alpha\beta} - 4 \sum_{i<j} \left[ \text{Re}(U_{\alpha i} U_{\beta j} U_{\alpha j}^* U_{\beta i}^*) \sin^2 \frac{\Delta m_{ji}^2 L}{4E} \right] + 8\mathcal{J}_\nu \sum_\gamma \varepsilon_{\alpha\beta\gamma} \prod_{i<j} \sin \frac{\Delta m_{ji}^2 L}{4E}, \quad (111)$$

for flavor oscillations of massive neutrinos. That is why  $\mathcal{J}_q$  is solely responsible for all the weak CP-violating effects in the SM, and  $\mathcal{J}_\nu$  is the only measure of leptonic CP violation in neutrino oscillations. Under CP, T and CPT transformations, as illustrated by Fig. 17, one may obtain the corresponding oscillation probabilities  $P(\bar{\nu}_\alpha \rightarrow \bar{\nu}_\beta)$ ,  $P(\nu_\beta \rightarrow \nu_\alpha)$  and  $P(\bar{\nu}_\beta \rightarrow \bar{\nu}_\alpha)$  from Eq. (111) with the simple replacements  $(U, \mathcal{J}_\nu) \rightarrow (U^*, -\mathcal{J}_\nu)$ ,  $(U, \mathcal{J}_\nu) \rightarrow (U^*, -\mathcal{J}_\nu)$  and  $(U, \mathcal{J}_\nu) \rightarrow (U, \mathcal{J}_\nu)$ , respectively. Of course, matter effects can contaminate the genuine signals of CP and T violation and even give rise to a fake signal of CPT violation in a medium [339, 473, 474].

The unitarity of the CKM matrix  $V$  allows us to express  $\mathcal{J}_q$  in terms of the moduli of its four independent matrix elements [137, 314, 475, 476]. Namely,

$$\mathcal{J}_q^2 = |V_{\alpha i}|^2 |V_{\beta j}|^2 |V_{\alpha j}|^2 |V_{\beta i}|^2 - \frac{(1 + |V_{\alpha i}|^2 |V_{\beta j}|^2 + |V_{\alpha j}|^2 |V_{\beta i}|^2 - |V_{\alpha i}|^2 - |V_{\beta j}|^2 - |V_{\alpha j}|^2 - |V_{\beta i}|^2)^2}{4} \quad (112)$$

with  $\alpha \neq \beta$  and  $i \neq j$  running respectively over  $(u, c, t)$  and  $(d, s, b)$ . Similarly,  $\mathcal{J}_\nu$  can be expressed in terms of the moduli of four independent matrix elements of the PMNS matrix  $U$ . Eq. (112)

has two immediate implications: on the one hand, the elements of  $V$  or  $U$  must be measured to a sufficiently good degree of accuracy to guarantee the positivity of  $\mathcal{J}_q^2$  or  $\mathcal{J}_\nu^2$ ; on the other hand, the strength of CP violation can in principle be determined or constrained from the CP-conserving moduli of the CKM or PMNS matrix elements.

In general, there are totally  $(n-1)(n-2)/2$  independent Dirac phases of CP violation and  $[(n-1)(n-2)/2]^2$  distinct Jarlskog invariants for an  $n \times n$  unitary flavor mixing matrix, and it is a unique feature of the  $3 \times 3$  CKM or PMNS matrix that there exists a single CP-violating phase and a universal Jarlskog invariant of CP violation [477]. Given  $n = 4$ , for example, the flavor mixing matrix will have nine distinct Jarlskog invariants which depend on three independent Dirac phases of CP violation in different ways [478].

If the nature of massive neutrinos is of the Majorana type, one may define the following Jarlskog-like invariants for the  $3 \times 3$  unitary PMNS matrix  $U$  [333]:

$$\mathcal{V}_{\alpha\beta}^{ij} \equiv \text{Im} \left( U_{\alpha i} U_{\beta i} U_{\alpha j}^* U_{\beta j}^* \right), \quad (113)$$

where the Greek and Latin subscripts run over  $(e, \mu, \tau)$  and  $(1, 2, 3)$ , respectively. By this definition we find that  $\mathcal{V}_{\alpha\beta}^{ij} = \mathcal{V}_{\beta\alpha}^{ji} = -\mathcal{V}_{\alpha\beta}^{ji} = -\mathcal{V}_{\beta\alpha}^{ij}$  holds, and thus  $\mathcal{V}_{\alpha\beta}^{ii} = 0$  and  $\mathcal{V}_{\alpha\alpha}^{ij} \neq 0$  (for  $i \neq j$ ) hold. Then it is easy to verify that only nine  $\mathcal{V}_{\alpha\beta}^{ij}$  are independent. Given the standard parametrization of  $U$  in Eq. (2), one may easily figure out

$$\begin{aligned} \mathcal{V}_{ee}^{12} &= \cos^2 \theta_{12} \sin^2 \theta_{12} \cos^4 \theta_{13} \sin 2(\rho - \sigma), \\ \mathcal{V}_{ee}^{13} &= \cos^2 \theta_{12} \cos^2 \theta_{13} \sin^2 \theta_{13} \sin 2(\delta_\nu + \rho), \\ \mathcal{V}_{ee}^{23} &= \sin^2 \theta_{12} \cos^2 \theta_{13} \sin^2 \theta_{13} \sin 2(\delta_\nu + \sigma), \end{aligned} \quad (114)$$

and the expressions of other  $\mathcal{V}_{\alpha\beta}^{ij}$  [333]. Such CP-violating quantities are sensitive to the Majorana phases and will show up in the probabilities of lepton-number-violating  $\nu_\alpha \rightarrow \bar{\nu}_\beta$  oscillations.

#### 4.1.2. Commutators of fermion mass matrices

It is well known that any two observables in *matrix* Quantum Mechanics are represented by two Hermitian operators, and their commutator provides an elegant description of their compatibility — whether the two observables can be simultaneously measured or not. One may borrow the commutator language to describe quark flavor mixing and CP violation, because the latter just arise from a nontrivial mismatch between the up- and down-type quark mass matrices (or equivalently, a mismatch between the mass and flavor eigenstates of two quark sectors). To be specific, let us define the commutator of quark mass matrices  $M_u$  and  $M_d$  as follows [471]:

$$C_q \equiv i \left[ M_u M_u^\dagger, M_d M_d^\dagger \right] = i O_u \left( D_u^2 V D_d^2 V^\dagger - V D_d^2 V^\dagger D_u^2 \right) O_u^\dagger, \quad (115)$$

where Eq. (6) has been used to diagonalize  $M_u$  and  $M_d$ , and  $V = O_u^\dagger O_d$  is the CKM quark flavor mixing matrix. In fact,  $C_q$  is a Hermitian and traceless matrix of the form

$$C_q = i O_u \begin{pmatrix} 0 & (m_u^2 - m_c^2) Z_{uc} & (m_u^2 - m_t^2) Z_{ut} \\ (m_c^2 - m_u^2) Z_{cu} & 0 & (m_c^2 - m_t^2) Z_{ct} \\ (m_t^2 - m_u^2) Z_{tu} & (m_t^2 - m_c^2) Z_{tc} & 0 \end{pmatrix} O_u^\dagger \quad (116)$$

with  $Z_{\alpha\beta} = m_d^2 V_{\alpha d} V_{\beta d}^* + m_s^2 V_{\alpha s} V_{\beta s}^* + m_b^2 V_{\alpha b} V_{\beta b}^* = Z_{\beta\alpha}^*$  (for  $\alpha \neq \beta$  running over  $u, c, t$ ). This result implies that  $C_q = 0$  would hold if  $V$  were the identity matrix  $I$  (namely, if there were no flavor mixing). On the other hand, the determinant of  $C_q$  is

$$\det C_q = -2\mathcal{J}_q (m_u^2 - m_c^2)(m_c^2 - m_t^2)(m_t^2 - m_u^2)(m_d^2 - m_s^2)(m_s^2 - m_b^2)(m_b^2 - m_d^2), \quad (117)$$

proportional to the Jarlskog invariant  $\mathcal{J}_q$ . That is why  $\det C_q$  is equivalent to  $\mathcal{J}_q$  in signifying the existence of CP violation in the quark sector.

Note that CP would be a good symmetry if the masses of any two quarks of the same electric charge were degenerate. In this case it is always possible to remove the nontrivial phase of  $V$  and even arrange one of the elements of  $V$  to vanish [479, 480], and thus one is left with  $\mathcal{J}_q = 0$ . Namely,  $\det C_q$  does not contain any more information about CP violation than  $\mathcal{J}_q$ . The realistic condition for CP violation is the existence of at least one nontrivial phase difference between the quark mass matrices  $M_u$  and  $M_d$ , which in turn leads to  $\mathcal{J}_q \neq 0$  for the CKM matrix  $V$ .

The similar commutator language can be applied to the lepton sector. Given the charged-lepton mass matrix  $M_l$  in Eq. (6) and the Majorana neutrino mass matrix  $M_\nu$  in Eq. (16), we have

$$C_\nu \equiv i [M_l M_l^\dagger, M_\nu M_\nu^\dagger] = i O_l (D_l^2 U D_\nu^2 U^\dagger - U D_\nu^2 U^\dagger D_l^2) O_l^\dagger, \quad (118)$$

where  $U = O_l^\dagger O_\nu$  is the PMNS lepton flavor mixing matrix. Analogous to Eq. (117), the determinant of this leptonic commutator turns out to be

$$\det C_\nu = -2\mathcal{J}_\nu (m_e^2 - m_\mu^2)(m_\mu^2 - m_\tau^2)(m_\tau^2 - m_e^2)(m_1^2 - m_2^2)(m_2^2 - m_3^2)(m_3^2 - m_1^2), \quad (119)$$

which is proportional to the leptonic Jarlskog invariant  $\mathcal{J}_\nu$ . Given the nonzero but smallness of three neutrino mass-squared differences, we find  $|\det C_\nu| \ll |\det C_q|$  in spite of  $|\mathcal{J}_\nu| \gg |\mathcal{J}_q|$ .

When studying neutrino oscillations in matter, it is natural to attribute lepton flavor mixing and CP violation to the neutrino sector by choosing  $M_l = D_l$  (i.e.,  $O_l = I$ ). In this case  $M_\nu M_\nu^\dagger = U D_\nu^2 U^\dagger$  holds, and its effective counterpart in matter is  $\tilde{M}_\nu \tilde{M}_\nu^\dagger = \tilde{U} \tilde{D}_\nu^2 \tilde{U}^\dagger$  with  $\tilde{D}_\nu \equiv \text{Diag}\{\tilde{m}_1, \tilde{m}_2, \tilde{m}_3\}$ . Taking account of the effective Hamiltonian  $\mathcal{H}_m$  in Eq. (86), one finds [481, 482]

$$[D_l^2, \mathcal{H}_m] = \frac{1}{2E} [D_l^2, \tilde{M}_\nu \tilde{M}_\nu^\dagger] = \frac{1}{2E} [D_l^2, M_\nu M_\nu^\dagger], \quad (120)$$

simply because the matter potential in Eq. (86) commutes with  $D_l^2$ . A combination of this result with Eqs. (118) and (119) leads us to the equality  $\det \tilde{C}_\nu = \det C_\nu$ , which in turn leads us to the so-called Naumov relation [483]

$$\tilde{\mathcal{J}}_\nu \Delta \tilde{m}_{21}^2 \Delta \tilde{m}_{31}^2 \Delta \tilde{m}_{32}^2 = \mathcal{J}_\nu \Delta m_{21}^2 \Delta m_{31}^2 \Delta m_{32}^2, \quad (121)$$

where  $\Delta m_{ji}^2$  (for  $i, j = 1, 2, 3$ ) have been defined below Eq. (85),  $\Delta \tilde{m}_{ji}^2 \equiv \tilde{m}_j^2 - \tilde{m}_i^2$  are the analogs of  $\Delta m_{ji}^2$  in matter, and  $\tilde{\mathcal{J}}_\nu$  is the analog of  $\mathcal{J}_\nu$  in matter — the effective rephasing invariant of CP violation defined by the elements of  $\tilde{U}$ . The evolution of  $\tilde{\mathcal{J}}_\nu/\mathcal{J}_\nu$  with the matter parameter  $A \equiv 2EV_{\text{cc}}$  is illustrated in Fig. 18, where the best-fit values of  $\Delta m_{21}^2$ ,  $\Delta m_{31}^2$ ,  $\theta_{12}$  and  $\theta_{13}$  [92, 93]

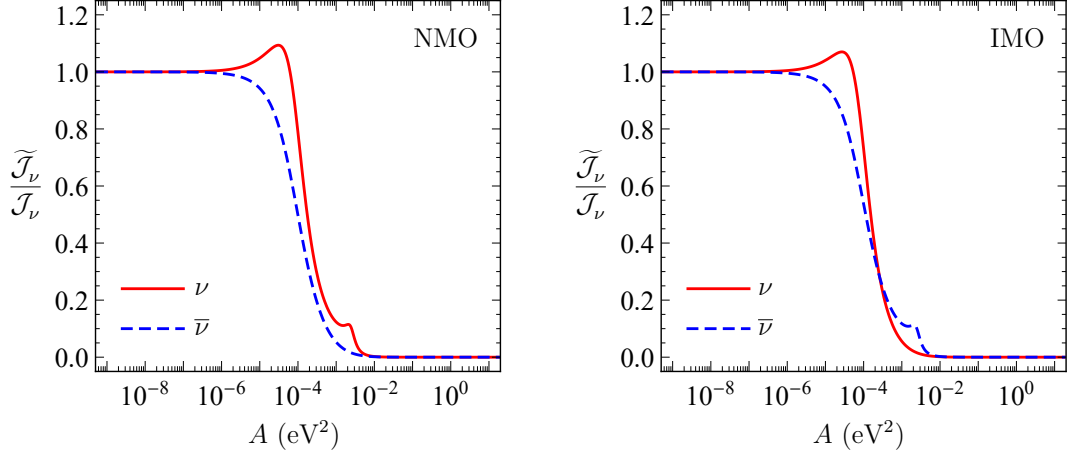

Figure 18: An illustration of the ratio  $\tilde{\mathcal{J}}_\nu/\mathcal{J}_\nu$  as a function of the neutrino ( $\nu$  with  $A$ ) or antineutrino ( $\bar{\nu}$  with  $-A$ ) beam energy  $E$  for the normal mass ordering (NMO, left panel) or inverted mass ordering (IMO, right panel), where the best-fit values of  $\Delta m_{21}^2$ ,  $\Delta m_{31}^2$ ,  $\theta_{12}$  and  $\theta_{13}$  [92, 93] have been input.

have been input<sup>23</sup>. The maxima and minima of the ratio  $\tilde{\mathcal{J}}_\nu/\mathcal{J}_\nu$  can be well understood after a proper analytical approximation is made for  $\tilde{\mathcal{J}}_\nu$  [484, 485].

If the canonical seesaw mechanism is taken into account, one may construct a commutator in terms of  $M_D^\dagger M_D$  and  $M_R^\dagger M_R$  to measure CP violation in the lepton-number-violating decays of heavy Majorana neutrinos [486]. Such a commutator language has some similarities with the weak-basis invariants of leptogenesis defined in Ref. [487]. On the other hand, a commutator in terms of  $M_l M_l^\dagger$  and  $M_D M_D^\dagger$  can serve as a basis-independent measure of CP violation associated with the lepton-flavor-violating decays of charged leptons.

## 4.2. Unitarity triangles of leptons and quarks

### 4.2.1. The CKM unitarity triangles of quarks

The SM requires that the CKM quark flavor mixing matrix  $V$  be unitary. This requirement means that the elements of  $V$  must satisfy Eq. (76), among which the six orthogonality relations define six triangles in the complex plane — the CKM unitarity triangles:

$$\begin{aligned}
\Delta_u &: V_{cd}^* V_{td} + V_{cs}^* V_{ts} + V_{cb}^* V_{tb} = 0, \\
\Delta_c &: V_{td}^* V_{ud} + V_{ts}^* V_{us} + V_{tb}^* V_{ub} = 0, \\
\Delta_t &: V_{ud}^* V_{cd} + V_{us}^* V_{cs} + V_{ub}^* V_{cb} = 0; \\
\Delta_d &: V_{us}^* V_{ub} + V_{cs}^* V_{cb} + V_{ts}^* V_{tb} = 0, \\
\Delta_s &: V_{ub}^* V_{ud} + V_{cb}^* V_{cd} + V_{tb}^* V_{td} = 0, \\
\Delta_b &: V_{ud}^* V_{us} + V_{cd}^* V_{cs} + V_{td}^* V_{ts} = 0,
\end{aligned} \tag{122}$$

where each triangle is named after the flavor index that does not appear in its three sides. Fig. 19 is a schematic illustration of these triangles by roughly taking account of current experimental data

<sup>23</sup>The explicit expressions of  $\Delta \tilde{m}_{ji}^2$  in terms of  $A$ ,  $\Delta m_{ji}^2$  and the elements of  $U$  can be found in section 4.4.1.



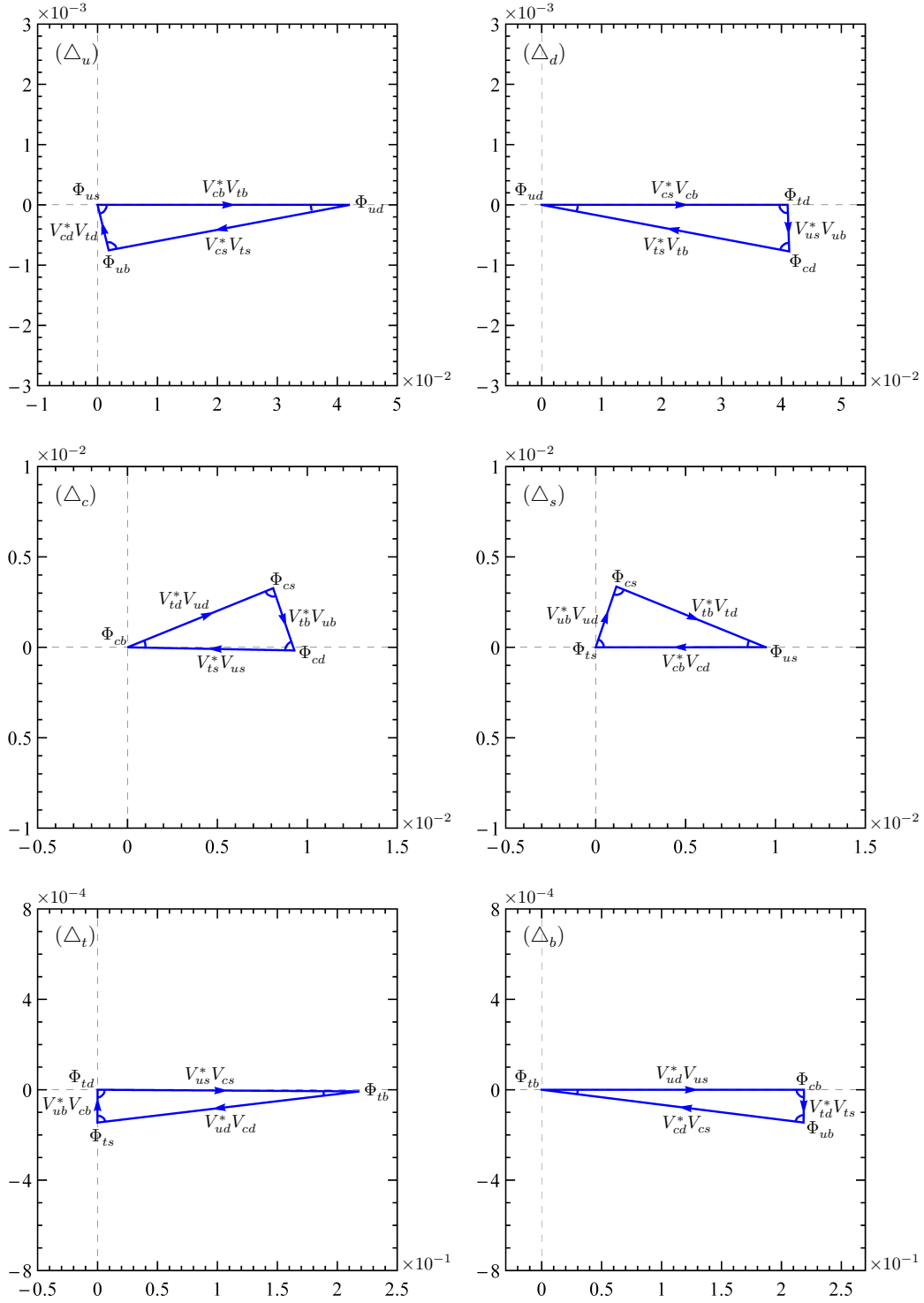

Figure 19: A schematic illustration of the six CKM unitarity triangles in the complex plane, where each triangle is named after the flavor index that does not show up in its three sides.

on the CKM matrix  $V$  [19]. Although the shapes of the six CKM unitarity triangles are different, they have the same area equal to  $\mathcal{J}_q/2 \simeq 1.6 \times 10^{-5}$ . So all of them would collapse into lines if CP were invariant in the quark sector.

An immediate observation is that the six unitarity triangles share nine inner angles defined by

$$\Phi_{\alpha i} \equiv \arg \left( -\frac{V_{\beta j}^* V_{\gamma j}}{V_{\beta k}^* V_{\gamma k}} \right) = \arg \left( -\frac{V_{\beta j}^* V_{\beta k}}{V_{\gamma j}^* V_{\gamma k}} \right), \quad (123)$$

where the Greek subscripts  $(\alpha, \beta, \gamma)$  run co-cyclically over  $(u, c, t)$ , and the Latin subscripts  $(i, j, k)$  run co-cyclically over  $(d, s, b)$ . Then one may write out the so-called CKM phase matrix [488, 489]

$$\Phi = \begin{pmatrix} \Phi_{ud} & \Phi_{us} & \Phi_{ub} \\ \Phi_{cd} & \Phi_{cs} & \Phi_{cb} \\ \Phi_{td} & \Phi_{ts} & \Phi_{tb} \end{pmatrix}. \quad (124)$$

It is clear that each row or column of the matrix  $\Phi$  corresponds to three inner angles of a unitarity triangle, and hence  $\Phi_{\alpha d} + \Phi_{\alpha s} + \Phi_{\alpha b} = \Phi_{ui} + \Phi_{ci} + \Phi_{ti} = \pi$  holds (for  $\alpha = u, c, t$  and  $i = d, s, b$ ). With the help of the Wolfenstein parametrization in Eq. (79), it is easy to calculate all the nine angles  $\Phi_{\alpha i}$  in terms of the Wolfenstein parameters. For instance, the three smallest angles are  $\Phi_{tb} \simeq \arctan(A^2 \lambda^4 \eta) \simeq 0.04^\circ$ ,  $\Phi_{ud} \simeq \arctan(\lambda^2 \eta) \simeq 1^\circ$  and  $\Phi_{us} \simeq \arctan[\eta / (1 - \rho)] \simeq 22^\circ$ . These three angles roughly measure the strengths of CP-violating effects in some weak decays of  $D$ ,  $K$  and  $B$  mesons [490, 491]. Current LHCb and Belle II experiments are focusing on more precision measurements of the twin  $b$ -flavored  $\Delta_s$  and  $\Delta_c$ , both their sides and their inner angles. In fact,  $\Delta_s$  has been rescaled in Fig. 10, where  $\alpha = \Phi_{cs}$ ,  $\beta = \Phi_{us}$  and  $\gamma = \Phi_{ts}$ . A similar analysis of the rescaled  $\Delta_s$  has recently been done in Ref. [492].

#### 4.2.2. The PMNS unitarity triangles of leptons

In the lepton sector the PMNS unitarity triangles [137, 493] can also serve as an intuitive language to geometrically describe lepton flavor mixing and CP violation. A prerequisite in this regard is certainly the assumption that the  $3 \times 3$  PMNS matrix  $U$  is exactly unitary. Since massive neutrinos are very likely to be the Majorana particles, it makes sense to classify the six PMNS unitarity triangles into the following two categories [494].

- The three Dirac triangles defined by the orthogonality relations

$$\begin{aligned} \Delta_e &: U_{\mu 1} U_{\tau 1}^* + U_{\mu 2} U_{\tau 2}^* + U_{\mu 3} U_{\tau 3}^* = 0, \\ \Delta_\mu &: U_{\tau 1} U_{e 1}^* + U_{\tau 2} U_{e 2}^* + U_{\tau 3} U_{e 3}^* = 0, \\ \Delta_\tau &: U_{e 1} U_{\mu 1}^* + U_{e 2} U_{\mu 2}^* + U_{e 3} U_{\mu 3}^* = 0, \end{aligned} \quad (125)$$

which have nothing to do with the Majorana phases of  $U$ .

- The three Majorana triangles defined by the orthogonality relations

$$\begin{aligned} \Delta_1 &: U_{e 2} U_{e 3}^* + U_{\mu 2} U_{\mu 3}^* + U_{\tau 2} U_{\tau 3}^* = 0, \\ \Delta_2 &: U_{e 3} U_{e 1}^* + U_{\mu 3} U_{\mu 1}^* + U_{\tau 3} U_{\tau 1}^* = 0, \\ \Delta_3 &: U_{e 1} U_{e 2}^* + U_{\mu 1} U_{\mu 2}^* + U_{\tau 1} U_{\tau 2}^* = 0, \end{aligned} \quad (126)$$

whose orientations are fixed by the Majorana phases of  $U$ .

In Figs. 20 and 21 we illustrate the shapes of these six triangles in the complex plane by using the best-fit values of the PMNS parameters [92, 93]. Their areas are all equal to  $|\mathcal{J}_\nu|/2 \simeq 1.4 \times 10^{-2}$ , implying the existence of appreciable effects of CP violation in neutrino oscillations.

Similar to Eq. (123), the inner angles of the PMNS unitarity triangles can be defined as

$$\phi_{\alpha i} \equiv \arg \left[ -\frac{U_{\beta j} U_{\gamma j}^*}{U_{\beta k} U_{\gamma k}^*} \right] = \arg \left[ -\frac{U_{\beta j} U_{\beta k}^*}{U_{\gamma j} U_{\gamma k}^*} \right], \quad (127)$$

where the Greek and Latin subscripts keep their cyclic running over  $(e, \mu, \tau)$  and  $(1, 2, 3)$ , respectively. The corresponding phase matrix turns out to be

$$\phi = \begin{pmatrix} \phi_{e1} & \phi_{e2} & \phi_{e3} \\ \phi_{\mu1} & \phi_{\mu2} & \phi_{\mu3} \\ \phi_{\tau1} & \phi_{\tau2} & \phi_{\tau3} \end{pmatrix}, \quad (128)$$

whose elements satisfy the simple sum rules  $\phi_{\alpha 1} + \phi_{\alpha 2} + \phi_{\alpha 3} = \phi_{ei} + \phi_{\mu i} + \phi_{\tau i} = \pi$  (for  $\alpha = e, \mu, \tau$  and  $i = 1, 2, 3$ ) [496]. Note that all the nine  $\phi_{\alpha i}$  are rephasing-invariant, and hence they are independent of the two Majorana phases of  $U$ . One way to reflect the Majorana nature of the PMNS matrix  $U$  is to define the Majorana phases as  $\psi_{\alpha i} \equiv \arg(U_{\alpha j} U_{\alpha k}^*)$  [497], where the Latin subscripts run cyclically over  $(1, 2, 3)$ . These phases are apparently independent of the phases of three charged-lepton fields, and they form a new phase matrix of the form

$$\psi = \begin{pmatrix} \psi_{e1} & \psi_{e2} & \psi_{e3} \\ \psi_{\mu1} & \psi_{\mu2} & \psi_{\mu3} \\ \psi_{\tau1} & \psi_{\tau2} & \psi_{\tau3} \end{pmatrix}. \quad (129)$$

The nine elements in the three rows of  $\psi$  satisfy the sum rules  $\psi_{\alpha 1} + \psi_{\alpha 2} + \psi_{\alpha 3} = 0$  (for  $\alpha = e, \mu, \tau$ ) [494, 496], but those in the three columns do not have a definite correlation. This observation means that the number of independent parameters in  $\psi$  is six instead of four. A comparison between Eqs. (128) and (129) leads us to  $\phi_{\alpha i} = \psi_{\beta i} - \psi_{\gamma i} \pm \pi$  with the Greek subscripts running cyclically over  $(e, \mu, \tau)$ , and the sign “ $\pm$ ” should be properly taken to guarantee  $\phi_{\alpha i} \in [0, \pi)$ .

### 4.3. Euler-like parametrizations of $U$ and $V$

#### 4.3.1. Nine distinct Euler-like parametrizations

A  $3 \times 3$  flavor mixing matrix  $X$  can be expressed as a product of three unitary matrices  $R_{12}$ ,  $R_{13}$  and  $R_{23}$ , which correspond to the Euler-like rotations in the complex  $(1, 2)$ ,  $(1, 3)$  and  $(2, 3)$  planes:

$$\begin{aligned} R_{12}(\theta_{12}, \alpha_{12}, \beta_{12}, \gamma_{12}) &= \begin{pmatrix} c_{12} e^{i\alpha_{12}} & s_{12} e^{-i\beta_{12}} & 0 \\ -s_{12} e^{i\beta_{12}} & c_{12} e^{-i\alpha_{12}} & 0 \\ 0 & 0 & e^{i\gamma_{12}} \end{pmatrix}, \\ R_{13}(\theta_{13}, \alpha_{13}, \beta_{13}, \gamma_{13}) &= \begin{pmatrix} c_{13} e^{i\alpha_{13}} & 0 & s_{13} e^{-i\beta_{13}} \\ 0 & e^{i\gamma_{13}} & 0 \\ -s_{13} e^{i\beta_{13}} & 0 & c_{13} e^{-i\alpha_{13}} \end{pmatrix}, \\ R_{23}(\theta_{23}, \alpha_{23}, \beta_{23}, \gamma_{23}) &= \begin{pmatrix} e^{i\gamma_{23}} & 0 & 0 \\ 0 & c_{23} e^{i\alpha_{23}} & s_{23} e^{-i\beta_{23}} \\ 0 & -s_{23} e^{i\beta_{23}} & c_{23} e^{-i\alpha_{23}} \end{pmatrix}, \end{aligned} \quad (130)$$

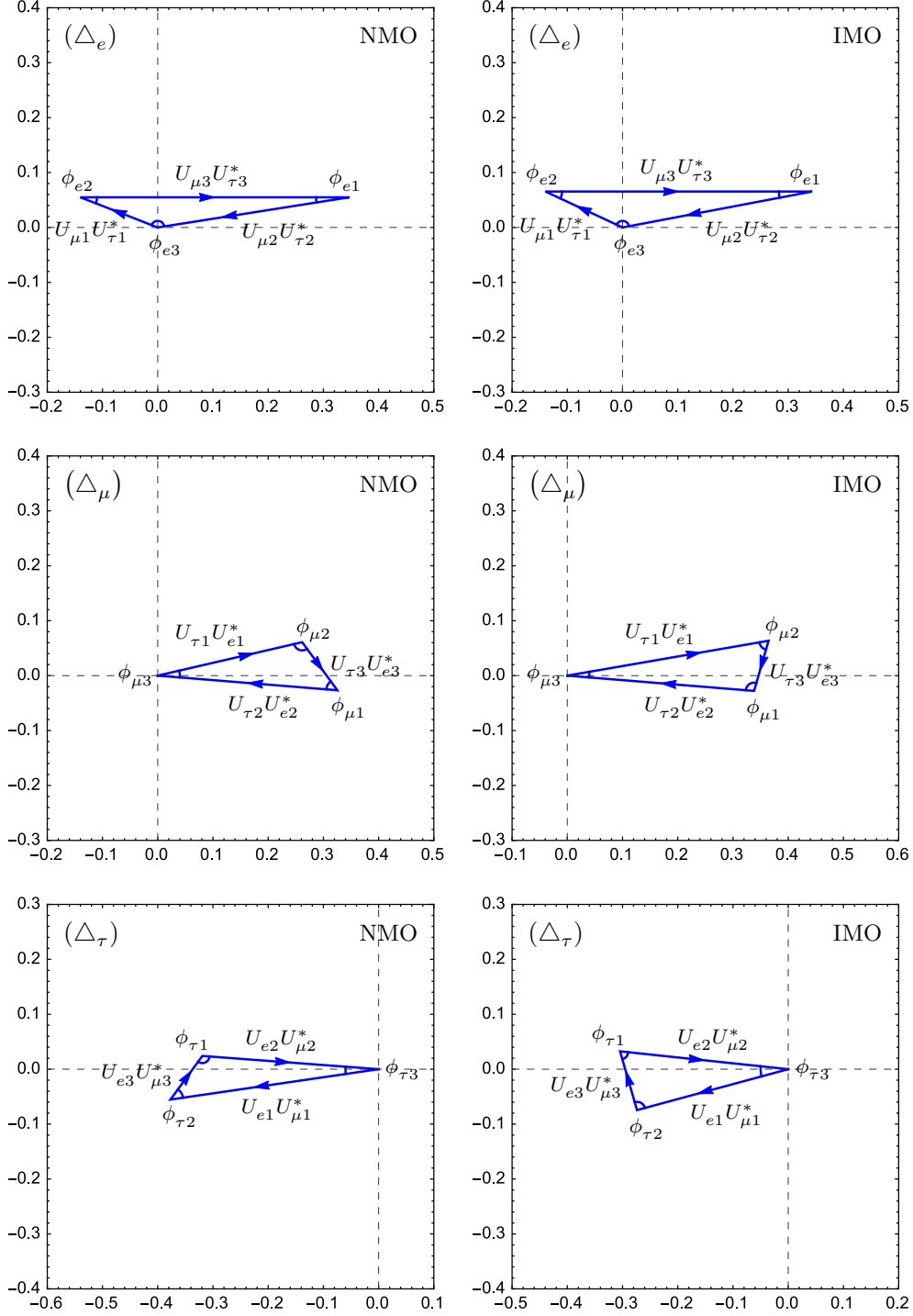

Figure 20: An illustration of three Dirac unitarity triangles of the PMNS matrix  $U$  in the complex plane, plotted by inputting the best-fit values of  $\theta_{12}$ ,  $\theta_{13}$ ,  $\theta_{23}$  and  $\delta$  [495] in the normal mass ordering (NMO, left panel) or inverted mass ordering (IMO, right panel) case.

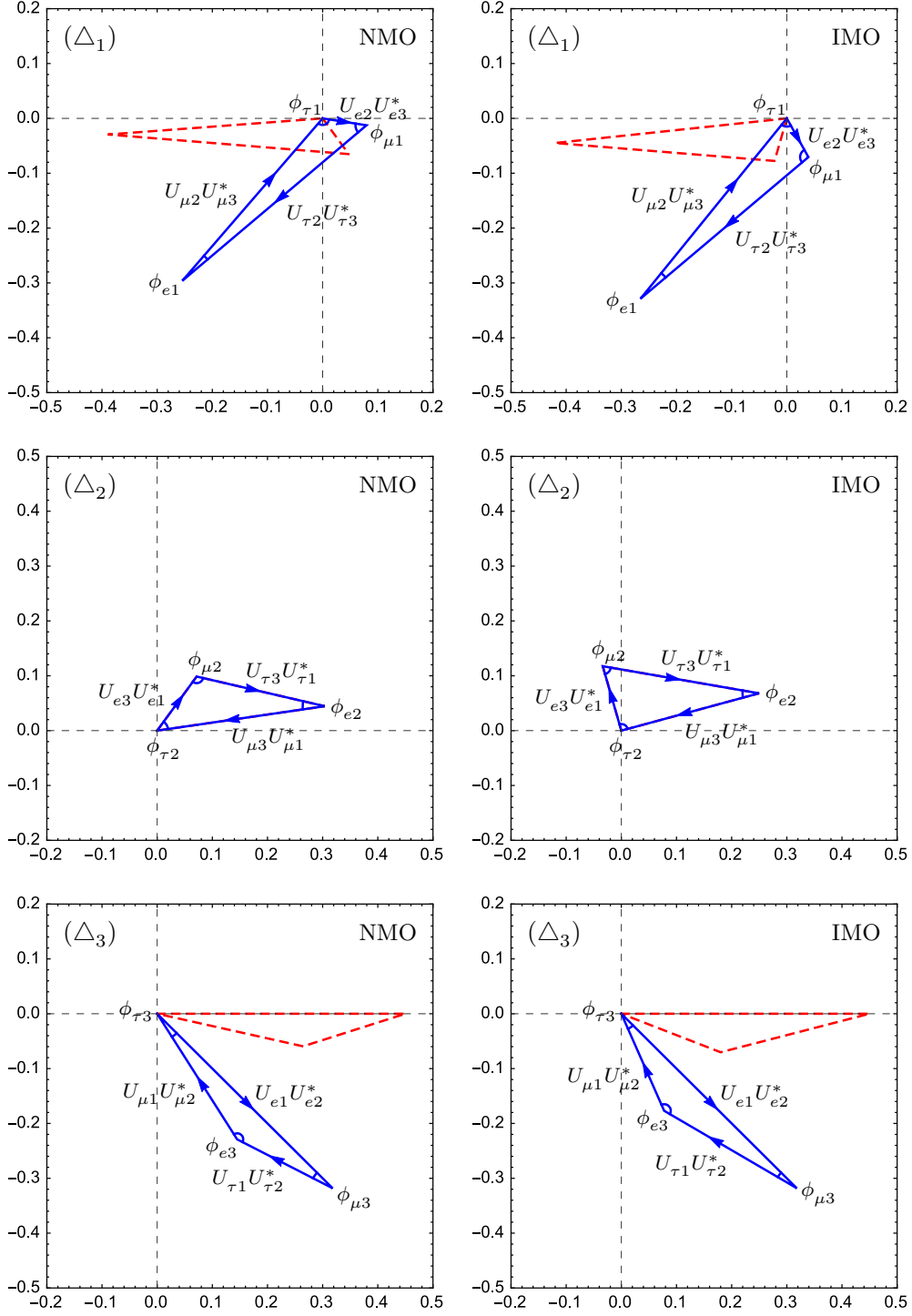

Figure 21: An illustration of three Majorana unitarity triangles of the PMNS matrix  $U$  in the complex plane, plotted by assuming the Majorana phases  $(\rho, \sigma) = (0, \pi/4)$  and inputting the best-fit values of  $\theta_{12}$ ,  $\theta_{13}$ ,  $\theta_{23}$  and  $\delta$  [495] in the NMO or IMO case. The dashed (red) triangles correspond to the  $(\rho, \sigma) = (0, 0)$  case for comparison.

where  $c_{ij} \equiv \cos \theta_{ij}$  and  $s_{ij} \equiv \sin \theta_{ij}$  (for  $ij = 12, 13, 23$ ). To cover the whole three-flavor space and provide a full description of the  $3 \times 3$  flavor mixing matrix  $X$ , we find that there are twelve distinct ways to arrange the products of  $R_{12}$ ,  $R_{13}$  and  $R_{23}$  [498]. To be explicit,

- six combinations of the form

$$X = R_{ij}(\theta_{ij}, \alpha_{ij}, \beta_{ij}, \gamma_{ij}) \otimes R_{mn}(\theta_{mn}, \alpha_{mn}, \beta_{mn}, \gamma_{mn}) \otimes R_{ij}(\theta'_{ij}, \alpha'_{ij}, \beta'_{ij}, \gamma'_{ij}) \quad (131)$$

with  $mn \neq ij$ , where the complex rotation matrix  $R_{ij}$  shows up twice;

- the other six combinations of the form

$$X = R_{ij}(\theta_{ij}, \alpha_{ij}, \beta_{ij}, \gamma_{ij}) \otimes R_{mn}(\theta_{mn}, \alpha_{mn}, \beta_{mn}, \gamma_{mn}) \otimes R_{kl}(\theta'_{kl}, \alpha'_{kl}, \beta'_{kl}, \gamma'_{kl}) \quad (132)$$

with  $mn \neq kl \neq ij$ , where the rotations are in three different complex planes.

Since the combinations  $R_{ij} \otimes R_{mn} \otimes R_{ij}$  and  $R_{ij} \otimes R_{kl} \otimes R_{ij}$  (for  $mn \neq kl$ ) are correlated with each other if the relevant phase parameters are switched off, they are topologically indistinguishable. We are therefore left with nine structurally distinct parametrizations for the flavor mixing matrix  $X$ : three of them from Eq. (131) and six from Eq. (132). These parametrizations are listed in Table 12 by taking account of only a single irreducible CP-violating phase.

To illustrate why only a single CP-violating phase of  $X$  is irreducible in rephasing the fermion fields, let us consider the following example:

$$\begin{aligned} X &= R_{23}(\theta_{23}, \alpha_{23}, \beta_{23}, \gamma_{23}) \otimes R_{13}(\theta_{13}, \alpha_{13}, \beta_{13}, \gamma_{13}) \otimes R_{12}(\theta_{12}, \alpha_{12}, \beta_{12}, \gamma_{12}) \\ &= P_\varphi \begin{pmatrix} c_{12}c_{13} & s_{12}c_{13} & s_{13}e^{-i\delta} \\ -s_{12}c_{23} - c_{12}s_{13}s_{23}e^{i\delta} & c_{12}c_{23} - s_{12}s_{13}s_{23}e^{i\delta} & c_{13}s_{23} \\ s_{12}s_{23} - c_{12}s_{13}c_{23}e^{i\delta} & -c_{12}s_{23} - s_{12}s_{13}c_{23}e^{i\delta} & c_{13}c_{23} \end{pmatrix} P_\phi \end{aligned} \quad (133)$$

with  $P_\varphi \equiv \text{Diag}\{e^{i\varphi_x}, e^{i\varphi_y}, e^{i\varphi_z}\}$  and  $P_\phi \equiv \text{Diag}\{e^{i\phi_x}, e^{i\phi_y}, e^{i\phi_z}\}$ , where  $\delta = \beta_{13} - \gamma_{12} - \gamma_{23}$  and

$$\begin{aligned} \varphi_x &= (\alpha_{12} - \alpha_{23}) - (\beta_{12} + \beta_{23}) + (\gamma_{23} - \gamma_{13}) , \\ \varphi_y &= -(\alpha_{13} + \beta_{23}) , \\ \varphi_z &= -(\alpha_{13} + \alpha_{23}) ; \\ \phi_x &= (\alpha_{13} + \alpha_{23}) + (\beta_{12} + \beta_{23}) + \gamma_{13} , \\ \phi_y &= (\alpha_{13} + \alpha_{23} - \alpha_{12}) + \beta_{23} + \gamma_{13} , \\ \phi_z &= \gamma_{12} . \end{aligned} \quad (134)$$

When quark flavor mixing is concerned,  $X = V$  is the CKM matrix. In this case one may remove both  $P_\varphi$  and  $P_\phi$  by redefining the phases of six quark fields, and thus only the CP-violating phase  $\delta = \delta_q$  survives in this standard parametrization. The same is true of the PMNS lepton flavor mixing matrix  $U$  if massive neutrinos are the Dirac particles. If massive neutrinos have the Majorana nature, however, only a common phase of the three neutrino fields can be redefined to remove one phase parameter in  $P_\phi$ . In this case Eq. (134) will be reduced to Eq. (2), in which  $U$  totally

Table 12: Nine topologically distinct Euler-like parametrizations of a  $3 \times 3$  unitary flavor mixing matrix in terms of three rotation angles and one CP-violating phase (i.e.,  $\alpha_{ij} = \beta_{ij} = 0$  and  $\gamma_{ij} \equiv \delta$  in Eq. (130) for  $ij = 12, 13$  or  $23$ ). The phase (or sign) convention of each parametrization is adjustable.

Product of three rotation matrices	Explicit parametrization pattern
(1) $R_{12}(\theta_{12}) \otimes R_{23}(\theta_{23}, \delta) \otimes R_{12}^T(\theta'_{12})$	$= \begin{pmatrix} s_{12}s'_{12}c_{23} + c_{12}c'_{12}e^{-i\delta} & s_{12}c'_{12}c_{23} - c_{12}s'_{12}e^{-i\delta} & s_{12}s_{23} \\ c_{12}s'_{12}c_{23} - s_{12}c'_{12}e^{-i\delta} & c_{12}c'_{12}c_{23} + s_{12}s'_{12}e^{-i\delta} & c_{12}s_{23} \\ -s'_{12}s_{23} & -c'_{12}s_{23} & c_{23} \end{pmatrix}$
(2) $R_{23}(\theta_{23}) \otimes R_{12}(\theta_{12}, \delta) \otimes R_{23}^T(\theta'_{23})$	$= \begin{pmatrix} c_{12} & s_{12}c'_{23} & -s_{12}s'_{23} \\ -s_{12}c_{23} & c_{12}c_{23}c'_{23} + s_{23}s'_{23}e^{-i\delta} & -c_{12}c_{23}s'_{23} + s_{23}c'_{23}e^{-i\delta} \\ s_{12}s_{23} & -c_{12}s_{23}c'_{23} + c_{23}s'_{23}e^{-i\delta} & c_{12}s_{23}s'_{23} + c_{23}c'_{23}e^{-i\delta} \end{pmatrix}$
(3) $R_{23}(\theta_{23}) \otimes R_{13}(\theta_{13}, \delta) \otimes R_{12}(\theta_{12})$	$= \begin{pmatrix} c_{12}c_{13} & s_{12}c_{13} & s_{13} \\ -c_{12}s_{13}s_{23} - s_{12}c_{23}e^{-i\delta} & -s_{12}s_{13}s_{23} + c_{12}c_{23}e^{-i\delta} & c_{13}s_{23} \\ -c_{12}s_{13}c_{23} + s_{12}s_{23}e^{-i\delta} & -s_{12}s_{13}c_{23} - c_{12}s_{23}e^{-i\delta} & c_{13}c_{23} \end{pmatrix}$
(4) $R_{12}(\theta_{12}) \otimes R_{13}(\theta_{13}, \delta) \otimes R_{23}^T(\theta_{23})$	$= \begin{pmatrix} c_{12}c_{13} & c_{12}s_{13}s_{23} + s_{12}c_{23}e^{-i\delta} & c_{12}s_{13}c_{23} - s_{12}s_{23}e^{-i\delta} \\ -s_{12}c_{13} & -s_{12}s_{13}s_{23} + c_{12}c_{23}e^{-i\delta} & -s_{12}s_{13}c_{23} - c_{12}s_{23}e^{-i\delta} \\ -s_{13} & c_{13}s_{23} & c_{13}c_{23} \end{pmatrix}$
(5) $R_{31}(\theta_{13}) \otimes R_{12}(\theta_{12}, \delta) \otimes R_{13}^T(\theta'_{13})$	$= \begin{pmatrix} c_{12}c_{13}c'_{13} + s_{13}s'_{13}e^{-i\delta} & s_{12}c_{13} & -c_{12}c_{13}s'_{13} + s_{13}c'_{13}e^{-i\delta} \\ -s_{12}c'_{13} & c_{12} & s_{12}s'_{13} \\ -c_{12}s_{13}c'_{13} + c_{13}s'_{13}e^{-i\delta} & -s_{12}s_{13} & c_{12}s_{13}s'_{13} + c_{13}c'_{13}e^{-i\delta} \end{pmatrix}$
(6) $R_{12}(\theta_{12}) \otimes R_{23}(\theta_{23}, \delta) \otimes R_{13}(\theta_{13})$	$= \begin{pmatrix} -s_{12}s_{13}s_{23} + c_{12}c_{13}e^{-i\delta} & s_{12}c_{23} & s_{12}c_{13}s_{23} + c_{12}s_{13}e^{-i\delta} \\ -c_{12}s_{13}s_{23} - s_{12}c_{13}e^{-i\delta} & c_{12}c_{23} & c_{12}c_{13}s_{23} - s_{12}s_{13}e^{-i\delta} \\ -s_{13}c_{23} & -s_{23} & c_{13}c_{23} \end{pmatrix}$
(7) $R_{23}(\theta_{23}) \otimes R_{12}(\theta_{12}, \delta) \otimes R_{13}^T(\theta_{13})$	$= \begin{pmatrix} c_{12}c_{13} & s_{12} & -c_{12}s_{13} \\ -s_{12}c_{13}c_{23} + s_{13}s_{23}e^{-i\delta} & c_{12}c_{23} & s_{12}s_{13}c_{23} + c_{13}s_{23}e^{-i\delta} \\ s_{12}c_{13}s_{23} + s_{13}c_{23}e^{-i\delta} & -c_{12}s_{23} & -s_{12}s_{13}s_{23} + c_{13}c_{23}e^{-i\delta} \end{pmatrix}$
(8) $R_{13}(\theta_{13}) \otimes R_{12}(\theta_{12}, \delta) \otimes R_{23}(\theta_{23})$	$= \begin{pmatrix} c_{12}c_{13} & s_{12}c_{13}c_{23} - s_{13}s_{23}e^{-i\delta} & s_{12}c_{13}s_{23} + s_{13}c_{23}e^{-i\delta} \\ -s_{12} & c_{12}c_{23} & c_{12}s_{23} \\ -c_{12}s_{13} & -s_{12}s_{13}c_{23} - c_{13}s_{23}e^{-i\delta} & -s_{12}s_{13}s_{23} + c_{13}c_{23}e^{-i\delta} \end{pmatrix}$
(9) $R_{13}(\theta_{13}) \otimes R_{23}(\theta_{23}, \delta) \otimes R_{12}^T(\theta_{12})$	$= \begin{pmatrix} -s_{12}s_{13}s_{23} + c_{12}c_{13}e^{-i\delta} & -c_{12}s_{13}s_{23} - s_{12}c_{13}e^{-i\delta} & s_{13}c_{23} \\ s_{12}c_{23} & c_{12}c_{23} & s_{23} \\ -s_{12}c_{13}s_{23} - c_{12}s_{13}e^{-i\delta} & -c_{12}c_{13}s_{23} + s_{12}s_{13}e^{-i\delta} & c_{13}c_{23} \end{pmatrix}$

contains three nontrivial CP-violating phases (i.e.,  $\delta = \delta_\nu$ ,  $\rho$  and  $\sigma$ ) together with three flavor mixing angles ( $\theta_{12}$ ,  $\theta_{13}$  and  $\theta_{23}$ ). Note that only  $\delta_\nu$  is sensitive to leptonic CP violation in normal neutrino-neutrino and antineutrino-antineutrino oscillations, and hence it is absolutely necessary to include such a phase parameter in Table 12.

Besides the Euler-like parametrizations, one may certainly parametrize the CKM matrix  $V$  or the PMNS matrix  $U$  in some different ways. In the quark sector, the Wolfenstein parametrization of  $V$  is most popular because it can naturally reflect the hierarchical structure of quark flavor mixing. In the lepton sector, combining a constant flavor mixing pattern with the Wolfenstein-like perturbations is a realistic and popular way to parametrize the  $3 \times 3$  PMNS matrix  $U$  [464, 499, 500, 501, 502, 503]. But the standard Euler-like parametrization of  $U$  in Eq. (2) is most favored in neutrino oscillation phenomenology, as will be discussed below.

#### 4.3.2. Which parametrization is favored?

Although all the parametrizations of the CKM matrix  $V$  or the PMNS matrix  $U$  are “scientifically indistinguishable”, “they are not psychologically identical” in the description of flavor issues [504]. That is why it makes sense to ask which parametrization is favored in phenomenology or model building, based on the criterion that a favorite choice should be able to make the underlying physics more transparent or establish some direct and simpler relations between the model parameters and experimental observables [505]. Among nine Euler-like parametrizations of the  $3 \times 3$  fermion flavor mixing matrix listed in Table 12, a few of them are expected to be particularly favored in describing lepton or quark flavor problems, including neutrino oscillations.

Pattern (1), which can be easily reduced to the famous Euler rotation matrix by switching off the phase parameter, was first proposed for quark flavor mixing in terms of the following notation and phase convention [505]:

$$V = \begin{pmatrix} V_{ud} & V_{us} & V_{ub} \\ V_{cd} & V_{cs} & V_{cb} \\ V_{td} & V_{ts} & V_{tb} \end{pmatrix} = \begin{pmatrix} s_u s_d c + c_u c_d e^{-i\varphi} & s_u c_d c - c_u s_d e^{-i\varphi} & s_u s \\ c_u s_d c - s_u c_d e^{-i\varphi} & c_u c_d c + s_u s_d e^{-i\varphi} & c_u s \\ -s_d s & -c_d s & c \end{pmatrix}, \quad (135)$$

where  $c_u \equiv \cos \vartheta_u$ ,  $s_d \equiv \sin \vartheta_d$ ,  $c \equiv \cos \vartheta$  and  $s \equiv \sin \vartheta$ . Given the best-fit values of the moduli of  $|V_{\alpha i}|$  (for  $\alpha = u, c, t$  and  $i = d, s, b$ ) listed in Table 8, we obtain  $\vartheta \simeq 2.4^\circ$ ,  $\vartheta_u \simeq 5.0^\circ$ ,  $\vartheta_d \simeq 12.3^\circ$  and  $\varphi \simeq 90^\circ$ . It is worth emphasizing that this parametrization is of particular interest for describing both the heavy-quark flavor mixing effects and the Fritzsche-like textures of quark mass matrices [134, 505, 506, 507, 508, 509]. For example,

$$\begin{aligned} \tan \vartheta_u &= \left| \frac{V_{ub}}{V_{cb}} \right| \simeq \sqrt{\frac{m_u}{m_c}}, \\ \tan \vartheta_d &= \left| \frac{V_{td}}{V_{ts}} \right| \simeq \sqrt{\frac{m_d}{m_s}}, \end{aligned} \quad (136)$$

which can also be understood in a model-independent way in the heavy-quark mass limits (i.e.,  $m_t \rightarrow \infty$  and  $m_b \rightarrow \infty$ , as will be discussed in section 6.1.1) [275]. A careful analysis tells us that the so-called Cabibbo triangle defined by  $V_{us} = s_u c_d c - c_u s_d e^{-i\varphi}$  in the complex plane is approximately congruent with the rescaled CKM unitarity triangle  $\Delta_s$  that has been shown in Fig. 10 [505, 510], and thus  $\varphi \simeq \alpha \simeq 90^\circ$  holds to a very good degree of accuracy. In other words, both triangles are essentially the right triangles [511, 512]. Since  $\varphi$  actually measures the phase difference between the up- and down-type quark sectors, its special value might be suggestive of something deeper about CP violation.



Pattern (1) is also advantageous to the description of lepton flavor mixing and CP violation:

$$U = \begin{pmatrix} U_{e1} & U_{e2} & U_{e3} \\ U_{\mu 1} & U_{\mu 2} & U_{\mu 3} \\ U_{\tau 1} & U_{\tau 2} & U_{\tau 3} \end{pmatrix} = \begin{pmatrix} s_l s_\nu c + c_l c_\nu e^{-i\phi} & s_l c_\nu c - c_l s_\nu e^{-i\phi} & s_l s \\ c_l s_\nu c - s_l c_\nu e^{-i\phi} & c_l c_\nu c + s_l s_\nu e^{-i\phi} & c_l s \\ -s_\nu s & -c_\nu s & c \end{pmatrix} P_\nu, \quad (137)$$

where  $c_l \equiv \cos \theta_l$ ,  $s_\nu \equiv \sin \theta_\nu$ ,  $c \equiv \cos \theta$  and  $s \equiv \sin \theta$  are defined in the lepton sector, and the phase matrix  $P_\nu = \text{Diag}\{e^{i\rho}, e^{i\sigma}, 1\}$  contains two extra Majorana phases. Given the best-fit values  $\theta_{12} \simeq 33.5^\circ$ ,  $\theta_{13} \simeq 8.4^\circ$ ,  $\theta_{23} \simeq 47.9^\circ$  and  $\delta_\nu \simeq 237.6^\circ$  in the standard parametrization of  $U$  listed in Table 10 for the normal neutrino mass ordering [92], we obtain  $\theta \simeq 48.5^\circ$ ,  $\theta_l \simeq 11.3^\circ$ ,  $\theta_\nu \simeq 37.8^\circ$  and  $\phi \simeq 306.6^\circ$ . Since the elements  $U_{\tau i}$  (for  $i = 1, 2, 3$ ) in Eq. (137) are rather simple functions of  $\theta_\nu$  and  $\theta$ , they will make the expressions of the one-loop RGEs of  $\theta_l$ ,  $\theta_\nu$ ,  $\theta$  and  $\phi$  impressively simplified — much simpler than those obtained by using the standard parametrization of  $U$  [513], as one will clearly see in section 4.5.3.

Pattern (2) is equivalent to the original Kobayashi-Maskawa parametrization of quark flavor mixing and CP violation [21], but it seems to be more appropriate for describing lepton flavor mixing and neutrino oscillations in matter. In fact, the structure of this parametrization and those of patterns (3) and (7) listed in Table 12 have a common feature: the rotation matrix on the left-hand side of the PMNS matrix  $U$  is  $R_{23}(\theta_{23})$ , which can commute with the diagonal matter potential matrix given in Eq. (86). This commutative property allows one to derive an exact relation between the effective parameters  $(\widetilde{\theta}_{23}, \widetilde{\delta}_\nu)$  in matter and their genuine counterparts  $(\theta_{23}, \delta_\nu)$  in vacuum [436, 440, 514] — the so-called Toshev relation [515], provided the matter-corrected PMNS matrix  $\widetilde{U}$  takes the same parametrization as  $U$ :

$$\sin \widetilde{\delta}_\nu \sin 2\widetilde{\theta}_{23} = \sin \delta_\nu \sin 2\theta_{23}. \quad (138)$$

If  $\theta_{23} = \pi/4$  and  $\delta_\nu = \pm\pi/2$  hold in vacuum, Eq. (138) implies that  $\widetilde{\theta}_{23} = \pi/4$  and  $\widetilde{\delta}_\nu = \pm\pi/2$  must simultaneously hold in matter [439, 440, 516]. In other words, matter effects respect the  $\mu$ - $\tau$  reflection symmetry of three massive neutrinos, which naturally leads us to  $|U_{\mu i}| = |U_{\tau i}|$  and  $|\widetilde{U}_{\mu i}| = |\widetilde{U}_{\tau i}|$  (for  $i = 1, 2, 3$ ). This simple flavor symmetry dictates  $\theta_{23} = \pi/4$  and  $\delta_\nu = \pm\pi/2$  to hold in patterns (2), (3) and (7) of the Euler-like parametrizations of  $U$ .

Pattern (3) is just the standard parametrization of the CKM matrix  $V$  or the PMNS matrix  $U$  advocated by the Particle Data Group [19], but its phase convention is different from the one taken in Eq. (2) for  $U$ . This parametrization becomes most popular today in neutrino phenomenology, simply because its first row and third column are so simple that the three flavor mixing angles can be directly related to the dominant effects of solar ( $\theta_{12}$ ), atmospheric ( $\theta_{23}$ ), accelerator ( $\theta_{23}$ ) and reactor ( $\theta_{12}$  or  $\theta_{13}$ ) neutrino (antineutrino) oscillations. On the other hand, the smallest PMNS matrix element  $U_{e3}$  is determined by the smallest neutrino mixing angle  $\theta_{13}$ , and the smallest CKM matrix element  $V_{ub}$  is analogously determined by the smallest quark mixing angle  $\vartheta_{13}$ . Another merit of this parametrization for lepton flavor mixing and CP violation is that it allows the interesting Toshev relation in Eq. (138) to hold, and therefore it is also useful for describing long-baseline neutrino oscillations in terrestrial matter.

Pattern (3) is also a convenient choice for describing the effective electron-neutrino mass term of the  $\beta$  decays (i.e.,  $\langle m \rangle_e$ ) in Eq. (92) and that of the  $0\nu 2\beta$  decays (i.e.,  $\langle m \rangle_{ee}$ ) in Eq. (93), as they

only depend on the PMNS matrix elements  $U_{ei}$  (for  $i = 1, 2, 3$ ) which are simple functions of  $\theta_{12}$  and  $\theta_{13}$ . In addition, one may adjust the phase convention of  $U$  to make  $|\langle m \rangle_{ee}|$  rely only on two Majorana phases. In comparison, parametrization (1) in Eq. (137) would make the expressions of  $\langle m \rangle_e$  and  $\langle m \rangle_{ee}$  rather complicated, and hence it seems less useful in this connection.

Pattern (5) has a special structure in the sense that its ‘‘central element’’ has the simplest form:  $V_{cs} = \cos \vartheta_{12}$  or  $U_{\mu 2} = \cos \theta_{12}$ . A unique feature of this parametrization is that its three flavor mixing angles are comparably large and the CP-violating phase is strongly suppressed [517]. For example,  $\vartheta_{12} \simeq 13.2^\circ$ ,  $\vartheta_{13} \simeq 10.4^\circ$ ,  $\vartheta'_{13} \simeq 10.6^\circ$  and  $\delta_q \simeq 1.1^\circ$  in the quark sector; while  $\theta_{12} \simeq 53.6^\circ$ ,  $\theta_{13} \simeq 47.3^\circ$ ,  $\theta'_{13} \simeq 65.8^\circ$  and  $\delta_\nu \simeq 22.6^\circ$  in the lepton sector, where the best-fit values of quark and lepton flavor mixing parameters in the standard parametrization of  $V$  or  $U$  have been input [19, 92]. In other words, the three flavor mixing angles in this parametrization are essentially democratic, and the CP-violating phase turns out to be minimal as compared with the other eight Euler-like parametrizations. Nevertheless, such a parametrization of the CKM matrix  $V$  or the PMNS matrix  $U$  might not be very convenient in model building or neutrino phenomenology, simply because neither the observed pattern of  $V$  nor that of  $U$  exhibits a transparently ‘‘centralized’’ structure around  $V_{cs}$  or  $U_{\mu 2}$ .

In short, whether a specific parametrization of  $V$  or  $U$  is favored depends on the specific problems to be dealt with. None of the parametrizations proposed in the literature can be convenient for all the flavor problems of leptons or quarks. Nevertheless, the standard parametrization of  $U$  in Eq. (2) and the Wolfenstein parametrization of  $V$  in Eq. (81) have popularly been used in both the experimental and theoretical aspects of flavor physics.

#### 4.4. The effective PMNS matrix in matter

##### 4.4.1. Sum rules and asymptotic behaviors

When a neutrino beam travels in a medium, its flavor components may undergo coherent forward scattering with matter via weak charged-current and neutral-current interactions. This kind of MSW matter effects [83, 84] will in general modify the behaviors of neutrino oscillations, as briefly discussed in section 3.3.1. The effective Hamiltonian describing the propagation of a neutrino beam in matter has been given in Eq. (86) with definitions of the effective neutrino masses  $\tilde{m}_i$  (for  $i = 1, 2, 3$ ) and the effective PMNS matrix  $\tilde{U}$ . It is therefore possible to write out the matter-corrected probabilities of neutrino oscillations in the same form as those in vacuum, and the only thing left is to establish some direct analytical relations between the relevant effective quantities and their counterparts in vacuum.

Since the probabilities of neutrino oscillations depend on the neutrino mass-squared differences instead of the absolute neutrino masses, it proves to be more convenient to rewrite the effective Hamiltonian in Eq. (86) as follows:

$$\begin{aligned} \mathcal{H}'_m &= \frac{1}{2E} \left[ U \begin{pmatrix} 0 & 0 & 0 \\ 0 & \Delta m_{21}^2 & 0 \\ 0 & 0 & \Delta m_{31}^2 \end{pmatrix} U^\dagger + A \begin{pmatrix} 1 & 0 & 0 \\ 0 & 0 & 0 \\ 0 & 0 & 0 \end{pmatrix} \right] \\ &= \frac{1}{2E} \left[ \tilde{U} \begin{pmatrix} 0 & 0 & 0 \\ 0 & \Delta \tilde{m}_{21}^2 & 0 \\ 0 & 0 & \Delta \tilde{m}_{31}^2 \end{pmatrix} \tilde{U}^\dagger + B \begin{pmatrix} 1 & 0 & 0 \\ 0 & 1 & 0 \\ 0 & 0 & 1 \end{pmatrix} \right], \end{aligned} \quad (139)$$

where  $\Delta m_{ji}^2$  and  $\Delta \widetilde{m}_{ji}^2$  (for  $i, j = 1, 2, 3$ ) have been defined below Eqs. (85) and (121), respectively;  $A = 2EV_{\text{cc}}$  and  $B = \widetilde{m}_1^2 - m_1^2 - 2EV_{\text{nc}}$  describe the matter effects. The trace of  $\mathcal{H}'_{\text{m}}$  leads us to  $3B = \Delta m_{21}^2 + \Delta m_{31}^2 + A - \Delta \widetilde{m}_{21}^2 - \Delta \widetilde{m}_{31}^2$ . Given the analytical expressions of  $\widetilde{m}_i^2$  (for  $i = 1, 2, 3$ ) in Refs. [334, 518, 519], it is straightforward to obtain

$$\begin{aligned}\Delta \widetilde{m}_{21}^2 &= \frac{2}{3} \sqrt{x^2 - 3y} \sqrt{3(1 - z^2)} , \\ \Delta \widetilde{m}_{31}^2 &= \frac{1}{3} \sqrt{x^2 - 3y} \left[ 3z + \sqrt{3(1 - z^2)} \right] , \\ B &= \frac{1}{3}x - \frac{1}{3} \sqrt{x^2 - 3y} \left[ z + \sqrt{3(1 - z^2)} \right]\end{aligned}\quad (140)$$

for the normal neutrino mass ordering (i.e.,  $m_1 < m_2 < m_3$  or  $\Delta m_{31}^2 > 0$ ); or

$$\begin{aligned}\Delta \widetilde{m}_{21}^2 &= \frac{1}{3} \sqrt{x^2 - 3y} \left[ 3z - \sqrt{3(1 - z^2)} \right] , \\ \Delta \widetilde{m}_{31}^2 &= -\frac{2}{3} \sqrt{x^2 - 3y} \sqrt{3(1 - z^2)} , \\ B &= \frac{1}{3}x - \frac{1}{3} \sqrt{x^2 - 3y} \left[ z - \sqrt{3(1 - z^2)} \right]\end{aligned}\quad (141)$$

for the inverted mass ordering (i.e.,  $m_3 < m_1 < m_2$  or  $\Delta m_{31}^2 < 0$ ), where  $x, y$  and  $z$  are given by

$$\begin{aligned}x &= \Delta m_{21}^2 + \Delta m_{31}^2 + A , \\ y &= \Delta m_{21}^2 \Delta m_{31}^2 + A \left[ \Delta m_{21}^2 (1 - |U_{e2}|^2) + \Delta m_{31}^2 (1 - |U_{e3}|^2) \right] , \\ z &= \cos \left[ \frac{1}{3} \arccos \frac{2x^3 - 9xy + 27A\Delta m_{21}^2 \Delta m_{31}^2 |U_{e1}|^2}{2 \sqrt{(x^2 - 3y)^3}} \right] .\end{aligned}\quad (142)$$

Note that Eqs. (139)—(142) are only valid for *neutrino* mixing and flavor oscillations in matter. When an *antineutrino* beam is concerned, the corresponding results can be directly read off from the above formulas by making the replacements  $U \rightarrow U^*$ ,  $A \rightarrow -A$  and  $V_{\text{nc}} \rightarrow -V_{\text{nc}}$ .

The expressions of  $\mathcal{H}'_{\text{m}}$  and  $\mathcal{H}''_{\text{m}}$ , together with the unitarity of  $\widetilde{U}$ , allow us to obtain a full set of linear equations for the three variables  $\widetilde{U}_{\alpha i} \widetilde{U}_{\beta i}^*$  (for  $i = 1, 2, 3$ ) as follows [520]:

$$\begin{aligned}\sum_{i=1}^3 \Delta \widetilde{m}_{i1}^2 \widetilde{U}_{\alpha i} \widetilde{U}_{\beta i}^* &= \sum_{i=1}^3 \Delta m_{i1}^2 U_{\alpha i} U_{\beta i}^* + A \delta_{\alpha\beta} - B \delta_{\alpha\beta} , \\ \sum_{i=1}^3 \Delta \widetilde{m}_{i1}^2 (\Delta \widetilde{m}_{i1}^2 + 2B) \widetilde{U}_{\alpha i} \widetilde{U}_{\beta i}^* &= \sum_{i=1}^3 \Delta m_{i1}^2 \left[ \Delta m_{i1}^2 + A(\delta_{\alpha\beta} + \delta_{\beta\alpha}) \right] U_{\alpha i} U_{\beta i}^* + A^2 \delta_{\alpha\beta} - B^2 \delta_{\alpha\beta} , \\ \sum_{i=1}^3 \widetilde{U}_{\alpha i} \widetilde{U}_{\beta i}^* &= \sum_{i=1}^3 U_{\alpha i} U_{\beta i}^* = \delta_{\alpha\beta} .\end{aligned}\quad (143)$$

The solutions turn out to be

$$\begin{aligned}
\widetilde{U}_{\alpha 1} \widetilde{U}_{\beta 1}^* &= \frac{\zeta - 2\xi B - \xi \Delta \widetilde{m}_{21}^2 - \xi \Delta \widetilde{m}_{31}^2 + \Delta \widetilde{m}_{21}^2 \Delta \widetilde{m}_{31}^2 \delta_{\alpha\beta}}{\Delta \widetilde{m}_{21}^2 \Delta \widetilde{m}_{31}^2}, \\
\widetilde{U}_{\alpha 2} \widetilde{U}_{\beta 2}^* &= \frac{\xi \Delta \widetilde{m}_{31}^2 + 2\xi B - \zeta}{\Delta \widetilde{m}_{21}^2 \Delta \widetilde{m}_{32}^2}, \\
\widetilde{U}_{\alpha 3} \widetilde{U}_{\beta 3}^* &= \frac{\zeta - 2\xi B - \xi \Delta \widetilde{m}_{21}^2}{\Delta \widetilde{m}_{31}^2 \Delta \widetilde{m}_{32}^2},
\end{aligned} \tag{144}$$

where

$$\begin{aligned}
\xi &= \Delta m_{21}^2 U_{\alpha 2} U_{\beta 2}^* + \Delta m_{31}^2 U_{\alpha 3} U_{\beta 3}^* + A \delta_{e\alpha} \delta_{e\beta} - B \delta_{\alpha\beta}, \\
\zeta &= \Delta m_{21}^2 \left[ \Delta m_{21}^2 + A(\delta_{e\alpha} + \delta_{e\beta}) \right] U_{\alpha 2} U_{\beta 2}^* + \Delta m_{31}^2 \left[ \Delta m_{31}^2 + A(\delta_{e\alpha} + \delta_{e\beta}) \right] U_{\alpha 3} U_{\beta 3}^* \\
&\quad + A^2 \delta_{e\alpha} \delta_{e\beta} - B^2 \delta_{\alpha\beta}.
\end{aligned} \tag{145}$$

As a result, one may easily obtain the exact formulas of nine  $|\widetilde{U}_{\alpha i}|^2$  (for  $\alpha = e, \mu, \tau$  and  $i = 1, 2, 3$ ) from Eq. (144) by taking  $\alpha = \beta$  as well as the exact expressions for the sides of three effective Dirac unitarity triangles in matter, defined as

$$\begin{aligned}
\widetilde{\Delta}_e : \quad & \widetilde{U}_{\mu 1} \widetilde{U}_{\tau 1}^* + \widetilde{U}_{\mu 2} \widetilde{U}_{\tau 2}^* + \widetilde{U}_{\mu 3} \widetilde{U}_{\tau 3}^* = 0, \\
\widetilde{\Delta}_\mu : \quad & \widetilde{U}_{\tau 1} \widetilde{U}_{e 1}^* + \widetilde{U}_{\tau 2} \widetilde{U}_{e 2}^* + \widetilde{U}_{\tau 3} \widetilde{U}_{e 3}^* = 0, \\
\widetilde{\Delta}_\tau : \quad & \widetilde{U}_{e 1} \widetilde{U}_{\mu 1}^* + \widetilde{U}_{e 2} \widetilde{U}_{\mu 2}^* + \widetilde{U}_{e 3} \widetilde{U}_{\mu 3}^* = 0,
\end{aligned} \tag{146}$$

from Eq. (144) by taking  $\alpha \neq \beta$ . In comparison with the genuine Dirac unitarity triangles  $\Delta_\alpha$  (for  $\alpha = e, \mu, \tau$ ) defined in Eq. (125), the shapes of  $\widetilde{\Delta}_\alpha$  will be deformed. This kind of geometric shape deformation is also reflected in Fig. 18, where the effective Jarlskog invariant  $\widetilde{\mathcal{J}}_v$  measures the areas of  $\widetilde{\Delta}_\alpha$  and its relationship with  $\mathcal{J}_v$  is described by the Naumov formula in Eq. (121).

To illustrate, let us consider the maximum value of  $\widetilde{\mathcal{J}}_v/\mathcal{J}_v$  shown in Fig. 18, which means the maximal matter-enhanced effect of CP violation. An elegant analytical approximation [484] leads us to  $\widetilde{\mathcal{J}}_v/\mathcal{J}_v \simeq 1/\sin 2\theta_{12} \simeq 1.09$  at  $A \simeq \Delta m_{21}^2 \cos 2\theta_{12} \simeq 2.87 \times 10^{-5} \text{ eV}^2$  with the best-fit input  $\theta_{12} \simeq 33.48^\circ$ . In this special case we obtain

$$\widetilde{\Delta}_e : \begin{cases} \widetilde{U}_{\mu 1} \widetilde{U}_{\tau 1}^* \simeq \frac{1}{\sin 2\theta_{12}} U_{\mu 1} U_{\tau 1}^* - \frac{1 - \tan \theta_{12}}{2} U_{\mu 3} U_{\tau 3}^* \simeq 1.09 U_{\mu 1} U_{\tau 1}^* - 0.17 U_{\mu 3} U_{\tau 3}^*, \\ \widetilde{U}_{\mu 2} \widetilde{U}_{\tau 2}^* \simeq \frac{1}{\sin 2\theta_{12}} U_{\mu 2} U_{\tau 2}^* - \frac{1 - \cot \theta_{12}}{2} U_{\mu 3} U_{\tau 3}^* \simeq 1.09 U_{\mu 2} U_{\tau 2}^* + 0.26 U_{\mu 3} U_{\tau 3}^*, \\ \widetilde{U}_{\mu 3} \widetilde{U}_{\tau 3}^* \simeq U_{\mu 3} U_{\tau 3}^*; \end{cases} \tag{147}$$

and

$$\widetilde{\Delta}_\mu : \begin{cases} \widetilde{U}_{\tau 1} \widetilde{U}_{e 1}^* \simeq \frac{1}{\sin 2\theta_{12}} U_{\tau 1} U_{e 1}^* - \frac{1 - \cot \theta_{12}}{2} U_{\tau 3} U_{e 3}^* \simeq 1.09 U_{\tau 1} U_{e 1}^* + 0.26 U_{\tau 3} U_{e 3}^*, \\ \widetilde{U}_{\tau 2} \widetilde{U}_{e 2}^* \simeq \frac{1}{\sin 2\theta_{12}} U_{\tau 2} U_{e 2}^* - \frac{1 - \tan \theta_{12}}{2} U_{\tau 3} U_{e 3}^* \simeq 1.09 U_{\tau 2} U_{e 2}^* - 0.17 U_{\tau 3} U_{e 3}^*, \\ \widetilde{U}_{\tau 3} \widetilde{U}_{e 3}^* \simeq U_{\tau 3} U_{e 3}^*; \end{cases} \tag{148}$$

as well as

$$\tilde{\Delta}_\tau : \begin{cases} \tilde{U}_{e1} \tilde{U}_{\mu1}^* \simeq \frac{1}{\sin 2\theta_{12}} U_{e1} U_{\mu1}^* - \frac{1 - \cot \theta_{12}}{2} U_{e3} U_{\mu3}^* \simeq 1.09 U_{e1} U_{\mu1}^* + 0.26 U_{e3} U_{\mu3}^* , \\ \tilde{U}_{e2} \tilde{U}_{\mu2}^* \simeq \frac{1}{\sin 2\theta_{12}} U_{e2} U_{\mu2}^* - \frac{1 - \tan \theta_{12}}{2} U_{e3} U_{\mu3}^* \simeq 1.09 U_{e2} U_{\mu2}^* - 0.17 U_{e3} U_{\mu3}^* , \\ \tilde{U}_{e3} \tilde{U}_{\mu3}^* \simeq U_{e3} U_{\mu3}^* , \end{cases} \quad (149)$$

from which the enhancement of the effective Jarlskog invariant  $\tilde{\mathcal{J}}$  and the deformation of each effective Dirac unitarity triangle can be seen in a transparent way.

Another interesting extreme case is the  $A \rightarrow \infty$  limit, in which the asymptotic behaviors of nine elements of  $\tilde{U}$  can well be understood. Let us consider four possibilities in the following.

- A neutrino beam with normal mass ordering. In the  $A \rightarrow \infty$  limit we simplify Eq. (140) and then obtain  $\Delta\tilde{m}_{21}^2 \simeq \Delta m_{31}^2 (1 - |U_{e3}|^2) - \Delta m_{21}^2 |U_{e1}|^2$  and  $\Delta\tilde{m}_{31}^2 \simeq \Delta\tilde{m}_{32}^2 \simeq A$  to a good degree of accuracy, and the pattern of  $\tilde{U}$  turns out to be

$$\tilde{U}|_{A \rightarrow \infty} \simeq \begin{pmatrix} 0 & 0 & 1 \\ \sqrt{1 - |U_{\mu3}|^2} & |U_{\mu3}| & 0 \\ -|U_{\mu3}| & \sqrt{1 - |U_{\mu3}|^2} & 0 \end{pmatrix}. \quad (150)$$

- A neutrino beam with inverted mass ordering. In this case we arrive at  $\Delta\tilde{m}_{21}^2 \simeq A$ ,  $\Delta\tilde{m}_{31}^2 \simeq \Delta m_{31}^2 (1 - |U_{e3}|^2) - \Delta m_{21}^2 |U_{e1}|^2$  and  $\Delta\tilde{m}_{32}^2 \simeq -A$  from Eq. (141) when  $A$  approaches infinity. The corresponding pattern of  $\tilde{U}$  is

$$\tilde{U}|_{A \rightarrow \infty} \simeq \begin{pmatrix} 0 & 1 & 0 \\ \sqrt{1 - |U_{\mu3}|^2} & 0 & |U_{\mu3}| \\ -|U_{\mu3}| & 0 & \sqrt{1 - |U_{\mu3}|^2} \end{pmatrix}. \quad (151)$$

- An antineutrino beam with normal mass ordering. In this case one should make the replacements  $U \rightarrow U^*$  and  $A \rightarrow -A$  for the exact formulas obtained above before doing the analytical approximations. In the  $A \rightarrow \infty$  limit we arrive at  $\Delta\tilde{m}_{21}^2 \simeq \Delta\tilde{m}_{31}^2 \simeq A$  and  $\Delta\tilde{m}_{32}^2 \simeq \Delta m_{31}^2 (1 - |U_{e3}|^2) - \Delta m_{21}^2 |U_{e1}|^2$ . The pattern of  $\tilde{U}$  becomes

$$\tilde{U}|_{A \rightarrow \infty} \simeq \begin{pmatrix} 1 & 0 & 0 \\ 0 & \sqrt{1 - |U_{\mu3}|^2} & |U_{\mu3}| \\ 0 & -|U_{\mu3}| & \sqrt{1 - |U_{\mu3}|^2} \end{pmatrix}. \quad (152)$$

- An antineutrino beam with inverted mass ordering. Here the replacements  $U \rightarrow U^*$  and  $A \rightarrow -A$  should be made for the exact formulas obtained above before doing the analytical

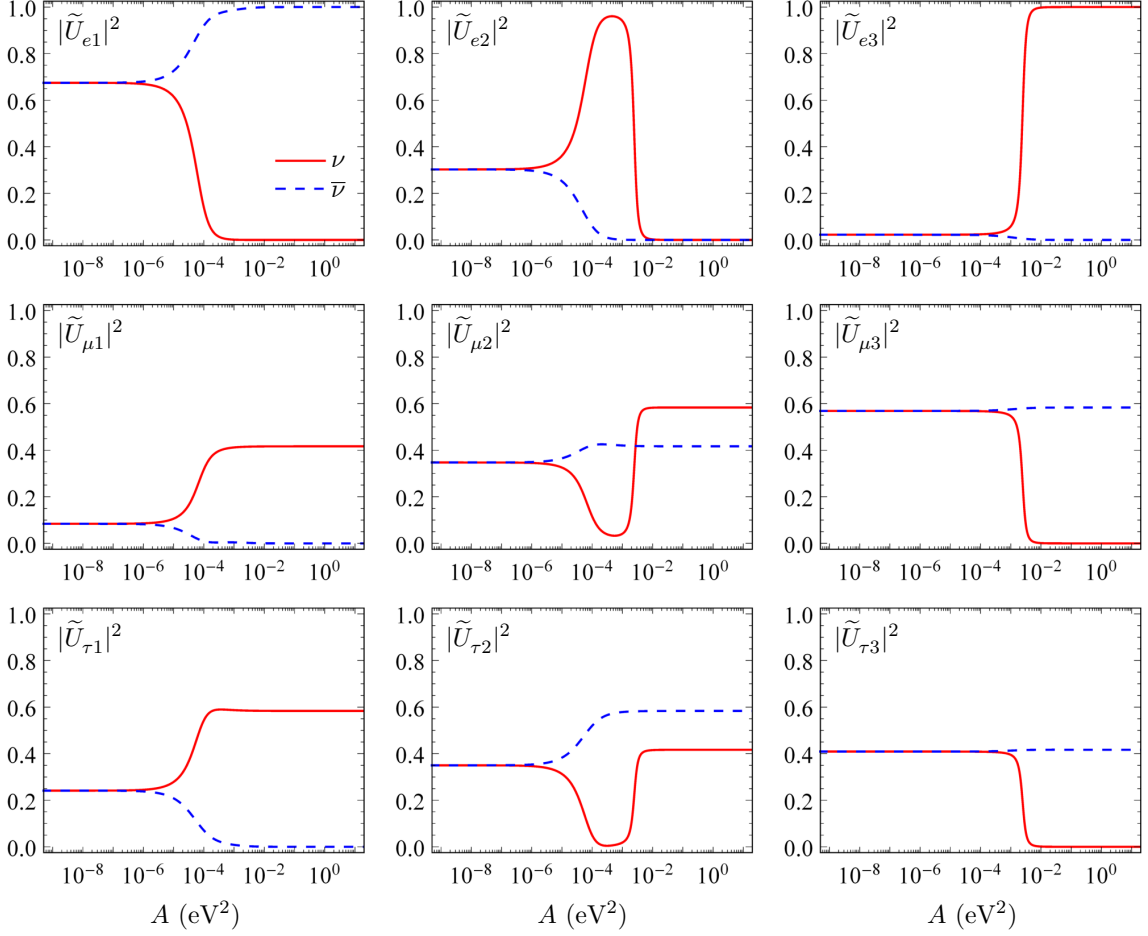

Figure 22: The evolution of  $|\tilde{U}_{\alpha i}|^2$  (for  $\alpha = e, \mu, \tau$  and  $i = 1, 2, 3$ ) with the matter parameter  $A$  in the normal neutrino mass ordering case, where the best-fit values of six neutrino oscillation parameters have been input [92, 93].

approximations. We obtain  $\Delta\tilde{m}_{21}^2 \simeq -\Delta m_{31}^2 (1 - |U_{e3}|^2) + \Delta m_{21}^2 |U_{e1}|^2$  and  $\Delta\tilde{m}_{31}^2 \simeq \Delta\tilde{m}_{32}^2 \simeq -A$  when the  $A \rightarrow \infty$  limit is taken. The pattern of  $\tilde{U}$  turns out to be

$$\tilde{U}|_{A \rightarrow \infty} \simeq \begin{pmatrix} 0 & 0 & 1 \\ |U_{\mu 3}| & \sqrt{1 - |U_{\mu 3}|^2} & 0 \\ -\sqrt{1 - |U_{\mu 3}|^2} & |U_{\mu 3}| & 0 \end{pmatrix}. \quad (153)$$

These analytical results can be used to explain the numerical results for the asymptotic behaviors of  $|\tilde{U}_{\alpha i}|^2$  (for  $\alpha = e, \mu, \tau$  and  $i = 1, 2, 3$ ) shown in Figs. 22 and 23 [520], where the best-fit values of six neutrino oscillation parameters have been input [92, 93]. They tell us that only one degree of freedom is left for the effective PMNS matrix  $\tilde{U}$  in very dense matter, which can be expressed in terms of the fundamental PMNS matrix element  $|U_{\mu 3}|$ . It becomes clear that  $\tilde{\mathcal{J}}_\nu \rightarrow 0$  in the  $A \rightarrow \infty$  limit, as one may see either numerically from Fig. 18 or analytically from Eq. (121).

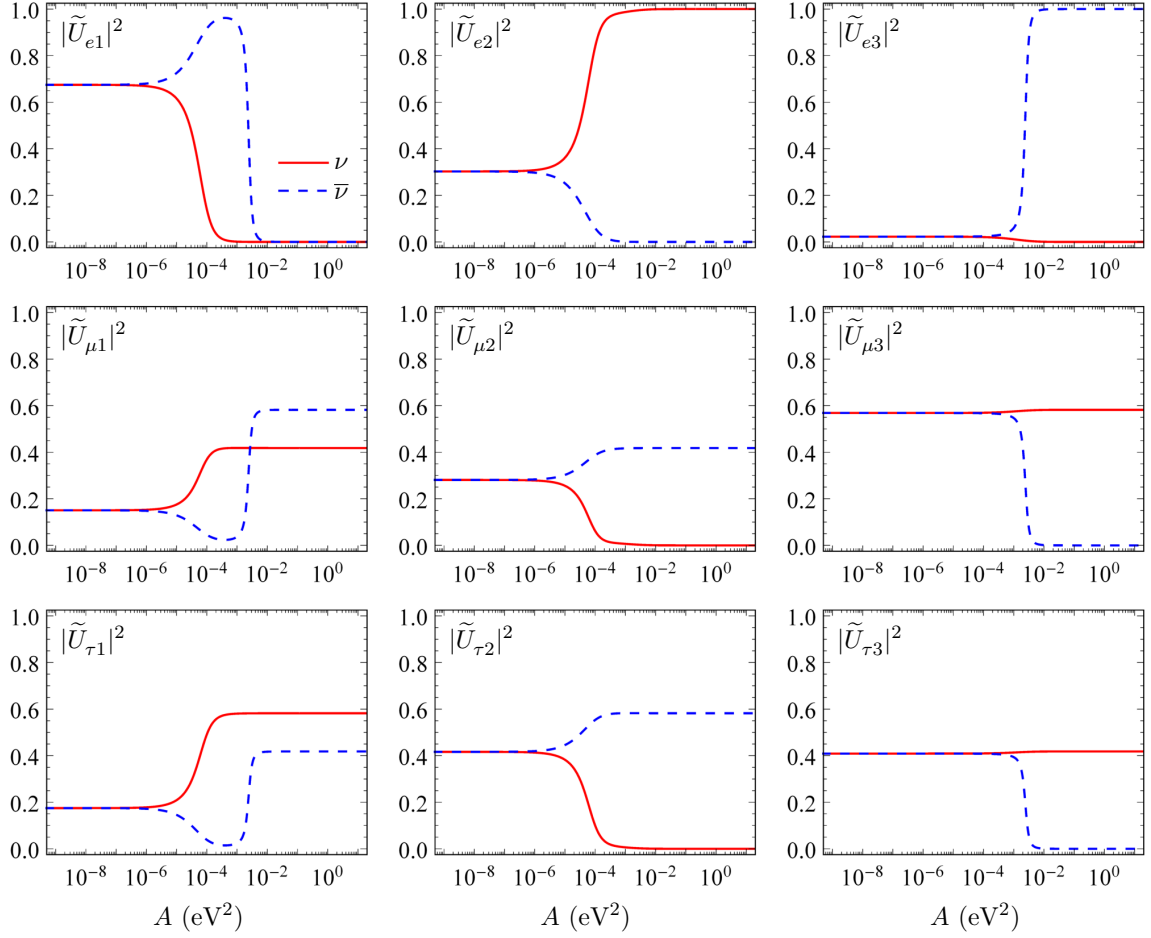

Figure 23: The evolution of  $|\tilde{U}_{\alpha i}|^2$  (for  $\alpha = e, \mu, \tau$  and  $i = 1, 2, 3$ ) with the matter parameter  $A$  in the inverted neutrino mass ordering case, where the best-fit values of six neutrino oscillation parameters have been input [92, 93].

In practice, one has to adopt a proper medium density profile to numerically calculate matter effects on neutrino oscillations when dealing with a neutrino (or antineutrino) beam travelling in a density-varying medium (e.g., inside the Sun). Moreover, the one-loop quantum correction to the matter potential in Eq. (88) or Eq. (141) should be taken into account if the medium is very dense (e.g., around the core of a neutron star or a supernova) [521].

#### 4.4.2. Differential equations of $\tilde{U}$

A recent development in the study of matter effects on neutrino mixing and CP violation is that the general idea of RGEs [522, 523] can be borrowed to understand how the effective neutrino mass-squared differences and flavor mixing parameters in a medium evolve with a scale-like variable — the matter parameter  $A$ . Such an approach implies that the genuine flavor quantities in vacuum can in principle be extrapolated from their matter-corrected counterparts to be measured in some realistic neutrino oscillation experiments [524]. Since the RGE method has been serving as a powerful tool in quantum field theories [6, 7], solid-state physics [525, 526] and some other

fields of modern physics to systematically describe the changes of a physical system as viewed at different distances or energy scales, the fact that it finds its application in neutrino mixing and flavor oscillations in matter is certainly interesting.

Given the effective Hamiltonian  $\mathcal{H}_m$  in Eq. (86), one may neglect the flavor-universal term  $V_{nc}$  and differentiating both sides of this equation with respect to the matter parameter  $A = 2EV_{cc}$ . Then it is straightforward to obtain

$$\frac{d\widetilde{D}_v^2}{dA} + \left[ \widetilde{U}^\dagger \frac{d\widetilde{U}}{dA}, \widetilde{D}_v^2 \right] = \widetilde{U}^\dagger \begin{pmatrix} 1 & 0 & 0 \\ 0 & 0 & 0 \\ 0 & 0 & 0 \end{pmatrix} \widetilde{U}, \quad (154)$$

where  $\widetilde{D} \equiv \text{Diag}\{\widetilde{m}_1, \widetilde{m}_2, \widetilde{m}_3\}$  is defined, the symbol  $[*, *]$  denotes the commutator of two matrices, and the unitarity of  $\widetilde{U}$  has been used. Taking the diagonal and off-diagonal elements for the two sides of Eq. (154) separately, we are left with

$$\frac{d\widetilde{m}_i^2}{dA} = |\widetilde{U}_{ei}|^2, \quad \sum_\alpha \widetilde{U}_{\alpha i}^* \frac{d\widetilde{U}_{\alpha j}}{dA} = \frac{\widetilde{U}_{ei}^* \widetilde{U}_{ej}}{\Delta\widetilde{m}_{ji}^2}, \quad (155)$$

where  $j \neq i$ ,  $i = 1, 2, 3$  and  $\alpha = e, \mu, \tau$ . With the help of the normalization and orthogonality conditions of  $\widetilde{U}$ , one finds

$$\frac{d\widetilde{U}_{\beta i}}{dA} = \sum_\alpha \frac{d\widetilde{U}_{\alpha i}}{dA} \widetilde{U}_{\alpha i}^* \widetilde{U}_{\beta i} + \sum_{j \neq i} \frac{\widetilde{U}_{ei} \widetilde{U}_{ej}^*}{\Delta\widetilde{m}_{ij}^2} \widetilde{U}_{\beta j}. \quad (156)$$

As a consequence, the derivatives of nine  $|\widetilde{U}_{\alpha i}|^2$  with respect to  $A$  can be derived from Eq. (156):

$$\frac{d|\widetilde{U}_{\alpha i}|^2}{dA} = \frac{d\widetilde{U}_{\alpha i}^*}{dA} \widetilde{U}_{\alpha i} + \widetilde{U}_{\alpha i}^* \frac{d\widetilde{U}_{\alpha i}}{dA} = 2 \sum_{j \neq i} \frac{\text{Re}(\widetilde{U}_{ei} \widetilde{U}_{\alpha j} \widetilde{U}_{ej}^* \widetilde{U}_{\alpha i}^*)}{\Delta\widetilde{m}_{ij}^2}. \quad (157)$$

To be explicit, we make use of Eqs. (154) and (156) to write out a set of RGE-like equations which are closed for the variables  $\Delta\widetilde{m}_{ji}^2$  (for  $ji = 21, 31, 32$ ) and  $|\widetilde{U}_{ei}|^2$  (for  $i = 1, 2, 3$ ) [524, 527]:

$$\frac{d\Delta\widetilde{m}_{ji}^2}{dA} = |\widetilde{U}_{ej}|^2 - |\widetilde{U}_{ei}|^2, \quad (158)$$

and

$$\begin{aligned} \frac{d|\widetilde{U}_{e1}|^2}{dA} &= -2|\widetilde{U}_{e1}|^2 \left( \frac{|\widetilde{U}_{e2}|^2}{\Delta\widetilde{m}_{21}^2} + \frac{|\widetilde{U}_{e3}|^2}{\Delta\widetilde{m}_{31}^2} \right), \\ \frac{d|\widetilde{U}_{e2}|^2}{dA} &= -2|\widetilde{U}_{e2}|^2 \left( \frac{|\widetilde{U}_{e3}|^2}{\Delta\widetilde{m}_{32}^2} - \frac{|\widetilde{U}_{e1}|^2}{\Delta\widetilde{m}_{21}^2} \right), \\ \frac{d|\widetilde{U}_{e3}|^2}{dA} &= +2|\widetilde{U}_{e3}|^2 \left( \frac{|\widetilde{U}_{e1}|^2}{\Delta\widetilde{m}_{31}^2} + \frac{|\widetilde{U}_{e2}|^2}{\Delta\widetilde{m}_{32}^2} \right), \end{aligned} \quad (159)$$



in which only four equations are independent. Solving Eqs. (158) and (159) will allow us to rediscover the results for  $|\widetilde{U}_{ei}|^2$  obtained from Eq. (144) by taking  $\alpha = \beta = e$ . The differential equations for  $|\widetilde{U}_{\mu i}|^2$  and  $|\widetilde{U}_{ri}|^2$  (for  $i = 1, 2, 3$ ) can similarly be written out from Eq. (157), and the evolution of all of them with  $A$  has been illustrated in Figs. 22 and 23.

Eq. (156) also allows us to derive a differential equation for  $\widetilde{\mathcal{J}}_\nu$ , the effective Jarlskog invariant of CP violation in matter. The result is

$$\frac{d\widetilde{\mathcal{J}}_\nu}{dA} = -\widetilde{\mathcal{J}}_\nu \left( \frac{|\widetilde{U}_{e2}|^2 - |\widetilde{U}_{e1}|^2}{\Delta\widetilde{m}_{21}^2} + \frac{|\widetilde{U}_{e3}|^2 - |\widetilde{U}_{e1}|^2}{\Delta\widetilde{m}_{31}^2} + \frac{|\widetilde{U}_{e3}|^2 - |\widetilde{U}_{e2}|^2}{\Delta\widetilde{m}_{32}^2} \right). \quad (160)$$

A combination of Eqs. (158)—(160) leads us to

$$\frac{d}{dA} \ln \left[ \widetilde{\mathcal{J}}_\nu \Delta\widetilde{m}_{21}^2 \Delta\widetilde{m}_{31}^2 \Delta\widetilde{m}_{32}^2 \right] = 0, \quad (161)$$

implying the validity of the Naumov relation shown in Eq. (121) [483].

Taking the standard parametrization of  $\widetilde{U}$ , one may use Eqs. (155) and (156) to derive the differential equations of its three mixing angles and the Dirac CP-violating phase [524]. Namely,

$$\begin{aligned} \frac{d\widetilde{\theta}_{12}}{dA} &= \frac{1}{2} \sin 2\widetilde{\theta}_{12} \left( \frac{\cos^2 \widetilde{\theta}_{13}}{\Delta\widetilde{m}_{21}^2} - \frac{\sin^2 \widetilde{\theta}_{13} \Delta\widetilde{m}_{21}^2}{\Delta\widetilde{m}_{31}^2 \Delta\widetilde{m}_{32}^2} \right), \\ \frac{d\widetilde{\theta}_{13}}{dA} &= \frac{1}{2} \sin 2\widetilde{\theta}_{13} \left( \frac{\cos^2 \widetilde{\theta}_{12}}{\Delta\widetilde{m}_{31}^2} + \frac{\sin^2 \widetilde{\theta}_{12}}{\Delta\widetilde{m}_{32}^2} \right), \\ \frac{d\widetilde{\theta}_{23}}{dA} &= \frac{1}{2} \sin 2\widetilde{\theta}_{12} \frac{\sin \widetilde{\theta}_{13} \cos \widetilde{\delta}_\nu \Delta\widetilde{m}_{21}^2}{\Delta\widetilde{m}_{31}^2 \Delta\widetilde{m}_{32}^2}, \\ \frac{d\widetilde{\delta}_\nu}{dA} &= -\sin 2\widetilde{\theta}_{12} \sin \widetilde{\theta}_{13} \sin \widetilde{\delta}_\nu \frac{\cot 2\widetilde{\theta}_{23} \Delta\widetilde{m}_{21}^2}{\Delta\widetilde{m}_{31}^2 \Delta\widetilde{m}_{32}^2}, \end{aligned} \quad (162)$$

from which it is easy to verify the relation

$$\frac{d}{dA} \left( \sin 2\widetilde{\theta}_{23} \sin \widetilde{\delta}_\nu \right) = \left( 2 \cos 2\widetilde{\theta}_{23} \sin \widetilde{\delta}_\nu \right) \frac{d\widetilde{\theta}_{23}}{dA} + \left( \sin 2\widetilde{\theta}_{23} \cos \widetilde{\delta}_\nu \right) \frac{d\widetilde{\delta}_\nu}{dA} = 0. \quad (163)$$

This certainly means the validity of the Toshev relation  $\sin 2\widetilde{\theta}_{23} \sin \widetilde{\delta}_\nu = \sin 2\theta_{23} \sin \delta_\nu$  for neutrino mixing and CP violation in the standard parametrization [515].

## 4.5. Effects of renormalization-group evolution

### 4.5.1. RGEs for the Yukawa coupling matrices

In quantum field theories *renormalization* is a necessary mathematical procedure to obtain finite results when one goes beyond the Born approximation (i.e., the tree-level calculations) [522, 523, 528]. The key idea of such a renormalization procedure is that the theory keeps its form invariance or self similarity under a change of the renormalization point, and in this case the Lagrangian parameters have to depend on the point of renormalization or the energy scale.

This kind of scale dependence of the relevant Lagrangian parameters, such as the gauge coupling constants and fermion flavor parameters, is described by their respective RGEs.

Starting from the electroweak scale ( $\Lambda_{\text{EW}} \sim 10^2$  GeV) where the SM works extremely well, one may describe how the Yukawa coupling matrices of charged leptons and quarks evolve to the GUT scale ( $\Lambda_{\text{GUT}} \sim 10^{16}$  GeV) via the RGEs [310, 313]. Between  $\Lambda_{\text{EW}}$  and  $\Lambda_{\text{GUT}}$  there might exist one or more new physics scales, such as the heavy degrees of freedom in a given seesaw mechanism which are assumed to show up and play a crucial role in generating tiny masses for the three known neutrinos<sup>24</sup>. One may define the seesaw scale  $\Lambda_{\text{SS}}$  to characterize the lowest mass scale of the heavy particles in this connection, such as the mass of the lightest heavy Majorana neutrino in the canonical (Type-I) seesaw scenario. Below  $\Lambda_{\text{GUT}}$  but above  $\Lambda_{\text{SS}}$  the threshold effects associated with the masses of heavier seesaw particles need to be carefully dealt with in the RGEs by integrating out the corresponding heavy degrees of freedom step by step [529, 530, 531, 532, 533, 534, 535, 536]. Below  $\Lambda_{\text{SS}}$  and above  $\Lambda_{\text{EW}}$  the unique dimension-five Weinberg operator [160, 537] is responsible for the masses of three light Majorana neutrinos, and thus the RGE of the effective Majorana neutrino coupling matrix between  $\Lambda_{\text{EW}}$  and  $\Lambda_{\text{SS}}$  can be derived after integrating out all the heavy particles [538, 539, 540, 541]. If massive neutrinos are the Dirac particles, their Yukawa coupling matrix will evolve with the energy scale in a different way [542].

Besides the SM, the minimal supersymmetric standard model (MSSM) [543] is also a very popular benchmark model to illustrate how the Yukawa coupling matrices evolve from  $\Lambda_{\text{EW}}$  to  $\Lambda_{\text{GUT}}$  or vice versa<sup>25</sup>. In the MSSM case two Higgs doublets  $H_1$  (with hypercharge  $+1/2$ ) and  $H_2$  (with hypercharge  $-1/2$ ) are introduced to replace the SM Higgs doublet  $H$  and its charge-conjugate counterpart  $\widetilde{H}$ , respectively, in Eqs. (3), (12), (30) and so on. The vacuum expectation values of  $H_1$  and  $H_2$  are usually parametrized as  $v_1 = v \cos \beta$  and  $v_2 = v \sin \beta$ , and thus  $v_1^2 + v_2^2 = v^2$  with  $v \simeq 246$  GeV holds and  $\tan \beta = v_2/v_1$  is a free dimensionless parameter of the MSSM. No matter which seesaw mechanism works at  $\Lambda_{\text{SS}}$  to generate tiny neutrino masses of  $\nu_i$  (for  $i = 1, 2, 3$ ) in correspondence with  $\nu_\alpha$  (for  $\alpha = e, \mu, \tau$ ), as discussed in section 2.2.3, one may use  $\kappa$  to universally denote the effective Majorana neutrino coupling matrix appearing in the unique dimension-five Weinberg operator as follows:

$$\frac{\mathcal{L}_{\text{d}=5}}{\Lambda_{\text{SS}}} \propto \begin{cases} \kappa_{\alpha\beta} \left[ \overline{\ell_{\alpha\text{L}}} \widetilde{H} \widetilde{H}^T (\ell_{\beta\text{L}})^c \right] + \text{h.c.}, & (\text{SM}); \\ \kappa_{\alpha\beta} \left[ \overline{\ell_{\alpha\text{L}}} H_2 H_2^T (\ell_{\beta\text{L}})^c \right] + \text{h.c.}, & (\text{MSSM}), \end{cases} \quad (164)$$

where the subscripts  $\alpha$  and  $\beta$  run over the flavor indices  $e, \mu$  and  $\tau$ . We are therefore left with the effective neutrino mass matrix  $M_\nu = \kappa v^2/2$  in the SM or  $M_\nu = \kappa(v \sin \beta)^2/2$  in the MSSM after spontaneous electroweak symmetry breaking.

If massive neutrinos are the Dirac particles, their mass matrix is given by  $M_\nu = Y_\nu v/\sqrt{2}$  in the SM or  $M_\nu = Y_\nu v \sin \beta/\sqrt{2}$  in the MSSM. As for the mass matrices of charged fermions, we have

<sup>24</sup>Most of the underlying flavor symmetries are also expected to show up at a superhigh energy scale, as will be discussed in section 6.4.2 and section 7.4.2. Of course, we still have no idea whether such a new energy scale is close to the GUT scale  $\Lambda_{\text{GUT}}$  or the seesaw scale  $\Lambda_{\text{SS}}$ , or none of them.

<sup>25</sup>For the sake of simplicity, here we do not take into account the scale of supersymmetry breaking and the effect of supersymmetric threshold corrections on the RGE running behaviors of charged fermions [285].

$M_l = Y_l v / \sqrt{2}$ ,  $M_u = Y_u v / \sqrt{2}$  and  $M_d = Y_d v / \sqrt{2}$  in the SM as already given below Eq. (5), or  $M_l = Y_l v \cos \beta / \sqrt{2}$ ,  $M_u = Y_u v \sin \beta / \sqrt{2}$  and  $M_d = Y_d v \cos \beta / \sqrt{2}$  in the MSSM.

In the following let us list the one-loop RGEs of leptons and quarks above the electroweak scale  $\Lambda_{\text{EW}}$  by separately considering the cases of massive Majorana and Dirac neutrinos.

(1) The one-loop RGEs for the effective coupling matrix of *Majorana* neutrinos and the Yukawa coupling matrices of charged leptons and quarks:

$$\begin{aligned}
16\pi^2 \frac{d\kappa}{dt} &= \alpha_\kappa \kappa + C_\kappa \left[ (Y_l Y_l^\dagger) \kappa + \kappa (Y_l Y_l^\dagger)^T \right], \\
16\pi^2 \frac{dY_l}{dt} &= \left[ \alpha_l + C_l^l (Y_l Y_l^\dagger) \right] Y_l, \\
16\pi^2 \frac{dY_u}{dt} &= \left[ \alpha_u + C_u^u (Y_u Y_u^\dagger) + C_u^d (Y_d Y_d^\dagger) \right] Y_u, \\
16\pi^2 \frac{dY_d}{dt} &= \left[ \alpha_d + C_d^u (Y_u Y_u^\dagger) + C_d^d (Y_d Y_d^\dagger) \right] Y_d,
\end{aligned} \tag{165}$$

where  $t \equiv \ln(\mu/\Lambda_{\text{EW}})$  with  $\mu$  being an arbitrary renormalization scale between  $\Lambda_{\text{EW}}$  and  $\Lambda_{\text{SS}}$ . In the framework of the SM one has  $C_\kappa = C_u^d = C_d^u = -3/2$ ,  $C_l^l = C_u^u = C_d^d = 3/2$ , and

$$\begin{aligned}
\alpha_\kappa &= -3g_2^2 + 4\lambda + 2\text{Tr} \left[ 3(Y_u Y_u^\dagger) + 3(Y_d Y_d^\dagger) + (Y_l Y_l^\dagger) \right], \\
\alpha_l &= -\frac{9}{4}g_1^2 - \frac{9}{4}g_2^2 + \text{Tr} \left[ 3(Y_u Y_u^\dagger) + 3(Y_d Y_d^\dagger) + (Y_l Y_l^\dagger) \right], \\
\alpha_u &= -\frac{17}{20}g_1^2 - \frac{9}{4}g_2^2 - 8g_3^2 + \text{Tr} \left[ 3(Y_u Y_u^\dagger) + 3(Y_d Y_d^\dagger) + (Y_l Y_l^\dagger) \right], \\
\alpha_d &= -\frac{1}{4}g_1^2 - \frac{9}{4}g_2^2 - 8g_3^2 + \text{Tr} \left[ 3(Y_u Y_u^\dagger) + 3(Y_d Y_d^\dagger) + (Y_l Y_l^\dagger) \right];
\end{aligned} \tag{166}$$

and in the framework of the MSSM one has  $C_\kappa = C_u^d = C_d^u = 1$ ,  $C_l^l = C_u^u = C_d^d = 3$ , and

$$\begin{aligned}
\alpha_\kappa &= -\frac{6}{5}g_1^2 - 6g_2^2 + 6\text{Tr}(Y_u Y_u^\dagger), \\
\alpha_l &= -\frac{9}{5}g_1^2 - 3g_2^2 + \text{Tr} \left[ 3(Y_d Y_d^\dagger) + (Y_l Y_l^\dagger) \right], \\
\alpha_u &= -\frac{13}{15}g_1^2 - 3g_2^2 - \frac{16}{3}g_3^2 + 3\text{Tr}(Y_u Y_u^\dagger), \\
\alpha_d &= -\frac{7}{15}g_1^2 - 3g_2^2 - \frac{16}{3}g_3^2 + \text{Tr} \left[ 3(Y_d Y_d^\dagger) + (Y_l Y_l^\dagger) \right].
\end{aligned} \tag{167}$$

In Eqs. (166) and (167) the three gauge coupling constants  $g_i$  (for  $i = 1, 2, 3$ ) satisfy their own one-loop RGEs of the form

$$16\pi^2 \frac{dg_i}{dt} = b_i g_i^3, \tag{168}$$

in which  $b_1 = 41/10$ ,  $b_2 = -19/6$  and  $b_3 = -7$  in the SM; or  $b_1 = 33/5$ ,  $b_2 = 1$  and  $b_3 = -3$  in the MSSM. Moreover,  $\lambda$  in the expression of  $\alpha_\kappa$  in Eq. (166) denotes the Higgs self-coupling

parameter of the SM and obeys the one-loop RGE [532, 544]<sup>26</sup>

$$16\pi^2 \frac{d\lambda}{dt} = 24\lambda^2 - 3\lambda \left( \frac{3}{5}g_1^2 + 3g_2^2 \right) + \frac{3}{8} \left( \frac{3}{5}g_1^2 + g_2^2 \right)^2 + \frac{3}{4}g_2^4 \\ + 4\lambda \text{Tr} \left[ 3(Y_u Y_u^\dagger) + 3(Y_d Y_d^\dagger) + (Y_l Y_l^\dagger) \right] - 2\text{Tr} \left[ 3(Y_u Y_u^\dagger)^2 + 3(Y_d Y_d^\dagger)^2 + (Y_l Y_l^\dagger)^2 \right], \quad (169)$$

where  $\lambda = M_H^2/(2v^2) \simeq 0.13$  can be obtained at the electroweak scale with the typical inputs  $M_H \simeq 125$  GeV and  $v \simeq 246$  GeV. It will be extremely important to directly measure the value of  $\lambda$  in the future Higgs factory (e.g., CEPC [545, 546]) as a new crucial test of the SM.

(2) The one-loop RGEs for the Yukawa coupling matrices of *Dirac* neutrinos, charged leptons, up- and down-type quarks:

$$16\pi^2 \frac{dY_\nu}{dt} = \left[ \alpha_\nu + C_\nu^\nu(Y_\nu Y_\nu^\dagger) + C_\nu^l(Y_l Y_l^\dagger) \right] Y_\nu, \\ 16\pi^2 \frac{dY_l}{dt} = \left[ \alpha_l + C_l^\nu(Y_\nu Y_\nu^\dagger) + C_l^l(Y_l Y_l^\dagger) \right] Y_l, \\ 16\pi^2 \frac{dY_u}{dt} = \left[ \alpha_u + C_u^u(Y_u Y_u^\dagger) + C_u^d(Y_d Y_d^\dagger) \right] Y_u, \\ 16\pi^2 \frac{dY_d}{dt} = \left[ \alpha_d + C_d^u(Y_u Y_u^\dagger) + C_d^d(Y_d Y_d^\dagger) \right] Y_d. \quad (170)$$

In the framework of the SM we have  $C_\nu^\nu = C_l^l = C_u^u = C_d^d = 3/2$ ,  $C_\nu^l = C_l^\nu = C_u^d = C_d^u = -3/2$ , and

$$\alpha_\nu = -\frac{9}{20}g_1^2 - \frac{9}{4}g_2^2 + \text{Tr} \left[ 3(Y_u Y_u^\dagger) + 3(Y_d Y_d^\dagger) + (Y_\nu Y_\nu^\dagger) + (Y_l Y_l^\dagger) \right], \\ \alpha_l = -\frac{9}{4}g_1^2 - \frac{9}{4}g_2^2 + \text{Tr} \left[ 3(Y_u Y_u^\dagger) + 3(Y_d Y_d^\dagger) + (Y_\nu Y_\nu^\dagger) + (Y_l Y_l^\dagger) \right], \\ \alpha_u = -\frac{17}{20}g_1^2 - \frac{9}{4}g_2^2 - 8g_3^2 + \text{Tr} \left[ 3(Y_u Y_u^\dagger) + 3(Y_d Y_d^\dagger) + (Y_\nu Y_\nu^\dagger) + (Y_l Y_l^\dagger) \right], \\ \alpha_d = -\frac{1}{4}g_1^2 - \frac{9}{4}g_2^2 - 8g_3^2 + \text{Tr} \left[ 3(Y_u Y_u^\dagger) + 3(Y_d Y_d^\dagger) + (Y_\nu Y_\nu^\dagger) + (Y_l Y_l^\dagger) \right]; \quad (171)$$

and in the the MSSM we have  $C_\nu^\nu = C_l^l = C_u^u = C_d^d = 3$ ,  $C_\nu^l = C_l^\nu = C_u^d = C_d^u = 1$ , and

$$\alpha_\nu = -\frac{3}{5}g_1^2 - 3g_2^2 + \text{Tr} \left[ 3(Y_u Y_u^\dagger) + (Y_\nu Y_\nu^\dagger) \right], \\ \alpha_l = -\frac{9}{5}g_1^2 - 3g_2^2 + \text{Tr} \left[ 3(Y_d Y_d^\dagger) + (Y_l Y_l^\dagger) \right], \\ \alpha_u = -\frac{13}{15}g_1^2 - 3g_2^2 - \frac{16}{3}g_3^2 + \text{Tr} \left[ 3(Y_u Y_u^\dagger) + (Y_\nu Y_\nu^\dagger) \right], \\ \alpha_d = -\frac{7}{15}g_1^2 - 3g_2^2 - \frac{16}{3}g_3^2 + \text{Tr} \left[ 3(Y_d Y_d^\dagger) + (Y_l Y_l^\dagger) \right]. \quad (172)$$

<sup>26</sup>Note that the expression of  $\alpha_\kappa$  in Eq. (166) and the one-loop RGE of  $\lambda$  in Eq. (169) are dependent upon the convention used for the self-interaction term of the Higgs potential given in Eq. (3). In Refs. [532, 544] and some other references one has adopted the convention  $-(\lambda/4)(H^\dagger H)^2$  for the quartic term of the Higgs potential, and thus the relation  $\lambda = 2M_H^2/v^2$  holds at the tree level.

In this case the RGEs of three gauge coupling constants  $g_i$  (for  $i = 1, 2, 3$ ) are of the same form as those already shown in Eq. (168).

#### 4.5.2. Running behaviors of quark flavors

If massive neutrinos are the Majorana particles, Eqs. (165)—(167) tell us that the one-loop RGEs of the Yukawa coupling matrices  $Y_l$ ,  $Y_u$  and  $Y_d$  are independent of the effective neutrino coupling matrix  $\kappa$ . If massive neutrinos have the Dirac nature, then the tiny neutrino masses imply that the corresponding  $Y_\nu Y_\nu^\dagger$  term can be safely neglected from Eqs. (170)—(172). It is therefore instructive and convenient to study the running behaviors of charged leptons and quarks against the change of energy scales in a way independent of the nature of massive neutrinos — a case which is equivalent to switching off the tiny neutrino masses.

First of all, let us derive the one-loop RGEs for the eigenvalues of  $Y_u$  and  $Y_d$  (denoted respectively as  $y_\alpha$  for  $\alpha = u, c, t$  and  $y_i$  for  $i = d, s, b$ ) and the elements of the CKM quark flavor mixing matrix  $V = O_u^\dagger O_d$ , where the unitary matrices  $O_u$  and  $O_d$  have been used to diagonalize the quark mass matrices  $M_u$  and  $M_d$  in Eq. (6). Of course, the same unitary transformations can be used to diagonalize the Yukawa coupling matrices  $Y_u$  and  $Y_d$ . Namely,  $O_u^\dagger Y_u O_u' = \hat{Y}_u \equiv \text{Diag}\{y_u, y_c, y_t\}$  and  $O_d^\dagger Y_d O_d' = \hat{Y}_d \equiv \text{Diag}\{y_d, y_s, y_b\}$ . Taking account of the differential equations of  $Y_u$  and  $Y_d$  in Eq. (165) or Eq. (170), we immediately find

$$16\pi^2 \left( \frac{dO_u}{dt} \hat{Y}_u O_u'^\dagger + O_u \frac{d\hat{Y}_u}{dt} O_u'^\dagger + O_u \hat{Y}_u \frac{dO_u'^\dagger}{dt} \right) = (\alpha_u + C_u^u O_u \hat{Y}_u^2 O_u'^\dagger + C_u^d O_d \hat{Y}_d^2 O_d'^\dagger) O_u \hat{Y}_u O_u'^\dagger, \quad (173a)$$

$$16\pi^2 \left( \frac{dO_d}{dt} \hat{Y}_d O_d'^\dagger + O_d \frac{d\hat{Y}_d}{dt} O_d'^\dagger + O_d \hat{Y}_d \frac{dO_d'^\dagger}{dt} \right) = (\alpha_d + C_d^u O_u \hat{Y}_u^2 O_u'^\dagger + C_d^d O_d \hat{Y}_d^2 O_d'^\dagger) O_d \hat{Y}_d O_d'^\dagger. \quad (173b)$$

Let us multiply Eqs. (173a) and (173b) by  $O_u^\dagger$  and  $O_d^\dagger$  on their left-hand sides, respectively; and multiply these two equations by  $O_u' \hat{Y}_u$  and  $O_d' \hat{Y}_d$  on their right-hand sides, respectively. Then we arrive at

$$16\pi^2 \left( O_u^\dagger \frac{dO_u}{dt} \hat{Y}_u^2 + \frac{d\hat{Y}_u}{dt} \hat{Y}_u + \hat{Y}_u \frac{dO_u'^\dagger}{dt} O_u' \hat{Y}_u \right) = (\alpha_u + C_u^u \hat{Y}_u^2 + C_u^d V \hat{Y}_d^2 V^\dagger) \hat{Y}_u^2, \quad (174a)$$

$$16\pi^2 \left( O_d^\dagger \frac{dO_d}{dt} \hat{Y}_d^2 + \frac{d\hat{Y}_d}{dt} \hat{Y}_d + \hat{Y}_d \frac{dO_d'^\dagger}{dt} O_d' \hat{Y}_d \right) = (\alpha_d + C_d^u V^\dagger \hat{Y}_u^2 V + C_d^d \hat{Y}_d^2) \hat{Y}_d^2. \quad (174b)$$

Given the unitarity condition  $O_u'^\dagger O_u' = O_u O_u'^\dagger = I$ , the term associated with  $O_u'$  on the left-hand side of Eq. (174a) can easily be eliminated if this equation is added to its Hermitian conjugate. The same is true of the term associated with  $O_d'$  on the left-hand side of Eq. (174b). As a consequence, we are left with

$$16\pi^2 \left( \frac{d\hat{Y}_u^2}{dt} + \left[ O_u^\dagger \frac{dO_u}{dt}, \hat{Y}_u^2 \right] \right) = 2(\alpha_u + C_u^u \hat{Y}_u^2) \hat{Y}_u^2 + C_u^d \{V \hat{Y}_d^2 V^\dagger, \hat{Y}_u^2\}, \quad (175a)$$

$$16\pi^2 \left( \frac{d\hat{Y}_d^2}{dt} + \left[ O_d^\dagger \frac{dO_d}{dt}, \hat{Y}_d^2 \right] \right) = 2(\alpha_d + C_d^d \hat{Y}_d^2) \hat{Y}_d^2 + C_d^u \{V^\dagger \hat{Y}_u^2 V, \hat{Y}_d^2\}, \quad (175b)$$

where the symbols  $[*, *]$  and  $\{*, *\}$  stand for the commutator and anticommutator of two matrices, respectively. Since  $\hat{Y}_u$  and  $\hat{Y}_d$  are diagonal, the diagonal elements of each of the two commutators in Eqs. (175a) and (175b) must be vanishing. This observation immediately leads us to the one-loop RGEs for the eigenvalues of  $Y_u$  and  $Y_d$  as follows:

$$16\pi^2 \frac{dy_\alpha^2}{dt} = 2 \left( \alpha_u + C_u^u y_\alpha^2 + C_u^d \sum_i y_i^2 |V_{\alpha i}|^2 \right) y_\alpha^2, \quad (176a)$$

$$16\pi^2 \frac{dy_i^2}{dt} = 2 \left( \alpha_d + C_d^d y_i^2 + C_d^u \sum_\alpha y_\alpha^2 |V_{\alpha i}|^2 \right) y_i^2, \quad (176b)$$

where  $\alpha$  and  $i$  run respectively over  $(u, c, t)$  and  $(d, s, b)$ , and the explicit expressions of  $\alpha_u$  and  $\alpha_d$  can be directly read off from Eq. (166) in the SM or Eq. (167) in the MSSM.

We proceed to derive the RGEs of the CKM matrix elements. After differentiating  $V = O_u^\dagger O_d$  and  $O_d^\dagger O_d = I$ , it is straightforward for us to arrive at

$$\frac{dV}{dt} = \frac{dO_u^\dagger}{dt} O_d + O_u^\dagger \frac{dO_d}{dt} = \frac{dO_u^\dagger}{dt} O_u V - V \frac{dO_d^\dagger}{dt} O_d. \quad (177)$$

Since the off-diagonal elements of the commutator on the left-hand side of Eq. (175a) or Eq. (175b) are respectively equal to those of the anticommutator on the right-hand side of these two equations, one may explicitly obtain

$$16\pi^2 \left( \frac{dO_u^\dagger}{dt} O_u \right)_{\alpha\beta} = C_u^d \xi_{\alpha\beta} \sum_j y_j^2 V_{\alpha j} V_{\beta j}^*, \quad (\alpha \neq \beta), \quad (178a)$$

$$16\pi^2 \left( \frac{dO_d^\dagger}{dt} O_d \right)_{ij} = C_d^u \xi_{ij} \sum_\beta y_\beta^2 V_{\beta i}^* V_{\beta j}, \quad (i \neq j), \quad (178b)$$

where  $\xi_{\alpha\beta} \equiv (y_\alpha^2 + y_\beta^2)/(y_\alpha^2 - y_\beta^2)$  and  $\xi_{ij} \equiv (y_i^2 + y_j^2)/(y_i^2 - y_j^2)$  are defined, and the Greek and Latin subscripts run respectively over  $(u, c, t)$  and  $(d, s, b)$ . On the other hand,

$$\left( \frac{dO_u^\dagger}{dt} O_u \right)_{\alpha\alpha} + \left( \frac{dO_u^\dagger}{dt} O_u \right)_{\alpha\alpha}^* = \left( \frac{dO_d^\dagger}{dt} O_d \right)_{ii} + \left( \frac{dO_d^\dagger}{dt} O_d \right)_{ii}^* = 0 \quad (179)$$

holds (for  $\alpha = u, c, t$  and  $i = d, s, b$ ) as a direct consequence of the differentiation of  $O_u^\dagger O_u = O_d^\dagger O_d = I$  [314, 315, 547, 548]. Therefore, a sum of the expression

$$\begin{aligned} \frac{dV_{\alpha i}}{dt} V_{\alpha i}^* &= \left[ \sum_\beta \left( \frac{dO_u^\dagger}{dt} O_u \right)_{\alpha\beta} V_{\beta i} - \sum_j V_{\alpha j} \left( \frac{dO_d^\dagger}{dt} O_d \right)_{ji} \right] V_{\alpha i}^* \\ &= \left[ \sum_{\beta \neq \alpha} \left( \frac{dO_u^\dagger}{dt} O_u \right)_{\alpha\beta} V_{\beta i} - \sum_{j \neq i} V_{\alpha j} \left( \frac{dO_d^\dagger}{dt} O_d \right)_{ji} \right] V_{\alpha i}^* + \left[ \left( \frac{dO_u^\dagger}{dt} O_u \right)_{\alpha\alpha} - \left( \frac{dO_d^\dagger}{dt} O_d \right)_{ii} \right] |V_{\alpha i}|^2 \end{aligned} \quad (180)$$

and its complex conjugate immediately leads us to

$$\begin{aligned}
16\pi^2 \frac{d|V_{\alpha i}|^2}{dt} &= 32\pi^2 \left\{ \sum_{\beta \neq \alpha} \operatorname{Re} \left[ V_{\alpha i}^* V_{\beta i} \left( \frac{dO_u^\dagger}{dt} O_u \right)_{\alpha\beta} \right] - \sum_{j \neq i} \operatorname{Re} \left[ V_{\alpha i}^* V_{\alpha j} \left( \frac{dO_d^\dagger}{dt} O_d \right)_{ji} \right] \right\} \\
&= 2 \left[ C_u^d \sum_{\beta \neq \alpha} \sum_j \xi_{\alpha\beta} y_j^2 \operatorname{Re} (V_{\alpha i} V_{\beta j} V_{\alpha j}^* V_{\beta i}^*) + C_d^u \sum_{j \neq i} \sum_\beta \xi_{ij} y_\beta^2 \operatorname{Re} (V_{\alpha i} V_{\beta j} V_{\alpha j}^* V_{\beta i}^*) \right], \quad (181)
\end{aligned}$$

where Eqs. (178a), (178b) and (179) have been used, and  $(\alpha, \beta)$  and  $(i, j)$  run respectively over  $(u, c, t)$  and  $(d, s, b)$ . This result, together with Eqs. (176a) and (176b), allows us to examine the RGE running behaviors of six quark masses and four independent flavor mixing parameters.

Since  $y_u^2 \ll y_c^2 \ll y_t^2$  and  $y_d^2 \ll y_s^2 \ll y_b^2$  hold, Eqs. (176a) and (176b) can be simplified to a great extent. In this connection the relatively strong hierarchy among the moduli of nine CKM matrix elements (as shown in Table 8) should also be taken into account. We are therefore left with the approximate but instructive relations between the quark mass ratios at  $\Lambda_{\text{EW}}$  and those at a much higher energy scale  $\Lambda$ :

$$\begin{aligned}
\left. \frac{m_u}{m_c} \right|_\Lambda &\simeq \left. \frac{m_u}{m_c} \right|_{\Lambda_{\text{EW}}}, & \left. \frac{m_c}{m_t} \right|_\Lambda &\simeq I_t^{C_u^u} I_b^{C_u^d} \left. \frac{m_c}{m_t} \right|_{\Lambda_{\text{EW}}}; \\
\left. \frac{m_d}{m_s} \right|_\Lambda &\simeq \left. \frac{m_d}{m_s} \right|_{\Lambda_{\text{EW}}}, & \left. \frac{m_s}{m_b} \right|_\Lambda &\simeq I_t^{C_d^u} I_b^{C_d^d} \left. \frac{m_s}{m_b} \right|_{\Lambda_{\text{EW}}}, \quad (182)
\end{aligned}$$

where

$$I_f \equiv \exp \left[ -\frac{1}{16\pi^2} \int_0^{\ln(\Lambda/\Lambda_{\text{EW}})} y_f^2(t) dt \right] \quad (183)$$

stands for the one-loop RGE evolution functions of a given flavor (e.g.,  $f = t, b$  or  $\tau$ ) [549, 550]. Fig. 24 illustrates the running behaviors of  $I_t$ ,  $I_b$  and  $I_\tau$  against the energy scale  $\Lambda$  in the SM with  $M_H \simeq 125$  GeV or in the MSSM with  $\tan\beta \simeq 30$ , from which one may get a ball-park feeling of how large or how small the RGE-induced corrections to the quark mass ratios can be.

Simplifying the one-loop RGEs of  $|V_{\alpha i}|^2$  in Eq. (181) in a similar approximation, we obtain the leading-order expressions as follows [511, 549]:

$$16\pi^2 \frac{d}{dt} \begin{pmatrix} |V_{ud}| & |V_{us}| & |V_{ub}| \\ |V_{cd}| & |V_{cs}| & |V_{cb}| \\ |V_{td}| & |V_{ts}| & |V_{tb}| \end{pmatrix} \simeq - (C_u^d y_b^2 + C_d^u y_t^2) \begin{pmatrix} 0 & 0 & |V_{ub}| \\ 0 & 0 & |V_{cb}| \\ |V_{td}| & |V_{ts}| & 0 \end{pmatrix}. \quad (184)$$

This result implies that  $|V_{ud}|$ ,  $|V_{us}|$ ,  $|V_{cd}|$ ,  $|V_{cs}|$  and  $|V_{tb}|$  are essentially stable against the RGE-induced corrections, while  $|V_{ub}|$ ,  $|V_{cb}|$ ,  $|V_{td}|$  and  $|V_{ts}|$  evolve with the energy scale in an essentially identical way. In other words,

$$\begin{aligned}
|V_{\alpha i}|(\Lambda) &\simeq |V_{\alpha i}|(\Lambda_{\text{EW}}), \quad (\text{for } \alpha i = ud, us, cd, cs, tb); \\
|V_{\alpha i}|(\Lambda) &\simeq I_t^{C_u^d} I_b^{C_d^u} |V_{\alpha i}|(\Lambda_{\text{EW}}), \quad (\text{for } \alpha i = ub, cb, td, ts), \quad (185)
\end{aligned}$$

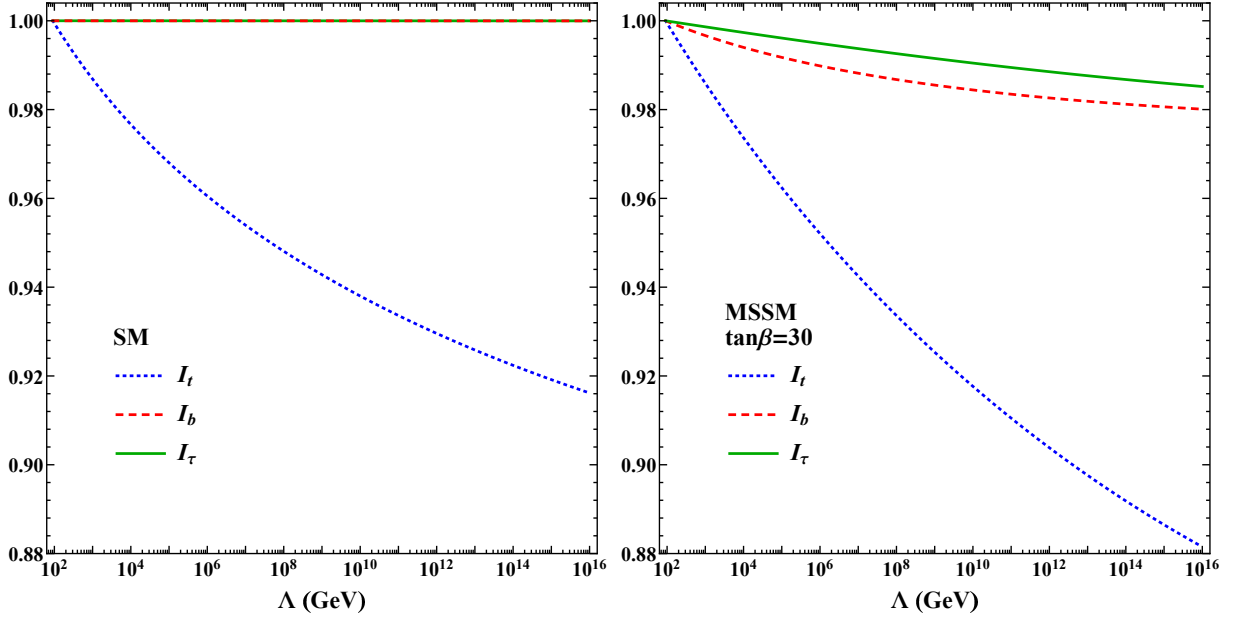

Figure 24: A numerical illustration of the one-loop RGE evolution functions of *top*, *bottom* and *tau* flavors defined in Eq. (183) for the SM with  $M_H \simeq 125$  GeV (left panel) or the MSSM with  $\tan\beta \simeq 30$  (right panel).

where  $I_t$  and  $I_b$  have been defined in Eq. (183). At the one-loop level the relationship between the Jarlskog invariant of CP violation at  $\Lambda_{\text{EW}}$  and that at a superhigh energy scale  $\Lambda$  turns out to be

$$\mathcal{J}_q(\Lambda) \simeq I_t^{2C_u^d} I_b^{2C_u^d} \mathcal{J}_q(\Lambda_{\text{EW}}). \quad (186)$$

Taking account of  $I_t \leq 1$ ,  $I_b \leq 1$  and  $C_u^d = C_d^u = -3/2$  in the SM (or  $C_u^d = C_d^u = 1$  in the MSSM), one can easily see that  $|V_{ub}|$ ,  $|V_{cb}|$ ,  $|V_{td}|$ ,  $|V_{ts}|$  and  $\mathcal{J}_q$  will all increase (or decrease) with the increase of  $\Lambda$  in the SM (or MSSM)

Given the CKM unitarity triangles shown in Fig. 19, Eqs. (185) and (186) tell us that the three sides of  $\Delta_u$ ,  $\Delta_d$ ,  $\Delta_c$  or  $\Delta_s$  identically change with the energy scale<sup>27</sup>, and thus its shape is essentially not deformed by the RGE running effects. In comparison, only the shortest side of  $\Delta_t$  or  $\Delta_b$  is sensitive to the RGE-induced corrections, and hence its sharp shape will become either much sharper or less sharp as the energy scale changes.

If the CKM matrix  $V$  takes the parametrization shown in Eq. (135), one will immediately find that its parameters  $\theta_u$ ,  $\theta_d$  and  $\varphi$  are insensitive to the RGE-induced corrections, and only  $\sin\theta$  evolves with the energy scale in the same way as  $|V_{ub}|$  and  $|V_{cb}|$  (or  $|V_{td}|$  and  $|V_{ts}|$ ) do [137, 511]. This observation, together with Eq. (182), means that the instructive Fritzsche-like predictions in Eq. (136) are essentially independent of the energy scale and thus directly testable at low energies.

<sup>27</sup>It is worth pointing out that this interesting observation is also true when the two-loop RGEs of nine CKM matrix elements are taken into account and some analytical approximations are made up to the accuracy of  $\mathcal{O}(\lambda^4)$  with  $\lambda \simeq 0.22$  [316, 492]. Of course, the two-loop quantum corrections are always suppressed by a coefficient  $1/(16\pi^2)$  as compared with the one-loop contributions.



If the Wolfenstein parametrization of  $V$  is considered, one may similarly find that  $\lambda$ ,  $\rho$  and  $\eta$  are insensitive to the RGE running effects, and only  $A$  changes with the energy scale in the same way as  $|V_{ub}|$ ,  $|V_{cb}|$ ,  $|V_{td}|$  and  $|V_{ts}|$  do [492, 551]. The latter result is quite natural, simply because these four CKM matrix elements are all proportional to  $A$ .

#### 4.5.3. Running behaviors of massive neutrinos

Now we turn to the one-loop RGEs for the Yukawa coupling eigenvalues and flavor mixing parameters of three charged leptons and three massive neutrinos.

(1) If massive neutrinos are the Dirac particles, we may derive the RGEs for the eigenvalues of  $Y_l$  and  $Y_\nu$  in the same way as what we have done in section 4.5.2. The results are

$$16\pi^2 \frac{dy_\alpha^2}{dt} = 2 \left( \alpha_l + C_l^l y_\alpha^2 + C_l^i \sum_i y_i^2 |U_{ai}|^2 \right) y_\alpha^2, \quad (187a)$$

$$16\pi^2 \frac{dy_i^2}{dt} = 2 \left( \alpha_\nu + C_\nu^i y_i^2 + C_\nu^\alpha \sum_\alpha y_\alpha^2 |U_{ai}|^2 \right) y_i^2, \quad (187b)$$

where  $\alpha$  and  $i$  run respectively over  $(e, \mu, \tau)$  and  $(1, 2, 3)$ , and the explicit expressions of  $\alpha_l$  and  $\alpha_\nu$  can be easily read off from Eq. (171) in the SM or Eq. (172) in the MSSM. The RGEs for moduli of the PMNS matrix elements, likewise, are given as follows:

$$16\pi^2 \frac{d|U_{ai}|^2}{dt} = 2 \left[ C_l^i \sum_{\beta \neq \alpha} \sum_j \xi_{\alpha\beta} y_j^2 \operatorname{Re} \left( U_{ai} U_{\beta j} U_{\alpha j}^* U_{\beta i}^* \right) + C_\nu^l \sum_{j \neq i} \sum_\beta \xi_{ij} y_\beta^2 \operatorname{Re} \left( U_{ai} U_{\beta j} U_{\alpha j}^* U_{\beta i}^* \right) \right], \quad (188)$$

where  $\xi_{\alpha\beta} \equiv (y_\alpha^2 + y_\beta^2)/(y_\alpha^2 - y_\beta^2)$  and  $\xi_{ij} \equiv (y_i^2 + y_j^2)/(y_i^2 - y_j^2)$  are defined, and the Greek and Latin subscripts run respectively over  $(e, \mu, \tau)$  and  $(1, 2, 3)$ . Eqs. (187a), (187b) and (188) allow us to look at the one-loop RGE running behaviors of ten physical flavor quantities in the lepton sector — three charged-lepton masses, three Dirac neutrino masses and four independent flavor mixing parameters (e.g., three flavor mixing angles and the Dirac CP-violating phase in a given Euler-like parametrization of  $U$  as listed in Table 12).

Given the fact that  $y_e^2 \ll y_\mu^2 \ll y_\tau^2$  holds and  $y_i^2$  (for  $i = 1, 2, 3$ ) are extremely small, the above three equations can be simplified to a great extent in the  $\tau$ -flavor dominance approximation:

$$\begin{aligned} 16\pi^2 \frac{dy_\alpha^2}{dt} &\simeq 2 \left( \alpha_l + C_l^l y_\alpha^2 \right) y_\alpha^2, \\ 16\pi^2 \frac{dy_i^2}{dt} &\simeq 2 \left( \alpha_\nu + C_\nu^l y_\tau^2 |U_{\tau i}|^2 \right) y_i^2, \\ 16\pi^2 \frac{d|U_{ai}|^2}{dt} &\simeq 2 C_\nu^l y_\tau^2 \sum_{j \neq i} \xi_{ij} \operatorname{Re} \left( U_{ai} U_{\tau j} U_{\alpha j}^* U_{\tau i}^* \right), \end{aligned} \quad (189)$$

in which the same approximations need to be made for the expressions of  $\alpha_l$  and  $\alpha_\nu$ . As pointed out in section 4.3.2, the parametrization of  $U$  in Eq. (137) is particularly suitable for describing

the RGE running behaviors of lepton flavor mixing parameters because its  $U_{\tau i}$  (for  $i = 1, 2, 3$ ) elements are very simple. Combining this parametrization with Eq. (189), one obtains [513]

$$\begin{aligned}
16\pi^2 \frac{d\theta_l}{dt} &\simeq \frac{1}{2} C_{\nu}^l y_{\tau}^2 (\xi_{13} - \xi_{23}) \sin 2\theta_{\nu} \cos \theta \cos \phi , \\
16\pi^2 \frac{d\theta_{\nu}}{dt} &\simeq \frac{1}{2} C_{\nu}^l y_{\tau}^2 \sin 2\theta_{\nu} \left[ \xi_{12} \sin^2 \theta + (\xi_{13} - \xi_{23}) \cos^2 \theta \right] , \\
16\pi^2 \frac{d\theta}{dt} &\simeq \frac{1}{2} C_{\nu}^l y_{\tau}^2 \sin 2\theta \left( \xi_{13} \sin^2 \theta_{\nu} + \xi_{23} \cos^2 \theta_{\nu} \right) , \\
16\pi^2 \frac{d\phi}{dt} &\simeq -C_{\nu}^l y_{\tau}^2 (\xi_{13} - \xi_{23}) \cot 2\theta_l \sin 2\theta_{\nu} \cos \theta \sin \phi .
\end{aligned} \tag{190}$$

The RGE for the Jarlskog invariant  $\mathcal{J}_{\nu} = (1/8) \sin 2\theta_l \sin 2\theta_{\nu} \sin 2\theta \sin \theta \sin \phi$  in this parametrization can accordingly be expressed as

$$\begin{aligned}
16\pi^2 \frac{d\mathcal{J}_{\nu}}{dt} &\simeq C_{\nu}^l y_{\tau}^2 \mathcal{J}_{\nu} \left[ \xi_{12} \cos 2\theta_{\nu} \sin^2 \theta + \xi_{13} (\cos 2\theta + \cos^2 \theta_{\nu} \sin^2 \theta) \right. \\
&\quad \left. + \xi_{23} (\cos 2\theta + \sin^2 \theta_{\nu} \sin^2 \theta) \right] .
\end{aligned} \tag{191}$$

This result implies that  $\mathcal{J}_{\nu} = 0$  will be stable against any changes of the energy scale, provided CP is initially a good symmetry (i.e.,  $\sin \phi = 0$ ) for Dirac neutrinos at a given scale.

(2) If massive neutrinos are of the Majorana nature, their one-loop RGEs will be quite different. Without loss of generality, it proves convenient to choose the flavor basis in which  $Y_l = \hat{Y}_l \equiv \text{Diag}\{y_e, y_{\mu}, y_{\tau}\}$ . Then the RGE of  $Y_l$  in Eq. (165) is simplified to

$$16\pi^2 \frac{dy_{\alpha}^2}{dt} = 2(\alpha_l + C_l^l y_{\alpha}^2) y_{\alpha}^2 , \tag{192}$$

where the expression of  $\alpha_l$  can be read off from Eq. (166) in the SM or from Eq. (167) in the MSSM. In this case the effective Majorana neutrino coupling matrix  $\kappa$  defined in Eq. (164) is diagonalized by the PMNS matrix  $U$  as follows:  $U^{\dagger} \kappa U^* = \hat{\kappa} \equiv \text{Diag}\{\kappa_1, \kappa_2, \kappa_3\}$  with  $\kappa_i$  being the eigenvalues of  $\kappa$  (for  $i = 1, 2, 3$ ). The RGE of  $\kappa$  in Eq. (165) accordingly leads us to

$$16\pi^2 \left( \frac{dU}{dt} \hat{\kappa} U^T + U \frac{d\hat{\kappa}}{dt} U^T + U \hat{\kappa} \frac{dU^T}{dt} \right) = \alpha_{\kappa} U \hat{\kappa} U^T + C_{\kappa} (\hat{Y}_l^2 U \hat{\kappa} U^T + U \hat{\kappa} U^T \hat{Y}_l^2) . \tag{193}$$

Multiplying this equation by  $U^{\dagger}$  on the left-hand side and by  $U^*$  on the right-hand side, we obtain

$$16\pi^2 \frac{d\hat{\kappa}}{dt} = \alpha_{\kappa} \hat{\kappa} + C_{\kappa} (U^{\dagger} \hat{Y}_l^2 U \hat{\kappa} + \hat{\kappa} U^T \hat{Y}_l^2 U^*) - 16\pi^2 \left( U^{\dagger} \frac{dU}{dt} \hat{\kappa} + \hat{\kappa} \frac{dU^T}{dt} U^* \right) . \tag{194}$$

Given the facts that the product of  $U^{\dagger}$  and the derivative of  $U$  is anti-Hermitian<sup>28</sup> and  $\hat{\kappa}$  itself is diagonal and real, Eq. (194) allows us to arrive at

$$16\pi^2 \frac{d\kappa_i^2}{dt} = 2 \left( \alpha_{\kappa} + 2C_{\kappa} \sum_{\alpha} y_{\alpha}^2 |U_{\alpha i}|^2 \right) \kappa_i^2 , \tag{195}$$

<sup>28</sup>Note that the diagonal elements of this product are actually vanishing in the case that massive neutrinos are the Majorana particles, as constrained by Eq. (194). In the case that massive neutrinos are of the Dirac nature, however, the diagonal elements of the above product are purely imaginary.

where the subscripts  $i$  and  $\alpha$  run over (1, 2, 3) and ( $e, \mu, \tau$ ), respectively. Because the off-diagonal parts on the right-hand side of Eq. (194) vanish, we are left with

$$\begin{aligned}\operatorname{Re}\left(\frac{dU^\dagger}{dt}U\right)_{ij} &= \frac{C_\kappa}{16\pi^2} \cdot \frac{\kappa_i + \kappa_j}{\kappa_i - \kappa_j} \sum_\alpha y_\alpha^2 \operatorname{Re}(U_{\alpha i}^* U_{\alpha j}), \\ \operatorname{Im}\left(\frac{dU^\dagger}{dt}U\right)_{ij} &= \frac{C_\kappa}{16\pi^2} \cdot \frac{\kappa_i - \kappa_j}{\kappa_i + \kappa_j} \sum_\alpha y_\alpha^2 \operatorname{Im}(U_{\alpha i}^* U_{\alpha j}).\end{aligned}\quad (196)$$

The one-loop RGE of the PMNS matrix elements  $U_{\alpha i}$  turns out to be

$$\begin{aligned}\frac{dU_{\alpha i}}{dt} &= -\left(U\frac{dU^\dagger}{dt}U\right)_{\alpha i} = -U_{\alpha k}\left(\frac{dU^\dagger}{dt}U\right)_{ki} \\ &= -\frac{C_\kappa}{16\pi^2} \sum_{k \neq i} \sum_\beta y_\beta^2 U_{\alpha k} \left[ \frac{\kappa_k + \kappa_i}{\kappa_k - \kappa_i} \operatorname{Re}(U_{\beta k}^* U_{\beta i}) + i \frac{\kappa_k - \kappa_i}{\kappa_k + \kappa_i} \operatorname{Im}(U_{\beta k}^* U_{\beta i}) \right].\end{aligned}\quad (197)$$

Then the combination  $U_{\alpha i} U_{\alpha j}^*$ , which is apparently independent of redefining the phases of three charged-lepton fields but definitely sensitive to the two Majorana phases of the PMNS matrix  $U$ , can be expressed as follows:

$$\begin{aligned}\frac{d(U_{\alpha i} U_{\alpha j}^*)}{dt} &= \frac{dU_{\alpha i}}{dt} U_{\alpha j}^* + U_{\alpha i} \frac{dU_{\alpha j}^*}{dt} \\ &= -\frac{C_\kappa}{16\pi^2} \sum_{k \neq i} \sum_\beta y_\beta^2 U_{\alpha k} U_{\alpha j}^* \left[ \frac{\kappa_k + \kappa_i}{\kappa_k - \kappa_i} \operatorname{Re}(U_{\beta k}^* U_{\beta i}) + i \frac{\kappa_k - \kappa_i}{\kappa_k + \kappa_i} \operatorname{Im}(U_{\beta k}^* U_{\beta i}) \right] \\ &\quad - \frac{C_\kappa}{16\pi^2} \sum_{k \neq j} \sum_\beta y_\beta^2 U_{\alpha i} U_{\alpha k}^* \left[ \frac{\kappa_k + \kappa_j}{\kappa_k - \kappa_j} \operatorname{Re}(U_{\beta k}^* U_{\beta j}) - i \frac{\kappa_k - \kappa_j}{\kappa_k + \kappa_j} \operatorname{Im}(U_{\beta k}^* U_{\beta j}) \right].\end{aligned}\quad (198)$$

When taking  $i = j$ , we find that the one-loop RGEs of  $|U_{\alpha i}|^2$  are actually independent of redefining the phases of three Majorana neutrino fields — all the imaginary terms on the right-hand side of Eq. (198) will therefore disappear in the  $i = j$  case.

With the help of Eq. (198), one may take a particular parametrization of  $U$  to explicitly derive the RGEs for its three flavor mixing angles and three CP-violating phases. Now that the  $\tau$ -flavor dominance is an excellent approximation thanks to  $y_e^2 \ll y_\mu^2 \ll y_\tau^2$ , it has been shown that the parametrization of  $U$  advocated in Eq. (137) is more advantageous than the standard parametrization of  $U$  shown in Eq. (2) [513], just because the  $\tau$ -related matrix elements  $U_{\tau i}$  (for  $i = 1, 2, 3$ ) in Eq. (137) are much simpler than those in Eq. (2). To be concrete, we obtain

$$\begin{aligned}16\pi^2 \frac{d\kappa_1}{dt} &\simeq (\alpha_\kappa + 2C_\kappa y_\tau^2 \sin^2 \theta_\nu \sin^2 \theta), \\ 16\pi^2 \frac{d\kappa_2}{dt} &\simeq (\alpha_\kappa + 2C_\kappa y_\tau^2 \cos^2 \theta_\nu \sin^2 \theta), \\ 16\pi^2 \frac{d\kappa_3}{dt} &\simeq (\alpha_\kappa + 2C_\kappa y_\tau^2 \cos^2 \theta),\end{aligned}\quad (199)$$

from Eq. (195) by only keeping the  $\tau$ -flavor contribution; and

$$\begin{aligned}
16\pi^2 \frac{d\theta_l}{dt} &\simeq \frac{1}{2} C_\kappa y_\tau^2 \sin 2\theta_\nu \cos \theta \left[ \frac{\kappa_1 + \kappa_3}{\kappa_1 - \kappa_3} \cos \rho \cos(\rho - \phi) + \frac{\kappa_1 - \kappa_3}{\kappa_1 + \kappa_3} \sin \rho \sin(\rho - \phi) \right. \\
&\quad \left. - \frac{\kappa_2 + \kappa_3}{\kappa_2 - \kappa_3} \cos \sigma \cos(\sigma - \phi) - \frac{\kappa_2 - \kappa_3}{\kappa_2 + \kappa_3} \sin \sigma \sin(\sigma - \phi) \right], \\
16\pi^2 \frac{d\theta_\nu}{dt} &\simeq \frac{1}{2} C_\kappa y_\tau^2 \sin 2\theta_\nu \left[ \frac{\kappa_1 + \kappa_2}{\kappa_1 - \kappa_2} \sin^2 \theta \cos^2(\sigma - \rho) + \frac{\kappa_1 - \kappa_2}{\kappa_1 + \kappa_2} \sin^2 \theta \sin^2(\sigma - \rho) \right. \\
&\quad + \frac{\kappa_1 + \kappa_3}{\kappa_1 - \kappa_3} \cos^2 \theta \cos^2 \rho + \frac{\kappa_1 - \kappa_3}{\kappa_1 + \kappa_3} \cos^2 \theta \sin^2 \rho \\
&\quad \left. - \frac{\kappa_2 + \kappa_3}{\kappa_2 - \kappa_3} \cos^2 \theta \cos^2 \sigma - \frac{\kappa_2 - \kappa_3}{\kappa_2 + \kappa_3} \cos^2 \theta \sin^2 \sigma \right], \\
16\pi^2 \frac{d\theta}{dt} &\simeq \frac{1}{2} C_\kappa y_\tau^2 \sin 2\theta \left[ \frac{\kappa_1 + \kappa_3}{\kappa_1 - \kappa_3} \sin^2 \theta_\nu \cos^2 \rho + \frac{\kappa_1 - \kappa_3}{\kappa_1 + \kappa_3} \sin^2 \theta_\nu \sin^2 \rho \right. \\
&\quad \left. + \frac{\kappa_2 + \kappa_3}{\kappa_2 - \kappa_3} \cos^2 \theta_\nu \cos^2 \sigma + \frac{\kappa_2 - \kappa_3}{\kappa_2 + \kappa_3} \cos^2 \theta_\nu \sin^2 \sigma \right], \tag{200}
\end{aligned}$$

from Eq. (198) for the three flavor mixing angles, together with

$$\begin{aligned}
16\pi^2 \frac{d\rho}{dt} &\simeq 2C_\kappa y_\tau^2 \left[ \frac{\kappa_1 \kappa_2}{\kappa_1^2 - \kappa_2^2} \cos^2 \theta_\nu \sin^2 \theta \sin 2(\sigma - \rho) + \frac{\kappa_1 \kappa_3}{\kappa_1^2 - \kappa_3^2} (\sin^2 \theta_\nu \sin^2 \theta - \cos^2 \theta) \sin 2\rho \right. \\
&\quad \left. + \frac{\kappa_2 \kappa_3}{\kappa_2^2 - \kappa_3^2} \cos^2 \theta_\nu \sin^2 \theta \sin 2\sigma \right], \\
16\pi^2 \frac{d\sigma}{dt} &\simeq 2C_\kappa y_\tau^2 \left[ \frac{\kappa_1 \kappa_2}{\kappa_1^2 - \kappa_2^2} \sin^2 \theta_\nu \sin^2 \theta \sin 2(\sigma - \rho) + \frac{\kappa_1 \kappa_3}{\kappa_1^2 - \kappa_3^2} \sin^2 \theta_\nu \sin^2 \theta \sin 2\rho \right. \\
&\quad \left. + \frac{\kappa_2 \kappa_3}{\kappa_2^2 - \kappa_3^2} (\cos^2 \theta_\nu \sin^2 \theta - \cos^2 \theta) \sin 2\sigma \right], \\
16\pi^2 \frac{d\phi}{dt} &\simeq C_\kappa y_\tau^2 \cot 2\theta_l \sin 2\theta_\nu \cos \theta \left[ \frac{\kappa_1 + \kappa_3}{\kappa_1 - \kappa_3} \cos \rho \sin(\rho - \phi) - \frac{\kappa_1 - \kappa_3}{\kappa_1 + \kappa_3} \sin \rho \cos(\rho - \phi) \right. \\
&\quad \left. - \frac{\kappa_2 + \kappa_3}{\kappa_2 - \kappa_3} \cos \sigma \sin(\sigma - \phi) + \frac{\kappa_2 - \kappa_3}{\kappa_2 + \kappa_3} \sin \sigma \cos(\sigma - \phi) \right] \\
&\quad + 2C_\kappa y_\tau^2 \left[ \frac{\kappa_1 \kappa_2}{\kappa_1^2 - \kappa_2^2} \sin^2 \theta \sin 2(\sigma - \rho) + \frac{\kappa_1 \kappa_3}{\kappa_1^2 - \kappa_3^2} (\sin^2 \theta_\nu - \cos^2 \theta_\nu \cos^2 \theta) \sin 2\rho \right. \\
&\quad \left. + \frac{\kappa_2 \kappa_3}{\kappa_2^2 - \kappa_3^2} (\cos^2 \theta_\nu - \sin^2 \theta_\nu \cos^2 \theta) \sin 2\sigma \right], \tag{201}
\end{aligned}$$

for the three CP-violating phases. It is clear that the running behaviors of  $\kappa_1$ ,  $\kappa_2$  and  $\kappa_3$  (i.e., three neutrino masses) are essentially identical because they are mainly governed by  $\alpha_\kappa$  unless the value of  $\tan \beta$  is large enough in the MSSM to make the  $y_\tau^2$ -related term become competitive with  $\alpha_\kappa$  [552]. On the other hand,  $\theta_\nu$  is in general more sensitive to the RGE-induced corrections than  $\theta_l$ ,

and  $\theta$ , since its RGE contains a term proportional to  $(\kappa_1 + \kappa_2)/(\kappa_1 - \kappa_2) = -(m_1 + m_2)^2/\Delta m_{21}^2$  with a relatively small denominator  $\Delta m_{21}^2 \simeq 7.4 \times 10^{-5} \text{ eV}^2$  [513] (in comparison,  $\theta_{12}$  is most sensitive to the RGE effects for the same reason in the standard parametrization of  $U$  [552, 553]). Note that the RGE running behavior of  $\phi$  can be quite different from those of  $\rho$  and  $\sigma$ , because it involves an extra term proportional to  $\cot 2\theta_i$ . That is why  $\rho$  and  $\sigma$  evolve in a relatively mild way as compared with  $\phi$ . Note also that the derivatives of  $\rho$  and  $\sigma$  will vanish if both of them are initially vanishing. This observation means that  $\rho$  and  $\sigma$  cannot simultaneously be generated from nonzero  $\phi$  via the one-loop RGEs. When the RGE of the Jarlskog invariant  $\mathcal{J}_\nu$  is concerned in the Majorana case, one finds that it involves all the three CP-violating phases instead of  $\phi$  itself. Therefore,  $\mathcal{J}_\nu = 0$  at a given energy scale (equivalent to  $\phi = 0$ ) is not stable at all when the scale changes [513].

## 5. Flavor mixing between active and sterile neutrinos

### 5.1. A parametrization of the $6 \times 6$ flavor mixing matrix

#### 5.1.1. The interplay between active and sterile neutrinos

One of the fundamental questions in particle physics and cosmology is whether there exist one or more extra species of massive neutrinos which do not directly participate in the standard weak interactions. Such *sterile* neutrinos will not interact with normal matter unless they mix with the three known (active) neutrinos to some extent. The seesaw-motivated heavy sterile neutrinos, warm-dark-matter-motivated keV-scale sterile neutrinos and anomaly-motivated eV-scale sterile neutrinos (e.g., from the LSND and MiniBooNE experiments) will be discussed in sections 5.2, 5.3 and 5.4, respectively. Here let us focus on how to describe the interplay between active and sterile neutrinos in terms of some extra Euler-like flavor mixing angles and CP-violating phases.

Since the number of sterile neutrino species is completely unknown, let us assume a kind of *parallelism* between the active and sterile sectors. Namely, we assume the existence of three sterile neutrino states  $\nu_x, \nu_y$  and  $\nu_z$ , and their corresponding mass eigenstates are denoted as  $\nu_4, \nu_5$  and  $\nu_6$ . In this (3+3) active-sterile neutrino mixing scenario one may write out a  $6 \times 6$  unitary matrix  $\mathcal{U}$  to link the six neutrino flavor eigenstates to their mass eigenstates in the basis where the flavor eigenstates of three charged leptons are identical with their mass eigenstates [554]:

$$\begin{pmatrix} \nu_e \\ \nu_\mu \\ \nu_\tau \\ \nu_x \\ \nu_y \\ \nu_z \end{pmatrix} = \mathcal{U} \begin{pmatrix} \nu_1 \\ \nu_2 \\ \nu_3 \\ \nu_4 \\ \nu_5 \\ \nu_6 \end{pmatrix} = \begin{pmatrix} I & 0 \\ 0 & U'_0 \end{pmatrix} \begin{pmatrix} A & R \\ S & B \end{pmatrix} \begin{pmatrix} U_0 & 0 \\ 0 & I \end{pmatrix} \begin{pmatrix} \nu_1 \\ \nu_2 \\ \nu_3 \\ \nu_4 \\ \nu_5 \\ \nu_6 \end{pmatrix}, \quad (202)$$

where  $I$  denotes the  $3 \times 3$  identity matrix, “0” represents the  $3 \times 3$  zero matrix, the  $3 \times 3$  unitary matrices  $U_0$  and  $U'_0$  are responsible respectively for flavor mixing in the active sector and that in the sterile sector, while  $A, B, R$  and  $S$  are the  $3 \times 3$  matrices describing the interplay between the two sectors. As a result of the unitarity of  $\mathcal{U}$ ,

$$\begin{aligned} AA^\dagger + RR^\dagger &= BB^\dagger + SS^\dagger = I, \\ AS^\dagger + RB^\dagger &= A^\dagger R + S^\dagger B = 0, \\ A^\dagger A + S^\dagger S &= B^\dagger B + R^\dagger R = I. \end{aligned} \quad (203)$$

Table 13: The fifteen two-dimensional  $6 \times 6$  rotation matrices in the complex plane, where the notations  $c_{ij} \equiv \cos \theta_{ij}$  and  $\hat{s}_{ij} \equiv e^{i\delta_{ij}} \sin \theta_{ij}$  (for  $1 \leq i < j \leq 6$ ) are defined.

$O_{12} = \begin{pmatrix} c_{12} & \hat{s}_{12}^* & 0 & 0 & 0 & 0 \\ -\hat{s}_{12} & c_{12} & 0 & 0 & 0 & 0 \\ 0 & 0 & 1 & 0 & 0 & 0 \\ 0 & 0 & 0 & 1 & 0 & 0 \\ 0 & 0 & 0 & 0 & 1 & 0 \\ 0 & 0 & 0 & 0 & 0 & 1 \end{pmatrix}$	$O_{13} = \begin{pmatrix} c_{13} & 0 & \hat{s}_{13}^* & 0 & 0 & 0 \\ 0 & 1 & 0 & 0 & 0 & 0 \\ -\hat{s}_{13} & 0 & c_{13} & 0 & 0 & 0 \\ 0 & 0 & 0 & 1 & 0 & 0 \\ 0 & 0 & 0 & 0 & 1 & 0 \\ 0 & 0 & 0 & 0 & 0 & 1 \end{pmatrix}$	$O_{23} = \begin{pmatrix} 1 & 0 & 0 & 0 & 0 & 0 \\ 0 & c_{23} & \hat{s}_{23}^* & 0 & 0 & 0 \\ 0 & -\hat{s}_{23} & c_{23} & 0 & 0 & 0 \\ 0 & 0 & 0 & 1 & 0 & 0 \\ 0 & 0 & 0 & 0 & 1 & 0 \\ 0 & 0 & 0 & 0 & 0 & 1 \end{pmatrix}$
$O_{14} = \begin{pmatrix} c_{14} & 0 & 0 & \hat{s}_{14}^* & 0 & 0 \\ 0 & 1 & 0 & 0 & 0 & 0 \\ 0 & 0 & 1 & 0 & 0 & 0 \\ -\hat{s}_{14} & 0 & 0 & c_{14} & 0 & 0 \\ 0 & 0 & 0 & 0 & 1 & 0 \\ 0 & 0 & 0 & 0 & 0 & 1 \end{pmatrix}$	$O_{24} = \begin{pmatrix} 1 & 0 & 0 & 0 & 0 & 0 \\ 0 & c_{24} & 0 & \hat{s}_{24}^* & 0 & 0 \\ 0 & 0 & 1 & 0 & 0 & 0 \\ 0 & -\hat{s}_{24} & 0 & c_{24} & 0 & 0 \\ 0 & 0 & 0 & 0 & 1 & 0 \\ 0 & 0 & 0 & 0 & 0 & 1 \end{pmatrix}$	$O_{34} = \begin{pmatrix} 1 & 0 & 0 & 0 & 0 & 0 \\ 0 & 1 & 0 & 0 & 0 & 0 \\ 0 & 0 & c_{34} & \hat{s}_{34}^* & 0 & 0 \\ 0 & 0 & -\hat{s}_{34} & c_{34} & 0 & 0 \\ 0 & 0 & 0 & 0 & 1 & 0 \\ 0 & 0 & 0 & 0 & 0 & 1 \end{pmatrix}$
$O_{15} = \begin{pmatrix} c_{15} & 0 & 0 & 0 & \hat{s}_{15}^* & 0 \\ 0 & 1 & 0 & 0 & 0 & 0 \\ 0 & 0 & 1 & 0 & 0 & 0 \\ 0 & 0 & 0 & 1 & 0 & 0 \\ -\hat{s}_{15} & 0 & 0 & 0 & c_{15} & 0 \\ 0 & 0 & 0 & 0 & 0 & 1 \end{pmatrix}$	$O_{25} = \begin{pmatrix} 1 & 0 & 0 & 0 & 0 & 0 \\ 0 & c_{25} & 0 & 0 & \hat{s}_{25}^* & 0 \\ 0 & 0 & 1 & 0 & 0 & 0 \\ 0 & 0 & 0 & 1 & 0 & 0 \\ 0 & -\hat{s}_{25} & 0 & 0 & c_{25} & 0 \\ 0 & 0 & 0 & 0 & 0 & 1 \end{pmatrix}$	$O_{35} = \begin{pmatrix} 1 & 0 & 0 & 0 & 0 & 0 \\ 0 & 1 & 0 & 0 & 0 & 0 \\ 0 & 0 & c_{35} & 0 & \hat{s}_{35}^* & 0 \\ 0 & 0 & 0 & 1 & 0 & 0 \\ 0 & 0 & -\hat{s}_{35} & 0 & c_{35} & 0 \\ 0 & 0 & 0 & 0 & 0 & 1 \end{pmatrix}$
$O_{45} = \begin{pmatrix} 1 & 0 & 0 & 0 & 0 & 0 \\ 0 & 1 & 0 & 0 & 0 & 0 \\ 0 & 0 & 1 & 0 & 0 & 0 \\ 0 & 0 & 0 & c_{45} & \hat{s}_{45}^* & 0 \\ 0 & 0 & 0 & -\hat{s}_{45} & c_{45} & 0 \\ 0 & 0 & 0 & 0 & 0 & 1 \end{pmatrix}$	$O_{16} = \begin{pmatrix} c_{16} & 0 & 0 & 0 & 0 & \hat{s}_{16}^* \\ 0 & 1 & 0 & 0 & 0 & 0 \\ 0 & 0 & 1 & 0 & 0 & 0 \\ 0 & 0 & 0 & 1 & 0 & 0 \\ 0 & 0 & 0 & 0 & 1 & 0 \\ -\hat{s}_{16} & 0 & 0 & 0 & 0 & c_{16} \end{pmatrix}$	$O_{26} = \begin{pmatrix} 1 & 0 & 0 & 0 & 0 & 0 \\ 0 & c_{26} & 0 & 0 & 0 & \hat{s}_{26}^* \\ 0 & 0 & 1 & 0 & 0 & 0 \\ 0 & 0 & 0 & 1 & 0 & 0 \\ 0 & 0 & 0 & 0 & 1 & 0 \\ 0 & -\hat{s}_{26} & 0 & 0 & 0 & c_{26} \end{pmatrix}$
$O_{36} = \begin{pmatrix} 1 & 0 & 0 & 0 & 0 & 0 \\ 0 & 1 & 0 & 0 & 0 & 0 \\ 0 & 0 & c_{36} & 0 & 0 & \hat{s}_{36}^* \\ 0 & 0 & 0 & 1 & 0 & 0 \\ 0 & 0 & 0 & 0 & 1 & 0 \\ 0 & 0 & -\hat{s}_{36} & 0 & 0 & c_{36} \end{pmatrix}$	$O_{46} = \begin{pmatrix} 1 & 0 & 0 & 0 & 0 & 0 \\ 0 & 1 & 0 & 0 & 0 & 0 \\ 0 & 0 & 1 & 0 & 0 & 0 \\ 0 & 0 & 0 & c_{46} & 0 & \hat{s}_{46}^* \\ 0 & 0 & 0 & 0 & 1 & 0 \\ 0 & 0 & 0 & -\hat{s}_{46} & 0 & c_{46} \end{pmatrix}$	$O_{56} = \begin{pmatrix} 1 & 0 & 0 & 0 & 0 & 0 \\ 0 & 1 & 0 & 0 & 0 & 0 \\ 0 & 0 & 1 & 0 & 0 & 0 \\ 0 & 0 & 0 & 1 & 0 & 0 \\ 0 & 0 & 0 & 0 & c_{56} & \hat{s}_{56}^* \\ 0 & 0 & 0 & 0 & -\hat{s}_{56} & c_{56} \end{pmatrix}$

If  $R = S = 0$  and  $A = B = I$  hold, there will be no correlation between the active and sterile sectors. To fully parametrize  $\mathcal{U}$  in terms of the rotation angles and phase parameters in a manner analogous to Eq. (2), we introduce fifteen two-dimensional rotation matrices  $O_{ij}$  (for  $1 \leq i < j \leq 6$ ) in a six-dimensional complex space (as listed in Table 13) and assign them as follows:

$$\begin{aligned} \begin{pmatrix} U_0 & 0 \\ 0 & I \end{pmatrix} &= O_{23} O_{13} O_{12}, & \begin{pmatrix} I & 0 \\ 0 & U'_0 \end{pmatrix} &= O_{56} O_{46} O_{45}, \\ \begin{pmatrix} A & R \\ S & B \end{pmatrix} &= O_{36} O_{26} O_{16} O_{35} O_{25} O_{15} O_{34} O_{24} O_{14}. \end{aligned} \quad (204)$$

Among the fifteen flavor mixing angles (or the fifteen CP-violating phases), six of them appear in the active ( $U_0$ ) and sterile ( $U'_0$ ) sectors:

$$U_0 = \begin{pmatrix} c_{12}c_{13} & \hat{s}_{12}^*c_{13} & \hat{s}_{13}^* \\ -\hat{s}_{12}c_{23} - c_{12}\hat{s}_{13}\hat{s}_{23}^* & c_{12}c_{23} - \hat{s}_{12}^*\hat{s}_{13}\hat{s}_{23}^* & c_{13}\hat{s}_{23}^* \\ \hat{s}_{12}\hat{s}_{23} - c_{12}\hat{s}_{13}c_{23} & -c_{12}\hat{s}_{23} - \hat{s}_{12}^*\hat{s}_{13}c_{23} & c_{13}c_{23} \end{pmatrix}, \quad (205a)$$

$$U'_0 = \begin{pmatrix} c_{45}c_{46} & \hat{s}_{45}^*c_{46} & \hat{s}_{46}^* \\ -\hat{s}_{45}c_{56} - c_{45}\hat{s}_{46}\hat{s}_{56}^* & c_{45}c_{56} - \hat{s}_{45}^*\hat{s}_{46}\hat{s}_{56}^* & c_{46}\hat{s}_{56}^* \\ \hat{s}_{45}\hat{s}_{56} - c_{45}\hat{s}_{46}c_{56} & -c_{45}\hat{s}_{56} - \hat{s}_{45}^*\hat{s}_{46}c_{56} & c_{46}c_{56} \end{pmatrix}. \quad (205b)$$

Comparing Eq. (205a) with Eq. (2), one can easily arrive at  $\delta_\nu \equiv \delta_{13} - \delta_{12} - \delta_{23}$ . In a similar way one may define  $\delta'_\nu \equiv \delta_{46} - \delta_{45} - \delta_{56}$  for  $U'_0$  in Eq. (205b) if the latter takes the same phase convention as that in Eq. (2), although the meaning of  $\delta'_\nu$  remains unclear. It will be extremely difficult, if not impossible, to probe the purely sterile sector described by  $U'_0$  from an experimental point of view, because one has no idea about how to measure any decays among the sterile  $\nu_4$ ,  $\nu_5$  and  $\nu_6$  neutrinos or possible oscillations between any two of the sterile  $\nu_x$ ,  $\nu_y$  and  $\nu_z$  flavors. From a phenomenological point of view, it might be interesting to make such a naive conjecture that  $\theta_{45} = \theta_{12}$ ,  $\theta_{46} = \theta_{13}$  and  $\theta_{56} = \theta_{23}$  together with  $\delta_{45} = \delta_{12}$ ,  $\delta_{46} = \delta_{13}$  and  $\delta_{56} = \delta_{23}$  [486]. In other words, we have conjectured that there might be a mirroring symmetry between the purely active neutrino sector and the purely sterile neutrino sector (or equivalently  $U'_0 = U_0$ ). But how to test such a conjecture is absolutely an open question.

On the other hand, nine of the fifteen flavor mixing angles (or the fifteen CP-violating phases) appear in  $A$ ,  $B$ ,  $R$  and  $S$ , and thus they measure the interplay between the active and sterile sectors. To be explicit, we have [554, 555]

$$A = \begin{pmatrix} c_{14}c_{15}c_{16} & 0 & 0 \\ -c_{14}c_{15}\hat{s}_{16}\hat{s}_{26}^* - c_{14}\hat{s}_{15}\hat{s}_{25}^*c_{26} & c_{24}c_{25}c_{26} & 0 \\ -\hat{s}_{14}\hat{s}_{24}^*c_{25}c_{26} & & \\ -c_{14}c_{15}\hat{s}_{16}c_{26}\hat{s}_{36}^* + c_{14}\hat{s}_{15}\hat{s}_{25}^*\hat{s}_{26}\hat{s}_{36}^* & -c_{24}c_{25}\hat{s}_{26}\hat{s}_{36}^* - c_{24}\hat{s}_{25}\hat{s}_{35}^*c_{36} & c_{34}c_{35}c_{36} \\ -c_{14}\hat{s}_{15}c_{25}\hat{s}_{35}^*c_{36} + \hat{s}_{14}\hat{s}_{24}^*c_{25}\hat{s}_{26}\hat{s}_{36}^* & -\hat{s}_{24}\hat{s}_{34}^*c_{35}c_{36} & \\ +\hat{s}_{14}\hat{s}_{24}^*\hat{s}_{25}\hat{s}_{35}^*c_{36} - \hat{s}_{14}c_{24}\hat{s}_{34}^*c_{35}c_{36} & & \end{pmatrix}, \quad (206)$$

and

$$B = \begin{pmatrix} c_{14}c_{24}c_{34} & 0 & 0 \\ -c_{14}c_{24}\hat{s}_{34}^*\hat{s}_{35} - c_{14}\hat{s}_{24}\hat{s}_{25}^*c_{35} & c_{15}c_{25}c_{35} & 0 \\ -\hat{s}_{14}^*\hat{s}_{15}c_{25}c_{35} & & \\ -c_{14}c_{24}\hat{s}_{34}^*c_{35}\hat{s}_{36} + c_{14}\hat{s}_{24}\hat{s}_{25}^*\hat{s}_{35}\hat{s}_{36} & -c_{15}c_{25}\hat{s}_{35}^*\hat{s}_{36} - c_{15}\hat{s}_{25}\hat{s}_{26}^*c_{36} & c_{16}c_{26}c_{36} \\ -c_{14}\hat{s}_{24}c_{25}\hat{s}_{26}^*c_{36} + \hat{s}_{14}^*\hat{s}_{15}c_{25}\hat{s}_{35}^*\hat{s}_{36} & -\hat{s}_{15}^*\hat{s}_{16}c_{26}c_{36} & \\ +\hat{s}_{14}^*\hat{s}_{15}\hat{s}_{25}^*\hat{s}_{26}^*c_{36} - \hat{s}_{14}^*c_{15}\hat{s}_{16}c_{26}c_{36} & & \end{pmatrix}, \quad (207)$$

which are two triangular matrices. One can easily see that the small active-sterile neutrino mixing angles  $\theta_{ij}$  (for  $i = 1, 2, 3$  and  $j = 4, 5, 6$ ) measure small deviations of  $A$  and  $B$  from the identity

matrix  $I$ . In addition, we find

$$\begin{aligned}
R &= \begin{pmatrix} \hat{s}_{14}^* c_{15} c_{16} & \hat{s}_{15}^* c_{16} & \hat{s}_{16}^* \\ -\hat{s}_{14}^* c_{15} \hat{s}_{16} \hat{s}_{26}^* - \hat{s}_{14}^* \hat{s}_{15} \hat{s}_{25}^* c_{26} & -\hat{s}_{15}^* \hat{s}_{16} \hat{s}_{26}^* + c_{15} \hat{s}_{25}^* c_{26} & c_{16} \hat{s}_{26}^* \\ +c_{14} \hat{s}_{24}^* c_{25} c_{26} & & \end{pmatrix}, \\
S &= \begin{pmatrix} -\hat{s}_{14} c_{24} c_{34} & -\hat{s}_{24} c_{34} & -\hat{s}_{34} \\ \hat{s}_{14} c_{24} \hat{s}_{34}^* \hat{s}_{35} + \hat{s}_{14} \hat{s}_{24}^* \hat{s}_{25} c_{35} & \hat{s}_{24} \hat{s}_{34}^* \hat{s}_{35} - c_{24} \hat{s}_{25} c_{35} & -c_{34} \hat{s}_{35} \\ -c_{14} \hat{s}_{15} c_{25} c_{35} & & \end{pmatrix}. \quad (208) \\
&\begin{pmatrix} \hat{s}_{14} c_{24} \hat{s}_{34}^* c_{35} \hat{s}_{36} - \hat{s}_{14} \hat{s}_{24}^* \hat{s}_{25} \hat{s}_{35}^* \hat{s}_{36} & \hat{s}_{24} \hat{s}_{34}^* c_{35} \hat{s}_{36} + c_{24} \hat{s}_{25} \hat{s}_{35}^* \hat{s}_{36} & -c_{34} c_{35} \hat{s}_{36} \\ +\hat{s}_{14} \hat{s}_{24}^* c_{25} \hat{s}_{26} c_{36} + c_{14} \hat{s}_{15} c_{25} \hat{s}_{35}^* \hat{s}_{36} & -c_{24} c_{25} \hat{s}_{26} c_{36} & \\ +c_{14} \hat{s}_{15} \hat{s}_{25}^* \hat{s}_{26} c_{36} - c_{14} c_{15} \hat{s}_{16} c_{26} c_{36} & & \end{pmatrix}
\end{aligned}$$

It is clear that the texture of  $B$  is quite similar to that of  $A$ , and the texture of  $S$  is also analogous to that of  $R$ . One may actually obtain the expression of  $B$  from that of  $A^*$  with the subscript replacements  $15 \leftrightarrow 24$ ,  $16 \leftrightarrow 34$  and  $26 \leftrightarrow 35$ . Similarly, the expression of  $S$  can be obtained from that of  $-R^*$  with the same subscript replacements.

We proceed to define  $U \equiv AU_0$  and  $U' \equiv U'_0 B$  which describe the flavor mixing phenomena of three active neutrinos and three sterile neutrinos, respectively. The flavor eigenstates of these six neutrino species can therefore be expressed as

$$\begin{pmatrix} \nu_e \\ \nu_\mu \\ \nu_\tau \end{pmatrix} = U \begin{pmatrix} \nu_1 \\ \nu_2 \\ \nu_3 \end{pmatrix} + R \begin{pmatrix} \nu_4 \\ \nu_5 \\ \nu_6 \end{pmatrix}, \quad \begin{pmatrix} \nu_x \\ \nu_y \\ \nu_z \end{pmatrix} = U' \begin{pmatrix} \nu_4 \\ \nu_5 \\ \nu_6 \end{pmatrix} + S' \begin{pmatrix} \nu_1 \\ \nu_2 \\ \nu_3 \end{pmatrix} \quad (209)$$

with the definition  $S' \equiv U'_0 S U_0$ . Combining Eq. (209) with Eq. (4a), we obtain the standard weak charged-current interactions of six neutrinos with three charged leptons:

$$-\mathcal{L}_{cc} = \frac{g}{\sqrt{2}} \overline{(e \ \mu \ \tau)_L} \gamma^\mu \left[ U \begin{pmatrix} \nu_1 \\ \nu_2 \\ \nu_3 \end{pmatrix}_L + R \begin{pmatrix} \nu_4 \\ \nu_5 \\ \nu_6 \end{pmatrix}_L \right] W_\mu^- + \text{h.c.}, \quad (210)$$

where  $U$  is just the  $3 \times 3$  PMNS matrix responsible for the active neutrino mixing in the presence of sterile neutrinos, and  $R$  measures the strength of charged-current interactions between  $(e, \mu, \tau)$  and  $(\nu_4, \nu_5, \nu_6)$ . One can see that Eq. (210) simply reproduces Eq. (24) if  $\nu_4, \nu_5$  and  $\nu_6$  are taken to be the mass eigenstates of three heavy Majorana neutrinos (i.e.,  $N_1, N_2$  and  $N_3$ ) in the canonical seesaw mechanism. Given

$$UU^\dagger = AA^\dagger = I - RR^\dagger, \quad U'^\dagger U' = B^\dagger B = I - R^\dagger R, \quad (211)$$

we conclude that both  $U$  and  $U'$  are not exactly unitary as a consequence of the small interplay or mixing between the active and sterile neutrino sectors.



Current experimental and observational constraints on the active-sterile neutrino mixing are so strong that the corresponding mixing angles  $\theta_{ij}$  (for  $i = 1, 2, 3$  and  $j = 4, 5, 6$ ) are badly suppressed and their magnitudes are at most at the  $O(0.1)$  level [122, 556, 557, 558]. The smallness of these nine active-sterile flavor mixing angles allows us to make the following excellent approximations for Eqs. (206)—(208):

$$\begin{aligned}
A &\simeq I - \frac{1}{2} \begin{pmatrix} s_{14}^2 + s_{15}^2 + s_{16}^2 & 0 & 0 \\ 2\hat{s}_{14}\hat{s}_{24}^* + 2\hat{s}_{15}\hat{s}_{25}^* + 2\hat{s}_{16}\hat{s}_{26}^* & s_{24}^2 + s_{25}^2 + s_{26}^2 & 0 \\ 2\hat{s}_{14}\hat{s}_{34}^* + 2\hat{s}_{15}\hat{s}_{35}^* + 2\hat{s}_{16}\hat{s}_{36}^* & 2\hat{s}_{24}\hat{s}_{34}^* + 2\hat{s}_{25}\hat{s}_{35}^* + 2\hat{s}_{26}\hat{s}_{36}^* & s_{34}^2 + s_{35}^2 + s_{36}^2 \end{pmatrix}, \\
B &\simeq I - \frac{1}{2} \begin{pmatrix} s_{14}^2 + s_{24}^2 + s_{34}^2 & 0 & 0 \\ 2\hat{s}_{14}\hat{s}_{15}^* + 2\hat{s}_{24}\hat{s}_{25}^* + 2\hat{s}_{34}\hat{s}_{35}^* & s_{15}^2 + s_{25}^2 + s_{35}^2 & 0 \\ 2\hat{s}_{14}\hat{s}_{16}^* + 2\hat{s}_{24}\hat{s}_{26}^* + 2\hat{s}_{34}\hat{s}_{36}^* & 2\hat{s}_{15}\hat{s}_{16}^* + 2\hat{s}_{25}\hat{s}_{26}^* + 2\hat{s}_{35}\hat{s}_{36}^* & s_{16}^2 + s_{26}^2 + s_{36}^2 \end{pmatrix}, \quad (212)
\end{aligned}$$

where the terms of  $O(s_{ij}^4)$  have been omitted; and

$$R \simeq -S^\dagger \simeq \begin{pmatrix} \hat{s}_{14}^* & \hat{s}_{15}^* & \hat{s}_{16}^* \\ \hat{s}_{24}^* & \hat{s}_{25}^* & \hat{s}_{26}^* \\ \hat{s}_{34}^* & \hat{s}_{35}^* & \hat{s}_{36}^* \end{pmatrix}, \quad (213)$$

where the terms of  $O(s_{ij}^3)$  have been omitted.

### 5.1.2. The Jarlskog invariants for active neutrinos

It is known that the  $n \times n$  unitary flavor mixing matrix contains  $(n-1)^2(n-2)^2/4$  distinct Jarlskog-like invariants of CP violation [471, 559]. When the  $6 \times 6$  unitary matrix  $\mathcal{U}$  in Eq. (202) is concerned, we are totally left with one hundred Jarlskog-like invariants. But these invariants are correlated with one another because they are all the functions of fifteen CP-violating phases  $\delta_{ij}$  (for  $1 \leq i < j \leq 6$ ). In practice one is mainly interested in the Jarlskog-like parameters defined from the elements of the  $3 \times 3$  non-unitary matrix  $U \equiv AU_0$  for three active neutrinos, simply because they measure the strength of leptonic CP violation in neutrino oscillations:

$$\mathcal{J}_{\alpha\beta}^{ij} \equiv \text{Im} \left( U_{\alpha i} U_{\beta j} U_{\alpha j}^* U_{\beta i}^* \right), \quad (214)$$

in which the Greek and Latin indices run over  $(e, \mu, \tau)$  and  $(1, 2, 3)$ , respectively. If the sterile neutrino sector is switched off, one will arrive at  $U = U_0$  and a universal Jarlskog invariant  $\mathcal{J}_\nu$  defined in Eq. (108). That is,  $\mathcal{J}_{e\mu}^{12} = \mathcal{J}_{e\mu}^{23} = \mathcal{J}_{e\mu}^{31} = \mathcal{J}_{\mu\tau}^{12} = \mathcal{J}_{\mu\tau}^{23} = \mathcal{J}_{\mu\tau}^{31} = \mathcal{J}_{\tau e}^{12} = \mathcal{J}_{\tau e}^{23} = \mathcal{J}_{\tau e}^{31} \equiv \mathcal{J}_\nu$ , where  $\mathcal{J}_\nu$  has been expressed in Eq. (109) with the CP-violating phase  $\delta_\nu$  defined as  $\delta_\nu \equiv \delta_{13} - \delta_{12} - \delta_{23}$  based on the parametrization of  $U_0$  in Eq. (205a). Taking account of the interplay between active and sterile neutrinos, we now obtain

$$\begin{aligned}
\mathcal{J}_{e\mu}^{12} &\simeq \mathcal{J}_\nu + c_{12}s_{12}c_{23}\text{Im}X, \\
\mathcal{J}_{\tau e}^{12} &\simeq \mathcal{J}_\nu + c_{12}s_{12}s_{23}\text{Im}Y, \\
\mathcal{J}_{\mu\tau}^{12} &\simeq \mathcal{J}_\nu + c_{12}s_{12}c_{23}s_{23} (s_{23}\text{Im}X + c_{23}\text{Im}Y), \\
\mathcal{J}_{\mu\tau}^{23} &\simeq \mathcal{J}_\nu + c_{12}c_{23}s_{23} (s_{12}s_{23}\text{Im}X + s_{12}c_{23}\text{Im}Y + c_{12}\text{Im}Z), \\
\mathcal{J}_{\mu\tau}^{31} &\simeq \mathcal{J}_\nu + s_{12}c_{23}s_{23} (c_{12}s_{23}\text{Im}X + c_{12}c_{23}\text{Im}Y - s_{12}\text{Im}Z), \quad (215)
\end{aligned}$$

together with  $\mathcal{J}_{e\mu}^{23} \simeq \mathcal{J}_{e\mu}^{31} \simeq \mathcal{J}_{\tau e}^{23} \simeq \mathcal{J}_{\tau e}^{31} \simeq \mathcal{J}_\nu$ , where  $X \equiv \mathcal{X}e^{-i\delta_{12}}$ ,  $Y \equiv \mathcal{Y}e^{-i(\delta_{12}+\delta_{23})}$  and  $Z \equiv \mathcal{Z}e^{-i\delta_{23}}$  with  $\mathcal{X} \equiv \hat{s}_{14}\hat{s}_{24}^* + \hat{s}_{15}\hat{s}_{25}^* + \hat{s}_{16}\hat{s}_{26}^*$ ,  $\mathcal{Y} \equiv \hat{s}_{14}\hat{s}_{34}^* + \hat{s}_{15}\hat{s}_{35}^* + \hat{s}_{16}\hat{s}_{36}^*$  and  $\mathcal{Z} \equiv \hat{s}_{24}\hat{s}_{34}^* + \hat{s}_{25}\hat{s}_{35}^* + \hat{s}_{26}\hat{s}_{36}^*$ . These results tell us that new effects of CP violation may in general show up in active neutrino oscillations, provided the active-sterile neutrino mixing angles and CP-violating phases are not negligibly small. Note that  $\mathcal{J}_{e\mu}^{23} \simeq \mathcal{J}_{e\mu}^{31} \simeq \mathcal{J}_{\tau e}^{23} \simeq \mathcal{J}_{\tau e}^{31} \simeq \mathcal{J}_\nu$  holds as a good approximation because these four Jarlskog-like invariants all involve the smallest element of  $U$  (i.e.,  $U_{e3} \simeq \hat{s}_{13}^*$ ) [560].

The above observation can also be understood from taking a look at how the three Dirac unitarity triangles defined in Eq. (125), which are sensitive to active neutrino oscillations, get deformed in the presence of sterile neutrinos. With the help of Eqs. (211) and (213), we immediately find

$$\begin{aligned}\Delta'_e &: U_{\mu 1}U_{\tau 1}^* + U_{\mu 2}U_{\tau 2}^* + U_{\mu 3}U_{\tau 3}^* \simeq -\mathcal{Z}^*, \\ \Delta'_\mu &: U_{\tau 1}U_{e 1}^* + U_{\tau 2}U_{e 2}^* + U_{\tau 3}U_{e 3}^* \simeq -\mathcal{Y}, \\ \Delta'_\tau &: U_{e 1}U_{\mu 1}^* + U_{e 2}U_{\mu 2}^* + U_{e 3}U_{\mu 3}^* \simeq -\mathcal{X}^*,\end{aligned}\tag{216}$$

where  $\mathcal{X}$ ,  $\mathcal{Y}$  and  $\mathcal{Z}$  have been defined below Eq. (215). In other words,  $\Delta'_\alpha$  (for  $\alpha = e, \mu$  or  $\tau$ ) is actually a quadrangle in the complex plane, and its departure from the standard unitarity triangle  $\Delta_\alpha$  signifies the impact of sterile neutrinos on active neutrinos.

If all the three species of sterile neutrinos are light enough and thus kinematically allowed to participate in the oscillations of three active neutrinos, then one may simply extend the standard results in Eqs. (84) and (85) by including the contributions from  $\nu_4$ ,  $\nu_5$  and  $\nu_6$ . In this case the probability of  $\nu_\alpha \rightarrow \nu_\beta$  oscillations (for  $\alpha, \beta = e, \mu, \tau$ ) can be expressed as

$$\begin{aligned}P(\nu_\alpha \rightarrow \nu_\beta) &= \delta_{\alpha\beta} - 4 \sum_{i < j} \left[ \text{Re}(\mathcal{U}_{\alpha i} \mathcal{U}_{\beta j} \mathcal{U}_{\alpha j}^* \mathcal{U}_{\beta i}^*) \sin^2 \frac{\Delta m_{ji}^2 L}{4E} \right] \\ &\quad + 2 \sum_{i < j} \left[ \text{Im}(\mathcal{U}_{\alpha i} \mathcal{U}_{\beta j} \mathcal{U}_{\alpha j}^* \mathcal{U}_{\beta i}^*) \sin \frac{\Delta m_{ji}^2 L}{2E} \right]\end{aligned}\tag{217}$$

with the definition  $\Delta m_{ji}^2 \equiv m_j^2 - m_i^2$  (for  $i, j = 1, \dots, 6$ ). Needless to say, the probability of  $\bar{\nu}_\alpha \rightarrow \bar{\nu}_\beta$  oscillations can be directly read off from Eq. (217) by replacing  $\mathcal{U}$  with  $\mathcal{U}^*$ . The CP-violating terms in such neutrino and antineutrino oscillations are therefore dependent on all the CP-violating phases of the  $6 \times 6$  flavor mixing matrix  $\mathcal{U}$  or their combinations.

If all the three species of sterile neutrinos are heavy enough and hence kinematically forbidden to take part in the oscillations of three active neutrinos, the amplitude of the active  $\nu_\alpha \rightarrow \nu_\beta$  oscillation (for  $\alpha, \beta = e, \mu, \tau$ ) in vacuum can be expressed in an analogous way as that in Eq. (84):

$$\begin{aligned}A(\nu_\alpha \rightarrow \nu_\beta) &= \sum_i [A(W^+ + \alpha^- \rightarrow \nu_i) \cdot \text{Propagation}(\nu_i) \cdot A(\nu_i \rightarrow W^+ + \beta^-)] \\ &= \frac{1}{\sqrt{(UU^\dagger)_{\alpha\alpha}(UU^\dagger)_{\beta\beta}}} \sum_i \left[ U_{\alpha i}^* \exp\left(-i \frac{m_i^2 L}{2E}\right) U_{\beta i} \right],\end{aligned}\tag{218}$$

in which  $A(W^+ + \alpha^- \rightarrow \nu_i) = U_{\alpha i}^* / \sqrt{(UU^\dagger)_{\alpha\alpha}}$  and  $A(\nu_i \rightarrow W^+ + \beta^-) = U_{\beta i} / \sqrt{(UU^\dagger)_{\beta\beta}}$  describe the production of  $\nu_\alpha$  at the source and the detection of  $\nu_\beta$  at the detector via the corresponding

weak charged-current interactions, respectively [561]. It is then straightforward to calculate the oscillation probability  $P(\nu_\alpha \rightarrow \nu_\beta) = |A(\nu_\alpha \rightarrow \nu_\beta)|^2$  in vacuum. The result is

$$P(\nu_\alpha \rightarrow \nu_\beta) = \frac{1}{(UU^\dagger)_{\alpha\alpha}(UU^\dagger)_{\beta\beta}} \left[ \sum_i |U_{\alpha i}|^2 |U_{\beta i}|^2 + 2 \sum_{i<j} \text{Re}(U_{\alpha i} U_{\beta j} U_{\alpha j}^* U_{\beta i}^*) \cos \frac{\Delta m_{ji}^2 L}{2E} + 2 \sum_{i<j} \mathcal{J}_{\alpha\beta}^{ij} \sin \frac{\Delta m_{ji}^2 L}{2E} \right], \quad (219)$$

where the Jarlskog-like invariants  $\mathcal{J}_{\alpha\beta}^{ij}$  have been defined in Eq. (214), and the Latin subscripts  $i$  and  $j$  run only over 1, 2 and 3. As indicated by Eq. (219), extra CP-violating effects induced by the active-sterile neutrino mixing are expected to show up in the active neutrino oscillations.

### 5.1.3. On the (3+2) and (3+1) flavor mixing scenarios

In the phenomenological aspects of particle physics, astrophysics and cosmology, one sometimes prefers to follow the principle of *Occam's razor* — “entities must not be multiplied beyond necessity” — to reduce the number of free parameters of a given model or mechanism when confronting it with a very limited number of experimental measurements or observations. The most popular example of this kind in neutrino physics should be the so-called *minimal* seesaw mechanism in which only two heavy Majorana neutrinos are introduced to interpret both the tiny masses of three active neutrinos and the observed matter-antimatter asymmetry of the Universe [238], and a much simpler scenario along this line of thought is the so-called *littlest* seesaw model which has fewer free parameters [562]. Recently some more attention has been paid to the application of Occam's razor as an empirical guiding principle in studying fermion mass textures and flavor mixing patterns [563, 564, 565, 566, 567].

To parametrize the interplay between two heavy sterile neutrinos and three light active neutrinos in the minimal seesaw scenario, one may simply switch off the contributions from  $O_{i6}$  (for  $i = 1, \dots, 5$ ) in Eq. (208). In this case the form of  $U_0$  keeps unchanged in the  $5 \times 5$  flavor mixing matrix  $\mathcal{U}$ , but  $U'_0$ ,  $B$ ,  $R$  and  $S$  are simplified to be the  $2 \times 2$ ,  $3 \times 2$  and  $2 \times 3$  matrices, respectively. Since only  $U = AU_0$  and  $R$  take part in the weak charged-current interactions shown in Eq. (210), here we write out the explicit expressions of  $A$  and  $R$  as follows [555]:

$$A = \begin{pmatrix} c_{14}c_{15} & 0 & 0 \\ -c_{14}\hat{s}_{15}\hat{s}_{25}^* - \hat{s}_{14}\hat{s}_{24}^*c_{25} & c_{24}c_{25} & 0 \\ -c_{14}\hat{s}_{15}c_{25}\hat{s}_{35}^* + \hat{s}_{14}\hat{s}_{24}^*\hat{s}_{25}\hat{s}_{35}^* - \hat{s}_{14}c_{24}\hat{s}_{34}^*c_{35} & -c_{24}\hat{s}_{25}\hat{s}_{35}^* - \hat{s}_{24}\hat{s}_{34}^*c_{35} & c_{34}c_{35} \end{pmatrix},$$

$$R = \begin{pmatrix} \hat{s}_{14}c_{15} & \hat{s}_{15}^* \\ -\hat{s}_{14}\hat{s}_{15}\hat{s}_{25}^* + c_{14}\hat{s}_{24}^*c_{25} & c_{15}\hat{s}_{25}^* \\ -\hat{s}_{14}\hat{s}_{15}c_{25}\hat{s}_{35}^* - c_{14}\hat{s}_{24}^*\hat{s}_{25}\hat{s}_{35}^* + c_{14}c_{24}\hat{s}_{34}^*c_{35} & c_{15}c_{25}\hat{s}_{35}^* \end{pmatrix}. \quad (220)$$

Once the  $5 \times 5$  flavor mixing matrix  $\mathcal{U}$  is fully parametrized in the minimal seesaw framework, it is then straightforward to reconstruct the  $3 \times 3$  Dirac mass matrix  $M_D$  and the  $2 \times 2$  Majorana neutrino mass matrix  $M_R$  in terms of their mass eigenvalues and relevant flavor mixing parameters.

Note that some different parametrization schemes for the minimal seesaw mechanism have been proposed in the literature [239, 568, 569, 570, 571, 572], but all of them have neglected the small deviation of  $U$  from  $U_0$  (i.e.,  $A \simeq I$  has been assumed).

Another simple example of this kind is the so-called minimal type-(I+II) seesaw model which contains a single heavy Majorana neutrino and the Higgs triplet [573, 574, 575, 576]. In this special case Eq. (220) is further simplified to

$$A = \begin{pmatrix} c_{14} & 0 & 0 \\ -\hat{s}_{14}\hat{s}_{24}^* & c_{24} & 0 \\ -\hat{s}_{14}c_{24}\hat{s}_{34}^* & -c_{24}\hat{s}_{25}\hat{s}_{35}^* - \hat{s}_{24}\hat{s}_{34}^* & c_{34} \end{pmatrix}, \quad R = \begin{pmatrix} \hat{s}_{14}^* \\ c_{14}\hat{s}_{24}^* \\ c_{14}c_{24}\hat{s}_{34}^* \end{pmatrix}, \quad (221)$$

by switching off the contributions from both  $O_{i5}$  (for  $i = 1, \dots, 4$ ) and  $O_{i6}$  (for  $i = 1, \dots, 5$ ). The phenomenological consequences of such a seesaw scenario are expected to be more easily tested, thanks to the parameter cutting with Occam's razor.

Note that it is sometimes more convenient to write out the full parametrization of the  $4 \times 4$  flavor mixing matrix  $\mathcal{U}$  in a generic (3+1) active-sterile neutrino mixing scheme, no matter whether the sterile neutrino is heavy or light. In this connection one usually denotes the flavor and mass eigenstates of such a sterile neutrino species as  $\nu_s$  and  $\nu_4$ , respectively. Then the  $4 \times 4$  active-sterile neutrino mixing matrix  $\mathcal{U}$  can be written as

$$\begin{pmatrix} \nu_e \\ \nu_\mu \\ \nu_\tau \\ \nu_s \end{pmatrix} = \begin{pmatrix} \mathcal{U}_{e1} & \mathcal{U}_{e2} & \mathcal{U}_{e3} & \mathcal{U}_{e4} \\ \mathcal{U}_{\mu1} & \mathcal{U}_{\mu2} & \mathcal{U}_{\mu3} & \mathcal{U}_{\mu4} \\ \mathcal{U}_{\tau1} & \mathcal{U}_{\tau2} & \mathcal{U}_{\tau3} & \mathcal{U}_{\tau4} \\ \mathcal{U}_{s1} & \mathcal{U}_{s2} & \mathcal{U}_{s3} & \mathcal{U}_{s4} \end{pmatrix} \begin{pmatrix} \nu_1 \\ \nu_2 \\ \nu_3 \\ \nu_4 \end{pmatrix}, \quad (222)$$

where  $\mathcal{U}_{\alpha 4}$  (for  $\alpha = e, \mu, \tau$ ) and  $\mathcal{U}_{si}$  (for  $i = 1, 2, 3$ ) must be strongly suppressed in magnitude. Explicitly,  $\mathcal{U} = O_{34}O_{24}O_{14}O_{23}O_{13}O_{12}$  reads as follows:

$$\mathcal{U} = \begin{pmatrix} c_{12}c_{13}c_{14} & c_{13}c_{14}\hat{s}_{12}^* & c_{14}\hat{s}_{13}^* & \hat{s}_{14}^* \\ -c_{12}c_{13}\hat{s}_{14}\hat{s}_{24}^* & -c_{13}\hat{s}_{12}^*\hat{s}_{14}\hat{s}_{24}^* & -\hat{s}_{13}^*\hat{s}_{14}\hat{s}_{24}^* & c_{14}\hat{s}_{24}^* \\ -c_{12}c_{24}\hat{s}_{13}\hat{s}_{23}^* & -c_{24}\hat{s}_{12}^*\hat{s}_{13}\hat{s}_{23}^* & +c_{13}c_{24}\hat{s}_{23}^* & \\ -c_{23}c_{24}\hat{s}_{12} & +c_{12}c_{23}c_{24} & & \\ -c_{12}c_{13}c_{24}\hat{s}_{14}\hat{s}_{34}^* & -c_{13}c_{24}\hat{s}_{12}^*\hat{s}_{14}\hat{s}_{34}^* & -c_{24}\hat{s}_{13}^*\hat{s}_{14}\hat{s}_{34}^* & c_{14}c_{24}\hat{s}_{34}^* \\ +c_{12}\hat{s}_{13}\hat{s}_{23}\hat{s}_{24}\hat{s}_{34}^* & +\hat{s}_{12}^*\hat{s}_{13}\hat{s}_{23}^*\hat{s}_{24}\hat{s}_{34}^* & -c_{13}\hat{s}_{23}^*\hat{s}_{24}\hat{s}_{34}^* & \\ -c_{12}c_{23}c_{34}\hat{s}_{13} & -c_{23}c_{34}\hat{s}_{12}^*\hat{s}_{13} & +c_{13}c_{23}c_{34} & \\ +c_{23}\hat{s}_{12}\hat{s}_{24}\hat{s}_{34}^* & -c_{12}c_{23}\hat{s}_{24}\hat{s}_{34}^* & & \\ +c_{34}\hat{s}_{12}\hat{s}_{23} & -c_{12}c_{34}\hat{s}_{23} & & \\ -c_{12}c_{13}c_{24}c_{34}\hat{s}_{14} & -c_{13}c_{24}c_{34}\hat{s}_{12}^*\hat{s}_{14} & -c_{24}c_{34}\hat{s}_{13}^*\hat{s}_{14} & c_{14}c_{24}c_{34} \\ +c_{12}c_{34}\hat{s}_{13}\hat{s}_{23}^*\hat{s}_{24} & +c_{34}\hat{s}_{12}^*\hat{s}_{13}\hat{s}_{23}^*\hat{s}_{24} & -c_{13}c_{34}\hat{s}_{23}^*\hat{s}_{24} & \\ +c_{12}c_{23}\hat{s}_{13}\hat{s}_{34} & +c_{23}\hat{s}_{12}^*\hat{s}_{13}\hat{s}_{34} & -c_{13}c_{23}\hat{s}_{34} & \\ +c_{23}c_{34}\hat{s}_{12}\hat{s}_{24} & -c_{12}c_{23}c_{34}\hat{s}_{24} & & \\ -\hat{s}_{12}\hat{s}_{23}\hat{s}_{34} & +c_{12}\hat{s}_{23}\hat{s}_{34} & & \end{pmatrix}, \quad (223)$$

where  $c_{ij} \equiv \cos \theta_{ij}$  and  $\hat{s}_{ij} \equiv e^{i\delta_{ij}} \sin \theta_{ij}$  are defined as before (for  $1 \leq i < j \leq 4$ ). It is obvious that  $\mathcal{U}$  contains six rotation angles and six CP-violating phases. But the nine distinct Jarlskog-like invariants of  $\mathcal{U}$ , defined by  $\mathcal{J}_{\alpha\beta}^{ij} \equiv \text{Im}(\mathcal{U}_{\alpha i} \mathcal{U}_{\beta j} \mathcal{U}_{\alpha j}^* \mathcal{U}_{\beta i}^*)$  as Eq. (214), depend only upon three phase combinations  $\delta_\nu \equiv \delta_{13} - \delta_{12} - \delta_{23}$ ,  $\delta'_\nu \equiv \delta_{14} - \delta_{12} - \delta_{24}$  and  $\delta''_\nu \equiv \delta_{14} - \delta_{13} - \delta_{34}$  [478]. It has been shown that these invariants can be geometrically linked to the areas of a number of unitarity quadrangles in the complex plane [577].

## 5.2. The seesaw-motivated heavy Majorana neutrinos

### 5.2.1. Naturalness and testability of seesaw mechanisms

As described in section 2.2.3, the key point of a conventional seesaw mechanism is to attribute the tiny masses of three known neutrinos (i.e.,  $\nu_i$  versus  $\nu_\alpha$  for  $i = 1, 2, 3$  and  $\alpha = e, \mu, \tau$ ) to the existence of some new and heavy degrees of freedom. The latter may either slightly mix with  $\nu_\alpha$  (e.g., in the type-I, type-III and inverse seesaw scenarios) or have no mixing with  $\nu_\alpha$  at all (e.g., in the type-II seesaw mechanism). Accordingly, the unitarity of the  $3 \times 3$  PMNS matrix  $U$  will either be slightly violated or hold exactly.

The energy scale at which a seesaw mechanism works is crucially important, since it is closely associated with whether this mechanism is theoretically natural and experimentally testable [181]. One may argue that the conventional seesaw mechanisms are natural because their scales (or equivalently, the masses of heavy seesaw particles) are not far away from a presumably fundamental energy scale — the GUT scale  $\Lambda_{\text{GUT}} \sim 10^{16}$  GeV, which is more than ten orders of magnitude greater than the Fermi (or electroweak) scale  $\Lambda_{\text{EW}} \sim 10^2$  GeV. The masses of three known neutrinos are therefore expected to be of order  $m_i \sim \Lambda_{\text{EW}}^2 / \Lambda_{\text{SS}}$  with  $\Lambda_{\text{SS}}$  being the seesaw scale, and then  $m_i \sim \mathcal{O}(0.1)$  eV can be naturally achieved if  $\Lambda_{\text{SS}} \sim 10^{14}$  GeV is assumed. But this kind of naturalness is accompanied by two problems: on the one hand,  $\Lambda_{\text{SS}}$  is too high to be experimentally accessible, and hence such a seesaw mechanism cannot be directly tested; on the other hand, the heavy degrees of freedom may cause a potential hierarchy problem — the latter is usually spoke of when two largely different energy scales exist in a given model but there is no symmetry to stabilize low-scale physics which may suffer from significant quantum corrections stemming from high-scale physics [108].

To be more specific, the so-called seesaw-induced hierarchy problem means that the mass of the Higgs boson in the SM is considerably sensitive to quantum corrections that result from heavy degrees of freedom at the energy scale  $\Lambda_{\text{SS}} \gg \Lambda_{\text{EW}}$  [214, 215, 216]. Given the canonical (type-I) seesaw mechanism, for example, one finds

$$\delta M_H^2 \simeq -\frac{y_i^2}{8\pi^2} \left( \Lambda_{\text{SS}}^2 + M_i^2 \ln \frac{M_i^2}{\Lambda_{\text{SS}}^2} \right), \quad (224)$$

where  $\Lambda_{\text{SS}}$  represents the regulator cutoff,  $y_i$  and  $M_i$  (for  $i = 1, 2, 3$ ) stand respectively for the eigenvalues of  $Y_\nu$  and  $M_R$  in Eq. (30), and the smaller contributions proportional to  $v^2$  and  $M_H^2$  have been neglected. The quadratic sensitivity of  $\delta M_H^2$  to the seesaw scale  $\Lambda_{\text{SS}}$  implies that a high degree of fine-tuning is unavoidable between the bare mass of the Higgs boson and the quantum corrections, so as to make the theory consistent with the experimental measurement of  $M_H$  (i.e.,  $M_H \simeq 125$  GeV as observed at the LHC [19]). If  $\Lambda_{\text{SS}} \sim M_i$  is assumed and  $|\delta M_H^2| \lesssim 0.1 \text{ TeV}^2$  is

typically required for the sake of illustration, then the leading term of Eq. (224) leads us to a naive estimate of the form

$$M_i \sim \left[ \frac{(2\pi v)^2}{m_i} |\delta M_H^2| \right]^{1/3} \lesssim 1.3 \times 10^7 \text{ GeV} \left[ \frac{0.1 \text{ eV}}{m_i} \right]^{1/3} \left[ \frac{|\delta M_H^2|}{0.1 \text{ TeV}^2} \right]^{1/3}, \quad (225)$$

where the approximate seesaw relation  $m_i \sim y_i^2 v^2 / (2M_i)$  has been taken into account. In this case the bound  $M_i \lesssim 1.3 \times 10^7 \text{ GeV}$  corresponds to  $y_i \sim \sqrt{2m_i M_i} / v \lesssim 2.1 \times 10^{-4}$  for  $m_i \sim 0.1 \text{ eV}$ . Such small  $y_i$  should be regarded as an *unnatural* choice, because the conventional seesaw picture mainly ascribes the smallness of  $m_i$  to the largeness of  $M_i$  instead of the smallness of  $y_i$  [181, 578]. In particular, the strong suppression of  $y_i$  means that it is in practice very difficult to produce heavy Majorana neutrinos via their interactions with three charged leptons at a high-energy collider, as one can see from Eqs. (24)—(28). In other words, the observability of  $N_i$  demands that their masses and Yukawa couplings be both experimentally accessible [579, 580].

The above arguments mean that lowering the seesaw scale may soften the seesaw-induced hierarchy problem<sup>29</sup>, but this will trigger the naturalness problem and hence make the spirit of the seesaw mechanism partly lost. Moreover, the testability of a viable seesaw mechanism requires its heavy degrees of freedom to be light enough and thus producible at an accelerator but its Yukawa couplings to be sizable enough and hence detectable in a realistic experiment. Given the canonical seesaw scenario, for instance, these two requirements cannot be satisfied unless  $M_D$  and  $M_R$  possess very contrived structures which allow for an almost complete “structural cancellation” in the seesaw formula  $M_\nu \simeq -M_D M_R^{-1} M_D^T$  [217, 575, 588, 589, 590, 591, 592]. As a consequence, the lepton-number-violating collider signatures of  $N_i$  in such a TeV- or  $\Lambda_{\text{EW}}$ -scale seesaw model are essentially decoupled from the mass and flavor mixing parameters of three light neutrinos  $\nu_i$  (for  $i = 1, 2, 3$ ) [172]. Such a problem can be avoided in the type-II seesaw mechanism because its typical collider signatures, which are the like-sign dilepton events arising from the lepton-number-violating decays of the doubly-charged Higgs bosons, directly depend on the matrix elements of  $M_\nu$  (i.e., both the light neutrino masses and the PMNS flavor mixing parameters) [576, 593, 594, 595, 596, 597, 598, 599, 600, 601]. In this sense the type-II seesaw scenario seems a bit more attractive than the type-I seesaw scenario to bridge the gap between neutrino physics at low energies and collider physics at high energies. Nevertheless, one should keep in mind that the elegant thermal leptogenesis mechanism works better in association with the type-I seesaw mechanism [172, 228, 229].

To strike a balance between the naturalness and testability requirements for the canonical seesaw pictures at the TeV scale, which is now accessible with the help of the LHC, one may make the simplest extension by introducing a number of gauge-singlet fermions and scalars to build a *multiple* seesaw model [211, 212]. In this case the tiny masses of three light neutrinos  $\nu_i$  are generated via an approximate seesaw relation of the form  $m_i \sim (y_i \Lambda_{\text{EW}})^{n+1} / \Lambda_{\text{SS}}^n$  with  $y_i$  being the Yukawa

<sup>29</sup>It is theoretically more popular to invoke a new type of spacetime symmetry — supersymmetry [581, 582, 583, 584, 585, 586, 587] to resolve the hierarchy problem. This means that all the heavy Majorana neutrinos should have their superpartners in the canonical seesaw mechanism, a high price that one has to pay especially in the situation that no evidence for supersymmetry has been found at the LHC and in all the other high-energy experiments.

coupling eigenvalues and  $n$  being an arbitrary integer larger than one. It is then natural to achieve  $\Lambda_{\text{SS}} \sim 1 \text{ TeV}$  from  $n \gtrsim 2$ ,  $m_i \sim 0.1 \text{ eV}$  and  $y_i \gtrsim 10^{-3}$ . Note that the inverse (or double) seesaw model [209, 210] and its variation are just one of the simplest versions [560] of the multiple seesaw picture. The obvious drawback of such TeV-scale seesaw scenarios and other models along a different line of thought [213, 602, 603] is the introduction of too many new particles which are usually hard to be detected. Just as argued by Steven Weinberg in his *third law of progress in theoretical physics* [604], “You may use any degrees of freedom you like to describe a physical system, but if you use the wrong ones, you will be sorry”.

In short, it is possible to realize a specific seesaw mechanism between the Fermi scale  $\Lambda_{\text{EW}}$  and the GUT scale  $\Lambda_{\text{GUT}}$  to interpret the smallness of  $m_i$  for three active neutrinos  $\nu_i$ . But one has to pay the price regarding the demands of theoretical naturalness and experimental testability for such a seesaw scenario. In any case a judicious combination of the canonical seesaw and leptogenesis mechanisms will be really a way to kill two birds with one stone in neutrino physics and cosmology, as schematically illustrated by Figs. 7 and 8.

### 5.2.2. Reconstruction of the neutrino mass matrices

The type-(I+II) seesaw mechanism is an ideal example to illustrate how to reconstruct the Dirac and Majorana neutrino mass matrices with the help of the  $6 \times 6$  flavor mixing matrix  $\mathcal{U}$  in the chosen basis where the charged-lepton mass matrix has been taken to be diagonal. In this mechanism the mass term of six neutrinos is an extension of Eq. (20):

$$\begin{aligned} -\mathcal{L}'_{\text{hybrid}} &= \frac{1}{2} \overline{\nu_L} M_L (\nu_L)^c + \overline{\nu_L} M_D N_R + \frac{1}{2} \overline{(N_R)^c} M_R N_R + \text{h.c.} \\ &= \frac{1}{2} \overline{\begin{bmatrix} \nu_L & (N_R)^c \end{bmatrix}} \begin{pmatrix} M_L & M_D \\ M_D^T & M_R \end{pmatrix} \begin{bmatrix} (\nu_L)^c \\ N_R \end{bmatrix} + \text{h.c.} , \end{aligned} \quad (226)$$

where  $M_L$  and  $M_R$  are the Majorana mass matrices. The overall  $6 \times 6$  neutrino mass matrix in Eq. (226) can be diagonalized by a unitary transformation of the form

$$\mathcal{U}^\dagger \begin{pmatrix} M_L & M_D \\ M_D^T & M_R \end{pmatrix} \mathcal{U}^* = \begin{pmatrix} D_\nu & 0 \\ 0 & D_N \end{pmatrix} , \quad (227)$$

where  $D_\nu \equiv \text{Diag}\{m_1, m_2, m_3\}$  and  $D_N \equiv \text{Diag}\{M_1, M_2, M_3\}$  have been defined below Eq. (21). The standard weak charged-current interactions of six neutrinos are described by Eq. (24), or equivalently by Eq. (210) with  $\nu_4 = N_1$ ,  $\nu_5 = N_2$  and  $\nu_6 = N_3$ . With the help of Eqs. (202) and (203), we immediately obtain

$$\begin{aligned} M_L &= U D_\nu U^T + R D_N R^T \simeq U_0 D_\nu U_0^T + R D_N R^T , \\ M_D &= U D_\nu S'^T + R D_N U'^T \simeq R D_N U_0'^T , \\ M_R &= S' D_\nu S'^T + U' D_N U'^T \simeq U_0' D_N U_0'^T , \end{aligned} \quad (228)$$

where  $U \equiv A U_0$ ,  $U' \equiv U_0' B$  and  $S' \equiv U_0' S U_0$  have been defined around Eq. (209). On the right-hand side of Eq. (228) we have made the approximation by keeping only the leading terms of  $M_L$ ,

$M_D$  and  $M_R$ . It is then possible to reconstruct these  $3 \times 3$  neutrino mass matrices in terms of the neutrino masses and flavor mixing parameters.

Given the fact that nothing is known about the purely sterile sector, it is practically useful to take the basis where  $M_R$  is diagonal. In this case  $U'_0 \simeq I$  turns out to be a good approximation, as indicated by Eq. (228). It is worth pointing out that such a flavor basis is often chosen in the study of leptogenesis, simply because the lepton-number-violating and CP-violating decays of  $N_i$  (for  $i = 1, 2, 3$ ) need to be calculated. It is particularly easy to reconstruct  $M_D$  and  $M_L$  in this special basis [554]. To be more specific,

$$M_D \simeq RD_N \simeq \begin{pmatrix} M_1 \hat{s}_{14}^* & M_2 \hat{s}_{15}^* & M_3 \hat{s}_{16}^* \\ M_1 \hat{s}_{24}^* & M_2 \hat{s}_{25}^* & M_3 \hat{s}_{26}^* \\ M_1 \hat{s}_{34}^* & M_2 \hat{s}_{35}^* & M_3 \hat{s}_{36}^* \end{pmatrix}; \quad (229)$$

and the six independent matrix elements of  $M_L$  are

$$\begin{aligned} (M_L)_{ee} &\simeq m_1 (c_{12}c_{13})^2 + m_2 (\hat{s}_{12}^*c_{13})^2 + m_3 (\hat{s}_{13}^*)^2 + M_1 (\hat{s}_{14}^*)^2 + M_2 (\hat{s}_{15}^*)^2 + M_3 (\hat{s}_{16}^*)^2, \\ (M_L)_{e\mu} &\simeq -m_1 c_{12}c_{13} (\hat{s}_{12}c_{23} + c_{12}\hat{s}_{13}\hat{s}_{23}^*) + m_2 \hat{s}_{12}^*c_{13} (c_{12}c_{23} - \hat{s}_{12}^*\hat{s}_{13}\hat{s}_{23}^*) + m_3 c_{13}\hat{s}_{13}^*\hat{s}_{23}^* \\ &\quad + M_1 \hat{s}_{14}^*\hat{s}_{24}^* + M_2 \hat{s}_{15}^*\hat{s}_{25}^* + M_3 \hat{s}_{16}^*\hat{s}_{26}^*, \\ (M_L)_{e\tau} &\simeq m_1 c_{12}c_{13} (\hat{s}_{12}\hat{s}_{23} - c_{12}\hat{s}_{13}c_{23}) - m_2 \hat{s}_{12}^*c_{13} (c_{12}\hat{s}_{23} + \hat{s}_{12}^*\hat{s}_{13}c_{23}) + m_3 c_{13}\hat{s}_{13}^*c_{23} \\ &\quad + M_1 \hat{s}_{14}^*\hat{s}_{34}^* + M_2 \hat{s}_{15}^*\hat{s}_{35}^* + M_3 \hat{s}_{16}^*\hat{s}_{36}^*, \\ (M_L)_{\mu\mu} &\simeq m_1 (\hat{s}_{12}c_{23} + c_{12}\hat{s}_{13}\hat{s}_{23}^*)^2 + m_2 (c_{12}c_{23} - \hat{s}_{12}^*\hat{s}_{13}\hat{s}_{23}^*)^2 + m_3 (c_{13}\hat{s}_{23}^*)^2 \\ &\quad + M_1 (\hat{s}_{24}^*)^2 + M_2 (\hat{s}_{25}^*)^2 + M_3 (\hat{s}_{26}^*)^2, \\ (M_L)_{\mu\tau} &\simeq -m_1 (\hat{s}_{12}c_{23} + c_{12}\hat{s}_{13}\hat{s}_{23}^*) (\hat{s}_{12}\hat{s}_{23} - c_{12}\hat{s}_{13}c_{23}) \\ &\quad - m_2 (c_{12}c_{23} - \hat{s}_{12}^*\hat{s}_{13}\hat{s}_{23}^*) (c_{12}\hat{s}_{23} + \hat{s}_{12}^*\hat{s}_{13}c_{23}) + m_3 c_{13}^2 c_{23}\hat{s}_{23}^* \\ &\quad + M_1 \hat{s}_{24}^*\hat{s}_{34}^* + M_2 \hat{s}_{25}^*\hat{s}_{35}^* + M_3 \hat{s}_{26}^*\hat{s}_{36}^*, \\ (M_L)_{\tau\tau} &\simeq m_1 (\hat{s}_{12}\hat{s}_{23} - c_{12}\hat{s}_{13}c_{23})^2 + m_2 (c_{12}\hat{s}_{23} + \hat{s}_{12}^*\hat{s}_{13}c_{23})^2 + m_3 (c_{13}c_{23})^2 \\ &\quad + M_1 (\hat{s}_{34}^*)^2 + M_2 (\hat{s}_{35}^*)^2 + M_3 (\hat{s}_{36}^*)^2. \end{aligned} \quad (230)$$

Note that the canonical (type-I) seesaw mechanism can be reproduced from the type-(I+II) seesaw mechanism by taking  $M_L = 0$ , implying that all the six matrix elements in Eq. (230) must vanish. These strong constraint conditions are actually consistent with the exact type-I seesaw relation  $UD_\nu U^T + RD_N R^T = 0$  obtained in Eq. (27) with  $O = U$  in the chosen  $M_l = D_l$  basis.

Note also that the approximations made in Eq. (228) allow us to achieve the approximate but popular seesaw relation  $M_\nu \simeq -M_D M_R^{-1} M_D^T$ , from which one may parametrize the Dirac neutrino mass matrix  $M_D$  in the basis of  $M_R = D_N$  [605]:

$$M_D \simeq iUD_\nu^{1/2}\Omega D_N^{1/2}, \quad (231)$$

where  $U \simeq U_0$  in the neglect of tiny unitarity-violating effects, and  $\Omega$  is a complex orthogonal matrix containing three rotation angles and three phase parameters. A comparison of Eq. (229) with Eq. (231) allows one to establish a correlation between these two descriptions [606].



Given  $M_D$ , a calculation of the CP-violating asymmetries  $\varepsilon_{i\alpha}$  (for  $i = 1, 2, 3$  and  $\alpha = e, \mu, \tau$ ) between the decay rates of  $N_i \rightarrow \ell_\alpha + H$  and its CP-conjugate process  $N_i \rightarrow \bar{\ell}_\alpha + \bar{H}$  with the help of Eq. (50) will be possible. In view of the relations

$$\begin{aligned}\text{Im} \left[ (Y_\nu^*)_{\alpha i} (Y_\nu)_{\alpha j} (Y_\nu^\dagger Y_\nu)_{ij} \right] &\simeq \frac{4}{v^4} M_i^2 M_j^2 \text{Im} \left[ R_{\alpha i}^* R_{\alpha j} (R^\dagger R)_{ij} \right], \\ \text{Im} \left[ (Y_\nu^*)_{\alpha i} (Y_\nu)_{\alpha j} (Y_\nu^\dagger Y_\nu)^*_{ij} \right] &\simeq \frac{4}{v^4} M_i^2 M_j^2 \text{Im} \left[ R_{\alpha i}^* R_{\alpha j} (R^\dagger R)^*_{ij} \right],\end{aligned}\quad (232)$$

it becomes transparent that the nine CP-violating asymmetries  $\varepsilon_{i\alpha}$  depend on the nine CP-violating phase differences  $\delta_{i4} - \delta_{i5}$ ,  $\delta_{i4} - \delta_{i6}$  and  $\delta_{i5} - \delta_{i6}$  (for  $i = 1, 2, 3$ ), among which six of them are independent. This observation also implies that the CP-violating phases of  $M_\nu$  at low energies are in general not directly connected to those of  $Y_\nu$  at high energies [161].

### 5.2.3. On lepton flavor violation of charged leptons

Thanks to the discoveries of neutrino oscillations in a number of solar, atmospheric, reactor and accelerator experiments, the fact of lepton flavor violation in the neutrino sector has been convincingly established. It is the PMNS matrix  $U$  in Eq. (2) that describes the effects of lepton flavor violation in the SM extended with the finite masses of three known neutrinos. Just like quark flavor violation, which happens in those weak flavor-changing processes of both up- and down-type quarks, lepton flavor violation should also take place in the charged-lepton sector. The most typical example of this kind is the  $\mu^- \rightarrow e^- + \gamma$  decay mode, whose one-loop Feynman diagram is illustrated by Fig. 25(a) in accordance with the standard weak interactions between charged leptons and massive neutrinos described by Eq. (2). Given the tiny masses of three light neutrinos  $\nu_i$  (for  $i = 1, 2, 3$ ), the branching ratio of this rare decay is found to be formidably suppressed in magnitude [111, 607, 608, 609, 610, 611, 612]<sup>30</sup>

$$\mathcal{B}(\mu^- \rightarrow e^- + \gamma) = \frac{3\alpha_{\text{em}}}{32\pi} \left| \sum_{i=1}^3 U_{\mu i}^* U_{ei} \frac{m_i^2}{M_W^2} \right|^2 = \frac{3\alpha_{\text{em}}}{32\pi} \left| \sum_{i=2}^3 U_{\mu i}^* U_{ei} \frac{\Delta m_{i1}^2}{M_W^2} \right|^2 \lesssim 10^{-54}, \quad (233)$$

where the unitarity of the  $3 \times 3$  PMNS matrix  $U$  has been assumed, and a rough estimate based on current experimental data on the neutrino mass-squared differences and the PMNS matrix elements has been made. It is obvious that switching off the neutrino masses will make such a reaction completely forbidden, consistent with our naive expectation that lepton flavor violation and its smallness in the charged-lepton sector are closely related to the finite and non-degenerate neutrino masses in the minimal extension of the SM under discussion. Since the rate of  $\mu^- \rightarrow e^- + \gamma$  in Eq. (233) is about forty orders of magnitude smaller than the sensitivity of current experiments, any observation of charged-lepton flavor violation will be an unambiguous signal of new physics beyond the SM [613, 614, 615, 616]. Besides  $\mu^\pm \rightarrow e^\pm + \gamma$ , the other muon-associated lepton-flavor-violating processes include  $\mu^\pm \rightarrow e^\pm + e^\pm + e^\mp$ ,  $\mu^\pm + N \rightarrow e^\pm + N$ ,  $\mu^\pm + N \rightarrow e^\mp + N'$  and  $\mu^\pm + e^\mp \rightarrow \mu^\mp + e^\pm$ , where  $N$  and  $N'$  denote the relevant nuclei. The tau-associated processes of this kind include  $\tau^\pm \rightarrow \mu^\pm + \gamma$ ,  $\tau^\pm \rightarrow e^\pm + \gamma$ ,  $\tau^\pm \rightarrow \mu^\pm + \mu^\pm + e^\mp$  and  $\tau^\pm \rightarrow \mu^\pm + \mu^\mp + e^\pm$ , and so on.

<sup>30</sup>This result applies strictly to the Dirac neutrinos. If  $\nu_i$  (for  $i = 1, 2, 3$ ) are the Majorana particles, the origin of their tiny masses is believed to have something to do with some heavy degrees of freedom which may also contribute to  $\mu^- \rightarrow e^- + \gamma$ . See Fig. 25(b) and Eq. (234) for illustration in the type-I seesaw mechanism.

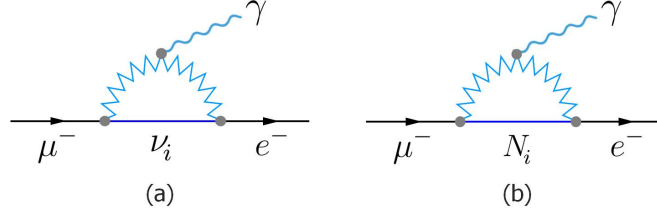

Figure 25: The one-loop Feynman diagrams for the lepton-flavor-violating  $\mu^- \rightarrow e^- + \gamma$  decay in the canonical seesaw model, mediated by the light and heavy Majorana neutrinos (i.e.,  $\nu_i$  and  $N_i$  for  $i = 1, 2, 3$ ), respectively.

Given the existence of three heavy Majorana neutrinos  $N_i$  in the canonical seesaw mechanism, which slightly mix with the charged leptons as described by the  $3 \times 3$  matrix  $R$  in Eq. (24), the rare decay  $\mu^- \rightarrow e^- + \gamma$  may also occur via Fig. 25(b). In this case its branching ratio turns out to be

$$\begin{aligned} \mathcal{B}(\mu^- \rightarrow e^- + \gamma) &= \frac{3\alpha_{\text{em}}}{2\pi} \left| \sum_{i=1}^3 U_{\mu i}^* U_{ei} G_\gamma(x_i) + \sum_{i=1}^3 R_{\mu i}^* R_{ei} G_\gamma(x'_i) \right|^2, \\ &\simeq \frac{3\alpha_{\text{em}}}{32\pi} \left| \sum_{i=1}^3 U_{\mu i}^* U_{ei} \frac{m_i^2}{M_W^2} + 2 \sum_{i=1}^3 R_{\mu i}^* R_{ei} \right|^2, \end{aligned} \quad (234)$$

where  $x_i \equiv m_i^2/M_W^2 \ll 1$  and  $x'_i \equiv M_i^2/M_W^2 \gg 1$  (for  $i = 1, 2, 3$ ), and  $G_\gamma(x)$  is the loop function which approaches  $x/4$  for  $x \ll 1$  or  $1/2$  for  $x \gg 1$  [617, 618, 619]. Note that the  $3 \times 3$  PMNS matrix  $U$  is not exactly unitary because it is correlated with  $R$  through  $UU^\dagger + RR^\dagger = I$  as shown in Eq. (211), and the explicit parametrizations of  $U$  and  $R$  have been given in section 5.1.1. Note also that the exact type-I seesaw relation  $UD_\nu U^T + RD_N R^T = 0$ , in which  $D_\nu = \text{Diag}\{m_1, m_2, m_3\}$  and  $D_N = \text{Diag}\{M_1, M_2, M_3\}$ , makes the light and heavy Majorana neutrino masses intimately correlated with the relevant flavor mixing parameters. To enhance the rate of this rare decay to a level close to the present experimental sensitivity, one may abandon the requirement  $x'_i \gg 1$  by lowering the conventional seesaw scale to the TeV regime or even lower such that the active-sterile neutrino mixing angles  $\theta_{ij}$  (for  $i = 1, 2, 3$  and  $j = 4, 5, 6$ ) of  $R$  can be as large as possible [122, 216, 616, 617, 618, 620, 621]. If one goes beyond the SM framework by incorporating the seesaw scenarios with some supersymmetric theories, for example, it will certainly be possible to achieve much richer phenomenology of lepton flavor violation in the charged-lepton sector [605, 619, 622, 623, 624, 625, 626, 627, 628, 629, 630, 631, 632, 633].

Of course, the heavy Majorana neutrinos can also mediate the lepton-number-violating decays such as the  $0\nu 2\beta$  processes depicted in Fig. 4(a) with the replacement  $\nu_i \rightarrow N_i$  (for  $i = 1, 2, 3$ ). In this case the nuclear matrix elements associated with light and heavy Majorana neutrinos are quite different and thus involve more uncertainties [186, 195, 634, 635]. When the contribution of  $N_i$  to the effective neutrino mass term  $\langle m \rangle_{ee}$  is *least* suppressed, the overall width of a  $0\nu 2\beta$  decay mode in the canonical seesaw scenario can be approximately expressed as [197]

$$\Gamma_{0\nu 2\beta} \propto \left| \sum_{i=1}^3 m_i U_{ei}^2 - M_A^2 \sum_{i=1}^3 \frac{R_{ei}^2}{M_i} \mathcal{F}(A, M_i) \right|^2 = \left| \sum_{i=1}^3 M_i R_{ei}^2 \left[ 1 + \frac{M_A^2}{M_i} \mathcal{F}(A, M_i) \right] \right|^2, \quad (235)$$

where  $A$  denotes the atomic number of the isotope,  $\mathcal{F}(A, M_i) \simeq 0.1$  depending mildly on the decaying nucleus, and  $M_A \simeq 0.1$  GeV [634, 636]. In obtaining the second equality of Eq. (235) we have used the exact seesaw relation  $(UD_\nu U^T)_{ee} = -(RD_N R^T)_{ee}$ . In view of the fact that the values of  $M_i$  are far above the electroweak scale  $\Lambda_{\text{EW}} \sim 10^2$  GeV, the second term in the square brackets of Eq. (235) must be negligible in most cases, unless the contribution of  $\nu_i$  is vanishing or vanishingly small due to a significant cancellation among three different  $m_i U_{ei}^2$  components [197, 198]. This observation implies that the lepton-number-violating  $0\nu 2\beta$  decays are essentially insensitive to the heavy degrees of freedom in the canonical seesaw mechanism.

### 5.3. keV-scale sterile neutrinos as warm dark matter

#### 5.3.1. On the keV-scale sterile neutrino species

In the past decades a lot of new and robust evidence for the existence of non-luminous and non-baryonic matter — dark matter (DM) in the Universe has been accumulated, but the nature of such a strange form of matter remains a fundamental puzzle in modern science. Although the three known neutrinos and their antiparticles definitely contribute to DM, their masses are so tiny that they belong to the category of hot (or relativistic) DM and only constitute a very small fraction of the total matter density of the Universe. A careful study of the structure formation indicates that most of DM should be cold (or non-relativistic) at the onset of the galaxy formation [19]. The most popular and well-motivated candidates for cold DM are expected to be the weakly interacting massive particles (WIMPs) and axions (or axion-like particles), even though many other exotic particles have also been proposed in building models beyond the SM [121].

In between the hot and cold regimes, warm DM is another intriguing possibility of explaining the observed non-luminous and non-baryonic matter content in the Universe. The presence of warm DM is likely to solve or soften several problems that one has so far encountered in current DM simulations [637], such as damping the inhomogeneities on small scales by reducing the number of dwarf galaxies or smoothing the cusps in the DM halos. From the point of view of particle physics, the keV-mass-scale sterile neutrinos are expected to be an ideal candidate for warm DM [118, 119, 120, 121]. Since sterile neutrinos are electrically neutral leptons, they satisfy the so-called Tremaine-Gunn bound in cosmology [638] (i.e., their phase space distribution in a galaxy cannot exceed that of the degenerate Fermi gas, and hence the mass of a single sterile neutrino should be above 0.4 keV if such particles constitute 100% of the observed DM). To play a prominent role as warm DM, keV-scale sterile neutrinos ought to be efficiently produced in the early Universe. Given the fact that such sterile particles are unable to thermalize in an easy way, the simplest mechanism for their production is either via non-resonant active-sterile neutrino oscillations [118, 639] or through resonant active-sterile neutrino oscillations in the presence of a non-negligible lepton number asymmetry [640, 641, 642].

For the sake of simplicity and illustration, here we assume that there is only a single sterile neutrino species and its mass scale is around  $\mathcal{O}(1)$  keV to constitute warm DM. Denoting the mass eigenstate of such a sterile neutrino species  $\nu_s$  as  $\nu_4$ , one may simply write out the  $4 \times 4$  active-sterile neutrino mixing matrix  $\mathcal{U}$  as in Eq. (222) and then parametrize it as in Eq. (223). Since  $|\theta_{i4}| \ll 1$  (for  $i = 1, 2, 3$ ) is naturally expected, let us simplify the parametrization of  $\mathcal{U}$  by taking  $|\mathcal{U}_{e4}|^2 \simeq \sin^2 \theta_{14}$ ,  $|\mathcal{U}_{\mu 4}|^2 \simeq \sin^2 \theta_{24}$ ,  $|\mathcal{U}_{\tau 4}|^2 \simeq \sin^2 \theta_{34}$  and  $|\mathcal{U}_{s4}|^2 \simeq 1$  for the four matrix elements relevant to  $\nu_4$  as a very good approximation. The dominant decay modes of  $\nu_4$  with  $m_4 \sim \mathcal{O}(1)$

keV are  $\nu_4 \rightarrow \nu_\alpha + \nu_\beta + \bar{\nu}_\beta$  (for  $\alpha, \beta = e, \mu, \tau$ ) mediated by the  $Z^0$  boson at the tree level, and a sum of their decay rates is given by [89]

$$\sum_{\alpha=e}^{\tau} \sum_{\beta=e}^{\tau} \Gamma(\nu_4 \rightarrow \nu_\alpha + \nu_\beta + \bar{\nu}_\beta) = \frac{\eta_\nu G_F^2 m_4^5}{192\pi^3} \sum_{\alpha=e}^{\tau} |\mathcal{U}_{\alpha 4}|^2, \quad (236)$$

where  $\eta_\nu = 1$  (Dirac neutrinos) or  $\eta_\nu = 2$  (Majorana neutrinos). As a result, the lifetime of  $\nu_4$  is

$$\tau_{\nu_4} \simeq \frac{2.88 \times 10^{27}}{\eta_\nu} \left( \frac{m_4}{1 \text{ keV}} \right)^{-5} \left( \frac{\sin^2 \theta_*}{10^{-8}} \right)^{-1} \text{ s}, \quad (237)$$

where  $\sin^2 \theta_* \equiv \sin^2 \theta_{14} + \sin^2 \theta_{24} + \sin^2 \theta_{34}$  with  $\theta_*$  being an effective (overall) active-sterile neutrino mixing angle. This lifetime is expected to be much larger than the age of the Universe ( $\sim 10^{17}$  s). That is why the keV-scale sterile neutrinos may be a natural candidate for warm DM.

Note that in practice warm DM in the form of keV-scale sterile neutrinos is always produced out of thermal equilibrium, and therefore its primordial momentum distribution is in general not described by the Fermi-Dirac distribution [643]. Note also that this kind of DM may not only suppress the formation of dwarf galaxies and other small-scale structures but also have impacts on the X-ray spectrum, the velocity distribution of pulsars and the formation of the first stars [644, 645]. So the effective mass and mixing parameters of keV-scale sterile neutrinos can be stringently constrained by measuring the X-ray fluxes and the Lyman- $\alpha$  forest [646, 647].

The X-ray signal of a sterile neutrino  $\nu_4$  with mass  $m_4 \sim \mathcal{O}(1)$  keV is the photon with energy  $E_\gamma \simeq m_4/2$ , emitted from its radiative decay  $\nu_4 \rightarrow \nu_i + \gamma$  (for  $i = 1, 2, 3$ ). Given  $m_4 \gg m_i$ , the sum of the three decay rates is found to be [89, 648, 649]

$$\begin{aligned} \sum_{i=1}^3 \Gamma(\nu_4 \rightarrow \nu_i + \gamma) &= \frac{9\alpha_{\text{em}}\eta_\nu G_F^2 m_4^5}{512\pi^4} |\mathcal{U}_{s4}|^2 \sum_{\alpha=e}^{\tau} |\mathcal{U}_{\alpha 4}|^2 \\ &\simeq \frac{9\alpha_{\text{em}}\eta_\nu G_F^2 m_4^5}{512\pi^4} \sin^2 \theta_* \simeq \frac{\eta_\nu \sin^2 2\theta_*}{1.5 \times 10^{22}} \left( \frac{m_4}{1 \text{ keV}} \right)^5 \text{ s}^{-1}, \end{aligned} \quad (238)$$

where  $\alpha_{\text{em}} \simeq 1/137$  is the electromagnetic fine-structure constant. So far most of the astronomical searches for a DM decay line in X-rays have not led us to a convincing signal. Such negative results can be used to constrain  $\sin^2 2\theta_*$  as a function of  $m_4$ , as illustrated in Fig. 26 [643, 650]. The smallness of  $\theta_*$  implies that the active-sterile neutrino mixing angles  $\theta_{i4}$  (for  $i = 1, 2, 3$ ) are at most of  $\mathcal{O}(10^{-4})$ , and hence it is very difficult to directly detect the existence of such keV-scale sterile particles in a realistic laboratory experiment.

Note that an unidentified line with  $E_\gamma \simeq 3.55$  keV has recently been reported in the stacked spectrum of galaxy clusters [651], in the individual spectra of nearby galaxy clusters [651, 652, 653], in the Andromeda galaxy [652], and in the Galactic Center region [654]. Explaining this line as a signal of the  $\nu_4 \rightarrow \nu_i + \gamma$  decay, one may arrive at the mass  $m_4 \simeq 7.1$  keV and the lifetime  $\tau_{\nu_4} \sim 10^{27.8 \pm 0.3}$  s [652]. Then it is straightforward to obtain  $\sin^2 2\theta_* \sim 5 \times 10^{-11}$  from Eq. (238) with  $\eta_\nu = 2$  for the sterile Majorana neutrinos. But whether this observation is really solid and the corresponding interpretation is close to the truth remains to be seen.

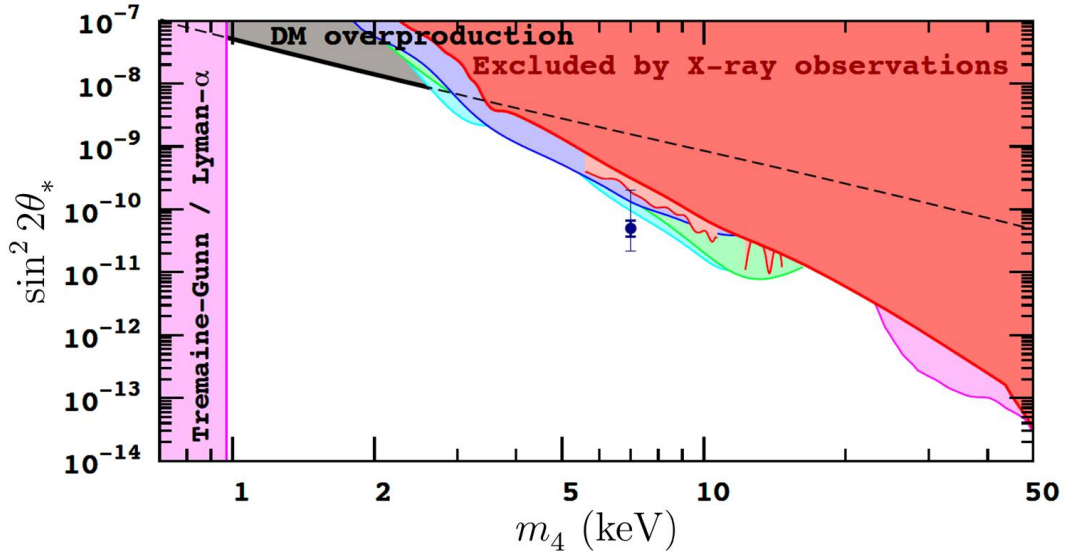

Figure 26: Current limits on the effective active-sterile neutrino mixing parameter  $\sin^2 2\theta_*$  as a function of the sterile neutrino mass  $m_4$  in the warm DM picture [643], in which the dark point corresponds to the unidentified line in X-rays with  $E_\gamma \simeq 3.55$  keV or  $m_4 \simeq 7.1$  keV.

Sterile neutrinos of  $\mathcal{O}(1)$  keV have been taken into account in some phenomenological models [557, 643, 655], although a part of such models are more or less contrived from a theoretical point of view. Two typical examples of this kind are the so-called neutrino minimal standard model (or  $\nu$ MSM) [656] and the so-called split seesaw model [657], which can not only realize the seesaw and leptogenesis ideas but also accommodate one keV-scale sterile neutrino species as the warm DM candidate. Here let us mention a purely phenomenological and model-independent argument to support the conjecture of keV-scale sterile neutrinos as warm DM [89]. Fig. 2 shows that there exists a remarkable desert spanning six orders of magnitude between  $\mathcal{O}(0.5)$  eV and  $\mathcal{O}(0.5)$  MeV in the mass spectrum of twelve known fundamental fermions. This *flavor desert* puzzle might be solved if one or more keV-scale sterile neutrinos are allowed to exist in the desert and they are arranged to satisfy all the prerequisites of warm DM.

### 5.3.2. A possibility to detect keV-scale sterile neutrinos

As first pointed out by Weinberg in 1962 [658], it is in principle possible to capture the cosmic low-energy electron neutrinos on radioactive  $\beta$ -decaying nuclei (i.e.,  $\nu_e + N \rightarrow N' + e^-$ ). If there exists a keV-scale sterile neutrino species which slightly mixes with the active neutrinos as described by  $\mathcal{U}$  in Eq. (222), then the  $\nu_4$  component of  $\nu_e$  is expected to leave a distinct imprint on the electron energy spectrum<sup>31</sup>. Note that such a capture reaction can take place for any kinetic energy of the incident neutrino, simply because the associated  $\beta$  decay  $N \rightarrow N' + e^- + \bar{\nu}_e$  always

<sup>31</sup>It is worth pointing out that the  $\beta$ -decaying nuclei can only be used to capture the *neutrino* component of hot or warm DM. When the keV-scale sterile *antineutrino* DM is concerned, it is necessary to consider the electron-capture decaying nuclei as a possible capture target. In this connection the isotope  $^{163}\text{Ho}$  is an interesting candidate that has been studied to some extent [659].

releases some energies ( $Q_\beta = m_N - m_{N'} - m_e > 0$ ). That is why Weinberg's idea is uniquely advantageous to the detection of cosmic neutrinos whose masses and energies are much smaller than the value of  $Q_\beta$  [660, 661, 662, 663, 664]. Since the product of the cross section of non-relativistic neutrinos  $\sigma_i$  and their average velocity  $v_i$  converges to a constant value in the low-energy limit [661, 662], the capture rate for each  $\nu_i$  can be expressed as  $\mathcal{N}_i = N_T |\mathcal{U}_{ei}|^2 \sigma_i v_i n_i$ , in which  $n_i$  stands for the number density of  $\nu_i$  around the Earth or in our solar system, and  $N_T$  denotes the average number of target nuclei for the duration of detection. Assuming that the keV-scale sterile neutrinos account for the total amount of DM in our Galactic neighborhood, one may estimate their number density with the help of the average density of local DM  $\rho_{\text{DM}}^{\text{local}} \simeq 0.3 \text{ GeV cm}^{-3}$  [665]. The value turns out to be  $n_4 \simeq 10^5 (3 \text{ keV}/m_4) \text{ cm}^{-3}$ . On the other hand, the average number of the target nuclei in the detecting time interval  $t$  is  $N_T = N(0)(1 - e^{-\lambda t})/(\lambda t)$ , where  $\lambda = \ln 2/t_{1/2}$  with  $t_{1/2}$  being the half-life of the target nuclei, and  $N(0)$  is the initial number of the target nuclei [89].

In the capture reaction each non-relativistic neutrino  $\nu_i$  is in principle expected to produce a monoenergetic electron with the kinetic energy  $T_e^{(i)} = Q_\beta + E_{\nu_i} \simeq Q_\beta + m_i$ . Given the fact that a realistic experiment must have a finite energy resolution, one may take into account a Gaussian energy resolution function in calculating the overall neutrino capture rate (i.e., the energy spectrum of the detected electrons):

$$\mathcal{N}_\nu = \sum_{i=1}^4 \left\{ N_T |\mathcal{U}_{ei}|^2 \sigma_i v_i n_i \frac{1}{\sqrt{2\pi} \sigma} \exp \left[ -\frac{(T_e - T_e^{(i)})^2}{2\sigma^2} \right] \right\}, \quad (239)$$

where  $\sigma$  characterizes a finite energy resolution and its unit is keV. Note that  $N_T \simeq N(0)$  is an excellent approximation for long-lived  ${}^3\text{H}$ , but this is not true for  ${}^{106}\text{Ru}$  and some other heavy nuclei which have either  $t_{1/2} \sim t$  or  $t_{1/2} < t$ . The main background of such a neutrino capture process is certainly its corresponding  $\beta$  decay. Since the finite energy resolution may push the outgoing electron's ideal endpoint  $Q_\beta - \min(m_i)$  towards a higher energy region, it is likely to mimic the desired signal of the neutrino capture reaction [664, 666]. Taking the same energy resolution as that in Eq. (239), we can describe the energy spectrum of a  $\beta$  decay as

$$\begin{aligned} \frac{d\mathcal{N}_\beta}{dT_e} = & \int_0^{Q_\beta - \min(m_i)} dT'_e \left\{ N_T \frac{G_F^2 \cos^2 \vartheta_C}{2\pi^3} F(Z, E_e) |\mathcal{M}|^2 \sqrt{E_e^2 - m_e^2} E_e (Q_\beta - T'_e) \right. \\ & \left. \times \sum_{i=1}^4 \left[ |\mathcal{U}_{ei}|^2 \sqrt{(Q_\beta - T'_e)^2 - m_i^2} \Theta(Q_\beta - T'_e - m_i) \right] \frac{1}{\sqrt{2\pi} \sigma} \exp \left[ -\frac{(T_e - T'_e)^2}{2\sigma^2} \right] \right\}, \quad (240) \end{aligned}$$

where  $T'_e = E_e - m_e$  is the intrinsic kinetic energy of the outgoing electron,  $F(Z, E_e)$  denotes the Fermi function,  $|\mathcal{M}|^2$  stands for the dimensionless contribution of relevant nuclear matrix elements [667], and  $\vartheta_C \simeq 13^\circ$  is the Cabibbo angle. Given the standard parametrization of the  $4 \times 4$  active-sterile neutrino mixing matrix  $\mathcal{U}$  in Eq. (223), it is apparently the mixing angle  $\theta_{14}$  that determines how significant the role of  $\nu_4$  can be in Eqs. (239) and (240), corresponding respectively to the signal and the background. In view of the stringent constraint shown in Fig. 26 and the fact that  $\sin^2 \theta_{14}$  is just one of the three components of  $\sin^2 \theta_*$ , we roughly expect  $\sin^2 \theta_{14} \lesssim 10^{-8}$ . This expectation implies that the capture rate of keV-scale sterile neutrino DM on radioactive  $\beta$ -decaying nuclei must be extremely small.

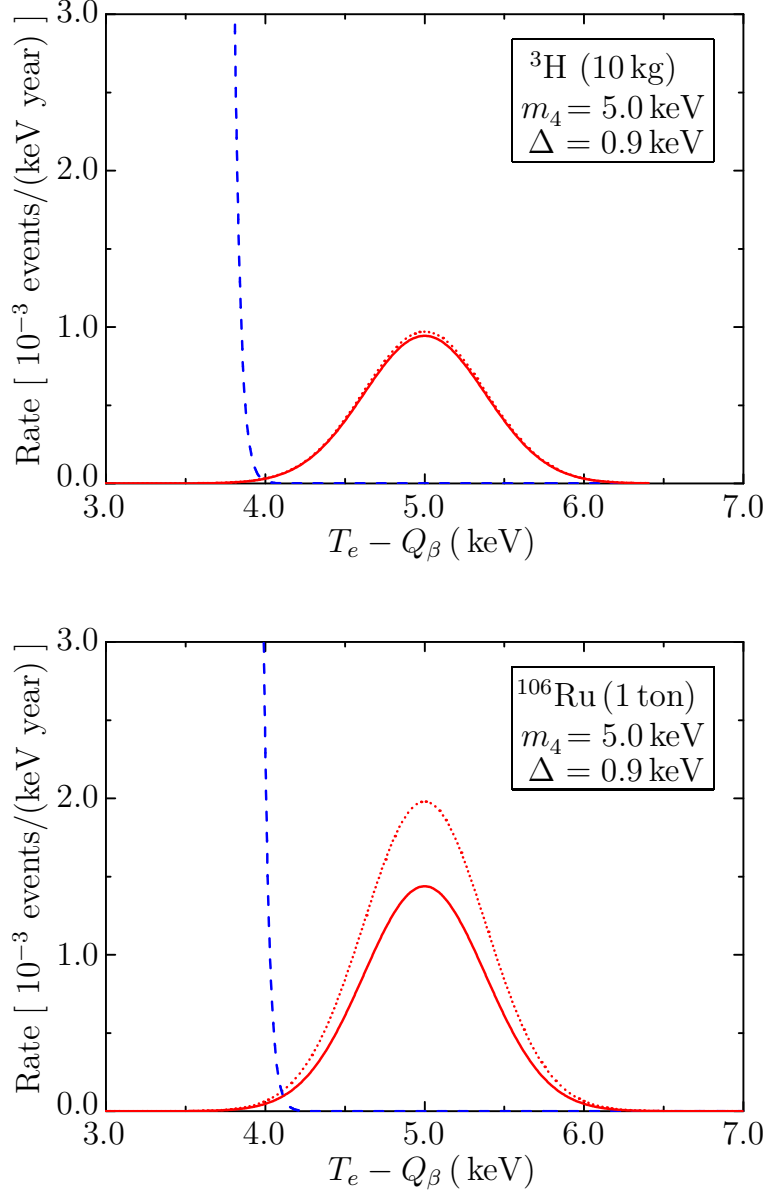

Figure 27: The capture rate of keV sterile neutrino DM as a function of the kinetic energy  $T_e$  of the electrons, where  $m_4 \simeq 5$  keV and  $\sin^2 \theta_{14} \simeq 1 \times 10^{-9}$  are typically input. The solid (or dotted) curves denote the signals with (or without) the half-life effect of the target nuclei, and the dashed curve stands for the  $\beta$ -decay background [664].

For the purpose of illustration, let us choose tritium ( $^3\text{H}$ ) and ruthenium ( $^{106}\text{Ru}$ ) nuclei as the benchmark targets to capture keV sterile neutrino DM, simply because their capture reactions have relatively large cross sections. Here we quote the inputs  $Q_\beta = 18.59$  keV,  $t_{1/2} = 3.8878 \times 10^8$  s and  $\sigma_i v_i/c = 7.84 \times 10^{-45}$  cm $^2$  for  $^3\text{H}$ ; and  $Q_\beta = 39.4$  keV,  $t_{1/2} = 3.2278 \times 10^7$  s and  $\sigma_i v_i/c = 5.88 \times 10^{-45}$  cm $^2$  for  $^{106}\text{Ru}$ , where  $c$  is the speed of light [661]. For simplicity, we adopt  $|\mathcal{M}|^2 \simeq 5.55$  for both  $^3\text{H}$  and  $^{106}\text{Ru}$  [667]. A numerical analysis shows that the relative values of  $T_e - Q_\beta$  in

the electron energy spectra of the neutrino capture reaction and the corresponding  $\beta$  decay are insensitive to the input of  $|\mathcal{M}|^2$ , although  $d\mathcal{N}_\beta/dT_e$  itself is sensitive to  $|\mathcal{M}|^2$  [664]. With the help of Eqs. (239) and (240), we calculate the capture rate  $\mathcal{N}_\nu$  and the background distribution  $d\mathcal{N}_\beta/dT_e$  for  ${}^3\text{H}$  and  ${}^{106}\text{Ru}$  nuclei by typically taking  $m_4 \simeq 5$  keV and  $\sin^2 \theta_{14} \simeq 1 \times 10^{-9}$ . The normal mass ordering of three active neutrinos with  $m_1 \simeq 0$  is assumed, and the best-fit values of three active neutrino mixing angles are input. Fig. 27 is a summary of the main numerical results, where the finite energy resolution  $\Delta = 2\sqrt{2 \ln 2} \sigma \simeq 2.35482 \sigma$  has been chosen to distinguish the signal from the background. Furthermore, the half-life  $t_{1/2}$  of target nuclei should be taken into account because their number has been decreasing during the experiment. We give a comparison between the result including the finite half-life effect and that in the assumption of a constant number of target nuclei for an experiment with the one-year exposure time (i.e.,  $t = 1$  year). To optimistically illustrate the signature of keV-scale sterile neutrino DM in this detection method, we assume 10 kg  ${}^3\text{H}$  and 1 ton  ${}^{106}\text{Ru}$  as the isotope sources in our calculations. It is worth emphasizing that the half-life effect is important for the source of  ${}^{106}\text{Ru}$  nuclei, but it is negligible for the source of  ${}^3\text{H}$  nuclei. The endpoint of the  $\beta$ -decay energy spectrum is sensitive to  $\Delta$ , while the peak of the neutrino-capture energy spectrum is always located at  $T_e \simeq Q_\beta + m_4$ . In practice a relatively large gap between the location of the signature of  $\nu_4$  and the  $\beta$ -decay endpoint in the electron recoil energy spectrum implies that the signature should be essentially independent of the corresponding  $\beta$ -decay background [664, 666]<sup>32</sup>.

A good news is that the required energy resolution to identify a signature of keV-scale sterile neutrino DM is of  $\mathcal{O}(0.1)$  keV to  $\mathcal{O}(1)$  keV, which may easily be reached in the realistic KATRIN  $\beta$ -decay experiment with  ${}^3\text{H}$  being the isotope source [669, 670]. The bad news is that the tiny active-sterile neutrino mixing angles make the observability of such hypothetical particles rather dim and remote. For instance, the capture rate of  $\nu_4$  on 10 kg  ${}^3\text{H}$  (or 1 ton  ${}^{106}\text{Ru}$ ) nuclei is only of  $\mathcal{O}(10^{-3})$  per year for  $m_4 \simeq 5$  keV and  $\sin^2 \theta_{14} \simeq 1 \times 10^{-9}$ , as shown in Fig. 27. In this regard new ideas and novel detection techniques are needed to go beyond the state of the art [643].

## 5.4. Anomaly-motivated light sterile neutrinos

### 5.4.1. The anomalies hinting at light sterile neutrinos

From a theoretical point of view, there is almost no motivation to consider the existence of one or more light sterile neutrino species in the eV mass range because such hypothetical particles are not expected to help solve any fundamental problems known today in the flavor sector of particle physics and cosmology. But since 1995 some anomalous results have been obtained in several short-baseline neutrino experiments, triggering off a lot of conjectures that there might exist some extra degrees of freedom beyond the SM — the light sterile neutrinos as the simplest solutions to those “anomalies”. In other words, the anomalies are presumably ascribed to the active-sterile neutrino mixing and active-to-sterile flavor oscillations. Given the fact that a new wave of experimental endeavors are underway to confirm or exclude the relevant anomalies [671], here let us briefly review the experimental status and phenomenological studies in this respect.

---

<sup>32</sup>In this connection another potential background is the electron events produced by the scattering of low-energy solar  $pp$  neutrinos with electrons in the target atoms [668], but it should be suppressed by improving the energy resolution of a realistic experiment of this kind.



The first anomaly of this kind is the observation of an unexpected excess of the  $\bar{\nu}_e$ -like events in a very pure  $\bar{\nu}_\mu$  beam (produced from the decay mode  $\mu^+ \rightarrow e^+ + \nu_e + \bar{\nu}_\mu$ ) by the Liquid Scintillator Neutrino Detector (LSND) in a 30-meter short-baseline accelerator antineutrino experiment [672]. If such an excess is ascribed to  $\bar{\nu}_\mu \rightarrow \bar{\nu}_e$  oscillations, then an oscillation probability of  $(0.34^{+0.20}_{-0.18} \pm 0.07)\%$  can be obtained, although a different interpretation of the original measurement appeared from the very beginning [673]. A further measurement shows that the number of the observed excess events is  $87.9 \pm 22.4 \pm 6.0$ , about  $3.8\sigma$  over the background-only expectation [674, 675].

To clarify the LSND anomaly, the Mini Booster Neutrino Experiment (MiniBooNE) was designed to search for the signals of short-baseline  $\nu_\mu \rightarrow \nu_e$  and  $\bar{\nu}_\mu \rightarrow \bar{\nu}_e$  oscillations [676]. Although the baseline length of this experiment is eighteen times longer than that of the LSND experiment, both of them have the same  $L/E$  ratio and thus the same oscillation frequency. It turned out that an excess of the electron-like events was observed in the low-energy region via both neutrino and antineutrino modes, and the significance of such results has steadily increased [677, 678, 679]. The recent MiniBooNE result indicates an anomaly at the  $4.7\sigma$  significance level [675], which is more or less consistent with the LSND result.

It is impossible to interpret the LSND and MiniBooNE anomalies within the standard three-flavor neutrino oscillation framework, because the parameter space of this framework is already saturated in successfully accounting for those robust experimental results of solar, atmospheric, reactor and accelerator neutrino (or antineutrino) oscillations. That is why a light sterile neutrino species has typically been introduced to explain the above short-baseline anomalies via the active-to-sterile neutrino oscillations. In this case one may use the (3+1) active-sterile neutrino mixing matrix  $\mathcal{U}$  in Eq. (223) to calculate the probabilities of  $\nu_\mu \rightarrow \nu_e$  and  $\bar{\nu}_\mu \rightarrow \bar{\nu}_e$  oscillations and then confront them with the LSND and MiniBooNE results. The corresponding oscillation parameters are  $\Delta m_{41}^2 \equiv m_4^2 - m_1^2$ ,  $|\mathcal{U}_{e4}|^2 = \sin^2 \theta_{14}$  and  $|\mathcal{U}_{\mu 4}|^2 = \cos^2 \theta_{14} \sin^2 \theta_{24} \simeq \sin^2 \theta_{24}$ , and their magnitudes are expected to be  $\Delta m_{41}^2 \sim \mathcal{O}(1) \text{ eV}^2$  and  $\sin^2 \theta_{14} \sim \sin^2 \theta_{24} \lesssim \mathcal{O}(10^{-2})$  [671].

The so-called gallium anomaly is another well known example which has motivated the conjecture of a light sterile neutrino species. It means a deficit of about 15% regarding the ratio of the measured-to-predicted neutrino-induced signal rates in the radiochemical solar neutrino experiments GALLEX [680] and SAGE [681] with  $^{71}\text{Ga}$  being the target nuclei. The significance of such an anomaly is at the  $3\sigma$  level [682, 683], and it can be interpreted as a consequence of  $\nu_e \rightarrow \nu_e$  oscillations in the (3+1) active-sterile neutrino mixing scheme with  $\Delta m_{41}^2 \sim \mathcal{O}(1) \text{ eV}^2$  and  $\sin^2 \theta_{14} \sim \mathcal{O}(10^{-2})$  to  $\mathcal{O}(10^{-1})$  being the dominant oscillation parameters [684].

The reactor antineutrino anomaly has also provided some hints at the possible existence of a light sterile neutrino species in the eV mass range and with an active-sterile flavor mixing factor  $\sin^2 2\theta_{14} \sim \mathcal{O}(0.1)$  [685]. It originated from a 6% deficit of the observed reactor  $\bar{\nu}_e$  events as compared with the recalculated reactor antineutrino flux of four main fission isotopes  $^{235}\text{U}$ ,  $^{238}\text{U}$ ,  $^{239}\text{Pu}$  and  $^{241}\text{Pu}$  [686, 687]<sup>33</sup>, with a significance of about  $3\sigma$ . But it is worth pointing out that the recent Daya Bay measurement has convincingly rejected both the hypothesis of a constant  $\bar{\nu}_e$  flux as a function of the  $^{239}\text{Pu}$  fission fraction and the hypothesis of a constant  $\bar{\nu}_e$  energy spectrum, indicating that  $^{235}\text{U}$  may be the primary contributor to the reactor antineutrino anomaly [690]. In

---

<sup>33</sup>Such updated calculations were based on some more complicated *ab initio* methods and gave rise to a slightly larger prediction for the  $\bar{\nu}_e$  flux than the previous one [688, 689].

this situation whether the active-to-sterile antineutrino oscillations remain a reasonable solution to the anomaly is open to question [691, 692].

Note that there is also a so-called “shape anomaly” in the reactor antineutrino spectrum, referring to a bump structure or an excess in the observed  $\bar{\nu}_e$  spectrum as compared with the predicted shape around 5 MeV [693, 694, 695]. Since this anomaly is not only measured by both the near and far detectors but also correlated with the reactor power, it is very hard to interpret it with the help of the active-to-sterile antineutrino oscillations. Instead, such an anomalous shape of the  $\bar{\nu}_e$  spectrum casts some doubt on the reliability of our current calculations of the reactor antineutrino flux and spectrum [696, 697, 698, 699].

Today a number of short-baseline reactor antineutrino experiments (e.g., NEOS [700], DANSS [701], STEREO [702], PROSPECT [703], Neutrino-4 [704] and SoLid [705]) are underway towards verifying or disproving the light sterile neutrino hypothesis. Although it seems possible to interpret the aforementioned LSND, MiniBooNE, Gallium and reactor antineutrino anomalies in the (3+1) active-sterile (anti)neutrino mixing scenario with  $m_4 \sim \mathcal{O}(1)$  eV and  $\sin^2 \theta_{14} \sim \sin^2 \theta_{24} \sim \mathcal{O}(10^{-2})$ , a careful global analysis has recently shown a tension between the data from appearance and disappearance experiments at the  $4.7\sigma$  level [706]. In addition, the existence of such a light thermalized sterile neutrino species is strongly disfavored by the Planck data on the cosmological side [105]. In particular, the Planck constraints on the sum of all the light neutrino masses and the effective extra relativistic degrees of freedom almost leave no room for a hypothetical eV-scale sterile neutrino species of this kind.

#### 5.4.2. Some possible phenomenological consequences

Given a light sterile antineutrino species which takes part in  $\bar{\nu}_e \rightarrow \bar{\nu}_e$  oscillations in a reactor antineutrino experiment, the corresponding disappearance oscillation probability can be obtained by extending the standard three-flavor oscillation formula in Eq. (90) as follows [350]:

$$\begin{aligned}
P(\bar{\nu}_e \rightarrow \bar{\nu}_e) = & 1 - \cos^4 \theta_{14} \left[ \sin^2 2\theta_{12} \cos^4 \theta_{13} \sin^2 \frac{\Delta m_{21}^2 L}{4E} + \frac{1}{2} \sin^2 2\theta_{13} \left( \sin^2 \frac{\Delta m_{31}^2 L}{4E} + \sin^2 \frac{\Delta m_{32}^2 L}{4E} \right) \right. \\
& \left. + \frac{1}{2} \cos 2\theta_{12} \sin^2 2\theta_{13} \sin \frac{\Delta m_{21}^2 L}{4E} \sin \frac{(\Delta m_{31}^2 + \Delta m_{32}^2) L}{4E} \right] \\
& - \sin^2 2\theta_{14} \left[ \sin^2 \theta_{13} \sin^2 \frac{\Delta m_{43}^2 L}{4E} + \frac{1}{2} \cos^2 \theta_{13} \left( \sin^2 \frac{\Delta m_{41}^2 L}{4E} + \sin^2 \frac{\Delta m_{42}^2 L}{4E} \right) \right. \\
& \left. + \frac{1}{2} \cos 2\theta_{12} \cos^2 \theta_{13} \sin \frac{\Delta m_{21}^2 L}{4E} \sin \frac{(\Delta m_{41}^2 + \Delta m_{42}^2) L}{4E} \right], \tag{241}
\end{aligned}$$

where the parametrization of the  $4 \times 4$  active-sterile neutrino mixing matrix in Eq. (223) has been adopted. It is clear that switching off  $\theta_{14}$  will allow Eq. (241) to reproduce the standard result shown in Eq. (90). Let us make some immediate comments on the new oscillatory terms. First, the oscillatory term driven by  $\Delta m_{43}^2$  is doubly suppressed by the small flavor mixing factors  $\sin^2 \theta_{13}$  and  $\sin^2 2\theta_{14}$ , and hence it should not play any important role in most cases, no matter how large or small the magnitude of  $\Delta m_{43}^2$  is. Second, a sum of the three oscillatory terms driven by

$\Delta m_{41}^2 \simeq \Delta m_{42}^2 \simeq \Delta m_{43}^2 \sim \mathcal{O}(1) \text{ eV}^2$  has been extensively assumed to explain the reactor antineutrino anomaly, as discussed above. Third, the new interference term in Eq. (241) is proportional to the product of  $\sin^2 2\theta_{14}$ ,  $\cos 2\theta_{12}$ ,  $\cos^2 \theta_{13}$ ,  $\sin[\Delta m_{21}^2 L/(4E)]$  and  $\sin[(\Delta m_{41}^2 + \Delta m_{42}^2)L/(4E)]$ , which is apparently sensitive to the sign of  $\Delta m_{41}^2 + \Delta m_{42}^2$ . Unless the value of  $m_4$  is in between those of  $m_1$  and  $m_2$ , the mass-squared differences  $\Delta m_{41}^2$  and  $\Delta m_{42}^2$  must have the same sign. If the standard and new interference terms are put together, namely

$$\begin{aligned} \text{Interference terms} = & \frac{1}{2} \cos 2\theta_{12} \sin \frac{\Delta m_{21}^2 L}{4E} \left[ \sin^2 2\theta_{13} \cos^4 \theta_{14} \sin \frac{(\Delta m_{31}^2 + \Delta m_{32}^2)L}{4E} \right. \\ & \left. + \cos^2 \theta_{13} \sin^2 2\theta_{14} \sin \frac{(\Delta m_{41}^2 + \Delta m_{42}^2)L}{4E} \right], \end{aligned} \quad (242)$$

then whether the latter may contaminate the former will be a concern for the upcoming JUNO experiment [350]. Such a concern certainly depends on the possible values of  $\theta_{14}$ ,  $\Delta m_{41}^2$  and  $\Delta m_{42}^2$ . Finally, it should be kept in mind that the probabilities of (anti)neutrino oscillations are invariant under the transformations  $\theta_{12} \rightarrow \theta_{12} - \pi/2$  and  $m_1 \leftrightarrow m_2$  [707], as one can see in Eqs. (90) and (242). That is why it looks quite natural for the interference terms to be proportional to the product of  $\cos 2\theta_{12}$  and  $\sin[\Delta m_{21}^2 L/(4E)]$ , which both change their signs under  $\theta_{12} \rightarrow \theta_{12} - \pi/2$  and  $m_1 \leftrightarrow m_2$ . As a consequence, the interference effects would vanish if  $\theta_{12} = \pi/4$  held.

Of course, the existence of one or more light sterile (anti)neutrino species will also affect the ‘‘appearance-type’’ (anti)neutrino oscillations, such as  $\nu_\mu \rightarrow \nu_e$  and  $\bar{\nu}_\mu \rightarrow \bar{\nu}_e$  oscillations [708, 709, 710]. In this connection the phenomenology can be very rich, including new CP-violating effects and neutral-current-associated matter effects.

Moreover, both the effective electron-neutrino mass of the  $\beta$  decays and that of the  $0\nu 2\beta$  decays will be modified in the presence of such new degrees of freedom if they slightly mix with the active neutrinos. In the (3+1) active-sterile neutrino mixing scheme, for example, one obtains

$$\langle m \rangle'_e = \sqrt{(m_1^2 \cos^2 \theta_{12} \cos^2 \theta_{13} + m_2^2 \sin^2 \theta_{12} \cos^2 \theta_{13} + m_3^2 \sin^2 \theta_{13}) \cos^2 \theta_{14} + m_4^2 \sin^2 \theta_{14}}, \quad (243)$$

and

$$\begin{aligned} \langle m \rangle'_{ee} = & \left[ m_1 \cos^2 \theta_{12} \cos^2 \theta_{13} \exp(i\phi_{e1}) + m_2 \sin^2 \theta_{12} \cos^2 \theta_{13} + m_3 \sin^2 \theta_{13} \exp(i\phi_{e3}) \right] \cos^2 \theta_{14} \\ & + m_4 \sin^2 \theta_{14} \exp(i\phi_{e4}), \end{aligned} \quad (244)$$

where the three phase parameters  $\phi_{e1}$ ,  $\phi_{e3}$  and  $\phi_{e4}$  are all allowed to vary in the  $[0, 2\pi)$  range. Switching off the mixing angle  $\theta_{14}$  will reduce Eqs. (243) and (244) to the standard three-flavor expressions  $\langle m \rangle_e$  and  $\langle m \rangle_{ee}$  in Eqs. (92) and (93), respectively. It is obvious that  $\langle m \rangle'_e \geq \langle m \rangle_e$  always holds, but it is difficult to compare between the magnitudes of  $\langle m \rangle_{ee}$  and  $\langle m \rangle'_{ee}$  because the CP-violating phases are likely to cause significant cancellations among their respective components. The extreme case is either  $\langle m \rangle_{ee} \rightarrow 0$  [388, 389, 390] or  $\langle m \rangle'_{ee} \rightarrow 0$  [711, 712, 713] (see section 7.2.1 for a detailed discussion about the parameter space of  $\langle m \rangle_{ee} \rightarrow 0$ ).

For the time being one has to admit that the conjecture of any light sterile (anti)neutrino species is primarily motivated by some experimental anomalies at the phenomenological level and lacks

a convincing theoretical motivation. In other words, it remains unclear why such light and sterile degrees of freedom should exist in nature and what place they could find in a more fundamental flavor theory and (or) in the evolution of our Universe.

## 6. Possible Yukawa textures of quark flavors

### 6.1. Quark flavor mixing in the quark mass limits

#### 6.1.1. Quark mass matrices in two extreme cases

As outlined in section 1.2, the flavor puzzles in the quark sector include why the mass spectra of up- and down-type quarks are strongly hierarchical (i.e.,  $m_u \ll m_c \ll m_t$  and  $m_d \ll m_s \ll m_b$ ) at a given energy scale; why the six off-diagonal elements of the CKM quark flavor mixing matrix  $V$  are strongly suppressed in magnitude, implying the smallness of three flavor mixing angles; and how the origin of CP violation is correlated with the generation of quark masses. In the lack of a complete flavor theory capable of predicting the flavor structures of six quarks, it is certainly hard to answer the above questions. On the one hand, some great ideas like grand unifications, supersymmetries and extra dimensions are not powerful enough to solve the observed flavor puzzles; on the other hand, the exercises of various group languages or flavor symmetries turn out to be too divergent to converge to something unique [275].

Without invoking a specific quark mass model, we emphasize that it is actually possible to follow a purely phenomenological way to understand some salient features of quark flavor mixing based on the quark mass hierarchies. The key point is that the CKM matrix  $V = O_u^\dagger O_d$  depends on the quark mass matrices  $M_u$  and  $M_d$  via the unitary matrices  $O_u$  and  $O_d$ , simply because of  $O_u^\dagger M_u M_u^\dagger O_u = D_u^2 = \text{Diag}\{m_u^2, m_c^2, m_t^2\}$  and  $O_d^\dagger M_d M_d^\dagger O_d = D_d^2 = \text{Diag}\{m_d^2, m_s^2, m_b^2\}$  as shown in Eq. (6) or Eq. (8). Then the off-diagonal elements of  $V$  are expected to be certain simple functions of the quark mass ratios and some extra dimensionless variables (e.g., the phase parameters responsible for CP violation) [449], which should be sensitive to the limits  $m_u \rightarrow 0$  and  $m_d \rightarrow 0$  or the limits  $m_t \rightarrow \infty$  and  $m_b \rightarrow \infty$ . Such a starting point of view is analogous to two well-known working symmetries in the effective field theories of QCD [714]: the chiral quark symmetry (i.e.,  $m_u, m_d, m_s \rightarrow 0$ ) and the heavy quark symmetry (i.e.,  $m_c, m_b, m_t \rightarrow \infty$ ). The reason for the usefulness of these two symmetries is that masses of the light quarks are far below the QCD scale  $\Lambda_{\text{QCD}} \sim 0.2 \text{ GeV}$ , whereas masses of the heavy quarks are far above it. In calculating the elements of  $V$  from  $M_u$  and  $M_d$ , we find that the mass limits corresponding to the chiral and heavy quark symmetries are equivalent to setting the relevant mass ratios to zero. Such a treatment may help understand the observed pattern of  $V$  in a simple way, and some preliminary attempts have been made along this line of thought [288, 479, 550, 715, 716].

Note that the quark mass limit  $m_u \rightarrow 0$  (or  $m_d \rightarrow 0$ ) does not point to a unique texture of  $M_u$  (or  $M_d$ ) in general, because the form of a quark mass matrix is always basis-dependent. Without loss of generality, one may always choose a particular flavor basis such that the Hermitian matrices  $M_u M_u^\dagger$  and  $M_d M_d^\dagger$  in the respective  $m_u \rightarrow 0$  and  $m_d \rightarrow 0$  limits can be written as

$$\lim_{m_u \rightarrow 0} M_u M_u^\dagger = \begin{pmatrix} 0 & 0 & 0 \\ 0 & \wedge_u & \heartsuit_u \\ 0 & \heartsuit_u^* & \Delta_u \end{pmatrix}, \quad \lim_{m_d \rightarrow 0} M_d M_d^\dagger = \begin{pmatrix} 0 & 0 & 0 \\ 0 & \wedge_d & \heartsuit_d \\ 0 & \heartsuit_d^* & \Delta_d \end{pmatrix}, \quad (245)$$

in which the symbols denote the nonzero elements. On the other hand, we argue that a given quark will become decoupled from other quarks if its mass goes to infinity. In this case it is possible to choose a proper flavor basis such that  $M_u M_u^\dagger$  and  $M_d M_d^\dagger$  can be expressed as

$$\lim_{m_t \rightarrow \infty} M_u M_u^\dagger = \begin{pmatrix} \times_u & \nabla_u & 0 \\ \nabla_u^* & \vee_u & 0 \\ 0 & 0 & \infty \end{pmatrix}, \quad \lim_{m_b \rightarrow \infty} M_d M_d^\dagger = \begin{pmatrix} \times_d & \nabla_d & 0 \\ \nabla_d^* & \vee_d & 0 \\ 0 & 0 & \infty \end{pmatrix}. \quad (246)$$

In other words, the  $3 \times 3$  Hermitian matrix  $M_u M_u^\dagger$  (or  $M_d M_d^\dagger$ ) can be simplified to an effective  $2 \times 2$  Hermitian matrix in either the chiral quark mass limit or the heavy quark mass limit. This observation is certainly consistent with the fact of  $m_u \ll m_c \ll m_t$  and  $m_d \ll m_s \ll m_b$  at an arbitrary energy scale [90, 91], and it provides a possibility of explaining some of the properties of quark flavor mixing in no need of going into details of  $M_u$  and  $M_d$ .

### 6.1.2. Some salient features of the CKM matrix

Now let us try to understand some salient features of the CKM matrix  $V = O_u^\dagger O_d$  shown in Table 8 and Eq. (79) by taking the chiral and heavy quark mass limits. To be more specific, we write out the nine elements of  $V$  as follows:

$$V_{\alpha i} = (O_u^*)_{1\alpha} (O_d)_{1i} + (O_u^*)_{2\alpha} (O_d)_{2i} + (O_u^*)_{3\alpha} (O_d)_{3i}, \quad (247)$$

where  $\alpha$  and  $i$  run over the flavor indices  $(u, c, t)$  and  $(d, s, b)$ , respectively. Then we are able to phenomenologically interpret why  $|V_{us}| \simeq |V_{cd}|$  and  $|V_{cb}| \simeq |V_{ts}|$  hold to an excellent degree of accuracy, why  $|V_{cd}/V_{td}| \simeq |V_{cs}/V_{ts}| \simeq |V_{tb}/V_{cb}|$  is a reasonable approximation, and why  $|V_{ub}/V_{cb}|$  is much smaller than  $|V_{td}/V_{ts}|$  with the help of Eqs. (245) and (246).

(1) In the  $m_t \rightarrow \infty$  and  $m_b \rightarrow \infty$  limits, the matrices  $M_u M_u^\dagger$  and  $M_d M_d^\dagger$  are of the form given in Eq. (246). The corresponding unitary matrices used to diagonalize them can be expressed as

$$\lim_{m_t \rightarrow \infty} O_u = \begin{pmatrix} c_{12} & \hat{s}_{12}^* & 0 \\ -\hat{s}_{12} & c_{12} & 0 \\ 0 & 0 & 1 \end{pmatrix}, \quad \lim_{m_b \rightarrow \infty} O_d = \begin{pmatrix} c'_{12} & \hat{s}'_{12} & 0 \\ -\hat{s}'_{12} & c'_{12} & 0 \\ 0 & 0 & 1 \end{pmatrix}, \quad (248)$$

where  $c_{12}^{(\prime)} \equiv \cos \psi_{12}^{(\prime)}$  and  $\hat{s}_{12}^{(\prime)} \equiv e^{i\delta_{12}^{(\prime)}} \sin \psi_{12}^{(\prime)}$  are defined in a way similar to Eq. (205a). So we are left with the equality  $V_{cd} = -V_{us}^* = s_{12} c'_{12} e^{i\delta_{12}} - c_{12} s'_{12} e^{i\delta'_{12}}$ , which is perfectly consistent with the experimental result  $|V_{cd}| \simeq |V_{us}|$ . In other words, the approximate relation  $|V_{us}| \simeq |V_{cd}|$  is a natural consequence of  $m_t \gg m_c \gg m_u$  and  $m_b \gg m_s \gg m_d$  [550]. When the  $m_u \rightarrow 0$  and  $m_d \rightarrow 0$  limits are taken as in Eq. (245), the unitary matrices used to diagonalize  $M_u M_u^\dagger$  and  $M_d M_d^\dagger$  can be respectively written as

$$\lim_{m_u \rightarrow 0} O_u = \begin{pmatrix} 1 & 0 & 0 \\ 0 & c_{23} & \hat{s}_{23}^* \\ 0 & -\hat{s}_{23} & c_{23} \end{pmatrix}, \quad \lim_{m_d \rightarrow 0} O_d = \begin{pmatrix} 1 & 0 & 0 \\ 0 & c'_{23} & \hat{s}'_{23} \\ 0 & -\hat{s}'_{23} & c'_{23} \end{pmatrix}, \quad (249)$$

where  $c_{23}^{(\prime)} \equiv \cos \psi_{23}^{(\prime)}$  and  $\hat{s}_{23}^{(\prime)} \equiv e^{i\delta_{23}^{(\prime)}} \sin \psi_{23}^{(\prime)}$ . Then we obtain  $V_{ts} = -V_{cb}^* = s_{23} c'_{23} e^{i\delta_{23}} - c_{23} s'_{23} e^{i\delta'_{23}}$ , which is in very good agreement with the experimental result  $|V_{cb}| \simeq |V_{ts}|$ . That is to say, the

approximate equality  $|V_{cb}| \simeq |V_{ts}|$  can naturally be attributed to the strong quark mass hierarchies  $m_u \ll m_c \ll m_t$  and  $m_d \ll m_s \ll m_b$ .

(2) The numerical results listed in Table 8 tell us that  $|V_{td}/V_{cd}| \simeq 0.040$ ,  $|V_{ts}/V_{cs}| \simeq 0.042$  and  $|V_{cb}/V_{tb}| \simeq 0.042$ , implying  $|V_{td}/V_{cd}| \simeq |V_{ts}/V_{cs}| \simeq |V_{cb}/V_{tb}|$  as a very good approximation. We find that such an interesting relation holds exactly if the quark mass limits  $m_u \rightarrow 0$  and  $m_b \rightarrow \infty$  are combined together. To be explicit,

$$V = \lim_{m_u \rightarrow 0} O_u^\dagger \lim_{m_b \rightarrow \infty} O_d = \begin{pmatrix} c'_{12} & \hat{s}'_{12} & 0 \\ -c'_{23} \hat{s}'_{12} & c'_{23} c'_{12} & -\hat{s}'_{23} \\ -\hat{s}'_{23} \hat{s}'_{12} & \hat{s}'_{23} c'_{12} & c'_{23} \end{pmatrix}, \quad (250)$$

with the help of Eqs. (248) and (249). We are therefore left with  $|V_{td}/V_{cd}| = |V_{ts}/V_{cs}| = |V_{cb}/V_{tb}| = \tan \psi_{23}$  with  $\psi_{23}$  being in the first quadrant. Eq. (250) also indicates that  $V_{ub}$  should be the smallest CKM matrix element. These simple observations are well consistent with current experimental data, especially when  $\psi_{23} \simeq 2.35^\circ$  is input. But it should be noted that a combination of the limits  $m_t \rightarrow \infty$  and  $m_d \rightarrow 0$  is less favored from a phenomenological point of view, because such a treatment will predict both  $|V_{td}| = 0$  and  $|V_{ub}/V_{us}| = |V_{cb}/V_{cs}| = |V_{ts}/V_{tb}|$ , which are essentially in conflict with Table 8 and Eq. (79). In particular, the limit  $|V_{ub}| \rightarrow 0$  is apparently much closer to reality than the limit  $|V_{td}| \rightarrow 0$ .

(3) Although the CKM matrix  $V$  is nearly symmetric about its  $V_{ud}$ - $V_{cs}$ - $V_{tb}$  axis, the fact that the ratio  $|V_{td}/V_{ts}|$  is about 2.5 times larger than  $|V_{ub}/V_{cb}|$  needs an explanation. With the help of Eqs. (246)—(248), we immediately obtain

$$\lim_{m_b \rightarrow \infty} \left| \frac{V_{ub}}{V_{cb}} \right| = \left| \frac{(O_u)_{3u}}{(O_u)_{3c}} \right|, \quad \lim_{m_t \rightarrow \infty} \left| \frac{V_{td}}{V_{ts}} \right| = \left| \frac{(O_d)_{3d}}{(O_d)_{3s}} \right|, \quad (251)$$

in the  $m_b \rightarrow \infty$  and  $m_t \rightarrow \infty$  limits, respectively. This result is rather nontrivial in the sense that  $|V_{ub}/V_{cb}|$  turns out to be independent of the down-quark sector in the  $m_b \rightarrow \infty$  limit, while  $|V_{td}/V_{ts}|$  has nothing to do with the up-quark sector in the  $m_t \rightarrow \infty$  limit [275, 550]. The flavor indices appearing on the right-hand side of Eq. (251) are especially suggestive:  $|V_{ub}/V_{cb}|$  is associated with the  $u$  and  $c$  quarks, and  $|V_{td}/V_{ts}|$  is dependent on the  $d$  and  $s$  quarks. One is therefore motivated to speculate that these two CKM modulus ratios should be two simple functions of the quark mass ratios  $m_u/m_c$  and  $m_d/m_s$ , respectively, in the  $m_b \rightarrow \infty$  and  $m_t \rightarrow \infty$  limits. Given  $|V_{ub}/V_{cb}| \simeq 0.087$  and  $|V_{td}/V_{ts}| \simeq 0.22$  from Table 8, as compared with  $\sqrt{m_u/m_c} \simeq \lambda^2 \simeq 0.048$  and  $\sqrt{m_d/m_s} \simeq \lambda \simeq 0.22$  from Table 7, it is reasonable to make the conjectures

$$\lim_{m_b \rightarrow \infty} \left| \frac{V_{ub}}{V_{cb}} \right| \simeq c_1 \sqrt{\frac{m_u}{m_c}}, \quad \lim_{m_t \rightarrow \infty} \left| \frac{V_{td}}{V_{ts}} \right| \simeq c_2 \sqrt{\frac{m_d}{m_s}}, \quad (252)$$

where  $c_1$  and  $c_2$  are the  $O(1)$  coefficients. Eq. (252) is certainly consistent with the well-known Fritzsch texture of quark mass matrices [135, 136] and some of its variations [479, 509, 717, 718].

Here it makes sense to compare the relations in Eq. (252) with those in Eq. (136), which are based on a particular parametrization of  $V$  advocated in Eq. (135). Since  $m_d > m_u$  but  $m_s < m_c$ , the inequality  $|V_{ub}/V_{cb}| < |V_{td}/V_{ts}|$  is therefore a natural consequence of the strong quark mass hierarchies. But such an argument and the conjectures made above are purely phenomenological and hardly distinguishable from many other interesting ideas of this kind from an experimental perspective, and hence it remains unclear whether they can find a good theoretical reason or not.

## 6.2. Quark flavor democracy and its breaking effects

### 6.2.1. $S_3$ and $S_{3L} \times S_{3R}$ flavor symmetry limits

The SM is unsatisfactory in the flavor sector because the flavor structures of leptons and quarks are completely undetermined. That is why this powerful theory has no predictive power for both the values of fermion masses and those of flavor mixing parameters. To change this unfortunate situation, one has to find a way out by reducing the number of free flavor parameters and thus enhancing the predictability and testability of the SM itself or its reasonable extensions. In this regard proper flavor symmetries are expected to be very helpful in determining the flavor structures and explaining current experimental data. One of the simplest flavor groups used to account for the observed patterns of the CKM quark mixing matrix is the non-Abelian  $S_3$  group [132, 133] — a permutation group of three objects which contains six elements [719, 720, 721]

$$\begin{aligned} S^{(123)} &= \begin{pmatrix} 1 & 0 & 0 \\ 0 & 1 & 0 \\ 0 & 0 & 1 \end{pmatrix}, & S^{(231)} &= \begin{pmatrix} 0 & 1 & 0 \\ 0 & 0 & 1 \\ 1 & 0 & 0 \end{pmatrix}, & S^{(312)} &= \begin{pmatrix} 0 & 0 & 1 \\ 1 & 0 & 0 \\ 0 & 1 & 0 \end{pmatrix}, \\ S^{(213)} &= \begin{pmatrix} 0 & 1 & 0 \\ 1 & 0 & 0 \\ 0 & 0 & 1 \end{pmatrix}, & S^{(132)} &= \begin{pmatrix} 1 & 0 & 0 \\ 0 & 0 & 1 \\ 0 & 1 & 0 \end{pmatrix}, & S^{(321)} &= \begin{pmatrix} 0 & 0 & 1 \\ 0 & 1 & 0 \\ 1 & 0 & 0 \end{pmatrix}. \end{aligned} \quad (253)$$

These six group elements can be categorized into three conjugacy classes:  $C_0 = \{S^{(123)}\}$ ,  $C_1 = \{S^{(231)}, S^{(312)}\}$  and  $C_2 = \{S^{(213)}, S^{(132)}, S^{(321)}\}$ . Moreover,  $S_3$  has one subgroup of order three,  $Z_3 = \{S^{(123)}, S^{(231)}, S^{(312)}\}$ , together with three subgroups of order two,  $Z_2^{(12)} = \{S^{(123)}, S^{(213)}\}$ ,  $Z_2^{(23)} = \{S^{(123)}, S^{(132)}\}$  and  $Z_2^{(31)} = \{S^{(123)}, S^{(321)}\}$  [722].

Given the kinetic term  $\mathcal{L}_F$  and the Yukawa interaction term  $\mathcal{L}_Y$  of the SM fermions in Eq. (3), together with the Dirac neutrino Yukawa coupling term in Eq. (12), one may require the relevant left- and right-handed fermion fields to transform as  $Q_L \rightarrow S^{(ijk)}Q_L$ ,  $\ell_L \rightarrow S^{(ijk)}\ell_L$ ,  $U_R \rightarrow S^{(lmn)}U_R$ ,  $D_R \rightarrow S^{(lmn)}D_R$ ,  $E_R \rightarrow S^{(lmn)}E_R$  and  $N_R \rightarrow S^{(lmn)}N_R$ , where  $S^{(ijk)}$  and  $S^{(lmn)}$  (for  $i \neq j \neq k = 1, 2, 3$  and  $l \neq m \neq n = 1, 2, 3$ ) can be either identical or different. Then it is easy to see that both  $\mathcal{L}_F$  and the extra  $\overline{N}_R i \not{\partial} N_R$  term are automatically invariant under the above transformations, and  $\mathcal{L}_Y$  is also invariant under the same transformations if the corresponding Yukawa coupling matrices satisfy the conditions  $S^{(ijk)}Y_f = Y_f S^{(lmn)}$  (for  $f = u, d, l$  or  $\nu$ ). After spontaneous gauge symmetry breaking, the resulting fermion mass matrices similarly satisfy

$$S^{(ijk)}M_x = M_x S^{(lmn)}, \quad (254)$$

where the subscript “ $x$ ” runs over  $u, d, l$  or  $D$ . Then we are left with only two possible textures of these four mass matrices:

$$S^{(ijk)} = S^{(lmn)} \longrightarrow M_x = a_x \begin{pmatrix} 1 & 1 & 1 \\ 1 & 1 & 1 \\ 1 & 1 & 1 \end{pmatrix} + b_x \begin{pmatrix} 1 & 0 & 0 \\ 0 & 1 & 0 \\ 0 & 0 & 1 \end{pmatrix}; \quad (255a)$$

$$S^{(ijk)} \neq S^{(lmn)} \longrightarrow M_x = a_x \begin{pmatrix} 1 & 1 & 1 \\ 1 & 1 & 1 \\ 1 & 1 & 1 \end{pmatrix}, \quad (255b)$$

where the democratic matrix is identical with either a sum of  $S^{(123)}$ ,  $S^{(231)}$  and  $S^{(312)}$  or a sum of  $S^{(213)}$ ,  $S^{(132)}$  and  $S^{(321)}$ , the identity matrix is equal to  $S^{(123)}$ , and the coefficients  $a_x$  and  $b_x$  govern the mass scales of  $M_x$ . Since the left- and right-handed fields of a Dirac fermion are *a priori* unrelated to each other, it is natural to take  $S^{(ijk)} \neq S^{(lmn)}$  when making the above  $S_3$  transformations. We therefore expect that the Dirac fermion mass matrix in Eq. (254) should exhibit an  $S_{3L} \times S_{3R}$  symmetry [132, 133], or equivalently the flavor democracy [137].

If massive neutrinos are of the Majorana nature and their mass term is described by Eq. (16), then their left- and right-handed fields must be correlated with each other and hence the corresponding neutrino mass matrix  $M_\nu$  under  $S_3$  symmetry is expected to contain both the flavor democracy term and the identity matrix term — the  $S^{(ijk)} = S^{(lmn)}$  case as shown in Eq. (255b) [723, 724, 725]. Namely,  $M_\nu$  is of the form

$$M_\nu = a_\nu \begin{pmatrix} 1 & 1 & 1 \\ 1 & 1 & 1 \\ 1 & 1 & 1 \end{pmatrix} + b_\nu \begin{pmatrix} 1 & 0 & 0 \\ 0 & 1 & 0 \\ 0 & 0 & 1 \end{pmatrix}, \quad (256)$$

in the  $S_3$  flavor symmetry limit. In the assumption of  $a_\nu = 0$  [138, 139, 726, 727] or  $|a_\nu| \ll |b_\nu|$  [721, 723, 724, 725], one may combine the texture of  $M_\nu$  in Eq. (256) and that of  $M_l$  in Eq. (66) or Eq. (255b) to arrive at a constant lepton flavor mixing matrix as the one given in Eq. (104), and stabilize this “democratic” flavor mixing pattern by introducing proper perturbations to the  $S_{3L} \times S_{3R}$  symmetry. This kind of explicit symmetry breaking is also expected to generate nonzero values of the smallest flavor mixing angle and CP-violating phases [138]. Alternatively, one may obtain the “tribimaximal” neutrino mixing matrix in Eq. (106) from  $M_\nu$  in Eq. (256) by assuming the charged-lepton mass matrix  $M_l$  to be diagonal, and stabilize such an interesting flavor mixing pattern by breaking the  $S_3$  flavor symmetry of  $M_\nu$  [719, 720].

As pointed out in Eqs. (66), (73) and (74), the flavor democracy or  $S_{3L} \times S_{3R}$  symmetry is a good starting point of view to understand the strong mass hierarchies of charged leptons, up-type quarks and down-type quarks. Given the structural parallelism between  $M_u$  and  $M_d$ , which is presumably expected to be true if the two quark sectors share the same flavor dynamics, the CKM matrix  $V$  must be the identity matrix in the  $S_{3L} \times S_{3R}$  symmetry limit. In other words,  $V = O_*^T O_* = I$  holds when both  $M_u$  and  $M_d$  are of the democratic form as shown in Eq. (74), where the orthogonal matrix  $O_*$  used to diagonalize these two special mass matrices has been given in Eq. (67). The small quark flavor mixing angles and CP-violating effects are therefore a consequence of proper flavor democracy breaking in the two quark sectors [137].

A purely phenomenological extension of the aforementioned flavor democracy hypothesis is the so-called “universal Yukawa coupling strength” scenario [728, 729, 730, 731] — a conjecture that all the Yukawa coupling matrix elements of leptons and quarks have the identical moduli but their phases are in general different:

$$Y_x \propto \begin{pmatrix} \exp(i\phi_{11}^x) & \exp(i\phi_{12}^x) & \exp(i\phi_{13}^x) \\ \exp(i\phi_{21}^x) & \exp(i\phi_{22}^x) & \exp(i\phi_{23}^x) \\ \exp(i\phi_{31}^x) & \exp(i\phi_{32}^x) & \exp(i\phi_{33}^x) \end{pmatrix}, \quad (257)$$

where the flavor index  $x$  runs over u, d,  $l$  or  $D$  for the up-type quark, down-type quarks, charged leptons or Dirac neutrinos. Some of the phase parameters in Eq. (257) can be rotated away by



redefining phases of the right-handed fermion fields. A further simplification of  $Y_x$  is also possible by taking some phase parameters to be vanishing. Note that the nonzero phases of  $Y_x$  can be regarded as a source of flavor democracy breaking, and thus they should also be responsible for the origin of CP violation in weak charged-current interactions. To account for current experimental data about fermion mass spectra and flavor mixing patterns, however, a careful arrangement of the relevant phase parameters has to be made.

### 6.2.2. Breaking of the quark flavor democracy

Starting from the flavor democracy limit under discussion, one may in principle follow the symmetry breaking steps  $S_{3L} \times S_{3R} \rightarrow S_{2L} \times S_{2R} \rightarrow S_{1L} \times S_{1R}$  or simply  $S_{3L} \times S_{3R} \rightarrow S_{1L} \times S_{1R}$  to generate masses of the second- and first-family quarks. Flavor mixing and CP violation are also expected to show up after implementing such a spontaneous or explicit symmetry breaking chain, but whether the latter is phenomenologically acceptable depends on whether the resulting CKM matrix and quark mass spectrum are compatible with current experimental data.

To illustrate, we consider a simple two-Higgs-doublet extension of the SM in its quark sector:

$$-\mathcal{L}_{\text{quark}} = \overline{Q}_L Y_u^{(0)} U_R \widetilde{H}_1 + \overline{Q}_L Y_d^{(0)} D_R H_1 + \overline{Q}_L Y_u^{(1)} U_R \widetilde{H}_2 + \overline{Q}_L Y_d^{(1)} D_R H_2 + \text{h.c.}, \quad (258)$$

which is invariant under the  $S_3$  transformations  $Q_L \rightarrow S^{(ijk)} Q_L$ ,  $U_R \rightarrow S^{(ijk)} U_R$  and  $D_R \rightarrow S^{(ijk)} D_R$  together with  $H_1 \rightarrow H_1$  and  $H_2 \rightarrow H_2$  (for  $S^{(123)}$ ,  $S^{(312)}$  and  $S^{(231)}$ ) or  $H_2 \rightarrow -H_2$  (for  $S^{(213)}$ ,  $S^{(132)}$  and  $S^{(321)}$ ), where the hypercharges of  $H_1$  and  $H_2$  are both  $+1/2$  [732]. In this case we are left with

$$Y_q^{(0)} = a_q \begin{pmatrix} 1 & 1 & 1 \\ 1 & 1 & 1 \\ 1 & 1 & 1 \end{pmatrix} + b_q \begin{pmatrix} 1 & 0 & 0 \\ 0 & 1 & 0 \\ 0 & 0 & 1 \end{pmatrix}, \quad Y_q^{(1)} = c_q \begin{pmatrix} 0 & 1 & -1 \\ -1 & 0 & 1 \\ 1 & -1 & 0 \end{pmatrix}, \quad (259)$$

where  $q = u$  or  $d$ . After the Higgs doublets  $H_1$  and  $H_2$  acquire their respective vacuum expectation values  $\langle H_1 \rangle \equiv \langle 0|H_1|0 \rangle = (0, v_1/\sqrt{2})^T$  and  $\langle H_2 \rangle \equiv \langle 0|H_2|0 \rangle = (0, v_2/\sqrt{2})^T e^{i\varrho}$  with  $\varrho$  being the relative phase between  $\langle H_1 \rangle$  and  $\langle H_2 \rangle$ , the  $SU(2)_L \times U(1)_Y \times S_3$  symmetry of  $\mathcal{L}_{\text{quark}}$  in Eq. (258) will be spontaneously broken. As a straightforward consequence,

$$M_q = \frac{v_1}{\sqrt{2}} \left[ a_q \begin{pmatrix} 1 & 1 & 1 \\ 1 & 1 & 1 \\ 1 & 1 & 1 \end{pmatrix} + b_q \begin{pmatrix} 1 & 0 & 0 \\ 0 & 1 & 0 \\ 0 & 0 & 1 \end{pmatrix} \right] + \frac{v_2}{\sqrt{2}} c_q e^{i\varrho} \begin{pmatrix} 0 & 1 & -1 \\ -1 & 0 & 1 \\ 1 & -1 & 0 \end{pmatrix}, \quad (260)$$

in which the term proportional to  $c_q \exp(i\varrho)$  is responsible for both  $S_3$  symmetry breaking and CP violation. Such a simple model has no way to fit current experimental data, and hence it is necessary to introduce more complicated symmetry breaking terms in an explicit way [732].

One of the empirically acceptable examples of explicit  $S_{3L} \times S_{3R}$  symmetry breaking is as follows [137, 550], although it is difficult to be realized from the model-building perspective:

$$M_u^{(D)} = \frac{C_u}{3} \left[ \begin{pmatrix} 1 & 1 & 1 \\ 1 & 1 & 1 \\ 1 & 1 & 1 \end{pmatrix} + \epsilon_u \begin{pmatrix} 0 & 0 & 1 \\ 0 & 0 & 1 \\ 1 & 1 & 1 \end{pmatrix} + \sigma_u \begin{pmatrix} 1 & 0 & -1 \\ 0 & -1 & 1 \\ -1 & 1 & 0 \end{pmatrix} \right], \quad (261a)$$

$$M_d^{(D)} = \frac{C_d}{3} \left[ \begin{pmatrix} 1 & 1 & 1 \\ 1 & 1 & 1 \\ 1 & 1 & 1 \end{pmatrix} + \epsilon_d \begin{pmatrix} 0 & 0 & 1 \\ 0 & 0 & 1 \\ 1 & 1 & 1 \end{pmatrix} + \sigma'_d \begin{pmatrix} 0 & 1 & -1 \\ -1 & 0 & 1 \\ 1 & -1 & 0 \end{pmatrix} \right], \quad (261b)$$

where  $\sigma'_d \equiv i\sigma_d$  is defined;  $\epsilon_q$  and  $\sigma_q$  (for  $q = u, d$ ) are real perturbations which break the  $S_{3L} \times S_{3R}$  and  $S_{2L} \times S_{2R}$  symmetries, respectively. After the transformation  $O_*^T M_q^{(D)} O_* = M_q^{(H)}$ , where  $O_*$  has been given in Eq. (67), we immediately arrive at

$$M_u^{(H)} = \frac{C_u}{9} \begin{pmatrix} 0 & +3\sqrt{3}\sigma_u & 0 \\ +3\sqrt{3}\sigma_u & -2\epsilon_u & -2\sqrt{2}\epsilon_u \\ 0 & -2\sqrt{2}\epsilon_u & 9 + 5\epsilon_u \end{pmatrix}, \quad (262a)$$

$$M_d^{(H)} = \frac{C_d}{9} \begin{pmatrix} 0 & +3\sqrt{3}\sigma'_d & 0 \\ -3\sqrt{3}\sigma'_d & -2\epsilon_d & -2\sqrt{2}\epsilon_d \\ 0 & -2\sqrt{2}\epsilon_d & 9 + 5\epsilon_d \end{pmatrix}, \quad (262b)$$

in the hierarchy basis. Such an explicit breaking of  $S_{3L} \times S_{3R}$  symmetry is unavoidably contrived, as we are guided by obtaining some textures of  $M_u^{(H)}$  and  $M_d^{(H)}$  which are essentially compatible with what we have observed about quark flavor mixing and CP violation.

A straightforward calculation allows us to diagonalize  $M_u^{(H)}$  and  $M_d^{(H)}$  via the unitary transformations  $O_u^\dagger M_u^{(H)} O_u = \text{Diag}\{m_u, m_c, m_t\}$  and  $O_d^\dagger M_d^{(H)} O_d = \text{Diag}\{m_d, m_s, m_b\}$ , where  $O_u = O_u Q$  and  $O_d = O_d Q$  with  $Q \equiv \text{Diag}\{-1, 1, 1\}$  to match the negative determinant of  $M_u^{(H)}$  or  $M_d^{(H)}$ . In the next-to-leading-order approximation, we find

$$C_u \simeq m_t \left(1 + \frac{5m_c}{2m_t}\right), \quad \epsilon_u \simeq -\frac{9m_c}{2m_t} \left(1 - \frac{1m_c}{2m_t}\right), \quad \sigma_u \simeq \frac{\sqrt{3m_u m_c}}{m_t} \left(1 - \frac{5m_c}{2m_t}\right); \quad (263a)$$

$$C_d \simeq m_b \left(1 + \frac{5m_s}{2m_b}\right), \quad \epsilon_d \simeq -\frac{9m_s}{2m_b} \left(1 - \frac{1m_s}{2m_b}\right), \quad \sigma_d \simeq \frac{\sqrt{3m_d m_s}}{m_b} \left(1 - \frac{5m_s}{2m_b}\right). \quad (263b)$$

Then the CKM quark flavor mixing matrix  $V = O_u^\dagger O_d$  can be figured out. The main nontrivial results are summarized as follows:

$$\begin{aligned} |V_{us}| &\simeq |V_{cd}| \simeq \sqrt{\left(\frac{m_u}{m_c} + \frac{m_d}{m_s}\right) \left(1 - \frac{m_u}{m_c} - \frac{m_d}{m_s}\right)}, \\ |V_{cb}| &\simeq |V_{ts}| \simeq \sqrt{2} \left(\frac{m_s}{m_b} - \frac{m_c}{m_t}\right) \left[1 + 3 \left(\frac{m_s}{m_b} + \frac{m_c}{m_t}\right)\right], \\ \left|\frac{V_{ub}}{V_{cb}}\right| &\simeq \sqrt{\frac{m_u}{m_c}}, \quad \left|\frac{V_{td}}{V_{ts}}\right| \simeq \sqrt{\frac{m_d}{m_s}}, \end{aligned} \quad (264)$$

together with  $\alpha \simeq 90^\circ$  for one of the three inner angles of the most popular CKM unitarity triangle defined in Fig. 10 and

$$\mathcal{J}_q \simeq 2 \sqrt{\frac{m_u}{m_c}} \sqrt{\frac{m_d}{m_s}} \left(\frac{m_s}{m_b} - \frac{m_c}{m_t}\right)^2 \left[1 + 6 \left(\frac{m_s}{m_b} + \frac{m_c}{m_t}\right)\right] \quad (265)$$

for the Jarlskog invariant of CP violation in the quark sector. Taking account of the values of quark masses listed in Table 7 and those of CKM matrix elements in Table 8, we see that the

predictions in Eqs. (264) and (265) are consistent with current experimental data to a reasonably good degree of accuracy. Only the relation  $|V_{ub}/V_{cb}| \simeq \sqrt{m_u/m_c}$  is a bit problematic, and hence the next-to-leading-order correction to it needs to be taken into consideration [509].

To obtain the proper terms of flavor democracy breaking, one may follow an inverse way to reconstruct the Hermitian textures of quark mass matrices in terms of the quark masses and flavor mixing parameters. But how to decompose the CKM matrix  $V$  into the unitary matrices  $O_u$  and  $O_d$  is an open question, because it is impossible to find a unique approach to do so. Based on the particular parametrization of  $V$  advocated in Eq. (135), one may decompose  $V$  as follows [733]:

$$O_u = O_* \begin{pmatrix} 1 & 0 & 0 \\ 0 & \cos(\eta_u \vartheta) & -\sin(\eta_u \vartheta) \\ 0 & \sin(\eta_u \vartheta) & \cos(\eta_u \vartheta) \end{pmatrix} \begin{pmatrix} \exp(i\eta_u \varphi) & 0 & 0 \\ 0 & 1 & 0 \\ 0 & 0 & 1 \end{pmatrix} \begin{pmatrix} \cos \vartheta_u & -\sin \vartheta_u & 0 \\ \sin \vartheta_u & \cos \vartheta_u & 0 \\ 0 & 0 & 1 \end{pmatrix}, \quad (266a)$$

$$O_d = O_* \begin{pmatrix} 1 & 0 & 0 \\ 0 & \cos(\eta_d \vartheta) & -\sin(\eta_d \vartheta) \\ 0 & \sin(\eta_d \vartheta) & \cos(\eta_d \vartheta) \end{pmatrix} \begin{pmatrix} \exp(i\eta_d \varphi) & 0 & 0 \\ 0 & 1 & 0 \\ 0 & 0 & 1 \end{pmatrix} \begin{pmatrix} \cos \vartheta_d & -\sin \vartheta_d & 0 \\ \sin \vartheta_d & \cos \vartheta_d & 0 \\ 0 & 0 & 1 \end{pmatrix}, \quad (266b)$$

where  $\eta_u = +2/3$  and  $\eta_d = -1/3$  are conjectured to correspond to the electric charges of up- and down-type quarks. It is easy to check that the product  $O_u^\dagger O_d$  can exactly reproduce  $V$  in Eq. (135), but now both  $O_u$  and  $O_d$  are fully determined after the experimental values of  $\vartheta_u$ ,  $\vartheta_d$ ,  $\vartheta$  and  $\varphi$  are input. Then a reconstruction of Hermitian  $M_u = O_u D_u O_u^\dagger$  and  $M_d = O_d D_d O_d^\dagger$ , where  $D_u$  and  $D_d$  have been defined in Eq. (6), will be straightforward. One finds that the resulting  $M_u$  or  $M_d$  can always be expressed as a sum of three terms with the  $S_{3L} \times S_{3R}$ ,  $S_{2L} \times S_{2R}$  and  $S_{1L} \times S_{1R}$  symmetries, respectively [733, 734]. Of course, the assumptions made in decomposing  $V$  as Eqs. (266a) and (266b) are purely phenomenological, but the structural parallelism between up- and down-quark mass matrices should be justifiable in most realistic model-building exercises [735].

### 6.2.3. Comments on the Friedberg-Lee symmetry

Another phenomenological way to understand the strong quark mass hierarchies, especially the smallness of  $m_u$  and  $m_d$ , is the Friedberg-Lee symmetry [736, 737, 738, 739, 740, 741, 742]<sup>34</sup>. The point is that the up- and down-type quark mass terms

$$-\mathcal{L}_{\text{quark}} = \overline{(u \ c \ t)}_L M_u \begin{pmatrix} u \\ c \\ t \end{pmatrix}_R + \overline{(d \ s \ b)}_L M_d \begin{pmatrix} d \\ s \\ b \end{pmatrix}_R + \text{h.c.} \quad (267)$$

are required to keep unchanged under the following translational transformations of six quark fields:  $(u, c, t) \rightarrow (u, c, t) + \zeta_u$  and  $(d, s, b) \rightarrow (d, s, b) + \zeta_d$ , where  $\zeta_u$  and  $\zeta_d$  are two constant elements of the Grassmann algebra independent of both space and time. In this case it is easy to show that  $M_u$  and  $M_d$  must have parallel textures of the form (for  $q = u$  or  $d$ )

$$M_q = \begin{pmatrix} y_q + z_q & -y_q & -z_q \\ -y_q & x_q + y_q & -x_q \\ -z_q & -x_q & x_q + z_q \end{pmatrix}, \quad (268)$$

<sup>34</sup>Some interesting and viable applications of this empirical flavor symmetry to the neutrino sector can be found in Refs. [743, 744, 745, 746, 747, 748, 749, 750, 751, 752, 753].

where  $x_q, y_q$  and  $z_q$  are assumed to be real and positive. Because of  $\det M_q = 0$ , one of the quark masses in each sector is vanishing. Given the fact of  $m_u \ll m_c \ll m_t$  and  $m_d \ll m_s \ll m_b$ , it is therefore natural to take  $m_u = m_d = 0$  in the Friedberg-Lee symmetry limit. Namely,  $O_u^T M_u O_u = \text{Diag}\{0, m_c, m_t\}$  and  $O_d^T M_d O_d = \text{Diag}\{0, m_s, m_b\}$  hold, where

$$m_c, m_t = (x_u + y_u + z_u) \mp \sqrt{x_u^2 + y_u^2 + z_u^2 - x_u y_u - x_u z_u - y_u z_u}, \quad (269a)$$

$$m_s, m_b = (x_d + y_d + z_d) \mp \sqrt{x_d^2 + y_d^2 + z_d^2 - x_d y_d - x_d z_d - y_d z_d}; \quad (269b)$$

and

$$O_q = \frac{1}{\sqrt{6}} \begin{pmatrix} \sqrt{2} & -2 & 0 \\ \sqrt{2} & 1 & \sqrt{3} \\ \sqrt{2} & 1 & -\sqrt{3} \end{pmatrix} \begin{pmatrix} 1 & 0 & 0 \\ 0 & \cos \omega_q & \sin \omega_q \\ 0 & -\sin \omega_q & \cos \omega_q \end{pmatrix}, \quad (270)$$

where  $\omega_q$  is given by  $\tan 2\omega_q = \sqrt{3}(y_q - z_q)/(2x_q - y_q - z_q)$ . This angle will vanish if  $y_q = z_q$  holds, in which case the quark mass terms in Eq. (267) are invariant under the  $c \leftrightarrow t$  and  $s \leftrightarrow b$  permutation symmetries [743, 745]. The CKM matrix  $V = O_u^\dagger O_d$  turns out to be

$$V = \begin{pmatrix} 1 & 0 & 0 \\ 0 & \cos(\omega_d - \omega_u) & \sin(\omega_d - \omega_u) \\ 0 & -\sin(\omega_d - \omega_u) & \cos(\omega_d - \omega_u) \end{pmatrix}. \quad (271)$$

Different from the flavor democracy limit discussed above, in which there is no quark flavor mixing at all, the Friedberg-Lee symmetry limit allows the existence of nontrivial flavor mixing between the second and third quark families in general.

It is clear that the so-called chiral quark mass limit (i.e.,  $m_u \rightarrow 0$  and  $m_d \rightarrow 0$ ) emphasized in section 6.1 can be regarded as a natural consequence of the Friedberg-Lee symmetry. That is why the latter may serve as a plausible starting point for building a realistic quark mass model, at least from the phenomenological perspective. The next step is of course to break the Friedberg-Lee symmetry so as to generate nonzero masses for  $u$  and  $d$  quarks, Such symmetry breaking effects should also give finite values for the other two flavor mixing angles and the CP-violating phase [737, 741, 754, 755, 756]. The open question is how to find out a proper way of breaking this symmetry in order to successfully interpret the observed pattern of the CKM matrix and the observed spectrum of quark masses.

In this connection one might frown on the simple example discussed above, because it is still far away from a real quark mass model which is expected to have a well-defined flavor symmetry structure and can easily be embedded into a more fundamental framework beyond the SM. Given the fact that no clue to the flavor puzzles has so far been found on the theoretical side, it should make sense to make every effort in the phenomenological aspects to explore all the possible underlying fermion flavor structures and confront their testable consequences with current experiment data. Just as argued by Leonardo da Vinci, “although nature commences with reason and ends in experience, it is necessary for us to do the opposite, that is to commence with experience and from this to proceed to investigate the reason” [757].

### 6.3. Texture zeros of quark mass matrices

#### 6.3.1. Where do texture zeros come from?

If some elements of the fermion mass matrices are vanishing, the number of their free parameters will be reduced, making it possible to establish some testable relations between the fermion mass ratios and the observable flavor mixing quantities. Such a texture-zero approach was first developed in 1977 to calculate the Cabibbo angle of quark flavor mixing in the two-family scheme [129, 130, 131], and it was extended by Harald Fritzsch to the three-family case one year later [135, 136]. The original version of the Fritzsch texture for quark mass matrices is of the form <sup>35</sup>

$$M_q = \begin{pmatrix} 0 & C_q & 0 \\ C_q^* & 0 & B_q \\ 0 & B_q^* & A_q \end{pmatrix}, \quad (272)$$

where  $A_q$  is taken to be real and positive, and  $A_q \gg |B_q| \gg |C_q|$  holds (for  $q = u$  or  $d$ ). One can see that  $M_q$  is Hermitian and has a nearest-neighbor-interaction structure, which allows a lighter quark to acquire its mass through an interaction with the nearest heavier neighbor. These two salient features guarantee the analytical calculability of  $M_q$ ; namely,  $A_q$ ,  $|B_q|$  and  $|C_q|$  can all be expressed as simple functions of the three quark masses in each quark sector [136, 758]. It is therefore straightforward to calculate the CKM matrix elements in terms of four independent quark mass ratios (i.e.,  $m_u/m_c$ ,  $m_c/m_t$ ,  $m_d/m_s$  and  $m_s/m_b$ ) and two nontrivial phase differences between  $M_u$  and  $M_d$  (i.e.,  $\arg C_u - \arg C_d$  and  $\arg B_u - \arg B_d$ ). Without the help of a sort of left-right symmetry or some kinds of non-Abelian flavor symmetries (see, e.g., Refs. [506, 759, 760]), however, it is very difficult to naturally realize both the Hermiticity and texture zeros of  $M_q$  in Eq. (272) from the model-building perspective. Moreover, such a purely phenomenological conjecture of quark mass matrices has already been excluded by today's experimental data.

Note that in the SM or its natural extensions without flavor-changing right-handed currents it is always possible to simultaneously transform two arbitrary  $3 \times 3$  quark mass matrices  $M_u$  and  $M_d$  in a given flavor basis into either the Hermitian textures [174] or the non-Hermitian but nearest-neighbor-interaction textures [759] in a new flavor basis. The latter can be expressed as

$$M'_q = \begin{pmatrix} 0 & C_q & 0 \\ C'_q & 0 & B_q \\ 0 & B'_q & A_q \end{pmatrix}, \quad (273)$$

with  $B'_q \neq B_q$  and  $C'_q \neq C_q$  (for  $q = u$  or  $d$ ). This observation means that the texture zeros of  $M_q$  in Eq. (272) are not a contrived assumption, but just a special choice of the flavor basis as in Eq. (273) — but in this case the Hermiticity of  $M_q$  is a purely empirical assumption. On the other hand, two generic  $3 \times 3$  Hermitian quark mass matrices  $M_u$  and  $M_d$  can be further simplified in a parallel way to a more specific Hermitian texture with the vanishing (1,3) and (3,1) entries via a new choice of the flavor basis [505], and in this case only the vanishing (1,1) and (2,2) entries of

---

<sup>35</sup>If a fermion mass matrix is Hermitian or symmetric, one usually counts its off-diagonal vanishing entries  $(m,n)$  and  $(n,m)$  as *one* texture zero instead of two texture zeros. That is why the Fritzsch form of  $M_u$  and  $M_d$  is also referred to as the six-zero textures of quark mass matrices.

$M_q$  in Eq. (272) are ascribed to an empirical conjecture. In short, whether the texture zeros of a given fermion mass matrix originate from a phenomenological assumption or not depends on the flavor basis that has been chosen for this mass matrix.

From the model-building point of view, any phenomenological assumptions on the textures of fermion mass matrices should find a reasonable theoretical justification. In this connection some Abelian flavor symmetries are very helpful to generate texture zeros in the lepton and quark sectors. The simplest way to do so is a proper implementation of the global  $Z_{2N}$  symmetry, where the cyclic group  $Z_{2N}$  has a unique generator  $\omega = \exp(i\pi/N)$  which produces all the group elements  $Z_{2N} = \{1, \omega, \omega^2, \dots, \omega^{2N-1}\}$  [211, 761, 762]. By definition, a given field  $\psi$  with the  $Z_{2N}$  charge  $Q$  transforms as  $\psi \rightarrow \omega^Q \psi$ , where  $Q = 0, 1, 2, \dots, 2N - 1$ . To generate all the zeros of  $M'_u$  and  $M'_d$  in Eq. (273), the minimal cyclic group should be  $Z_6$  with charges  $Q = 0, 1, 2, 3, 4$  and  $5$ . One may assign the  $Z_6$  charges of  $\overline{Q}_{1L}$ ,  $\overline{Q}_{2L}$  and  $\overline{Q}_{3L}$  in Eq. (3) to be  $0, 1$  and  $2$ , respectively; and the  $Z_6$  charges of  $U_{1R}$ ,  $U_{2R}$  and  $U_{3R}$  in Eq. (3) to be  $1, 2$ , and  $3$ , respectively. The same assignments can be made for the down-quark sector. In this case the spinor bilinears of quark fields have the following transformation properties:

$$\overline{Q}_{iL} U_{jR} \rightarrow Z_{ij} \overline{Q}_{iL} U_{jR}, \quad \overline{Q}_{iL} D_{jR} \rightarrow Z_{ij} \overline{Q}_{iL} D_{jR}, \quad Z = \begin{pmatrix} \omega^1 & \omega^2 & \omega^3 \\ \omega^2 & \omega^3 & \omega^4 \\ \omega^3 & \omega^4 & \omega^5 \end{pmatrix}. \quad (274)$$

By introducing three  $SU(2)_L$ -singlet scalar fields  $\Phi_1$  with  $Q = 4$ ,  $\Phi_2$  with  $Q = 2$  and  $\Phi_3$  with  $Q = 1$  and arranging them to couple with the above quark bilinears, one may obtain finite (1,2), (2,1), (2,3), (3,2) and (3,3) entries of the Yukawa coupling matrices  $Y'_u$  and  $Y'_d$  under the  $Z_6$  flavor symmetry. In contrast, the (1,1), (2,2), (1,3) and (3,1) entries of  $Y'_u$  and  $Y'_d$  have to be vanishing in order to assure the whole quark sector to be invariant under the above  $Z_6$  transformations. The six-zero textures of quark mass matrices  $M'_u$  and  $M'_d$  in Eq. (273) can therefore be achieved after spontaneous electroweak symmetry breaking. But it should be noted that the  $Z_6$  symmetry itself does not guarantee the resultant zero textures of fermion mass matrices to be Hermitian, nor do any other Abelian flavor symmetries in general.

This simple example tells us that it is always possible to enforce texture zeros upon a given fermion mass matrix by means of a proper Abelian flavor symmetry [761]. However, such an approach is quite arbitrary in the sense that there is no unique way to assign the proper charges (e.g., the  $Z_{2N}$  charges) for the relevant fermion and scalar fields. And hence the charge assignment is in practice guided by how to generate a phenomenologically-favored fermion flavor texture. In comparison with the texture zeros which purely originate from a proper choice of the flavor basis, the zeros enforced by a kind of flavor symmetry can be regarded as the ‘‘dynamical’’ zeros in an explicit model to interpret the observed flavor puzzles.

It is also worth pointing out that the texture-zero approach is reasonably consistent with a very popular belief that the fermion flavors should have specific structures instead of a random nature. The latter possibility was first suggested and discussed in 1980 [763] as a statistical solution to the quark flavor problem although it was not successful, and today this *flavor anarchy* approach has been further studied for both leptons and quarks [764, 765, 766, 767, 768, 769]. In our opinion, the observed fermion mass spectra naturally point to the flavor hierarchies or some kinds of flavor symmetries, and so do the observed flavor mixing patterns in the quark and lepton sectors. One of

the most challenging tasks in today's particle physics is therefore to explore the underlying flavor structures which can shed light on the origin of fermion masses and the dynamics of flavor mixing and CP violation in a way more fundamental and more quantitative than the SM itself.

### 6.3.2. Four- and five-zero quark flavor textures

Given its Hermiticity and six texture zeros, the Fritzsche ansatz of quark mass matrices shown in Eq. (272) is left with eight independent parameters among which the six real matrix elements can be determined by six quark masses and the two phase differences between  $M_u$  and  $M_d$  can be constrained by four flavor mixing parameters of the CKM matrix  $V$ . One may therefore expect two testable relations between four independent quark mass ratios and four flavor mixing parameters. In reality, the strong mass hierarchies of up- and down-type quarks allow us to make some reliable analytical approximations for the predictions of the Fritzsche ansatz and thus obtain a few more experimentally testable relations than expected [135, 136]. It turns out that this simple but instructive ansatz has definitely been ruled out by the relevant experimental data [551, 770, 771, 772], mainly for the reason that the experimental value of  $m_t$  is so large that the predicted result of  $|V_{cb}|$  has no way to be compatible with its observed value.

A straightforward way of modifying the Fritzsche ansatz is to reduce the number of its texture zeros. If one insists that there should exist a kind of structural parallelism between up- and down-type quarks in the spirit of requiring the two sectors to be on the same dynamical footing, then one may simultaneously add nonzero (1,1), (2,2) or (1,3) and (3,1) entries into  $M_u$  and  $M_d$  in Eq. (272). But it is found that only the following four-zero textures of quark mass matrices are phenomenologically favored [510, 717, 773, 774, 775, 776, 777, 778, 779, 780]:

$$M_q = \begin{pmatrix} 0 & C_q & 0 \\ C_q^* & B'_q & B_q \\ 0 & B_q^* & A_q \end{pmatrix}, \quad (275)$$

where  $A_q$  is chosen to be real and positive,  $B'_q$  is also real, and  $A_q \gg |B_q| \gtrsim |B'_q| \gg |C_q|$  is expected to hold (for  $q = u$  or  $d$ ). Because of  $\det M_q = -A_q |C_q|^2 < 0$ , let us diagonalize  $M_u$  or  $M_d$  in Eq. (275) by using the unitary transformation  $O_u^\dagger M_u O'_u = \text{Diag}\{m_u, m_c, m_t\}$  or  $O_d^\dagger M_d O'_d = \text{Diag}\{m_d, m_s, m_b\}$ , where  $O'_u = O_u Q_u$  and  $O'_d = O_d Q_d$  with  $Q_u = Q_d = \text{Diag}\{-1, 1, 1\}$  as a typical example to match the negative determinants of  $M_u$  and  $M_d$  under discussion<sup>36</sup>. Then we arrive at the expressions

$$B'_u = m_t + m_c - m_u - A_u, \quad |B_u|^2 = \frac{(A_u + m_u)(A_u - m_c)(m_t - A_u)}{A_u}, \quad |C_u|^2 = \frac{m_u m_c m_t}{A_u}, \quad (276)$$

<sup>36</sup>As for the more restrictive Fritzsche texture of  $M_q$  in Eq. (272), the unique choice is  $Q_u = Q_d = \text{Diag}\{1, -1, 1\}$  [781]. In dealing with the four-zero texture of  $M_q$  in Eq. (275), however, there are actually four different possibilities [718, 782]:  $Q_u = \text{Diag}\{\pm 1, \mp 1, 1\}$  and  $Q_d = \text{Diag}\{\pm 1, \mp 1, 1\}$ . Such sign ambiguities come from the fact that we have required  $O'_q$  to be as calculable as  $O_q$  in diagonalizing  $M_q$ , but  $O'_q$  is only relevant to a transformation of the right-handed quark fields and thus has no physical impact on the CKM matrix  $V$ . One may certainly avoid this kind of uncertainty by starting from  $O_u^\dagger M_u M_u^\dagger O_u = \text{Diag}\{m_u^2, m_c^2, m_t^2\}$  or  $O_d^\dagger M_d M_d^\dagger O_d = \text{Diag}\{m_d^2, m_s^2, m_b^2\}$ , but in this case an exact analytical calculation becomes rather complicated and the corresponding results are too lengthy to be useful.

and

$$\begin{aligned}
O_u &= P_u \begin{pmatrix} \sqrt{\frac{m_c m_t (A_u + m_u)}{A_u (m_u + m_c) (m_u + m_t)}} & \sqrt{\frac{m_u m_t (A_u - m_c)}{A_u (m_u + m_c) (m_t - m_c)}} & \sqrt{\frac{m_u m_c (m_t - A_u)}{A_u (m_u + m_t) (m_t - m_c)}} \\ -\sqrt{\frac{m_u (A_u + m_u)}{(m_u + m_c) (m_u + m_t)}} & \sqrt{\frac{m_c (A_u - m_c)}{(m_u + m_c) (m_t - m_c)}} & \sqrt{\frac{m_t (m_t - A_u)}{(m_u + m_t) (m_t - m_c)}} \\ \sqrt{\frac{m_u (A_u - m_c) (m_t - A_u)}{A_u (m_u + m_c) (m_u + m_t)}} & -\sqrt{\frac{m_c (A_u + m_u) (m_t - A_u)}{A_u (m_u + m_c) (m_t - m_c)}} & \sqrt{\frac{m_t (A_u + m_u) (A_u - m_c)}{A_u (m_u + m_t) (m_t - m_c)}} \end{pmatrix} \\
&\simeq P_u \begin{pmatrix} \sqrt{1 - \frac{m_u}{m_c}} & \sqrt{\frac{m_u}{m_c}} & \sqrt{\left(\frac{1}{r_u} - 1\right) \frac{m_u m_c}{m_t m_t}} \\ -\sqrt{r_u \frac{m_u}{m_c}} & \sqrt{r_u} & \sqrt{1 - r_u} \\ \sqrt{(1 - r_u) \left(1 - \frac{m_c}{m_t}\right) \frac{m_u}{m_c}} & -\sqrt{1 - r_u} & \sqrt{r_u \left(1 - \frac{m_c}{m_t}\right)} \end{pmatrix}, \quad (277)
\end{aligned}$$

where  $P_u = \text{Diag} \{1, \exp(-i \arg C_u), \exp[-i(\arg B_u + \arg C_u)]\}$  is the phase matrix,  $r_u \equiv A_u/m_t \lesssim 1$  is defined, and the strong hierarchy  $m_u \ll m_c \ll m_t$  has been taken into account in doing the analytical approximation. The expressions for  $B'_d$ ,  $|B_d|$ ,  $|C_d|$ ,  $P_d$  and  $O_d$  are exactly of the same form as in Eqs. (276) and (277), with  $P_d = \text{Diag} \{1, \exp(-i \arg C_d), \exp[-i(\arg B_d + \arg C_d)]\}$ ,  $r_d \equiv A_d/m_b \lesssim 1$  and  $m_d \ll m_s \ll m_b$ . Then the nine elements of the CKM matrix  $V = O_u^\dagger O_d$  can be explicitly calculated by means of Eqs. (247) and (277). After the values of six quark masses are input,  $V$  still depends on four free parameters  $A_u, A_d, \phi_1 \equiv \arg C_u - \arg C_d$  and  $\phi_2 \equiv \arg B_u - \arg B_d$ , which can be constrained by taking account of the experimental data listed in Table 8 or Eq. (83). A careful numerical analysis shows that  $\phi_1 \sim \pm\pi/2$  and  $\phi_2 \sim 0$  hold, consistent with the special four-zero textures of quark mass matrices in Eqs. (262a) and (262b) which originate from the explicit breaking of quark flavor democracy. Moreover, we find that both  $r_u \sim r_d \lesssim 1$  and  $r_u \sim r_d \sim 0.5$  are allowed [782]. In the former case, for example, an excellent analytical approximation leads us to

$$\left| \frac{V_{ub}}{V_{cb}} \right| \simeq \left| \sqrt{\frac{m_u}{m_c}} - \sqrt{1 - r_d} \sqrt{\frac{m_d m_s}{m_b m_b} \frac{e^{i\phi}}{|V_{cb}|}} \right|, \quad \left| \frac{V_{td}}{V_{ts}} \right| \simeq \sqrt{\frac{m_d}{m_s}}, \quad (278)$$

where  $\phi \equiv \phi_1 - \arcsin(\sin \phi_2 \sqrt{1 - r_u}/|V_{cb}|)$ . Now the experimentally favored relation  $|V_{td}/V_{ts}| \simeq \sqrt{m_d/m_s}$ , which has been conjectured in the  $m_t \rightarrow \infty$  limit in Eq. (252), remains valid in the generic four-zero textures of Hermitian quark mass matrices; but the simple relation  $|V_{ub}/V_{cb}| \simeq \sqrt{m_u/m_c}$  predicted by the original Fritzsch ansatz is modified and thus can fit current experimental data by slightly adjusting the values of  $r_u$  and  $r_d$  [718, 782]. Let us make two further comments on the four-zero textures of  $M_u$  and  $M_d$  in Eq. (275).

- To reduce the number of free parameters and keep the analytical calculability, one may assume  $B'_u = m_c$  and  $B'_d = m_s$  for  $M_u$  and  $M_d$  [508, 778, 783]. In this special but interesting



Table 14: The five phenomenologically viable five-zero textures of Hermitian quark mass matrices.

	I	II	III	IV	V
$M_u =$	$\begin{pmatrix} 0 & C_u & 0 \\ C_u^* & B'_u & 0 \\ 0 & 0 & A_u \end{pmatrix}$	$\begin{pmatrix} 0 & C_u & 0 \\ C_u^* & 0 & B_u \\ 0 & B_u^* & A_u \end{pmatrix}$	$\begin{pmatrix} 0 & 0 & D_u \\ 0 & B'_u & 0 \\ D_u^* & 0 & A_u \end{pmatrix}$	$\begin{pmatrix} 0 & C_u & 0 \\ C_u^* & B'_u & B_u \\ 0 & B_u^* & A_u \end{pmatrix}$	$\begin{pmatrix} 0 & 0 & D_u \\ 0 & B'_u & B_u \\ D_u^* & B_u^* & A_u \end{pmatrix}$
$M_d =$	$\begin{pmatrix} 0 & C_d & 0 \\ C_d^* & B'_d & B_d \\ 0 & B_d^* & A_d \end{pmatrix}$	$\begin{pmatrix} 0 & C_d & 0 \\ C_d^* & B'_d & B_d \\ 0 & B_d^* & A_d \end{pmatrix}$	$\begin{pmatrix} 0 & C_d & 0 \\ C_d^* & B'_d & B_d \\ 0 & B_d^* & A_d \end{pmatrix}$	$\begin{pmatrix} 0 & C_d & 0 \\ C_d^* & B'_d & 0 \\ 0 & 0 & A_d \end{pmatrix}$	$\begin{pmatrix} 0 & C_d & 0 \\ C_d^* & B'_d & 0 \\ 0 & 0 & A_d \end{pmatrix}$

case the analytical results obtained in Eqs. (276) and (277) can be remarkably simplified, but the resulting relation  $|V_{ub}/V_{cb}| \simeq \sqrt{m_u/m_c}$  is phenomenologically disfavored.

- It has been shown that a proper flavor basis transformation allows us to arrive at Hermitian  $M_u$  of the form given in Eq. (275) and Hermitian  $M_d$  with the vanishing (1,1) entry, or vice versa, from arbitrary forms of  $M_u$  and  $M_d$  [779]. This observation means that only one phenomenological assumption — the vanishing (1,3) and (3,1) entries for  $M_d$  (or for  $M_u$ ) — is needed to make in getting at Eq. (275).

We therefore conclude that the Hermitian four-zero textures of quark mass matrices are currently the most interesting zero textures which can successfully bridge a gap between the observed quark mass spectrum and the observed flavor mixing pattern.

Note that it is also possible to realize the four zeros of  $M_u$  and  $M_d$  in Eq. (275) by means of the cyclic group  $Z_6$ . For instance, one may assign the  $Z_6$  charges of  $\overline{Q}_{L1}$ ,  $\overline{Q}_{L2}$  and  $\overline{Q}_{L3}$  in Eq. (3) to be 0, 1 and 4, respectively; and the  $Z_6$  charges of  $U_{R1}$ ,  $U_{R2}$  and  $U_{R3}$  in Eq. (3) to be 3, 4, and 1, respectively. The same assignments can be made for the down-quark sector. Then the spinor bilinears of quark fields transform as follows:

$$\overline{Q}_{Li} U_{Rj} \rightarrow Z_{ij} \overline{Q}_{Li} U_{Rj}, \quad \overline{Q}_{Li} D_{Rj} \rightarrow Z_{ij} \overline{Q}_{Li} D_{Rj}, \quad Z = \begin{pmatrix} \omega^3 & \omega^4 & \omega^1 \\ \omega^4 & \omega^5 & \omega^2 \\ \omega^1 & \omega^2 & \omega^5 \end{pmatrix}. \quad (279)$$

By invoking three  $SU(2)_L$ -singlet scalar fields  $\Phi_1$  with  $Q = 2$ ,  $\Phi_2$  with  $Q = 4$  and  $\Phi_3$  with  $Q = 1$  and arranging them to couple with the above quark bilinears, one will be left with finite (1,2), (2,1), (2,2), (2,3), (3,2) and (3,3) entries of the Yukawa coupling matrices  $Y_u$  and  $Y_d$  under the  $Z_6$  flavor symmetry. In this case the (1,1), (1,3) and (3,1) entries of  $Y_u$  and  $Y_d$  are enforced to be vanishing by the  $Z_6$  symmetry. The quark mass matrices  $M_u$  and  $M_d$  turn out to be of the four-zero textures after spontaneous electroweak symmetry breaking.

Giving up the structural parallelism between up- and down-type quark sectors, Pierre Ramond *et al* found five different five-zero textures of Hermitian  $M_u$  and  $M_d$  which were phenomenologically allowed in 1993 [551], as listed in Table 14. These textures still survive today, if each of them is not required to have a strong hierarchy [784, 785]. Of course, none of them can fit current experimental data better than the four-zero textures of quark mass matrices discussed above.

### 6.3.3. Comments on the stability of texture zeros

Since a flavor symmetry model which can naturally accommodate the texture zeros of Yukawa coupling matrices is usually built at an energy scale far above the electroweak scale  $\Lambda_{\text{EW}}$ , it is sometimes necessary to examine whether the RGE evolution has a nontrivial impact on those texture zeros of fermion mass matrices. Here let us briefly comment on the stability of Hermitian quark flavor textures with four zeros as an example.

The one-loop RGEs of  $Y_u$  and  $Y_d$  given in Eq. (165) or Eq. (170) allow us to derive a straightforward relation between  $Y_u(\Lambda)$  and  $Y_u(\Lambda_{\text{EW}})$  or that between  $Y_d(\Lambda)$  and  $Y_d(\Lambda_{\text{EW}})$  in a reasonable analytical approximation, where  $\Lambda \gg \Lambda_{\text{EW}}$  is naturally assumed. To be more explicit, we are subject to the SM or the MSSM with  $\tan\beta \lesssim 10$ , in which case the top-quark Yukawa coupling is expected to dominate how the structures of  $Y_u$  and  $Y_d$  change with the energy scale, while the gauge coupling contributions only provide an overall RGE correction factor for each Yukawa coupling matrix. In this case one obtains the generic one-loop results [786]

$$(Y_u)_{ij}(\Lambda_{\text{EW}}) \simeq \gamma_u \left[ (Y_u)_{ij}(\Lambda) + (I_t^{C_u} - 1) \sum_{k=1}^3 (O_u)_{i3} (O_u^*)_{k3} (Y_u)_{kj}(\Lambda) \right], \quad (280a)$$

$$(Y_d)_{ij}(\Lambda_{\text{EW}}) \simeq \gamma_d \left[ (Y_d)_{ij}(\Lambda) + (I_t^{C_d} - 1) \sum_{k=1}^3 (O_u)_{i3} (O_u^*)_{k3} (Y_d)_{kj}(\Lambda) \right], \quad (280b)$$

where  $O_u$  is a unitary matrix used for the diagonalization  $O_u^\dagger Y_u Y_u^\dagger O_u \simeq \text{Diag}\{0, 0, y_t^2\}$  in the top-dominance approximation [550, 787],  $I_t$  has been defined in Eq. (183) and its numerical evolution with  $\Lambda$  can be found in Fig. 24, and

$$\gamma_{u,d} \equiv \exp \left[ -\frac{1}{16\pi^2} \int_0^{\ln(\Lambda/\Lambda_{\text{EW}})} \alpha_{u,d}(t) dt \right] \quad (281)$$

with the expressions of  $\alpha_u$  and  $\alpha_d$  having been given in Eq. (166) or Eq. (167). It becomes clear that the stability of up- and down-type quark mass matrices against the RGE evolution depends on the deviations of  $I_t^{C_u}$  and  $I_t^{C_d}$  from one, respectively.

Given the Hermitian four-zero textures of  $M_u$  and  $M_d$  at a superhigh energy scale  $\Lambda$  as shown in Eq. (275), one may use Eqs. (280a) and (280b) to get the corresponding quark mass matrices at the electroweak scale  $\Lambda_{\text{EW}}$  as follows:

$$M_u(\Lambda_{\text{EW}}) \simeq \gamma_u \left[ \begin{pmatrix} 0 & C_u & 0 \\ C_u^* & B'_u & B_u I_t^{C_u} \\ 0 & B_u^* I_t^{C_u} & A_u I_t^{C_u} \end{pmatrix} + \frac{I_t^{C_u} - 1}{A_u} \begin{pmatrix} 0 & 0 & 0 \\ 0 & |B_u|^2 & B_u B'_u \\ 0 & B_u^* B'_u & 0 \end{pmatrix} \right], \quad (282a)$$

$$M_d(\Lambda_{\text{EW}}) \simeq \gamma_d \left[ \begin{pmatrix} 0 & C_d & 0 \\ C_d^* & B'_d & B_d \\ 0 & B_d^* I_t^{C_d} & A_d I_t^{C_d} \end{pmatrix} + \frac{I_t^{C_d} - 1}{A_u} \begin{pmatrix} 0 & 0 & 0 \\ 0 & B_u B_d^* & A_d B_u \\ 0 & B_u^* B'_d & B_u^* B_d \end{pmatrix} \right]. \quad (282b)$$

We see that the texture zeros of both  $M_u$  and  $M_d$  keep unchanged in this approximation, but the Hermiticity of  $M_d$  gets lost. If the (2,2) entries are switched off in the beginning, then one finds that the (2,2) zeros of the Fritzsch ansatz are definitely sensitive to the RGE corrections [788].

As shown in Eqs. (261a) and (261b), a proper breaking of quark flavor democracy allows us to obtain a viable four-zero ansatz for quark mass matrices in the hierarchy basis, which is essentially consistent with current experimental data. It is therefore possible to study the one-loop RGE corrections to the democratic textures of  $M_u$  and  $M_d$  in a similar way [550, 733], and their effects can be interpreted as a kind of radiative flavor democracy breaking. One may analogously discuss the RGE-induced flavor democracy breaking effects in the lepton sector, to see how the democratic flavor mixing pattern  $U_0$  in Eq. (104) is modified at low energies [724].

#### 6.4. Towards building a realistic flavor model

##### 6.4.1. Hierarchies and U(1) flavor symmetries

Regarding the texture-zero approach discussed above, we have seen that the nonzero elements of quark mass matrices are generally required to be hierarchical in magnitude so as to predict a strong mass hierarchy and small rotation angles in each quark sector. Such a phenomenological treatment should also find a good reason in a realistic flavor model. In this connection the Froggatt-Nielsen (FN) mechanism has popularly been used to interpret the hierarchical flavor structures of leptons and quarks [134]. The idea is simply to introduce a flavor-dependent U(1) symmetry to distinguish one fermion from another, and invoke an  $SU(2)_L$ -singlet scalar field  $S$  — known as the “flavon” field — to break the U(1) symmetry after the flavon acquires its vacuum expectation value. This kind of family symmetry breaking is communicated to the fermions, such that their effective Yukawa coupling matrix elements can be expanded in powers of a small and positive parameter  $\epsilon \equiv \langle S \rangle / M_*$  with  $M_*$  being the corresponding energy scale of flavor dynamics. Similar to the canonical seesaw scale  $\Lambda_{SS}$ , which is essentially equivalent to the mass of the lightest heavy Majorana neutrino, the scale  $M_*$  is also associated with some hypothetical and superheavy fermions — the so-called FN fermions which will be integrated out at low energies. The most striking feature of the FN mechanism is that both the hierarchical textures of fermion masses and the hierarchical pattern of quark flavor mixing can be intuitively interpreted as powers of the expansion parameter  $\epsilon$  [789, 790, 791, 792, 793, 794]. So  $\epsilon \simeq \lambda$  is naturally expected, where  $\lambda \simeq 0.22$  denotes the Wolfenstein parameter which has been used to expand the CKM matrix  $V$  in Eq. (78). That is to say, we expect that the FN mechanism can help establish a reasonable theoretical link between the observed flavor mixing hierarchy (i.e.,  $\vartheta_{12} \sim \lambda$ ,  $\vartheta_{23} \sim \lambda^2$  and  $\vartheta_{13} \sim \lambda^4$ ) and the observed quark mass hierarchies (i.e.,  $m_u/m_c \sim m_c/m_t \sim \lambda^4$  and  $m_d/m_s \sim m_s/m_b \sim \lambda^2$ ) as clearly illustrated in Figs. 2 and 3.

Given the standard Yukawa interactions of charged leptons and quarks in Eq. (3), let us assume that the FN fermions can only interact with the SM fermions via the Higgs and flavon fields. Since the symmetry group of the flavon is U(1), a given field  $\psi$  with the U(1) charge  $Q$  transforms as  $\psi \rightarrow e^{iQ\alpha}\psi$ , where  $\alpha$  is a continuous real parameter independent of space and time. After this symmetry is spontaneously broken, each insertion of an FN fermion propagator together with the associated flavon field  $S$  contributes a factor  $\epsilon \equiv \langle S \rangle / M_*$ , and the outgoing fermion differs in flavon charge by one unit from the incoming one. Namely,  $Q(S) = -1$ . If the U(1) charges of  $\overline{Q_{iL}}$ ,  $\overline{\ell_{\alpha L}}$ ,  $U_{iR}$ ,  $D_{iR}$ ,  $E_{\alpha R}$  (for  $i = 1, 2, 3$  and  $\alpha = e, \mu, \tau$ ) and  $H$  in Eq. (3) are properly assigned, then the U(1) flavor symmetry requires the aforementioned interaction of the flavon with the FN fermion to repeat a number of times in between the left- and right-handed fields of the SM fermions interacting with the Higgs field [134]. Integrating out the relevant heavy degrees of freedom, one

Table 15: The particle content and flavor U(1) charge assignments for the MSSM fields and the flavon field  $S$  in a simple FN-like model of charged fermions described by Eq. (285), where  $r$  is an integer allowed to take values 0, 1 or 2, corresponding to possibly large, medium or small values of  $\tan\beta$  in the MSSM [795].

Fields	U(1) charges
$\overline{Q}_{1L}, \overline{Q}_{2L}, \overline{Q}_{3L}$	4, 2, 0
$\overline{\ell}_{eL}, \overline{\ell}_{\mu L}, \overline{\ell}_{\tau L}$	1 + $r$ , $r$ , $r$
$U_{1R}, U_{2R}, U_{3R}$	4, 2, 0
$D_{1R}, D_{2R}, D_{3R}$	1 + $r$ , $r$ , $r$
$E_{eR}, E_{\mu R}, E_{\tau R}$	4, 2, 0
$H_1, H_2, S$	0, 0, -1

is left with the effective Yukawa interactions of the SM fermions of the form

$$-\mathcal{L}_Y^{(\text{FN})} = \epsilon^{n_{ij}} \overline{Q}_{iL}(Y'_u)_{ij} \widetilde{H} U_{jR} + \epsilon^{n'_{ij}} \overline{Q}_{iL}(Y'_d)_{ij} H D_{jR} + \epsilon^{n''_{\alpha\beta}} \overline{\ell}_{\alpha L}(Y'_l)_{\alpha\beta} H E_{\beta R} + \text{h.c.}, \quad (283)$$

where  $n_{ij} = \mathcal{Q}(\overline{Q}_{iL}) + \mathcal{Q}(U_{jR}) - \mathcal{Q}(H)$ ,  $n'_{ij} = \mathcal{Q}(\overline{Q}_{iL}) + \mathcal{Q}(D_{jR}) + \mathcal{Q}(H)$  and  $n''_{\alpha\beta} = \mathcal{Q}(\overline{\ell}_{\alpha L}) + \mathcal{Q}(E_{\beta R}) + \mathcal{Q}(H)$  (for  $i, j = 1, 2, 3$  and  $\alpha, \beta = e, \mu, \tau$ ) are non-negative integers by default, and the effective Yukawa coupling matrices  $Y'_u$ ,  $Y'_d$  and  $Y'_l$  have included the contributions from those couplings between the FN fermions and the flavon. After the electroweak symmetry is spontaneously broken, Eq. (283) leads us to the effective fermion mass matrix elements

$$(M'_u)_{ij} = \epsilon^{n_{ij}} (Y'_u)_{ij} \frac{v}{\sqrt{2}}, \quad (M'_d)_{ij} = \epsilon^{n'_{ij}} (Y'_d)_{ij} \frac{v}{\sqrt{2}}, \quad (M'_l)_{\alpha\beta} = \epsilon^{n''_{\alpha\beta}} (Y'_l)_{\alpha\beta} \frac{v}{\sqrt{2}}. \quad (284)$$

Assuming an exact or approximate flavor democracy for  $Y'_u$ ,  $Y'_d$  or  $Y'_l$  by naturalness, one may then attribute the structural hierarchy of a given fermion mass matrix to different powers of  $\epsilon$  for its different elements. This is just the spirit of the FN mechanism.

Although the above discussions are subject to the SM, they are also valid for a natural extension of the SM with two Higgs doublets (i.e.,  $H = H_1$  with hypercharge +1/2 and  $\widetilde{H} = H_2$  with hypercharge -1/2 as done in section 4.5.1 for the MSSM). To illustrate why the FN mechanism works to constrain the textures of charged-lepton and quark mass matrices, let us take a simple example from Ref. [795] by neglecting the neutrino sector. In this MSSM scenario the effective FN-like Yukawa interactions of charged fermions are

$$-\mathcal{L}_Y^{(\text{FN})} = \epsilon^{n_{ij}} \overline{Q}_{iL}(Y_u)_{ij} H_2 U_{jR} + \epsilon^{n'_{ij}} \overline{Q}_{iL}(Y_d)_{ij} H_1 D_{jR} + \epsilon^{n''_{\alpha\beta}} \overline{\ell}_{\alpha L}(Y_l)_{\alpha\beta} H_1 E_{\beta R} + \text{h.c.} \quad (285)$$

with  $n_{ij} = \mathcal{Q}(\overline{Q}_{iL}) + \mathcal{Q}(U_{jR}) + \mathcal{Q}(H_2)$ ,  $n'_{ij} = \mathcal{Q}(\overline{Q}_{iL}) + \mathcal{Q}(D_{jR}) + \mathcal{Q}(H_1)$  and  $n''_{\alpha\beta} = \mathcal{Q}(\overline{\ell}_{\alpha L}) + \mathcal{Q}(E_{\beta R}) + \mathcal{Q}(H_1)$  (for  $i, j = 1, 2, 3$  and  $\alpha, \beta = e, \mu, \tau$ ), and the flavor U(1) charge assignments for the relevant MSSM fields and the flavon field  $S$  are shown in Table 15. Such explicit charge assignments are guided by current experimental data to a large extent, it is theoretically compatible with the SU(5)

unification framework [116]. As a result,

$$M_u \sim \langle H_2 \rangle \begin{pmatrix} \epsilon^8 & \epsilon^6 & \epsilon^4 \\ \epsilon^6 & \epsilon^4 & \epsilon^2 \\ \epsilon^4 & \epsilon^2 & 1 \end{pmatrix}, \quad M_d \sim \langle H_1 \rangle \epsilon^r \begin{pmatrix} \epsilon^5 & \epsilon^4 & \epsilon^4 \\ \epsilon^3 & \epsilon^2 & \epsilon^2 \\ \epsilon & 1 & 1 \end{pmatrix}, \quad M_l \sim \langle H_1 \rangle \epsilon^r \begin{pmatrix} \epsilon^5 & \epsilon^3 & \epsilon \\ \epsilon^4 & \epsilon^2 & 1 \\ \epsilon^4 & \epsilon^2 & 1 \end{pmatrix} \quad (286)$$

after spontaneous electroweak symmetry breaking. Taking  $\epsilon \sim \lambda$ , one immediately arrives at the phenomenologically-favored hierarchies  $m_u : m_c : m_t \sim \lambda^8 : \lambda^4 : 1$ ,  $m_d : m_s : m_b \sim \lambda^5 : \lambda^2 : 1$  and  $m_e : m_\mu : m_\tau \sim \lambda^5 : \lambda^2 : 1$ . Note that the lopsided textures of  $M_d$  and  $M_l$  together with the relation  $M_d \sim M_l^T$  allow us to obtain relatively large lepton flavor mixing effects once the seesaw mechanism is applied to the neutrino sector [795]. In particular, a kind of testable correlation between small quark flavor mixing parameters and large lepton flavor mixing parameters can be easily established in this approach [796, 797, 798, 799].

It is worth mentioning that the FN mechanism can be combined with some stringy symmetries to derive the textures of fermion mass matrices [775, 776, 800, 801, 802, 803, 804]. For example, there may exist non-renormalizable quark couplings of the type  $\overline{Q}_{iL}(Y'_u)_{ij}H_2U_{jR}(S_u/M_*)^{n_{ij}}$  for the up-type quark sector or  $\overline{Q}_{iL}(Y'_d)_{ij}H_1D_{jR}(S_d/M_*)^{n'_{ij}}$  for the down-type quark sector in an underlying supergravity or superstring theory, where  $S_u$  and  $S_d$  denote the relevant flavon fields. When the flavon and Higgs fields develop their respective vacuum expectation values, one will be left with the effective quark mass matrices  $(M'_u)_{ij} = \epsilon^{n_{ij}}(Y'_u)_{ij}\langle H_2 \rangle$  and  $(M'_d)_{ij} = \epsilon^{n'_{ij}}(Y'_d)_{ij}\langle H_1 \rangle$  as those in Eq. (284), where  $\epsilon_u \equiv \langle S_u \rangle / M_*$  and  $\epsilon_d \equiv \langle S_d \rangle / M_*$  are small and positive expansion parameters. Then a kind of  $Z_6$ -II orbifold model with the allowed non-renormalizable couplings may help us to obtain the following symmetric quark mass matrices [775, 776]:

$$M'_u \sim \langle H_2 \rangle \begin{pmatrix} 0 & \epsilon_u^3 & 0 \\ \epsilon_u^3 & \epsilon_u^2 & \epsilon_u^2 \\ 0 & \epsilon_u^2 & 1 \end{pmatrix}, \quad M'_d \sim \langle H_1 \rangle \begin{pmatrix} 0 & \epsilon_d^3 & 0 \\ \epsilon_d^3 & \epsilon_d^2 & \epsilon_d^2 \\ 0 & \epsilon_d^2 & 1 \end{pmatrix}, \quad (287)$$

where all the Yukawa coupling matrix elements have been assumed to be of  $O(1)$ , and all the zeros mean that they are sufficiently suppressed in magnitude as compared with their neighboring elements. We see that the patterns of quark mass matrices in Eq. (287) are essentially consistent with the four-zero textures shown in Eqs. (262a) and (262b), and thus they should essentially be compatible with current experimental data if a proper phase difference between  $M'_u$  and  $M'_d$  is introduced [509]. Of course, the RGE corrections to quark mass matrices should be taken into account when building a realistic flavor model at the stringy scale ( $\sim 10^{17}$  GeV) and confronting it with the experimental measurements at low energies.

#### 6.4.2. Model building based on $A_4$ flavor symmetry

One of the most popular discrete flavor symmetry groups which have been used for describing the family structures of leptons and quarks is the  $A_4$  group — the symmetry group of the tetrahedron [455, 457, 458, 805, 806, 807, 808, 809]. It is a non-Abelian finite subgroup of  $SO(3)$ . Now that the tetrahedron lives in the three-dimensional space, it is natural for  $A_4$  to have a three-dimensional representation denoted as  $\mathbf{3}$ , which is suggestive of the observed three fermion families in the SM [810]. Since the tetrahedron has four vertices,  $A_4$  describes the

even permutations of four objects and thus has  $4!/2 = 12$  elements. Besides the identity matrix  $I = S^{(123)}$ , where  $S^{(123)}$  has been given in Eq. (253), we have three  $3 \times 3$  reflection matrices:  $r_1 = \text{Diag}\{1, -1, -1\}$ ,  $r_2 = \text{Diag}\{-1, 1, -1\}$  and  $r_3 = \text{Diag}\{-1, -1, 1\}$ . Moreover, we have the cyclic permutation  $c = S^{(312)}$  and the anti-cyclic permutation  $a = S^{(231)}$ , where  $S^{(312)}$  and  $S^{(231)}$  have also been given in Eq. (253). Note that  $\{I, c, a\}$  form the  $C_3 = Z_3$  subgroup, while  $\{I, r_i\}$  form the  $Z_2$  subgroup [810, 811]. Note also that  $c$  and  $r_i c r_i$  (for  $i = 1, 2, 3$ ) form an equivalence class with four members, and  $a$  and  $r_i a r_i$  (for  $i = 1, 2, 3$ ) form another equivalence class with four members. We are therefore left with twelve elements of  $A_4$ , belonging to four equivalence classes with one ( $I$ ), three ( $r_i$ ), four ( $c$  and  $r_i c r_i$ ) and four ( $a$  and  $r_i a r_i$ ) members, respectively. There are accordingly four irreducible representations of  $A_4$ , denoted as  $\underline{\mathbf{3}}, \underline{\mathbf{1}}, \underline{\mathbf{1}}'$  and  $\underline{\mathbf{1}}''$ . Under the cyclic permutation  $c$  (or  $a$ ),  $\underline{\mathbf{1}}' \rightarrow \omega \underline{\mathbf{1}}'$  and  $\underline{\mathbf{1}}'' \rightarrow \omega^2 \underline{\mathbf{1}}''$  (or  $\underline{\mathbf{1}}' \rightarrow \omega^2 \underline{\mathbf{1}}'$  and  $\underline{\mathbf{1}}'' \rightarrow \omega \underline{\mathbf{1}}''$ ) hold, where  $\omega = \exp(i2\pi/3)$  is a complex cube root of unity and satisfies  $1 + \omega + \omega^2 = 0$ . Evidently,  $\underline{\mathbf{1}}' \otimes \underline{\mathbf{1}}' = \underline{\mathbf{1}}''$ ,  $\underline{\mathbf{1}}'' \otimes \underline{\mathbf{1}}'' = \underline{\mathbf{1}}'$  and  $\underline{\mathbf{1}}' \otimes \underline{\mathbf{1}}'' = \underline{\mathbf{1}}$  hold. The basic nontrivial tensor products are  $\underline{\mathbf{3}} \otimes \underline{\mathbf{3}} = \underline{\mathbf{3}}_S \oplus \underline{\mathbf{3}}_A \oplus \underline{\mathbf{1}} \oplus \underline{\mathbf{1}}' \oplus \underline{\mathbf{1}}''$ , where ‘‘S’’ (or ‘‘A’’) denotes the symmetric (or antisymmetric) product, and the existence of three inequivalent one-dimensional representations can be regarded as another hint of the relevance of  $A_4$  to the family problem of leptons and quarks [810]. Using  $(x_1, x_2, x_3)$  and  $(y_1, y_2, y_3)$  to denote the basis vectors for the two three-dimensional representations, one has

$$\begin{aligned}
\underline{\mathbf{3}}_S &= (x_2 y_3 + x_3 y_2, x_3 y_1 + x_1 y_3, x_1 y_2 + x_2 y_1), \\
\underline{\mathbf{3}}_A &= (x_2 y_3 - x_3 y_2, x_3 y_1 - x_1 y_3, x_1 y_2 - x_2 y_1), \\
\underline{\mathbf{1}} &= x_1 y_1 + x_2 y_2 + x_3 y_3, \\
\underline{\mathbf{1}}' &= x_1 y_1 + \omega x_2 y_2 + \omega^2 x_3 y_3, \\
\underline{\mathbf{1}}'' &= x_1 y_1 + \omega^2 x_2 y_2 + \omega x_3 y_3.
\end{aligned} \tag{288}$$

These basis vectors are equivalent to the flavor indices when building a flavor symmetry model.

Combining the SM with the  $A_4$  flavor symmetry, we have an overall symmetry group  $SU(2)_L \otimes U(1)_Y \otimes A_4$ . The three families of left- and right-handed quark fields, together with three Higgs doublets  $\Phi_i$  (for  $i = 1, 2, 3$ ), are placed in the representations of  $A_4$  as follows [809]:

$$\begin{aligned}
Q_L &= (Q_{1L}, Q_{2L}, Q_{3L})^T \sim \underline{\mathbf{3}}, \quad U_{1R} \sim \underline{\mathbf{1}}, \quad U_{2R} \sim \underline{\mathbf{1}}', \quad U_{3R} \sim \underline{\mathbf{1}}'', \\
D_{1R} &\sim \underline{\mathbf{1}}, \quad D_{2R} \sim \underline{\mathbf{1}}', \quad D_{3R} \sim \underline{\mathbf{1}}''; \quad \Phi = (\Phi_1, \Phi_2, \Phi_3)^T \sim \underline{\mathbf{3}}.
\end{aligned} \tag{289}$$

Then the Yukawa interactions of six quarks, which are invariant under  $SU(2)_L \otimes U(1)_Y \otimes A_4$ , can be expressed in the following way:

$$\begin{aligned}
-\mathcal{L}_{\text{quark}} &= \lambda_u (\overline{Q}_L \widetilde{\Phi})_{\underline{\mathbf{1}}} (U_{1R})_{\underline{\mathbf{1}}} + \lambda'_u (\overline{Q}_L \widetilde{\Phi})_{\underline{\mathbf{1}}'} (U_{3R})_{\underline{\mathbf{1}}''} + \lambda''_u (\overline{Q}_L \widetilde{\Phi})_{\underline{\mathbf{1}}''} (U_{2R})_{\underline{\mathbf{1}}'} \\
&\quad + \lambda_d (\overline{Q}_L \Phi)_{\underline{\mathbf{1}}} (D_{1R})_{\underline{\mathbf{1}}} + \lambda'_d (\overline{Q}_L \Phi)_{\underline{\mathbf{1}}'} (D_{3R})_{\underline{\mathbf{1}}''} + \lambda''_d (\overline{Q}_L \Phi)_{\underline{\mathbf{1}}''} (D_{2R})_{\underline{\mathbf{1}}'},
\end{aligned} \tag{290}$$

where  $\widetilde{\Phi} \equiv i\sigma_2 \Phi^*$  is defined. After the Higgs fields  $\Phi_i$  acquire their vacuum expectation values  $\langle \Phi_i^0 \rangle \equiv v_i$  (for  $i = 1, 2, 3$ ), the up- and down-type quark mass matrices are of the same texture:

$$M_q = \begin{pmatrix} \lambda_q v_1 & \lambda'_q v_1 & \lambda''_q v_1 \\ \lambda_q v_2 & \lambda'_q \omega v_2 & \lambda''_q \omega^2 v_2 \\ \lambda_q v_3 & \lambda'_q \omega^2 v_3 & \lambda''_q \omega v_3 \end{pmatrix}, \tag{291}$$

Table 16: The particle content and representation assignments of  $A_4$  and  $Z_2$  associated with charged leptons and quarks in the model described by Eq. (293) [812].

	$\ell_L$	$E_R$	$Q_L$	$D_R$	$U_{1R}$	$U_{2R}$	$U_{3R}$	$H$	$\varphi_u$	$\varphi_d$
$A_4$	$\underline{\mathbf{3}}$	$\underline{\mathbf{3}}$	$\underline{\mathbf{3}}$	$\underline{\mathbf{3}}$	$\underline{\mathbf{1}}$	$\underline{\mathbf{1}}''$	$\underline{\mathbf{1}}'$	$\underline{\mathbf{1}}$	$\underline{\mathbf{3}}$	$\underline{\mathbf{3}}$
$Z_2^u$	+	+	+	+	-	-	-	+	-	+
$Z_2^d$	+	-	+	-	+	+	+	+	+	-

for  $q = u$  and  $d$ . In the assumption of  $v_1 = v_2 = v_3 \equiv v$ , which is equivalent to the  $A_4 \rightarrow Z_3$  symmetry breaking, the above quark mass matrices can be simplified to

$$M_{u,d} = \sqrt{3} v U_\omega \begin{pmatrix} \lambda_{u,d} & 0 & 0 \\ 0 & \lambda'_{u,d} & 0 \\ 0 & 0 & \lambda''_{u,d} \end{pmatrix}, \quad (292)$$

where  $U_\omega$  is the trimaximal flavor mixing pattern given in Eq. (103). The diagonalization of  $M_u$  and  $M_d$  in Eq. (292) leads us to the trivial CKM quark flavor mixing matrix  $V = U_\omega^\dagger U_\omega = I$ . It is therefore necessary to introduce some further symmetry breaking effects in order to produce three small quark flavor mixing angles and CP violation [809]. We do not go into detail, but refer the reader to a few comprehensive review articles in this connection [143, 144, 145, 146].

A more realistic  $A_4$  extension of the SM, which contains several flavon fields, has been proposed to interpret the observed fermion mass spectra and flavor mixing patterns [812]. In this model the fermion fields  $\ell_L$ ,  $Q_L$ ,  $E_R$  and  $D_R$  are all assigned to the three-dimensional representation  $\underline{\mathbf{3}}$  of  $A_4$ , but the three component fields of  $U_R$  are placed in  $\underline{\mathbf{1}}$ ,  $\underline{\mathbf{1}}''$  and  $\underline{\mathbf{1}}'$  of  $A_4$ , respectively. The SM Higgs doublet  $H$  is assigned to  $\underline{\mathbf{1}}$  of  $A_4$ , and the two flavon fields  $\varphi_u$  and  $\varphi_d$  glued to the up- and down-type quark sectors by the corresponding  $Z_2$  symmetries are assigned to  $\underline{\mathbf{3}}$  of  $A_4$ . The particle content and representation assignments of  $A_4$  and  $Z_2$  associated with the charged-fermion sector of this model are briefly summarized in Table 16. Such assignments, together with the requirement that the charged-lepton and down-type quark fields couple to the same Higgs and flavon fields, allow us to write down the following effective Yukawa-interaction Lagrangian for quarks and charged leptons [812]<sup>37</sup>:

$$-\mathcal{L}_Y = \frac{(Y_d)_{\alpha\alpha'}}{M_*} (\overline{Q}_L D_R)_{\underline{\alpha}} H(\varphi_d)_{\underline{\alpha}'} + \frac{(Y_l)_{\alpha\alpha'}}{M_*} (\overline{\ell}_L E_R)_{\underline{\alpha}} H(\varphi_d)_{\underline{\alpha}'} \\ + \frac{(Y_u)_{\beta\beta'}}{M_*} (\overline{Q}_L \varphi_u)_{\underline{\beta}} \widetilde{H}(U_R)_{\underline{\beta}'} + \text{h.c.}, \quad (293)$$

where the Greek subscripts  $\alpha$  and  $\alpha'$  label the  $A_4$  triplets, while  $\beta$  and  $\beta'$  label the  $A_4$  singlets. Namely,  $\underline{\alpha} = \underline{\mathbf{3}}_S$  or  $\underline{\mathbf{3}}_A$ , and  $\underline{\alpha}' = \underline{\mathbf{3}}$ ; while  $\underline{\beta}$  and  $\underline{\beta}'$  can be  $\underline{\mathbf{1}}$ ,  $\underline{\mathbf{1}}'$  or  $\underline{\mathbf{1}}''$  in such a way that  $\underline{\beta} \otimes \underline{\beta}' = \underline{\mathbf{1}}$

<sup>37</sup>To generate tiny neutrino masses in this model, one needs to introduce two additional flavon fields and upgrade the standard dimension-five Weinberg operator to the flavon case, making it dimension-six [812].

is satisfied. Assuming the flavon multiplets get their vacuum expectation values in an arbitrary direction of  $A_4$ , one is left with  $\langle \varphi_f \rangle \propto (v_1^f, v_2^f, v_3^f)$  for  $f = u, d$  or  $l$ , where  $v_1^f \neq v_2^f \neq v_3^f$  holds. As a result, one may obtain the following textures of charged-lepton and quark mass matrices [812]:

$$M_u = \begin{pmatrix} v_1^u & 0 & 0 \\ 0 & v_2^u & 0 \\ 0 & 0 & v_3^u \end{pmatrix} U_\omega \begin{pmatrix} y_1^u & 0 & 0 \\ 0 & y_{1''}^u & 0 \\ 0 & 0 & y_{1'}^u \end{pmatrix}, \quad M_d = \begin{pmatrix} 0 & \alpha a_d & b_d \\ \alpha b_d & 0 & r a_d \\ a_d & r b_d & 0 \end{pmatrix}, \quad M_l = \begin{pmatrix} 0 & \alpha a_l & b_l \\ \alpha b_l & 0 & r a_l \\ a_l & r b_l & 0 \end{pmatrix} \quad (294)$$

with  $a_f \equiv v_2^f y_{3_S}^f$ ,  $b_f \equiv v_2^f y_{3_A}^f$ ,  $r \equiv v_1^f/v_2^f$  and  $\alpha \equiv v_3^f/v_2^f$  (for  $f = d$  and  $l$ ). Assuming  $r \gg \alpha \sim \mathcal{O}(1)$ ,  $r \gg b_d/a_d$  and  $r \gg b_l/a_l$  for  $M_d$  and  $M_l$ , one may find an approximate mass relation [813]:

$$\frac{m_b}{\sqrt{m_d m_s}} \simeq \frac{m_\tau}{\sqrt{m_e m_\mu}}, \quad (295)$$

which can be regarded as an interesting generalization of the well-known Georgi-Jarlskog mass relations  $m_b = m_\tau$ ,  $m_s = m_\mu/3$  and  $m_d = 3m_e$  at the SU(5) GUT scale [117]. Provided  $v_3^u : v_2^u : v_1^u = 1 : \lambda^2 : \lambda^4$  with  $\lambda \simeq 0.22$  being the Wolfenstein expansion parameter is assumed, then it is possible to understand the mass hierarchy of three up-type quarks. The three quark flavor mixing angles of the CKM matrix  $V$  in this scenario are expected to be  $\vartheta_{12} \sim \mathcal{O}(\lambda)$ ,  $\vartheta_{23} \sim \mathcal{O}(\lambda^2)$  and  $\vartheta_{13} \sim \mathcal{O}(\lambda^4)$ , essentially consistent with current experimental data [812].

It is worth mentioning that the *modular*  $A_4$  and  $S_3$  symmetry groups [814] have recently been applied to the quark sector to understand flavor mixing and CP violation [815, 816, 817, 818, 819]. A remarkable difference of model building based on a finite modular symmetry group from that based on an ordinary non-Abelian discrete flavor symmetry group is that the former allows the Yukawa coupling matrix elements to be expressed in terms of the holomorphic functions of a complex modulus parameter and to transform in a nontrivial way under the modular group. Such a new approach will be briefly introduced in section 7.4.3.

It is also worth remarking that once a certain flavor symmetry is adopted to build a realistic fermion mass model as illustrated above, the number of parameters in the corresponding full theory (including the sector of flavor symmetry breaking) is typically much larger than that in the SM. This ugly aspect is often ignored in today's model-building exercises, in which one pays more attention to those effective parameters in the flavor sector instead of all the parameters of the full theory. A blindingly obvious reason for this situation is that currently available experimental data are so limited that it remains impossible to fully test a new theory beyond the SM, especially in the case that such a theory is not predictive enough. So there is no doubt that we have a long way to go in building fully predictive and testable flavor symmetry models.

## 7. Possible charged-lepton and neutrino flavor textures

### 7.1. Reconstruction of the lepton flavor textures

#### 7.1.1. Charged leptons and Dirac neutrinos

While the up-down parallelism (or similarity) has often been taken as a plausible starting point of view to reconstruct the textures of quark mass matrices from current experimental data or to build a phenomenological quark flavor model based on a kind of underlying flavor symmetry, it is



seldom that the flavor textures of charged leptons and massive neutrinos are treated on the same footing. The most obvious reason for this situation is that there exists a puzzling gap of at least six orders of magnitude between the masses of neutrinos and those of charged leptons, as shown in Fig. 2. In other words, the origin of tiny neutrino masses should be quite different from that of sizable charged-lepton masses, in particular in the case that massive neutrinos have the Majorana nature and thus exist as a new form of matter in nature [820].

That is why one often studies the properties of massive neutrinos by taking the flavor basis where the mass eigenstates of three charged leptons are identical with their flavor eigenstates (i.e., by taking the charged-lepton mass matrix  $M_l$  to be diagonal, real and positive). In this particular basis the neutrino flavor eigenstates ( $\nu_e, \nu_\mu, \nu_\tau$ ) are directly linked to the neutrino mass eigenstates ( $\nu_1, \nu_2, \nu_3$ ) via the PMNS flavor mixing matrix  $U$  in Eq. (2), and thus it is possible to reconstruct the neutrino mass matrix  $M_\nu$  in terms of the parameters of  $U$  and neutrino masses  $m_i$  (for  $i = 1, 2, 3$ ). One may of course follow the opposite way to discuss the properties of charged leptons in the flavor basis where the neutrino mass matrix  $M_\nu$  is diagonal, real and positive, and reconstruct  $M_l$  in terms of the parameters of  $U$  and charged-lepton masses  $m_\alpha$  (for  $\alpha = e, \mu, \tau$ ).

Let us first focus on reconstruction of the Hermitian charged-lepton mass matrix  $M_l$  in the flavor basis of  $M_\nu = D_\nu = \text{Diag}\{m_1, m_2, m_3\}$ , no matter whether massive neutrinos are the Dirac or Majorana particles. As one can see in section 2.1.2, the Hermiticity of  $M_l$  assures the relationship  $M_l = U^\dagger D_l U$  to hold in the chosen flavor basis, which is essentially free from uncertainties coming from the right-handed charged-lepton fields<sup>38</sup>. In this case the nine elements of  $M_l$  can be expressed as follows:

$$(M_l)_{ij} \equiv \langle m \rangle_{ij} = m_e U_{ei}^* U_{ej} + m_\mu U_{\mu i}^* U_{\mu j} + m_\tau U_{\tau i}^* U_{\tau j}, \quad (296)$$

where the Latin subscripts  $i$  and  $j$  run over 1, 2 and 3. With the help of the parametrization of  $U$  advocated in Eq. (2), where the diagonal phase matrix  $P_\nu$  can be neglected for our present purpose, we find that the explicit expressions of  $\langle m \rangle_{ij}$  turn out to be

$$\begin{aligned} \langle m \rangle_{11} &= m_e c_{12}^2 c_{13}^2 + m_\mu \left| s_{12} c_{23} + c_{12} \tilde{s}_{13} s_{23} \right|^2 + m_\tau \left| s_{12} s_{23} - c_{12} \tilde{s}_{13} c_{23} \right|^2, \\ \langle m \rangle_{22} &= m_e s_{12}^2 c_{13}^2 + m_\mu \left| c_{12} c_{23} - s_{12} \tilde{s}_{13} s_{23} \right|^2 + m_\tau \left| c_{12} s_{23} + s_{12} \tilde{s}_{13} c_{23} \right|^2, \\ \langle m \rangle_{33} &= m_e s_{13}^2 + m_\mu c_{13}^2 s_{23}^2 + m_\tau c_{13}^2 c_{23}^2, \\ \langle m \rangle_{12} &= m_e c_{12} s_{12} c_{13}^2 - m_\mu (s_{12} c_{23} + c_{12} \tilde{s}_{13}^* s_{23}) (c_{12} c_{23} - s_{12} \tilde{s}_{13} s_{23}) \\ &\quad - m_\tau (s_{12} s_{23} - c_{12} \tilde{s}_{13}^* c_{23}) (c_{12} s_{23} + s_{12} \tilde{s}_{13} c_{23}), \\ \langle m \rangle_{13} &= m_e c_{12} c_{13} \tilde{s}_{13}^* - m_\mu c_{13} s_{23} (s_{12} c_{23} + c_{12} \tilde{s}_{13}^* s_{23}) + m_\tau c_{13} c_{23} (s_{12} s_{23} - c_{12} \tilde{s}_{13}^* c_{23}), \\ \langle m \rangle_{23} &= m_e s_{12} c_{13} \tilde{s}_{13}^* + m_\mu c_{13} s_{23} (c_{12} c_{23} - s_{12} \tilde{s}_{13}^* s_{23}) - m_\tau c_{13} c_{23} (c_{12} s_{23} + s_{12} \tilde{s}_{13}^* c_{23}), \end{aligned} \quad (297)$$

where  $\tilde{s}_{13} \equiv s_{13} e^{i\delta_\nu}$  is defined for the sake of simplicity. Given the fact that the mass spectrum of three charged leptons is strongly hierarchical (i.e.,  $m_e \ll m_\mu \ll m_\tau$ ) but the pattern of  $U$  is more

<sup>38</sup>Note that the mass eigenvalues of a Hermitian fermion mass matrix are definitely real, but they may not be positive in general. Here we have required  $U M_l U^\dagger = D_l$  with  $m_\alpha$  (for  $\alpha = e, \mu, \tau$ ) being positive and  $U = O_l^\dagger$  being the PMNS matrix in the chosen  $M_\nu = D_\nu$  basis, in order to make an unambiguous reconstruction of  $M_l$  possible.

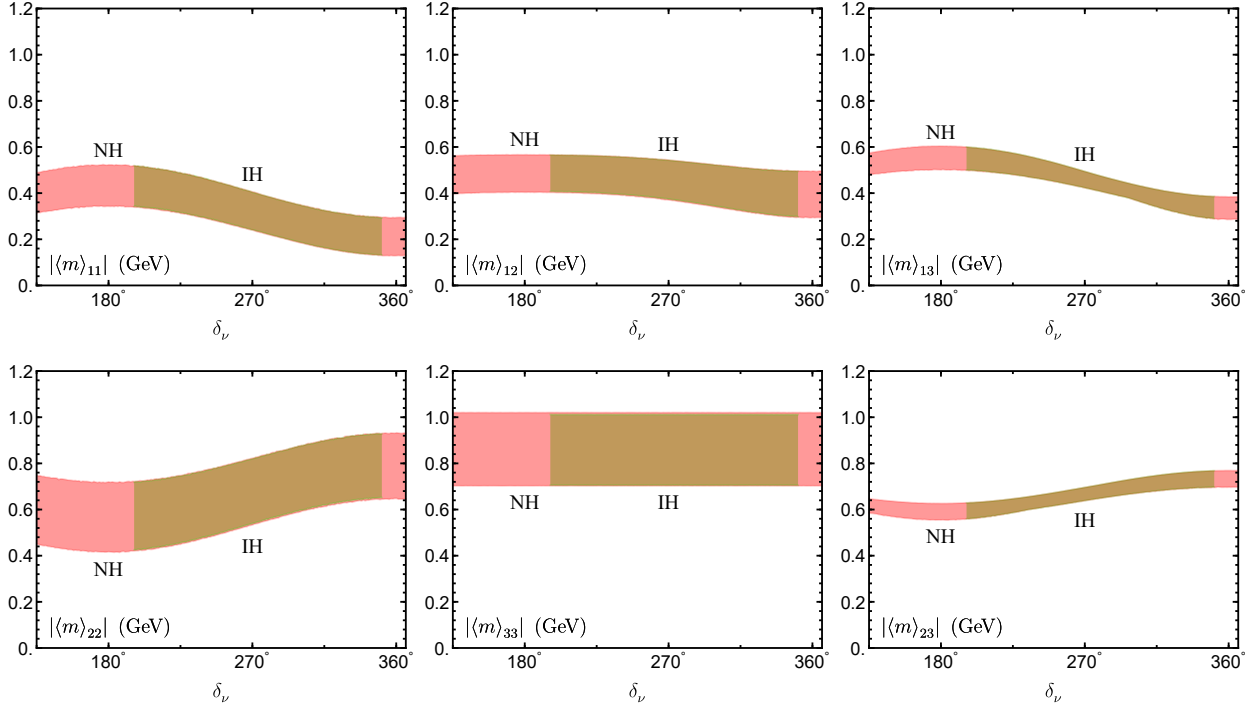

Figure 28: The  $3\sigma$  regions of six independent elements  $|\langle m \rangle_{ij}|$  (for  $i, j = 1, 2, 3$ ) of the Hermitian charged-lepton mass matrix  $M_l$  in the  $M_\nu = D_\nu$  basis, as functions of the CP-violating phase  $\delta_\nu$  in the range  $0.75\pi \leq \delta_\nu \leq 2.03\pi$  (normal neutrino mass hierarchy, or NH for short) or in the range  $1.09\pi \leq \delta_\nu \leq 1.95\pi$  (inverted hierarchy, or IH).

or less anarchical, one naturally expects that the nine elements of  $M_l$  are respectively dominated by the terms proportional to  $m_\tau$  and therefore comparable in magnitude. This observation is supported by Fig. 28 in which the magnitudes of six independent  $\langle m \rangle_{ij}$  are numerically calculated by inputting the values of three charged-lepton masses at  $M_Z$  listed in Table 6 and the  $3\sigma$  ranges of four lepton flavor mixing parameters listed in Table 10. We conclude that  $M_l$  has no texture zeros in the chosen flavor basis, as constrained by current experimental data, but it seems to exhibit an approximate  $2 \leftrightarrow 3$  permutation symmetry. Among all the elements of  $M_l$ , only  $\langle m \rangle_{33}$  is insensitive to the CP-violating phase  $\delta_\nu$ . So an experimental determination of  $\delta_\nu$  in the near future will help fix the texture of  $M_l$  to a much better degree of accuracy.

Let us now reconstruct the Hermitian Dirac neutrino mass matrix  $M_\nu$  in the flavor basis of  $M_l = D_l = \text{Diag}\{m_e, m_\mu, m_\tau\}$ . In this case we concentrate on  $M_\nu = P_l U D_\nu U^\dagger P_l^\dagger$ , which is independent of the Majorana phases of  $U$ . But let us keep the diagonal phase matrix  $P_l = \text{Diag}\{e^{i\phi_e}, e^{i\phi_\mu}, e^{i\phi_\tau}\}$ . Although  $P_l$  does not have any physical meaning, it will be helpful for discussing the  $\mu$ - $\tau$  reflection symmetry of  $M_\nu$ . The nine elements of  $M_\nu$  can then be written as

$$(M_\nu)_{\alpha\beta} \equiv \langle m \rangle_{\alpha\beta} = \left[ m_1 U_{\alpha 1} U_{\beta 1}^* + m_2 U_{\alpha 2} U_{\beta 2}^* + m_3 U_{\alpha 3} U_{\beta 3}^* \right] e^{i(\phi_\alpha - \phi_\beta)}, \quad (298)$$

where the Greek subscripts  $\alpha$  and  $\beta$  run over  $e, \mu$  and  $\tau$ . Given the standard parametrization of the PMNS matrix  $U$  in Eq. (2) with the Majorana phase matrix  $P_\nu$  being irrelevant in the present case,

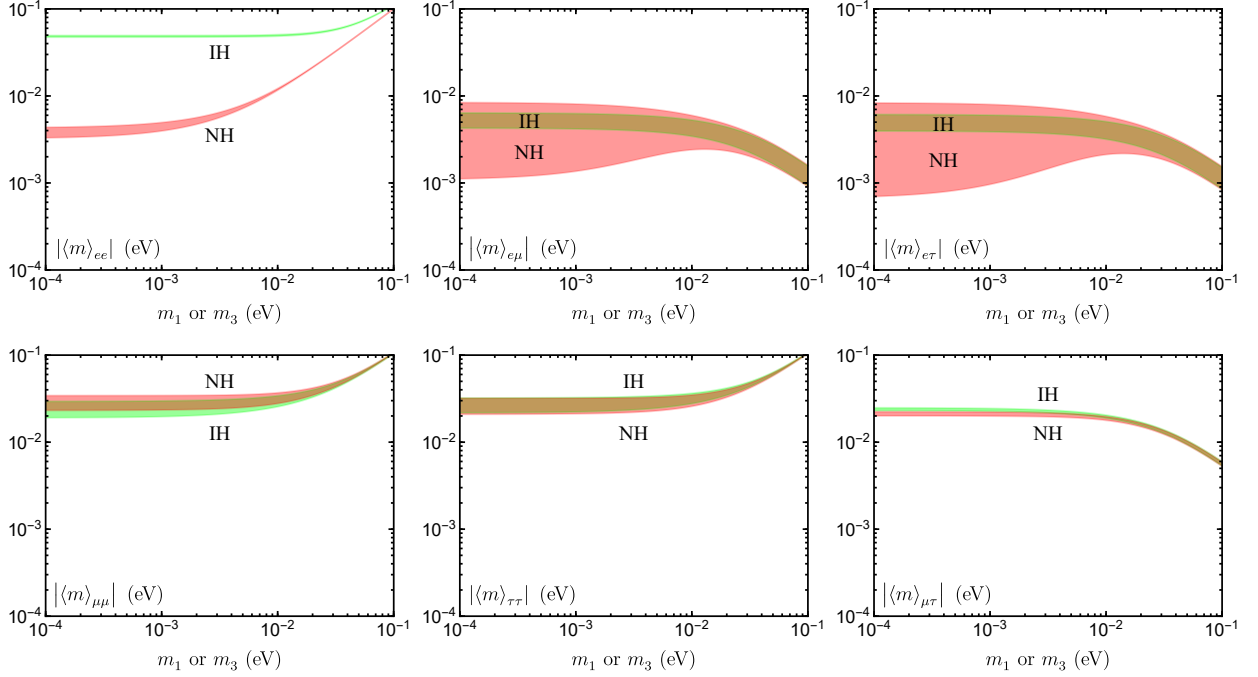

Figure 29: The  $3\sigma$  ranges of six independent elements  $|\langle m \rangle_{\alpha\beta}|$  (for  $\alpha, \beta = e, \mu, \tau$ ) of the Hermitian Dirac neutrino mass matrix  $M_\nu$  in the  $M_l = D_l$  basis, as functions of the smallest neutrino mass  $m_1$  in the normal neutrino mass hierarchy (NH) case or of  $m_3$  in the inverted hierarchy (IH) case.

we explicitly obtain the expressions

$$\begin{aligned}
\langle m \rangle_{ee} &= m_1 c_{12}^2 c_{13}^2 + m_2 s_{12}^2 c_{13}^2 + m_3 s_{13}^2, \\
\langle m \rangle_{\mu\mu} &= m_1 |s_{12} c_{23} + c_{12} \tilde{s}_{13} s_{23}|^2 + m_2 |c_{12} c_{23} - s_{12} \tilde{s}_{13} s_{23}|^2 + m_3 c_{13}^2 s_{23}^2, \\
\langle m \rangle_{\tau\tau} &= m_1 |s_{12} s_{23} - c_{12} \tilde{s}_{13} c_{23}|^2 + m_2 |c_{12} s_{23} + s_{12} \tilde{s}_{13} c_{23}|^2 + m_3 c_{13}^2 c_{23}^2, \\
\langle m \rangle_{e\mu} &= [-m_1 c_{12} c_{13} (s_{12} c_{23} + c_{12} \tilde{s}_{13}^* s_{23}) + m_2 s_{12} c_{13} (c_{12} c_{23} - s_{12} \tilde{s}_{13}^* s_{23}) + m_3 c_{13} \tilde{s}_{13}^* s_{23}] e^{i(\phi_e - \phi_\mu)}, \\
\langle m \rangle_{e\tau} &= [m_1 c_{12} c_{13} (s_{12} s_{23} - c_{12} \tilde{s}_{13}^* c_{23}) - m_2 s_{12} c_{13} (c_{12} s_{23} + s_{12} \tilde{s}_{13}^* c_{23}) + m_3 c_{13} \tilde{s}_{13}^* c_{23}] e^{i(\phi_e - \phi_\tau)}, \\
\langle m \rangle_{\mu\tau} &= [-m_1 (s_{12} c_{23} + c_{12} \tilde{s}_{13} s_{23}) (s_{12} s_{23} - c_{12} \tilde{s}_{13}^* c_{23}) - m_2 (c_{12} c_{23} - s_{12} \tilde{s}_{13} s_{23}) (c_{12} s_{23} + s_{12} \tilde{s}_{13}^* c_{23}) \\
&\quad + m_3 c_{13}^2 c_{23} s_{23}] e^{i(\phi_\mu - \phi_\tau)}. \tag{299}
\end{aligned}$$

Taking account of the  $3\sigma$  ranges of two neutrino mass-squared differences and four neutrino mixing parameters listed in Tables 9 and 10, we illustrate the magnitudes of six independent  $\langle m \rangle_{\alpha\beta}$  as functions of  $m_1$  (normal neutrino mass hierarchy) or  $m_3$  (inverted hierarchy) in Fig. 29. It is obvious that the elements of  $M_\nu$  exhibit an approximate  $\mu$ - $\tau$  symmetry<sup>39</sup>.

<sup>39</sup>Note that in most of the literature the  $\nu_\mu$ - $\nu_\tau$  permutation symmetry has been referred to as the  $\mu$ - $\tau$  permutation symmetry for the sake of simplicity. Here we follow this common but inexact wording, but one should keep in mind that it does not mean any actual permutation symmetry between charged muon and tau.

The approximate  $\mu$ - $\tau$  symmetry of  $M_\nu$  is closely associated with the fact of  $\theta_{23} \simeq \pi/4$  and  $\delta_\nu \sim 3\pi/2$  indicated by current neutrino oscillation data, as discussed in section 3.4.2. One may actually derive  $\theta_{23} = \pi/4$  and  $\delta_\nu = 3\pi/2$ , together with  $2\phi_e - \phi_\mu - \phi_\tau = \pi$ , from the Dirac neutrino mass matrix if it has the following texture:

$$M_\nu = \begin{pmatrix} \langle m \rangle_{ee} & \langle m \rangle_{e\mu} & \langle m \rangle_{e\mu}^* \\ \langle m \rangle_{\mu e} & \langle m \rangle_{\mu\mu} & \langle m \rangle_{\mu\tau} \\ \langle m \rangle_{\mu e}^* & \langle m \rangle_{\mu\tau}^* & \langle m \rangle_{\mu\mu}^* \end{pmatrix}, \quad (300)$$

where  $\langle m \rangle_{ee}$  is real and the other four parameters are in general complex. Such a special form of  $M_\nu$  can be obtained from requiring the Dirac neutrino mass term in Eq. (13) to be invariant under the following charge-conjugation transformations of left- and right-handed neutrino fields [821]:

$$\begin{aligned} \nu_{eL} &\leftrightarrow (\nu_{eL})^c, & N_{eR} &\leftrightarrow (N_{eR})^c, \\ \nu_{\mu L} &\leftrightarrow (\nu_{\tau L})^c, & N_{\mu R} &\leftrightarrow (N_{\tau R})^c, \\ \nu_{\tau L} &\leftrightarrow (\nu_{\mu L})^c, & N_{\tau R} &\leftrightarrow (N_{\mu R})^c. \end{aligned} \quad (301)$$

This invariance dictates the Dirac neutrino mass matrix  $M_\nu$  to satisfy  $M_\nu = S^{(132)} M_\nu^* S^{(132)}$ , where  $S^{(132)}$  has been given in Eq. (253), and thus it must take the form in Eq. (300). Note that the above  $\nu_\mu$ - $\nu_\tau$  reflection symmetry does not guarantee  $M_\nu$  to be Hermitian. It is therefore necessary to assume  $\langle m \rangle_{\mu e} = \langle m \rangle_{e\mu}^*$  in Eq. (300) so as to make  $M_\nu$  Hermitian and thus compatible with the numerical result shown in Fig. 29.

In the chosen  $M_l = D_l$  basis a systematic analysis of possible zero textures of the Dirac neutrino mass matrix  $M_\nu$  has been done, with or without an assumption of its Hermiticity [822, 823, 824]. Fig. 29 tells us that current experimental data can rule out all the possible zero textures of Hermitian  $M_\nu$  in the chosen basis, at least at the  $3\sigma$  level. Note, however, that this observation is subject to the choice of  $M_\nu = P_l U D_\nu U^\dagger P_l^\dagger$ . If one allows the eigenvalues of  $M_\nu$  to be negative, then it remains possible to have one or two texture zeros [823]. Since a non-Hermitian texture of  $M_\nu$  usually involves more free parameters, it is phenomenologically allowed to contain one or more vanishing entries. But in this case the non-Hermitian texture of  $M_\nu$  is also likely to be converted to a Hermitian form after a proper basis transformation is made, as what we have discussed for quark mass matrices in section 6.3.1.

Let us remark that the diagonal  $M_\nu = D_\nu$  basis for discussing possible textures of the charge-lepton mass matrix  $M_l$  or the diagonal  $M_l = D_l$  basis for exploring possible structures of the Dirac neutrino mass matrix  $M_\nu$  are just two special cases. In general, both  $M_l$  and  $M_\nu$  are expected to be non-diagonal, and hence the PMNS lepton flavor mixing matrix  $U = O_l^\dagger O_\nu$  should contain both the contribution from  $M_l$  via  $O_l^\dagger M_l O_l' = D_l$  and that from  $M_\nu$  through  $O_\nu^\dagger M_\nu O_\nu' = D_\nu$ . Although the textures of  $M_l$  and  $M_\nu$  have no reason to be parallel [825], it is always possible to assume them to share a common zero texture such as the well-known Fritzsch texture [135]. It is actually easy to show that the six-zero textures of Hermitian  $M_l$  and  $M_\nu$ ,

$$M_l = \begin{pmatrix} 0 & C_l & 0 \\ C_l^* & 0 & B_l \\ 0 & B_l^* & A_l \end{pmatrix}, \quad M_\nu = \begin{pmatrix} 0 & C_\nu & 0 \\ C_\nu^* & 0 & B_\nu \\ 0 & B_\nu^* & A_\nu \end{pmatrix}, \quad (302)$$

can essentially fit current neutrino oscillation data, but it only allows for a normal neutrino mass ordering and  $\theta_{23} < 45^\circ$  [447, 448]. This situation will change if the Hermiticity of  $M_l$  and  $M_\nu$  is given up but their texture zeros keep unchanged [826], with the cost of more free parameters or less predictability. In comparison, the four-zero textures of Hermitian lepton mass matrices,

$$M_l = \begin{pmatrix} 0 & C_l & 0 \\ C_l^* & B_l' & B_l \\ 0 & B_l^* & A_l \end{pmatrix}, \quad M_\nu = \begin{pmatrix} 0 & C_\nu & 0 \\ C_\nu^* & B_\nu' & B_\nu \\ 0 & B_\nu^* & A_\nu \end{pmatrix}, \quad (303)$$

are found to be completely consistent with current experimental data [783, 827, 828, 829, 830].

Finally, we reemphasize that it is very difficult to understand why the Yukawa couplings of three Dirac neutrinos are (more than) six orders of magnitude smaller than those of three charged leptons, if they acquire their masses in the same way as in the SM. In this regard it has been shown that a relatively natural generation of tiny Dirac neutrino masses is not impossible in some models involving extra spacial dimensions [470, 831, 832, 833, 834], supersymmetry or stringy symmetries [210, 835, 836, 837, 838], radiative mechanisms [220, 839, 840, 841, 842, 843, 844] or some flavor symmetries [845, 846, 847, 848, 849, 850, 851, 852]. That is why some attention has been paid to massive Dirac neutrinos and their phenomenological consequences. Nevertheless, more theoretical and experimental attention has been paid to the possibility that massive neutrinos may have the Majorana nature. So we are going to focus on possible flavor textures of Majorana neutrinos and explore their much richer phenomenological consequences, especially in the aspect of lepton number violation.

### 7.1.2. The Majorana neutrino mass matrix

Given the Majorana nature of three light massive neutrinos, their effective mass matrix  $M_\nu$  can be fully reconstructed in terms of three neutrino masses, three flavor mixing angles and three CP-violating phases in the flavor basis of  $M_l = D_l$ . To be explicit,  $M_\nu = P_l U D_\nu U^T P_l^T$  holds in this special basis, where  $P_l = \text{Diag}\{e^{i\phi_e}, e^{i\phi_\mu}, e^{i\phi_\tau}\}$  has no physical meaning but it will be helpful for the discussion about the  $\mu$ - $\tau$  reflection symmetry. Six independent elements of the symmetric Majorana neutrino mass matrix  $M_\nu$  can then be expressed as follows:

$$(M_\nu)_{\alpha\beta} \equiv \langle m \rangle_{\alpha\beta} = \left[ m_1 U_{\alpha 1} U_{\beta 1} + m_2 U_{\alpha 2} U_{\beta 2} + m_3 U_{\alpha 3} U_{\beta 3} \right] e^{i(\phi_\alpha + \phi_\beta)}, \quad (304)$$

where  $\alpha$  and  $\beta$  run over  $e$ ,  $\mu$  and  $\tau$ . With the help of the standard parametrization of  $U$  in Eq. (2), it is straightforward for us to arrive at

$$\begin{aligned} \langle m \rangle_{ee} &= \left[ \bar{m}_1 c_{12}^2 c_{13}^2 + \bar{m}_2 s_{12}^2 c_{13}^2 + m_3 \tilde{s}_{13}^{*2} \right] e^{i2\phi_e}, \\ \langle m \rangle_{\mu\mu} &= \left[ \bar{m}_1 (s_{12} c_{23} + c_{12} \tilde{s}_{13} s_{23})^2 + \bar{m}_2 (c_{12} c_{23} - s_{12} \tilde{s}_{13} s_{23})^2 + m_3 c_{13}^2 s_{23}^2 \right] e^{i2\phi_\mu}, \\ \langle m \rangle_{\tau\tau} &= \left[ \bar{m}_1 (s_{12} s_{23} - c_{12} \tilde{s}_{13} c_{23})^2 + \bar{m}_2 (c_{12} s_{23} + s_{12} \tilde{s}_{13} c_{23})^2 + m_3 c_{13}^2 c_{23}^2 \right] e^{i2\phi_\tau}, \\ \langle m \rangle_{e\mu} &= \left[ -\bar{m}_1 c_{12} c_{13} (s_{12} c_{23} + c_{12} \tilde{s}_{13} s_{23}) + \bar{m}_2 s_{12} c_{13} (c_{12} c_{23} - s_{12} \tilde{s}_{13} s_{23}) + m_3 c_{13} \tilde{s}_{13}^* s_{23} \right] e^{i(\phi_e + \phi_\mu)}, \\ \langle m \rangle_{e\tau} &= \left[ \bar{m}_1 c_{12} c_{13} (s_{12} s_{23} - c_{12} \tilde{s}_{13} c_{23}) - \bar{m}_2 s_{12} c_{13} (c_{12} s_{23} + s_{12} \tilde{s}_{13} c_{23}) + m_3 c_{13} \tilde{s}_{13}^* c_{23} \right] e^{i(\phi_e + \phi_\tau)}, \\ \langle m \rangle_{\mu\tau} &= \left[ -\bar{m}_1 (s_{12} c_{23} + c_{12} \tilde{s}_{13} s_{23}) (s_{12} s_{23} - c_{12} \tilde{s}_{13} c_{23}) - \bar{m}_2 (c_{12} c_{23} - s_{12} \tilde{s}_{13} s_{23}) (c_{12} s_{23} + s_{12} \tilde{s}_{13} c_{23}) \right. \\ &\quad \left. + m_3 c_{13}^2 c_{23} s_{23} \right] e^{i(\phi_\mu + \phi_\tau)}, \end{aligned} \quad (305)$$

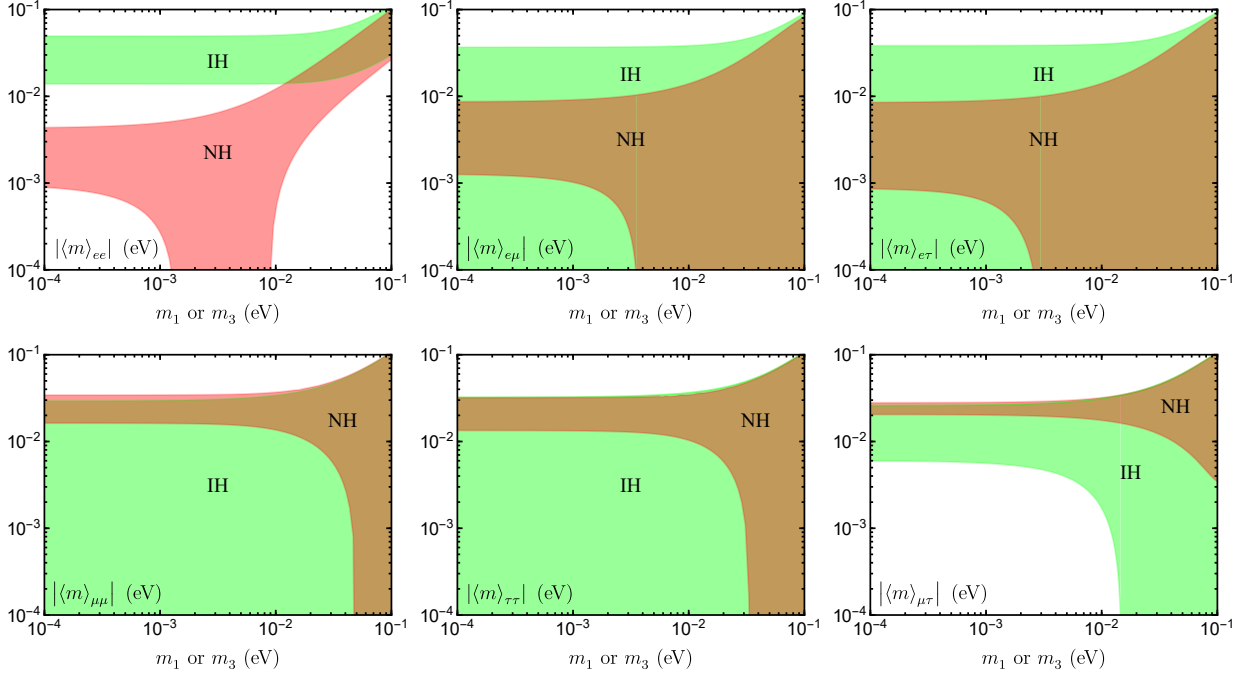

Figure 30: The  $3\sigma$  ranges of six independent elements  $|\langle m \rangle_{\alpha\beta}|$  (for  $\alpha, \beta = e, \mu, \tau$ ) of the Majorana neutrino mass matrix  $M_\nu$  in the  $M_I = D_I$  basis, as functions of the smallest neutrino mass  $m_1$  in the normal hierarchy (NH) case or of the smallest neutrino mass  $m_3$  in the inverted hierarchy (IH) case.

in which  $\bar{m}_1 \equiv m_1 e^{2i\rho}$  and  $\bar{m}_2 \equiv m_2 e^{2i\sigma}$ , together with  $\tilde{s}_{13} \equiv s_{13} e^{i\delta_\nu}$ , have been defined for simplicity. Inputting the  $3\sigma$  ranges of  $\Delta m_{21}^2$ ,  $\Delta m_{31}^2$ ,  $\theta_{12}$ ,  $\theta_{13}$ ,  $\theta_{23}$  and  $\delta_\nu$  listed in Tables 9 and 10, and allowing  $\rho$  and  $\sigma$  to vary between 0 and  $\pi$ , we plot the numerical profiles of  $|\langle m \rangle_{\alpha\beta}|$  as functions of  $m_1$  or  $m_3$  in Fig. 30, where the normal and inverted neutrino mass hierarchies are both taken into account. Two immediate comments on the results in Fig. 30 are in order.

- If the neutrino mass spectrum is normal and the absolute neutrino mass scale is of  $\mathcal{O}(0.1)$  eV or below, then the matrix element  $\langle m \rangle_{\mu\tau}$  is definitely nonzero, but one or more of the other five elements of  $M_\nu$  are possible to vanish. This observation is essentially understandable from Eq. (305) in the  $\theta_{13} \rightarrow 0$  limit, because a vanishingly small  $\langle m \rangle_{\alpha\beta}$  implies an almost complete cancellation between the terms associated with  $\bar{m}_{1,2}$  and the one proportional to  $m_3$ . In the case of an inverted neutrino mass ordering, the matrix element  $\langle m \rangle_{ee}$  is definitely nonzero because  $m_1 \sim m_2 > m_3$ ,  $\theta_{12} \neq \pi/4$  and the smallness of  $\theta_{13}$  guarantee that a complete cancellation between the two dominant components of  $\langle m \rangle_{ee}$  can never happen. But one or more of the other five elements of  $M_\nu$  are likely to be vanishing or vanishingly small if the value of  $m_1$  lies around  $\mathcal{O}(0.1)$  eV or below.
- No matter whether the neutrino mass spectrum is normal or inverted, the magnitudes of some elements of  $M_\nu$  exhibit an approximate  $\mu$ - $\tau$  permutation symmetry, such as  $|\langle m \rangle_{e\mu}| \simeq |\langle m \rangle_{e\tau}|$  and  $|\langle m \rangle_{\mu\mu}| \simeq |\langle m \rangle_{\tau\tau}|$  [853]. This observation can also be understood from Eq. (305) after

$\theta_{23} \sim \pi/4$  and  $\delta_\nu \sim 3\pi/2$  are taken into consideration. In this connection an immediate conjecture is that there should exist a kind of  $\mu$ - $\tau$  reflection symmetry for the Majorana neutrino mass matrix  $M_\nu$ , and it should be the simplest flavor symmetry in the neutrino sector which is behind the observed pattern of lepton flavor mixing [440].

We conclude that the profiles of  $|\langle m \rangle_{\alpha\beta}|$  shown in Fig. 30 are helpful for us to either explore an underlying flavor symmetry of  $M_\nu$ , or study some zero textures of  $M_\nu$  in the chosen flavor basis. For example, the well-known Fritzsche texture is definitely disfavored for  $M_\nu$  in the inverted neutrino mass ordering, simply because  $\langle m \rangle_{ee} = 0$  has been ruled out in this case.

The  $3 \times 3$  Majorana neutrino mass matrix  $M_\nu$  with an exact  $\mu$ - $\tau$  reflection symmetry is of the following form [439, 468, 516, 743, 854, 855]:

$$M_\nu = \begin{pmatrix} \langle m \rangle_{ee} & \langle m \rangle_{e\mu} & \langle m \rangle_{e\mu}^* \\ \langle m \rangle_{e\mu} & \langle m \rangle_{\mu\mu} & \langle m \rangle_{\mu\tau} \\ \langle m \rangle_{e\mu}^* & \langle m \rangle_{\mu\tau} & \langle m \rangle_{\mu\mu}^* \end{pmatrix}, \quad (306)$$

where  $\langle m \rangle_{ee}^* = \langle m \rangle_{ee}$  and  $\langle m \rangle_{\mu\tau}^* = \langle m \rangle_{\mu\tau}$  hold, and the other elements are in general complex. This sort of texture of  $M_\nu$  can be obtained from requiring the effective Majorana neutrino mass term in Eq. (16) to be invariant under the charge-conjugation transformations of three left-handed neutrino fields:  $\nu_{eL} \leftrightarrow (\nu_{eL})^c$ ,  $\nu_{\mu L} \leftrightarrow (\nu_{\tau L})^c$  and  $\nu_{\tau L} \leftrightarrow (\nu_{\mu L})^c$ . A comparison between Eqs. (305) and (306) immediately leads us to

$$\theta_{23} = \frac{\pi}{4}, \quad \delta_\nu = \frac{\pi}{2} \text{ or } \frac{3\pi}{2}, \quad \rho = 0 \text{ or } \frac{\pi}{2}, \quad \sigma = 0 \text{ or } \frac{\pi}{2}, \quad (307)$$

together with  $\phi_e = \pi/2$  and  $\phi_\mu + \phi_\tau = 0$  [856, 857]. It becomes clear that the presence of  $\phi_e$ ,  $\phi_\mu$  and  $\phi_\tau$  is necessary so as to make the texture of  $M_\nu$  under the  $\mu$ - $\tau$  reflection symmetry consistent with the standard parametrization of the PMNS matrix  $U$ .

Of course, the exact  $\mu$ - $\tau$  reflection symmetry of  $M_\nu$  can always be embedded into a much larger flavor symmetry group in building a more realistic neutrino mass model [440]. It must be broken in a proper way, such that the resultant flavor mixing angles and CP-violating phases can fit current experimental data to a much better degree of accuracy. Several possibilities of breaking this empirical flavor symmetry have been discussed in the literature (see Ref. [440] for a recent review), and a typical example of this kind will be described in section 7.1.3.

It is certainly unnecessary to ascribe all the lepton flavor mixing effects to the neutrino sector, no matter whether the Majorana neutrino mass matrix  $M_\nu$  originates from a seesaw mechanism or not. It has been shown that the Fritzsche texture of  $M_\nu$  can be obtained from the canonical seesaw mechanism if the Dirac neutrino mass matrix  $M_D$  and the right-handed Majorana neutrino mass matrix  $M_R$  are of the same Fritzsche form and have a kind of parameter correlation (see section 7.2.2 for some explicit discussions) [630, 858], and thus one may arrive at the six-zero textures of Hermitian  $M_l$  and symmetric  $M_\nu$  at low energies,

$$M_l = \begin{pmatrix} 0 & C_l & 0 \\ C_l^* & 0 & B_l \\ 0 & B_l^* & A_l \end{pmatrix}, \quad M_\nu = \begin{pmatrix} 0 & C_\nu & 0 \\ C_\nu & 0 & B_\nu \\ 0 & B_\nu & A_\nu \end{pmatrix}, \quad (308)$$

which are essentially compatible with current neutrino oscillation data. If the four-zero textures of Hermitian  $M_l$  and symmetric  $M_\nu$  are taken into account, one will be left with more free parameters to fit the experimental data [137]. Since the textures of  $M_l$  and  $M_\nu$  are parallel, the strong mass hierarchy of three charged leptons implies that their contributions to lepton flavor mixing should be suppressed to some extent as compared with the neutrino sector. From the point of view of model building, the specific textures of  $M_l$  and  $M_\nu$  should be determined from proper flavor symmetries. In this case the arbitrariness of choosing the flavor basis for  $M_l$  and  $M_\nu$  might be under control.

### 7.1.3. Breaking of $\mu$ - $\tau$ reflection symmetry

The exact  $\mu$ - $\tau$  reflection symmetry of  $M_\nu$  must be broken to some extent, such that the observed deviation of  $\theta_{23}$  from  $\pi/4$  and that of  $\delta_\nu$  from  $3\pi/2$  can be explained. There are several ways to explicitly break this simple flavor symmetry, of course. Given the Majorana neutrino mass matrix in Eq. (306), for example, its  $\mu$ - $\tau$  reflection symmetry can be broken by introducing an imaginary correction to  $\langle m \rangle_{ee}$  and (or)  $\langle m \rangle_{\mu\tau}$ , by introducing different perturbations to  $\langle m \rangle_{e\mu}$  and  $\langle m \rangle_{e\tau}$ , or by introducing different corrections to  $\langle m \rangle_{\mu\mu}$  and  $\langle m \rangle_{\tau\tau}$ . Then one will be left with  $\text{Im}\langle m \rangle_{ee} \neq 0$  and (or)  $\text{Im}\langle m \rangle_{\mu\tau} \neq 0$ ,  $\langle m \rangle_{e\tau} \neq \langle m \rangle_{e\mu}^*$ , or  $\langle m \rangle_{\tau\tau} \neq \langle m \rangle_{\mu\mu}^*$ , respectively [439, 440, 446, 516, 743, 806, 854, 859, 860, 861, 862, 863, 864, 865, 866, 867, 868]. As a consequence, the results in Eq. (307) will be slightly modified. But the explicit breaking of a flavor symmetry is quite ad hoc, and hence it often poses a challenge to those realistic model-building exercises.

Now that an underlying flavor symmetry of  $M_\nu$  is usually expected to show up at a superhigh energy scale  $\Lambda$ , such as the seesaw scale  $\Lambda_{\text{SS}}$ , it makes sense to consider the RGE-induced corrections to  $M_\nu$  at the electroweak scale  $\Lambda_{\text{EW}}$ . That is to say, the flavor symmetry will automatically be broken due to the quantum effects when  $M_\nu$  runs from  $\Lambda$  down to  $\Lambda_{\text{EW}}$  via the one-loop RGEs. As far as the  $\mu$ - $\tau$  reflection symmetry is concerned, one has to figure out whether the RGE-triggered symmetry breaking evolves in the *right* direction so as to bring  $\theta_{23}$  to the right octant and  $\delta_\nu$  to the right quadrant at low energies [857, 869]. Of course, the “right” octant of  $\theta_{23}$  and the “right” quadrant of  $\delta_\nu$ , as indicated by the present best-fit values of  $\theta_{23}$  and  $\delta_\nu$ , remain rather preliminary, and they are even likely to “fluctuate” around their respective  $\mu$ - $\tau$  reflection symmetry limits (i.e.,  $\pi/4$  and  $3\pi/2$ ) in the coming years before sufficiently accurate data on these two fundamental flavor parameters are achieved from the ongoing and upcoming long-baseline neutrino oscillation experiments. In any case it is necessary to study the running behavior of  $M_\nu$  with energy scales and examine the corresponding effects of  $\mu$ - $\tau$  reflection symmetry breaking.

Let us first consider the Majorana neutrino mass matrix  $M_\nu$  with the  $\mu$ - $\tau$  reflection symmetry in the  $M_l = D_l$  basis, as shown in Eq. (306), in the framework of the MSSM. Assuming this flavor symmetry to be realized at a superhigh energy scale  $\Lambda_{\mu\tau}$  and taking account of  $M_\nu = \kappa(v \sin \beta)^2/2$  in the MSSM, where the one-loop RGE of  $\kappa$  has been given in Eq. (165), we obtain the renormalized texture of  $M_\nu$  at the electroweak scale as follows [137, 870]:

$$M_\nu(\Lambda_{\text{EW}}) = I_0^2 \left[ T_l \cdot M_\nu(\Lambda_{\mu\tau}) \cdot T_l \right], \quad (309)$$

where  $T_l \equiv \text{Diag}\{I_e, I_\mu, I_\tau\}$  with the leptonic evolution functions  $I_\alpha$  (for  $\alpha = e, \mu, \tau$ ) being defined as in Eq. (183), and the overall evolution function  $I_0$  is defined by

$$I_0 = \exp \left[ -\frac{1}{32\pi^2} \int_0^{\ln(\Lambda_{\mu\tau}/\Lambda_{\text{EW}})} \alpha_\kappa(t) dt \right], \quad (310)$$



where  $\alpha_k$  has been given in Eq. (167). Note that  $I_e \simeq I_\mu \simeq 1$  holds to an excellent degree of accuracy as a consequence of the tininess of  $y_e^2$  and  $y_\mu^2$ ; and

$$\Delta_\tau \equiv 1 - I_\tau \simeq \frac{1}{16\pi^2} \int_0^{\ln(\Lambda_{\mu\tau}/\Lambda_{\text{EW}})} y_\tau^2(t) dt \quad (311)$$

is also quite small, of  $O(10^{-2})$  or smaller in most cases, because  $I_\tau$  is very close to one as shown in Fig. 24. But it is found that  $\Delta_\tau$  may affect the running behaviors of some lepton flavor mixing parameters in an appreciable way. To be explicit, we obtain

$$M_\nu(\Lambda_{\text{EW}}) \simeq I_0^2 \left[ \begin{pmatrix} \langle m \rangle_{ee} & \langle m \rangle_{e\mu} & \langle m \rangle_{e\mu}^* \\ \langle m \rangle_{e\mu} & \langle m \rangle_{\mu\mu} & \langle m \rangle_{\mu\tau} \\ \langle m \rangle_{e\mu}^* & \langle m \rangle_{\mu\tau} & \langle m \rangle_{\mu\mu}^* \end{pmatrix} - \Delta_\tau \begin{pmatrix} 0 & 0 & \langle m \rangle_{e\mu}^* \\ 0 & 0 & \langle m \rangle_{\mu\tau} \\ \langle m \rangle_{e\mu}^* & \langle m \rangle_{\mu\tau} & 2\langle m \rangle_{\mu\mu}^* \end{pmatrix} \right], \quad (312)$$

from which one can see how the  $\mu$ - $\tau$  reflection symmetry at  $\Lambda_{\mu\tau}$  is broken at  $\Lambda_{\text{EW}}$  thanks to the tau-dominated RGE running effects [440].

Since the charged-lepton mass matrix  $M_l = D_l$  keeps diagonal in the one-loop RGE evolution, one may simply diagonalize the Majorana neutrino mass matrix  $M_\nu$  at  $\Lambda_{\text{EW}}$  to obtain three neutrino masses, three flavor mixing angles and three CP-violating phases. Let us define  $\Delta\theta_{ij} \equiv \theta_{ij}(\Lambda_{\text{EW}}) - \theta_{ij}(\Lambda_{\mu\tau})$  (for  $ij = 12, 13, 23$ ),  $\Delta\delta_\nu \equiv \delta_\nu(\Lambda_{\text{EW}}) - \delta_\nu(\Lambda_{\mu\tau})$ ,  $\Delta\rho \equiv \rho(\Lambda_{\text{EW}}) - \rho(\Lambda_{\mu\tau})$  and  $\Delta\sigma \equiv \sigma(\Lambda_{\text{EW}}) - \sigma(\Lambda_{\mu\tau})$  to measure the RGE-induced corrections to the parameters of  $U$ . After a lengthy calculation, the three neutrino masses at  $\Lambda_{\text{EW}}$  are found to be

$$\begin{aligned} m_1(\Lambda_{\text{EW}}) &\simeq I_0^2 \left[ 1 - \Delta_\tau \left( 1 - c_{12}^2 c_{13}^2 \right) \right] m_1(\Lambda_{\mu\tau}), \\ m_2(\Lambda_{\text{EW}}) &\simeq I_0^2 \left[ 1 - \Delta_\tau \left( 1 - s_{12}^2 c_{13}^2 \right) \right] m_2(\Lambda_{\mu\tau}), \\ m_3(\Lambda_{\text{EW}}) &\simeq I_0^2 \left[ 1 - \Delta_\tau c_{13}^2 \right] m_3(\Lambda_{\mu\tau}). \end{aligned} \quad (313)$$

In a reasonable analytical approximation we also arrive at [857, 856, 871]

$$\begin{aligned} \Delta\theta_{12} &\simeq \frac{\Delta_\tau}{2} c_{12} s_{12} \left[ s_{13}^2 \left( \zeta_{31}^{\eta_\rho} - \zeta_{32}^{\eta_\rho} \right) + c_{13}^2 \zeta_{21}^{-\eta_\rho \eta_\sigma} \right], \\ \Delta\theta_{13} &\simeq \frac{\Delta_\tau}{2} c_{13} s_{13} \left( c_{12}^2 \zeta_{31}^{\eta_\rho} + s_{12}^2 \zeta_{32}^{\eta_\rho} \right), \\ \Delta\theta_{23} &\simeq \frac{\Delta_\tau}{2} \left( s_{12}^2 \zeta_{31}^{-\eta_\rho} + c_{12}^2 \zeta_{32}^{-\eta_\rho} \right) \end{aligned} \quad (314)$$

for the differences of three flavor mixing angles between  $\Lambda_{\text{EW}}$  and  $\Lambda_{\mu\tau}$ ; and

$$\begin{aligned} \Delta\delta_\nu &\simeq \frac{\Delta_\tau}{2} \left[ \frac{c_{12} s_{12}}{s_{13}} \left( \zeta_{32}^{-\eta_\sigma} - \zeta_{31}^{-\eta_\sigma} \right) - \frac{s_{13}}{c_{12} s_{12}} \left( c_{12}^4 \zeta_{32}^{-\eta_\sigma} - s_{12}^4 \zeta_{31}^{-\eta_\sigma} + \zeta_{21}^{\eta_\rho \eta_\sigma} \right) \right], \\ \Delta\rho &\simeq \Delta_\tau \frac{c_{12} s_{13}}{s_{12}} \left[ s_{12}^2 \left( \zeta_{31}^{-\eta_\rho} - \zeta_{32}^{-\eta_\rho} \right) + \frac{1}{2} \left( \zeta_{32}^{-\eta_\sigma} + \zeta_{21}^{\eta_\rho \eta_\sigma} \right) \right], \\ \Delta\sigma &\simeq \Delta_\tau \frac{s_{12} s_{13}}{2c_{12}} \left[ s_{12}^2 \left( \zeta_{21}^{\eta_\rho \eta_\sigma} - \zeta_{31}^{-\eta_\rho} \right) - c_{12}^2 \left( 2\zeta_{32}^{-\eta_\sigma} - \zeta_{31}^{-\eta_\rho} - \zeta_{21}^{\eta_\rho \eta_\sigma} \right) \right] \end{aligned} \quad (315)$$

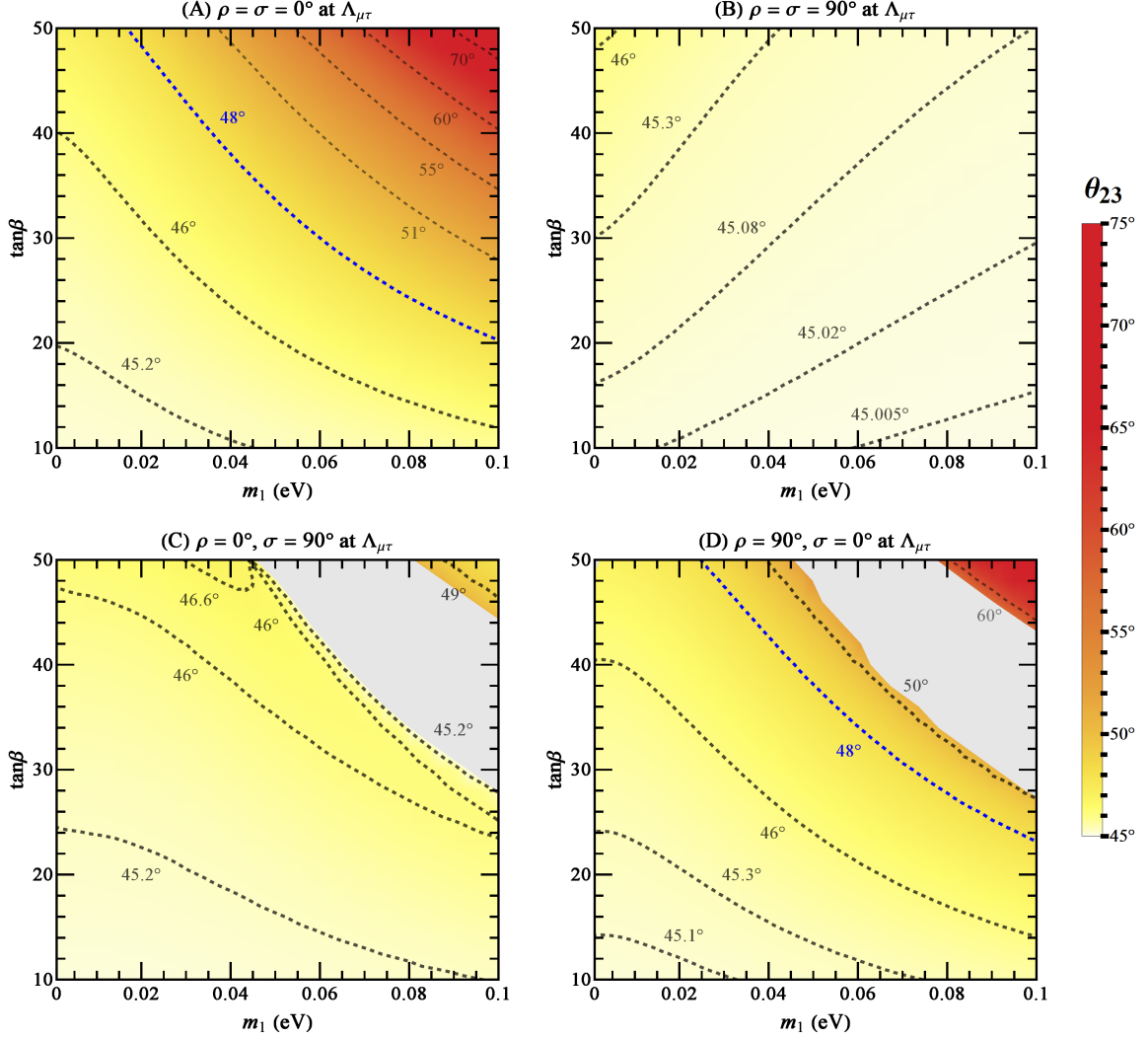

Figure 31: Majorana neutrinos: the allowed region of  $\theta_{23}$  at  $\Lambda_{\text{EW}}$  as functions of  $m_1 \in [0, 0.1]$  eV and  $\tan\beta \in [10, 50]$  in the MSSM with a normal neutrino mass ordering, originating from the RGE-induced breaking of  $\mu$ - $\tau$  reflection symmetry at  $\Lambda_{\mu\tau} \sim 10^{14}$  GeV [857]. Here the dashed curves are the contours for some typical values of  $\theta_{23}$ , and the blue one is compatible with the best-fit result of  $\theta_{23}$  obtained in Ref. [92].

for the differences of three CP-violating phases between  $\Lambda_{\text{EW}}$  and  $\Lambda_{\mu\tau}$ , where  $\eta_\rho \equiv \cos 2\rho = \pm 1$  and  $\eta_\sigma \equiv \cos 2\sigma = \pm 1$  represent possible options of  $\rho$  and  $\sigma$  in the  $\mu$ - $\tau$  symmetry limit at  $\Lambda_{\mu\tau}$ , and the ratios  $\zeta_{ij} \equiv (m_i - m_j)/(m_i + m_j)$  are defined with the neutrino masses  $m_i$  and  $m_j$  at  $\Lambda_{\text{EW}}$  (for  $i, j = 1, 2, 3$ ). In obtaining Eqs. (313), (314) and (315) we have used the  $\mu$ - $\tau$  reflection symmetry conditions  $\theta_{23} = \pi/4$  and  $\delta_\nu = 3\pi/2$  at  $\Lambda_{\mu\tau}$ . Our main observation is that the RGE-triggered  $\mu$ - $\tau$  reflection symmetry breaking provides a natural correlation of the neutrino mass ordering with both the octant of  $\theta_{23}$  and the quadrant of  $\delta_\nu$ .

In Figs. 31 and 32 we assume  $\Lambda_{\mu\tau} \sim 10^{14}$  GeV and plot the allowed regions of  $\theta_{23}$  and  $\delta_\nu$  at  $\Lambda_{\text{EW}}$  as functions of  $m_1 \in [0, 0.1]$  eV and  $\tan\beta \in [10, 50]$  in the MSSM with a normal neutrino

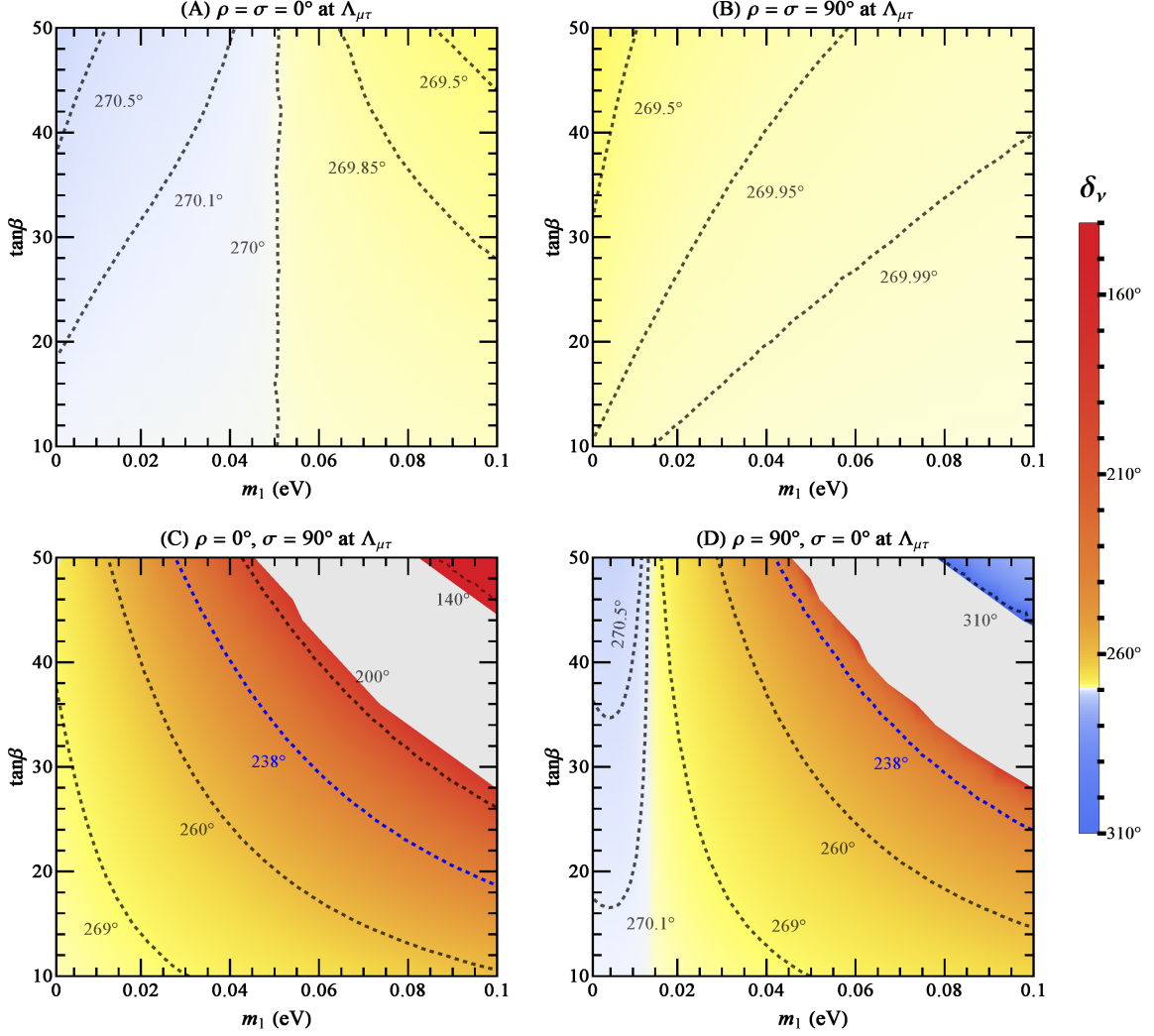

Figure 32: Majorana neutrinos: the allowed region of  $\delta_\nu$  at  $\Lambda_{EW}$  as functions of  $m_1 \in [0, 0.1]$  eV and  $\tan\beta \in [10, 50]$  in the MSSM with a normal neutrino mass ordering, originating from the RGE-induced breaking of  $\mu$ - $\tau$  reflection symmetry at  $\Lambda_{\mu\tau} \sim 10^{14}$  GeV [857]. Here the dashed curves are the contours for some typical values of  $\delta_\nu$ , and the blue one is compatible with the best-fit result of  $\delta_\nu$  obtained in Ref. [92].

mass ordering, respectively. Here the best-fit values and  $1\sigma$  ranges of six neutrino oscillation parameters, as listed in Tables 9 and 10 [92], have been taken into account. One can see that the normal neutrino mass ordering is naturally correlated with the upper octant of  $\theta_{23}$  and the third quadrant of  $\delta_\nu$  with the help of the  $\mu$ - $\tau$  reflection symmetry breaking triggered by the RGE evolution from  $\Lambda_{\mu\tau}$  down to  $\Lambda_{EW}$  in the MSSM. In this connection the reason that we have chosen the MSSM instead of the SM is three-fold [857]: (a) it is very hard to produce an appreciable value of  $\Delta\theta_{23}$  via the RGE-induced  $\mu$ - $\tau$  symmetry breaking effect in the SM; (b) the evolution of  $\theta_{23}$  from  $\Lambda_{\mu\tau}$  to  $\Lambda_{EW}$  seems to be in the “wrong” direction in the SM if one takes the present best-fit result  $\theta_{23} > 45^\circ$  seriously in the normal mass ordering case; and (c) the SM itself is likely to suffer from the vacuum-stability problem as the energy scale is above  $10^{10}$  GeV [91, 872].

Now we turn to the Dirac neutrino mass matrix  $M_\nu$  with the exact  $\mu$ - $\tau$  reflection symmetry at  $\Lambda_{\mu\tau} \gg \Lambda_{\text{EW}}$  in the  $M_l = D_l$  basis, as given in Eq. (300). With the help of the one-loop RGE of  $M_\nu = Y_{\nu} \sin\beta / \sqrt{2}$  in the MSSM given in Eq. (170), we obtain [821]

$$M_\nu(\Lambda_{\text{EW}}) = I_0 \left[ T_l \cdot M_\nu(\Lambda_{\mu\tau}) \right], \quad (316)$$

where the evolution functions  $I_0$  and  $T_l$  are defined in the same way as in Eqs. (309) and (310). Given  $T_l \simeq \text{Diag}\{1, 1, 1 - \Delta_\tau\}$  as a very good approximation, where  $\Delta_\tau$  is defined in the same way as in Eq. (311), the RGE-induced  $\mu$ - $\tau$  reflection symmetry breaking effect can be clearly seen as follows:

$$M_\nu(\Lambda_{\text{EW}}) \simeq I_0 \left[ \begin{pmatrix} \langle m \rangle_{ee} & \langle m \rangle_{e\mu} & \langle m \rangle_{e\mu}^* \\ \langle m \rangle_{\mu e} & \langle m \rangle_{\mu\mu} & \langle m \rangle_{\mu\tau} \\ \langle m \rangle_{\mu e}^* & \langle m \rangle_{\mu\tau}^* & \langle m \rangle_{\mu\mu}^* \end{pmatrix} - \Delta_\tau \begin{pmatrix} 0 & 0 & 0 \\ 0 & 0 & 0 \\ \langle m \rangle_{\mu e}^* & \langle m \rangle_{\mu\tau}^* & \langle m \rangle_{\mu\mu}^* \end{pmatrix} \right]. \quad (317)$$

It becomes obvious that the original Hermiticity of  $M_\nu$  at  $\Lambda_{\mu\tau}$  will be lost during the RGE evolution. A diagonalization of  $M_\nu$  at  $\Lambda_{\text{EW}}$  allows us to get at three neutrino masses and four flavor mixing parameters which can be confronted with current experimental data. Our approximate analytical results are summarized in terms of the same notations as in the Majorana case:

$$\begin{aligned} m_1(\Lambda_{\text{EW}}) &\simeq I_0 \left[ 1 - \frac{1}{2} \Delta_\tau (1 - c_{12}^2 c_{13}^2) \right] m_1(\Lambda_{\mu\tau}), \\ m_2(\Lambda_{\text{EW}}) &\simeq I_0 \left[ 1 - \frac{1}{2} \Delta_\tau (1 - s_{12}^2 c_{13}^2) \right] m_2(\Lambda_{\mu\tau}), \\ m_3(\Lambda_{\text{EW}}) &\simeq I_0 \left[ 1 - \frac{1}{2} \Delta_\tau c_{13}^2 \right] m_3(\Lambda_{\mu\tau}); \end{aligned} \quad (318)$$

and

$$\begin{aligned} \Delta\theta_{12} &\simeq \frac{\Delta_\tau}{2} s_{12} c_{12} \left[ c_{13}^2 \xi_{21} - s_{13}^2 (\xi_{32} - \xi_{31}) \right], \\ \Delta\theta_{13} &\simeq \frac{\Delta_\tau}{2} s_{13} c_{13} \left[ s_{12}^2 \xi_{32} + c_{12}^2 \xi_{31} \right], \\ \Delta\theta_{23} &\simeq \frac{\Delta_\tau}{2} \left[ c_{12}^2 \xi_{32} + s_{12}^2 \xi_{31} \right], \\ \Delta\delta_\nu &\simeq \frac{\Delta_\tau}{2} \left[ \frac{c_{12} (s_{12}^2 - c_{12}^2 s_{13}^2)}{s_{12} s_{13}} \xi_{32} - \frac{s_{12} (c_{12}^2 - s_{12}^2 s_{13}^2)}{c_{12} s_{13}} \xi_{31} - \frac{s_{13}}{c_{12} s_{12}} \xi_{21} \right], \end{aligned} \quad (319)$$

where  $\xi_{ij} \equiv (m_i^2 + m_j^2)/(m_i^2 - m_j^2)$  with  $i \neq j$ . In obtaining Eqs. (318) and (319) we have taken account of the  $\mu$ - $\tau$  reflection symmetry conditions  $\theta_{23} = \pi/4$  and  $\delta_\nu = 3\pi/2$  at  $\Lambda_{\mu\tau}$ . As in the case of Majorana neutrinos, a similar numerical illustration of the allowed regions of  $\theta_{23}$  and  $\delta_\nu$  at  $\Lambda_{\text{EW}}$  as functions of  $m_1$  and  $\tan\beta$  in the normal neutrino mass ordering case is shown in Fig. 33 for Dirac neutrinos. We see that current best-fit values of  $\theta_{23}$  and  $\delta_\nu$  can be ascribed to the RGE-induced  $\mu$ - $\tau$  reflection symmetry breaking in the MSSM.

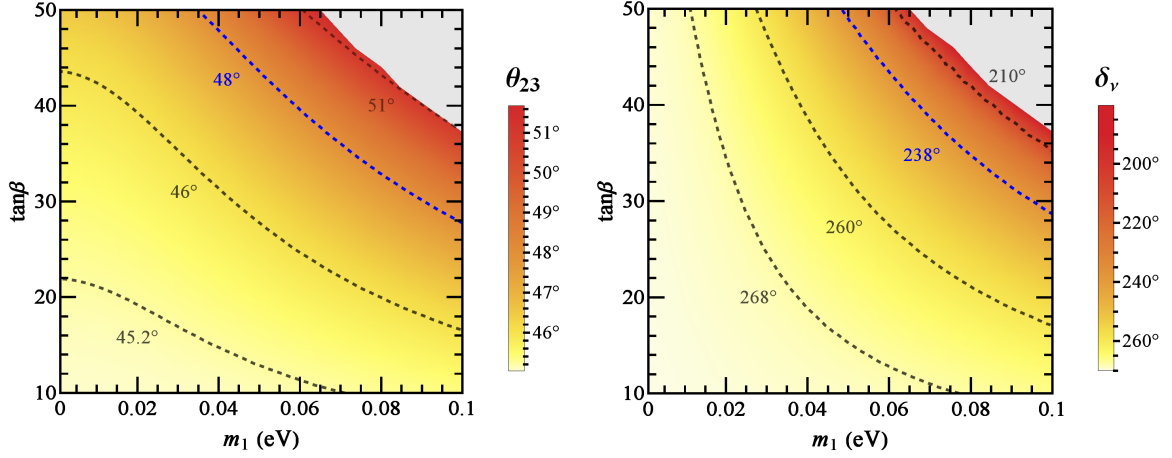

Figure 33: Dirac neutrinos: the allowed regions of  $\theta_{23}$  and  $\delta_\nu$  at  $\Lambda_{\text{EW}}$  as functions of  $m_1 \in [0, 0.1]$  eV and  $\tan\beta \in [10, 50]$  in the MSSM with a normal neutrino mass ordering, originating from the RGE-induced breaking of  $\mu$ - $\tau$  reflection symmetry at  $\Lambda_{\mu\tau} \sim 10^{14}$  GeV [857]. Here the dashed curves are the contours for some typical values of  $\theta_{23}$  and  $\delta_\nu$ , and the blue ones are compatible with the best-fit results of  $\theta_{23}$  and  $\delta_\nu$  obtained in Ref. [92].

## 7.2. Zero textures of massive Majorana neutrinos

### 7.2.1. Two- and one-zero flavor textures of $M_\nu$

In the  $M_l = D_l$  basis Fig. 30 tells us that one or two elements of the Majorana neutrino mass matrix  $M_\nu$  are possible to vanish, but it is impossible to simultaneously accommodate three independent vanishing entries as constrained by the available neutrino oscillation data. This phenomenological observation was first made in 2002, when some attention was paid to the two-zero textures of  $M_\nu$  [873, 874, 875]. In particular, it was found that the two Majorana phases  $\rho$  and  $\sigma$  of  $M_\nu$ , and the absolute neutrino mass scale  $m_1$  can be determined from the six neutrino oscillation parameters (i.e.,  $\Delta m_{21}^2$ ,  $\Delta m_{31}^2$ ,  $\theta_{12}$ ,  $\theta_{13}$ ,  $\theta_{23}$  and  $\delta_\nu$ ) if  $M_\nu$  possesses two texture zeros [874, 875, 876].

Given the  $3 \times 3$  symmetric Majorana neutrino mass matrix  $M_\nu$  in the  $M_l = D_l$  basis, its texture zeros can be counted as follows. If  $n$  of the six independent complex entries of  $M_\nu$  are taken to be zero, then we are left with  ${}^6C_n = 6!/[n!(6-n)!]$  different textures [877]. The possibilities of  $3 \leq n \leq 6$  have been ruled out, and that is why the two-zero textures of  $M_\nu$  are the focus of interest. There are totally fifteen textures of this kind, as listed and classified in Table 17. Among them, textures  $A_{1,2}$ ,  $B_{1,2,3,4}$  and  $C$  can survive current experimental tests at the  $3\sigma$  level, while textures  $D_{1,2}$ ,  $E_{1,2,3}$  and  $F_{1,2,3}$  have been excluded by the neutrino oscillation data [239, 878, 879, 880, 881, 882, 883, 884, 885, 886, 887, 888, 889, 890, 891].

To show why the two texture zeros of  $M_\nu$  allow us to determine its two Majorana phases  $\rho$  and  $\sigma$ , let us start from Eq. (304) to consider two independent zero elements  $\langle m \rangle_{\alpha\beta} = \langle m \rangle_{ab} = 0$ , where  $ab \neq \alpha\beta$ . Then we are left with the following equations:

$$\begin{aligned} \langle m \rangle_{\alpha\beta} &= \bar{m}_1 A_{\alpha\beta} + \bar{m}_2 B_{\alpha\beta} + m_3 C_{\alpha\beta} = 0, \\ \langle m \rangle_{ab} &= \bar{m}_1 A_{ab} + \bar{m}_2 B_{ab} + m_3 C_{ab} = 0, \end{aligned} \quad (320)$$

where  $A_{\alpha\beta}$ ,  $B_{\alpha\beta}$  and  $C_{\alpha\beta}$  can be directly read off from Eq. (305), so can be  $A_{ab}$ ,  $B_{ab}$  and  $C_{ab}$ . They

Table 17: The fifteen two-zero textures of the  $3 \times 3$  Majorana neutrino mass matrix  $M_\nu$ , where the symbol “ $\times$ ” stands for a nonzero complex element. The criterion of our classification is that the textures of  $M_\nu$  in each category have very similar phenomenological consequences.

$A_1$	$A_2$	$B_1$	$B_2$	$B_3$	$B_4$	C	
$\begin{pmatrix} 0 & 0 & \times \\ 0 & \times & \times \\ \times & \times & \times \end{pmatrix}$	$\begin{pmatrix} 0 & \times & 0 \\ \times & \times & \times \\ 0 & \times & \times \end{pmatrix}$	$\begin{pmatrix} \times & \times & 0 \\ \times & 0 & \times \\ 0 & \times & \times \end{pmatrix}$	$\begin{pmatrix} \times & 0 & \times \\ 0 & \times & \times \\ \times & \times & 0 \end{pmatrix}$	$\begin{pmatrix} \times & 0 & \times \\ 0 & 0 & \times \\ \times & \times & \times \end{pmatrix}$	$\begin{pmatrix} \times & \times & 0 \\ \times & \times & \times \\ 0 & \times & 0 \end{pmatrix}$	$\begin{pmatrix} \times & \times & \times \\ \times & 0 & \times \\ \times & \times & 0 \end{pmatrix}$	
$D_1$	$D_2$	$E_1$	$E_2$	$E_3$	$F_1$	$F_2$	$F_3$
$\begin{pmatrix} \times & \times & \times \\ \times & 0 & 0 \\ \times & 0 & \times \end{pmatrix}$	$\begin{pmatrix} \times & \times & \times \\ \times & \times & 0 \\ \times & 0 & 0 \end{pmatrix}$	$\begin{pmatrix} 0 & \times & \times \\ \times & 0 & \times \\ \times & \times & \times \end{pmatrix}$	$\begin{pmatrix} 0 & \times & \times \\ \times & \times & \times \\ \times & \times & 0 \end{pmatrix}$	$\begin{pmatrix} 0 & \times & \times \\ \times & \times & 0 \\ \times & 0 & \times \end{pmatrix}$	$\begin{pmatrix} \times & 0 & 0 \\ 0 & \times & \times \\ 0 & \times & \times \end{pmatrix}$	$\begin{pmatrix} \times & 0 & \times \\ 0 & \times & 0 \\ \times & 0 & \times \end{pmatrix}$	$\begin{pmatrix} \times & \times & 0 \\ \times & \times & 0 \\ 0 & 0 & \times \end{pmatrix}$

are simple trigonometric functions of  $\theta_{12}, \theta_{13}, \theta_{23}$  and  $\delta_\nu$ . As a result, we obtain

$$\begin{aligned} \frac{\bar{m}_1}{m_3} &= \frac{m_1}{m_3} e^{i2\rho} = + \frac{B_{\alpha\beta} C_{ab} - B_{ab} C_{\alpha\beta}}{A_{\alpha\beta} B_{ab} - A_{ab} B_{\alpha\beta}}, \\ \frac{\bar{m}_2}{m_3} &= \frac{m_2}{m_3} e^{i2\sigma} = - \frac{A_{\alpha\beta} C_{ab} - A_{ab} C_{\alpha\beta}}{A_{\alpha\beta} B_{ab} - A_{ab} B_{\alpha\beta}}, \end{aligned} \quad (321)$$

which establish the unique correlation between  $(m_1/m_3, m_2/m_3, \rho, \sigma)$  and  $(\theta_{12}, \theta_{13}, \theta_{23}, \delta_\nu)$ . Once the experimental information on  $\Delta m_{21}^2$  or  $\Delta m_{31}^2$  is taken into account, one may also determine the neutrino mass  $m_1$  as follows:

$$m_1^2 = \left(\frac{m_1}{m_2}\right)^2 \left[1 - \left(\frac{m_1}{m_2}\right)^2\right]^{-1} \Delta m_{21}^2 = \left(\frac{m_1}{m_3}\right)^2 \left[1 - \left(\frac{m_1}{m_3}\right)^2\right]^{-1} \Delta m_{31}^2. \quad (322)$$

In short, current neutrino oscillation data on three neutrino mixing angles and two neutrino mass-squared differences, together with the correlative relations in Eqs. (321) and (322), allow us to determine or constrain all the three CP-violating phases and the absolute neutrino mass scale. A systematical analysis of all the two-zero textures of  $M_\nu$  has recently been done in Refs. [888, 889, 890], and the survivable textures remain  $A_{1,2}$ ,  $B_{1,2,3,4}$  and C at the  $3\sigma$  confidence level. Some particular attention has been paid to  $B_{1,2,3,4}$  and C [892, 893], since they can accommodate an appreciable value of  $|\langle m \rangle_{ee}|$  which is quite encouraging for current and future experimental efforts in searching for the lepton-number-violating  $0\nu 2\beta$  signals.

As in the case of quark mass matrices discussed in section 6.3.1, it is also possible to generate the texture zeros of  $M_\nu$  by means of some Abelian flavor symmetries (e.g., the cyclic group  $Z_{2N}$  [211, 761, 894]). If such zeros are realized at a superhigh energy scale  $\Lambda$ , their stability at the electroweak scale  $\Lambda_{EW}$  can be examined by means of the one-loop RGE obtained in Eq. (309) with the replacement  $\Lambda_{\mu\tau} \rightarrow \Lambda$ . Since  $T_l$  is diagonal and  $M_\nu$  is symmetric, it is easy to check that the texture zeros of  $M_\nu$  are stable against the RGE evolution from  $\Lambda$  down to  $\Lambda_{EW}$  [137, 895],

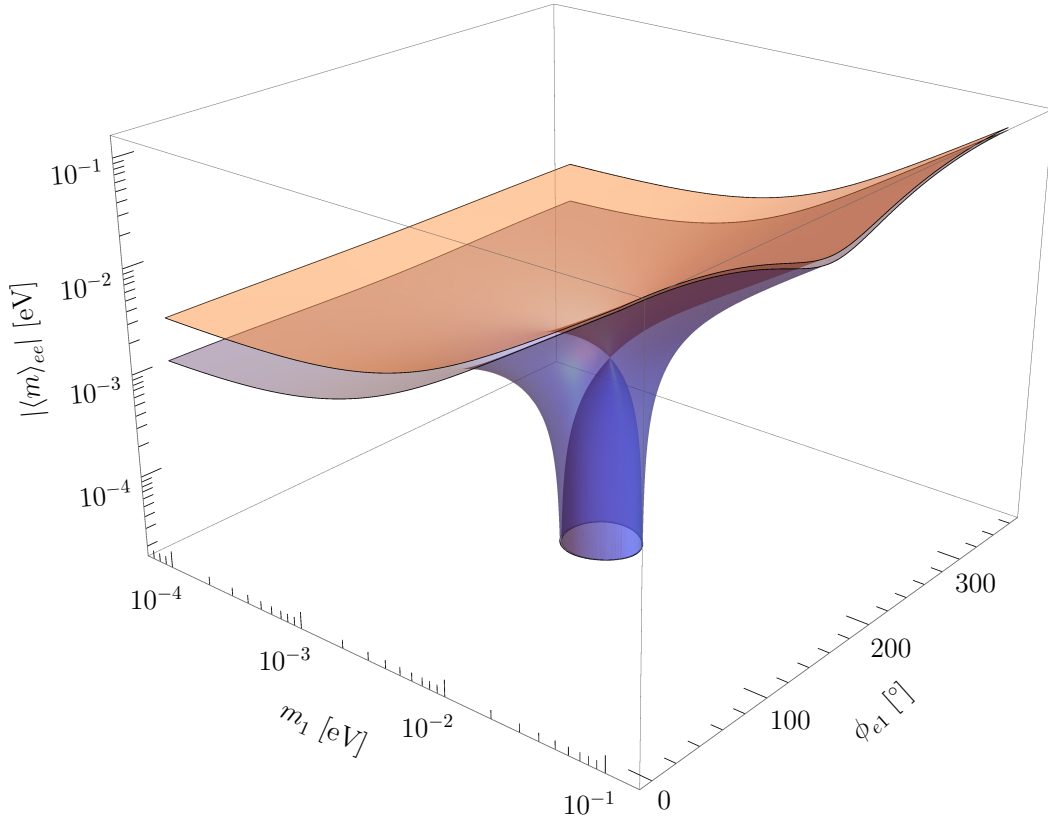

Figure 34: A three-dimensional illustration of the upper (in orange) and lower (in blue) bounds of  $|\langle m \rangle_{ee}|$  as functions of  $m_1$  and  $\phi_{e1}$  in the normal neutrino mass ordering case, where the best-fit values  $\Delta m_{21}^2$ ,  $\Delta m_{31}^2$ ,  $\sin^2 \theta_{12}$  and  $\sin^2 \theta_{13}$  listed in Table 10 have been input [393].

but its nonzero elements are sensitive to the RGE corrections and thus affect the values of three neutrino masses and six flavor mixing parameters in general.

Assuming one of the six independent elements of the Majorana neutrino mass matrix  $M_\nu$  to vanish, one will arrive at six possible one-zero textures of  $M_\nu$  [389, 390, 896, 897, 898], which are all compatible with current neutrino oscillation data. Unlike the two-zero textures of  $M_\nu$  discussed above, the one-zero textures of  $M_\nu$  are less constrained, and hence it is impossible to fully determine the absolute neutrino mass scale and two Majorana CP phases in terms of the six neutrino oscillation parameters in this case.

But the possibility of  $\langle m \rangle_{ee} = 0$  deserves special attention because it implies a null result for the lepton-number-violating  $0\nu 2\beta$  decays even though massive neutrinos are of the Majorana nature. As shown in Fig. 30, only the normal neutrino mass ordering allows for  $\langle m \rangle_{ee} = 0$ , in which case a complete cancellation takes place among its three components. To see this point more clearly, we plot the bounds of  $|\langle m \rangle_{ee}|$  as functions of  $m_1$  and  $\phi_{e1}$  in Fig. 34 by using the phase convention set in Eq. (93), where  $\phi_{e1}$  and  $\phi_{e3}$  are related to the three CP-violating phases in the standard parametrization of  $U$  through  $\phi_{e1} \equiv 2(\rho - \sigma)$  and  $\phi_{e3} \equiv -2(\delta_\nu + \sigma)$ . For the sake of simplicity, we

have only input the best-fit values of  $\Delta m_{21}^2$ ,  $\Delta m_{31}^2$ ,  $\theta_{12}$  and  $\theta_{13}$  listed in Table 10. In fact, the profile of  $|\langle m \rangle_{ee}|$  in Fig. 34 can be understood in a straightforward way. Given

$$\frac{\partial |\langle m \rangle_{ee}|}{\partial \phi_{e3}} = 0 \quad \longrightarrow \quad \tan \phi_{e3} = \frac{m_1 \sin \phi_{e1}}{m_1 \cos \phi_{e1} + m_2 \tan^2 \theta_{12}}, \quad (323)$$

it is easy to derive the upper (“U”) and lower (“L”) bounds of  $|\langle m \rangle_{ee}|$  from Eq. (93):

$$|\langle m \rangle_{ee}|_{\text{U,L}} = \left| \sqrt{m_1^2 \cos^4 \theta_{12} + \frac{1}{2} m_1 m_2 \sin^2 2\theta_{12} \cos \phi_{e1} + m_2^2 \sin^4 \theta_{12} \cos^2 \theta_{13} \pm m_3 \sin^2 \theta_{13}} \right|, \quad (324)$$

where the sign “+” (or “−”) corresponds to “U” (or “L”). The bottom of the “well” profile in Fig. 34 satisfies the condition  $|\langle m \rangle_{ee}|_{\text{L}} = 0$ , which in turn fixes the correlation between  $m_1$  and  $\phi_{e1}$  [393]. Note that the “bullet”-like structure of  $|\langle m \rangle_{ee}|_{\text{L}}$  has a local maximum on its tip,

$$|\langle m \rangle_{ee}|_* = m_3 \sin^2 \theta_{13} = \sqrt{m_1^2 + \Delta m_{31}^2} \sin^2 \theta_{13}, \quad (325)$$

which is located at  $\phi_{e1} = \pi$  and  $m_1 = m_2 \tan^2 \theta_{12}$ . This position actually means that the first term on the right-hand side of Eq. (324) vanishes, and thus it exactly corresponds to the touching point of the upper and lower bound layers of  $|\langle m \rangle_{ee}|$  shown in Fig. 34. With the help of current neutrino oscillation data, the location of the tip of the bullet is found to be  $(m_1, \phi_{e1}, |\langle m \rangle_{ee}|_*) \simeq (4 \text{ meV}, \pi, 1.1 \text{ meV})$ . That is why  $|\langle m \rangle_{ee}| \sim 1 \text{ meV}$  has often been taken as a threshold to signify the maximally reachable limit of the next-generation  $0\nu 2\beta$ -decay experiments [393, 394, 899]. Below this threshold the neutrino mass spectrum and one of the Majorana phases can be well constrained (for example,  $0.7 \text{ meV} \leq m_1 \leq 8.0 \text{ meV}$ ,  $8.6 \text{ meV} \leq m_2 \leq 11.7 \text{ meV}$ ,  $50.3 \text{ meV} \leq m_3 \leq 50.9 \text{ meV}$  and  $130^\circ \leq \phi_{e1} \leq 230^\circ$  can be extracted from  $|\langle m \rangle_{ee}| \lesssim 1 \text{ meV}$  [899]), although the experimental signal is expected to be null in this unfortunate situation.

### 7.2.2. The Fritzsche texture on the seesaw

Since the Fritzsche texture of fermion mass matrices is one of the most typical examples to illustrate how the texture zeros may establish some testable relations between the fermion mass ratios and flavor mixing angles, it has also been applied to the lepton sector by combining with the canonical seesaw mechanism in the assumption that the right-handed Majorana neutrino mass matrix  $M_{\text{R}}$  is the identity matrix (i.e.,  $M_{\text{R}} = M_0 I$  with  $M_0$  being the universal heavy neutrino mass) [900]. In this simple ansatz the charged-lepton mass matrix  $M_l$  and the Dirac neutrino mass matrix  $M_{\text{D}}$  are both of the Fritzsche form:

$$M_l = \begin{pmatrix} 0 & C_l & 0 \\ C_l^* & 0 & B_l \\ 0 & B_l^* & A_l \end{pmatrix}, \quad M_{\text{D}} = \begin{pmatrix} 0 & C_{\text{D}} & 0 \\ C_{\text{D}} & 0 & B_{\text{D}} \\ 0 & B_{\text{D}} & A_{\text{D}} \end{pmatrix}, \quad (326)$$

where we have required  $M_{\text{D}}$  to be real and symmetric, so as to assure the maximal analytical calculability. Then the seesaw formula in Eq. (25) leads us to the light Majorana neutrino mass matrix  $M_{\nu} \simeq -M_{\text{D}}^2/M_0$ . The key point is that the real orthogonal matrix  $O_{\text{D}}$  used to diagonalize



$M_D$  (i.e.,  $O_D^T M_D O_D = D_D \equiv \text{Diag}\{d_1, -d_2, d_3\}$  with  $d_i$  being the positive eigenvalues of  $M_D$ ) can simultaneously diagonalize  $M_\nu$ . Namely, we have  $O_\nu = iO_D$  such that

$$O_\nu^\dagger M_\nu O_\nu^* = -O_D^T M_\nu O_D \simeq \frac{1}{M_0} (O_D^T M_D O_D)^2 = \frac{1}{M_0} D_D^2, \quad (327)$$

from which  $m_i \simeq d_i^2/M_0$  can be obtained (for  $i = 1, 2, 3$ ). Although  $M_\nu$  itself is not of the Fritzsche form,  $O_\nu$  is fully calculable from  $M_D$ . To be more explicit, the nine elements of  $O_l$  used to diagonalize  $M_l$  in Eq. (326) and those of  $O_\nu$  used to diagonalize  $M_\nu$  in this seesaw scenario are listed in Table 18. Then the PMNS lepton flavor mixing matrix  $U = O_l^\dagger O_\nu$  can be calculated in terms of two charged-lepton mass ratios, two neutrino mass ratios and two CP-violating phases between  $M_l$  and  $M_\nu$ . Needless to say, only the normal neutrino mass ordering is allowed by such a special seesaw scenario. Some careful analyses have shown that its phenomenological consequences are compatible with current neutrino oscillation data very well [901, 902, 903, 904], much better than the plain Fritzsche ansatz of Hermitian lepton mass matrices in Eq. (302).

Of course, the choice of  $M_R = M_0 I$  is too special to accommodate any successful leptogenesis mechanism, no matter whether  $M_D$  has been assumed to be real or not. This point is self-evident, as can be seen from either of the following two equivalent criteria for CP invariance of heavy Majorana neutrino decays in the canonical seesaw mechanism [486, 905, 906, 907]:

$$\begin{aligned} \text{Im} \left\{ \det \left[ M_D^\dagger M_D, M_R^\dagger M_R \right] \right\} &= 0, \\ \text{Im} \left\{ \text{Tr} \left[ \left( M_D^\dagger M_D \right) \left( M_R^\dagger M_R \right) M_R^* \left( M_D^\dagger M_D \right)^* M_R \right] \right\} &= 0. \end{aligned} \quad (328)$$

One possible way out is to introduce some complex perturbations to  $M_R$  to break the exact mass degeneracy of three heavy Majorana neutrinos [908, 909], in which case the resonant leptogenesis mechanism might work to account for the observed matter-antimatter asymmetry of our Universe.

Another phenomenologically interesting scenario of combining the Fritzsche texture with the canonical seesaw mechanism is to assume

$$M_D = \begin{pmatrix} 0 & C_D & 0 \\ C_D & 0 & B_D \\ 0 & B_D & A_D \end{pmatrix}, \quad M_R = \begin{pmatrix} 0 & C_R & 0 \\ C_R & 0 & B_R \\ 0 & B_R & A_R \end{pmatrix}, \quad (329)$$

where  $A_D$  and  $A_R$  can always be arranged to be real and positive, and all the other elements are in general complex. In this case the light Majorana neutrino mass matrix  $M_\nu \simeq -M_D M_R^{-1} M_D^T$  is found to be of the same Fritzsche form

$$M_\nu \simeq - \begin{pmatrix} 0 & \frac{C_D^2}{C_R} & 0 \\ \frac{C_D^2}{C_R} & 0 & \frac{B_D C_D}{C_R} \\ 0 & \frac{B_D C_D}{C_R} & \frac{A_D^2}{A_R} \end{pmatrix}, \quad (330)$$

Table 18: The nine elements of  $O_l$  used to diagonalize the Fritzsch texture of  $M_l$  in Eq. (326), and those of  $O_\nu$  used to diagonalize  $M_\nu \simeq -M_D^2/M_0$  with  $M_D$  being given in Eq. (326) too, where  $x_l \equiv m_e/m_\mu$ ,  $y_l \equiv m_\mu/m_\tau$ ,  $x_\nu \equiv m_1/m_2$ ,  $y_\nu \equiv m_2/m_3$ ,  $\varphi_1 \equiv -\arg C_l$  and  $\varphi_2 \equiv -(\arg B_l + \arg C_l)$  have been defined.

Element	$O_l$	$O_\nu$
(1,1)	$\left[ \frac{1-y_l}{(1+x_l)(1-x_ly_l)(1-y_l+x_ly_l)} \right]^{1/2}$	$i \left[ \frac{1-\sqrt{y_\nu}}{(1+\sqrt{x_\nu})(1-\sqrt{x_\nu y_\nu})(1-\sqrt{y_\nu}+\sqrt{x_\nu y_\nu})} \right]^{1/2}$
(1,2)	$-i \left[ \frac{x_l(1+x_ly_l)}{(1+x_l)(1+y_l)(1-y_l+x_ly_l)} \right]^{1/2}$	$\left[ \frac{\sqrt{x_\nu}(1+\sqrt{x_\nu y_\nu})}{(1+\sqrt{x_\nu})(1+\sqrt{y_\nu})(1-\sqrt{y_\nu}+\sqrt{x_\nu y_\nu})} \right]^{1/2}$
(1,3)	$\left[ \frac{x_ly_l^3(1-x_l)}{(1-x_ly_l)(1+y_l)(1-y_l+x_ly_l)} \right]^{1/2}$	$i \left[ \frac{y_\nu\sqrt{x_\nu y_\nu}(1-\sqrt{x_\nu})}{(1-\sqrt{x_\nu y_\nu})(1+\sqrt{y_\nu})(1-\sqrt{y_\nu}+\sqrt{x_\nu y_\nu})} \right]^{1/2}$
(2,1)	$\left[ \frac{x_l(1-y_l)}{(1+x_l)(1-x_ly_l)} \right]^{1/2} e^{i\varphi_1}$	$i \left[ \frac{\sqrt{x_\nu}(1-\sqrt{y_\nu})}{(1+\sqrt{x_\nu})(1-\sqrt{x_\nu y_\nu})} \right]^{1/2}$
(2,2)	$i \left[ \frac{1+x_ly_l}{(1+x_l)(1+y_l)} \right]^{1/2} e^{i\varphi_1}$	$-\left[ \frac{1+\sqrt{x_\nu y_\nu}}{(1+\sqrt{x_\nu})(1+\sqrt{y_\nu})} \right]^{1/2}$
(2,3)	$\left[ \frac{y_l(1-x_l)}{(1-x_ly_l)(1+y_l)} \right]^{1/2} e^{i\varphi_1}$	$i \left[ \frac{\sqrt{y_\nu}(1-\sqrt{x_\nu})}{(1-\sqrt{x_\nu y_\nu})(1+\sqrt{y_\nu})} \right]^{1/2}$
(3,1)	$-\left[ \frac{x_ly_l(1-x_l)(1+x_ly_l)}{(1+x_l)(1-x_ly_l)(1-y_l+x_ly_l)} \right]^{1/2} e^{i\varphi_2}$	$-i \left[ \frac{\sqrt{x_\nu y_\nu}(1-\sqrt{x_\nu})(1+\sqrt{x_\nu y_\nu})}{(1+\sqrt{x_\nu})(1-\sqrt{x_\nu y_\nu})(1-\sqrt{y_\nu}+\sqrt{x_\nu y_\nu})} \right]^{1/2}$
(3,2)	$-i \left[ \frac{y_l(1-x_l)(1-y_l)}{(1+x_l)(1+y_l)(1-y_l+x_ly_l)} \right]^{1/2} e^{i\varphi_2}$	$\left[ \frac{\sqrt{y_\nu}(1-\sqrt{x_\nu})(1-\sqrt{y_\nu})}{(1+\sqrt{x_\nu})(1+\sqrt{y_\nu})(1-\sqrt{y_\nu}+\sqrt{x_\nu y_\nu})} \right]^{1/2}$
(3,3)	$\left[ \frac{(1-y_l)(1+x_ly_l)}{(1-x_ly_l)(1+y_l)(1-y_l+x_ly_l)} \right]^{1/2} e^{i\varphi_2}$	$i \left[ \frac{(1-\sqrt{y_\nu})(1+\sqrt{x_\nu y_\nu})}{(1-\sqrt{x_\nu y_\nu})(1+\sqrt{y_\nu})(1-\sqrt{y_\nu}+\sqrt{x_\nu y_\nu})} \right]^{1/2}$

if the condition  $B_D/C_D = B_R/C_R$  is imposed [630, 858, 910]. This simple result, together with the Fritzsch texture of  $M_l$  in Eq. (326), allows us to analytically calculate the light neutrino masses and lepton flavor mixing parameters. Meanwhile, it is possible to interpret the cosmological baryon-antibaryon asymmetry via thermal leptogenesis in such a simple scenario [630, 858].

If a universal geometric mass hierarchy is further assumed for  $M_D$  and  $M_R$  in Eq. (329), namely

$$\frac{d_1}{d_2} = \frac{d_2}{d_3} = \frac{M_1}{M_2} = \frac{M_2}{M_3} \equiv r, \quad (331)$$

then it is straightforward to show that the condition  $B_D/C_D = B_R/C_R$  is automatically satisfied. As a consequence,  $M_\nu$  possesses the same Fritzsch texture as given in Eq. (330), and the three light Majorana neutrinos have the same geometric mass relation  $m_1/m_2 = m_2/m_3 = r$  [858]. In fact,

$$\begin{aligned} m_1 &= \frac{r^2}{\sqrt{1-r^4}} \sqrt{\Delta m_{31}^2}, \\ m_2 &= \frac{r}{\sqrt{1-r^4}} \sqrt{\Delta m_{31}^2}, \\ m_3 &= \frac{1}{\sqrt{1-r^4}} \sqrt{\Delta m_{31}^2}, \end{aligned} \quad (332)$$

exhibiting a normal mass hierarchy, where  $r^2 = \Delta m_{21}^2/(\Delta m_{31}^2 - \Delta m_{21}^2) \simeq 0.03$  as indicated by current best-fit values of  $\Delta m_{21}^2$  and  $\Delta m_{31}^2$  listed in Table 9. On the other hand, the nontrivial phase differences between  $M_D$  and  $M_R$  allow us to obtain a proper CP-violating asymmetry between the lepton-number-violating decay of the lightest heavy Majorana neutrino  $N_1$  and its CP-conjugate process, making it possible to account for the observed cosmological baryon-to-photon ratio  $\eta = n_B/n_\gamma \simeq 6.12 \times 10^{-10}$  in Eq. (48) via the thermal leptogenesis mechanism [858].

Beyond the simple but instructive Fritzsch texture discussed above, there are actually many different possibilities to arrange texture zeros for  $M_l$ ,  $M_D$  and  $M_R$ , from which the texture of  $M_\nu$  can be derived by means of the seesaw formula. In this regard some general classifications and concrete analyses have been made (see, e.g., Refs. [911, 912, 913, 914, 915, 916]). It is certainly difficult to test most of them by just using current neutrino oscillation data, because such zero textures on the seesaw usually involve quite a lot of free parameters. A combination of the seesaw and leptogenesis mechanisms proves to be helpful to exclude some simple zero textures of this kind, but there is still a long way to go in this connection.

### 7.2.3. Seesaw mirroring between $M_\nu$ and $M_R$

The example taken in Eqs. (329) and (330) implies that the textures of  $M_\nu$  and  $M_R$  in the canonical seesaw mechanism may be parallel, with either some texture zeros or some equalities based on a sort of flavor symmetry. Such a parallel structure of  $M_\nu$  and  $M_R$  via the seesaw formula can be referred to as the *seesaw mirroring* relationship between light and heavy Majorana neutrinos [722]. In this sense the simplest seesaw-induced correlation between  $M_\nu$  and  $M_R$  should be  $M_\nu \simeq d_0^2/M_R$  by assuming  $M_D = id_0 I$  with  $d_0$  being the mass scale of the Dirac neutrino mass matrix. Taking account of  $O_R^\dagger M_R O_R^* = D_N \equiv \text{Diag}\{M_1, M_2, M_3\}$  and  $O_\nu^\dagger M_\nu O_\nu^* = D_\nu \equiv \text{Diag}\{m_1, m_2, m_3\}$ , we can immediately arrive at the following two seesaw mirroring relations:

$$D_\nu \simeq \frac{d_0^2}{D_N}, \quad O_\nu = O_R^*. \quad (333)$$

Therefore,  $m_i \simeq d_0^2/M_i$  holds (for  $i = 1, 2, 3$ ). In the basis where the flavor eigenstates of three charged leptons are identical with their mass eigenstates (i.e.,  $M_l = D_l$ ), we have  $O_R = U^*$  with  $U$  being the PMNS flavor mixing matrix for three light neutrinos. One might naively expect that the CP-violating asymmetries between  $N_i \rightarrow \ell_\alpha + H$  and  $N_i \rightarrow \bar{\ell}_\alpha + \bar{H}$  decays (for  $i = 1, 2, 3$ ) at high

energies could solely be related to the CP-violating phases of  $U$  at low energies in this case, but it is not true. The point is simply that the prerequisite  $M_D = id_0 I$  leads to CP invariance in the heavy Majorana neutrino sector, as one can easily see from Eq. (328).

Although the Fritzsche texture of  $M_\nu$  in Eq. (330) can be regarded as a seesaw-invariant consequence of the Fritzsche textures of  $M_D$  and  $M_R$  in Eq. (329), this interesting seesaw mirroring is subject to the precondition  $B_D/C_D = B_R/C_R$ . It has been noticed that a stable seesaw-invariant zero texture is the Fritzsche-like one [137]:

$$M_D = \begin{pmatrix} 0 & C_D & 0 \\ C_D & B'_D & B_D \\ 0 & B_D & A_D \end{pmatrix}, \quad M_R = \begin{pmatrix} 0 & C_R & 0 \\ C_R & B'_R & B_R \\ 0 & B_R & A_R \end{pmatrix}, \quad (334)$$

in which  $A_D$  and  $A_R$  can be arranged to be real and positive. In this case the canonical seesaw formula  $M_\nu \simeq -M_D M_R^{-1} M_D^T$  leads us to

$$M_\nu \simeq - \begin{pmatrix} 0 & \frac{C_D^2}{C_R} & 0 \\ \frac{C_D^2}{C_R} & B'_\nu & \frac{A_D B_D}{A_R} + \frac{B_D C_D}{C_R} - \frac{A_D C_D B_R}{A_R C_R} \\ 0 & \frac{A_D B_D}{A_R} + \frac{B_D C_D}{C_R} - \frac{A_D C_D B_R}{A_R C_R} & \frac{A_D^2}{A_R} \end{pmatrix}, \quad (335)$$

where

$$B'_\nu = \frac{B_D^2}{A_R} + 2 \frac{B'_D C_D}{C_R} - \frac{C_D^2 B'_R}{C_R^2} - 2 \frac{B_D C_D B_R}{A_R C_R} + \frac{C_D^2 B_R^2}{A_R C_R^2}. \quad (336)$$

Note that the Fritzsche-like four-zero textures of  $M_l$  and  $M_\nu$  are compatible with current neutrino oscillation data very well, and the same zero textures of  $M_D$  and  $M_R$  can also guarantee thermal leptogenesis to work well [917, 918]. So the universal zero textures of these mass matrices in the seesaw mechanism deserve more attention in the model-building exercises.

Possible seesaw mirroring relations between light and heavy Majorana neutrinos are certainly not limited to their *zero* flavor textures. If the neutrino mass terms in the canonical seesaw mechanism are required to be invariant under the  $S_3$  charge-conjugation transformation of left- and right-handed neutrino fields, a systematic analysis shows that there exist remarkable structural equalities or similarities between  $M_\nu$  and  $M_R$  [722], reflecting another kind of seesaw mirroring relationship of interest. In particular, the textures of  $M_D$  and  $M_R$  which respect the  $\mu$ - $\tau$  reflection symmetry are found to be seesaw-invariant. To be explicit, let us consider

$$M_D = \begin{pmatrix} A_D & B_D & B_D^* \\ E_D & C_D & D_D \\ E_D^* & D_D^* & C_D \end{pmatrix}, \quad M_R = \begin{pmatrix} A_R & B_R & B_R^* \\ B_R & C_R & D_R \\ B_R^* & D_R & C_R \end{pmatrix}, \quad (337)$$

corresponding to the textures given in Eqs. (300) and (306) under the  $\mu$ - $\tau$  reflection symmetry, with

$A_D, A_R$  and  $D_R$  being real. With the help of the seesaw formula  $M_\nu \simeq -M_D M_R^{-1} M_D^T$ , we obtain

$$M_\nu \simeq - \begin{pmatrix} A_\nu & B_\nu & B_\nu^* \\ B_\nu & C_\nu & D_\nu \\ B_\nu^* & D_\nu & C_\nu^* \end{pmatrix}, \quad (338)$$

where

$$\begin{aligned} A_\nu &= \frac{1}{\det M_R} \left\{ A_D^2 (|C_R|^2 - D_R^2) + 4A_D \text{Re} [B_D (D_R B_R^* - B_R C_R^*)] + 2\text{Re} [B_D^2 (A_R C_R^* - B_R^{*2})] \right. \\ &\quad \left. + 2|B_D|^2 (|B_R|^2 - A_R D_R) \right\}, \\ B_\nu &= \frac{1}{\det M_R} \left\{ A_D E_D (|C_R|^2 - D_R^2) + 2E_D \text{Re} [B_D (D_R B_R^* - B_R C_R^*)] + A_D C_D (D_R B_R^* - B_R C_R^*) \right. \\ &\quad \left. + B_D C_D (A_R C_R^* - B_R^{*2}) + (B_D^* C_D + B_D D_D) (|B_R|^2 - A_R D_R) + A_D D_D (B_R D_R - B_R^* C_R) \right. \\ &\quad \left. + B_D^* D_D (A_R C_R - B_R^2) \right\}, \\ C_\nu &= \frac{1}{\det M_R} \left[ E_D^2 (|C_R|^2 - D_R^2) + 2E_D C_D (D_R B_R^* - B_R C_R^*) + 2E_D D_D (B_R D_R - B_R^* C_R) \right. \\ &\quad \left. + C_D^2 (A_R C_R^* - B_R^{*2}) + 2C_D D_D (|B_R|^2 - A_R D_R) + D_D^2 (A_R C_R - B_R^2) \right], \\ D_\nu &= \frac{1}{\det M_R} \left\{ |E_D|^2 (|C_R|^2 - D_R^2) + 2\text{Re} [(E_D^* C_D + E_D D_D^*) (D_R B_R^* - B_R C_R^*)] \right. \\ &\quad \left. + (|C_D|^2 + |D_D|^2) (|B_R|^2 - A_R D_R) + 2\text{Re} [C_D D_D^* (A_R C_R^* - B_R^{*2})] \right\}, \end{aligned} \quad (339)$$

with  $\det M_R = A_R |C_R|^2 + 2|B_R|^2 D_R - A_R D_R^2 - 2\text{Re}(B_R^2 C_R^*)$ . It is obvious that  $M_\nu$  and  $M_R$  have the same texture associated with the  $\mu$ - $\tau$  reflection symmetry, and thus there exists an interesting seesaw mirroring relationship between these two mass matrices [722]. In particular, such a relationship means a quite strong constraint on the overall texture of  $M_\nu$ , which is essentially independent of the detailed parameter correlation in Eq. (339).

One may certainly find more examples of this kind in the canonical seesaw mechanism or its extensions, such as the universal Fritzsch texture or Fritzsch-like texture of all the fermion mass matrices in the inverse seesaw or multiple seesaw scenarios [211, 919, 920]. Of course, a seesaw mirroring relation between light and heavy Majorana neutrinos does not necessarily mean that there is a kind of underlying flavor symmetry behind it, although such a relationship is phenomenologically interesting and suggestive.

### 7.3. Simplified versions of seesaw mechanisms

#### 7.3.1. The minimal seesaw mechanism

Motivated by the principle of Occam's razor, one may simplify a conventional seesaw mechanism by introducing fewer heavy degrees of freedom. The purpose of this treatment is simply to reduce the number of unknown parameters and thus enhance the predictability and testability of the concerned seesaw scenario. As mentioned in section 5.1.3, the minimal seesaw mechanism [238] is the most popular example of this sort. It is a straightforward extension of the SM by

adding only two right-handed Majorana neutrino fields (denoted as  $N_{\mu R}$  and  $N_{\tau R}$ ) and allowing for lepton number violation, in which the  $3 \times 2$  Dirac neutrino mass matrix  $M_D$  and the  $2 \times 2$  heavy Majorana neutrino mass matrix  $M_R$  are expressed as

$$M_D = \begin{pmatrix} A_{e\mu} & A_{e\tau} \\ A_{\mu\mu} & A_{\mu\tau} \\ A_{\tau\mu} & A_{\tau\tau} \end{pmatrix}, \quad M_R = \begin{pmatrix} B_{\mu\mu} & B_{\mu\tau} \\ B_{\mu\tau} & B_{\tau\tau} \end{pmatrix}, \quad (340)$$

where all the elements are complex in general. The seesaw formula  $M_\nu \simeq -M_D M_R^{-1} M_D^T$  allows us to calculate the light Majorana neutrino mass matrix  $M_\nu$  in the leading-order approximation. Since  $M_R$  is of rank two,  $M_\nu$  must be a rank-two matrix with the vanishing determinant, implying the existence of a massless neutrino! This observation is the most salient feature of the minimal seesaw mechanism, and its validity is independent of the approximation made in deriving the leading-order seesaw formula but guaranteed by the so-called ‘‘seesaw fair play rule’’ — the number of massive light Majorana neutrinos exactly matches that of massive heavy Majorana neutrinos in an arbitrary type-I seesaw scenario [921]. In the basis where  $M_R$  is diagonal and real, a number of generic parametrizations of  $M_D$  have been proposed in the literature [568, 569, 570, 571, 572].

As a consequence, the minimal seesaw mechanism can make a definite prediction for the light Majorana neutrino mass spectrum at the tree level <sup>40</sup>:

$$\text{Normal ordering : } m_1 = 0, \quad m_2 = \sqrt{\Delta m_{21}^2}, \quad m_3 = \sqrt{\Delta m_{31}^2}; \quad (341a)$$

$$\text{Inverted ordering : } m_1 = \sqrt{|\Delta m_{32}^2| - \Delta m_{21}^2}, \quad m_2 = \sqrt{|\Delta m_{32}^2|}, \quad m_3 = 0, \quad (341b)$$

where the values of three neutrino mass-squared differences can be directly read off from Table 9. Because of  $m_1 = 0$  (or  $m_3 = 0$ ), it is always possible to redefine the phases of neutrino fields such that one of the Majorana phases can be rotated away [926]. In other words, there are only *two* nontrivial CP-violating phases in the minimal seesaw mechanism — another salient feature of this simplified but viable seesaw scenario.

In the  $M_l = D_l$  basis one may reconstruct  $M_\nu = U D_\nu U^T$  in terms of three neutrino masses, three flavor mixing angles and two CP-violating phases. With the help of Eq. (341a) or Eq. (341b) together with Tables 9 and 10, we plot the  $3\sigma$  ranges of six independent elements of  $M_\nu$  in Fig. 35. Some immediate comments are in order.

- In the normal neutrino mass hierarchy case,  $M_\nu$  is not allowed to possess any texture zeros. In comparison, one or two of  $\langle m \rangle_{e\mu}$ ,  $\langle m \rangle_{e\tau}$ ,  $\langle m \rangle_{\mu\mu}$  and  $\langle m \rangle_{\tau\tau}$  are still likely to be vanishing or vanishingly small in the inverted hierarchy case, although the corresponding parameter space is strongly restricted. This general observation is consistent with some explicit analyses of the zero textures of  $M_\nu$  in the minimal seesaw framework [563, 927].

<sup>40</sup>Note that  $m_1 = 0$  remains valid at the one-loop level [922, 923, 924, 925], but the two-loop quantum corrections may lead us to  $m_1 \sim 10^{-13}$  eV in the SM or  $m_1 \sim 10^{-10}$  eV  $\cdot (\tan\beta/10)^4$  in the MSSM [925] even if  $m_1 = 0$  originally holds at the tree level (the same observation is true for  $m_3 = 0$ ). Such a vanishingly small neutrino mass can be ignored in most cases because it has little impact on neutrino phenomenology.

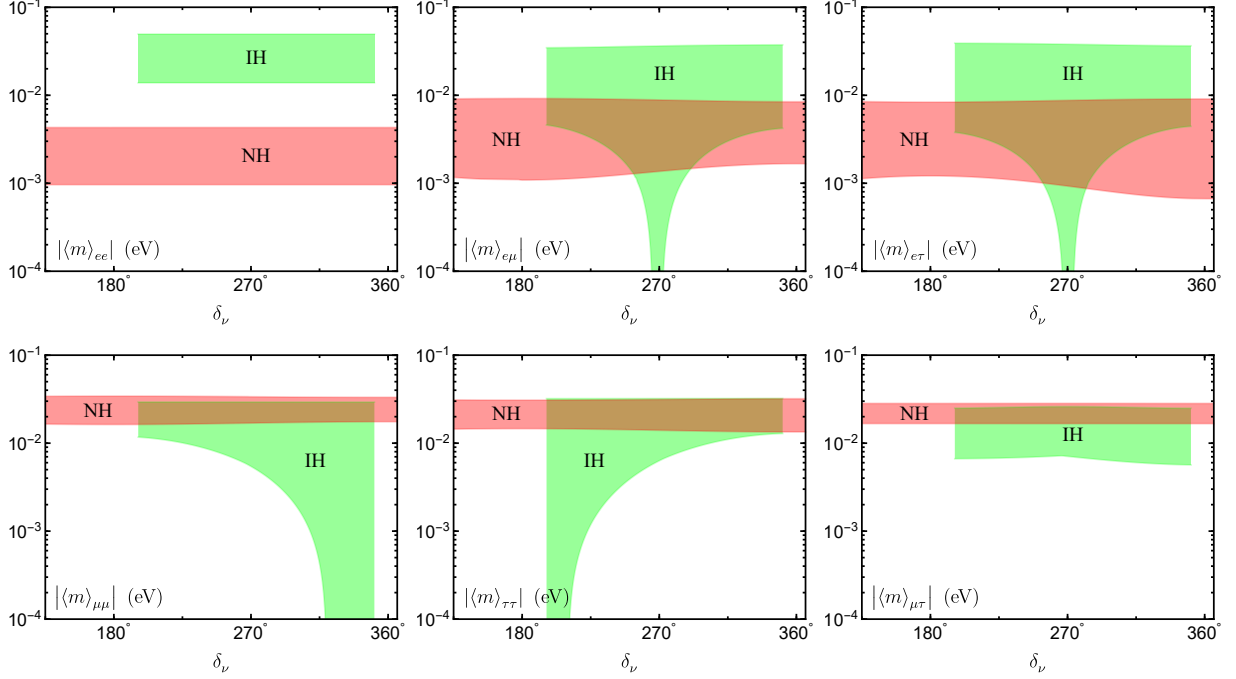

Figure 35: In the minimal seesaw mechanism with a choice of the  $M_l = D_l$  basis, the  $3\sigma$  ranges of six independent elements  $|\langle m \rangle_{\alpha\beta}|$  (for  $\alpha, \beta = e, \mu, \tau$ ) of the Majorana neutrino mass matrix  $M_\nu$  as functions of the CP-violating phase  $\delta_\nu$ , where both the normal neutrino mass hierarchy (NH) and the inverted hierarchy (IH) are taken into account.

- The  $\mu$ - $\tau$  flavor symmetry is favored to a large extent, for both normal and inverted neutrino mass hierarchies. A comparison between Figs. 30 and 35 clearly tells us how powerful or predictive the Occam's razor could be in dealing with the seesaw-related flavor structures. Hence it deserves more attention, at least from a phenomenological point of view [564].

Of course, either the texture zeros or the  $\mu$ - $\tau$  reflection symmetry of  $M_\nu$  should stem from the zeros or symmetries of  $M_D$  and (or)  $M_R$ . A systematic classification of possible zero textures of  $M_D$  and  $M_R$  has been made in Refs. [239, 927] in the minimal seesaw mechanism, and some recent works have also been done to discuss the structures of  $M_D$  and  $M_R$  based on the  $\mu$ - $\tau$  reflection symmetry in this simplified seesaw framework (see, e.g., Refs. [928, 929, 930, 931]).

To illustrate, let us consider the  $\mu$ - $\tau$  reflection symmetry of  $M_D$  and  $M_R$  in Eq. (340) by requiring the neutrino mass terms in the minimal seesaw model to be invariant under the following transformations for the left- and right-handed neutrino fields:

$$\nu_{eL} \leftrightarrow (\nu_{eL})^c, \quad \nu_{\mu L} \leftrightarrow (\nu_{\tau L})^c, \quad \nu_{\tau L} \leftrightarrow (\nu_{\mu L})^c; \quad N_{\mu R} \leftrightarrow (N_{\tau R})^c, \quad N_{\tau R} \leftrightarrow (N_{\mu R})^c. \quad (342)$$

Then the textures of  $M_D$  and  $M_R$  are constrained as follows:

$$M_D = \begin{pmatrix} A_{e\mu} & A_{e\mu}^* \\ A_{\mu\mu} & A_{\mu\tau} \\ A_{\mu\tau}^* & A_{\mu\mu} \end{pmatrix}, \quad M_R = \begin{pmatrix} B_{\mu\mu} & B_{\mu\tau} \\ B_{\mu\tau} & B_{\mu\mu}^* \end{pmatrix}, \quad (343)$$

where  $B_{\mu\tau} = B_{\mu\tau}^*$  holds. The light Majorana neutrino mass matrix  $M_\nu \simeq -M_D M_R^{-1} M_D^T$  turns out to have the same  $\mu$ - $\tau$  reflection symmetry as that given in Eq. (338), and its four independent elements are now given by

$$\begin{aligned}
A_\nu &= 2 \left[ |A_{e\mu}|^2 B_{\mu\tau} + \text{Re} \left( A_{e\mu}^2 B_{\mu\mu} \right) \right] , \\
B_\nu &= A_{e\mu} \left( A_{\mu\mu} B_{\mu\mu} + A_{\mu\tau} B_{\mu\tau} \right) + A_{e\mu}^* \left( A_{\mu\mu} B_{\mu\tau} + A_{\mu\tau} B_{\mu\mu}^* \right) , \\
C_\nu &= A_{\mu\mu}^2 B_{\mu\mu} + A_{\mu\tau}^2 B_{\mu\mu}^* + 2A_{\mu\mu} A_{\mu\tau} B_{\mu\tau} , \\
D_\nu &= \left( |A_{\mu\mu}|^2 + |A_{\mu\tau}|^2 \right) B_{\mu\tau} + 2\text{Re} \left( A_{\mu\mu} A_{\mu\tau}^* B_{\mu\mu} \right) .
\end{aligned} \tag{344}$$

There are certainly several simple ways to explicitly break the  $\mu$ - $\tau$  reflection symmetry of  $M_\nu$  by introducing simple perturbations to either  $M_D$  or  $M_R$  in Eq. (343), or both of them [930]. If the  $\mu$ - $\tau$  reflection symmetry is realized at the seesaw scale  $\Lambda_{\text{SS}}$ , the RGE-induced corrections to  $M_\nu$  may also break this flavor symmetry at the electroweak scale  $\Lambda_{\text{EW}}$ , as already discussed in section 7.1.3.

It is worth pointing out that a further simplified version of the minimal seesaw mechanism, the so-called *littlest* seesaw scenario, has recently been proposed and discussed [562, 932, 933, 934]. In the flavor basis where both  $M_R$  and  $M_l$  are diagonal and real, the elements of  $M_D$  are arranged to satisfy  $A_{e\mu} = 0$ ,  $A_{\mu\mu} = A_{\tau\mu}$  and  $A_{\tau\tau} \propto A_{\mu\tau} \propto A_{e\tau}$ . The resultant  $M_\nu \simeq -M_D M_R^{-1} M_D^T$  only contains three real free parameters in this paradigm (or only two real free parameters if an  $S_4 \times U(1)$  flavor symmetry is taken into account to constrain the CP-violating phase [932]), but it is able to account for the observed neutrino mass spectrum and flavor mixing pattern. In this connection a ‘‘littlest’’ realization of the leptogenesis mechanism and a combination of the  $\mu$ - $\tau$  reflection symmetry with the littlest seesaw model are also possible [935, 936].

It is also worth mentioning that the so-called *minimal* type-III seesaw scenario, in which only two  $SU(2)_L$  fermion triplets are introduced, has recently been proposed and discussed [937]. One of the salient features of this simplified seesaw mechanism is that the lightest active neutrino must be massless, exactly the same as in the minimal (type-I) seesaw case. Its phenomenological consequences on various lepton-flavor-violating and lepton-number-violating processes certainly deserve some further studies [938].

### 7.3.2. The minimal type-(I+II) seesaw scenario

Now let us look at a simplified version of the so-called type-(I+II) seesaw mechanism and its phenomenological consequences on neutrino flavor mixing and thermal leptogenesis. This seesaw scenario is an extension of the SM with both three heavy right-handed neutrino fields  $N_{\alpha R}$  (for  $\alpha = e, \mu, \tau$ ) and an  $SU(2)_L$  Higgs triplet  $\Delta$  which has a superhigh mass scale  $M_\Delta$  [202, 203, 204, 205, 206]<sup>41</sup>, or equivalently a combination of the type-I seesaw in Eq. (30) and the type-II seesaw in Eq. (32). After spontaneous electroweak symmetry breaking the relevant neutrino mass terms can be written in the same way as in Eq. (226):

$$-\mathcal{L}_{\text{I+II}} = \frac{1}{2} \overline{\left[ \nu_L \quad (N_R)^c \right]} \begin{pmatrix} M_L & M_D \\ M_D^T & M_R \end{pmatrix} \begin{bmatrix} (\nu_L)^c \\ N_R \end{bmatrix} + \text{h.c.} , \tag{345}$$

<sup>41</sup>Note that this seesaw scenario had long been referred to as the type-II seesaw mechanism, but since about 2007 it has gradually been renamed as the type-(I+II) seesaw mechanism.



where  $M_L = \lambda_\Delta Y_\Delta v^2 / M_\Delta$  from Eq. (32) and  $M_D = Y_\nu v / \sqrt{2}$  from Eq. (30). If the mass scales of  $M_L$ ,  $M_D$  and  $M_R$  are strongly hierarchical, as one may argue according to 't Hooft's naturalness principle [181], then a diagonalization of the  $6 \times 6$  symmetric mass matrix in Eq. (345) will lead us to the following type-(I+II) seesaw formula in the leading-order approximation:

$$M_\nu \simeq M_L - M_D M_R^{-1} M_D^T. \quad (346)$$

Needless to say, this ‘‘hybrid’’ seesaw scenario generally contains more free parameters as compared with the type-I or type-II seesaw mechanism, although it can naturally be embedded into an SO(10) or left-right symmetric model (see, e.g., Refs. [939, 940, 941]). It can be simplified by reducing the number of heavy Majorana neutrinos from three to one [573, 574, 575, 576], and the resulting scenario is just called the *minimal* type-(I+II) seesaw.

One may simply take  $M_R = M_1$  with  $M_1$  being the mass of the only heavy Majorana neutrino  $N_1$  in the minimal type-(I+II) seesaw mechanism. In this case the second term of  $M_\nu$  in Eq. (346) is of rank one and thus provides a nonzero mass for one of the three light Majorana neutrinos. So the textures of  $M_L$  and  $M_D$  can be arranged to be as simple as possible for interpreting current neutrino oscillation data in the spirit of Occam's razor. For example, the assumptions of  $M_L = m_0 I$  and  $M_D^T = id_0 (1, 1, 1)$  lead us to the same form of  $M_\nu$  as that in Eq. (256):

$$M_\nu \simeq m_0 \begin{pmatrix} 1 & 0 & 0 \\ 0 & 1 & 0 \\ 0 & 0 & 1 \end{pmatrix} + \frac{d_0^2}{M_1} \begin{pmatrix} 1 & 1 & 1 \\ 1 & 1 & 1 \\ 1 & 1 & 1 \end{pmatrix}, \quad (347)$$

which apparently respects the  $S_3$  flavor symmetry [719, 720, 721]. Proper perturbations to the special textures of  $M_L$  and  $M_D$  taken above are therefore expected to generate a realistic texture of  $M_\nu$  with proper  $S_3$  symmetry breaking terms to fit the experimental data.

In general,  $M_L$  and  $M_D$  can be fully reconstructed in terms of  $m_i$  (for  $i = 1, 2, 3$ ) and  $M_1$  together with both the active neutrino mixing parameters in Eq. (205a) and the active-sterile flavor mixing parameters in Eq. (221). The results are

$$M_D \simeq M_1 \begin{pmatrix} \hat{s}_{14}^* \\ \hat{s}_{24}^* \\ \hat{s}_{34}^* \end{pmatrix}, \quad M_L \simeq M_L^0 + M_1 \begin{pmatrix} (\hat{s}_{14}^*)^2 & \hat{s}_{14}^* \hat{s}_{24}^* & \hat{s}_{14}^* \hat{s}_{34}^* \\ \hat{s}_{14}^* \hat{s}_{24}^* & (\hat{s}_{24}^*)^2 & \hat{s}_{24}^* \hat{s}_{34}^* \\ \hat{s}_{14}^* \hat{s}_{34}^* & \hat{s}_{24}^* \hat{s}_{34}^* & (\hat{s}_{34}^*)^2 \end{pmatrix}, \quad (348)$$

where  $\hat{s}_{i4} \equiv e^{i\delta_{i4}} \sin \theta_{i4}$  (for  $i = 1, 2, 3$ ) as defined in section 5.1.1, and

$$\begin{aligned} (M_L^0)_{ee} &= m_1 (c_{12} c_{13})^2 + m_2 (\hat{s}_{12}^* c_{13})^2 + m_3 (\hat{s}_{13}^*)^2, \\ (M_L^0)_{\mu\mu} &= m_1 (\hat{s}_{12} c_{23} + c_{12} \hat{s}_{13} \hat{s}_{23}^*)^2 + m_2 (c_{12} c_{23} - \hat{s}_{12}^* \hat{s}_{13} \hat{s}_{23}^*)^2 + m_3 (c_{13} \hat{s}_{23}^*)^2, \\ (M_L^0)_{\tau\tau} &= m_1 (\hat{s}_{12} \hat{s}_{23} - c_{12} \hat{s}_{13} c_{23})^2 + m_2 (c_{12} \hat{s}_{23} + \hat{s}_{12}^* \hat{s}_{13} c_{23})^2 + m_3 (c_{13} c_{23})^2, \\ (M_L^0)_{e\mu} &= -m_1 c_{12} c_{13} (\hat{s}_{12} c_{23} + c_{12} \hat{s}_{13} \hat{s}_{23}^*) + m_2 \hat{s}_{12}^* c_{13} (c_{12} c_{23} - \hat{s}_{12}^* \hat{s}_{13} \hat{s}_{23}^*) + m_3 c_{13} \hat{s}_{13}^* \hat{s}_{23}^*, \\ (M_L^0)_{e\tau} &= m_1 c_{12} c_{13} (\hat{s}_{12} \hat{s}_{23} - c_{12} \hat{s}_{13} c_{23}) - m_2 \hat{s}_{12}^* c_{13} (c_{12} \hat{s}_{23} + \hat{s}_{12}^* \hat{s}_{13} c_{23}) + m_3 c_{13} \hat{s}_{13}^* c_{23}, \\ (M_L^0)_{\mu\tau} &= -m_1 (\hat{s}_{12} c_{23} + c_{12} \hat{s}_{13} \hat{s}_{23}^*) (\hat{s}_{12} \hat{s}_{23} - c_{12} \hat{s}_{13} c_{23}) - m_2 (c_{12} c_{23} - \hat{s}_{12}^* \hat{s}_{13} \hat{s}_{23}^*) (c_{12} \hat{s}_{23} + \hat{s}_{12}^* \hat{s}_{13} c_{23}) \\ &\quad + m_3 c_{13}^2 c_{23} \hat{s}_{23}^*. \end{aligned} \quad (349)$$

It is obvious that the active-sterile flavor mixing angles must be strongly suppressed in magnitude, and the corresponding phase parameters are responsible for CP violation in the lepton-number-violating decays  $N_1 \rightarrow \ell_\alpha + H$  and  $N_1 \rightarrow \bar{\ell}_\alpha + \bar{H}$  (for  $\alpha = e, \mu, \tau$ ).

Different from the decays of  $N_i$  in the type-I seesaw mechanism, which are described by the tree-level, one-loop vertex correction and self-energy Feynman diagrams in Fig. 6, the decays of  $N_i$  in the type-(I+II) seesaw scenario can also happen via the one-loop vertex correction mediated by the Higgs triplet  $\Delta$  (i.e.,  $N_j$  in Fig. 6(b) can be replaced by  $\Delta$ ) [942, 943, 944]. As a result, the interference between the tree-level and one-loop contributions leads us to the CP-violating asymmetries  $\varepsilon_{i\alpha}$  between  $N_i \rightarrow \ell_\alpha + H$  and  $N_i \rightarrow \bar{\ell}_\alpha + \bar{H}$  decays (for  $i = 1, 2, 3$  and  $\alpha = e, \mu, \tau$ ), as defined in Eq. (50). In the assumption of  $M_1 \ll M_2, M_3$  and  $M_\Delta$ , the flavor-dependent CP-violating asymmetry of  $N_1$  decays turns out to be [172, 945]

$$\varepsilon_{1\alpha} \simeq \frac{3M_1}{8\pi v^2 (Y_\nu^\dagger Y_\nu)_{11}} \sum_\beta \text{Im} \left[ (Y_\nu^*)_{\alpha 1} (Y_\nu^*)_{\beta 1} (M_\nu)_{\alpha\beta} \right], \quad (350)$$

where  $v \simeq 246$  GeV, and  $M_\nu$  has been given in Eq. (346). Once the minimal type-(I+II) seesaw scenario is taken into account, we find that the  $N_1$ -mediated vertex correction and self-energy diagrams of  $N_1$  decays do not really contribute to  $\varepsilon_{1\alpha}$ . So only the  $M_L$  term of  $M_\nu$  is nontrivial in this special case. Given the parametrization of  $M_D$  and the reconstruction of  $M_L$  in Eq. (348), it is actually the  $M_L^0$  component of  $M_L$  that contributes to  $\varepsilon_{1\alpha}$ . If the Fritzsch texture of  $M_l$  and  $M_L$  is assumed, for example, a successful leptogenesis can essentially be realized [573].

### 7.3.3. The minimal inverse seesaw scenario

Although the canonical (type-I) seesaw mechanism is theoretically natural for interpreting the tiny masses of three active neutrinos and the cosmological matter-antimatter asymmetry via leptogenesis, it is unfortunately not testable at any accelerator experiments because its energy scale is too high to be experimentally reachable. To lower the seesaw scale to the TeV scale, there must be a significant ‘‘structural cancellation’’ in the seesaw formula  $M_\nu \simeq -M_D M_R^{-1} M_D^T$ . In fact, it has been found that  $M_\nu$  will vanish in the  $M_R = D_N \equiv \text{Diag}\{M_1, M_2, M_3\}$  basis if

$$M_D = d_0 \begin{pmatrix} y_1 & y_2 & y_3 \\ ay_1 & ay_2 & ay_3 \\ by_1 & by_2 & by_3 \end{pmatrix}, \quad \frac{y_1^2}{M_1} + \frac{y_2^2}{M_2} + \frac{y_3^2}{M_3} = 0 \quad (351)$$

hold simultaneously, where  $a, b$  and  $y_i$  (for  $i = 1, 2, 3$ ) are in general complex [217, 946]. This special texture of  $M_D$  means that some of its elements are not necessarily suppressed in magnitude to assure  $m_i$  to be vanishing, and thus some elements of  $R \simeq M_D D_N^{-1}$  obtained from Eq. (229) are not necessarily small in magnitude to make an appreciable interaction of  $N_i$  (for  $i = 1, 2, 3$ ) with three charged leptons possible [181, 555]. The latter is a necessary condition for the production of a heavy Majorana neutrino with  $M_i \lesssim 1$  TeV at the LHC or other high-energy colliders [579, 601, 947, 948]. To generate tiny neutrino masses  $m_i$ , one may introduce some perturbations to  $M_D$  in Eq. (351). Given  $M'_D = M_D - \epsilon X_D$  with  $\epsilon$  being a small dimensionless parameter (i.e.,  $|\epsilon| \ll 1$ ), for example, one immediately obtain

$$M'_\nu \simeq -M'_D D_N^{-1} M_D^T \simeq \epsilon \left( M_D D_N^{-1} X_D^T + X_D D_N^{-1} M_D^T \right), \quad (352)$$

from which the mass eigenvalues of  $M_\nu$  at or below  $O(0.1)$  eV can definitely be obtained by adjusting the magnitude of  $\epsilon$  [181]. In this case, however, possible collider signatures of  $N_i$  (associated with  $R$ ) are decoupled from the light Majorana neutrino sector (controlled by  $\epsilon$ ) to a large extent.

A relatively natural scenario which can lower the seesaw scale to the TeV scale but avoid a significant structural cancellation is the so-called *inverse* (or *double*) seesaw mechanism [209, 210]. Its idea is to extend the SM by introducing three heavy right-handed neutrino fields  $N_{\alpha R}$  (for  $\alpha = e, \mu, \tau$ ), three SM gauge-singlet neutrinos  $S_{\alpha R}$  (for  $\alpha = e, \mu, \tau$ ) and one scalar singlet  $\Phi$ , such that the lepton-number-violating but gauge-invariant neutrino mass terms can be written as

$$-\mathcal{L}_{\text{inverse}} = \overline{\ell}_L Y_\nu \widetilde{H} N_R + \overline{(N_R)^c} Y_S \Phi S_R + \frac{1}{2} \overline{(S_R)^c} \mu S_R + \text{h.c.}, \quad (353)$$

in which the  $\mu$  term is expected to be naturally small according to 't Hooft's naturalness criterion, simply because lepton number conservation will be restored in Eq. (353) if this term is switched off. After spontaneous gauge symmetry breaking, the neutrino mass terms turn out to be

$$-\mathcal{L}'_{\text{inverse}} = \frac{1}{2} \overline{[v_L \ (N_R)^c \ (S_R)^c]} \begin{pmatrix} 0 & M_D & 0 \\ M_D^T & 0 & M_S \\ 0 & M_S^T & \mu \end{pmatrix} \begin{pmatrix} (v_L)^c \\ N_R \\ S_R \end{pmatrix} + \text{h.c.}, \quad (354)$$

where  $M_D = Y_\nu v / \sqrt{2}$  and  $M_S = Y_S \langle \Phi \rangle$ . Diagonalizing the symmetric  $9 \times 9$  mass matrix in Eq. (354) leads us to the effective light Majorana neutrino mass matrix in the leading-order approximation:

$$M_\nu \simeq M_D (M_S^T)^{-1} \mu (M_S)^{-1} M_D^T. \quad (355)$$

So the tiny mass eigenvalues of  $M_\nu$  can be attributed to the smallness of  $\mu$ , and they are further suppressed by  $M_D/M_S$  and its transpose in the case that the mass scale of  $M_D$  is strongly suppressed as compared with that of  $M_S$ . For instance,  $\mu \sim O(1)$  keV and  $M_D/M_S \sim O(10^{-2})$  will naturally make  $M_\nu$  at the sub-eV scale, and the heavy degrees of freedom in this scenario are expected to be around the experimentally accessible TeV or 10 TeV scales. Note that the heavy sector consists of three pairs of pseudo-Dirac neutrinos whose CP-opposite Majorana components have a tiny mass splitting characterized by the mass scale of  $\mu$  [181], and hence it is very hard to observe any appreciable effects of lepton number violation in practice.

The principle of Occam's razor suggests that the number of free parameters in the inverse seesaw mechanism be reduced by introducing only two pairs of  $N_{\alpha R}$  and  $S_{\alpha R}$  (e.g., for  $\alpha = \mu$  and  $\tau$ ) [560]. This *minimal* inverse seesaw scenario can work well at the TeV scale to interpret current neutrino oscillation data, since the resulting light Majorana neutrino mass matrix  $M_\nu$  is phenomenologically equivalent to the one obtained from the minimal type-I seesaw mechanism in section 7.3.1. The point is that  $M_D$ ,  $M_S$  and  $\mu$  are simplified respectively to the  $3 \times 2$ ,  $2 \times 2$  and  $2 \times 2$  mass matrices, and thus  $M_\nu$  is of rank two and must have a vanishing mass eigenvalue. So the predictability and testability are enhanced in this simplified version of the inverse seesaw mechanism, and its possible collider signatures and low-energy consequences for lepton flavor violation and dark matter have attracted some particular attention [560, 949, 950, 951, 952].

The so-called *littlest* inverse seesaw model, which combines the aforementioned minimal inverse seesaw with an  $S_4$  flavor symmetry, has recently been proposed [953]. The resultant light Majorana neutrino mass matrix  $M_\nu$  is essentially equivalent to the one obtained from the littlest seesaw scenario [562], as briefly discussed in section 7.3.1.

## 7.4. Flavor symmetries and model-building approaches

### 7.4.1. Leptonic flavor democracy and $S_3$ symmetry

It is well known that the  $S_3$  flavor symmetry has played an important role in some pioneering efforts towards understanding the observed flavor mixing patterns of both quarks [132, 133] and leptons [138, 139], partly because the group of this simple symmetry is the minimal non-Abelian discrete group describing the permutations of three objects. But  $S_3$  does not have any irreducible three-dimensional representation, and hence it is not a natural flavor symmetry group for building a realistic three-family flavor model of either leptons or quarks. From the phenomenological point of view, however,  $S_3$  remains a good example for illustrating some salient features of three-family flavor mixing, as discussed in section 6.2.1 for the quark sector. Here let us take a look at the lepton sector by considering flavor democracy for the charged-lepton mass matrix  $M_l$  and the Dirac neutrino mass matrix  $M_D$ , together with  $S_3$  flavor symmetry for the heavy right-handed Majorana neutrino mass matrix  $M_R$  in the canonical seesaw mechanism.

Given the  $SU(2)_L \times U(1)_Y$  gauge-invariant mass terms of charged leptons and neutrinos in the canonical (type-I) seesaw mechanism in Eq. (30), one may obtain the mass matrices  $M_l = Y_l \nu / \sqrt{2}$  and  $M_D = Y_\nu \nu / \sqrt{2}$  together with  $M_R$  itself. Assuming that the leading term of  $M_R$  respects the  $S_3$  symmetry and those of  $M_l$  and  $M_D$  respect the  $S_{3L} \times S_{3R}$  symmetry (i.e., flavor democracy) as shown in Eqs. (255a) and (255b), we can write out

$$M_l = \frac{C_l}{3} \begin{pmatrix} 1 & 1 & 1 \\ 1 & 1 & 1 \\ 1 & 1 & 1 \end{pmatrix} + \Delta M_l, \quad (356a)$$

$$M_D = \frac{C_D}{3} \begin{pmatrix} 1 & 1 & 1 \\ 1 & 1 & 1 \\ 1 & 1 & 1 \end{pmatrix} + \Delta M_D, \quad (356b)$$

$$M_R = \frac{C_R}{3} \left[ \begin{pmatrix} 1 & 1 & 1 \\ 1 & 1 & 1 \\ 1 & 1 & 1 \end{pmatrix} + r \begin{pmatrix} 1 & 0 & 0 \\ 0 & 1 & 0 \\ 0 & 0 & 1 \end{pmatrix} \right] + \Delta M_R, \quad (356c)$$

where  $r$  is a real dimensionless parameter,  $C_x$  (for  $x = l, D$  or  $R$ ) characterizes the absolute mass scale of  $M_x$ , and  $\Delta M_x$  denotes a small perturbation to  $M_x$  and thus breaks its flavor democracy or  $S_3$  symmetry. Note that the latter is not a real flavor symmetry of the leptonic mass terms in Eq. (30); instead, it is just an empirical guiding principle to help fix the basic texture of  $M_x$ . How to explicitly break flavor democracy and  $S_3$  symmetry is an open question [721, 722, 725, 954, 955, 956, 957, 958, 959, 960], and hence whether the textures of  $\Delta M_l$ ,  $\Delta M_D$  and  $\Delta M_R$  are appropriate or not can only be justified by their phenomenological consequences on the lepton mass spectra, flavor mixing angles, CP violation at low energies and even leptogenesis at the seesaw scale. Here we focus on the low-energy phenomenology by simply assuming  $\Delta M_R = 0$  and [961]

$$\Delta M_l = \frac{C_l}{3} \begin{pmatrix} i\xi_l & 0 & 0 \\ 0 & -i\xi_l & 0 \\ 0 & 0 & \zeta_l \end{pmatrix}, \quad \Delta M_D = \frac{C_D}{3} \begin{pmatrix} 0 & 0 & 0 \\ 0 & -\xi_D & 0 \\ 0 & 0 & \zeta_D \end{pmatrix}, \quad (357)$$

where  $0 < \xi_l \ll \zeta_l \ll 1$  and  $0 < r \ll \xi_D^2 \ll \zeta_D^2$  are taken for the purpose of doing the subsequent analytical approximations. Diagonalizing the complex symmetric charged-lepton mass matrix via the transformation  $O_l^\dagger M_l O_l^* = D_l$ , one obtains  $m_\tau \simeq C_l$ ,  $m_\mu \simeq 2\zeta_l C_l/9$  and  $m_e \simeq \xi_l^2 C_l/(6\zeta_l)$  in the leading-order approximation, together with

$$O_l \simeq O_* + \frac{i}{\sqrt{6}} \sqrt{\frac{m_e}{m_\mu}} \begin{pmatrix} 1 & \sqrt{3} & 0 \\ 1 & -\sqrt{3} & 0 \\ -2 & 0 & 0 \end{pmatrix} + \frac{1}{2\sqrt{3}} \frac{m_\mu}{m_\tau} \begin{pmatrix} 0 & \sqrt{2} & -1 \\ 0 & \sqrt{2} & -1 \\ 0 & \sqrt{2} & 2 \end{pmatrix}, \quad (358)$$

where  $O_*$  has been given in Eq. (67). On the other hand, the light Majorana neutrino mass matrix  $M_\nu \simeq -M_D M_R^{-1} M_D^T$  is found to be of the texture

$$M_\nu \simeq -\frac{C_D^2}{3C_R} \left[ \begin{pmatrix} 1 & 1 & 1 \\ 1 & 1 & 1 \\ 1 & 1 & 1 \end{pmatrix} + \frac{1}{3r} \begin{pmatrix} 0 & 0 & 0 \\ 0 & 2\xi_D^2 & \xi_D \zeta_D \\ 0 & \xi_D \zeta_D & 2\zeta_D^2 \end{pmatrix} \right]. \quad (359)$$

Diagonalizing  $M_\nu$  via the transformation  $O_\nu^\dagger M_\nu O_\nu^* = D_\nu$ , one may arrive at a normal neutrino mass spectrum with  $m_1 \simeq C_D^2/(3C_R)$ ,  $m_2 \simeq \xi_D^2 C_D^2/(6rC_R)$  and  $m_3 \simeq 2\zeta_D^2 C_D^2/(9rC_R)$ , together with

$$O_\nu \simeq iS^{(123)} + i \begin{pmatrix} 0 & \frac{m_1}{m_2} & \frac{m_1}{m_3} \\ -\frac{m_1}{m_2} & 0 & \frac{1}{\sqrt{3}} \sqrt{\frac{m_2}{m_3}} \\ -\frac{m_1}{m_3} & -\frac{1}{\sqrt{3}} \sqrt{\frac{m_2}{m_3}} & 0 \end{pmatrix}, \quad (360)$$

in the leading-order approximation, where  $S^{(123)} = I$  has been given in Eq. (253). Then the PMNS matrix  $U = O_l^\dagger O_\nu$  can be achieved from Eqs. (358) and (360), and its leading term is just the democratic flavor mixing pattern  $U_0 = O_*^\dagger$  in Eq. (104). A careful analysis of this phenomenological ansatz shows that it is compatible with current neutrino oscillation data, and a simple perturbation to the texture of  $M_R$  in Eq. (356c) may allow us to interpret the observed cosmological baryon-antibaryon asymmetry of our Universe via the resonant leptogenesis mechanism [961].

Of course, one may also combine flavor democracy and (or)  $S_3$  symmetry with the type-II seesaw mechanism [719, 720, 721] or the type-(I+II) seesaw mechanism [957, 962], so as to explain current experimental data on lepton masses and flavor mixing effects. Although there exists an obvious gap between such phenomenological attempts and a real flavor symmetry model for charged leptons and massive neutrinos, the former can be regarded as a necessary step towards the latter. In fact, a more realistic model-building exercise based on the  $S_3$  flavor symmetry group usually requires an extra symmetry to reduce the number of free parameters or assumes a specific way of breaking  $S_3$  symmetry spontaneously and softly [958, 962, 963, 964, 965, 966, 967, 968, 969, 970, 971]. Since the underlying flavor symmetry is most likely to manifest itself at a high energy scale far above the electroweak scale and the corresponding symmetry group should accommodate  $S_3$  or the empirical  $\mu$ - $\tau$  reflection symmetry, the discussions about  $S_3$  symmetry and its possible breaking actually fit the spirit of a bottom-up approach of model building.

#### 7.4.2. Examples of $A_4$ and $S_4$ flavor symmetries

Since 1998, the three lepton flavor mixing angles have been measured to a good degree of accuracy thanks to a number of robust and successful neutrino oscillation experiments [19]. Given the fact that the observed values of  $\theta_{12}$  and  $\theta_{23}$  are quite close to the special angles  $\angle BAD = \arcsin(1/\sqrt{3}) \simeq 35.3^\circ$  and  $\angle ABC = \arcsin(1/\sqrt{2}) = 45^\circ$  within a cube shown in Fig. 16, one may naturally conjecture that the leading term of the  $3 \times 3$  PMNS matrix  $U$  should be a constant pattern  $U_0$  (e.g., the tribimaximal or democratic flavor mixing pattern) whose nonzero elements are just the square roots of a few simple fractions formed from small integers, such as  $1/\sqrt{2}$ ,  $1/\sqrt{3}$  and  $1/\sqrt{6}$ . Since the latter are very similar to the Clebsch-Gordan coefficients used in compact Lie groups and representation theories, they strongly suggest the existence of a kind of flavor symmetry group behind the observed pattern of lepton flavor mixing. In other words,  $U = U_0 + \Delta U$ , where  $\Delta U$  describes small corrections of flavor symmetry breaking to  $U_0$ . Along this line of thought, many efforts have been made in exploring possible flavor symmetry groups which can easily give rise to  $U_0$  in a reasonable extension of the SM, especially its scalar part. In this connection an underlying flavor symmetry may be Abelian or non-Abelian, continuous or discrete, local or global; and it can be either spontaneously or explicitly broken. But more attention has been paid to the global and discrete flavor symmetry groups as a powerful guiding principle of model building, simply because such a symmetry group has some obvious advantages. For example, it can be embedded in a continuous symmetry group; it may stem from some string compactifications; its spontaneous breaking does not involve any Goldstone bosons; and so on. So far one has examined many simple discrete flavor symmetries, such as  $Z_2$ ,  $Z_3$ ,  $S_3$ ,  $S_4$ ,  $A_4$ ,  $A_5$ ,  $D_4$ ,  $D_5$ ,  $Q_4$ ,  $Q_6$ ,  $\Delta(27)$ ,  $\Delta(48)$  and  $T'$ , to interpret the experimental data on flavor mixing and CP violation [143, 144, 145, 146]. Among them,  $A_4$  and  $S_4$  are found to be most appropriate and promising towards understanding the underlying flavor structures of leptons and quarks.

If  $U_0 = O_l^\dagger O_\nu$  is a constant flavor mixing pattern independent of any free parameters, then the corresponding charged-lepton and neutrino mass matrices  $M_l$  and  $M_\nu$  must have very special textures such that the unitary transformation matrices  $O_l$  and  $O_\nu$  used to diagonalize them are constant matrices. Behind the special flavor structure of  $M_l$  or  $M_\nu$  should be a kind of *residual* flavor symmetry arising from the breaking of a larger flavor symmetry [972, 973, 974]. The latter can be denoted as  $G_{\text{FS}}$ , and its breaking leads us to the residual symmetry groups  $G_l$  and  $G_\nu$  which constrain the textures of  $M_l$  and  $M_\nu$ . In fact, the textures of quark mass matrices discussed in Eqs. (289)—(292) is an example of this sort with  $G_u = G_d$  for the up- and down-type quark sectors. That is why we are left with  $O_u = O_d = U_\omega$  and thus a constant (and trivial) CKM matrix  $V = I$ . Now let us follow Refs. [455, 457, 458, 807, 809] to illustrate how to obtain the constant tribimaximal neutrino mixing pattern in Eq. (106) from  $A_4$  symmetry breaking.

To be explicit, we introduce three Higgs doublets  $\Phi_i$  (for  $i = 1, 2, 3$ ) for the charged-lepton sector as for the quark sector in Eq. (289), and three right-handed neutrino fields  $N_{\alpha R}$  (for  $\alpha = e, \mu, \tau$ ), one Higgs doublet  $\phi$  and three flavon fields  $\chi_i$  (for  $i = 1, 2, 3$ ) for the neutrino sector. These scalar and lepton fields, together with the SM lepton fields, are placed in the representations of the  $A_4$  symmetry group as follows:

$$\begin{aligned} \ell_L &= (\ell_{eL}, \ell_{\mu L}, \ell_{\tau L})^T \sim \underline{\mathbf{3}}, & N_R &= (N_{eR}, N_{\mu R}, N_{\tau R})^T \sim \underline{\mathbf{3}}, & E_{eR} &\sim \underline{\mathbf{1}}, & E_{\mu R} &\sim \underline{\mathbf{1}}', & E_{\tau R} &\sim \underline{\mathbf{1}}''; \\ \Phi &= (\Phi_1, \Phi_2, \Phi_3)^T \sim \underline{\mathbf{3}}, & \phi &\sim \underline{\mathbf{1}}, & \chi &= (\chi_1, \chi_2, \chi_3)^T \sim \underline{\mathbf{3}}. \end{aligned} \quad (361)$$

The gauge-invariant lepton mass terms, which are invariant under  $A_4$ , can be written as

$$\begin{aligned}
-\mathcal{L}_{\text{lepton}} = & \lambda_l (\bar{\ell}_L \Phi)_{\underline{1}} (E_{eR})_{\underline{1}} + \lambda'_l (\bar{\ell}_L \Phi)_{\underline{1}'} (E_{\tau R})_{\underline{1}''} + \lambda''_l (\bar{\ell}_L \Phi)_{\underline{1}''} (E_{\mu R})_{\underline{1}'} \\
& + \lambda_\nu (\bar{\ell}_L N_R)_{\underline{1}} (\tilde{\phi})_{\underline{1}} + M \left[ \overline{(N_R)^c} N_R \right]_{\underline{1}} + \lambda_\chi \left[ \overline{(N_R)^c} N_R \right]_{\underline{3}} \cdot (\chi)_{\underline{3}} + \text{h.c.}, \quad (362)
\end{aligned}$$

where  $\tilde{\phi} = i\sigma_2 \phi^*$ . After the scalar fields  $\Phi_i$  and  $\phi$  acquire their respective vacuum expectation values  $\langle \Phi_i^0 \rangle \equiv v_i$  (for  $i = 1, 2, 3$ ) and  $\langle \phi^0 \rangle \equiv v_\phi$  while the flavon fields  $\chi_i$  acquire their vacuum expectation values  $\langle \chi_i \rangle \equiv v_{\chi_i}$  (for  $i = 1, 2, 3$ ), the charged-lepton mass matrix  $M_l$  and the right-handed Majorana neutrino mass matrix  $M_R$  turn out to be

$$M_l = \begin{pmatrix} \lambda_l v_1 & \lambda'_l v_1 & \lambda''_l v_1 \\ \lambda_l v_2 & \lambda'_l \omega v_2 & \lambda''_l \omega^2 v_2 \\ \lambda_l v_3 & \lambda'_l \omega^2 v_3 & \lambda''_l \omega v_3 \end{pmatrix}, \quad M_R = \begin{pmatrix} M & M_{\chi_3} & M_{\chi_2} \\ M_{\chi_3} & M & M_{\chi_1} \\ M_{\chi_2} & M_{\chi_1} & M \end{pmatrix}, \quad (363)$$

but the Dirac neutrino mass matrix  $M_D$  is given by  $M_D = \lambda_\nu v_\phi I$ . Assuming  $v_1 = v_2 = v_3 \equiv v$ ,  $v_{\chi_1} = v_{\chi_3} = 0$  and  $M > M_{\chi_2} \gg \lambda_\nu v_\phi$ , we use the seesaw formula  $M_\nu \simeq -M_D M_R^{-1} M_D^T$  and obtain

$$M_l = \sqrt{3} v U_\omega \begin{pmatrix} \lambda_l & 0 & 0 \\ 0 & \lambda'_l & 0 \\ 0 & 0 & \lambda''_l \end{pmatrix}, \quad M_\nu \simeq -\frac{\lambda_\nu^2 v_\phi^2}{M} \begin{pmatrix} \xi & 0 & -\zeta \\ 0 & 1 & 0 \\ -\zeta & 0 & \xi \end{pmatrix}, \quad (364)$$

where  $U_\omega$  has been given in Eq. (103),  $\xi \equiv M^2/(M^2 - M_{\chi_2}^2)$  and  $\zeta \equiv M M_{\chi_2}/(M^2 - M_{\chi_2}^2)$  have been defined. Diagonalizing  $M_l$  and  $M_\nu$  in Eq. (364) leads us to a constant flavor mixing matrix<sup>42</sup>

$$U_0 = \frac{i}{\sqrt{2}} U_\omega^\dagger \begin{pmatrix} 1 & 0 & -1 \\ 0 & \sqrt{2} & 0 \\ 1 & 0 & 1 \end{pmatrix} = \frac{1}{\sqrt{6}} P_l \begin{pmatrix} -2 & \sqrt{2} & 0 \\ 1 & \sqrt{2} & -\sqrt{3} \\ 1 & \sqrt{2} & \sqrt{3} \end{pmatrix} P_\nu, \quad (365)$$

where “i” comes from the negative sign of the seesaw formula,  $P_l = \text{Diag}\{1, \omega^*, \omega\}$  and  $P_\nu = \text{Diag}\{-i, +i, -1\}$ . So we are left with the tribimaximal flavor mixing pattern as the leading term of the PMNS matrix  $U$  in this simple  $A_4$  flavor symmetry model. Since the experimental discovery of  $\theta_{13} \sim 9^\circ$  in 2012 [15], more realistic model-building exercises based on  $A_4$  have essentially gone beyond the initial goal of simply deriving a constant flavor mixing matrix (see, e.g., Refs. [976, 977, 978, 979, 980, 981, 982, 983, 984, 985, 986]).

In comparison with  $A_4$ , the flavor symmetry group  $S_4$  is the unique finite group capable of yielding the tribimaximal flavor mixing pattern for all the Yukawa couplings [462, 974]. It is a non-Abelian group describing all the permutations of four objects and possesses twenty-four elements belonging to five conjugacy classes, with  $\underline{1}$ ,  $\underline{1}'$ ,  $\underline{2}$ ,  $\underline{3}$  and  $\underline{3}'$  as its irreducible representations. The multiplication rules of two three-dimensional representations of  $S_4$  are quite similar to those of  $A_4$

<sup>42</sup>In the literature most authors have neglected small and non-unitary corrections to  $U_0$ , which are generally inherent in such  $A_4$  flavor symmetry models and can arise from both the charged-lepton and neutrino sectors [975].

(i.e.,  $\underline{\mathbf{3}} \otimes \underline{\mathbf{3}} = \underline{\mathbf{1}} \oplus \underline{\mathbf{2}} \oplus \underline{\mathbf{3}}_S \oplus \underline{\mathbf{3}}'_A$ ,  $\underline{\mathbf{3}}' \otimes \underline{\mathbf{3}}' = \underline{\mathbf{1}} \oplus \underline{\mathbf{2}} \oplus \underline{\mathbf{3}}_S \oplus \underline{\mathbf{3}}'_A$  and  $\underline{\mathbf{3}} \otimes \underline{\mathbf{3}}' = \underline{\mathbf{1}}' \oplus \underline{\mathbf{2}} \oplus \underline{\mathbf{3}}'_S \oplus \underline{\mathbf{3}}'_A$ ), and the two-dimensional representation behaves exactly as its  $S_3$  counterpart (i.e.,  $\underline{\mathbf{2}} \otimes \underline{\mathbf{2}} = \underline{\mathbf{1}} \oplus \underline{\mathbf{1}}' \oplus \underline{\mathbf{2}}$ ) [987]. That is why the three families of leptons or quarks can naturally be organized into one of the three-dimensional representations of  $S_4$ , and the corresponding residual symmetries can be defined in the same representation. If  $G_{\text{FS}} = S_4$  is broken to  $G_l = Z_3$  and  $G_v = K_4$ , where  $K_4$  is the Klein group with four elements, one may easily show that  $M_l$  is diagonal and  $M_\nu$  has a “magic” texture of the form [736, 988]

$$M_\nu = m_0 I + \begin{pmatrix} 2y_\nu & -y_\nu & -y_\nu \\ -y_\nu & x_\nu + y_\nu & -x_\nu \\ -y_\nu & -x_\nu & x_\nu + y_\nu \end{pmatrix}, \quad (366)$$

whose row sums and column sums are all identical to  $m_0$ . Then the tribimaximal neutrino mixing pattern can be derived from this texture of  $M_\nu$  in a straightforward way [462, 974]. Of course, such an example is just for the purpose of illustration, because it is absolutely unclear whether the tribimaximal flavor mixing pattern is really the leading term of the observed pattern of lepton flavor mixing or not. So far a lot of efforts have been made in building lepton mass models and explaining neutrino oscillation data based on the  $S_4$  flavor symmetry group (see, e.g., Refs. [459, 460, 461, 989, 990, 991, 992, 993, 994, 995, 996, 997, 998, 999, 1000, 1001, 1002]).

The above examples provide us with a simple but instructive recipe for model building, and its basic ingredients can be summarized as follows [971]: (a) choose a proper discrete symmetry group  $G_{\text{FS}}$ , write down its possible irreducible representations and figure out all of their multiplication decompositions; (b) assign the fermion and scalar fields of the SM or its extension to the representations of the chosen symmetry group; (c) write out the Yukawa structure of the model in accordance with the particle content and the given representations, which is invariant under  $G_{\text{FS}}$ ; (d) obtain the fermion mass matrices after the flavor symmetry  $G_{\text{FS}}$  is spontaneously broken (i.e., after the relevant scalar fields acquire their respective vacuum expectation values) to the residual symmetry groups  $G_l$  and  $G_v$  in the lepton sector or  $G_u$  and  $G_d$  in the quark sector; (e) work out the fermion mass spectra and flavor mixing patterns of leptons and quarks, and then confront them with current experimental tests.

If more than one Higgs doublets are introduced in such flavor symmetry models, their consequences on various flavor-changing processes beyond the SM have to be examined. If one insists on using only the Higgs doublet of the SM, then the effective non-renormalizable interactions have to be taken into account to support the discrete flavor symmetry. In either case some hypothetical gauge-singlet scalar (flavon) fields are required. That is why such flavor symmetry models are typically associated with many unknown degrees of freedom which are normally put into a hidden dustbin in most of today’s model-building exercises, simply because many of those new particles or parameters are experimentally inaccessible at present or in the foreseeable future. On the other hand, the variety of flavor symmetry models makes it practically hard to judge which flavor symmetry group is closer to the truth [722, 816].

#### 7.4.3. Generalized CP and modular symmetries

Given a non-Abelian discrete flavor symmetry, the model-building approach described above is sometimes categorized as the *conventional* approach. It has recently been improved or extended



in two aspects: on the one hand, the flavor symmetry group is combined with the ‘‘generalized CP’’ (GCP) transformation [1003, 1004] so as to predict or constrain the Majorana phases of CP violation; on the other hand, the flavor symmetry group is combined with the ‘‘modular’’ invariance concept borrowed from superstring theories [814, 1005] so as to minimize the number of flavon fields and enhance the predictability of the model. Here we give a brief introduction to the GCP and modular symmetries associated with discrete flavor symmetries.

A theoretical reason for introducing the concept of GCP lies in the fact that the canonical CP transformation is not always consistent with the non-Abelian discrete flavor symmetries. In the context of such a flavor symmetry group  $G_{\text{FS}}$ , let us consider a scalar multiplet  $\Phi(t, \mathbf{x})$  which belongs to an irreducible representation of  $G_{\text{FS}}$  and transforms under the action of  $G_{\text{FS}}$  as  $\Phi(t, \mathbf{x}) \xrightarrow{g} \rho(g)\Phi(t, \mathbf{x})$  with  $g \in G_{\text{FS}}$ , where  $\rho(g)$  denotes the unitary representation matrix for the element  $g$  in the given irreducible representation. Now let us define the CP transformation of  $\Phi(t, \mathbf{x})$  as  $\Phi(t, \mathbf{x}) \xrightarrow{\text{CP}} \mathcal{X}\Phi^*(t, -\mathbf{x})$ , where  $\mathcal{X}$  is unitary in order to keep the kinetic term of  $\Phi$  invariant. So the cases of  $\mathcal{X} = I$  and  $\mathcal{X} \neq I$  correspond to the canonical and generalized CP transformations, respectively. A successive implementation of the GCP transformation, the flavor symmetry transformation  $g \in G_{\text{FS}}$  and the inverse GCP transformation of  $\Phi(t, \mathbf{x})$  leads us to

$$\Phi(t, \mathbf{x}) \xrightarrow{\text{CP}} \mathcal{X}\Phi^*(t, -\mathbf{x}) \xrightarrow{g} \mathcal{X}\rho^*(g)\Phi^*(t, -\mathbf{x}) \xrightarrow{\text{CP}^{-1}} \mathcal{X}\rho^*(g)\mathcal{X}^{-1}\Phi(t, \mathbf{x}) . \quad (367)$$

Then the consistency requirement dictates  $\mathcal{X}\rho^*(g)\mathcal{X}^{-1}$  to be a flavor symmetry transformation of  $G_{\text{FS}}$  and thus hold for all the irreducible representations of  $G_{\text{FS}}$ . In other words,  $\mathcal{X}\rho^*(g)\mathcal{X}^{-1} = \rho(g')$ , where  $g'$  is also an element of  $G_{\text{FS}}$  (i.e.,  $g, g' \in G_{\text{FS}}$ ). It is then sufficient to arrange  $\mathcal{X}$  to be consistent with the generators of  $G_{\text{FS}}$ , and all the  $\mathcal{X}$  matrices satisfying Eq. (367) constitute a representation of the automorphism group of  $G_{\text{FS}}$ . Given  $\mathcal{X}$  as a solution to Eq. (367),  $\rho(g)\mathcal{X}$  is also a solution but it provides us with nothing new. So the GCP transformations of physical interest are given by the aforementioned automorphism group of  $G_{\text{FS}}$  after those equivalent ones have been removed, leaving a new group  $H_{\text{CP}}$  to us. The overall group constituted by  $G_{\text{FS}}$  and  $H_{\text{CP}}$  is therefore isomorphic to their semi-direct product  $G_{\text{FS}} \rtimes H_{\text{CP}}$  [1003, 1004, 1006].

Let us proceed to take a look at some physical implications of the GCP transformations. By definition, the GCP symmetries constrain the charged-lepton and Majorana neutrino mass matrices in the following way [440]:

$$\mathcal{X}^\dagger (M_l M_l^\dagger) \mathcal{X} = (M_l M_l^\dagger)^* , \quad \mathcal{X}^\dagger M_\nu \mathcal{X}^* = M_\nu^* . \quad (368)$$

Given  $O_l^\dagger M_l M_l^\dagger O_l = D_l^2 \equiv \text{Diag}\{m_e^2, m_\mu^2, m_\tau^2\}$  and  $O_\nu^\dagger M_\nu O_\nu^* = D_\nu \equiv \text{Diag}\{m_1, m_2, m_3\}$  as discussed in sections 2.1.2 and 2.2.1, we simply obtain

$$\mathcal{X}_l^\dagger D_l^2 \mathcal{X}_l = D_l^2 \quad \text{with} \quad \mathcal{X}_l \equiv O_l^\dagger \mathcal{X} O_l^* , \quad \mathcal{X}_\nu^\dagger D_\nu \mathcal{X}_\nu^* = D_\nu \quad \text{with} \quad \mathcal{X}_\nu = O_\nu^\dagger \mathcal{X} O_\nu^* . \quad (369)$$

So  $\mathcal{X}_l$  must be a diagonal phase matrix, and  $\mathcal{X}_\nu$  is also diagonal but its finite entries are  $\pm 1$ . The PMNS matrix  $U = O_l^\dagger O_\nu$  turns out to satisfy  $\mathcal{X}_l^\dagger U \mathcal{X}_\nu = U^*$ , implying that  $U$  can only accommodate some trivial CP phases [1007, 1008]. That is why the GCP symmetry has to be broken in order to generate nontrivial CP-violating effects. A simple but phenomenologically interesting way of

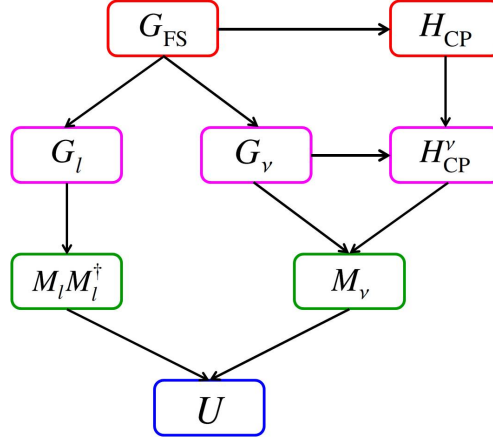

Figure 36: A schematic illustration of how to derive the PMNS lepton flavor mixing matrix  $U$  in the direct model-building approach, with the help of a combination of the non-Abelian discrete flavor symmetry group  $G_{\text{FS}}$  and the generalized CP symmetry group  $H_{\text{CP}}$ . Here we focus on the case of  $G_\nu = Z_2$  for the sake of simplicity.

breaking  $G_{\text{FS}} \times H_{\text{CP}}$  is to preserve the residual symmetry  $G_l$  in the charged-lepton sector and the residual symmetry  $G_\nu \times H_{\text{CP}}$  with  $G_\nu = Z_2$  in the neutrino sector [1003], as schematically illustrated in Fig. 36<sup>43</sup>. One may accomplish this aim by requiring the vacuum expectation values of the flavon fields in the charged-lepton and neutrino sectors to satisfy the conditions  $\mathcal{T}\langle\phi_l\rangle = \langle\phi_l\rangle$  and  $\mathcal{S}\langle\phi_\nu\rangle = \mathcal{X}\langle\phi_\nu\rangle^* = \langle\phi_\nu\rangle$ , where  $\mathcal{T}$ ,  $\mathcal{S}$  and  $\mathcal{X}$  are the representation matrices for the generators of  $G_l$ ,  $Z_2$  and  $H_{\text{CP}}^\nu$ , respectively. Moreover,  $\mathcal{X}\mathcal{S}^*\mathcal{X}^{-1} = \mathcal{S}$  is required to make  $Z_2$  and  $H_{\text{CP}}^\nu$  commutable. Since  $\mathcal{S}^2 = I$ , it is always possible to diagonalize  $\mathcal{S}$  by means of a unitary matrix  $O_S$ ; namely,  $O_S^\dagger \mathcal{S} O_S = D_S = \pm \text{Diag}\{-1, 1, -1\}$ , where the first and third eigenvalues of  $\mathcal{S}$  are chosen to be degenerate. In this case  $O_S$  can be redefined by carrying out a complex (1,3) rotation [440]. Combining this freedom with the requirement  $\mathcal{X}\mathcal{S}^*\mathcal{X}^{-1} = \mathcal{S}$  allows us to arrive at  $O_S O_S^T = \mathcal{X}$ . The invariance of  $M_\nu$  under  $Z_2 \times H_{\text{CP}}^\nu$  means  $\mathcal{S}^\dagger M_\nu \mathcal{S}^* = M_\nu$  and  $\mathcal{X}^\dagger M_\nu \mathcal{X}^* = M_\nu^*$ , from which we obtain  $D_S O_S^\dagger M_\nu O_S^* = O_S^\dagger M_\nu O_S^* D_S$  and  $O_S^\dagger M_\nu O_S^* = (O_S^\dagger M_\nu O_S^*)^*$ , respectively. So the real and symmetric matrix  $O_S^\dagger M_\nu O_S^*$  can easily be diagonalized by a real (1,3) rotation matrix  $O_{13}(\theta_*)$ . With the help of these arrangements, the PMNS lepton flavor mixing matrix is given by  $U = O_l^\dagger O_S O_{13}(\theta_*) P_\nu$  [1003], where  $O_l$  is determined by  $G_l$  and  $P_\nu$  serves as the diagonal Majorana phase matrix. Note that  $U$  is essentially a constant matrix modified by a single free parameter  $\theta_*$  in this approach, in which  $\theta_*$  plays an important role in producing nonzero  $\theta_{13}$ .

The above approach is sometimes referred to as the *direct* model-building approach, in which the CP-violating phases are purely fixed by the  $G_{\text{FS}} \times H_{\text{CP}}$  group structures. This approach typically predicts  $0, \pm\pi/2$  or  $\pi$  for the relevant CP phases (see, e.g., Refs. [1010, 1011, 1012, 1013]), unless a larger flavor symmetry group is chosen (see, e.g., Refs. [1014, 1015]). In this connection the so-called *indirect* model-building approach provides a possible way out. Its strategy is to choose

<sup>43</sup>This plot can be compared with the conventional flow scheme [1009] for deriving the lepton flavor mixing matrix  $U$  from  $M_l$  and  $M_\nu$  based on either continuous or discrete flavor symmetries.

a non-Abelian discrete flavor symmetry group  $G_{\text{FS}}$  which is consistent with the canonical CP transformation, such as  $S_3$ ,  $A_4$ ,  $S_4$  and  $A_5$  [1004, 1011, 1016], and introduce the nontrivial CP-violating phases with the help of the complex vacuum expectation value of a flavon field  $\phi$  which transforms trivially with respect to  $G_{\text{FS}}$  [1017, 1018, 1019, 982, 1020].

Now we turn to the modular transformation and its subgroup symmetries. In a superstring theory the torus compactification is perhaps the simplest way to make the extra six dimensions of space compactified. The two-dimensional torus can be constructed as  $\mathbb{R}^2$  divided by a two-dimensional lattice  $\Lambda$ , which is spanned by the vectors  $(\alpha_1, \alpha_2) = (2\pi R, 2\pi R\tau)$  with  $R$  being real and  $\tau$  being a complex *modulus* parameter [814, 1005, 1021, 1022]. Since the same lattice can also be described in another basis,

$$\begin{pmatrix} \alpha'_2 \\ \alpha'_1 \end{pmatrix} = \begin{pmatrix} a & b \\ c & d \end{pmatrix} \begin{pmatrix} \alpha_2 \\ \alpha_1 \end{pmatrix}, \quad (370)$$

where  $a, b, c$  and  $d$  are integers and satisfy  $ad - bc = 1$ , the modulus parameter  $\tau$  transforms as

$$\tau = \frac{\alpha_2}{\alpha_1} \longrightarrow \tau' = \frac{\alpha'_2}{\alpha'_1} = \frac{a\tau + b}{c\tau + d}. \quad (371)$$

This modular transformation is generated by  $S : \tau \rightarrow -1/\tau$  (duality) and  $T : \tau \rightarrow \tau + 1$  (discrete translational symmetry), which satisfy the algebraic relations  $S^2 = I$  and  $(ST)^3 = I$ . If  $T^N = I$  is required, one is left with the finite subgroups  $\Gamma_N$  which are isomorphic to some even permutation groups. In particular,  $\Gamma_2 \simeq S_3$ ,  $\Gamma_3 \simeq A_4$ ,  $\Gamma_4 \simeq S_4$  and  $\Gamma_5 \simeq A_5$  [1005]. The holomorphic functions transforming as  $f(\tau) \rightarrow (c\tau + d)^k f(\tau)$  under the modular transformation in Eq. (371) are called the modular forms of weight  $k$ . String theories on torus  $T^2$  and orbifolds  $T^2/Z_N$  have the modular symmetry, so do the four-dimensional low-energy effective theories (e.g., a supergravity theory) on the compactifications  $T^2 \otimes X_4$  and  $(T^2/Z_N) \otimes X_4$  with  $X_4$  being a four-dimensional compact space [1021, 1022]. Given the above  $\tau \rightarrow \tau'$  transformation, the chiral superfields  $\phi^{(l)}$  transform as  $\phi^{(l)} \rightarrow (c\tau + d)^{-k_l} \rho^{(l)}(\gamma) \phi^{(l)}$ , where  $-k_l$  is the so-called modular weight and  $\rho^{(l)}(\gamma)$  stands for a unitary representation matrix of  $\gamma \in \Gamma_N$  [1023].

It becomes clear that the modular groups  $\Gamma_{2,\dots,5}$  can find some interesting applications in understanding the flavor structures of leptons and quarks. A big difference between the modular symmetry and a usual discrete flavor symmetry is that the former dictates the Yukawa-like couplings to be the functions of the modulus parameter  $\tau$  and transform in a nontrivial way under  $\Gamma_N$ , whereas the latter only acts on the fermion and scalar fields. To describe the dependence of the Yukawa-like couplings on  $\tau$ , it has been found that the Dedekind  $\eta$ -function  $\eta(\tau) = q^{1/24}(1-q)(1-q^2)(1-q^3)\cdots$  with  $q = \exp(i2\pi\tau)$  is a good example of this kind [814], which satisfies

$$\eta(-1/\tau) = \eta(\tau) \sqrt{-i\tau}, \quad \eta(\tau + 1) = \eta(\tau) \exp(i\pi/12), \quad (372)$$

corresponding to the aforementioned duality and discrete translational transformations.

For the modular group  $\Gamma_3 \sim A_4$ , there are three linearly independent modular forms of the lowest nontrivial weight  $k = 2$ , denoted as  $Y_i(\tau)$  (for  $i = 1, 2, 3$ ). They transform in the three-dimensional representation of  $A_4$  and can be explicitly written out in terms of the Dedekind  $\eta$ -

function  $\eta(\tau)$  and its derivative  $\dot{\eta}(\tau)$  [814]:

$$\begin{aligned} Y_1(\tau) &= \frac{i}{2\pi} \left[ \frac{\dot{\eta}(\tau/3)}{\eta(\tau/3)} + \frac{\dot{\eta}(\tau/3 + 1/3)}{\eta(\tau/3 + 1/3)} + \frac{\dot{\eta}(\tau/3 + 2/3)}{\eta(\tau/3 + 2/3)} - 27 \frac{\dot{\eta}(3\tau)}{\eta(3\tau)} \right] = 1 + 12q + 36q^2 + 12q^3 + \dots, \\ Y_2(\tau) &= \frac{-i}{\pi} \left[ \frac{\dot{\eta}(\tau/3)}{\eta(\tau/3)} + \omega^2 \frac{\dot{\eta}(\tau/3 + 1/3)}{\eta(\tau/3 + 1/3)} + \omega \frac{\dot{\eta}(\tau/3 + 2/3)}{\eta(\tau/3 + 2/3)} \right] = -6q^{1/3} (1 + 7q + 8q^2 + \dots), \\ Y_3(\tau) &= \frac{-i}{\pi} \left[ \frac{\dot{\eta}(\tau/3)}{\eta(\tau/3)} + \omega \frac{\dot{\eta}(\tau/3 + 1/3)}{\eta(\tau/3 + 1/3)} + \omega^2 \frac{\dot{\eta}(\tau/3 + 2/3)}{\eta(\tau/3 + 2/3)} \right] = -18q^{2/3} (1 + 2q + 5q^2 + \dots), \end{aligned} \quad (373)$$

where  $\omega = \exp(i2\pi/3)$  and  $q = \exp(i2\pi\tau)$  have been given before. From the  $q$ -expansion we see that  $Y_i(\tau)$  satisfy the constraint  $[Y_2(\tau)]^2 + 2Y_1(\tau)Y_3(\tau) = 0$ . Note that the overall coefficient of  $Y_i(\tau)$  in Eq. (373) is just a choice, because it cannot be fixed from the modular  $A_4$  symmetry itself. Writing  $Y_1(\tau)$ ,  $Y_2(\tau)$  and  $Y_3(\tau)$  as a column vector  $Y(\tau) = [Y_1(\tau), Y_2(\tau), Y_3(\tau)]^T$ , we have  $Y(-1/\tau) = \tau^2 \rho(S)Y(\tau)$  and  $Y(\tau + 1) = \rho(T)Y(\tau)$  under the modular  $A_4$  transformation, where the unitary transformation matrices  $\rho(S)$  and  $\rho(T)$  are given by

$$\rho(S) = \frac{1}{3} \begin{pmatrix} -1 & 2 & 2 \\ 2 & -1 & 2 \\ 2 & 2 & -1 \end{pmatrix}, \quad \rho(T) = \begin{pmatrix} 1 & 0 & 0 \\ 0 & \omega & 0 \\ 0 & 0 & \omega^2 \end{pmatrix}. \quad (374)$$

In addition to an early and general description of some typical finite modular symmetry groups and their possible phenomenological applications [1005], some concrete model-building exercises based on modular  $A_4$  [814, 815, 816, 1021, 1022, 1024, 1025, 1026, 1027, 1028, 1029], modular  $S_3$  [819], modular  $S_4$  [1030, 1031, 1032, 1033, 1034, 1035] and modular  $A_5$  [1036, 1037] have recently been done to interpret the flavor structures of leptons and (or) quarks.

Here we just follow Ref. [1024] to briefly illustrate how a modular  $A_4$  symmetry allows us to determine or constrain the textures of lepton mass matrices in the MSSM framework combined with the canonical seesaw scenario. The assignments of the irreducible representations of  $A_4$  and the modular weights to the MSSM fields and right-handed neutrino superfields in this model are summarized as follows:

$$\begin{aligned} \ell_L = (\ell_{eL}, \ell_{\mu L}, \ell_{\tau L})^T &\sim \underline{\mathbf{3}}, \quad N_R = (N_{eR}, N_{\mu R}, N_{\tau R})^T \sim \underline{\mathbf{3}}, \quad E_{eR} \sim \underline{\mathbf{1}}, \quad E_{\mu R} \sim \underline{\mathbf{1}}'', \quad E_{\tau R} \sim \underline{\mathbf{1}}'; \\ H_1 &\sim \underline{\mathbf{1}}, \quad H_2 \sim \underline{\mathbf{1}}, \quad Y(\tau) \sim \underline{\mathbf{3}}, \end{aligned} \quad (375)$$

together with  $k_l = 1$  for  $\ell_L$ ,  $N_R$  and  $E_R$ ;  $k_l = 0$  for  $H_1$  and  $H_2$ ; and  $k = 2$  for  $Y(\tau)$ . Then one may write out the gauge-invariant and modular-invariant mass terms of charged leptons and massive neutrinos as the following superpotential:

$$\begin{aligned} \mathcal{W}_{\text{lepton}} &= \alpha_l (E_{eR})_{\underline{\mathbf{1}}}(H_1)_{\underline{\mathbf{1}}}[ \ell_L Y(\tau) ]_{\underline{\mathbf{1}}} + \beta_l (E_{\mu R})_{\underline{\mathbf{1}}''}(H_1)_{\underline{\mathbf{1}}}[ \ell_L Y(\tau) ]_{\underline{\mathbf{1}}'} + \gamma_l (E_{\tau R})_{\underline{\mathbf{1}}'}(H_1)_{\underline{\mathbf{1}}}[ \ell_L Y(\tau) ]_{\underline{\mathbf{1}}''} \\ &\quad + g_1 (N_R)_{\underline{\mathbf{3}}}(H_2)_{\underline{\mathbf{1}}}[ \ell_L Y(\tau) ]_{\underline{\mathbf{3}}_s} + g_2 (N_R)_{\underline{\mathbf{3}}}(H_2)_{\underline{\mathbf{1}}}[ \ell_L Y(\tau) ]_{\underline{\mathbf{3}}_A} \\ &\quad + M_0 (N_R N_R)_{\underline{\mathbf{3}}_s} \cdot [Y(\tau)]_{\underline{\mathbf{3}}}. \end{aligned} \quad (376)$$

After spontaneous gauge symmetry breaking, we are left with [1024]

$$M_l = \begin{pmatrix} Y_1^* & Y_2^* & Y_3^* \\ Y_3^* & Y_1^* & Y_2^* \\ Y_2^* & Y_3^* & Y_1^* \end{pmatrix} \begin{pmatrix} \alpha_l & 0 & 0 \\ 0 & \beta_l & 0 \\ 0 & 0 & \gamma_l \end{pmatrix}, \quad (377)$$

where the coefficients  $\alpha_l$ ,  $\beta_l$  and  $\gamma_l$  characterize the mass scales of three charged leptons and can always be taken to be real and positive; and

$$\begin{aligned}
M_R &= M_0 \begin{pmatrix} 2Y_1^* & -Y_3^* & -Y_2^* \\ -Y_3^* & 2Y_2^* & -Y_1^* \\ -Y_2^* & -Y_1^* & 2Y_3^* \end{pmatrix}, \\
M_D &= v_2 \begin{pmatrix} 2g_1^* Y_1^* & -(g_1^* + g_2^*) Y_3^* & (g_2^* - g_1^*) Y_2^* \\ (g_2^* - g_1^*) Y_3^* & 2g_1^* Y_2^* & -(g_1^* + g_2^*) Y_1^* \\ -(g_1^* + g_2^*) Y_2^* & (g_2^* - g_1^*) Y_1^* & 2g_1^* Y_3^* \end{pmatrix}, \tag{378}
\end{aligned}$$

where  $M_0$  characterizes the overall mass scale of three heavy Majorana neutrinos, and  $g_{1,2}$  are in general complex as  $Y_{1,2,3}$  are. The effective Majorana neutrino mass matrix  $M_\nu$  can then be calculated with the help of the seesaw formula  $M_\nu \simeq -M_D M_R^{-1} M_D^T$ . After  $M_l$  and  $M_\nu$  are diagonalized, one will obtain the charged-lepton masses, neutrino masses and the PMNS lepton flavor mixing matrix. A careful numerical analysis shows that this modular  $A_4$  symmetry model is compatible with current neutrino oscillation data, but it involves a number of free parameters besides the complex modulus parameter  $\tau$  [1024].

More efforts are certainly underway to explore more successful applications of the modular flavor symmetries in understanding a number of well-known flavor puzzles. For example, the GCP symmetry has recently been combined with the modular flavor symmetries for model building [1034]. In this case it is found that some viable modular symmetry models turn out to be more constrained and thus more predictive, with the complex modulus parameter  $\tau$  being the only source of CP violation for leptons and quarks. On the other hand, it has recently been pointed out that the most general Kähler potential consistent with the modular flavor symmetries of a given model contains additional terms with additional parameters [1038], and the latter will unavoidably reduce the predictive power of the model. Although it remains unclear whether the new ideas and methods under discussion are going to work well, we believe that a change in perception is always helpful for us to solve those long-standing flavor problems.

## 8. Summary and outlook

A number of great experimental breakthroughs in the past twenty years, including the discovery of the long-awaited Higgs boson, the determination of the Kobayashi-Maskawa CP-violating phase, and the observations of atmospheric, solar, reactor and accelerator neutrino (or antineutrino) oscillations, *did* bear witness to an exciting period of history in particle physics. On the one hand, we are convinced that the basic structures and interactions of the SM must be correct at and below the Fermi energy scale; on the other hand, we are left with some solid evidence that the SM must be incomplete — at least in its lepton flavor sector. The fact that the masses of three known (active) neutrinos are extremely small strongly indicates that the new physics responsible for neutrino mass generation and lepton flavor mixing seems to be essentially decoupled from the other parts of the SM at low energies. Since the SM itself tells us nothing about the quantitative details of different Yukawa interactions, it is really challenging to explore the underlying flavor structures of charged fermions and massive neutrinos either separately or on the same footing. Nevertheless,

a lot of important progress has so far been made in understanding how lepton or quark flavors mix and why CP symmetry is broken. The purpose of this review article is just to provide an overview of some typical ideas, approaches and results in this connection, with a focus on those general and model-independent observations and without going into detail of those model-building exercises.

We have briefly introduced the standard pictures of fermion mass generation, flavor mixing and CP violation in the SM or its minimal extension with massive Dirac or Majorana neutrinos, and highlighted the basic ideas of several seesaw mechanisms. After summarizing current experimental and theoretical knowledge about the flavor parameters of quarks and leptons, which include their masses, flavor mixing angles and CP-violating phases, we have outlined various popular ways of describing flavor mixing and CP violation. Some particular attention has been paid to the RGE evolution of fermion mass matrices and flavor mixing parameters from a superhigh energy scale down to the electroweak scale, and to the matter effects on neutrino oscillations. Taking account of possible extra neutrino species, we have proposed a standard parametrization of the  $6 \times 6$  active-sterile flavor mixing matrix and discussed the phenomenological aspects of heavy, keV-scale and eV-scale sterile neutrinos. Possible Yukawa textures of quark flavors have been explored by considering the quark mass limits, flavor symmetries and texture zeros, with an emphasis on those essentially model-independent ideas or novel model-building approaches. We have also gone over some recent progress made in investigating possible flavor structures of charged leptons and massive neutrinos, including how to reconstruct the lepton flavor textures, simplified versions of seesaw mechanisms, and basic strategies for building realistic flavor symmetry models. It is certainly impossible to cover a vast amount of work that has been done in the past twenty years at the frontiers of flavor physics, and hence we have combined our general descriptions with some typical examples for the sake of illustration, so as to provide a clear picture of where we are standing and how to proceed in the near future.

From a theoretical point of view, what lies behind the observed fermion mass spectra and flavor mixing patterns should most likely be a kind of fundamental flavor symmetry and its spontaneous breaking [1039]. In contrast with a “vertical” GUT symmetry which makes leptons and quarks of the same family correlated with one another, a “horizontal” flavor symmetry is expected to link one fermion family to another. So far many flavor symmetry groups on the market have been tried, in particular  $A_4$  and  $S_4$  have been extensively studied as two promising model-building playgrounds. But it remains unclear which flavor symmetry is close to the truth and can really shed light on the secrets of flavor structures, although some new concepts (e.g., generalized CP and modular symmetries) have been developed along this kind of thought. In any case, one lesson definitely emerges from all our theoretical and experimental attempts in the past two decades: possible new flavor symmetries and new degrees of freedom should show up in a new framework beyond the SM and at a new energy scale far above the electroweak scale.

We certainly have no reason to be pessimistic on the way to look into deeper flavor structures of charged fermions and massive neutrinos, because history tells us that a breakthrough might just be around the corner. It is especially encouraging that a lot of progress has recently been made in “cosmic flavor physics” — the studies of those flavor problems in cosmology and astrophysics, thanks to the fact that our knowledge about neutrino masses and lepton flavor mixing effects is rapidly growing. On the other hand, “dark flavor physics” — the studies of those flavor issues associated with dark matter and even dark sector of the Universe, is entering a booming period

in particle physics and cosmology. That is why we are confident that new developments in flavor physics will benefit not only the energy and intensity frontiers but also the cosmic frontier of modern sciences, and new developments in answering some fundamental questions about the origin and evolution of our Universe (e.g., the nature of dark matter, the dynamics of dark energy, the reason for baryogenesis and the origin of cosmic rays) will help deepen our understanding of flavor structures of both leptons and quarks. The road ahead is surely bright and exciting!

## Acknowledgements

I am deeply indebted to Harald Fritzsch for bringing me to the frontier of *flavor puzzles* and sharing many of his brilliant ideas with me, not only in research but also in life. Our collaboration in the past twenty-five years constitutes an early basis for the present work. I would like to thank all other collaborators of mine who have worked with me on the topics of flavor structures of leptons and quarks, especially to Takeshi Araki, Wei Chao, Dongsheng Du, Chao-Qiang Geng, Jean-Marc Gerard, Wan-lei Guo, Guo-yuan Huang, Sin Kyu Kang, Tatsuo Kobayashi, Yu-Feng Li, Shu Luo, Jianwei Mei, Newton Nath, Midori Obara, Tommy Ohlsson, Werner Rodejohann, Anthony Sanda, Yifang Wang, Dan-di Wu, Deshan Yang, Di Zhang, He Zhang, Jue Zhang, Zhen-hua Zhao, Shun Zhou, Ye-Ling Zhou and Jing-yu Zhu. I owe a big debt of gratitude to Zhen-hua Zhao and Shun Zhou for reading through the whole manuscript, finding out a long list of errors and clarifying some highly nontrivial issues. I am also grateful to Di Zhang and Jing-yu Zhu for carefully reading several parts of the manuscript and correcting quite a lot of errors, to Guo-yuan Huang and Shun Zhou for their friendly helps in updating Tables 6 and 7, and to Guo-yuan Huang, Yu-Feng Li, Zhi-cheng Liu, Di Zhang, Zhen-hua Zhao, Ye-Ling Zhou and Jing-yu Zhu for their kind helps in plotting some of the figures. A thoroughgoing revision of this article was finished at the end of January 2020 during my visiting stay at CERN, where I benefited quite a lot from many communications with Di Zhang. My recent research work is supported in part by the National Natural Science Foundation of China under Grant No. 11775231 and No. 11835013, and by the Chinese Academy of Sciences (CAS) Center for Excellence in Particle Physics.

## References

- [1] J. J. Thomson, Cathode Rays, *Phil. Mag. Ser.5* 44 (1897) 293–316. doi:[10.1080/14786449708621070](https://doi.org/10.1080/14786449708621070).
- [2] S. L. Glashow, Partial Symmetries of Weak Interactions, *Nucl. Phys.* 22 (1961) 579–588. doi:[10.1016/0029-5582\(61\)90469-2](https://doi.org/10.1016/0029-5582(61)90469-2).
- [3] S. Weinberg, A Model of Leptons, *Phys. Rev. Lett.* 19 (1967) 1264–1266. doi:[10.1103/PhysRevLett.19.1264](https://doi.org/10.1103/PhysRevLett.19.1264).
- [4] A. Salam, Weak and Electromagnetic Interactions, *Conf. Proc.* C680519 (1968) 367–377.
- [5] H. Fritzsch, M. Gell-Mann, H. Leutwyler, Advantages of the Color Octet Gluon Picture, *Phys. Lett.* 47B (1973) 365–368. doi:[10.1016/0370-2693\(73\)90625-4](https://doi.org/10.1016/0370-2693(73)90625-4).
- [6] D. J. Gross, F. Wilczek, Ultraviolet Behavior of Nonabelian Gauge Theories, *Phys. Rev. Lett.* 30 (1973) 1343–1346. doi:[10.1103/PhysRevLett.30.1343](https://doi.org/10.1103/PhysRevLett.30.1343).
- [7] H. D. Politzer, Reliable Perturbative Results for Strong Interactions?, *Phys. Rev. Lett.* 30 (1973) 1346–1349. doi:[10.1103/PhysRevLett.30.1346](https://doi.org/10.1103/PhysRevLett.30.1346).
- [8] T. E. Browder, T. Gershon, D. Pirjol, A. Soni, J. Zupan, New Physics at a Super Flavor Factory, *Rev. Mod. Phys.* 81 (2009) 1887–1941. arXiv:[0802.3201](https://arxiv.org/abs/0802.3201), doi:[10.1103/RevModPhys.81.1887](https://doi.org/10.1103/RevModPhys.81.1887).

- [9] R. Davis, Jr., D. S. Harmer, K. C. Hoffman, Search for neutrinos from the sun, *Phys. Rev. Lett.* 20 (1968) 1205–1209. doi:[10.1103/PhysRevLett.20.1205](https://doi.org/10.1103/PhysRevLett.20.1205).
- [10] Q. R. Ahmad, et al., Measurement of the rate of  $\nu_e + d \rightarrow p + p + e^-$  interactions produced by  $^8\text{B}$  solar neutrinos at the Sudbury Neutrino Observatory, *Phys. Rev. Lett.* 87 (2001) 071301. arXiv:[nucl-ex/0106015](https://arxiv.org/abs/nucl-ex/0106015), doi:[10.1103/PhysRevLett.87.071301](https://doi.org/10.1103/PhysRevLett.87.071301).
- [11] S. Fukuda, et al., Solar B-8 and hep neutrino measurements from 1258 days of Super-Kamiokande data, *Phys. Rev. Lett.* 86 (2001) 5651–5655. arXiv:[hep-ex/0103032](https://arxiv.org/abs/hep-ex/0103032), doi:[10.1103/PhysRevLett.86.5651](https://doi.org/10.1103/PhysRevLett.86.5651).
- [12] Q. R. Ahmad, et al., Direct evidence for neutrino flavor transformation from neutral current interactions in the Sudbury Neutrino Observatory, *Phys. Rev. Lett.* 89 (2002) 011301. arXiv:[nucl-ex/0204008](https://arxiv.org/abs/nucl-ex/0204008), doi:[10.1103/PhysRevLett.89.011301](https://doi.org/10.1103/PhysRevLett.89.011301).
- [13] Y. Fukuda, et al., Evidence for oscillation of atmospheric neutrinos, *Phys. Rev. Lett.* 81 (1998) 1562–1567. arXiv:[hep-ex/9807003](https://arxiv.org/abs/hep-ex/9807003), doi:[10.1103/PhysRevLett.81.1562](https://doi.org/10.1103/PhysRevLett.81.1562).
- [14] K. Eguchi, et al., First results from KamLAND: Evidence for reactor anti-neutrino disappearance, *Phys. Rev. Lett.* 90 (2003) 021802. arXiv:[hep-ex/0212021](https://arxiv.org/abs/hep-ex/0212021), doi:[10.1103/PhysRevLett.90.021802](https://doi.org/10.1103/PhysRevLett.90.021802).
- [15] F. P. An, et al., Observation of electron-antineutrino disappearance at Daya Bay, *Phys. Rev. Lett.* 108 (2012) 171803. arXiv:[1203.1669](https://arxiv.org/abs/1203.1669), doi:[10.1103/PhysRevLett.108.171803](https://doi.org/10.1103/PhysRevLett.108.171803).
- [16] M. H. Ahn, et al., Indications of neutrino oscillation in a 250 km long baseline experiment, *Phys. Rev. Lett.* 90 (2003) 041801. arXiv:[hep-ex/0212007](https://arxiv.org/abs/hep-ex/0212007), doi:[10.1103/PhysRevLett.90.041801](https://doi.org/10.1103/PhysRevLett.90.041801).
- [17] K. Abe, et al., Indication of Electron Neutrino Appearance from an Accelerator-produced Off-axis Muon Neutrino Beam, *Phys. Rev. Lett.* 107 (2011) 041801. arXiv:[1106.2822](https://arxiv.org/abs/1106.2822), doi:[10.1103/PhysRevLett.107.041801](https://doi.org/10.1103/PhysRevLett.107.041801).
- [18] K. Abe, et al., Observation of Electron Neutrino Appearance in a Muon Neutrino Beam, *Phys. Rev. Lett.* 112 (2014) 061802. arXiv:[1311.4750](https://arxiv.org/abs/1311.4750), doi:[10.1103/PhysRevLett.112.061802](https://doi.org/10.1103/PhysRevLett.112.061802).
- [19] M. Tanabashi, et al., Review of Particle Physics, *Phys. Rev. D* 98 (3) (2018) 030001. doi:[10.1103/PhysRevD.98.030001](https://doi.org/10.1103/PhysRevD.98.030001).
- [20] N. Cabibbo, Unitary Symmetry and Leptonic Decays, *Phys. Rev. Lett.* 10 (1963) 531–533. doi:[10.1103/PhysRevLett.10.531](https://doi.org/10.1103/PhysRevLett.10.531).
- [21] M. Kobayashi, T. Maskawa, CP Violation in the Renormalizable Theory of Weak Interaction, *Prog. Theor. Phys.* 49 (1973) 652–657. doi:[10.1143/PTP.49.652](https://doi.org/10.1143/PTP.49.652).
- [22] E. Rutherford, Collisions of Alpha Particles with Light Atoms. I. Hydrogen, *Phil. Mag. Ser.6* 37 (1919) 537–561. doi:[10.1080/14786440608635916](https://doi.org/10.1080/14786440608635916).
- [23] J. Chadwick, Possible Existence of a Neutron, *Nature* 129 (1932) 312. doi:[10.1038/129312a0](https://doi.org/10.1038/129312a0).
- [24] C. D. Anderson, The Positive Electron, *Phys. Rev.* 43 (1933) 491–494. doi:[10.1103/PhysRev.43.491](https://doi.org/10.1103/PhysRev.43.491).
- [25] C. D. Anderson, S. H. Neddermeyer, Cloud Chamber Observations of Cosmic Rays at 4300 Meters Elevation and Near Sea-Level, *Phys. Rev.* 50 (1936) 263–271. doi:[10.1103/PhysRev.50.263](https://doi.org/10.1103/PhysRev.50.263).
- [26] C. M. G. Lattes, H. Muirhead, G. P. S. Occhialini, C. F. Powell, Processes Involving Charged Mesons, *Nature* 159 (1947) 694–697. doi:[10.1038/159694a0](https://doi.org/10.1038/159694a0).
- [27] G. D. Rochester, C. C. Butler, Evidence for the Existence of New Unstable Elementary Particles, *Nature* 160 (1947) 855–857. doi:[10.1038/160855a0](https://doi.org/10.1038/160855a0).
- [28] C. L. Cowan, F. Reines, F. B. Harrison, H. W. Kruse, A. D. McGuire, Detection of the Free Neutrino: A Confirmation, *Science* 124 (1956) 103–104. doi:[10.1126/science.124.3212.103](https://doi.org/10.1126/science.124.3212.103).
- [29] C. S. Wu, E. Ambler, R. W. Hayward, D. D. Hoppes, R. P. Hudson, Experimental Test of Parity Conservation in Beta Decay, *Phys. Rev.* 105 (1957) 1413–1414. doi:[10.1103/PhysRev.105.1413](https://doi.org/10.1103/PhysRev.105.1413).
- [30] R. L. Garwin, L. M. Lederman, M. Weinrich, Observations of the Failure of Conservation of Parity and Charge Conjugation in Meson Decays: The Magnetic Moment of the Free Muon, *Phys. Rev.* 105 (1957) 1415–1417. doi:[10.1103/PhysRev.105.1415](https://doi.org/10.1103/PhysRev.105.1415).
- [31] G. Danby, J. M. Gaillard, K. A. Goulianos, L. M. Lederman, N. B. Mistry, M. Schwartz, J. Steinberger, Observation of High-Energy Neutrino Reactions and the Existence of Two Kinds of Neutrinos, *Phys. Rev. Lett.* 9 (1962) 36–44. doi:[10.1103/PhysRevLett.9.36](https://doi.org/10.1103/PhysRevLett.9.36).
- [32] J. H. Christenson, J. W. Cronin, V. L. Fitch, R. Turlay, Evidence for the  $2\pi$  Decay of the  $K^0$  Meson, *Phys. Rev. Lett.* 13 (1964) 138–140. doi:[10.1103/PhysRevLett.13.138](https://doi.org/10.1103/PhysRevLett.13.138).



- [33] J. J. Aubert, et al., Experimental Observation of a Heavy Particle  $J$ , Phys. Rev. Lett. 33 (1974) 1404–1406. [doi:10.1103/PhysRevLett.33.1404](https://doi.org/10.1103/PhysRevLett.33.1404).
- [34] J. E. Augustin, et al., Discovery of a Narrow Resonance in  $e^+e^-$  Annihilation, Phys. Rev. Lett. 33 (1974) 1406–1408. [doi:10.1103/PhysRevLett.33.1406](https://doi.org/10.1103/PhysRevLett.33.1406).
- [35] M. L. Perl, et al., Evidence for Anomalous Lepton Production in  $e^+e^-$  Annihilation, Phys. Rev. Lett. 35 (1975) 1489–1492. [doi:10.1103/PhysRevLett.35.1489](https://doi.org/10.1103/PhysRevLett.35.1489).
- [36] S. W. Herb, et al., Observation of a Dimuon Resonance at 9.5 GeV in 400 GeV Proton-Nucleus Collisions, Phys. Rev. Lett. 39 (1977) 252–255. [doi:10.1103/PhysRevLett.39.252](https://doi.org/10.1103/PhysRevLett.39.252).
- [37] G. Arnison, et al., Experimental Observation of Isolated Large Transverse Energy Electrons with Associated Missing Energy at  $\sqrt{s} = 540$ -GeV, Phys. Lett. 122B (1983) 103–116, [611(1983)]. [doi:10.1016/0370-2693\(83\)91177-2](https://doi.org/10.1016/0370-2693(83)91177-2).
- [38] G. Arnison, et al., Experimental Observation of Lepton Pairs of Invariant Mass Around 95-GeV/ $c^2$  at the CERN SPS Collider, Phys. Lett. 126B (1983) 398–410, [7.55(1983)]. [doi:10.1016/0370-2693\(83\)90188-0](https://doi.org/10.1016/0370-2693(83)90188-0).
- [39] F. Abe, et al., Observation of Top Quark Production in  $\bar{p}p$  collisions, Phys. Rev. Lett. 74 (1995) 2626–2631. [arXiv:hep-ex/9503002](https://arxiv.org/abs/hep-ex/9503002), [doi:10.1103/PhysRevLett.74.2626](https://doi.org/10.1103/PhysRevLett.74.2626).
- [40] S. Abachi, et al., Observation of the Top Quark, Phys. Rev. Lett. 74 (1995) 2632–2637. [arXiv:hep-ex/9503003](https://arxiv.org/abs/hep-ex/9503003), [doi:10.1103/PhysRevLett.74.2632](https://doi.org/10.1103/PhysRevLett.74.2632).
- [41] K. Kodama, et al., Observation of Tau Neutrino Interactions, Phys. Lett. B504 (2001) 218–224. [arXiv:hep-ex/0012035](https://arxiv.org/abs/hep-ex/0012035), [doi:10.1016/S0370-2693\(01\)00307-0](https://doi.org/10.1016/S0370-2693(01)00307-0).
- [42] B. Aubert, et al., Observation of CP Violation in the  $B^0$  Meson System, Phys. Rev. Lett. 87 (2001) 091801. [arXiv:hep-ex/0107013](https://arxiv.org/abs/hep-ex/0107013), [doi:10.1103/PhysRevLett.87.091801](https://doi.org/10.1103/PhysRevLett.87.091801).
- [43] K. Abe, et al., Observation of Large CP Violation in the Neutral  $B$  Meson System, Phys. Rev. Lett. 87 (2001) 091802. [arXiv:hep-ex/0107061](https://arxiv.org/abs/hep-ex/0107061), [doi:10.1103/PhysRevLett.87.091802](https://doi.org/10.1103/PhysRevLett.87.091802).
- [44] G. Aad, et al., Observation of a new particle in the search for the Standard Model Higgs boson with the ATLAS detector at the LHC, Phys. Lett. B716 (2012) 1–29. [arXiv:1207.7214](https://arxiv.org/abs/1207.7214), [doi:10.1016/j.physletb.2012.08.020](https://doi.org/10.1016/j.physletb.2012.08.020).
- [45] S. Chatrchyan, et al., Observation of a New Boson at a Mass of 125 GeV with the CMS Experiment at the LHC, Phys. Lett. B716 (2012) 30–61. [arXiv:1207.7235](https://arxiv.org/abs/1207.7235), [doi:10.1016/j.physletb.2012.08.021](https://doi.org/10.1016/j.physletb.2012.08.021).
- [46] R. Aaij, et al., Observation of CP Violation in Charm Decays, Phys. Rev. Lett. 122 (21) (2019) 211803. [arXiv:1903.08726](https://arxiv.org/abs/1903.08726), [doi:10.1103/PhysRevLett.122.211803](https://doi.org/10.1103/PhysRevLett.122.211803).
- [47] P. A. M. Dirac, The quantum theory of the electron, Proc. Roy. Soc. Lond. A117 (1928) 610–624. [doi:10.1098/rspa.1928.0023](https://doi.org/10.1098/rspa.1928.0023).
- [48] P. A. M. Dirac, Quantised singularities in the electromagnetic field, Proc. Roy. Soc. Lond. A133 (821) (1931) 60–72. [doi:10.1098/rspa.1931.0130](https://doi.org/10.1098/rspa.1931.0130).
- [49] H. Yukawa, On the Interaction of Elementary Particles I, Proc. Phys. Math. Soc. Jap. 17 (1935) 48–57, [Prog. Theor. Phys. Suppl. 1, 1 (1935)]. [doi:10.1143/PTPS.1.1](https://doi.org/10.1143/PTPS.1.1).
- [50] E. Fermi, Tentativo di una teoria dell'emissione dei raggi beta, Ric. Sci. 4 (1933) 491–495.
- [51] E. Fermi, An attempt of a theory of beta radiation. 1., Z. Phys. 88 (1934) 161–177. [doi:10.1007/BF01351864](https://doi.org/10.1007/BF01351864).
- [52] M. Gell-Mann, A Schematic Model of Baryons and Mesons, Phys. Lett. 8 (1964) 214–215. [doi:10.1016/S0031-9163\(64\)92001-3](https://doi.org/10.1016/S0031-9163(64)92001-3).
- [53] G. Zweig, An SU(3) model for strong interaction symmetry and its breaking. Version 1.
- [54] T. D. Lee, C.-N. Yang, Question of Parity Conservation in Weak Interactions, Phys. Rev. 104 (1956) 254–258. [doi:10.1103/PhysRev.104.254](https://doi.org/10.1103/PhysRev.104.254).
- [55] A. Salam, On parity conservation and neutrino mass, Nuovo Cim. 5 (1957) 299–301. [doi:10.1007/BF02812841](https://doi.org/10.1007/BF02812841).
- [56] L. D. Landau, On the conservation laws for weak interactions, Nucl. Phys. 3 (1957) 127–131. [doi:10.1016/0029-5582\(57\)90061-5](https://doi.org/10.1016/0029-5582(57)90061-5).
- [57] T. D. Lee, C.-N. Yang, Parity Nonconservation and a Two Component Theory of the Neutrino, Phys. Rev. 105 (1957) 1671–1675. [doi:10.1103/PhysRev.105.1671](https://doi.org/10.1103/PhysRev.105.1671).

- [58] R. P. Feynman, M. Gell-Mann, Theory of Fermi interaction, *Phys. Rev.* 109 (1958) 193–198. [doi:10.1103/PhysRev.109.193](https://doi.org/10.1103/PhysRev.109.193).
- [59] E. C. G. Sudarshan, R. e. Marshak, Chirality invariance and the universal Fermi interaction, *Phys. Rev.* 109 (1958) 1860–1860. [doi:10.1103/PhysRev.109.1860.2](https://doi.org/10.1103/PhysRev.109.1860.2).
- [60] F. Englert, R. Brout, Broken Symmetry and the Mass of Gauge Vector Mesons, *Phys. Rev. Lett.* 13 (1964) 321–323. [doi:10.1103/PhysRevLett.13.321](https://doi.org/10.1103/PhysRevLett.13.321).
- [61] P. W. Higgs, Broken symmetries, massless particles and gauge fields, *Phys. Lett.* 12 (1964) 132–133. [doi:10.1016/0031-9163\(64\)91136-9](https://doi.org/10.1016/0031-9163(64)91136-9).
- [62] P. W. Higgs, Broken Symmetries and the Masses of Gauge Bosons, *Phys. Rev. Lett.* 13 (1964) 508–509. [doi:10.1103/PhysRevLett.13.508](https://doi.org/10.1103/PhysRevLett.13.508).
- [63] G. S. Guralnik, C. R. Hagen, T. W. B. Kibble, Global Conservation Laws and Massless Particles, *Phys. Rev. Lett.* 13 (1964) 585–587. [doi:10.1103/PhysRevLett.13.585](https://doi.org/10.1103/PhysRevLett.13.585).
- [64] G. 't Hooft, Renormalization of Massless Yang-Mills Fields, *Nucl. Phys.* B33 (1971) 173–199. [doi:10.1016/0550-3213\(71\)90395-6](https://doi.org/10.1016/0550-3213(71)90395-6).
- [65] G. 't Hooft, Renormalizable Lagrangians for Massive Yang-Mills Fields, *Nucl. Phys.* B35 (1971) 167–188. [doi:10.1016/0550-3213\(71\)90139-8](https://doi.org/10.1016/0550-3213(71)90139-8).
- [66] F. J. Hasert, et al., Observation of Neutrino Like Interactions Without Muon Or Electron in the Gargamelle Neutrino Experiment, *Phys. Lett.* B46 (1973) 138–140. [doi:10.1016/0370-2693\(73\)90499-1](https://doi.org/10.1016/0370-2693(73)90499-1).
- [67] S. L. Glashow, J. Iliopoulos, L. Maiani, Weak Interactions with Lepton-Hadron Symmetry, *Phys. Rev. D2* (1970) 1285–1292. [doi:10.1103/PhysRevD.2.1285](https://doi.org/10.1103/PhysRevD.2.1285).
- [68] J. D. Bjorken, S. L. Glashow, Elementary Particles and SU(4), *Phys. Lett.* 11 (1964) 255–257. [doi:10.1016/0031-9163\(64\)90433-0](https://doi.org/10.1016/0031-9163(64)90433-0).
- [69] M. Gell-Mann, M. Levy, The axial vector current in beta decay, *Nuovo Cim.* 16 (1960) 705. [doi:10.1007/BF02859738](https://doi.org/10.1007/BF02859738).
- [70] A. D. Sakharov, Violation of CP Invariance, C asymmetry, and baryon asymmetry of the universe, *Pisma Zh. Eksp. Teor. Fiz.* 5 (1967) 32–35. [doi:10.1070/PU1991v034n05ABEH002497](https://doi.org/10.1070/PU1991v034n05ABEH002497).
- [71] E. Majorana, Teoria simmetrica dell'elettrone e del positrone, *Nuovo Cim.* 14 (1937) 171–184. [doi:10.1007/BF02961314](https://doi.org/10.1007/BF02961314).
- [72] W. H. Furry, On transition probabilities in double beta-disintegration, *Phys. Rev.* 56 (1939) 1184–1193. [doi:10.1103/PhysRev.56.1184](https://doi.org/10.1103/PhysRev.56.1184).
- [73] B. Pontecorvo, Mesonium and anti-mesonium, *Sov. Phys. JETP* 6 (1957) 429.
- [74] M. Gell-Mann, A. Pais, Behavior of neutral particles under charge conjugation, *Phys. Rev.* 97 (1955) 1387–1389. [doi:10.1103/PhysRev.97.1387](https://doi.org/10.1103/PhysRev.97.1387).
- [75] Z. Maki, M. Nakagawa, S. Sakata, Remarks on the unified model of elementary particles, *Prog. Theor. Phys.* 28 (1962) 870–880. [doi:10.1143/PTP.28.870](https://doi.org/10.1143/PTP.28.870).
- [76] B. Pontecorvo, Neutrino Experiments and the Problem of Conservation of Leptonic Charge, *Sov. Phys. JETP* 26 (1968) 984–988, [*Zh. Eksp. Teor. Fiz.* 53, 1717 (1967)].
- [77] V. N. Gribov, B. Pontecorvo, Neutrino astronomy and lepton charge, *Phys. Lett.* 28B (1969) 493. [doi:10.1016/0370-2693\(69\)90525-5](https://doi.org/10.1016/0370-2693(69)90525-5).
- [78] K. Hirata, et al., Observation of a Neutrino Burst from the Supernova SN 1987a, *Phys. Rev. Lett.* 58 (1987) 1490–1493. [doi:10.1103/PhysRevLett.58.1490](https://doi.org/10.1103/PhysRevLett.58.1490).
- [79] R. M. Bionta, et al., Observation of a Neutrino Burst in Coincidence with Supernova SN 1987A in the Large Magellanic Cloud, *Phys. Rev. Lett.* 58 (1987) 1494. [doi:10.1103/PhysRevLett.58.1494](https://doi.org/10.1103/PhysRevLett.58.1494).
- [80] J. N. Bahcall, Solar neutrinos. I: Theoretical, *Phys. Rev. Lett.* 12 (1964) 300–302. [doi:10.1103/PhysRevLett.12.300](https://doi.org/10.1103/PhysRevLett.12.300).
- [81] J. N. Bahcall, R. K. Ulrich, Solar Models, Neutrino Experiments and Helioseismology, *Rev. Mod. Phys.* 60 (1988) 297–372. [doi:10.1103/RevModPhys.60.297](https://doi.org/10.1103/RevModPhys.60.297).
- [82] J. N. Bahcall, M. H. Pinsonneault, S. Basu, Solar models: Current epoch and time dependences, neutrinos, and helioseismological properties, *Astrophys. J.* 555 (2001) 990–1012. [arXiv:astro-ph/0010346](https://arxiv.org/abs/astro-ph/0010346), [doi:10.1086/321493](https://doi.org/10.1086/321493).
- [83] L. Wolfenstein, Neutrino Oscillations in Matter, *Phys. Rev. D17* (1978) 2369–2374. [doi:10.1103/](https://doi.org/10.1103/)

- [PhysRevD.17.2369](#).
- [84] S. P. Mikheyev, A. Yu. Smirnov, Resonance Amplification of Oscillations in Matter and Spectroscopy of Solar Neutrinos, *Sov. J. Nucl. Phys.* 42 (1985) 913–917.
  - [85] M. G. Aartsen, et al., First observation of PeV-energy neutrinos with IceCube, *Phys. Rev. Lett.* 111 (2013) 021103. [arXiv:1304.5356](#), [doi:10.1103/PhysRevLett.111.021103](#).
  - [86] M. G. Aartsen, et al., Evidence for High-Energy Extraterrestrial Neutrinos at the IceCube Detector, *Science* 342 (2013) 1242856. [arXiv:1311.5238](#), [doi:10.1126/science.1242856](#).
  - [87] E. Witten, Lepton number and neutrino masses, *Nucl. Phys. Proc. Suppl.* 91 (2001) 3–8. [arXiv:hep-ph/0006332](#), [doi:10.1016/S0920-5632\(00\)00916-6](#).
  - [88] K. Abe, et al., Search for CP Violation in Neutrino and Antineutrino Oscillations by the T2K Experiment with  $2.2 \times 10^{21}$  Protons on Target, *Phys. Rev. Lett.* 121 (17) (2018) 171802. [arXiv:1807.07891](#), [doi:10.1103/PhysRevLett.121.171802](#).
  - [89] Y. F. Li, Z.-z. Xing, Possible Capture of keV Sterile Neutrino Dark Matter on Radioactive  $\beta$ -decaying Nuclei, *Phys. Lett.* B695 (2011) 205–210. [arXiv:1009.5870](#), [doi:10.1016/j.physletb.2010.11.015](#).
  - [90] Z.-z. Xing, H. Zhang, S. Zhou, Updated Values of Running Quark and Lepton Masses, *Phys. Rev.* D77 (2008) 113016. [arXiv:0712.1419](#), [doi:10.1103/PhysRevD.77.113016](#).
  - [91] Z.-z. Xing, H. Zhang, S. Zhou, Impacts of the Higgs mass on vacuum stability, running fermion masses and two-body Higgs decays, *Phys. Rev.* D86 (2012) 013013. [arXiv:1112.3112](#), [doi:10.1103/PhysRevD.86.013013](#).
  - [92] F. Capozzi, E. Lisi, A. Marrone, A. Palazzo, Current unknowns in the three neutrino framework, *Prog. Part. Nucl. Phys.* 102 (2018) 48–72. [arXiv:1804.09678](#), [doi:10.1016/j.pnpnp.2018.05.005](#).
  - [93] I. Esteban, M. C. Gonzalez-Garcia, A. Hernandez-Cabezudo, M. Maltoni, T. Schwetz, Global analysis of three-flavour neutrino oscillations: synergies and tensions in the determination of  $\theta_{23}$ ,  $\delta_{CP}$ , and the mass ordering, *JHEP* 01 (2019) 106. [arXiv:1811.05487](#), [doi:10.1007/JHEP01\(2019\)106](#).
  - [94] G. 't Hooft, Symmetry Breaking Through Bell-Jackiw Anomalies, *Phys. Rev. Lett.* 37 (1976) 8–11. [doi:10.1103/PhysRevLett.37.8](#).
  - [95] G. 't Hooft, Computation of the Quantum Effects Due to a Four-Dimensional Pseudoparticle, *Phys. Rev.* D14 (1976) 3432–3450. [doi:10.1103/PhysRevD.14.3432](#), [doi:10.1103/PhysRevD.18.2199.3](#), [doi:10.1103/PhysRevD.14.3432](#).
  - [96] R. N. Mohapatra, R. E. Marshak, Local B-L Symmetry of Electroweak Interactions, Majorana Neutrinos and Neutron Oscillations, *Phys. Rev. Lett.* 44 (1980) 1316–1319, [Erratum: *Phys. Rev. Lett.* 44,1643(1980)]. [doi:10.1103/PhysRevLett.44.1644.2](#), [doi:10.1103/PhysRevLett.44.1316](#).
  - [97] C. Wetterich, Neutrino Masses and the Scale of B-L Violation, *Nucl. Phys.* B187 (1981) 343–375. [doi:10.1016/0550-3213\(81\)90279-0](#).
  - [98] W. Buchmuller, C. Greub, P. Minkowski, Neutrino masses, neutral vector bosons and the scale of B-L breaking, *Phys. Lett.* B267 (1991) 395–399. [doi:10.1016/0370-2693\(91\)90952-M](#).
  - [99] J. Heeck, Unbroken B C L symmetry, *Phys. Lett.* B739 (2014) 256–262. [arXiv:1408.6845](#), [doi:10.1016/j.physletb.2014.10.067](#).
  - [100] R. N. Mohapatra, J. C. Pati, Left-Right Gauge Symmetry and an Isoconjugate Model of CP Violation, *Phys. Rev.* D11 (1975) 566–571. [doi:10.1103/PhysRevD.11.566](#).
  - [101] R. N. Mohapatra, J. C. Pati, A Natural Left-Right Symmetry, *Phys. Rev.* D11 (1975) 2558. [doi:10.1103/PhysRevD.11.2558](#).
  - [102] G. Senjanovic, R. N. Mohapatra, Exact Left-Right Symmetry and Spontaneous Violation of Parity, *Phys. Rev.* D12 (1975) 1502. [doi:10.1103/PhysRevD.12.1502](#).
  - [103] H. Fritzsch, P. Minkowski, Unified Interactions of Leptons and Hadrons, *Annals Phys.* 93 (1975) 193–266. [doi:10.1016/0003-4916\(75\)90211-0](#).
  - [104] H. Georgi, The State of the Art Gauge Theories, *AIP Conf. Proc.* 23 (1975) 575–582. [doi:10.1063/1.2947450](#).
  - [105] N. Aghanim, et al., Planck 2018 results. VI. Cosmological parameters [arXiv:1807.06209](#).
  - [106] G. 't Hooft, Naturalness, chiral symmetry, and spontaneous chiral symmetry breaking, *NATO Sci. Ser. B* 59 (1980) 135–157. [doi:10.1007/978-1-4684-7571-5\\_9](#).
  - [107] M. Gell-Mann, The interpretation of the new particles as displaced charge multiplets, *Nuovo Cim.* 4 (S2)

- (1956) 848–866. doi:10.1007/BF02748000.
- [108] G. F. Giudice, Naturally Speaking: The Naturalness Criterion and Physics at the LHC (2008) 155–178 arXiv:0801.2562, doi:10.1142/9789812779762\_0010.
- [109] A. N. Schellekens, The Emperor’s Last Clothes? Overlooking the String Theory Landscape, Rept. Prog. Phys. 71 (2008) 072201. arXiv:0807.3249, doi:10.1088/0034-4885/71/7/072201.
- [110] J. L. Feng, Theoretical overview: Motivations for lepton flavor violation, in: New initiatives on lepton flavor violation and neutrino oscillation with high intense muon and neutrino sources. Proceedings, International Workshop, Honolulu, USA, October 2-6, 2000, 2000, pp. 18–29. arXiv:hep-ph/0101122, doi:10.1142/9789812777003\_0002.
- [111] P. Minkowski,  $\mu \rightarrow e\gamma$  at a Rate of One Out of  $10^9$  Muon Decays?, Phys. Lett. 67B (1977) 421–428. doi:10.1016/0370-2693(77)90435-X.
- [112] T. Yanagida, Horizontal gauge symmetry and masses of neutrinos, Conf. Proc. C7902131 (1979) 95–99.
- [113] M. Gell-Mann, P. Ramond, R. Slansky, Complex Spinors and Unified Theories, Conf. Proc. C790927 (1979) 315–321. arXiv:1306.4669.
- [114] S. L. Glashow, The Future of Elementary Particle Physics, NATO Sci. Ser. B 61 (1980) 687. doi:10.1007/978-1-4684-7197-7\_15.
- [115] R. N. Mohapatra, G. Senjanovic, Neutrino Mass and Spontaneous Parity Nonconservation, Phys. Rev. Lett. 44 (1980) 912. doi:10.1103/PhysRevLett.44.912.
- [116] H. Georgi, S. L. Glashow, Unity of All Elementary Particle Forces, Phys. Rev. Lett. 32 (1974) 438–441. doi:10.1103/PhysRevLett.32.438.
- [117] H. Georgi, C. Jarlskog, A New Lepton-Quark Mass Relation in a Unified Theory, Phys. Lett. 86B (1979) 297–300. doi:10.1016/0370-2693(79)90842-6.
- [118] S. Dodelson, L. M. Widrow, Sterile-neutrinos as dark matter, Phys. Rev. Lett. 72 (1994) 17–20. arXiv:hep-ph/9303287, doi:10.1103/PhysRevLett.72.17.
- [119] A. Kusenko, Sterile neutrinos: The Dark side of the light fermions, Phys. Rept. 481 (2009) 1–28. arXiv:0906.2968, doi:10.1016/j.physrep.2009.07.004.
- [120] A. Boyarsky, O. Ruchayskiy, M. Shaposhnikov, The Role of sterile neutrinos in cosmology and astrophysics, Ann. Rev. Nucl. Part. Sci. 59 (2009) 191–214. arXiv:0901.0011, doi:10.1146/annurev.nucl.010909.083654.
- [121] J. L. Feng, Dark Matter Candidates from Particle Physics and Methods of Detection, Ann. Rev. Astron. Astrophys. 48 (2010) 495–545. arXiv:1003.0904, doi:10.1146/annurev-astro-082708-101659.
- [122] S. Antusch, C. Biggio, E. Fernandez-Martinez, M. B. Gavela, J. Lopez-Pavon, Unitarity of the Leptonic Mixing Matrix, JHEP 10 (2006) 084. arXiv:hep-ph/0607020, doi:10.1088/1126-6708/2006/10/084.
- [123] S. Antusch, S. Blanchet, M. Blennow, E. Fernandez-Martinez, Non-unitary Leptonic Mixing and Leptogenesis, JHEP 01 (2010) 017. arXiv:0910.5957, doi:10.1007/JHEP01(2010)017.
- [124] M. Blennow, P. Coloma, E. Fernandez-Martinez, J. Hernandez-Garcia, J. Lopez-Pavon, Non-Unitarity, sterile neutrinos, and Non-Standard neutrino Interactions, JHEP 04 (2017) 153. arXiv:1609.08637, doi:10.1007/JHEP04(2017)153.
- [125] L.-L. Chau, W.-Y. Keung, Comments on the Parametrization of the Kobayashi-Maskawa Matrix, Phys. Rev. Lett. 53 (1984) 1802. doi:10.1103/PhysRevLett.53.1802.
- [126] H. Fritzsch, How to Describe Weak Interaction Mixing and Maximal CP Violation?, Phys. Rev. D32 (1985) 3058. doi:10.1103/PhysRevD.32.3058.
- [127] H. Harari, M. Leurer, Recommending a Standard Choice of Cabibbo Angles and KM Phases for Any Number of Generations, Phys. Lett. B181 (1986) 123–128. doi:10.1016/0370-2693(86)91268-2.
- [128] L. Wolfenstein, Parametrization of the Kobayashi-Maskawa Matrix, Phys. Rev. Lett. 51 (1983) 1945. doi:10.1103/PhysRevLett.51.1945.
- [129] S. Weinberg, The Problem of Mass, Trans. New York Acad. Sci. 38 (1977) 185–201. doi:10.1111/j.2164-0947.1977.tb02958.x.
- [130] F. Wilczek, A. Zee, Discrete Flavor Symmetries and a Formula for the Cabibbo Angle, Phys. Lett. 70B (1977) 418, [Erratum: Phys. Lett. 72B, 504 (1978)]. doi:10.1016/0370-2693(77)90403-8.
- [131] H. Fritzsch, Calculating the Cabibbo Angle, Phys. Lett. 70B (1977) 436–440. doi:10.1016/

- 0370-2693(77)90408-7.
- [132] S. Pakvasa, H. Sugawara, Discrete Symmetry and Cabibbo Angle, Phys. Lett. 73B (1978) 61–64. [doi:10.1016/0370-2693\(78\)90172-7](#).
  - [133] H. Harari, H. Haut, J. Weyers, Quark Masses and Cabibbo Angles, Phys. Lett. 78B (1978) 459–461. [doi:10.1016/0370-2693\(78\)90485-9](#).
  - [134] C. D. Froggatt, H. B. Nielsen, Hierarchy of Quark Masses, Cabibbo Angles and CP Violation, Nucl. Phys. B147 (1979) 277–298. [doi:10.1016/0550-3213\(79\)90316-X](#).
  - [135] H. Fritzsch, Weak Interaction Mixing in the Six-Quark Theory, Phys. Lett. 73B (1978) 317–322. [doi:10.1016/0370-2693\(78\)90524-5](#).
  - [136] H. Fritzsch, Quark Masses and Flavor Mixing, Nucl. Phys. B155 (1979) 189–207. [doi:10.1016/0550-3213\(79\)90362-6](#).
  - [137] H. Fritzsch, Z.-z. Xing, Mass and flavor mixing schemes of quarks and leptons, Prog. Part. Nucl. Phys. 45 (2000) 1–81. [arXiv:hep-ph/9912358](#), [doi:10.1016/S0146-6410\(00\)00102-2](#).
  - [138] H. Fritzsch, Z.-Z. Xing, Lepton mass hierarchy and neutrino oscillations, Phys. Lett. B372 (1996) 265–270. [arXiv:hep-ph/9509389](#), [doi:10.1016/0370-2693\(96\)00107-4](#).
  - [139] H. Fritzsch, Z.-z. Xing, Large leptonic flavor mixing and the mass spectrum of leptons, Phys. Lett. B440 (1998) 313–318. [arXiv:hep-ph/9808272](#), [doi:10.1016/S0370-2693\(98\)01106-X](#).
  - [140] P. F. Harrison, D. H. Perkins, W. G. Scott, Tri-bimaximal mixing and the neutrino oscillation data, Phys. Lett. B530 (2002) 167. [arXiv:hep-ph/0202074](#), [doi:10.1016/S0370-2693\(02\)01336-9](#).
  - [141] Z.-z. Xing, Nearly tribimaximal neutrino mixing and CP violation, Phys. Lett. B533 (2002) 85–93. [arXiv:hep-ph/0204049](#), [doi:10.1016/S0370-2693\(02\)01649-0](#).
  - [142] X. G. He, A. Zee, Some simple mixing and mass matrices for neutrinos, Phys. Lett. B560 (2003) 87–90. [arXiv:hep-ph/0301092](#), [doi:10.1016/S0370-2693\(03\)00390-3](#).
  - [143] G. Altarelli, F. Feruglio, Discrete Flavor Symmetries and Models of Neutrino Mixing, Rev. Mod. Phys. 82 (2010) 2701–2729. [arXiv:1002.0211](#), [doi:10.1103/RevModPhys.82.2701](#).
  - [144] H. Ishimori, T. Kobayashi, H. Ohki, Y. Shimizu, H. Okada, M. Tanimoto, Non-Abelian Discrete Symmetries in Particle Physics, Prog. Theor. Phys. Suppl. 183 (2010) 1–163. [arXiv:1003.3552](#), [doi:10.1143/PTPS.183.1](#).
  - [145] S. F. King, C. Luhn, Neutrino Mass and Mixing with Discrete Symmetry, Rept. Prog. Phys. 76 (2013) 056201. [arXiv:1301.1340](#), [doi:10.1088/0034-4885/76/5/056201](#).
  - [146] S. T. Petcov, Discrete Flavour Symmetries, Neutrino Mixing and Leptonic CP Violation, Eur. Phys. J. C78 (9) (2018) 709. [arXiv:1711.10806](#), [doi:10.1140/epjc/s10052-018-6158-5](#).
  - [147] M. Raidal, Relation between the neutrino and quark mixing angles and grand unification, Phys. Rev. Lett. 93 (2004) 161801. [arXiv:hep-ph/0404046](#), [doi:10.1103/PhysRevLett.93.161801](#).
  - [148] H. Minakata, A. Yu. Smirnov, Neutrino mixing and quark-lepton complementarity, Phys. Rev. D70 (2004) 073009. [arXiv:hep-ph/0405088](#), [doi:10.1103/PhysRevD.70.073009](#).
  - [149] Z.-z. Xing, Nontrivial correlation between the CKM and MNS matrices, Phys. Lett. B618 (2005) 141–149. [arXiv:hep-ph/0503200](#), [doi:10.1016/j.physletb.2005.05.040](#).
  - [150] C. Jarlskog, Ambiguities pertaining to quark-lepton complementarity, Phys. Lett. B625 (2005) 63–66. [arXiv:hep-ph/0507212](#), [doi:10.1016/j.physletb.2005.08.061](#).
  - [151] G. Altarelli, P. A. N. Machado, D. Meloni, On Bimaximal Neutrino Mixing and GUT's, PoS CORFU2014 (2015) 012. [arXiv:1504.05514](#), [doi:10.22323/1.231.0012](#).
  - [152] D. Meloni, GUT and flavor models for neutrino masses and mixing, Front.in Phys. 5 (2017) 43. [arXiv:1709.02662](#), [doi:10.3389/fphy.2017.00043](#).
  - [153] Z.-z. Xing, Quark Mass Hierarchy and Flavor Mixing Puzzles, Int. J. Mod. Phys. A29 (2014) 1430067. [arXiv:1411.2713](#), [doi:10.1142/S0217751X14300671](#).
  - [154] V. A. Kuzmin, V. A. Rubakov, M. E. Shaposhnikov, On the Anomalous Electroweak Baryon Number Non-conservation in the Early Universe, Phys. Lett. 155B (1985) 36. [doi:10.1016/0370-2693\(85\)91028-7](#).
  - [155] A. G. Cohen, D. B. Kaplan, A. E. Nelson, Progress in electroweak baryogenesis, Ann. Rev. Nucl. Part. Sci. 43 (1993) 27–70. [arXiv:hep-ph/9302210](#), [doi:10.1146/annurev.ns.43.120193.000331](#).
  - [156] M. Trodden, Electroweak baryogenesis, Rev. Mod. Phys. 71 (1999) 1463–1500. [arXiv:hep-ph/9803479](#),

- [doi:10.1103/RevModPhys.71.1463](https://doi.org/10.1103/RevModPhys.71.1463).
- [157] W. Buchmuller, R. D. Peccei, T. Yanagida, Leptogenesis as the origin of matter, *Ann. Rev. Nucl. Part. Sci.* 55 (2005) 311–355. [arXiv:hep-ph/0502169](https://arxiv.org/abs/hep-ph/0502169), [doi:10.1146/annurev.nucl.55.090704.151558](https://doi.org/10.1146/annurev.nucl.55.090704.151558).
- [158] M. Fukugita, T. Yanagida, Baryogenesis Without Grand Unification, *Phys. Lett. B* 174 (1986) 45–47. [doi:10.1016/0370-2693\(86\)91126-3](https://doi.org/10.1016/0370-2693(86)91126-3).
- [159] I. Affleck, M. Dine, A New Mechanism for Baryogenesis, *Nucl. Phys. B* 249 (1985) 361–380. [doi:10.1016/0550-3213\(85\)90021-5](https://doi.org/10.1016/0550-3213(85)90021-5).
- [160] S. Weinberg, Baryon and Lepton Nonconserving Processes, *Phys. Rev. Lett.* 43 (1979) 1566–1570. [doi:10.1103/PhysRevLett.43.1566](https://doi.org/10.1103/PhysRevLett.43.1566).
- [161] W. Buchmuller, M. Plumacher, Baryon asymmetry and neutrino mixing, *Phys. Lett. B* 389 (1996) 73–77. [arXiv:hep-ph/9608308](https://arxiv.org/abs/hep-ph/9608308), [doi:10.1016/S0370-2693\(96\)01232-4](https://doi.org/10.1016/S0370-2693(96)01232-4).
- [162] R. Jackiw, C. Rebbi, Vacuum Periodicity in a Yang-Mills Quantum Theory, *Phys. Rev. Lett.* 37 (1976) 172–175. [doi:10.1103/PhysRevLett.37.172](https://doi.org/10.1103/PhysRevLett.37.172).
- [163] C. G. Callan, Jr., R. F. Dashen, D. J. Gross, The Structure of the Gauge Theory Vacuum, *Phys. Lett. B* 63 (1976) 334–340. [doi:10.1016/0370-2693\(76\)90277-X](https://doi.org/10.1016/0370-2693(76)90277-X).
- [164] S. Weinberg, The U(1) Problem, *Phys. Rev. D* 11 (1975) 3583–3593. [doi:10.1103/PhysRevD.11.3583](https://doi.org/10.1103/PhysRevD.11.3583).
- [165] S. L. Adler, Axial vector vertex in spinor electrodynamics, *Phys. Rev.* 177 (1969) 2426–2438. [doi:10.1103/PhysRev.177.2426](https://doi.org/10.1103/PhysRev.177.2426).
- [166] J. S. Bell, R. Jackiw, A PCAC puzzle:  $\pi^0 \rightarrow \gamma\gamma$  in the  $\sigma$  model, *Nuovo Cim. A* 60 (1969) 47–61. [doi:10.1007/BF02823296](https://doi.org/10.1007/BF02823296).
- [167] C. A. Baker, et al., An Improved experimental limit on the electric dipole moment of the neutron, *Phys. Rev. Lett.* 97 (2006) 131801. [arXiv:hep-ex/0602020](https://arxiv.org/abs/hep-ex/0602020), [doi:10.1103/PhysRevLett.97.131801](https://doi.org/10.1103/PhysRevLett.97.131801).
- [168] R. D. Peccei, H. R. Quinn, CP Conservation in the Presence of Instantons, *Phys. Rev. Lett.* 38 (1977) 1440–1443. [doi:10.1103/PhysRevLett.38.1440](https://doi.org/10.1103/PhysRevLett.38.1440).
- [169] R. D. Peccei, H. R. Quinn, Constraints Imposed by CP Conservation in the Presence of Instantons, *Phys. Rev. D* 16 (1977) 1791–1797. [doi:10.1103/PhysRevD.16.1791](https://doi.org/10.1103/PhysRevD.16.1791).
- [170] W. Altmannshofer, et al., The Belle II Physics Book [arXiv:1808.10567](https://arxiv.org/abs/1808.10567).
- [171] R. Aaij, et al., Physics case for an LHCb Upgrade II - Opportunities in flavour physics, and beyond, in the HL-LHC era [arXiv:1808.08865](https://arxiv.org/abs/1808.08865).
- [172] Z.-z. Xing, S. Zhou, Neutrinos in particle physics, astronomy and cosmology, 2011.
- [173] D. Griffiths, Introduction to elementary particles, 2008.
- [174] P. H. Frampton, C. Jarlskog, Systematics of Quark Mass Matrices in the Standard Electroweak Model, *Phys. Lett. B* 154B (1985) 421–424. [doi:10.1016/0370-2693\(85\)90422-8](https://doi.org/10.1016/0370-2693(85)90422-8).
- [175] S. M. Bilenky, S. T. Petcov, Massive Neutrinos and Neutrino Oscillations, *Rev. Mod. Phys.* 59 (1987) 671, [Erratum: *Rev. Mod. Phys.* 60, 575 (1988)]. [doi:10.1103/RevModPhys.59.671](https://doi.org/10.1103/RevModPhys.59.671).
- [176] H. K. Dreiner, H. E. Haber, S. P. Martin, Two-component spinor techniques and Feynman rules for quantum field theory and supersymmetry, *Phys. Rept.* 494 (2010) 1–196. [arXiv:0812.1594](https://arxiv.org/abs/0812.1594), [doi:10.1016/j.physrep.2010.05.002](https://doi.org/10.1016/j.physrep.2010.05.002).
- [177] Z.-z. Xing, Flavor mixing and CP violation of massive neutrinos, *Int. J. Mod. Phys. A* 19 (2004) 1–80. [arXiv:hep-ph/0307359](https://arxiv.org/abs/hep-ph/0307359), [doi:10.1142/S0217751X04016969](https://doi.org/10.1142/S0217751X04016969).
- [178] J.-Y. Zhu, Leptonic unitarity triangles: RGE running effects and  $\mu$ - $\tau$  reflection symmetry breaking [arXiv:1810.04426](https://arxiv.org/abs/1810.04426).
- [179] R. D. Peccei, Discrete and global symmetries in particle physics, *Lect. Notes Phys.* 521 (1999) 1–50. [arXiv:hep-ph/9807516](https://arxiv.org/abs/hep-ph/9807516), [doi:10.1007/BFb010552](https://doi.org/10.1007/BFb010552), [doi:10.1007/BFb0105521](https://doi.org/10.1007/BFb0105521).
- [180] B. Kayser, F. Gibrat-Debu, F. Perrier, The Physics of massive neutrinos, *World Sci. Lect. Notes Phys.* 25 (1989) 1–117.
- [181] Z.-z. Xing, Naturalness and Testability of TeV Seesaw Mechanisms, *Prog. Theor. Phys. Suppl.* 180 (2009) 112–127. [arXiv:0905.3903](https://arxiv.org/abs/0905.3903), [doi:10.1143/PTPS.180.112](https://doi.org/10.1143/PTPS.180.112).
- [182] M. Goepfert-Mayer, Double beta-disintegration, *Phys. Rev.* 48 (1935) 512–516. [doi:10.1103/PhysRev.48.512](https://doi.org/10.1103/PhysRev.48.512).
- [183] M. J. Dolinski, A. W. P. Poon, W. Rodejohann, Neutrinoless Double-Beta Decay: Status and Prospects [arXiv:1808.07240](https://arxiv.org/abs/1808.07240).

- 1902.04097.
- [184] S. Dell’Oro, S. Marcocci, M. Viel, F. Vissani, Neutrinoless double beta decay: 2015 review, *Adv. High Energy Phys.* 2016 (2016) 2162659. [arXiv:1601.07512](#), [doi:10.1155/2016/2162659](#).
  - [185] S. R. Elliott, A. A. Hahn, M. K. Moe, Direct Evidence for Two Neutrino Double Beta Decay in  $^{82}\text{Se}$ , *Phys. Rev. Lett.* 59 (1987) 2020–2023. [doi:10.1103/PhysRevLett.59.2020](#).
  - [186] S. M. Bilenky, C. Giunti, Neutrinoless Double-Beta Decay: a Probe of Physics Beyond the Standard Model, *Int. J. Mod. Phys. A30* (04n05) (2015) 1530001. [arXiv:1411.4791](#), [doi:10.1142/S0217751X1530001X](#).
  - [187] M. Agostini, et al., Probing Majorana neutrinos with double- $\beta$  decay [arXiv:1909.02726](#), [doi:10.1126/science.aav8613](#).
  - [188] J. B. Albert, et al., Search for Majorana neutrinos with the first two years of EXO-200 data, *Nature* 510 (2014) 229–234. [arXiv:1402.6956](#), [doi:10.1038/nature13432](#).
  - [189] A. Gando, et al., Search for Majorana Neutrinos near the Inverted Mass Hierarchy Region with KamLAND-Zen, *Phys. Rev. Lett.* 117 (8) (2016) 082503, [Addendum: *Phys. Rev. Lett.* 117, no.10, 109903 (2016)]. [arXiv:1605.02889](#), [doi:10.1103/PhysRevLett.117.109903](#), [doi:10.1103/PhysRevLett.117.082503](#).
  - [190] J. Schechter, J. W. F. Valle, Neutrinoless Double beta Decay in SU(2) x U(1) Theories, *Phys. Rev. D25* (1982) 2951. [doi:10.1103/PhysRevD.25.2951](#).
  - [191] E. Takasugi, Can the Neutrinoless Double Beta Decay Take Place in the Case of Dirac Neutrinos?, *Phys. Lett.* 149B (1984) 372–376. [doi:10.1016/0370-2693\(84\)90426-X](#).
  - [192] J. F. Nieves, Dirac and Pseudodirac Neutrinos and Neutrinoless Double Beta Decay, *Phys. Lett.* 147B (1984) 375–379. [doi:10.1016/0370-2693\(84\)90136-9](#).
  - [193] M. Duerr, M. Lindner, A. Merle, On the Quantitative Impact of the Schechter-Valle Theorem, *JHEP* 06 (2011) 091. [arXiv:1105.0901](#), [doi:10.1007/JHEP06\(2011\)091](#).
  - [194] J.-H. Liu, J. Zhang, S. Zhou, Majorana Neutrino Masses from Neutrinoless Double-Beta Decays and Lepton-Number-Violating Meson Decays, *Phys. Lett.* B760 (2016) 571–576. [arXiv:1606.04886](#), [doi:10.1016/j.physletb.2016.07.043](#).
  - [195] W. Rodejohann, Neutrino-less Double Beta Decay and Particle Physics, *Int. J. Mod. Phys. E20* (2011) 1833–1930. [arXiv:1106.1334](#), [doi:10.1142/S0218301311020186](#).
  - [196] F. F. Deppisch, M. Hirsch, H. Pas, Neutrinoless Double Beta Decay and Physics Beyond the Standard Model, *J. Phys. G39* (2012) 124007. [arXiv:1208.0727](#), [doi:10.1088/0954-3889/39/12/124007](#).
  - [197] Z.-z. Xing, Low-energy limits on heavy Majorana neutrino masses from the neutrinoless double-beta decay and non-unitary neutrino mixing, *Phys. Lett.* B679 (2009) 255–259. [arXiv:0907.3014](#), [doi:10.1016/j.physletb.2009.07.040](#).
  - [198] W. Rodejohann, On Non-Unitary Lepton Mixing and Neutrino Mass Observables, *Phys. Lett.* B684 (2010) 40–47. [arXiv:0912.3388](#), [doi:10.1016/j.physletb.2009.12.031](#).
  - [199] W. Grimus, L. Lavoura, The Seesaw mechanism at arbitrary order: Disentangling the small scale from the large scale, *JHEP* 11 (2000) 042. [arXiv:hep-ph/0008179](#), [doi:10.1088/1126-6708/2000/11/042](#).
  - [200] Z.-z. Xing, S. Zhou, Why is the 3 x 3 neutrino mixing matrix almost unitary in realistic seesaw models?, *HEPNP* 30 (2006) 828–832. [arXiv:hep-ph/0512290](#).
  - [201] W. Konetschny, W. Kummer, Nonconservation of Total Lepton Number with Scalar Bosons, *Phys. Lett.* 70B (1977) 433–435. [doi:10.1016/0370-2693\(77\)90407-5](#).
  - [202] M. Magg, C. Wetterich, Neutrino Mass Problem and Gauge Hierarchy, *Phys. Lett.* 94B (1980) 61–64. [doi:10.1016/0370-2693\(80\)90825-4](#).
  - [203] J. Schechter, J. W. F. Valle, Neutrino Masses in SU(2) x U(1) Theories, *Phys. Rev. D22* (1980) 2227. [doi:10.1103/PhysRevD.22.2227](#).
  - [204] T. P. Cheng, L.-F. Li, Neutrino Masses, Mixings and Oscillations in SU(2) x U(1) Models of Electroweak Interactions, *Phys. Rev. D22* (1980) 2860. [doi:10.1103/PhysRevD.22.2860](#).
  - [205] G. Lazarides, Q. Shafi, C. Wetterich, Proton Lifetime and Fermion Masses in an SO(10) Model, *Nucl. Phys.* B181 (1981) 287–300. [doi:10.1016/0550-3213\(81\)90354-0](#).
  - [206] R. N. Mohapatra, G. Senjanovic, Neutrino Masses and Mixings in Gauge Models with Spontaneous Parity Violation, *Phys. Rev. D23* (1981) 165. [doi:10.1103/PhysRevD.23.165](#).
  - [207] R. Foot, H. Lew, X. G. He, G. C. Joshi, Seesaw Neutrino Masses Induced by a Triplet of Leptons, *Z. Phys.*

- C44 (1989) 441. [doi:10.1007/BF01415558](https://doi.org/10.1007/BF01415558).
- [208] E. Ma, Pathways to naturally small neutrino masses, *Phys. Rev. Lett.* 81 (1998) 1171–1174. [arXiv:hep-ph/9805219](https://arxiv.org/abs/hep-ph/9805219), [doi:10.1103/PhysRevLett.81.1171](https://doi.org/10.1103/PhysRevLett.81.1171).
- [209] D. Wyler, L. Wolfenstein, Massless Neutrinos in Left-Right Symmetric Models, *Nucl. Phys. B* 218 (1983) 205–214. [doi:10.1016/0550-3213\(83\)90482-0](https://doi.org/10.1016/0550-3213(83)90482-0).
- [210] R. N. Mohapatra, J. W. F. Valle, Neutrino Mass and Baryon Number Nonconservation in Superstring Models, *Phys. Rev. D* 34 (1986) 1642. [doi:10.1103/PhysRevD.34.1642](https://doi.org/10.1103/PhysRevD.34.1642).
- [211] Z.-z. Xing, S. Zhou, Multiple seesaw mechanisms of neutrino masses at the TeV scale, *Phys. Lett. B* 679 (2009) 249–254. [arXiv:0906.1757](https://arxiv.org/abs/0906.1757), [doi:10.1016/j.physletb.2009.07.051](https://doi.org/10.1016/j.physletb.2009.07.051).
- [212] F. Bonnet, D. Hernandez, T. Ota, W. Winter, Neutrino masses from higher than d=5 effective operators, *JHEP* 10 (2009) 076. [arXiv:0907.3143](https://arxiv.org/abs/0907.3143), [doi:10.1088/1126-6708/2009/10/076](https://doi.org/10.1088/1126-6708/2009/10/076).
- [213] Y. Liao, Cascade Seesaw for Tiny Neutrino Mass, *JHEP* 06 (2011) 098. [arXiv:1011.3633](https://arxiv.org/abs/1011.3633), [doi:10.1007/JHEP06\(2011\)098](https://doi.org/10.1007/JHEP06(2011)098).
- [214] F. Vissani, Do experiments suggest a hierarchy problem?, *Phys. Rev. D* 57 (1998) 7027–7030. [arXiv:hep-ph/9709409](https://arxiv.org/abs/hep-ph/9709409), [doi:10.1103/PhysRevD.57.7027](https://doi.org/10.1103/PhysRevD.57.7027).
- [215] J. A. Casas, J. R. Espinosa, I. Hidalgo, Implications for new physics from fine-tuning arguments. I. Application to SUSY and seesaw cases, *JHEP* 11 (2004) 057. [arXiv:hep-ph/0410298](https://arxiv.org/abs/hep-ph/0410298), [doi:10.1088/1126-6708/2004/11/057](https://doi.org/10.1088/1126-6708/2004/11/057).
- [216] A. Abada, C. Biggio, F. Bonnet, M. B. Gavela, T. Hambye, Low energy effects of neutrino masses, *JHEP* 12 (2007) 061. [arXiv:0707.4058](https://arxiv.org/abs/0707.4058), [doi:10.1088/1126-6708/2007/12/061](https://doi.org/10.1088/1126-6708/2007/12/061).
- [217] J. Kersten, A. Yu. Smirnov, Right-Handed Neutrinos at CERN LHC and the Mechanism of Neutrino Mass Generation, *Phys. Rev. D* 76 (2007) 073005. [arXiv:0705.3221](https://arxiv.org/abs/0705.3221), [doi:10.1103/PhysRevD.76.073005](https://doi.org/10.1103/PhysRevD.76.073005).
- [218] S. Weinberg, Electromagnetic and weak masses, *Phys. Rev. Lett.* 29 (1972) 388–392. [doi:10.1103/PhysRevLett.29.388](https://doi.org/10.1103/PhysRevLett.29.388).
- [219] A. Zee, A Theory of Lepton Number Violation, Neutrino Majorana Mass, and Oscillation, *Phys. Lett.* 93B (1980) 389, [Erratum: *Phys. Lett.* 95B, 461 (1980)]. [doi:10.1016/0370-2693\(80\)90349-4](https://doi.org/10.1016/0370-2693(80)90349-4), [10.1016/0370-2693\(80\)90193-8](https://doi.org/10.1016/0370-2693(80)90193-8).
- [220] Y. Cai, J. Herrero-García, M. A. Schmidt, A. Vicente, R. R. Volkas, From the trees to the forest: a review of radiative neutrino mass models, *Front. in Phys.* 5 (2017) 63. [arXiv:1706.08524](https://arxiv.org/abs/1706.08524), [doi:10.3389/fphy.2017.00063](https://doi.org/10.3389/fphy.2017.00063).
- [221] M. B. Wise, CP Violation, in: Summer Institute on Particles and Fields Banff, Canada, August 14-27, 1988, 1988, pp. 124–196.
- [222] C. Jarlskog (Ed.), *CP Violation*, Vol. 3, WSP, 1989. [doi:10.1142/0496](https://doi.org/10.1142/0496).  
URL <http://www.worldscientific.com/worldscibooks/10.1142/0496>
- [223] W. Bernreuther, CP violation and baryogenesis, *Lect. Notes Phys.* 591 (2002) 237–293. [arXiv:hep-ph/0205279](https://arxiv.org/abs/hep-ph/0205279).
- [224] L. B. Okun, Ya. B. Zeldovich, Realistic Quark Models and Astrophysics, *Comments Nucl. Part. Phys.* 6 (3) (1976) 69–73.
- [225] A. Riotto, M. Trodden, Recent progress in baryogenesis, *Ann. Rev. Nucl. Part. Sci.* 49 (1999) 35–75. [arXiv:hep-ph/9901362](https://arxiv.org/abs/hep-ph/9901362), [doi:10.1146/annurev.nucl.49.1.35](https://doi.org/10.1146/annurev.nucl.49.1.35).
- [226] E. W. Kolb, M. S. Turner, The Early Universe, *Front. Phys.* 69 (1990) 1–547.
- [227] M. Dine, A. Kusenko, The Origin of the matter - antimatter asymmetry, *Rev. Mod. Phys.* 76 (2003) 1. [arXiv:hep-ph/0303065](https://arxiv.org/abs/hep-ph/0303065), [doi:10.1103/RevModPhys.76.1](https://doi.org/10.1103/RevModPhys.76.1).
- [228] S. Davidson, E. Nardi, Y. Nir, Leptogenesis, *Phys. Rept.* 466 (2008) 105–177. [arXiv:0802.2962](https://arxiv.org/abs/0802.2962), [doi:10.1016/j.physrep.2008.06.002](https://doi.org/10.1016/j.physrep.2008.06.002).
- [229] G. C. Branco, R. G. Felipe, F. R. Joaquim, Leptonic CP Violation, *Rev. Mod. Phys.* 84 (2012) 515–565. [arXiv:1111.5332](https://arxiv.org/abs/1111.5332), [doi:10.1103/RevModPhys.84.515](https://doi.org/10.1103/RevModPhys.84.515).
- [230] M. A. Luty, Baryogenesis via leptogenesis, *Phys. Rev. D* 45 (1992) 455–465. [doi:10.1103/PhysRevD.45.455](https://doi.org/10.1103/PhysRevD.45.455).
- [231] L. Covi, E. Roulet, F. Vissani, CP violating decays in leptogenesis scenarios, *Phys. Lett. B* 384 (1996) 169–174. [arXiv:hep-ph/9605319](https://arxiv.org/abs/hep-ph/9605319), [doi:10.1016/0370-2693\(96\)00817-9](https://doi.org/10.1016/0370-2693(96)00817-9).



- [232] M. Plumacher, Baryogenesis and lepton number violation, *Z. Phys.* C74 (1997) 549–559. [arXiv:hep-ph/9604229](#), [doi:10.1007/s002880050418](#).
- [233] T. Endoh, T. Morozumi, Z.-h. Xiong, Primordial lepton family asymmetries in seesaw model, *Prog. Theor. Phys.* 111 (2004) 123–149. [arXiv:hep-ph/0308276](#), [doi:10.1143/PTP.111.123](#).
- [234] A. Pilaftsis, Resonant CP violation induced by particle mixing in transition amplitudes, *Nucl. Phys.* B504 (1997) 61–107. [arXiv:hep-ph/9702393](#), [doi:10.1016/S0550-3213\(97\)00469-0](#).
- [235] A. Pilaftsis, CP violation and baryogenesis due to heavy Majorana neutrinos, *Phys. Rev.* D56 (1997) 5431–5451. [arXiv:hep-ph/9707235](#), [doi:10.1103/PhysRevD.56.5431](#).
- [236] A. Pilaftsis, T. E. J. Underwood, Resonant leptogenesis, *Nucl. Phys.* B692 (2004) 303–345. [arXiv:hep-ph/0309342](#), [doi:10.1016/j.nuclphysb.2004.05.029](#).
- [237] A. Anisimov, A. Broncano, M. Plumacher, The CP-asymmetry in resonant leptogenesis, *Nucl. Phys.* B737 (2006) 176–189. [arXiv:hep-ph/0511248](#), [doi:10.1016/j.nuclphysb.2006.01.003](#).
- [238] P. H. Frampton, S. L. Glashow, T. Yanagida, Cosmological sign of neutrino CP violation, *Phys. Lett.* B548 (2002) 119–121. [arXiv:hep-ph/0208157](#), [doi:10.1016/S0370-2693\(02\)02853-8](#).
- [239] W.-l. Guo, Z.-z. Xing, S. Zhou, Neutrino Masses, Lepton Flavor Mixing and Leptogenesis in the Minimal Seesaw Model, *Int. J. Mod. Phys.* E16 (2007) 1–50. [arXiv:hep-ph/0612033](#), [doi:10.1142/S0218301307004898](#).
- [240] K. Turzyski, Degenerate minimal seesaw and leptogenesis, *Phys. Lett.* B589 (2004) 135–140. [arXiv:hep-ph/0401219](#), [doi:10.1016/j.physletb.2004.03.071](#).
- [241] A. Pilaftsis, Resonant tau-leptogenesis with observable lepton number violation, *Phys. Rev. Lett.* 95 (2005) 081602. [arXiv:hep-ph/0408103](#), [doi:10.1103/PhysRevLett.95.081602](#).
- [242] A. Pilaftsis, T. E. J. Underwood, Electroweak-scale resonant leptogenesis, *Phys. Rev.* D72 (2005) 113001. [arXiv:hep-ph/0506107](#), [doi:10.1103/PhysRevD.72.113001](#).
- [243] Z.-z. Xing, S. Zhou, Tri-bimaximal Neutrino Mixing and Flavor-dependent Resonant Leptogenesis, *Phys. Lett.* B653 (2007) 278–287. [arXiv:hep-ph/0607302](#), [doi:10.1016/j.physletb.2007.08.009](#).
- [244] R. Barbieri, P. Creminelli, A. Strumia, N. Tetradis, Baryogenesis through leptogenesis, *Nucl. Phys.* B575 (2000) 61–77. [arXiv:hep-ph/9911315](#), [doi:10.1016/S0550-3213\(00\)00011-0](#).
- [245] W. Buchmuller, P. Di Bari, M. Plumacher, Leptogenesis for pedestrians, *Annals Phys.* 315 (2005) 305–351. [arXiv:hep-ph/0401240](#), [doi:10.1016/j.aop.2004.02.003](#).
- [246] S. Blanchet, P. Di Bari, Flavor effects on leptogenesis predictions, *JCAP* 0703 (2007) 018. [arXiv:hep-ph/0607330](#), [doi:10.1088/1475-7516/2007/03/018](#).
- [247] A. Abada, S. Davidson, A. Ibarra, F. X. Josse-Michaux, M. Losada, A. Riotto, Flavour Matters in Leptogenesis, *JHEP* 09 (2006) 010. [arXiv:hep-ph/0605281](#), [doi:10.1088/1126-6708/2006/09/010](#).
- [248] E. Nardi, Y. Nir, E. Roulet, J. Racker, The Importance of flavor in leptogenesis, *JHEP* 01 (2006) 164. [arXiv:hep-ph/0601084](#), [doi:10.1088/1126-6708/2006/01/164](#).
- [249] Z.-z. Xing, Theoretical Overview of Neutrino Properties, *Int. J. Mod. Phys.* A23 (2008) 4255–4272. [arXiv:0810.1421](#), [doi:10.1142/S0217751X08042730](#).
- [250] J. A. Harvey, M. S. Turner, Cosmological baryon and lepton number in the presence of electroweak fermion number violation, *Phys. Rev.* D42 (1990) 3344–3349. [doi:10.1103/PhysRevD.42.3344](#).
- [251] A. A. Belavin, A. M. Polyakov, A. S. Schwartz, Yu. S. Tyupkin, Pseudoparticle Solutions of the Yang-Mills Equations, *Phys. Lett.* B59 (1975) 85–87. [doi:10.1016/0370-2693\(75\)90163-X](#).
- [252] P. Sikivie, The strong CP problem, *Comptes Rendus Physique* 13 (2012) 176–179. [doi:10.1016/j.crhy.2011.10.002](#).
- [253] J. E. Kim, Light Pseudoscalars, *Particle Physics and Cosmology*, *Phys. Rept.* 150 (1987) 1–177. [doi:10.1016/0370-1573\(87\)90017-2](#).
- [254] H.-Y. Cheng, The Strong CP Problem Revisited, *Phys. Rept.* 158 (1988) 1. [doi:10.1016/0370-1573\(88\)90135-4](#).
- [255] J. L. Daz-Cruz, W. G. Hollik, U. J. Saldana-Salazar, A bottom-up approach to the strong CP problem, *Int. J. Mod. Phys.* A33 (14n15) (2018) 1850088. [arXiv:1605.03860](#), [doi:10.1142/S0217751X18500884](#).
- [256] V. Baluni, CP Violating Effects in QCD, *Phys. Rev.* D19 (1979) 2227–2230. [doi:10.1103/PhysRevD.19.2227](#).

- [257] R. J. Crewther, P. Di Vecchia, G. Veneziano, E. Witten, Chiral Estimate of the Electric Dipole Moment of the Neutron in Quantum Chromodynamics, Phys. Lett. 88B (1979) 123, [Erratum: Phys. Lett. 91B, 487 (1980)]. [doi:10.1016/0370-2693\(80\)91025-4](https://doi.org/10.1016/0370-2693(80)91025-4), [10.1016/0370-2693\(79\)90128-X](https://doi.org/10.1016/0370-2693(79)90128-X).
- [258] F.-K. Guo, U.-G. Meissner, Baryon electric dipole moments from strong CP violation, JHEP 12 (2012) 097. [arXiv:1210.5887](https://arxiv.org/abs/1210.5887), [doi:10.1007/JHEP12\(2012\)097](https://doi.org/10.1007/JHEP12(2012)097).
- [259] T. Akan, F.-K. Guo, U.-G. Meiner, Finite-volume corrections to the CP-odd nucleon matrix elements of the electromagnetic current from the QCD vacuum angle, Phys. Lett. B736 (2014) 163–168. [arXiv:1406.2882](https://arxiv.org/abs/1406.2882), [doi:10.1016/j.physletb.2014.07.022](https://doi.org/10.1016/j.physletb.2014.07.022).
- [260] J. Dragos, T. Luu, A. Shindler, J. de Vries, A. Yousif, Confirming the Existence of the strong CP Problem in Lattice QCD with the Gradient Flow [arXiv:1902.03254](https://arxiv.org/abs/1902.03254).
- [261] J. E. Kim, G. Carosi, Axions and the Strong CP Problem, Rev. Mod. Phys. 82 (2010) 557–602. [arXiv:0807.3125](https://arxiv.org/abs/0807.3125), [doi:10.1103/RevModPhys.82.557](https://doi.org/10.1103/RevModPhys.82.557).
- [262] S. Weinberg, A New Light Boson?, Phys. Rev. Lett. 40 (1978) 223–226. [doi:10.1103/PhysRevLett.40.223](https://doi.org/10.1103/PhysRevLett.40.223).
- [263] F. Wilczek, Problem of Strong  $P$  and  $T$  Invariance in the Presence of Instantons, Phys. Rev. Lett. 40 (1978) 279–282. [doi:10.1103/PhysRevLett.40.279](https://doi.org/10.1103/PhysRevLett.40.279).
- [264] J. E. Kim, Weak Interaction Singlet and Strong CP Invariance, Phys. Rev. Lett. 43 (1979) 103. [doi:10.1103/PhysRevLett.43.103](https://doi.org/10.1103/PhysRevLett.43.103).
- [265] M. A. Shifman, A. I. Vainshtein, V. I. Zakharov, Can Confinement Ensure Natural CP Invariance of Strong Interactions?, Nucl. Phys. B166 (1980) 493–506. [doi:10.1016/0550-3213\(80\)90209-6](https://doi.org/10.1016/0550-3213(80)90209-6).
- [266] A. R. Zhitnitsky, On Possible Suppression of the Axion Hadron Interactions. (In Russian), Sov. J. Nucl. Phys. 31 (1980) 260, [Yad. Fiz. 31, 497 (1980)].
- [267] M. Dine, W. Fischler, M. Srednicki, A Simple Solution to the Strong CP Problem with a Harmless Axion, Phys. Lett. 104B (1981) 199–202. [doi:10.1016/0370-2693\(81\)90590-6](https://doi.org/10.1016/0370-2693(81)90590-6).
- [268] Z. G. Berezhiani, M. Yu. Khlopov, Cosmology of Spontaneously Broken Gauge Family Symmetry, Z. Phys. C49 (1991) 73–78. [doi:10.1007/BF01570798](https://doi.org/10.1007/BF01570798).
- [269] M. A. B. Beg, H. S. Tsao, Strong  $P$ ,  $T$  Noninvariances in a Superweak Theory, Phys. Rev. Lett. 41 (1978) 278. [doi:10.1103/PhysRevLett.41.278](https://doi.org/10.1103/PhysRevLett.41.278).
- [270] H. Georgi, A Model of Soft CP Violation, Hadronic J. 1 (1978) 155.
- [271] R. N. Mohapatra, G. Senjanovic, Natural Suppression of Strong  $p$  and  $t$  Noninvariance, Phys. Lett. 79B (1978) 283–286. [doi:10.1016/0370-2693\(78\)90243-5](https://doi.org/10.1016/0370-2693(78)90243-5).
- [272] A. E. Nelson, Naturally Weak CP Violation, Phys. Lett. 136B (1984) 387–391. [doi:10.1016/0370-2693\(84\)92025-2](https://doi.org/10.1016/0370-2693(84)92025-2).
- [273] S. M. Barr, Solving the Strong CP Problem Without the Peccei-Quinn Symmetry, Phys. Rev. Lett. 53 (1984) 329. [doi:10.1103/PhysRevLett.53.329](https://doi.org/10.1103/PhysRevLett.53.329).
- [274] S. M. Barr, A Natural Class of Nonpeccei-quinn Models, Phys. Rev. D30 (1984) 1805. [doi:10.1103/PhysRevD.30.1805](https://doi.org/10.1103/PhysRevD.30.1805).
- [275] Z.-z. Xing, Model-independent access to the structure of quark flavor mixing, Phys. Rev. D86 (2012) 113006. [arXiv:1211.3890](https://arxiv.org/abs/1211.3890), [doi:10.1103/PhysRevD.86.113006](https://doi.org/10.1103/PhysRevD.86.113006).
- [276] H. Fusaoka, Y. Koide, Updated estimate of running quark masses, Phys. Rev. D57 (1998) 3986–4001. [arXiv:hep-ph/9712201](https://arxiv.org/abs/hep-ph/9712201), [doi:10.1103/PhysRevD.57.3986](https://doi.org/10.1103/PhysRevD.57.3986).
- [277] Z. Huang, The Measure of strong CP violation, Phys. Rev. D48 (1993) 270–282. [arXiv:hep-ph/9209235](https://arxiv.org/abs/hep-ph/9209235), [doi:10.1103/PhysRevD.48.270](https://doi.org/10.1103/PhysRevD.48.270).
- [278] M. Beneke, V. M. Braun, Heavy quark effective theory beyond perturbation theory: Renormalons, the pole mass and the residual mass term, Nucl. Phys. B426 (1994) 301–343. [arXiv:hep-ph/9402364](https://arxiv.org/abs/hep-ph/9402364), [doi:10.1016/0550-3213\(94\)90314-X](https://doi.org/10.1016/0550-3213(94)90314-X).
- [279] M. C. Smith, S. S. Willenbrock, Top quark pole mass, Phys. Rev. Lett. 79 (1997) 3825–3828. [arXiv:hep-ph/9612329](https://arxiv.org/abs/hep-ph/9612329), [doi:10.1103/PhysRevLett.79.3825](https://doi.org/10.1103/PhysRevLett.79.3825).
- [280] G. 't Hooft, Dimensional regularization and the renormalization group, Nucl. Phys. B61 (1973) 455–468. [doi:10.1016/0550-3213\(73\)90376-3](https://doi.org/10.1016/0550-3213(73)90376-3).
- [281] S. Weinberg, New approach to the renormalization group, Phys. Rev. D8 (1973) 3497–3509. [doi:10.1103/](https://doi.org/10.1103/)

- [PhysRevD.8.3497](#).
- [282] Y. Koide, A Fermion - Boson Composite Model of Quarks and Leptons, Phys. Lett. 120B (1983) 161–165. [doi:10.1016/0370-2693\(83\)90644-5](#).
  - [283] H. Arason, D. J. Castano, B. Keszthelyi, S. Mikaelian, E. J. Piard, P. Ramond, B. D. Wright, Renormalization group study of the standard model and its extensions. 1. The Standard model, Phys. Rev. D46 (1992) 3945–3965. [doi:10.1103/PhysRevD.46.3945](#).
  - [284] Z.-z. Xing, H. Zhang, On the Koide-like relations for the running masses of charged leptons, neutrinos and quarks, Phys. Lett. B635 (2006) 107–111. [arXiv:hep-ph/0602134](#), [doi:10.1016/j.physletb.2006.02.051](#).
  - [285] S. Antusch, M. Spinrath, Quark and lepton masses at the GUT scale including SUSY threshold corrections, Phys. Rev. D78 (2008) 075020. [arXiv:0804.0717](#), [doi:10.1103/PhysRevD.78.075020](#).
  - [286] S. P. Martin, Matching relations for decoupling in the Standard Model at two loops and beyond, Phys. Rev. D99 (3) (2019) 033007. [arXiv:1812.04100](#), [doi:10.1103/PhysRevD.99.033007](#).
  - [287] S. P. Martin, D. G. Robertson, Standard Model parameters in the tadpole-free pure MS scheme [arXiv:1907.02500](#).
  - [288] H. Fritzsch, Hierarchical Chiral Symmetries and the Quark Mass Matrix, Phys. Lett. B184 (1987) 391–396. [doi:10.1016/0370-2693\(87\)90186-9](#).
  - [289] P. Kaus, S. Meshkov, A BCS Quark Mass Matrix, Mod. Phys. Lett. A3 (1988) 1251, [Erratum: Mod. Phys. Lett. A4, 603 (1989)]. [doi:10.1142/S0217732388001501](#).
  - [290] T. Blum, et al., Domain wall QCD with physical quark masses, Phys. Rev. D93 (7) (2016) 074505. [arXiv:1411.7017](#), [doi:10.1103/PhysRevD.93.074505](#).
  - [291] S. Aoki, et al., Review of lattice results concerning low-energy particle physics, Eur. Phys. J. C77 (2) (2017) 112. [arXiv:1607.00299](#), [doi:10.1140/epjc/s10052-016-4509-7](#).
  - [292] S. Aoki, et al., FLAG Review 2019 [arXiv:1902.08191](#).
  - [293] N. Carrasco, et al., Up, down, strange and charm quark masses with  $N_f = 2+1+1$  twisted mass lattice QCD, Nucl. Phys. B887 (2014) 19–68. [arXiv:1403.4504](#), [doi:10.1016/j.nuclphysb.2014.07.025](#).
  - [294] S. Basak, et al., Electromagnetic effects on the light hadron spectrum, J. Phys. Conf. Ser. 640 (1) (2015) 012052. [arXiv:1510.04997](#), [doi:10.1088/1742-6596/640/1/012052](#).
  - [295] T. Blum, R. Zhou, T. Doi, M. Hayakawa, T. Izubuchi, S. Uno, N. Yamada, Electromagnetic mass splittings of the low lying hadrons and quark masses from 2+1 flavor lattice QCD+QED, Phys. Rev. D82 (2010) 094508. [arXiv:1006.1311](#), [doi:10.1103/PhysRevD.82.094508](#).
  - [296] B. Chakraborty, C. T. H. Davies, B. Galloway, P. Knecht, J. Koponen, G. C. Donald, R. J. Dowdall, G. P. Lepage, C. McNeile, High-precision quark masses and QCD coupling from  $n_f = 4$  lattice QCD, Phys. Rev. D91 (5) (2015) 054508. [arXiv:1408.4169](#), [doi:10.1103/PhysRevD.91.054508](#).
  - [297] Z. Fodor, C. Hoelbling, S. Krieg, L. Lellouch, T. Lippert, A. Portelli, A. Sastre, K. K. Szabo, L. Varnhorst, Up and down quark masses and corrections to Dashen’s theorem from lattice QCD and quenched QED, Phys. Rev. Lett. 117 (8) (2016) 082001. [arXiv:1604.07112](#), [doi:10.1103/PhysRevLett.117.082001](#).
  - [298] A. Bazavov, et al., Up-, down-, strange-, charm-, and bottom-quark masses from four-flavor lattice QCD, Phys. Rev. D98 (5) (2018) 054517. [arXiv:1802.04248](#), [doi:10.1103/PhysRevD.98.054517](#).
  - [299] N. Gray, D. J. Broadhurst, W. Grafe, K. Schilcher, Three Loop Relation of Quark (Modified) Ms and Pole Masses, Z. Phys. C48 (1990) 673–680. [doi:10.1007/BF01614703](#).
  - [300] R. Hempfling, B. A. Kniehl, On the relation between the fermion pole mass and MS Yukawa coupling in the standard model, Phys. Rev. D51 (1995) 1386–1394. [arXiv:hep-ph/9408313](#), [doi:10.1103/PhysRevD.51.1386](#).
  - [301] K. G. Chetyrkin, M. Steinhauser, Short distance mass of a heavy quark at order  $\alpha_s^3$ , Phys. Rev. Lett. 83 (1999) 4001–4004. [arXiv:hep-ph/9907509](#), [doi:10.1103/PhysRevLett.83.4001](#).
  - [302] K. Melnikov, T. v. Ritbergen, The Three loop relation between the MS-bar and the pole quark masses, Phys. Lett. B482 (2000) 99–108. [arXiv:hep-ph/9912391](#), [doi:10.1016/S0370-2693\(00\)00507-4](#).
  - [303] P. Marquard, A. V. Smirnov, V. A. Smirnov, M. Steinhauser, Quark Mass Relations to Four-Loop Order in Perturbative QCD, Phys. Rev. Lett. 114 (14) (2015) 142002. [arXiv:1502.01030](#), [doi:10.1103/PhysRevLett.114.142002](#).

- [304] P. Marquard, A. V. Smirnov, V. A. Smirnov, M. Steinhauser, D. Wellmann,  $\overline{\text{MS}}$ -on-shell quark mass relation up to four loops in QCD and a general  $\text{SU}(N)$  gauge group, Phys. Rev. D94 (7) (2016) 074025. [arXiv:1606.06754](#), [doi:10.1103/PhysRevD.94.074025](#).
- [305] S. Antusch, V. Maurer, Running quark and lepton parameters at various scales, JHEP 11 (2013) 115. [arXiv:1306.6879](#), [doi:10.1007/JHEP11\(2013\)115](#).
- [306] J. Hardy, I. S. Towner,  $|V_{ud}|$  from nuclear  $\beta$  decays, PoS CKM2016 (2016) 028. [doi:10.22323/1.291.0028](#).
- [307] D. Poganic, et al., Precise measurement of the  $\pi^+ \rightarrow \pi^0 e^+ \nu$  branching ratio, Phys. Rev. Lett. 93 (2004) 181803. [arXiv:hep-ex/0312030](#), [doi:10.1103/PhysRevLett.93.181803](#).
- [308] R. Aaij, et al., Determination of the quark coupling strength  $|V_{ub}|$  using baryonic decays, Nature Phys. 11 (2015) 743–747. [arXiv:1504.01568](#), [doi:10.1038/nphys3415](#).
- [309] L. J. Hall, A. Rasin, On the generality of certain predictions for quark mixing, Phys. Lett. B315 (1993) 164–169. [arXiv:hep-ph/9303303](#), [doi:10.1016/0370-2693\(93\)90175-H](#).
- [310] T. P. Cheng, E. Eichten, L.-F. Li, Higgs Phenomena in Asymptotically Free Gauge Theories, Phys. Rev. D9 (1974) 2259. [doi:10.1103/PhysRevD.9.2259](#).
- [311] E. Ma, S. Pakvasa, Variation of Mixing Angles and Masses With  $q^2$  in the Standard Six Quark Model, Phys. Rev. D20 (1979) 2899. [doi:10.1103/PhysRevD.20.2899](#).
- [312] B. Pendleton, G. G. Ross, Mass and Mixing Angle Predictions from Infrared Fixed Points, Phys. Lett. 98B (1981) 291–294. [doi:10.1016/0370-2693\(81\)90017-4](#).
- [313] M. E. Machacek, M. T. Vaughn, Two Loop Renormalization Group Equations in a General Quantum Field Theory. 2. Yukawa Couplings, Nucl. Phys. B236 (1984) 221–232. [doi:10.1016/0550-3213\(84\)90533-9](#).
- [314] K. Sasaki, Renormalization Group Equations for the Kobayashi-Maskawa Matrix, Z. Phys. C32 (1986) 149–152. [doi:10.1007/BF01441364](#).
- [315] K. S. Babu, Renormalization Group Analysis of the Kobayashi-Maskawa Matrix, Z. Phys. C35 (1987) 69. [doi:10.1007/BF01561056](#).
- [316] V. D. Barger, M. S. Berger, P. Ohmann, Universal evolution of CKM matrix elements, Phys. Rev. D47 (1993) 2038–2045. [arXiv:hep-ph/9210260](#), [doi:10.1103/PhysRevD.47.2038](#).
- [317] M. Kobayashi, Exactly unitary Wolfenstein parametrization of flavor mixing, Prog. Theor. Phys. 92 (1994) 287–288. [doi:10.1143/PTP.92.287](#).
- [318] A. J. Buras, M. E. Lautenbacher, G. Ostermaier, Waiting for the top quark mass,  $K^+ \rightarrow \pi^+ \nu \bar{\nu}$ ,  $B_s^0$ - $\bar{B}_s^0$  mixing and CP asymmetries in  $B$  decays, Phys. Rev. D50 (1994) 3433–3446. [arXiv:hep-ph/9403384](#), [doi:10.1103/PhysRevD.50.3433](#).
- [319] J. Charles, A. Hocker, H. Lacker, S. Laplace, F. R. Le Diberder, J. Malcles, J. Ocariz, M. Pivk, L. Roos, CP violation and the CKM matrix: Assessing the impact of the asymmetric  $B$  factories, Eur. Phys. J. C41 (1) (2005) 1–131. [arXiv:hep-ph/0406184](#), [doi:10.1140/epjc/s2005-02169-1](#).
- [320] Z.-z. Xing, Wolfenstein parametrization revisited, Phys. Rev. D51 (1995) 3958–3959. [arXiv:hep-ph/9411340](#), [doi:10.1103/PhysRevD.51.3958](#).
- [321] B. Aubert, et al., Measurement of Time-Dependent CP Asymmetry in  $B^0 \rightarrow c\bar{c}K^{(*)0}$  Decays, Phys. Rev. D79 (2009) 072009. [arXiv:0902.1708](#), [doi:10.1103/PhysRevD.79.072009](#).
- [322] I. Adachi, et al., Precise measurement of the CP violation parameter  $\sin 2\phi_1$  in  $B^0 \rightarrow (c\bar{c})K^0$  decays, Phys. Rev. Lett. 108 (2012) 171802. [arXiv:1201.4643](#), [doi:10.1103/PhysRevLett.108.171802](#).
- [323] R. Aaij, et al., Measurement of CP violation in  $B^0 \rightarrow J/\psi K_S^0$  decays, Phys. Rev. Lett. 115 (3) (2015) 031601. [arXiv:1503.07089](#), [doi:10.1103/PhysRevLett.115.031601](#).
- [324] Y. Amhis, et al., Averages of  $b$ -hadron,  $c$ -hadron, and  $\tau$ -lepton properties as of summer 2016, Eur. Phys. J. C77 (12) (2017) 895. [arXiv:1612.07233](#), [doi:10.1140/epjc/s10052-017-5058-4](#).
- [325] M. Bona, et al., The 2004 UTfit collaboration report on the status of the unitarity triangle in the standard model, JHEP 07 (2005) 028. [arXiv:hep-ph/0501199](#), [doi:10.1088/1126-6708/2005/07/028](#).
- [326] B. Kayser, Neutrino mass, mixing, and oscillation, in: Flavor physics for the millennium. Proceedings, Theoretical Advanced Study Institute in elementary particle physics, TASI 2000, Boulder, USA, June 4-30, 2000, 2001, pp. 625–650. [arXiv:hep-ph/0104147](#), [doi:10.1142/9789812811509\\_0017](#).
- [327] J. Schechter, J. W. F. Valle, Neutrino Oscillation Thought Experiment, Phys. Rev. D23 (1981) 1666. [doi:10.1103/PhysRevD.23.1666](#).

- [328] L. F. Li, F. Wilczek, Physical Processes Involving Majorana Neutrinos, *Phys. Rev. D* 25 (1982) 143. doi:[10.1103/PhysRevD.25.143](https://doi.org/10.1103/PhysRevD.25.143).
- [329] J. Bernabeu, P. Pascual, CP Properties of the Leptonic Sector for Majorana Neutrinos, *Nucl. Phys. B* 228 (1983) 21–30. doi:[10.1016/0550-3213\(83\)90393-0](https://doi.org/10.1016/0550-3213(83)90393-0).
- [330] P. Langacker, J. Wang, Neutrino anti-neutrino transitions, *Phys. Rev. D* 58 (1998) 093004. arXiv:[hep-ph/9802383](https://arxiv.org/abs/hep-ph/9802383), doi:[10.1103/PhysRevD.58.093004](https://doi.org/10.1103/PhysRevD.58.093004).
- [331] A. de Gouvea, B. Kayser, R. N. Mohapatra, Manifest CP Violation from Majorana Phases, *Phys. Rev. D* 67 (2003) 053004. arXiv:[hep-ph/0211394](https://arxiv.org/abs/hep-ph/0211394), doi:[10.1103/PhysRevD.67.053004](https://doi.org/10.1103/PhysRevD.67.053004).
- [332] Z.-z. Xing, Properties of CP Violation in Neutrino-Antineutrino Oscillations, *Phys. Rev. D* 87 (5) (2013) 053019. arXiv:[1301.7654](https://arxiv.org/abs/1301.7654), doi:[10.1103/PhysRevD.87.053019](https://doi.org/10.1103/PhysRevD.87.053019).
- [333] Z.-z. Xing, Y.-L. Zhou, Majorana CP-violating phases in neutrino-antineutrino oscillations and other lepton-number-violating processes, *Phys. Rev. D* 88 (2013) 033002. arXiv:[1305.5718](https://arxiv.org/abs/1305.5718), doi:[10.1103/PhysRevD.88.033002](https://doi.org/10.1103/PhysRevD.88.033002).
- [334] V. D. Barger, K. Whisnant, S. Pakvasa, R. J. N. Phillips, Matter Effects on Three-Neutrino Oscillations, *Phys. Rev. D* 22 (1980) 2718. doi:[10.1103/PhysRevD.22.2718](https://doi.org/10.1103/PhysRevD.22.2718).
- [335] P. Langacker, J. P. Leveille, J. Sheiman, On the Detection of Cosmological Neutrinos by Coherent Scattering, *Phys. Rev. D* 27 (1983) 1228. doi:[10.1103/PhysRevD.27.1228](https://doi.org/10.1103/PhysRevD.27.1228).
- [336] H. A. Bethe, A Possible Explanation of the Solar Neutrino Puzzle, *Phys. Rev. Lett.* 56 (1986) 1305. doi:[10.1103/PhysRevLett.56.1305](https://doi.org/10.1103/PhysRevLett.56.1305).
- [337] J. Linder, Derivation of neutrino matter potentials induced by earth, Submitted to: *Am. J. Phys.* arXiv:[hep-ph/0504264](https://arxiv.org/abs/hep-ph/0504264).
- [338] T.-K. Kuo, J. T. Pantaleone, Neutrino Oscillations in Matter, *Rev. Mod. Phys.* 61 (1989) 937. doi:[10.1103/RevModPhys.61.937](https://doi.org/10.1103/RevModPhys.61.937).
- [339] Z.-z. Xing, Fake CPT violation in disappearance neutrino oscillations, *J. Phys. G* 28 (2002) B7. arXiv:[hep-ph/0112120](https://arxiv.org/abs/hep-ph/0112120), doi:[10.1088/0954-3899/28/2/402](https://doi.org/10.1088/0954-3899/28/2/402).
- [340] J. Bernabu, A. Segarra, Disentangling genuine from matter-induced CP violation in neutrino oscillations, *Phys. Rev. Lett.* 121 (21) (2018) 211802. arXiv:[1806.07694](https://arxiv.org/abs/1806.07694), doi:[10.1103/PhysRevLett.121.211802](https://doi.org/10.1103/PhysRevLett.121.211802).
- [341] Y. Wang, Z.-z. Xing, Neutrino Masses and Flavor Oscillations, *Adv. Ser. Direct. High Energy Phys.* 26 (2016) 371–395. arXiv:[1504.06155](https://arxiv.org/abs/1504.06155), doi:[10.1142/9789814733519\\_0019](https://doi.org/10.1142/9789814733519_0019).
- [342] M. Aoki, K. Hagiwara, Y. Hayato, T. Kobayashi, T. Nakaya, K. Nishikawa, N. Okamura, Prospects of very long baseline neutrino oscillation experiments with the KEK / JAERI high intensity proton accelerator, *Phys. Rev. D* 67 (2003) 093004. arXiv:[hep-ph/0112338](https://arxiv.org/abs/hep-ph/0112338), doi:[10.1103/PhysRevD.67.093004](https://doi.org/10.1103/PhysRevD.67.093004).
- [343] F. An, et al., Neutrino Physics with JUNO, *J. Phys. G* 43 (3) (2016) 030401. arXiv:[1507.05613](https://arxiv.org/abs/1507.05613), doi:[10.1088/0954-3899/43/3/030401](https://doi.org/10.1088/0954-3899/43/3/030401).
- [344] S. T. Petcov, M. Piai, The LMA MSW solution of the solar neutrino problem, inverted neutrino mass hierarchy and reactor neutrino experiments, *Phys. Lett. B* 533 (2002) 94–106. arXiv:[hep-ph/0112074](https://arxiv.org/abs/hep-ph/0112074), doi:[10.1016/S0370-2693\(02\)01591-5](https://doi.org/10.1016/S0370-2693(02)01591-5).
- [345] S. Choubey, S. T. Petcov, M. Piai, Precision neutrino oscillation physics with an intermediate baseline reactor neutrino experiment, *Phys. Rev. D* 68 (2003) 113006. arXiv:[hep-ph/0306017](https://arxiv.org/abs/hep-ph/0306017), doi:[10.1103/PhysRevD.68.113006](https://doi.org/10.1103/PhysRevD.68.113006).
- [346] J. Learned, S. T. Dye, S. Pakvasa, R. C. Svoboda, Determination of neutrino mass hierarchy and  $\theta_{13}$  with a remote detector of reactor antineutrinos, *Phys. Rev. D* 78 (2008) 071302. arXiv:[hep-ex/0612022](https://arxiv.org/abs/hep-ex/0612022), doi:[10.1103/PhysRevD.78.071302](https://doi.org/10.1103/PhysRevD.78.071302).
- [347] L. Zhan, Y. Wang, J. Cao, L. Wen, Determination of the Neutrino Mass Hierarchy at an Intermediate Baseline, *Phys. Rev. D* 78 (2008) 111103. arXiv:[0807.3203](https://arxiv.org/abs/0807.3203), doi:[10.1103/PhysRevD.78.111103](https://doi.org/10.1103/PhysRevD.78.111103).
- [348] L. Zhan, Y. Wang, J. Cao, L. Wen, Experimental Requirements to Determine the Neutrino Mass Hierarchy Using Reactor Neutrinos, *Phys. Rev. D* 79 (2009) 073007. arXiv:[0901.2976](https://arxiv.org/abs/0901.2976), doi:[10.1103/PhysRevD.79.073007](https://doi.org/10.1103/PhysRevD.79.073007).
- [349] Y.-F. Li, J. Cao, Y. Wang, L. Zhan, Unambiguous Determination of the Neutrino Mass Hierarchy Using Reactor Neutrinos, *Phys. Rev. D* 88 (2013) 013008. arXiv:[1303.6733](https://arxiv.org/abs/1303.6733), doi:[10.1103/PhysRevD.88.013008](https://doi.org/10.1103/PhysRevD.88.013008).
- [350] Z.-Z. Xing, Interference effects in reactor antineutrino oscillations arXiv:[1808.02256](https://arxiv.org/abs/1808.02256).

- [351] R. N. Cahn, D. A. Dwyer, S. J. Freedman, W. C. Haxton, R. W. Kadel, Yu. G. Kolomensky, K. B. Luk, P. McDonald, G. D. Orebi Gann, A. W. P. Poon, [White Paper: Measuring the Neutrino Mass Hierarchy](#), in: Proceedings, 2013 Community Summer Study on the Future of U.S. Particle Physics: Snowmass on the Mississippi (CSS2013): Minneapolis, MN, USA, July 29-August 6, 2013, 2013. [arXiv:1307.5487](#). URL <http://www.slac.stanford.edu/econf/C1307292/docs/submittedArxivFiles/1307.5487.pdf>
- [352] F. Capozzi, E. Lisi, A. Marrone, Neutrino mass hierarchy and electron neutrino oscillation parameters with one hundred thousand reactor events, *Phys. Rev. D* 89 (1) (2014) 013001. [arXiv:1309.1638](#), [doi:10.1103/PhysRevD.89.013001](#).
- [353] Y.-F. Li, Y. Wang, Z.-z. Xing, Terrestrial matter effects on reactor antineutrino oscillations at JUNO or RENO-50: how small is small?, *Chin. Phys. C* 40 (9) (2016) 091001. [arXiv:1605.00900](#), [doi:10.1088/1674-1137/40/9/091001](#).
- [354] Y.-F. Li, Z.-z. Xing, J.-y. Zhu, Indirect unitarity violation entangled with matter effects in reactor antineutrino oscillations, *Phys. Lett. B* 782 (2018) 578–588. [arXiv:1802.04964](#), [doi:10.1016/j.physletb.2018.05.079](#).
- [355] K. Abe, et al., Hyper-Kamiokande Design Report [arXiv:1805.04163](#).
- [356] R. Acciarri, et al., Long-Baseline Neutrino Facility (LBNF) and Deep Underground Neutrino Experiment (DUNE) [arXiv:1512.06148](#).
- [357] D. Brailsford, DUNE: Status and Perspectives, in: Proceedings, Prospects in Neutrino Physics (NuPhys2017): London, UK, December 20–22, 2017, 2018, pp. 4–12. [arXiv:1804.04979](#).
- [358] S. M. Bilenky, C. Giunti, J. A. Grifols, E. Masso, Absolute values of neutrino masses: Status and prospects, *Phys. Rept.* 379 (2003) 69–148. [arXiv:hep-ph/0211462](#), [doi:10.1016/S0370-1573\(03\)00102-9](#).
- [359] A. Osipowicz, et al., KATRIN: A Next generation tritium beta decay experiment with sub-eV sensitivity for the electron neutrino mass. Letter of intent [arXiv:hep-ex/0109033](#).
- [360] Y. Farzan, A. Yu. Smirnov, On the effective mass of the electron neutrino in beta decay, *Phys. Lett. B* 557 (2003) 224–232. [arXiv:hep-ph/0211341](#), [doi:10.1016/S0370-2693\(03\)00207-7](#).
- [361] G. Drexlin, V. Hannen, S. Mertens, C. Weinheimer, Current direct neutrino mass experiments, *Adv. High Energy Phys.* 2013 (2013) 293986. [arXiv:1307.0101](#), [doi:10.1155/2013/293986](#).
- [362] M. Aker, et al., An improved upper limit on the neutrino mass from a direct kinematic method by KATRIN [arXiv:1909.06048](#).
- [363] Z.-z. Xing, Y.-L. Zhou, Geometry of the effective Majorana neutrino mass in the  $0\nu\beta\beta$  decay, *Chin. Phys. C* 39 (2015) 011001. [arXiv:1404.7001](#), [doi:10.1088/1674-1137/39/1/011001](#).
- [364] Z.-Z. Xing, Y.-L. Zhou, On the Majorana neutrinos and neutrinoless double beta decays, *Mod. Phys. Lett. A* 30 (25) (2015) 1530019. [doi:10.1142/S0217732315300190](#).
- [365] M. Agostini, et al., Results on Neutrinoless Double- $\beta$  Decay of  $^{76}\text{Ge}$  from Phase I of the GERDA Experiment, *Phys. Rev. Lett.* 111 (12) (2013) 122503. [arXiv:1307.4720](#), [doi:10.1103/PhysRevLett.111.122503](#).
- [366] S. A. Thomas, F. B. Abdalla, O. Lahav, Upper Bound of 0.28 eV on the Neutrino Masses from the Largest Photometric Redshift Survey, *Phys. Rev. Lett.* 105 (2010) 031301. [arXiv:0911.5291](#), [doi:10.1103/PhysRevLett.105.031301](#).
- [367] G. Mangano, G. Miele, S. Pastor, M. Peloso, A Precision calculation of the effective number of cosmological neutrinos, *Phys. Lett. B* 534 (2002) 8–16. [arXiv:astro-ph/0111408](#), [doi:10.1016/S0370-2693\(02\)01622-2](#).
- [368] P. F. de Salas, S. Pastor, Relic neutrino decoupling with flavour oscillations revisited, *JCAP* 1607 (07) (2016) 051. [arXiv:1606.06986](#), [doi:10.1088/1475-7516/2016/07/051](#).
- [369] F. Beutler, C. Blake, M. Colless, D. H. Jones, L. Staveley-Smith, L. Campbell, Q. Parker, W. Saunders, F. Watson, The 6dF Galaxy Survey: Baryon Acoustic Oscillations and the Local Hubble Constant, *Mon. Not. Roy. Astron. Soc.* 416 (2011) 3017–3032. [arXiv:1106.3366](#), [doi:10.1111/j.1365-2966.2011.19250.x](#).
- [370] L. Anderson, et al., The clustering of galaxies in the SDSS-III Baryon Oscillation Spectroscopic Survey: baryon acoustic oscillations in the Data Releases 10 and 11 Galaxy samples, *Mon. Not. Roy. Astron. Soc.* 441 (1) (2014) 24–62. [arXiv:1312.4877](#), [doi:10.1093/mnras/stu523](#).

- [371] A. J. Ross, L. Samushia, C. Howlett, W. J. Percival, A. Burden, M. Manera, The clustering of the SDSS DR7 main Galaxy sample I. A 4 per cent distance measure at  $z = 0.15$ , *Mon. Not. Roy. Astron. Soc.* 449 (1) (2015) 835–847. [arXiv:1409.3242](#), [doi:10.1093/mnras/stv154](#).
- [372] E. Di Valentino, E. Giusarma, O. Mena, A. Melchiorri, J. Silk, Cosmological limits on neutrino unknowns versus low redshift priors, *Phys. Rev. D* 93 (8) (2016) 083527. [arXiv:1511.00975](#), [doi:10.1103/PhysRevD.93.083527](#).
- [373] A. J. Cuesta, V. Niro, L. Verde, Neutrino mass limits: robust information from the power spectrum of galaxy surveys, *Phys. Dark Univ.* 13 (2016) 77–86. [arXiv:1511.05983](#), [doi:10.1016/j.dark.2016.04.005](#).
- [374] Q.-G. Huang, K. Wang, S. Wang, Constraints on the neutrino mass and mass hierarchy from cosmological observations, *Eur. Phys. J. C* 76 (9) (2016) 489. [arXiv:1512.05899](#), [doi:10.1140/epjc/s10052-016-4334-z](#).
- [375] A. Caldwell, A. Merle, O. Schulz, M. Totzauer, Global Bayesian analysis of neutrino mass data, *Phys. Rev. D* 96 (7) (2017) 073001. [arXiv:1705.01945](#), [doi:10.1103/PhysRevD.96.073001](#).
- [376] R.-Y. Guo, J.-F. Zhang, X. Zhang, Exploring neutrino mass and mass hierarchy in the scenario of vacuum energy interacting with cold dark matter, *Chin. Phys. C* 42 (9) (2018) 095103. [arXiv:1803.06910](#), [doi:10.1088/1674-1137/42/9/095103](#).
- [377] W. Zhang, E.-K. Li, M. Du, Y. Mu, S. Ning, B. Chang, L. Xu, Detecting the neutrino mass and mass hierarchy from global data [arXiv:1904.09698](#).
- [378] S. Roy Choudhury, S. Hannestad, Updated results on neutrino mass and mass hierarchy from cosmology [arXiv:1907.12598](#).
- [379] K. N. Abazajian, et al., CMB-S4 Science Book, First Edition [arXiv:1610.02743](#).
- [380] A. Kogut, et al., The Primordial Inflation Explorer (PIXIE): A Nulling Polarimeter for Cosmic Microwave Background Observations, *JCAP* 1107 (2011) 025. [arXiv:1105.2044](#), [doi:10.1088/1475-7516/2011/07/025](#).
- [381] J. Delabrouille, et al., Exploring cosmic origins with CORE: Survey requirements and mission design, *JCAP* 1804 (04) (2018) 014. [arXiv:1706.04516](#), [doi:10.1088/1475-7516/2018/04/014](#).
- [382] T. Abbott, et al., The Dark Energy Survey: more than dark energy – an overview, *Mon. Not. Roy. Astron. Soc.* 460 (2) (2016) 1270–1299. [arXiv:1601.00329](#), [doi:10.1093/mnras/stw641](#).
- [383] R. Laureijs, et al., Euclid Definition Study Report [arXiv:1110.3193](#).
- [384] P. A. Abell, et al., LSST Science Book, Version 2.0 [arXiv:0912.0201](#).
- [385] D. J. Bacon, et al., Cosmology with Phase 1 of the Square Kilometre Array: Red Book 2018: Technical specifications and performance forecasts, Submitted to: *Publ. Astron. Soc. Austral.* [arXiv:1811.02743](#).
- [386] J.-F. Zhang, B. Wang, X. Zhang, Forecast for weighing neutrinos in cosmology with SKA [arXiv:1907.00179](#).
- [387] A. Loureiro, et al., On The Upper Bound of Neutrino Masses from Combined Cosmological Observations and Particle Physics Experiments, *Phys. Rev. Lett.* 123 (8) (2019) 081301. [arXiv:1811.02578](#), [doi:10.1103/PhysRevLett.123.081301](#).
- [388] W. Rodejohann, On cancellations in neutrinoless double beta decay, *Nucl. Phys. B* 597 (2001) 110–126. [arXiv:hep-ph/0008044](#), [doi:10.1016/S0550-3213\(00\)00728-8](#).
- [389] Z.-z. Xing, Vanishing effective mass of the neutrinoless double beta decay?, *Phys. Rev. D* 68 (2003) 053002. [arXiv:hep-ph/0305195](#), [doi:10.1103/PhysRevD.68.053002](#).
- [390] Y. BenTov, A. Zee, Neutrino Mass Matrices with  $M_{ee} = 0$ , *Phys. Rev. D* 84 (2011) 073012. [arXiv:1103.2616](#), [doi:10.1103/PhysRevD.84.073012](#).
- [391] Z.-z. Xing, Z.-h. Zhao, Y.-L. Zhou, How to interpret a discovery or null result of the  $0\nu 2\beta$  decay, *Eur. Phys. J. C* 75 (9) (2015) 423. [arXiv:1504.05820](#), [doi:10.1140/epjc/s10052-015-3656-6](#).
- [392] G. Benato, Effective Majorana Mass and Neutrinoless Double Beta Decay, *Eur. Phys. J. C* 75 (11) (2015) 563. [arXiv:1510.01089](#), [doi:10.1140/epjc/s10052-015-3802-1](#).
- [393] Z.-z. Xing, Z.-h. Zhao, The effective neutrino mass of neutrinoless double-beta decays: how possible to fall into a well, *Eur. Phys. J. C* 77 (3) (2017) 192. [arXiv:1612.08538](#), [doi:10.1140/epjc/s10052-017-4777-x](#).
- [394] S.-F. Ge, M. Lindner, Extracting Majorana properties from strong bounds on neutrinoless double beta decay,

- Phys. Rev. D95 (3) (2017) 033003. [arXiv:1608.01618](https://arxiv.org/abs/1608.01618), [doi:10.1103/PhysRevD.95.033003](https://doi.org/10.1103/PhysRevD.95.033003).
- [395] G. T. Zatsepin, On the possibility of determining the upper limit of the neutrino mass by means of the flight time, *Pisma Zh. Eksp. Teor. Fiz.* 8 (1968) 333–334.
- [396] T. J. Loredo, D. Q. Lamb, Bayesian analysis of neutrinos observed from supernova SN-1987A, *Phys. Rev. D* 65 (2002) 063002. [arXiv:astro-ph/0107260](https://arxiv.org/abs/astro-ph/0107260), [doi:10.1103/PhysRevD.65.063002](https://doi.org/10.1103/PhysRevD.65.063002).
- [397] G. Pagliaroli, F. Rossi-Torres, F. Vissani, Neutrino mass bound in the standard scenario for supernova electronic antineutrino emission, *Astropart. Phys.* 33 (2010) 287–291. [arXiv:1002.3349](https://arxiv.org/abs/1002.3349), [doi:10.1016/j.astropartphys.2010.02.007](https://doi.org/10.1016/j.astropartphys.2010.02.007).
- [398] J.-S. Lu, J. Cao, Y.-F. Li, S. Zhou, Constraining Absolute Neutrino Masses via Detection of Galactic Supernova Neutrinos at JUNO, *JCAP* 1505 (05) (2015) 044. [arXiv:1412.7418](https://arxiv.org/abs/1412.7418), [doi:10.1088/1475-7516/2015/05/044](https://doi.org/10.1088/1475-7516/2015/05/044).
- [399] H.-L. Li, Y.-F. Li, M. Wang, L.-J. Wen, S. Zhou, Towards a complete reconstruction of supernova neutrino spectra in future large liquid-scintillator detectors, *Phys. Rev. D* 97 (6) (2018) 063014. [arXiv:1712.06985](https://arxiv.org/abs/1712.06985), [doi:10.1103/PhysRevD.97.063014](https://doi.org/10.1103/PhysRevD.97.063014).
- [400] H.-L. Li, X. Huang, Y.-F. Li, L.-J. Wen, S. Zhou, Model-independent approach to the reconstruction of multiflavor supernova neutrino energy spectra, *Phys. Rev. D* 99 (12) (2019) 123009. [arXiv:1903.04781](https://arxiv.org/abs/1903.04781), [doi:10.1103/PhysRevD.99.123009](https://doi.org/10.1103/PhysRevD.99.123009).
- [401] F. Halzen, S. R. Klein, IceCube: An Instrument for Neutrino Astronomy, *Rev. Sci. Instrum.* 81 (2010) 081101. [arXiv:1007.1247](https://arxiv.org/abs/1007.1247), [doi:10.1063/1.3480478](https://doi.org/10.1063/1.3480478).
- [402] M. G. Aartsen, et al., IceCube-Gen2: A Vision for the Future of Neutrino Astronomy in Antarctica [arXiv:1412.5106](https://arxiv.org/abs/1412.5106).
- [403] R. S. L. Hansen, M. Lindner, O. Scholer, Timing the Neutrino Signal of a Galactic Supernova [arXiv:1904.11461](https://arxiv.org/abs/1904.11461).
- [404] M. Yoshimura, Neutrino Pair Emission from Excited Atoms, *Phys. Rev. D* 75 (2007) 113007. [arXiv:hep-ph/0611362](https://arxiv.org/abs/hep-ph/0611362), [doi:10.1103/PhysRevD.75.113007](https://doi.org/10.1103/PhysRevD.75.113007).
- [405] A. Fukumi, et al., Neutrino Spectroscopy with Atoms and Molecules, *PTEP* 2012 (2012) 04D002. [arXiv:1211.4904](https://arxiv.org/abs/1211.4904), [doi:10.1093/ptep/pts066](https://doi.org/10.1093/ptep/pts066).
- [406] G.-Y. Huang, N. Sasao, Z.-Z. Xing, M. Yoshimura, Testing unitarity of the  $3 \times 3$  neutrino mixing matrix in an atomic system [arXiv:1904.10366](https://arxiv.org/abs/1904.10366).
- [407] D. N. Dinh, S. T. Petcov, N. Sasao, M. Tanaka, M. Yoshimura, Observables in Neutrino Mass Spectroscopy Using Atoms, *Phys. Lett. B* 719 (2013) 154–163. [arXiv:1209.4808](https://arxiv.org/abs/1209.4808), [doi:10.1016/j.physletb.2013.01.015](https://doi.org/10.1016/j.physletb.2013.01.015).
- [408] N. Song, R. Boyero Garcia, J. J. Gomez-Cadenas, M. C. Gonzalez-Garcia, A. Peralta Conde, J. Taron, Conditions for Statistical Determination of the Neutrino Mass Spectrum in Radiative Emission of Neutrino Pairs in Atoms, *Phys. Rev. D* 93 (1) (2016) 013020. [arXiv:1510.00421](https://arxiv.org/abs/1510.00421), [doi:10.1103/PhysRevD.93.013020](https://doi.org/10.1103/PhysRevD.93.013020).
- [409] J. Zhang, S. Zhou, Improved Statistical Determination of Absolute Neutrino Masses via Radiative Emission of Neutrino Pairs from Atoms, *Phys. Rev. D* 93 (11) (2016) 113020. [arXiv:1604.08008](https://arxiv.org/abs/1604.08008), [doi:10.1103/PhysRevD.93.113020](https://doi.org/10.1103/PhysRevD.93.113020).
- [410] M. Yoshimura, N. Sasao, M. Tanaka, Dynamics of paired superradiance, *Phys. Rev. A* 86 (2012) 013812. [arXiv:1203.5394](https://arxiv.org/abs/1203.5394), [doi:10.1103/PhysRevA.86.013812](https://doi.org/10.1103/PhysRevA.86.013812).
- [411] Y. Miyamoto, H. Hara, T. Masuda, N. Sasao, M. Tanaka, S. Uetake, A. Yoshimi, K. Yoshimura, M. Yoshimura, Externally triggered coherent two-photon emission from hydrogen molecules, *PTEP* 2015 (8) (2015) 081C01. [arXiv:1505.07663](https://arxiv.org/abs/1505.07663), [doi:10.1093/ptep/ptv103](https://doi.org/10.1093/ptep/ptv103).
- [412] T. Hiraki, H. Hara, Y. Miyamoto, K. Imamura, T. Masuda, N. Sasao, S. Uetake, A. Yoshimi, K. Yoshimura, M. Yoshimura, Coherent two-photon emission from hydrogen molecules excited by counter-propagating laser pulses, *Adv. Atom. Molec. Phys.* 52 (2019) 045401. [arXiv:1806.04005](https://arxiv.org/abs/1806.04005), [doi:10.1088/1361-6455/aafbd0](https://doi.org/10.1088/1361-6455/aafbd0).
- [413] M. Agostini, et al., Comprehensive measurement of  $pp$ -chain solar neutrinos, *Nature* 562 (7728) (2018) 505–510. [doi:10.1038/s41586-018-0624-y](https://doi.org/10.1038/s41586-018-0624-y).
- [414] I. Esteban, M. C. Gonzalez-Garcia, M. Maltoni, I. Martinez-Soler, T. Schwetz, Updated fit to three neutrino mixing: exploring the accelerator-reactor complementarity, *JHEP* 01 (2017) 087. [arXiv:1611.01514](https://arxiv.org/abs/1611.01514), [doi:10.1007/JHEP01\(2017\)087](https://doi.org/10.1007/JHEP01(2017)087).



[10.1007/JHEP01\(2017\)087](https://arxiv.org/abs/10.1007/JHEP01(2017)087).

- [415] F. P. An, et al., Measurement of electron antineutrino oscillation based on 1230 days of operation of the Daya Bay experiment, *Phys. Rev. D*95 (7) (2017) 072006. [arXiv:1610.04802](https://arxiv.org/abs/1610.04802), [doi:10.1103/PhysRevD.95.072006](https://doi.org/10.1103/PhysRevD.95.072006).
- [416] A. Gando, et al., Reactor On-Off Antineutrino Measurement with KamLAND, *Phys. Rev. D*88 (3) (2013) 033001. [arXiv:1303.4667](https://arxiv.org/abs/1303.4667), [doi:10.1103/PhysRevD.88.033001](https://doi.org/10.1103/PhysRevD.88.033001).
- [417] N. Vinyoles, A. M. Serenelli, F. L. Villante, S. Basu, J. Bergstrm, M. C. Gonzalez-Garcia, M. Maltoni, C. Pena-Garay, N. Song, A new Generation of Standard Solar Models, *Astrophys. J.* 835 (2) (2017) 202. [arXiv:1611.09867](https://arxiv.org/abs/1611.09867), [doi:10.3847/1538-4357/835/2/202](https://doi.org/10.3847/1538-4357/835/2/202).
- [418] B. Kayser, Neutrino Mass, Mixing, and Flavor Change (2002) 1–24 [arXiv:hep-ph/0211134](https://arxiv.org/abs/hep-ph/0211134).
- [419] J. N. Bahcall, Neutrino Astrophysics, 1989.
- [420] M. Guidry, J. Billings, A Basic Introduction to the Physics of Solar Neutrinos [arXiv:1812.00035](https://arxiv.org/abs/1812.00035).
- [421] J. N. Bahcall, C. Pena-Garay, Solar models and solar neutrino oscillations, *New J. Phys.* 6 (2004) 63. [arXiv:hep-ph/0404061](https://arxiv.org/abs/hep-ph/0404061), [doi:10.1088/1367-2630/6/1/063](https://doi.org/10.1088/1367-2630/6/1/063).
- [422] K. Abe, et al., Solar Neutrino Measurements in Super-Kamiokande-IV, *Phys. Rev. D*94 (5) (2016) 052010. [arXiv:1606.07538](https://arxiv.org/abs/1606.07538), [doi:10.1103/PhysRevD.94.052010](https://doi.org/10.1103/PhysRevD.94.052010).
- [423] B. Aharmim, et al., Combined Analysis of all Three Phases of Solar Neutrino Data from the Sudbury Neutrino Observatory, *Phys. Rev. C*88 (2013) 025501. [arXiv:1109.0763](https://arxiv.org/abs/1109.0763), [doi:10.1103/PhysRevC.88.025501](https://doi.org/10.1103/PhysRevC.88.025501).
- [424] S. Abe, et al., Precision Measurement of Neutrino Oscillation Parameters with KamLAND, *Phys. Rev. Lett.* 100 (2008) 221803. [arXiv:0801.4589](https://arxiv.org/abs/0801.4589), [doi:10.1103/PhysRevLett.100.221803](https://doi.org/10.1103/PhysRevLett.100.221803).
- [425] J. K. Ahn, et al., Observation of Reactor Electron Antineutrino Disappearance in the RENO Experiment, *Phys. Rev. Lett.* 108 (2012) 191802. [arXiv:1204.0626](https://arxiv.org/abs/1204.0626), [doi:10.1103/PhysRevLett.108.191802](https://doi.org/10.1103/PhysRevLett.108.191802).
- [426] Y. Abe, et al., Indication of Reactor  $\bar{\nu}_e$  Disappearance in the Double Chooz Experiment, *Phys. Rev. Lett.* 108 (2012) 131801. [arXiv:1112.6353](https://arxiv.org/abs/1112.6353), [doi:10.1103/PhysRevLett.108.131801](https://doi.org/10.1103/PhysRevLett.108.131801).
- [427] D. Adey, et al., Measurement of the Electron Antineutrino Oscillation with 1958 Days of Operation at Daya Bay, *Phys. Rev. Lett.* 121 (24) (2018) 241805. [arXiv:1809.02261](https://arxiv.org/abs/1809.02261), [doi:10.1103/PhysRevLett.121.241805](https://doi.org/10.1103/PhysRevLett.121.241805).
- [428] M. C. Goodman, Neutrino Mistakes: Wrong tracks and Hints, Hopes and Failures, in: International Conference on History of the Neutrino: 1930-2018 Paris, France, September 5-7, 2018, 2019. [arXiv:1901.07068](https://arxiv.org/abs/1901.07068).
- [429] A. Strumia, F. Vissani, Neutrino masses and mixings and... [arXiv:hep-ph/0606054](https://arxiv.org/abs/hep-ph/0606054).
- [430] K. Abe, et al., Atmospheric neutrino oscillation analysis with external constraints in Super-Kamiokande I-IV, *Phys. Rev. D*97 (7) (2018) 072001. [arXiv:1710.09126](https://arxiv.org/abs/1710.09126), [doi:10.1103/PhysRevD.97.072001](https://doi.org/10.1103/PhysRevD.97.072001).
- [431] M. H. Ahn, et al., Measurement of Neutrino Oscillation by the K2K Experiment, *Phys. Rev. D*74 (2006) 072003. [arXiv:hep-ex/0606032](https://arxiv.org/abs/hep-ex/0606032), [doi:10.1103/PhysRevD.74.072003](https://doi.org/10.1103/PhysRevD.74.072003).
- [432] D. G. Michael, et al., Observation of muon neutrino disappearance with the MINOS detectors and the NuMI neutrino beam, *Phys. Rev. Lett.* 97 (2006) 191801. [arXiv:hep-ex/0607088](https://arxiv.org/abs/hep-ex/0607088), [doi:10.1103/PhysRevLett.97.191801](https://doi.org/10.1103/PhysRevLett.97.191801).
- [433] P. Adamson, et al., Improved search for muon-neutrino to electron-neutrino oscillations in MINOS, *Phys. Rev. Lett.* 107 (2011) 181802. [arXiv:1108.0015](https://arxiv.org/abs/1108.0015), [doi:10.1103/PhysRevLett.107.181802](https://doi.org/10.1103/PhysRevLett.107.181802).
- [434] P. Adamson, et al., First measurement of electron neutrino appearance in NOvA, *Phys. Rev. Lett.* 116 (15) (2016) 151806. [arXiv:1601.05022](https://arxiv.org/abs/1601.05022), [doi:10.1103/PhysRevLett.116.151806](https://doi.org/10.1103/PhysRevLett.116.151806).
- [435] P. Adamson, et al., Measurement of the neutrino mixing angle  $\theta_{23}$  in NOvA, *Phys. Rev. Lett.* 118 (15) (2017) 151802. [arXiv:1701.05891](https://arxiv.org/abs/1701.05891), [doi:10.1103/PhysRevLett.118.151802](https://doi.org/10.1103/PhysRevLett.118.151802).
- [436] M. Freund, Analytic approximations for three neutrino oscillation parameters and probabilities in matter, *Phys. Rev. D*64 (2001) 053003. [arXiv:hep-ph/0103300](https://arxiv.org/abs/hep-ph/0103300), [doi:10.1103/PhysRevD.64.053003](https://doi.org/10.1103/PhysRevD.64.053003).
- [437] K. Abe, et al., Combined Analysis of Neutrino and Antineutrino Oscillations at T2K, *Phys. Rev. Lett.* 118 (15) (2017) 151801. [arXiv:1701.00432](https://arxiv.org/abs/1701.00432), [doi:10.1103/PhysRevLett.118.151801](https://doi.org/10.1103/PhysRevLett.118.151801).
- [438] M. A. Acero, et al., New constraints on oscillation parameters from  $\nu_e$  appearance and  $\nu_\mu$  disappearance in the NOvA experiment, *Phys. Rev. D*98 (2018) 032012. [arXiv:1806.00096](https://arxiv.org/abs/1806.00096), [doi:10.1103/PhysRevD.98.032012](https://doi.org/10.1103/PhysRevD.98.032012).
- [439] P. F. Harrison, W. G. Scott,  $\mu$ - $\tau$  reflection symmetry in lepton mixing and neutrino oscillations, *Phys. Lett.*

- B547 (2002) 219–228. [arXiv:hep-ph/0210197](#), [doi:10.1016/S0370-2693\(02\)02772-7](#).
- [440] Z.-z. Xing, Z.-h. Zhao, A review of  $\mu$ - $\tau$  flavor symmetry in neutrino physics, Rept. Prog. Phys. 79 (7) (2016) 076201. [arXiv:1512.04207](#), [doi:10.1088/0034-4885/79/7/076201](#).
- [441] G. L. Fogli, E. Lisi, D. Montanino, A comprehensive analysis of solar, atmospheric, accelerator and reactor neutrino experiments in a hierarchical three generation scheme, Phys. Rev. D49 (1994) 3626–3642. [doi:10.1103/PhysRevD.49.3626](#).
- [442] S. Schael, et al., Precision electroweak measurements on the Z resonance, Phys. Rept. 427 (2006) 257–454. [arXiv:hep-ex/0509008](#), [doi:10.1016/j.physrep.2005.12.006](#).
- [443] G. L. Fogli, E. Lisi, A. Marrone, A. Palazzo, A. M. Rotunno, Hints of  $\theta_{13} > 0$  from global neutrino data analysis, Phys. Rev. Lett. 101 (2008) 141801. [arXiv:0806.2649](#), [doi:10.1103/PhysRevLett.101.141801](#).
- [444] G. L. Fogli, E. Lisi, A. Marrone, A. Palazzo, A. M. Rotunno, Evidence of  $\theta_{13} \neq 0$  from global neutrino data analysis, Phys. Rev. D84 (2011) 053007. [arXiv:1106.6028](#), [doi:10.1103/PhysRevD.84.053007](#).
- [445] Z.-z. Xing, S. Zhou, Implications of Leptonic Unitarity Violation at Neutrino Telescopes, Phys. Lett. B666 (2008) 166–172. [arXiv:0804.3512](#), [doi:10.1016/j.physletb.2008.07.011](#).
- [446] Z.-z. Xing, S. Zhou, A partial  $\mu\tau$  symmetry and its prediction for leptonic CP violation, Phys. Lett. B737 (2014) 196–200. [arXiv:1404.7021](#), [doi:10.1016/j.physletb.2014.08.047](#).
- [447] Z.-z. Xing, Hierarchical neutrino masses and large mixing angles from the Fritzsch texture of lepton mass matrices, Phys. Lett. B550 (2002) 178–185. [arXiv:hep-ph/0210276](#), [doi:10.1016/S0370-2693\(02\)02981-7](#).
- [448] M. Fukugita, M. Tanimoto, T. Yanagida, Predictions from the Fritzsch type lepton mass matrices, Phys. Lett. B562 (2003) 273–278. [arXiv:hep-ph/0303177](#), [doi:10.1016/S0370-2693\(03\)00568-9](#).
- [449] Z.-Z. Xing, Implications of the Daya Bay observation of  $\theta_{13}$  on the leptonic flavor mixing structure and CP violation, Chin. Phys. C36 (2012) 281–297. [arXiv:1203.1672](#), [doi:10.1088/1674-1137/36/4/L01](#).
- [450] N. Cabibbo, Time Reversal Violation in Neutrino Oscillation, Phys. Lett. 72B (1978) 333–335. [doi:10.1016/0370-2693\(78\)90132-6](#).
- [451] L. Wolfenstein, Oscillations Among Three Neutrino Types and CP Violation, Phys. Rev. D18 (1978) 958–960. [doi:10.1103/PhysRevD.18.958](#).
- [452] I. Dunietz, O. W. Greenberg, D.-d. Wu, A Priori Definition of Maximal CP Violation, Phys. Rev. Lett. 55 (1985) 2935. [doi:10.1103/PhysRevLett.55.2935](#).
- [453] F. Vissani, A Study of the scenario with nearly degenerate Majorana neutrinos [arXiv:hep-ph/9708483](#).
- [454] V. D. Barger, S. Pakvasa, T. J. Weiler, K. Whisnant, Bimaximal mixing of three neutrinos, Phys. Lett. B437 (1998) 107–116. [arXiv:hep-ph/9806387](#), [doi:10.1016/S0370-2693\(98\)00880-6](#).
- [455] G. Altarelli, F. Feruglio, Tri-bimaximal neutrino mixing from discrete symmetry in extra dimensions, Nucl. Phys. B720 (2005) 64–88. [arXiv:hep-ph/0504165](#), [doi:10.1016/j.nuclphysb.2005.05.005](#).
- [456] E. Ma, Aspects of the tetrahedral neutrino mass matrix, Phys. Rev. D72 (2005) 037301. [arXiv:hep-ph/0505209](#), [doi:10.1103/PhysRevD.72.037301](#).
- [457] K. S. Babu, X.-G. He, Model of geometric neutrino mixing [arXiv:hep-ph/0507217](#).
- [458] G. Altarelli, F. Feruglio, Tri-bimaximal neutrino mixing, A(4) and the modular symmetry, Nucl. Phys. B741 (2006) 215–235. [arXiv:hep-ph/0512103](#), [doi:10.1016/j.nuclphysb.2006.02.015](#).
- [459] C. Hagedorn, M. Lindner, R. N. Mohapatra, S(4) flavor symmetry and fermion masses: Towards a grand unified theory of flavor, JHEP 06 (2006) 042. [arXiv:hep-ph/0602244](#), [doi:10.1088/1126-6708/2006/06/042](#).
- [460] Y. Cai, H.-B. Yu, A SO(10) GUT Model with S4 Flavor Symmetry, Phys. Rev. D74 (2006) 115005. [arXiv:hep-ph/0608022](#), [doi:10.1103/PhysRevD.74.115005](#).
- [461] H. Zhang, Flavor S(4) x Z(2) symmetry and neutrino mixing, Phys. Lett. B655 (2007) 132–140. [arXiv:hep-ph/0612214](#), [doi:10.1016/j.physletb.2007.09.003](#).
- [462] C. S. Lam, Determining Horizontal Symmetry from Neutrino Mixing, Phys. Rev. Lett. 101 (2008) 121602. [arXiv:0804.2622](#), [doi:10.1103/PhysRevLett.101.121602](#).
- [463] C. Giunti, Current status of neutrino masses and mixings (2002) 24–28 [Nucl. Phys. Proc. Suppl. 117, 24 (2003)]. [arXiv:hep-ph/0209103](#), [doi:10.1016/S0920-5632\(03\)90480-4](#).
- [464] Z.-z. Xing, Wolfenstein - like parametrization of the neutrino mixing matrix, J. Phys. G29 (2003) 2227–2234.

- [arXiv:hep-ph/0211465](#), [doi:10.1088/0954-3899/29/9/316](#).
- [465] C. H. Albright, A. Dueck, W. Rodejohann, Possible Alternatives to Tri-bimaximal Mixing, *Eur. Phys. J. C* 70 (2010) 1099–1110. [arXiv:1004.2798](#), [doi:10.1140/epjc/s10052-010-1492-2](#).
- [466] Y. Kajiyama, M. Raidal, A. Strumia, The Golden ratio prediction for the solar neutrino mixing, *Phys. Rev. D* 76 (2007) 117301. [arXiv:0705.4559](#), [doi:10.1103/PhysRevD.76.117301](#).
- [467] W. Rodejohann, Unified Parametrization for Quark and Lepton Mixing Angles, *Phys. Lett. B* 671 (2009) 267–271. [arXiv:0810.5239](#), [doi:10.1016/j.physletb.2008.12.010](#).
- [468] Z.-z. Xing, Tetra-maximal Neutrino Mixing and Its Implications on Neutrino Oscillations and Collider Signatures, *Phys. Rev. D* 78 (2008) 011301. [arXiv:0805.0416](#), [doi:10.1103/PhysRevD.78.011301](#).
- [469] W. Rodejohann, H. Zhang, S. Zhou, Systematic search for successful lepton mixing patterns with nonzero  $\theta_{13}$ , *Nucl. Phys. B* 855 (2012) 592–607. [arXiv:1107.3970](#), [doi:10.1016/j.nuclphysb.2011.10.017](#).
- [470] G.-J. Ding, Y.-L. Zhou, Dirac Neutrinos with  $S_4$  Flavor Symmetry in Warped Extra Dimensions, *Nucl. Phys. B* 876 (2013) 418–452. [arXiv:1304.2645](#), [doi:10.1016/j.nuclphysb.2013.08.011](#).
- [471] C. Jarlskog, Commutator of the Quark Mass Matrices in the Standard Electroweak Model and a Measure of Maximal CP Violation, *Phys. Rev. Lett.* 55 (1985) 1039. [doi:10.1103/PhysRevLett.55.1039](#).
- [472] D.-d. Wu, The Rephasing Invariants and CP, *Phys. Rev. D* 33 (1986) 860. [doi:10.1103/PhysRevD.33.860](#).
- [473] M. Jacobson, T. Ohlsson, Extrinsic CPT violation in neutrino oscillations in matter, *Phys. Rev. D* 69 (2004) 013003. [arXiv:hep-ph/0305064](#), [doi:10.1103/PhysRevD.69.013003](#).
- [474] T. Ohlsson, S. Zhou, Extrinsic and Intrinsic CPT Asymmetries in Neutrino Oscillations, *Nucl. Phys. B* 893 (2015) 482–500. [arXiv:1408.4722](#), [doi:10.1016/j.nuclphysb.2015.02.015](#).
- [475] C. Jarlskog, R. Stora, Unitarity Polygons and CP Violation Areas and Phases in the Standard Electroweak Model, *Phys. Lett. B* 208 (1988) 268–274. [doi:10.1016/0370-2693\(88\)90428-5](#).
- [476] C. Hamzaoui, The Measure of CP Violation and Its Consequence on the Structure of the Kobayashi-Maskawa Matrix, *Phys. Rev. Lett.* 61 (1988) 35. [doi:10.1103/PhysRevLett.61.35](#).
- [477] F. J. Botella, L.-L. Chau, Anticipating the Higher Generations of Quarks from Rephasing Invariance of the Mixing Matrix, *Phys. Lett.* 168B (1986) 97–104. [doi:10.1016/0370-2693\(86\)91468-1](#).
- [478] W.-l. Guo, Z.-z. Xing, Rephasing invariants of CP and T violation in the four neutrino mixing models, *Phys. Rev. D* 65 (2002) 073020. [arXiv:hep-ph/0112121](#), [doi:10.1103/PhysRevD.65.073020](#).
- [479] H. Fritzsch, Z.-z. Xing, The Light quark sector, CP violation, and the unitarity triangle, *Nucl. Phys. B* 556 (1999) 49–75. [arXiv:hep-ph/9904286](#), [doi:10.1016/S0550-3213\(99\)00337-5](#).
- [480] J.-w. Mei, Z.-z. Xing, Impact of fermion mass degeneracy on flavor mixing, *J. Phys. G* 30 (2004) 1243–1252. [arXiv:hep-ph/0312382](#), [doi:10.1088/0256-307X/21/8/023](#), [doi:10.1088/0954-3899/30/9/022](#).
- [481] P. F. Harrison, W. G. Scott, CP and T violation in neutrino oscillations and invariance of Jarlskog’s determinant to matter effects, *Phys. Lett. B* 476 (2000) 349–355. [arXiv:hep-ph/9912435](#), [doi:10.1016/S0370-2693\(00\)00153-2](#).
- [482] Z.-z. Xing, Commutators of lepton mass matrices, CP violation, and matter effects in-medium baseline neutrino experiments, *Phys. Rev. D* 63 (2001) 073012. [arXiv:hep-ph/0009294](#), [doi:10.1103/PhysRevD.63.073012](#).
- [483] V. A. Naumov, Three neutrino oscillations in matter, CP violation and topological phases, *Int. J. Mod. Phys. D* 1 (1992) 379–399. [doi:10.1142/S0218271892000203](#).
- [484] Z.-z. Xing, J.-y. Zhu, Analytical approximations for matter effects on CP violation in the accelerator-based neutrino oscillations with  $E \lesssim 1$  GeV, *JHEP* 07 (2016) 011. [arXiv:1603.02002](#), [doi:10.1007/JHEP07\(2016\)011](#).
- [485] X. Wang, S. Zhou, On the Properties of the Effective Jarlskog Invariant for Three-flavor Neutrino Oscillations in Matter [arXiv:1908.07304](#).
- [486] Y. Wang, Z.-z. Xing, Commutators of lepton mass matrices associated with the seesaw and leptogenesis mechanisms, *Phys. Rev. D* 89 (9) (2014) 097301. [arXiv:1404.0109](#), [doi:10.1103/PhysRevD.89.097301](#).
- [487] G. C. Branco, T. Morozumi, B. M. Nobre, M. N. Rebelo, A Bridge between CP violation at low-energies and leptogenesis, *Nucl. Phys. B* 617 (2001) 475–492. [arXiv:hep-ph/0107164](#), [doi:10.1016/S0550-3213\(01\)00425-4](#).
- [488] P. F. Harrison, S. Dallison, W. G. Scott, The Matrix of Unitarity Triangle Angles for Quarks, *Phys. Lett. B* 680

- (2009) 328–333. [arXiv:0904.3077](#), [doi:10.1016/j.physletb.2009.09.004](#).
- [489] S. Luo, Z.-z. Xing, Radiative Corrections to the CKM Unitarity Triangles, *J. Phys. G* 37 (2010) 075018. [arXiv:0912.4593](#), [doi:10.1088/0954-3899/37/7/075018](#).
- [490] R. Aleksan, B. Kayser, D. London, Determining the quark mixing matrix from CP violating asymmetries, *Phys. Rev. Lett.* 73 (1994) 18–20. [arXiv:hep-ph/9403341](#), [doi:10.1103/PhysRevLett.73.18](#).
- [491] I. I. Y. Bigi, A. I. Sanda, On the other five KM triangles [arXiv:hep-ph/9909479](#).
- [492] Z.-Z. Xing, D. Zhang, Distinguishing between the twin  $b$ -flavored unitarity triangles on a circular arc [arXiv:1911.03292](#).
- [493] J. A. Aguilar-Saavedra, G. C. Branco, Unitarity triangles and geometrical description of CP violation with Majorana neutrinos, *Phys. Rev. D* 62 (2000) 096009. [arXiv:hep-ph/0007025](#), [doi:10.1103/PhysRevD.62.096009](#).
- [494] Z.-z. Xing, J.-y. Zhu, Leptonic Unitarity Triangles and Effective Mass Triangles of the Majorana Neutrinos, *Nucl. Phys. B* 908 (2016) 302–317. [arXiv:1511.00450](#), [doi:10.1016/j.nuclphysb.2016.03.031](#).
- [495] M. C. Gonzalez-Garcia, M. Maltoni, T. Schwetz, Updated fit to three neutrino mixing: status of leptonic CP violation, *JHEP* 11 (2014) 052. [arXiv:1409.5439](#), [doi:10.1007/JHEP11\(2014\)052](#).
- [496] S. Luo, Dirac Lepton Angle Matrix v.s. Majorana Lepton Angle Matrix and Their Renormalization Group Running Behaviours, *Phys. Rev. D* 85 (2012) 013006. [arXiv:1109.4260](#), [doi:10.1103/PhysRevD.85.013006](#).
- [497] J. F. Nieves, P. B. Pal, Minimal Rephasing Invariant CP Violating Parameters With Dirac and Majorana Fermions, *Phys. Rev. D* 36 (1987) 315. [doi:10.1103/PhysRevD.36.315](#).
- [498] H. Fritzsch, Z.-z. Xing, On the parametrization of flavor mixing in the standard model, *Phys. Rev. D* 57 (1998) 594–597. [arXiv:hep-ph/9708366](#), [doi:10.1103/PhysRevD.57.594](#).
- [499] N. Li, B.-Q. Ma, Parametrization of neutrino mixing matrix in tri-bimaximal mixing pattern, *Phys. Rev. D* 71 (2005) 017302. [arXiv:hep-ph/0412126](#), [doi:10.1103/PhysRevD.71.017302](#).
- [500] S. Pakvasa, W. Rodejohann, T. J. Weiler, Unitary parametrization of perturbations to tribimaximal neutrino mixing, *Phys. Rev. Lett.* 100 (2008) 111801. [arXiv:0711.0052](#), [doi:10.1103/PhysRevLett.100.111801](#).
- [501] Z.-Z. Xing, The T2K Indication of Relatively Large  $\theta_{13}$  and a Natural Perturbation to the Democratic Neutrino Mixing Pattern, *Chin. Phys. C* 36 (2012) 101–105. [arXiv:1106.3244](#), [doi:10.1088/1674-1137/36/2/001](#).
- [502] S. F. King, Tri-bimaximal-Cabibbo Mixing, *Phys. Lett. B* 718 (2012) 136–142. [arXiv:1205.0506](#), [doi:10.1016/j.physletb.2012.10.028](#).
- [503] B. Hu, Trimaximal-Cabibbo neutrino mixing: A parametrization in terms of deviations from tribimaximal mixing, *Phys. Rev. D* 87 (5) (2013) 053011. [arXiv:1212.4079](#), [doi:10.1103/PhysRevD.87.053011](#).
- [504] R. P. Feynman, The development of the space-time view of quantum electrodynamics, *Science* 153 (3737) (1966) 699–708, [*World Sci. Ser. 20th Cent. Phys.* 27, 9 (2000)]. [doi:10.1063/1.3048404](#), [10.1126/science.153.3737.699](#).
- [505] H. Fritzsch, Z.-Z. Xing, Flavor symmetries and the description of flavor mixing, *Phys. Lett. B* 413 (1997) 396–404. [arXiv:hep-ph/9707215](#), [doi:10.1016/S0370-2693\(97\)01130-1](#).
- [506] R. Barbieri, G. R. Dvali, L. J. Hall, Predictions from a U(2) flavor symmetry in supersymmetric theories, *Phys. Lett. B* 377 (1996) 76–82. [arXiv:hep-ph/9512388](#), [doi:10.1016/0370-2693\(96\)00318-8](#).
- [507] R. Barbieri, L. J. Hall, A. Romanino, Consequences of a U(2) flavor symmetry, *Phys. Lett. B* 401 (1997) 47–53. [arXiv:hep-ph/9702315](#), [doi:10.1016/S0370-2693\(97\)00372-9](#).
- [508] J. L. Chkareuli, C. D. Froggatt, Where does flavor mixing come from?, *Phys. Lett. B* 450 (1999) 158–164. [arXiv:hep-ph/9812499](#), [doi:10.1016/S0370-2693\(99\)00126-4](#).
- [509] H. Fritzsch, Z.-z. Xing, Four zero texture of Hermitian quark mass matrices and current experimental tests, *Phys. Lett. B* 555 (2003) 63–70. [arXiv:hep-ph/0212195](#), [doi:10.1016/S0370-2693\(03\)00048-0](#).
- [510] H. Fritzsch, Z.-z. Xing, A Symmetry pattern of maximal CP violation and a determination of the unitarity triangle, *Phys. Lett. B* 353 (1995) 114–118. [arXiv:hep-ph/9502297](#), [doi:10.1016/0370-2693\(95\)00545-V](#).
- [511] Z.-z. Xing, Right Unitarity Triangles, Stable CP-violating Phases and Approximate Quark-Lepton Comple-

- mentarity, Phys. Lett. B679 (2009) 111–117. [arXiv:0904.3172](#), [doi:10.1016/j.physletb.2009.07.027](#).
- [512] S. Antusch, S. F. King, M. Malinsky, M. Spinrath, Quark mixing sum rules and the right unitarity triangle, Phys. Rev. D81 (2010) 033008. [arXiv:0910.5127](#), [doi:10.1103/PhysRevD.81.033008](#).
- [513] Z.-z. Xing, A Novel parametrization of tau-lepton dominance and simplified one-loop renormalization-group equations of neutrino mixing angles and CP-violating phases, Phys. Lett. B633 (2006) 550–556. [arXiv:hep-ph/0510312](#), [doi:10.1016/j.physletb.2005.12.023](#).
- [514] Y.-L. Zhou, The Kobayashi-Maskawa Parametrization of Lepton Flavor Mixing and Its Application to Neutrino Oscillations in Matter, Phys. Rev. D84 (2011) 113012. [arXiv:1110.5023](#), [doi:10.1103/PhysRevD.84.113012](#).
- [515] S. Toshev, On T violation in matter neutrino oscillations, Mod. Phys. Lett. A6 (1991) 455–460. [doi:10.1142/S0217732391000464](#).
- [516] Z.-z. Xing, Y.-L. Zhou, A Generic Diagonalization of the  $3 \times 3$  Neutrino Mass Matrix and Its Implications on the  $\mu - \tau$  Flavor Symmetry and Maximal CP Violation, Phys. Lett. B693 (2010) 584–590. [arXiv:1008.4906](#), [doi:10.1016/j.physletb.2010.09.020](#).
- [517] J.-M. Gerard, Z.-z. Xing, Flavor Mixing Democracy and Minimal CP Violation, Phys. Lett. B713 (2012) 29–34. [arXiv:1203.0496](#), [doi:10.1016/j.physletb.2012.05.037](#).
- [518] H. W. Zaglauer, K. H. Schwarzer, The Mixing Angles in Matter for Three Generations of Neutrinos and the Msw Mechanism, Z. Phys. C40 (1988) 273. [doi:10.1007/BF01555889](#).
- [519] Z.-z. Xing, New formulation of matter effects on neutrino mixing and CP violation, Phys. Lett. B487 (2000) 327–333. [arXiv:hep-ph/0002246](#), [doi:10.1016/S0370-2693\(00\)00832-7](#).
- [520] Z.-Z. Xing, J.-Y. Zhu, Sum rules and asymptotic behaviors of neutrino mixing in dense matter, Nucl. Phys. B949 (2019) 114803. [arXiv:1905.08644](#), [doi:10.1016/j.nuclphysb.2019.114803](#).
- [521] F. J. Botella, C. S. Lim, W. J. Marciano, Radiative Corrections to Neutrino Indices of Refraction, Phys. Rev. D35 (1987) 896. [doi:10.1103/PhysRevD.35.896](#).
- [522] E. C. G. Stueckelberg de Breidenbach, A. Petermann, La normalisation des constantes dans la thorie des quanta Normalization of constants in the quanta theory, Helv. Phys. Acta 26 (1953) 499–520. [doi:10.5169/seals-112426](#).
- [523] M. Gell-Mann, F. E. Low, Quantum electrodynamics at small distances, Phys. Rev. 95 (1954) 1300–1312. [doi:10.1103/PhysRev.95.1300](#).
- [524] Z.-z. Xing, S. Zhou, Y.-L. Zhou, Renormalization-Group Equations of Neutrino Masses and Flavor Mixing Parameters in Matter, JHEP 05 (2018) 015. [arXiv:1802.00990](#), [doi:10.1007/JHEP05\(2018\)015](#).
- [525] K. G. Wilson, Renormalization group and critical phenomena. 1. Renormalization group and the Kadanoff scaling picture, Phys. Rev. B4 (1971) 3174–3183. [doi:10.1103/PhysRevB.4.3174](#).
- [526] K. G. Wilson, Renormalization group and critical phenomena. 2. Phase space cell analysis of critical behavior, Phys. Rev. B4 (1971) 3184–3205. [doi:10.1103/PhysRevB.4.3184](#).
- [527] X. Wang, S. Zhou, Analytical solutions to renormalization-group equations of effective neutrino masses and mixing parameters in matter, JHEP 05 (2019) 035. [arXiv:1901.10882](#), [doi:10.1007/JHEP05\(2019\)035](#).
- [528] N. N. Bogolyubov, D. V. Shirkov, Charge renormalization group in quantum field theory, Nuovo Cim. 3 (1956) 845–863. [doi:10.1007/BF02823486](#).
- [529] S. F. King, N. N. Singh, Renormalization group analysis of single right-handed neutrino dominance, Nucl. Phys. B591 (2000) 3–25. [arXiv:hep-ph/0006229](#), [doi:10.1016/S0550-3213\(00\)00545-9](#).
- [530] S. Antusch, J. Kersten, M. Lindner, M. Ratz, Neutrino mass matrix running for nondegenerate seesaw scales, Phys. Lett. B538 (2002) 87–95. [arXiv:hep-ph/0203233](#), [doi:10.1016/S0370-2693\(02\)01960-3](#).
- [531] J.-w. Mei, Running neutrino masses, leptonic mixing angles and CP-violating phases: From  $M_Z$  to  $\Lambda_{\text{GUT}}$ , Phys. Rev. D71 (2005) 073012. [arXiv:hep-ph/0502015](#), [doi:10.1103/PhysRevD.71.073012](#).
- [532] S. Antusch, J. Kersten, M. Lindner, M. Ratz, M. A. Schmidt, Running neutrino mass parameters in see-saw scenarios, JHEP 03 (2005) 024. [arXiv:hep-ph/0501272](#), [doi:10.1088/1126-6708/2005/03/024](#).
- [533] W. Chao, H. Zhang, One-loop renormalization group equations of the neutrino mass matrix in the triplet seesaw model, Phys. Rev. D75 (2007) 033003. [arXiv:hep-ph/0611323](#), [doi:10.1103/PhysRevD.75.033003](#).

- [534] M. A. Schmidt, Renormalization group evolution in the type I+II seesaw model, *Phys. Rev. D* 76 (2007) 073010, [Erratum: *Phys. Rev. D* 85, 099903 (2012)]. [arXiv:0705.3841](#), [doi:10.1103/PhysRevD.85.099903](#), [10.1103/PhysRevD.76.073010](#).
- [535] J. Chakraborty, A. Dighe, S. Goswami, S. Ray, Renormalization group evolution of neutrino masses and mixing in the Type-III seesaw mechanism, *Nucl. Phys. B* 820 (2009) 116–147. [arXiv:0812.2776](#), [doi:10.1016/j.nuclphysb.2009.05.016](#).
- [536] T. Ohlsson, S. Zhou, Renormalization group running of neutrino parameters, *Nature Commun.* 5 (2014) 5153. [arXiv:1311.3846](#), [doi:10.1038/ncomms6153](#).
- [537] Y. Liao, Unique Neutrino Mass Operator at any Mass Dimension, *Phys. Lett. B* 694 (2011) 346–348. [arXiv:1009.1692](#), [doi:10.1016/j.physletb.2010.10.005](#).
- [538] P. H. Chankowski, Z. Pluciennik, Renormalization group equations for seesaw neutrino masses, *Phys. Lett. B* 316 (1993) 312–317. [arXiv:hep-ph/9306333](#), [doi:10.1016/0370-2693\(93\)90330-K](#).
- [539] K. S. Babu, C. N. Leung, J. T. Pantaleone, Renormalization of the neutrino mass operator, *Phys. Lett. B* 319 (1993) 191–198. [arXiv:hep-ph/9309223](#), [doi:10.1016/0370-2693\(93\)90801-N](#).
- [540] S. Antusch, M. Drees, J. Kersten, M. Lindner, M. Ratz, Neutrino mass operator renormalization revisited, *Phys. Lett. B* 519 (2001) 238–242. [arXiv:hep-ph/0108005](#), [doi:10.1016/S0370-2693\(01\)01127-3](#).
- [541] S. Antusch, M. Drees, J. Kersten, M. Lindner, M. Ratz, Neutrino mass operator renormalization in two Higgs doublet models and the MSSM, *Phys. Lett. B* 525 (2002) 130–134. [arXiv:hep-ph/0110366](#), [doi:10.1016/S0370-2693\(01\)01414-9](#).
- [542] M. Lindner, M. Ratz, M. A. Schmidt, Renormalization group evolution of Dirac neutrino masses, *JHEP* 09 (2005) 081. [arXiv:hep-ph/0506280](#), [doi:10.1088/1126-6708/2005/09/081](#).
- [543] P. Fayet, Spontaneously Broken Supersymmetric Theories of Weak, Electromagnetic and Strong Interactions, *Phys. Lett. B* 69B (1977) 489. [doi:10.1016/0370-2693\(77\)90852-8](#).
- [544] S. Antusch, J. Kersten, M. Lindner, M. Ratz, Dynamical electroweak symmetry breaking by a neutrino condensate, *Nucl. Phys. B* 658 (2003) 203–216. [arXiv:hep-ph/0211385](#), [doi:10.1016/S0550-3213\(03\)00188-3](#).
- [545] M. Ahmad, et al., CEPC-SPPC Preliminary Conceptual Design Report. 1. Physics and Detector.
- [546] M. Dong, et al., CEPC Conceptual Design Report: Volume 2 - Physics & Detector [arXiv:1811.10545](#).
- [547] S. G. Naculich, Third generation effects on fermion mass predictions in supersymmetric grand unified theories, *Phys. Rev. D* 48 (1993) 5293–5304. [arXiv:hep-ph/9301258](#), [doi:10.1103/PhysRevD.48.5293](#).
- [548] P. Kielanowski, S. R. Juez Wysozka, J. H. Montes de Oca Y., Renormalization Group Equations for the CKM matrix, *Phys. Rev. D* 78 (2008) 116010. [arXiv:0810.2097](#), [doi:10.1103/PhysRevD.78.116010](#).
- [549] K. S. Babu, Q. Shafi, Heavy top quark from Fritzsch mass matrices, *Phys. Rev. D* 47 (1993) 5004–5012. [arXiv:hep-ph/9210251](#), [doi:10.1103/PhysRevD.47.5004](#).
- [550] Z.-z. Xing, Implications of the quark mass hierarchy on flavor mixings, *J. Phys. G* 23 (1997) 1563–1578. [arXiv:hep-ph/9609204](#), [doi:10.1088/0954-3899/23/11/006](#).
- [551] P. Ramond, R. G. Roberts, G. G. Ross, Stitching the Yukawa quilt, *Nucl. Phys. B* 406 (1993) 19–42. [arXiv:hep-ph/9303320](#), [doi:10.1016/0550-3213\(93\)90159-M](#).
- [552] J. A. Casas, J. R. Espinosa, A. Ibarra, I. Navarro, General RG equations for physical neutrino parameters and their phenomenological implications, *Nucl. Phys. B* 573 (2000) 652–684. [arXiv:hep-ph/9910420](#), [doi:10.1016/S0550-3213\(99\)00781-6](#).
- [553] S. Antusch, J. Kersten, M. Lindner, M. Ratz, Running neutrino masses, mixings and CP phases: Analytical results and phenomenological consequences, *Nucl. Phys. B* 674 (2003) 401–433. [arXiv:hep-ph/0305273](#), [doi:10.1016/j.nuclphysb.2003.09.050](#).
- [554] Z.-z. Xing, A full parametrization of the 6 X 6 flavor mixing matrix in the presence of three light or heavy sterile neutrinos, *Phys. Rev. D* 85 (2012) 013008. [arXiv:1110.0083](#), [doi:10.1103/PhysRevD.85.013008](#).
- [555] Z.-z. Xing, Correlation between the Charged Current Interactions of Light and Heavy Majorana Neutrinos, *Phys. Lett. B* 660 (2008) 515–521. [arXiv:0709.2220](#), [doi:10.1016/j.physletb.2008.01.038](#).
- [556] J. Kopp, M. Maltoni, T. Schwetz, Are there sterile neutrinos at the eV scale?, *Phys. Rev. Lett.* 107 (2011) 091801. [arXiv:1103.4570](#), [doi:10.1103/PhysRevLett.107.091801](#).
- [557] K. N. Abazajian, et al., Light Sterile Neutrinos: A White Paper [arXiv:1204.5379](#).

- [558] S. Gariazzo, C. Giunti, M. Laveder, Y. F. Li, E. M. Zavanin, Light sterile neutrinos, *J. Phys.* G43 (2016) 033001. [arXiv:1507.08204](#), [doi:10.1088/0954-3899/43/3/033001](#).
- [559] C. Jarlskog, A Basis Independent Formulation of the Connection Between Quark Mass Matrices, CP Violation and Experiment, *Z. Phys.* C29 (1985) 491–497. [doi:10.1007/BF01565198](#).
- [560] M. Malinsky, T. Ohlsson, Z.-z. Xing, H. Zhang, Non-unitary neutrino mixing and CP violation in the minimal inverse seesaw model, *Phys. Lett.* B679 (2009) 242–248. [arXiv:0905.2889](#), [doi:10.1016/j.physletb.2009.07.038](#).
- [561] C. Giunti, Flavor neutrinos states [arXiv:hep-ph/0402217](#).
- [562] S. F. King, Littlest Seesaw, *JHEP* 02 (2016) 085. [arXiv:1512.07531](#), [doi:10.1007/JHEP02\(2016\)085](#).
- [563] K. Harigaya, M. Ibe, T. T. Yanagida, Seesaw Mechanism with Occam’s Razor, *Phys. Rev.* D86 (2012) 013002. [arXiv:1205.2198](#), [doi:10.1103/PhysRevD.86.013002](#).
- [564] T. Ohlsson, Cutting with Occam’s razor, *Phys. Rev.* D86 (2012) 097301. [doi:10.1103/PhysRevD.86.097301](#).
- [565] T. Yanagida, Seesaw with Occam’s Razor, *Nucl. Phys. Proc. Suppl.* 235-236 (2013) 245–248. [doi:10.1016/j.nuclphysbps.2013.04.017](#).
- [566] M. Tanimoto, T. T. Yanagida, Occam’s Razor in Quark Mass Matrices, *PTEP* 2016 (4) (2016) 043B03. [arXiv:1601.04459](#), [doi:10.1093/ptep/ptw024](#).
- [567] Y. Kaneta, Y. Shimizu, M. Tanimoto, T. T. Yanagida, Occams razor in lepton mass matrices: The sign of the universes baryon asymmetry, *PTEP* 2016 (6) (2016) 063B03. [arXiv:1604.03315](#), [doi:10.1093/ptep/ptw079](#).
- [568] A. Ibarra, G. G. Ross, Neutrino phenomenology: The Case of two right-handed neutrinos, *Phys. Lett.* B591 (2004) 285–296. [arXiv:hep-ph/0312138](#), [doi:10.1016/j.physletb.2004.04.037](#).
- [569] T. Endoh, S. Kaneko, S. K. Kang, T. Morozumi, M. Tanimoto, CP violation in neutrino oscillation and leptogenesis, *Phys. Rev. Lett.* 89 (2002) 231601. [arXiv:hep-ph/0209020](#), [doi:10.1103/PhysRevLett.89.231601](#).
- [570] V. Barger, D. A. Dicus, H.-J. He, T.-j. Li, Structure of cosmological CP violation via neutrino seesaw, *Phys. Lett.* B583 (2004) 173–185. [arXiv:hep-ph/0310278](#), [doi:10.1016/j.physletb.2003.12.037](#).
- [571] T. Fujihara, S. Kaneko, S. K. Kang, D. Kimura, T. Morozumi, M. Tanimoto, Cosmological family asymmetry and CP violation, *Phys. Rev.* D72 (2005) 016006. [arXiv:hep-ph/0505076](#), [doi:10.1103/PhysRevD.72.016006](#).
- [572] A. Ibarra, Reconstructing the two right-handed neutrino model, *JHEP* 01 (2006) 064. [arXiv:hep-ph/0511136](#), [doi:10.1088/1126-6708/2006/01/064](#).
- [573] P.-H. Gu, H. Zhang, S. Zhou, A Minimal Type II Seesaw Model, *Phys. Rev.* D74 (2006) 076002. [arXiv:hep-ph/0606302](#), [doi:10.1103/PhysRevD.74.076002](#).
- [574] A. H. Chan, H. Fritzsch, S. Luo, Z.-z. Xing, Deviations from Tri-bimaximal Neutrino Mixing in Type-II Seesaw and Leptogenesis, *Phys. Rev.* D76 (2007) 073009. [arXiv:0704.3153](#), [doi:10.1103/PhysRevD.76.073009](#).
- [575] W. Chao, Z.-G. Si, Z.-z. Xing, S. Zhou, Correlative signatures of heavy Majorana neutrinos and doubly-charged Higgs bosons at the Large Hadron Collider, *Phys. Lett.* B666 (2008) 451–454. [arXiv:0804.1265](#), [doi:10.1016/j.physletb.2008.08.003](#).
- [576] P. Ren, Z.-z. Xing, Interference bands in decays of doubly-charged Higgs bosons to dileptons in the minimal type-II seesaw model at the TeV scale, *Phys. Lett.* B666 (2008) 48–56. [arXiv:0805.4292](#), [doi:10.1016/j.physletb.2008.06.059](#).
- [577] W.-l. Guo, Z.-z. Xing, Unitarity quadrangles of four neutrino mixing, *Phys. Rev.* D66 (2002) 097302. [arXiv:hep-ph/0209017](#), [doi:10.1103/PhysRevD.66.097302](#).
- [578] J. D. Clarke, R. Foot, R. R. Volkas, Electroweak naturalness in the three-flavor type I seesaw model and implications for leptogenesis, *Phys. Rev.* D91 (7) (2015) 073009. [arXiv:1502.01352](#), [doi:10.1103/PhysRevD.91.073009](#).
- [579] T. Han, B. Zhang, Signatures for Majorana neutrinos at hadron colliders, *Phys. Rev. Lett.* 97 (2006) 171804. [arXiv:hep-ph/0604064](#), [doi:10.1103/PhysRevLett.97.171804](#).
- [580] F. del Aguila, J. A. Aguilar-Saavedra, R. Pittau, Heavy neutrino signals at large hadron colliders, *JHEP* 10

- (2007) 047. [arXiv:hep-ph/0703261](https://arxiv.org/abs/hep-ph/0703261), [doi:10.1088/1126-6708/2007/10/047](https://doi.org/10.1088/1126-6708/2007/10/047).
- [581] J.-L. Gervais, B. Sakita, Field Theory Interpretation of Supergauges in Dual Models, Nucl. Phys. B34 (1971) 632–639. [doi:10.1016/0550-3213\(71\)90351-8](https://doi.org/10.1016/0550-3213(71)90351-8).
- [582] Yu. A. Golfand, E. P. Likhtman, Extension of the Algebra of Poincare Group Generators and Violation of p Invariance, JETP Lett. 13 (1971) 323–326, [Pisma Zh. Eksp. Teor. Fiz. 13, 452 (1971)].
- [583] P. Ramond, Dual Theory for Free Fermions, Phys. Rev. D3 (1971) 2415–2418. [doi:10.1103/PhysRevD.3.2415](https://doi.org/10.1103/PhysRevD.3.2415).
- [584] D. V. Volkov, V. P. Akulov, Possible universal neutrino interaction, JETP Lett. 16 (1972) 438–440, [Pisma Zh. Eksp. Teor. Fiz. 16, 621 (1972)].
- [585] D. V. Volkov, V. P. Akulov, Is the Neutrino a Goldstone Particle?, Phys. Lett. 46B (1973) 109–110. [doi:10.1016/0370-2693\(73\)90490-5](https://doi.org/10.1016/0370-2693(73)90490-5).
- [586] J. Wess, B. Zumino, A Lagrangian Model Invariant Under Supergauge Transformations, Phys. Lett. 49B (1974) 52. [doi:10.1016/0370-2693\(74\)90578-4](https://doi.org/10.1016/0370-2693(74)90578-4).
- [587] J. Wess, B. Zumino, Supergauge Transformations in Four-Dimensions, Nucl. Phys. B70 (1974) 39–50. [doi:10.1016/0550-3213\(74\)90355-1](https://doi.org/10.1016/0550-3213(74)90355-1).
- [588] J. Bernabeu, A. Santamaria, J. Vidal, A. Mendez, J. W. F. Valle, Lepton Flavor Nonconservation at High-Energies in a Superstring Inspired Standard Model, Phys. Lett. B187 (1987) 303–308. [doi:10.1016/0370-2693\(87\)91100-2](https://doi.org/10.1016/0370-2693(87)91100-2).
- [589] W. Buchmuller, D. Wyler, Dilatons and majorana neutrinos, Phys. Lett. B249 (1990) 458–462. [doi:10.1016/0370-2693\(90\)91016-5](https://doi.org/10.1016/0370-2693(90)91016-5).
- [590] A. Pilaftsis, Radiatively induced neutrino masses and large Higgs neutrino couplings in the standard model with Majorana fields, Z. Phys. C55 (1992) 275–282. [arXiv:hep-ph/9901206](https://arxiv.org/abs/hep-ph/9901206), [doi:10.1007/BF01482590](https://doi.org/10.1007/BF01482590).
- [591] C. A. Heusch, P. Minkowski, Lepton flavor violation induced by heavy Majorana neutrinos, Nucl. Phys. B416 (1994) 3–45. [doi:10.1016/0550-3213\(94\)90576-2](https://doi.org/10.1016/0550-3213(94)90576-2).
- [592] D. Tommasini, G. Barenboim, J. Bernabeu, C. Jarlskog, Nondecoupling of heavy neutrinos and lepton flavor violation, Nucl. Phys. B444 (1995) 451–467. [arXiv:hep-ph/9503228](https://arxiv.org/abs/hep-ph/9503228), [doi:10.1016/0550-3213\(95\)00201-3](https://doi.org/10.1016/0550-3213(95)00201-3).
- [593] K. Huitu, J. Maalampi, A. Pietila, M. Raidal, Doubly charged Higgs at LHC, Nucl. Phys. B487 (1997) 27–42. [arXiv:hep-ph/9606311](https://arxiv.org/abs/hep-ph/9606311), [doi:10.1016/S0550-3213\(97\)87466-4](https://doi.org/10.1016/S0550-3213(97)87466-4).
- [594] B. Dion, T. Gregoire, D. London, L. Marleau, H. Nadeau, Bilepton production at hadron colliders, Phys. Rev. D59 (1999) 075006. [arXiv:hep-ph/9810534](https://arxiv.org/abs/hep-ph/9810534), [doi:10.1103/PhysRevD.59.075006](https://doi.org/10.1103/PhysRevD.59.075006).
- [595] E. J. Chun, K. Y. Lee, S. C. Park, Testing Higgs triplet model and neutrino mass patterns, Phys. Lett. B566 (2003) 142–151. [arXiv:hep-ph/0304069](https://arxiv.org/abs/hep-ph/0304069), [doi:10.1016/S0370-2693\(03\)00770-6](https://doi.org/10.1016/S0370-2693(03)00770-6).
- [596] A. G. Akeroyd, M. Aoki, Single and pair production of doubly charged Higgs bosons at hadron colliders, Phys. Rev. D72 (2005) 035011. [arXiv:hep-ph/0506176](https://arxiv.org/abs/hep-ph/0506176), [doi:10.1103/PhysRevD.72.035011](https://doi.org/10.1103/PhysRevD.72.035011).
- [597] T. Han, B. Mukhopadhyaya, Z. Si, K. Wang, Pair production of doubly-charged scalars: Neutrino mass constraints and signals at the LHC, Phys. Rev. D76 (2007) 075013. [arXiv:0706.0441](https://arxiv.org/abs/0706.0441), [doi:10.1103/PhysRevD.76.075013](https://doi.org/10.1103/PhysRevD.76.075013).
- [598] C.-S. Chen, C.-Q. Geng, D. V. Zhuridov, Same-sign single dilepton productions at the LHC, Phys. Lett. B666 (2008) 340–343. [arXiv:0801.2011](https://arxiv.org/abs/0801.2011), [doi:10.1016/j.physletb.2008.07.088](https://doi.org/10.1016/j.physletb.2008.07.088).
- [599] J. Garayoa, T. Schwetz, Neutrino mass hierarchy and Majorana CP phases within the Higgs triplet model at the LHC, JHEP 03 (2008) 009. [arXiv:0712.1453](https://arxiv.org/abs/0712.1453), [doi:10.1088/1126-6708/2008/03/009](https://doi.org/10.1088/1126-6708/2008/03/009).
- [600] P. Fileviez Perez, T. Han, G.-y. Huang, T. Li, K. Wang, Neutrino Masses and the CERN LHC: Testing Type II Seesaw, Phys. Rev. D78 (2008) 015018. [arXiv:0805.3536](https://arxiv.org/abs/0805.3536), [doi:10.1103/PhysRevD.78.015018](https://doi.org/10.1103/PhysRevD.78.015018).
- [601] F. del Aguila, J. A. Aguilar-Saavedra, Distinguishing seesaw models at LHC with multi-lepton signals, Nucl. Phys. B813 (2009) 22–90. [arXiv:0808.2468](https://arxiv.org/abs/0808.2468), [doi:10.1016/j.nuclphysb.2008.12.029](https://doi.org/10.1016/j.nuclphysb.2008.12.029).
- [602] E. Dudas, C. A. Savoy, Multiple seesaw at low-energy, Acta Phys. Polon. B33 (2002) 2547–2558. [arXiv:hep-ph/0205264](https://arxiv.org/abs/hep-ph/0205264).
- [603] K. S. Babu, S. Nandi, Z. Tavartkiladze, New Mechanism for Neutrino Mass Generation and Triply Charged Higgs Bosons at the LHC, Phys. Rev. D80 (2009) 071702. [arXiv:0905.2710](https://arxiv.org/abs/0905.2710), [doi:10.1103/PhysRevD.80.071702](https://doi.org/10.1103/PhysRevD.80.071702).



- [604] S. Weinberg, Why the renormalization group is a good thing, Cambridge, Usa: MIT Pr. (1983) 1–19.
- [605] J. A. Casas, A. Ibarra, Oscillating neutrinos and  $\mu \rightarrow e\gamma$ , Nucl. Phys. B618 (2001) 171–204. [arXiv:hep-ph/0103065](#), [doi:10.1016/S0550-3213\(01\)00475-8](#).
- [606] Z.-z. Xing, Casas-Ibarra Parametrization and Unflavored Leptogenesis, Chin. Phys. C34 (2010) 1–6. [arXiv:0902.2469](#), [doi:10.1088/1674-1137/34/1/001](#).
- [607] S. T. Petcov, The Processes  $\mu \rightarrow e\gamma$ ,  $\mu \rightarrow ee\bar{e}$ ,  $\nu' \rightarrow \nu\gamma$  in the Weinberg-Salam Model with Neutrino Mixing, Sov. J. Nucl. Phys. 25 (1977) 340, [Erratum: Yad. Fiz. 25, 1336 (1977)].
- [608] S. M. Bilenky, S. T. Petcov, B. Pontecorvo, Lepton Mixing,  $\mu \rightarrow e + \gamma$  Decay and Neutrino Oscillations, Phys. Lett. 67B (1977) 309. [doi:10.1016/0370-2693\(77\)90379-3](#).
- [609] T. P. Cheng, L.-F. Li, Nonconservation of Separate  $\mu$ -Lepton and  $e$ -Lepton Numbers in Gauge Theories with V+A Currents, Phys. Rev. Lett. 38 (1977) 381. [doi:10.1103/PhysRevLett.38.381](#).
- [610] W. J. Marciano, A. I. Sanda, Exotic Decays of the Muon and Heavy Leptons in Gauge Theories, Phys. Lett. 67B (1977) 303–305. [doi:10.1016/0370-2693\(77\)90377-X](#).
- [611] B. W. Lee, S. Pakvasa, R. E. Shrock, H. Sugawara, Muon and Electron Number Nonconservation in a V-A Gauge Model, Phys. Rev. Lett. 38 (1977) 937, [Erratum: Phys. Rev. Lett. 38, 1230 (1977)]. [doi:10.1103/PhysRevLett.38.937](#), [doi:10.1103/PhysRevLett.38.1230](#).
- [612] B. W. Lee, R. E. Shrock, Natural Suppression of Symmetry Violation in Gauge Theories: Muon - Lepton and Electron Lepton Number Nonconservation, Phys. Rev. D16 (1977) 1444. [doi:10.1103/PhysRevD.16.1444](#).
- [613] R. H. Bernstein, P. S. Cooper, Charged Lepton Flavor Violation: An Experimenter’s Guide, Phys. Rept. 532 (2013) 27–64. [arXiv:1307.5787](#), [doi:10.1016/j.physrep.2013.07.002](#).
- [614] J. Albrecht, et al., **Working Group Report: Charged Leptons**, in: Proceedings, 2013 Community Summer Study on the Future of U.S. Particle Physics: Snowmass on the Mississippi (CSS2013): Minneapolis, MN, USA, July 29-August 6, 2013, 2013. [arXiv:1311.5278](#).  
URL <http://www.slac.stanford.edu/econf/C1307292/docs/IntensityFrontier/ChLeptons-14.pdf>
- [615] A. de Gouvea, P. Vogel, Lepton Flavor and Number Conservation, and Physics Beyond the Standard Model, Prog. Part. Nucl. Phys. 71 (2013) 75–92. [arXiv:1303.4097](#), [doi:10.1016/j.pnpnp.2013.03.006](#).
- [616] L. Calibbi, G. Signorelli, Charged Lepton Flavour Violation: An Experimental and Theoretical Introduction, Riv. Nuovo Cim. 41 (2) (2018) 71–174. [arXiv:1709.00294](#), [doi:10.1393/ncr/i2018-10144-0](#).
- [617] A. Ilakovac, A. Pilaftsis, Flavor violating charged lepton decays in seesaw-type models, Nucl. Phys. B437 (1995) 491. [arXiv:hep-ph/9403398](#), [doi:10.1016/0550-3213\(94\)00567-X](#).
- [618] R. Alonso, M. Dhen, M. B. Gavela, T. Hambye, Muon conversion to electron in nuclei in type-I seesaw models, JHEP 01 (2013) 118. [arXiv:1209.2679](#), [doi:10.1007/JHEP01\(2013\)118](#).
- [619] M. Lindner, M. Platscher, F. S. Queiroz, A Call for New Physics : The Muon Anomalous Magnetic Moment and Lepton Flavor Violation, Phys. Rept. 731 (2018) 1–82. [arXiv:1610.06587](#), [doi:10.1016/j.physrep.2017.12.001](#).
- [620] F. F. Deppisch, A. Pilaftsis, Lepton Flavour Violation and  $\theta_{13}$  in Minimal Resonant Leptogenesis, Phys. Rev. D83 (2011) 076007. [arXiv:1012.1834](#), [doi:10.1103/PhysRevD.83.076007](#).
- [621] A. Ibarra, E. Molinaro, S. T. Petcov, Low Energy Signatures of the TeV Scale See-Saw Mechanism, Phys. Rev. D84 (2011) 013005. [arXiv:1103.6217](#), [doi:10.1103/PhysRevD.84.013005](#).
- [622] F. Borzumati, A. Masiero, Large Muon and electron Number Violations in Supergravity Theories, Phys. Rev. Lett. 57 (1986) 961. [doi:10.1103/PhysRevLett.57.961](#).
- [623] J. Hisano, T. Moroi, K. Tobe, M. Yamaguchi, T. Yanagida, Lepton flavor violation in the supersymmetric standard model with seesaw induced neutrino masses, Phys. Lett. B357 (1995) 579–587. [arXiv:hep-ph/9501407](#), [doi:10.1016/0370-2693\(95\)00954-J](#).
- [624] J. Hisano, T. Moroi, K. Tobe, M. Yamaguchi, Lepton flavor violation via right-handed neutrino Yukawa couplings in supersymmetric standard model, Phys. Rev. D53 (1996) 2442–2459. [arXiv:hep-ph/9510309](#), [doi:10.1103/PhysRevD.53.2442](#).
- [625] N. Arkani-Hamed, H.-C. Cheng, J. L. Feng, L. J. Hall, Probing lepton flavor violation at future colliders, Phys. Rev. Lett. 77 (1996) 1937–1940. [arXiv:hep-ph/9603431](#), [doi:10.1103/PhysRevLett.77.1937](#).

- [626] J. L. Feng, Y. Nir, Y. Shadmi, Neutrino parameters, Abelian flavor symmetries, and charged lepton flavor violation, *Phys. Rev. D* 61 (2000) 113005. [arXiv:hep-ph/9911370](#), [doi:10.1103/PhysRevD.61.113005](#).
- [627] J. Hisano, K. Tobe, Neutrino masses, muon  $g-2$ , and lepton flavor violation in the supersymmetric seesaw model, *Phys. Lett. B* 510 (2001) 197–204. [arXiv:hep-ph/0102315](#), [doi:10.1016/S0370-2693\(01\)00494-4](#).
- [628] J. R. Ellis, J. Hisano, M. Raidal, Y. Shimizu, A New parametrization of the seesaw mechanism and applications in supersymmetric models, *Phys. Rev. D* 66 (2002) 115013. [arXiv:hep-ph/0206110](#), [doi:10.1103/PhysRevD.66.115013](#).
- [629] S. Pascoli, S. T. Petcov, W. Rodejohann, On the connection of leptogenesis with low-energy CP violation and LFV charged lepton decays, *Phys. Rev. D* 68 (2003) 093007. [arXiv:hep-ph/0302054](#), [doi:10.1103/PhysRevD.68.093007](#).
- [630] Z.-z. Xing, S. Zhou, Seesaw invariance of Fritzsch-like neutrino mass matrices, leptogenesis and lepton flavor violation, *Phys. Lett. B* 606 (2005) 145–156. [arXiv:hep-ph/0411044](#), [doi:10.1016/j.physletb.2004.11.066](#).
- [631] S. Antusch, E. Arganda, M. J. Herrero, A. M. Teixeira, Impact of  $\theta_{13}$  on lepton flavour violating processes within SUSY seesaw, *JHEP* 11 (2006) 090. [arXiv:hep-ph/0607263](#), [doi:10.1088/1126-6708/2006/11/090](#).
- [632] J. Barry, W. Rodejohann, Lepton number and flavour violation in TeV-scale left-right symmetric theories with large left-right mixing, *JHEP* 09 (2013) 153. [arXiv:1303.6324](#), [doi:10.1007/JHEP09\(2013\)153](#).
- [633] J. Herrero-Garca, T. Ohlsson, S. Riad, J. Wirth, Full parameter scan of the Zee model: exploring Higgs lepton flavor violation, *JHEP* 04 (2017) 130. [arXiv:1701.05345](#), [doi:10.1007/JHEP04\(2017\)130](#).
- [634] W. C. Haxton, G. J. Stephenson, Double beta Decay, *Prog. Part. Nucl. Phys.* 12 (1984) 409–479. [doi:10.1016/0146-6410\(84\)90006-1](#).
- [635] F. T. Avignone, III, S. R. Elliott, J. Engel, Double Beta Decay, Majorana Neutrinos, and Neutrino Mass, *Rev. Mod. Phys.* 80 (2008) 481–516. [arXiv:0708.1033](#), [doi:10.1103/RevModPhys.80.481](#).
- [636] M. Blennow, E. Fernandez-Martinez, J. Lopez-Pavon, J. Menendez, Neutrinoless double beta decay in seesaw models, *JHEP* 07 (2010) 096. [arXiv:1005.3240](#), [doi:10.1007/JHEP07\(2010\)096](#).
- [637] P. Bode, J. P. Ostriker, N. Turok, Halo formation in warm dark matter models, *Astrophys. J.* 556 (2001) 93–107. [arXiv:astro-ph/0010389](#), [doi:10.1086/321541](#).
- [638] S. Tremaine, J. E. Gunn, Dynamical Role of Light Neutral Leptons in Cosmology, *Phys. Rev. Lett.* 42 (1979) 407–410. [doi:10.1103/PhysRevLett.42.407](#).
- [639] A. D. Dolgov, S. H. Hansen, Massive sterile neutrinos as warm dark matter, *Astropart. Phys.* 16 (2002) 339–344. [arXiv:hep-ph/0009083](#), [doi:10.1016/S0927-6505\(01\)00115-3](#).
- [640] X.-D. Shi, G. M. Fuller, A New dark matter candidate: Nonthermal sterile neutrinos, *Phys. Rev. Lett.* 82 (1999) 2832–2835. [arXiv:astro-ph/9810076](#), [doi:10.1103/PhysRevLett.82.2832](#).
- [641] M. Laine, M. Shaposhnikov, Sterile neutrino dark matter as a consequence of  $\nu$ MSM-induced lepton asymmetry, *JCAP* 0806 (2008) 031. [arXiv:0804.4543](#), [doi:10.1088/1475-7516/2008/06/031](#).
- [642] A. Boyarsky, J. Lesgourgues, O. Ruchayskiy, M. Viel, Realistic sterile neutrino dark matter with keV mass does not contradict cosmological bounds, *Phys. Rev. Lett.* 102 (2009) 201304. [arXiv:0812.3256](#), [doi:10.1103/PhysRevLett.102.201304](#).
- [643] M. Drewes, et al., A White Paper on keV Sterile Neutrino Dark Matter, *JCAP* 1701 (01) (2017) 025. [arXiv:1602.04816](#), [doi:10.1088/1475-7516/2017/01/025](#).
- [644] A. Kusenko, G. Segre, Neutral current induced neutrino oscillations in a supernova, *Phys. Lett. B* 396 (1997) 197–200. [arXiv:hep-ph/9701311](#), [doi:10.1016/S0370-2693\(97\)00121-4](#).
- [645] G. M. Fuller, A. Kusenko, I. Mocioiu, S. Pascoli, Pulsar kicks from a dark-matter sterile neutrino, *Phys. Rev. D* 68 (2003) 103002. [arXiv:astro-ph/0307267](#), [doi:10.1103/PhysRevD.68.103002](#).
- [646] K. Abazajian, S. M. Koushiappas, Constraints on Sterile Neutrino Dark Matter, *Phys. Rev. D* 74 (2006) 023527. [arXiv:astro-ph/0605271](#), [doi:10.1103/PhysRevD.74.023527](#).
- [647] M. Loewenstein, A. Kusenko, P. L. Biermann, New Limits on Sterile Neutrinos from Suzaku Observations of the Ursa Minor Dwarf Spheroidal Galaxy, *Astrophys. J.* 700 (2009) 426–435. [arXiv:0812.2710](#), [doi:10.1088/0004-637X/700/1/426](#).

- [648] P. B. Pal, L. Wolfenstein, Radiative Decays of Massive Neutrinos, *Phys. Rev. D* 25 (1982) 766. doi:10.1103/PhysRevD.25.766.
- [649] R. E. Shrock, Electromagnetic Properties and Decays of Dirac and Majorana Neutrinos in a General Class of Gauge Theories, *Nucl. Phys. B* 206 (1982) 359–379. doi:10.1016/0550-3213(82)90273-5.
- [650] B. M. Roach, K. C. Y. Ng, K. Perez, J. F. Beacom, S. Horiuchi, R. Krivonos, D. R. Wik, NuSTAR Tests of Sterile-Neutrino Dark Matter: New Galactic Bulge Observations and Combined Impact [arXiv:1908.09037](https://arxiv.org/abs/1908.09037).
- [651] E. Bulbul, M. Markevitch, A. Foster, R. K. Smith, M. Loewenstein, S. W. Randall, Detection of An Unidentified Emission Line in the Stacked X-ray spectrum of Galaxy Clusters, *Astrophys. J.* 789 (2014) 13. [arXiv:1402.2301](https://arxiv.org/abs/1402.2301), doi:10.1088/0004-637X/789/1/13.
- [652] A. Boyarsky, O. Ruchayskiy, D. Iakubovskiy, J. Franse, Unidentified Line in X-Ray Spectra of the Andromeda Galaxy and Perseus Galaxy Cluster, *Phys. Rev. Lett.* 113 (2014) 251301. [arXiv:1402.4119](https://arxiv.org/abs/1402.4119), doi:10.1103/PhysRevLett.113.251301.
- [653] O. Urban, N. Werner, S. W. Allen, A. Simionescu, J. S. Kaastra, L. E. Strigari, A Suzaku Search for Dark Matter Emission Lines in the X-ray Brightest Galaxy Clusters, *Mon. Not. Roy. Astron. Soc.* 451 (3) (2015) 2447–2461. [arXiv:1411.0050](https://arxiv.org/abs/1411.0050), doi:10.1093/mnras/stv1142.
- [654] T. E. Jeltema, S. Profumo, Discovery of a 3.5 keV line in the Galactic Centre and a critical look at the origin of the line across astronomical targets, *Mon. Not. Roy. Astron. Soc.* 450 (2) (2015) 2143–2152. [arXiv:1408.1699](https://arxiv.org/abs/1408.1699), doi:10.1093/mnras/stv768.
- [655] M. Drewes, The Phenomenology of Right Handed Neutrinos, *Int. J. Mod. Phys. E* 22 (2013) 1330019. [arXiv:1303.6912](https://arxiv.org/abs/1303.6912), doi:10.1142/S0218301313300191.
- [656] T. Asaka, S. Blanchet, M. Shaposhnikov, The  $\nu$ MSM, dark matter and neutrino masses, *Phys. Lett. B* 631 (2005) 151–156. [arXiv:hep-ph/0503065](https://arxiv.org/abs/hep-ph/0503065), doi:10.1016/j.physletb.2005.09.070.
- [657] A. Kusenko, F. Takahashi, T. T. Yanagida, Dark Matter from Split Seesaw, *Phys. Lett. B* 693 (2010) 144–148. [arXiv:1006.1731](https://arxiv.org/abs/1006.1731), doi:10.1016/j.physletb.2010.08.031.
- [658] S. Weinberg, Universal Neutrino Degeneracy, *Phys. Rev.* 128 (1962) 1457–1473. doi:10.1103/PhysRev.128.1457.
- [659] Y. F. Li, Z.-Z. Xing, Captures of Hot and Warm Sterile Antineutrino Dark Matter on EC-decaying Ho-163 Nuclei, *JCAP* 1108 (2011) 006. [arXiv:1104.4000](https://arxiv.org/abs/1104.4000), doi:10.1088/1475-7516/2011/08/006.
- [660] J. m. Irvine, R. Humphreys, Neutrino Masses And The Cosmic Neutrino Background, *J. Phys. G* 9 (1983) 847–852. doi:10.1088/0305-4616/9/7/017.
- [661] A. G. Cocco, G. Mangano, M. Messina, Probing low energy neutrino backgrounds with neutrino capture on beta decaying nuclei, *JCAP* 0706 (2007) 015. [arXiv:hep-ph/0703075](https://arxiv.org/abs/hep-ph/0703075), doi:10.1088/1475-7516/2007/06/015.
- [662] R. Lazauskas, P. Vogel, C. Volpe, Charged current cross section for massive cosmological neutrinos impinging on radioactive nuclei, *J. Phys. G* 35 (2008) 025001. [arXiv:0710.5312](https://arxiv.org/abs/0710.5312), doi:10.1088/0954-3899/35/2/025001.
- [663] M. Blennow, Prospects for cosmic neutrino detection in tritium experiments in the case of hierarchical neutrino masses, *Phys. Rev. D* 77 (2008) 113014. [arXiv:0803.3762](https://arxiv.org/abs/0803.3762), doi:10.1103/PhysRevD.77.113014.
- [664] Y. F. Li, Z.-z. Xing, S. Luo, Direct Detection of the Cosmic Neutrino Background Including Light Sterile Neutrinos, *Phys. Lett. B* 692 (2010) 261–267. [arXiv:1007.0914](https://arxiv.org/abs/1007.0914), doi:10.1016/j.physletb.2010.07.055.
- [665] M. Kamionkowski, A. Kinkhabwala, Galactic halo models and particle dark matter detection, *Phys. Rev. D* 57 (1998) 3256–3263. [arXiv:hep-ph/9710337](https://arxiv.org/abs/hep-ph/9710337), doi:10.1103/PhysRevD.57.3256.
- [666] W. Liao, keV scale  $\nu_R$  dark matter and its detection in  $\beta$  decay experiment, *Phys. Rev. D* 82 (2010) 073001. [arXiv:1005.3351](https://arxiv.org/abs/1005.3351), doi:10.1103/PhysRevD.82.073001.
- [667] E. W. Otten, C. Weinheimer, Neutrino mass limit from tritium beta decay, *Rept. Prog. Phys.* 71 (2008) 086201. [arXiv:0909.2104](https://arxiv.org/abs/0909.2104), doi:10.1088/0034-4885/71/8/086201.
- [668] W. Liao, X.-H. Wu, H. Zhou, Electron events from the scattering with solar neutrinos in the search of keV scale sterile neutrino dark matter, *Phys. Rev. D* 89 (9) (2014) 093017. [arXiv:1311.6075](https://arxiv.org/abs/1311.6075), doi:10.1103/PhysRevD.89.093017.
- [669] S. Mertens, T. Lasserre, S. Groh, G. Drexlin, F. Glueck, A. Huber, A. W. P. Poon, M. Steidl, N. Steinbrink,

- C. Weinheimer, Sensitivity of Next-Generation Tritium Beta-Decay Experiments for keV-Scale Sterile Neutrinos, JCAP 1502 (02) (2015) 020. [arXiv:1409.0920](#), [doi:10.1088/1475-7516/2015/02/020](#).
- [670] S. Mertens, et al., A novel detector system for KATRIN to search for keV-scale sterile neutrinos, J. Phys. G46 (6) (2019) 065203. [arXiv:1810.06711](#), [doi:10.1088/1361-6471/ab12fe](#).
- [671] S. Bser, C. Buck, C. Giunti, J. Lesgourgues, L. Ludhova, S. Mertens, A. Schukraft, M. Wurm, Status of Light Sterile Neutrino Searches [arXiv:1906.01739](#).
- [672] C. Athanassopoulos, et al., Candidate events in a search for  $\bar{\nu}_\mu \rightarrow \bar{\nu}_e$  oscillations, Phys. Rev. Lett. 75 (1995) 2650–2653. [arXiv:nucl-ex/9504002](#), [doi:10.1103/PhysRevLett.75.2650](#).
- [673] J. E. Hill, Results from the LSND neutrino oscillation search for  $\bar{\nu}_\mu \rightarrow \bar{\nu}_e$ , Phys. Rev. Lett. 75 (1995) 2654–2657. [arXiv:hep-ex/9504009](#), [doi:10.1103/PhysRevLett.75.2654](#).
- [674] A. Aguilar-Arevalo, et al., Evidence for neutrino oscillations from the observation of  $\bar{\nu}_e$  appearance in a  $\bar{\nu}_\mu$  beam, Phys. Rev. D64 (2001) 112007. [arXiv:hep-ex/0104049](#), [doi:10.1103/PhysRevD.64.112007](#).
- [675] A. A. Aguilar-Arevalo, et al., Significant Excess of Electron Like Events in the MiniBooNE Short-Baseline Neutrino Experiment, Phys. Rev. Lett. 121 (22) (2018) 221801. [arXiv:1805.12028](#), [doi:10.1103/PhysRevLett.121.221801](#).
- [676] A. Bazarko, MiniBooNE: Status of the booster neutrino experiment, Nucl. Phys. Proc. Suppl. 91 (2001) 210–215. [arXiv:hep-ex/0009056](#), [doi:10.1016/S0920-5632\(00\)00943-9](#).
- [677] A. A. Aguilar-Arevalo, et al., A Search for Electron Neutrino Appearance at the  $\Delta m^2 \sim 1 \text{ eV}^2$  Scale, Phys. Rev. Lett. 98 (2007) 231801. [arXiv:0704.1500](#), [doi:10.1103/PhysRevLett.98.231801](#).
- [678] A. A. Aguilar-Arevalo, et al., Event Excess in the MiniBooNE Search for  $\bar{\nu}_\mu \rightarrow \bar{\nu}_e$  Oscillations, Phys. Rev. Lett. 105 (2010) 181801. [arXiv:1007.1150](#), [doi:10.1103/PhysRevLett.105.181801](#).
- [679] A. A. Aguilar-Arevalo, et al., Improved Search for  $\bar{\nu}_\mu \rightarrow \bar{\nu}_e$  Oscillations in the MiniBooNE Experiment, Phys. Rev. Lett. 110 (2013) 161801. [arXiv:1303.2588](#), [doi:10.1103/PhysRevLett.110.161801](#).
- [680] W. Hampel, et al., GALLEX solar neutrino observations: Results for GALLEX IV, Phys. Lett. B447 (1999) 127–133. [doi:10.1016/S0370-2693\(98\)01579-2](#).
- [681] J. N. Abdurashitov, et al., Measurement of the solar neutrino capture rate with gallium metal, Phys. Rev. C60 (1999) 055801. [arXiv:astro-ph/9907113](#), [doi:10.1103/PhysRevC.60.055801](#).
- [682] C. Giunti, M. Laveder, Statistical Significance of the Gallium Anomaly, Phys. Rev. C83 (2011) 065504. [arXiv:1006.3244](#), [doi:10.1103/PhysRevC.83.065504](#).
- [683] D. Frekers, et al., The Ga-71(He-3, t) reaction and the low-energy neutrino response, Phys. Lett. B706 (2011) 134–138. [doi:10.1016/j.physletb.2011.10.061](#).
- [684] J. Kostensalo, J. Suhonen, C. Giunti, P. C. Srivastava, The gallium anomaly revisited, Phys. Lett. B795 (2019) 542–547. [arXiv:1906.10980](#), [doi:10.1016/j.physletb.2019.06.057](#).
- [685] G. Mention, M. Fechner, T. Lasserre, T. A. Mueller, D. Lhuillier, M. Cribier, A. Letourneau, The Reactor Antineutrino Anomaly, Phys. Rev. D83 (2011) 073006. [arXiv:1101.2755](#), [doi:10.1103/PhysRevD.83.073006](#).
- [686] T. A. Mueller, et al., Improved Predictions of Reactor Antineutrino Spectra, Phys. Rev. C83 (2011) 054615. [arXiv:1101.2663](#), [doi:10.1103/PhysRevC.83.054615](#).
- [687] P. Huber, On the determination of anti-neutrino spectra from nuclear reactors, Phys. Rev. C84 (2011) 024617, [Erratum: Phys. Rev. C85, 029901 (2012)]. [arXiv:1106.0687](#), [doi:10.1103/PhysRevC.85.029901](#), [doi:10.1103/PhysRevC.84.024617](#).
- [688] K. Schreckenbach, G. Colvin, W. Gelletly, F. Von Feilitzsch, Determination of the Antineutrino Spectrum from U-235 Thermal Neutron Fission Products up to 9.5 MeV, Phys. Lett. 160B (1985) 325–330. [doi:10.1016/0370-2693\(85\)91337-1](#).
- [689] A. A. Hahn, K. Schreckenbach, G. Colvin, B. Krusche, W. Gelletly, F. Von Feilitzsch, Anti-neutrino Spectra From  $^{241}\text{Pu}$  and  $^{239}\text{Pu}$  Thermal Neutron Fission Products, Phys. Lett. B218 (1989) 365–368. [doi:10.1016/0370-2693\(89\)91598-0](#).
- [690] F. P. An, et al., Evolution of the Reactor Antineutrino Flux and Spectrum at Daya Bay, Phys. Rev. Lett. 118 (25) (2017) 251801. [arXiv:1704.01082](#), [doi:10.1103/PhysRevLett.118.251801](#).
- [691] C. Giunti, X. P. Ji, M. Laveder, Y. F. Li, B. R. Littlejohn, Reactor Fuel Fraction Information on the Antineutrino Anomaly, JHEP 10 (2017) 143. [arXiv:1708.01133](#), [doi:10.1007/JHEP10\(2017\)143](#).

- [692] C. Giunti, Y. F. Li, B. R. Littlejohn, P. T. Surukuchi, Diagnosing the Reactor Antineutrino Anomaly with Global Antineutrino Flux Data, *Phys. Rev. D* 99 (7) (2019) 073005. [arXiv:1901.01807](#), [doi:10.1103/PhysRevD.99.073005](#).
- [693] Y. Abe, et al., Improved measurements of the neutrino mixing angle  $\theta_{13}$  with the Double Chooz detector, *JHEP* 10 (2014) 086, [Erratum: *JHEP* 02, 074 (2015)]. [arXiv:1406.7763](#), [doi:10.1007/JHEP02\(2015\)074](#), [10.1007/JHEP10\(2014\)086](#).
- [694] F. P. An, et al., Measurement of the Reactor Antineutrino Flux and Spectrum at Daya Bay, *Phys. Rev. Lett.* 116 (6) (2016) 061801, [Erratum: *Phys. Rev. Lett.* 118, no.9, 099902 (2017)]. [arXiv:1508.04233](#), [doi:10.1103/PhysRevLett.116.061801](#), [10.1103/PhysRevLett.118.099902](#).
- [695] J. H. Choi, et al., Observation of Energy and Baseline Dependent Reactor Antineutrino Disappearance in the RENO Experiment, *Phys. Rev. Lett.* 116 (21) (2016) 211801. [arXiv:1511.05849](#), [doi:10.1103/PhysRevLett.116.211801](#).
- [696] S. K. Kang, Roles of sterile neutrinos in particle physics and cosmology, *Int. J. Mod. Phys. A* 34 (10) (2019) 1930005. [arXiv:1904.07108](#), [doi:10.1142/S0217751X19300059](#).
- [697] P. Huber, NEOS Data and the Origin of the 5 MeV Bump in the Reactor Antineutrino Spectrum, *Phys. Rev. Lett.* 118 (4) (2017) 042502. [arXiv:1609.03910](#), [doi:10.1103/PhysRevLett.118.042502](#).
- [698] J. M. Berryman, V. Brdar, P. Huber, Particle physics origin of the 5 MeV bump in the reactor antineutrino spectrum?, *Phys. Rev. D* 99 (5) (2019) 055045. [arXiv:1803.08506](#), [doi:10.1103/PhysRevD.99.055045](#).
- [699] Y.-F. Li, D. Zhang, New Realization of the Conversion Calculation for Reactor Antineutrino Fluxes, *Phys. Rev. D* 100 (5) (2019) 053005. [arXiv:1904.07791](#), [doi:10.1103/PhysRevD.100.053005](#).
- [700] Y. J. Ko, et al., Sterile Neutrino Search at the NEOS Experiment, *Phys. Rev. Lett.* 118 (12) (2017) 121802. [arXiv:1610.05134](#), [doi:10.1103/PhysRevLett.118.121802](#).
- [701] I. Alekseev, et al., Search for sterile neutrinos at the DANSS experiment, *Phys. Lett. B* 787 (2018) 56–63. [arXiv:1804.04046](#), [doi:10.1016/j.physletb.2018.10.038](#).
- [702] H. Almazn, et al., Sterile Neutrino Constraints from the STEREO Experiment with 66 Days of Reactor-On Data, *Phys. Rev. Lett.* 121 (16) (2018) 161801. [arXiv:1806.02096](#), [doi:10.1103/PhysRevLett.121.161801](#).
- [703] J. Ashenfelter, et al., Measurement of the Antineutrino Spectrum from  $^{235}\text{U}$  Fission at HFIR with PROSPECT, *Phys. Rev. Lett.* 122 (25) (2019) 251801. [arXiv:1812.10877](#), [doi:10.1103/PhysRevLett.122.251801](#).
- [704] A. P. Serebrov, et al., First Observation of the Oscillation Effect in the Neutrino-4 Experiment on the Search for the Sterile Neutrino, *Pisma Zh. Eksp. Teor. Fiz.* 109 (4) (2019) 209–218, [*JETP Lett.* 109, no. 4, 213 (2019)]. [arXiv:1809.10561](#), [doi:10.1134/S0021364019040040](#).
- [705] Y. Abreu, et al., Performance of a full scale prototype detector at the BR2 reactor for the SoLid experiment, *JINST* 13 (05) (2018) P05005. [arXiv:1802.02884](#), [doi:10.1088/1748-0221/13/05/P05005](#).
- [706] M. Dentler, I. Hernández-Cabezudo, J. Kopp, P. A. N. Machado, M. Maltoni, I. Martínez-Soler, T. Schwetz, Updated Global Analysis of Neutrino Oscillations in the Presence of eV-Scale Sterile Neutrinos, *JHEP* 08 (2018) 010. [arXiv:1803.10661](#), [doi:10.1007/JHEP08\(2018\)010](#).
- [707] S. Zhou, Symmetric formulation of neutrino oscillations in matter and its intrinsic connection to renormalization-group equations, *J. Phys. G* 44 (4) (2017) 044006. [arXiv:1612.03537](#), [doi:10.1088/1361-6471/aa5fd9](#).
- [708] P. Adamson, et al., Limits on Active to Sterile Neutrino Oscillations from Disappearance Searches in the MINOS, Daya Bay, and Bugey-3 Experiments, *Phys. Rev. Lett.* 117 (15) (2016) 151801, [Addendum: *Phys. Rev. Lett.* 117, no.20, 209901 (2016)]. [arXiv:1607.01177](#), [doi:10.1103/PhysRevLett.117.151801](#), [10.1103/PhysRevLett.117.209901](#).
- [709] Y.-F. Li, S. Luo, Neutrino Oscillation Probabilities in Matter with Direct and Indirect Unitarity Violation in the Lepton Mixing Matrix, *Phys. Rev. D* 93 (3) (2016) 033008. [arXiv:1508.00052](#), [doi:10.1103/PhysRevD.93.033008](#).
- [710] J. Tang, Y. Zhang, Y.-F. Li, Probing Direct and Indirect Unitarity Violation in Future Accelerator Neutrino Facilities, *Phys. Lett. B* 774 (2017) 217–224. [arXiv:1708.04909](#), [doi:10.1016/j.physletb.2017.09.055](#).
- [711] Y. F. Li, S.-s. Liu, Vanishing effective mass of the neutrinoless double beta decay including light sterile

- neutrinos, Phys. Lett. B706 (2012) 406–411. [arXiv:1110.5795](#), [doi:10.1016/j.physletb.2011.11.054](#).
- [712] J.-H. Liu, S. Zhou, Another look at the impact of an eV-mass sterile neutrino on the effective neutrino mass of neutrinoless double-beta decays, Int. J. Mod. Phys. A33 (02) (2018) 1850014. [arXiv:1710.10359](#), [doi:10.1142/S0217751X18500148](#).
- [713] G.-Y. Huang, S. Zhou, Impact of an eV-mass sterile neutrino on the neutrinoless double-beta decays: A Bayesian analysis, Nucl. Phys. B945 (2019) 114691. [arXiv:1902.03839](#), [doi:10.1016/j.nuclphysb.2019.114691](#).
- [714] F. Wilczek, Origins of Mass, Central Eur. J. Phys. 10 (2012) 1021–1037. [arXiv:1206.7114](#), [doi:10.2478/s11534-012-0121-0](#).
- [715] W. G. Hollik, U. J. Saldana Salazar, The double mass hierarchy pattern: simultaneously understanding quark and lepton mixing, Nucl. Phys. B892 (2015) 364–389. [arXiv:1411.3549](#), [doi:10.1016/j.nuclphysb.2015.01.019](#).
- [716] U. J. Saldana-Salazar, K. M. Tame-Narvaez, The mass ratios parametrization, Int. J. Mod. Phys. A34 (01) (2019) 1950007. [arXiv:1804.04578](#), [doi:10.1142/S0217751X19500076](#).
- [717] D.-s. Du, Z.-z. Xing, A Modified Fritzsche ansatz with additional first order perturbation, Phys. Rev. D48 (1993) 2349–2352. [doi:10.1103/PhysRevD.48.2349](#).
- [718] Z.-z. Xing, H. Zhang, Complete parameter space of quark mass matrices with four texture zeros, J. Phys. G30 (2004) 129–136. [arXiv:hep-ph/0309112](#), [doi:10.1088/0954-3899/30/2/011](#).
- [719] R. Jora, S. Nasri, J. Schechter, An Approach to permutation symmetry for the electroweak theory, Int. J. Mod. Phys. A21 (2006) 5875–5894. [arXiv:hep-ph/0605069](#), [doi:10.1142/S0217751X0603391X](#).
- [720] R. Jora, J. Schechter, M. Naeem Shahid, Perturbed S(3) neutrinos, Phys. Rev. D80 (2009) 093007, [Erratum: Phys. Rev. D82, 079902 (2010)]. [arXiv:0909.4414](#), [doi:10.1103/PhysRevD.80.093007](#), [10.1103/PhysRevD.82.079902](#).
- [721] Z.-z. Xing, D. Yang, S. Zhou, Broken  $S_3$  Flavor Symmetry of Leptons and Quarks: Mass Spectra and Flavor Mixing Patterns, Phys. Lett. B690 (2010) 304–310. [arXiv:1004.4234](#), [doi:10.1016/j.physletb.2010.05.045](#).
- [722] Z.-Z. Xing, D. Zhang, Seesaw mirroring between light and heavy Majorana neutrinos with the help of the  $S_3$  reflection symmetry, JHEP 03 (2019) 184. [arXiv:1901.07912](#), [doi:10.1007/JHEP03\(2019\)184](#).
- [723] M. Tanimoto, Large mixing angle MSW solution in S(3) flavor symmetry, Phys. Lett. B483 (2000) 417–424. [arXiv:hep-ph/0001306](#), [doi:10.1016/S0370-2693\(00\)00550-5](#).
- [724] Z.-z. Xing, Democratic neutrino mixing and radiative corrections, Phys. Rev. D63 (2001) 057301. [arXiv:hep-ph/0011217](#), [doi:10.1103/PhysRevD.63.057301](#).
- [725] H. Fritzsche, Z.-z. Xing, Democratic neutrino mixing reexamined, Phys. Lett. B598 (2004) 237–242. [arXiv:hep-ph/0406206](#), [doi:10.1016/j.physletb.2004.07.061](#).
- [726] M. Fukugita, M. Tanimoto, T. Yanagida, Atmospheric neutrino oscillation and a phenomenological lepton mass matrix, Phys. Rev. D57 (1998) 4429–4432. [arXiv:hep-ph/9709388](#), [doi:10.1103/PhysRevD.57.4429](#).
- [727] H. Fritzsche, Z.-z. Xing, Maximal neutrino mixing and maximal CP violation, Phys. Rev. D61 (2000) 073016. [arXiv:hep-ph/9909304](#), [doi:10.1103/PhysRevD.61.073016](#).
- [728] G. C. Branco, J. I. Silva-Marcos, M. N. Rebelo, Universal strength for Yukawa couplings, Phys. Lett. B237 (1990) 446–450. [doi:10.1016/0370-2693\(90\)91204-0](#).
- [729] P. M. Fishbane, P. Kaus, Pure phase mass matrices, Phys. Rev. D49 (1994) 3612–3616. [doi:10.1103/PhysRevD.49.3612](#).
- [730] G. C. Branco, D. Emmanuel-Costa, J. I. Silva-Marcos, A New approach to the Yukawa puzzle, Phys. Rev. D56 (1997) 107–116. [arXiv:hep-ph/9608477](#), [doi:10.1103/PhysRevD.56.107](#).
- [731] G. C. Branco, M. N. Rebelo, J. I. Silva-Marcos, Quasidegenerate neutrino masses with universal strength Yukawa couplings, Phys. Lett. B428 (1998) 136–142. [arXiv:hep-ph/9802340](#), [doi:10.1016/S0370-2693\(98\)00388-8](#).
- [732] C.-E. Lee, C.-L. Lin, Y.-W. Yang, Weak mixing matrix under permutation symmetry breaking, Phys. Rev. D42 (1990) 2355–2358. [doi:10.1103/PhysRevD.42.2355](#).

- [733] H. Fritzsch, Z.-z. Xing, D. Zhang, The breaking of flavor democracy in the quark sector, *Chin. Phys.* C41 (9) (2017) 093104. [arXiv:1705.01391](#), [doi:10.1088/1674-1137/41/9/093104](#).
- [734] U. J. Saldana-Salazar, The flavor-blind principle: A symmetrical approach to the Gatto-Sartori-Tonin relation, *Phys. Rev. D*93 (1) (2016) 013002. [arXiv:1509.08877](#), [doi:10.1103/PhysRevD.93.013002](#).
- [735] F. Gonzalez Canales, A. Mondragn, M. Mondragn, U. J. Saldana Salazar, L. Velasco-Sevilla, Quark sector of S3 models: classification and comparison with experimental data, *Phys. Rev. D*88 (2013) 096004. [arXiv:1304.6644](#), [doi:10.1103/PhysRevD.88.096004](#).
- [736] R. Friedberg, T. D. Lee, A Possible Relation between the Neutrino Mass Matrix and the Neutrino Mapping Matrix, *HEPMP* 30 (2006) 591–598. [arXiv:hep-ph/0606071](#).
- [737] R. Friedberg, T. D. Lee, Hidden symmetry of the CKM and neutrino mapping matrices, *Annals Phys.* 323 (2008) 1087–1105. [arXiv:0705.4156](#), [doi:10.1016/j.aop.2007.06.004](#).
- [738] R. Friedberg, T. D. Lee, Jarlskog invariant of the neutrino mapping matrix, *Annals Phys.* 323 (2008) 1677–1691. [arXiv:0709.1526](#), [doi:10.1016/j.aop.2007.11.001](#).
- [739] T. D. Lee, Symmetry and asymmetry, *Nucl. Phys.* A805 (2008) 54–71. [doi:10.1016/j.nuclphysa.2008.02.272](#).
- [740] R. Friedberg, T. D. Lee, Model with Strong  $\gamma(4)$  T-violation, *Chin. Phys.* C32 (2008) 939. [arXiv:0810.3373](#), [doi:10.1088/1674-1137/32/12/001](#).
- [741] R. Friedberg, T. D. Lee, A Timeon Model of Quark and Lepton Mass Matrices, *Annals Phys.* 324 (2009) 2196–2225. [arXiv:0904.1640](#), [doi:10.1016/j.aop.2009.05.009](#).
- [742] R. Friedberg, T. D. Lee, Deviations of the Lepton Mapping Matrix from the Harrison-Perkins-Scott Form, *Chin. Phys.* C34 (2010) 1547–1555, [Erratum: *Chin. Phys.* C34, 1905 (2010)]. [arXiv:1008.0453](#), [doi:10.1088/1674-1137/34/12/022](#), [doi:10.1088/1674-1137/34/10/001](#).
- [743] Z.-z. Xing, H. Zhang, S. Zhou, Nearly Tri-bimaximal Neutrino Mixing and CP Violation from  $\mu$ - $\tau$  Symmetry Breaking, *Phys. Lett.* B641 (2006) 189–197. [arXiv:hep-ph/0607091](#), [doi:10.1016/j.physletb.2006.08.045](#).
- [744] S. Luo, Z.-z. Xing, Friedberg-Lee Symmetry Breaking and Its Prediction for  $\theta_{13}$ , *Phys. Lett.* B646 (2007) 242–247. [arXiv:hep-ph/0611360](#), [doi:10.1016/j.physletb.2007.01.040](#).
- [745] Z.-z. Xing, Neutrino Mixing: From the Broken  $\mu$ - $\tau$  Symmetry to the Broken Friedberg-Lee Symmetry, *Int. J. Mod. Phys.* E16 (2007) 1361–1372. [arXiv:hep-ph/0703007](#), [doi:10.1142/S0218301307006721](#).
- [746] W. Chao, S. Luo, Z.-z. Xing, Neutrino mixing and leptogenesis in type-II seesaw scenarios with left-right symmetry, *Phys. Lett.* B659 (2008) 281–289. [arXiv:0704.3838](#), [doi:10.1016/j.physletb.2007.11.028](#).
- [747] C. Jarlskog, Neutrino sector with Majorana mass terms and Friedberg-Lee symmetry, *Phys. Rev. D*77 (2008) 073002. [arXiv:0712.0903](#), [doi:10.1103/PhysRevD.77.073002](#).
- [748] S. Luo, Z.-z. Xing, X. Li, Generic Friedberg-Lee Symmetry of Dirac Neutrinos, *Phys. Rev. D*78 (2008) 117301. [arXiv:0809.0781](#), [doi:10.1103/PhysRevD.78.117301](#).
- [749] C.-S. Huang, T.-j. Li, W. Liao, S.-H. Zhu, Generalization of Friedberg-Lee Symmetry, *Phys. Rev. D*78 (2008) 013005. [arXiv:0803.4124](#), [doi:10.1103/PhysRevD.78.013005](#).
- [750] T. Araki, R. Takahashi, Tri-Bimaximal Mixing from Twisted Friedberg-Lee Symmetry, *Eur. Phys. J.* C63 (2009) 521–526. [arXiv:0811.0905](#), [doi:10.1140/epjc/s10052-009-1124-x](#).
- [751] X.-G. He, W. Liao, The Friedberg-Lee Symmetry and Minimal Seesaw Model, *Phys. Lett.* B681 (2009) 253–256. [arXiv:0909.1463](#), [doi:10.1016/j.physletb.2009.10.010](#).
- [752] T. Araki, C. Q. Geng, Leptogenesis in model with Friedberg-Lee symmetry, *Phys. Lett.* B680 (2009) 343–350. [arXiv:0906.1903](#), [doi:10.1016/j.physletb.2009.09.015](#).
- [753] Z.-h. Zhao, Modified Friedberg-Lee symmetry for neutrino mixing, *Phys. Rev. D*92 (11) (2015) 113001. [arXiv:1509.06915](#), [doi:10.1103/PhysRevD.92.113001](#).
- [754] T. Araki, C. Q. Geng, Constrains on Timeon Model, *Phys. Rev. D*79 (2009) 077301. [arXiv:0901.4820](#), [doi:10.1103/PhysRevD.79.077301](#).
- [755] S. Bar-Shalom, D. Oaknin, A. Soni, Extended Friedberg Lee hidden symmetries, quark masses and CP-violation with four generations, *Phys. Rev. D*80 (2009) 015011. [arXiv:0904.1341](#), [doi:10.1103/PhysRevD.80.015011](#).

- [756] T. Araki, C. Q. Geng, Quark Masses and Mixings with Hierarchical Friedberg-Lee Symmetry, *Phys. Rev. D* 81 (2010) 076009. [arXiv:1001.3759](#), [doi:10.1103/PhysRevD.81.076009](#).
- [757] C. Jarlskog, A Model for Neutrino Masses, in: Fourth NO-VE International Workshop on Neutrino Oscillations in Venice : Ten years after the neutrino oscillations!! : Venezia, April 15-18, 2008, 2008, Istituto Veneto di Scienze, Lettere ed Arti, Campo Santo Stefano, 2008, pp. 45–61. [arXiv:0806.2206](#).
- [758] H. Georgi, D. V. Nanopoulos, Ordinary Predictions from Grand Principles: T Quark Mass in O(10), *Nucl. Phys. B* 155 (1979) 52–74. [doi:10.1016/0550-3213\(79\)90355-9](#).
- [759] G. C. Branco, L. Lavoura, F. Mota, Nearest Neighbor Interactions and the Physical Content of Fritzsche Mass Matrices, *Phys. Rev. D* 39 (1989) 3443. [doi:10.1103/PhysRevD.39.3443](#).
- [760] K. S. Babu, J. Kubo, Dihedral families of quarks, leptons and Higgses, *Phys. Rev. D* 71 (2005) 056006. [arXiv:hep-ph/0411226](#), [doi:10.1103/PhysRevD.71.056006](#).
- [761] W. Grimus, A. S. Joshipura, L. Lavoura, M. Tanimoto, Symmetry realization of texture zeros, *Eur. Phys. J. C* 36 (2004) 227–232. [arXiv:hep-ph/0405016](#), [doi:10.1140/epjc/s2004-01896-y](#).
- [762] W. Rodejohann, U. Saldana-Salazar, Multi-Higgs-Doublet Models and Singular Alignment, *JHEP* 07 (2019) 036. [arXiv:1903.00983](#), [doi:10.1007/JHEP07\(2019\)036](#).
- [763] C. D. Froggatt, H. B. Nielsen, Statistical Analysis of Quark and Lepton Masses, *Nucl. Phys. B* 164 (1980) 114–140. [doi:10.1016/0550-3213\(80\)90504-0](#).
- [764] L. J. Hall, H. Murayama, N. Weiner, Neutrino mass anarchy, *Phys. Rev. Lett.* 84 (2000) 2572–2575. [arXiv:hep-ph/9911341](#), [doi:10.1103/PhysRevLett.84.2572](#).
- [765] N. Haba, H. Murayama, Anarchy and hierarchy, *Phys. Rev. D* 63 (2001) 053010. [arXiv:hep-ph/0009174](#), [doi:10.1103/PhysRevD.63.053010](#).
- [766] M. Hirsch, S. F. King, Discriminating neutrino seesaw models, *Phys. Lett. B* 516 (2001) 103–110. [arXiv:hep-ph/0102103](#), [doi:10.1016/S0370-2693\(01\)00912-1](#).
- [767] F. Vissani, Expected properties of massive neutrinos for mass matrices with a dominant block and random coefficients order unity, *Phys. Lett. B* 508 (2001) 79–84. [arXiv:hep-ph/0102236](#), [doi:10.1016/S0370-2693\(01\)00485-3](#).
- [768] R. Rosenfeld, J. L. Rosner, Hierarchy and anarchy in quark mass matrices, or can hierarchy tolerate anarchy?, *Phys. Lett. B* 516 (2001) 408–414. [arXiv:hep-ph/0106335](#), [doi:10.1016/S0370-2693\(01\)00948-0](#).
- [769] L. J. Hall, M. P. Salem, T. Watari, Quark and Lepton Masses from Gaussian Landscapes, *Phys. Rev. Lett.* 100 (2008) 141801. [arXiv:0707.3444](#), [doi:10.1103/PhysRevLett.100.141801](#).
- [770] W. A. Ponce, R. H. Benavides, Texture Zeros for the Standard Model Quark Mass Matrices, *Eur. Phys. J. C* 71 (2011) 1641. [arXiv:1104.5475](#), [doi:10.1140/epjc/s10052-011-1641-2](#).
- [771] Y. Giraldo, Texture Zeros and WB Transformations in the Quark Sector of the Standard Model, *Phys. Rev. D* 86 (2012) 093021. [arXiv:1110.5986](#), [doi:10.1103/PhysRevD.86.093021](#).
- [772] M. Gupta, G. Ahuja, Flavor mixings and textures of the fermion mass matrices, *Int. J. Mod. Phys. A* 27 (2012) 1230033. [arXiv:1302.4823](#), [doi:10.1142/S0217751X12300335](#).
- [773] H. Lehmann, C. Newton, T. T. Wu, A New variant of symmetry breaking for quark mass matrices, *Phys. Lett. B* 384 (1996) 249–254. [doi:10.1016/0370-2693\(96\)00609-0](#).
- [774] K. Kang, S. K. Kang, New class of quark mass matrix and calculability of flavor mixing matrix, *Phys. Rev. D* 56 (1997) 1511–1514. [arXiv:hep-ph/9704253](#), [doi:10.1103/PhysRevD.56.1511](#).
- [775] T. Kobayashi, Z.-z. Xing, A String inspired ansatz for quark masses and mixing, *Mod. Phys. Lett. A* 12 (1997) 561–572. [arXiv:hep-ph/9609486](#), [doi:10.1142/S0217732397000583](#).
- [776] T. Kobayashi, Z.-z. Xing, Quark mass matrices in superstring models, *Int. J. Mod. Phys. A* 13 (1998) 2201–2215. [arXiv:hep-ph/9712432](#), [doi:10.1142/S0217751X98000998](#).
- [777] A. Mondragon, E. Rodriguez-Jauregui, The Breaking of the flavor permutational symmetry: Mass textures and the CKM matrix, *Phys. Rev. D* 59 (1999) 093009. [arXiv:hep-ph/9807214](#), [doi:10.1103/PhysRevD.59.093009](#).
- [778] H. Nishiura, K. Matsuda, T. Fukuyama, Lepton and quark mass matrices, *Phys. Rev. D* 60 (1999) 013006. [arXiv:hep-ph/9902385](#), [doi:10.1103/PhysRevD.60.013006](#).
- [779] G. C. Branco, D. Emmanuel-Costa, R. Gonzalez Felipe, Texture zeros and weak basis transformations, *Phys. Lett. B* 477 (2000) 147–155. [arXiv:hep-ph/9911418](#), [doi:10.1016/S0370-2693\(00\)00193-3](#).



- [780] W. G. Hollik, U. J. Saldana-Salazar, Texture zeros and hierarchical masses from flavour (mis)alignment, Nucl. Phys. B928 (2018) 535–554. [arXiv:1712.05387](#), [doi:10.1016/j.nuclphysb.2018.01.030](#).
- [781] C. H. Albright, C. Jarlskog, B.-A. Lindholm, Three Family Fritsch and Stech Models with Minimal and Two Doublet Higgs Structures, Phys. Rev. D38 (1988) 872. [doi:10.1103/PhysRevD.38.872](#).
- [782] Z.-z. Xing, Z.-h. Zhao, On the four-zero texture of quark mass matrices and its stability, Nucl. Phys. B897 (2015) 302–325. [arXiv:1501.06346](#), [doi:10.1016/j.nuclphysb.2015.05.027](#).
- [783] Z.-z. Xing, H. Zhang, Lepton mass matrices with four texture zeros, Phys. Lett. B569 (2003) 30–40. [arXiv:hep-ph/0304234](#), [doi:10.1016/j.physletb.2003.07.008](#).
- [784] H. D. Kim, S. Raby, L. Schradin, Quark mass textures and  $\sin 2\beta$ , Phys. Rev. D69 (2004) 092002. [arXiv:hep-ph/0401169](#), [doi:10.1103/PhysRevD.69.092002](#).
- [785] W. A. Ponce, J. D. Gmez, R. H. Benavides, Five texture zeros and CP violation for the standard model quark mass matrices, Phys. Rev. D87 (5) (2013) 053016. [arXiv:1303.1338](#), [doi:10.1103/PhysRevD.87.053016](#).
- [786] Z.-c. Liu, Renormalization-group evolution of the fermion mass matrices [arXiv:1908.10311](#).
- [787] G. F. Giudice, A New ansatz for quark and lepton mass matrices, Mod. Phys. Lett. A7 (1992) 2429–2436. [arXiv:hep-ph/9204215](#), [doi:10.1142/S0217732392003876](#).
- [788] C. H. Albright, M. Lindner, Nonlinear Evolution of the Three Family Fritsch Mass Matrices, Phys. Lett. B213 (1988) 347–354. [doi:10.1016/0370-2693\(88\)91773-X](#).
- [789] S. Dimopoulos, Natural Generation of Fermion Masses, Phys. Lett. 129B (1983) 417–428. [doi:10.1016/0370-2693\(83\)90132-6](#).
- [790] M. Leurer, Y. Nir, N. Seiberg, Mass matrix models, Nucl. Phys. B398 (1993) 319–342. [arXiv:hep-ph/9212278](#), [doi:10.1016/0550-3213\(93\)90112-3](#).
- [791] L. E. Ibanez, G. G. Ross, Fermion masses and mixing angles from gauge symmetries, Phys. Lett. B332 (1994) 100–110. [arXiv:hep-ph/9403338](#), [doi:10.1016/0370-2693\(94\)90865-6](#).
- [792] P. Binetruy, P. Ramond, Yukawa textures and anomalies, Phys. Lett. B350 (1995) 49–57. [arXiv:hep-ph/9412385](#), [doi:10.1016/0370-2693\(95\)00297-X](#).
- [793] E. Dudas, S. Pokorski, C. A. Savoy, Yukawa matrices from a spontaneously broken Abelian symmetry, Phys. Lett. B356 (1995) 45–55. [arXiv:hep-ph/9504292](#), [doi:10.1016/0370-2693\(95\)00795-M](#).
- [794] K. S. Babu, TASI Lectures on Flavor Physics, in: Proceedings of Theoretical Advanced Study Institute in Elementary Particle Physics on The dawn of the LHC era (TASI 2008): Boulder, USA, June 2-27, 2008, 2010, pp. 49–123. [arXiv:0910.2948](#), [doi:10.1142/9789812838360\\_0002](#).
- [795] K. S. Babu, T. Enkhbat, Fermion mass hierarchy and electric dipole moments, Nucl. Phys. B708 (2005) 511–531. [arXiv:hep-ph/0406003](#), [doi:10.1016/j.nuclphysb.2004.12.002](#).
- [796] K. S. Babu, S. M. Barr, Large neutrino mixing angles in unified theories, Phys. Lett. B381 (1996) 202–208. [arXiv:hep-ph/9511446](#), [doi:10.1016/0370-2693\(96\)00552-7](#).
- [797] C. H. Albright, K. S. Babu, S. M. Barr, A Minimality condition and atmospheric neutrino oscillations, Phys. Rev. Lett. 81 (1998) 1167–1170. [arXiv:hep-ph/9802314](#), [doi:10.1103/PhysRevLett.81.1167](#).
- [798] J. K. Elwood, N. Irges, P. Ramond, Family symmetry and neutrino mixing, Phys. Rev. Lett. 81 (1998) 5064–5067. [arXiv:hep-ph/9807228](#), [doi:10.1103/PhysRevLett.81.5064](#).
- [799] J. Sato, T. Yanagida, Large lepton mixing in a coset space family unification on  $E(7) / SU(5) \times U(1)^3$ , Phys. Lett. B430 (1998) 127–131. [arXiv:hep-ph/9710516](#), [doi:10.1016/S0370-2693\(98\)00510-3](#).
- [800] J. L. Lopez, D. V. Nanopoulos, Hierarchical Fermion Masses and Mixing Angles From the Flipped String, Nucl. Phys. B338 (1990) 73–100. [doi:10.1016/0550-3213\(90\)90624-M](#).
- [801] A. E. Faraggi, E. Halyo, Cabibbo-Kobayashi-Maskawa mixing in superstring derived Standard - like Models, Nucl. Phys. B416 (1994) 63–86. [arXiv:hep-ph/9306235](#), [doi:10.1016/0550-3213\(94\)90578-9](#).
- [802] K. S. Babu, R. N. Mohapatra, Mass matrix textures from superstring inspired  $SO(10)$  models, Phys. Rev. Lett. 74 (1995) 2418–2421. [arXiv:hep-ph/9410326](#), [doi:10.1103/PhysRevLett.74.2418](#).
- [803] T. Kobayashi, Quark mass matrices in orbifold models, Phys. Lett. B358 (1995) 253–258. [arXiv:hep-ph/9507244](#), [doi:10.1016/0370-2693\(95\)01006-C](#).
- [804] N. Haba, C. Hattori, M. Matsuda, T. Matsuoka, Fermion masses and mixings in a string inspired model, Prog. Theor. Phys. 96 (1996) 1249–1280. [arXiv:hep-ph/9605238](#), [doi:10.1143/PTP.96.1249](#).

- [805] E. Ma, G. Rajasekaran, Softly broken  $A(4)$  symmetry for nearly degenerate neutrino masses, Phys. Rev. D64 (2001) 113012. [arXiv:hep-ph/0106291](#), [doi:10.1103/PhysRevD.64.113012](#).
- [806] K. S. Babu, E. Ma, J. W. F. Valle, Underlying  $A(4)$  symmetry for the neutrino mass matrix and the quark mixing matrix, Phys. Lett. B552 (2003) 207–213. [arXiv:hep-ph/0206292](#), [doi:10.1016/S0370-2693\(02\)03153-2](#).
- [807] E. Ma,  $A(4)$  symmetry and neutrinos with very different masses, Phys. Rev. D70 (2004) 031901. [arXiv:hep-ph/0404199](#), [doi:10.1103/PhysRevD.70.031901](#).
- [808] S.-L. Chen, M. Frigerio, E. Ma, Hybrid seesaw neutrino masses with  $A(4)$  family symmetry, Nucl. Phys. B724 (2005) 423–431. [arXiv:hep-ph/0504181](#), [doi:10.1016/j.nuclphysb.2005.07.012](#).
- [809] X.-G. He, Y.-Y. Keum, R. R. Volkas,  $A(4)$  flavor symmetry breaking scheme for understanding quark and neutrino mixing angles, JHEP 04 (2006) 039. [arXiv:hep-ph/0601001](#), [doi:10.1088/1126-6708/2006/04/039](#).
- [810] A. Zee, Obtaining the neutrino mixing matrix with the tetrahedral group, Phys. Lett. B630 (2005) 58–67. [arXiv:hep-ph/0508278](#), [doi:10.1016/j.physletb.2005.09.068](#).
- [811] R. R. Volkas,  $A(4)$  symmetry breaking scheme for understanding quark and lepton mixing angles, Conf. Proc. C060726 (2006) 316–319. [arXiv:hep-ph/0612296](#).
- [812] S. F. King, S. Morisi, E. Peinado, J. W. F. Valle, Quark-Lepton Mass Relation in a Realistic  $A_4$  Extension of the Standard Model, Phys. Lett. B724 (2013) 68–72. [arXiv:1301.7065](#), [doi:10.1016/j.physletb.2013.05.067](#).
- [813] S. Morisi, E. Peinado, Y. Shimizu, J. W. F. Valle, Relating quarks and leptons without grand-unification, Phys. Rev. D84 (2011) 036003. [arXiv:1104.1633](#), [doi:10.1103/PhysRevD.84.036003](#).
- [814] F. Feruglio, Are neutrino masses modular forms?, in: A. Levy, S. Forte, G. Ridolfi (Eds.), From My Vast Repertoire ...: Guido Altarelli's Legacy, 2019, pp. 227–266. [arXiv:1706.08749](#), [doi:10.1142/9789813238053\\_0012](#).
- [815] H. Okada, M. Tanimoto, CP violation of quarks in  $A_4$  modular invariance, Phys. Lett. B791 (2019) 54–61. [arXiv:1812.09677](#), [doi:10.1016/j.physletb.2019.02.028](#).
- [816] T. Kobayashi, Y. Shimizu, K. Takagi, M. Tanimoto, T. H. Tatsuishi, H. Uchida, Finite modular subgroups for fermion mass matrices and baryon/lepton number violation, Phys. Lett. B794 (2019) 114–121. [arXiv:1812.11072](#), [doi:10.1016/j.physletb.2019.05.034](#).
- [817] F. J. de Anda, S. F. King, E. Perdomo,  $SU(5)$  Grand Unified Theory with  $A_4$  Modular Symmetry [arXiv:1812.05620](#).
- [818] H. Okada, M. Tanimoto, Towards unification of quark and lepton flavors in  $A_4$  modular invariance [arXiv:1905.13421](#).
- [819] T. Kobayashi, Y. Shimizu, K. Takagi, M. Tanimoto, T. H. Tatsuishi, Modular  $S_3$  invariant flavor model in  $SU(5)$  GUT [arXiv:1906.10341](#).
- [820] F. Wilczek, Majorana returns, Nature Phys. 5 (2009) 614–618. [doi:10.1038/nphys1380](#).
- [821] Z.-z. Xing, D. Zhang, J.-y. Zhu, The  $\mu$ - $\tau$  reflection symmetry of Dirac neutrinos and its breaking effect via quantum corrections, JHEP 11 (2017) 135. [arXiv:1708.09144](#), [doi:10.1007/JHEP11\(2017\)135](#).
- [822] C. Hagedorn, W. Rodejohann, Minimal mass matrices for dirac neutrinos, JHEP 07 (2005) 034. [arXiv:hep-ph/0503143](#), [doi:10.1088/1126-6708/2005/07/034](#).
- [823] X.-w. Liu, S. Zhou, Texture Zeros for Dirac Neutrinos and Current Experimental Tests, Int. J. Mod. Phys. A28 (2013) 1350040. [arXiv:1211.0472](#), [doi:10.1142/S0217751X13500401](#).
- [824] P. O. Ludl, W. Grimus, A complete survey of texture zeros in the lepton mass matrices, JHEP 07 (2014) 090, [Erratum: JHEP 10, 126 (2014)]. [arXiv:1406.3546](#), [doi:10.1007/JHEP07\(2014\)090](#), [doi:10.1007/JHEP10\(2014\)126](#).
- [825] L. J. Hall, D. Tucker-Smith, Leading order textures for lepton mass matrices, Phys. Rev. D59 (1999) 113013. [arXiv:hep-ph/9812308](#), [doi:10.1103/PhysRevD.59.113013](#).
- [826] H. Fritzsch, Z.-z. Xing, Y.-L. Zhou, Non-Hermitian Perturbations to the Fritzsch Textures of Lepton and Quark Mass Matrices, Phys. Lett. B697 (2011) 357–363. [arXiv:1101.4272](#), [doi:10.1016/j.physletb.2011.02.026](#).
- [827] K. Matsuda, H. Nishiura, Can four-zero-texture mass matrix model reproduce the quark and lepton mixing

- angles and CP violating phases?, Phys. Rev. D74 (2006) 033014. [arXiv:hep-ph/0606142](#), [doi:10.1103/PhysRevD.74.033014](#).
- [828] B. Adhikary, M. Chakraborty, A. Ghosal, Scaling ansatz, four zero Yukawa textures and large  $\theta_{13}$ , Phys. Rev. D86 (2012) 013015. [arXiv:1205.1355](#), [doi:10.1103/PhysRevD.86.013015](#).
- [829] J. Barranco, D. Delepine, L. Lopez-Lozano, Neutrino Mass Determination from a Four-Zero Texture Mass Matrix, Phys. Rev. D86 (2012) 053012. [arXiv:1205.0859](#), [doi:10.1103/PhysRevD.86.053012](#).
- [830] P. Fakay, S. Sharma, R. Verma, G. Ahuja, M. Gupta, Implications of  $\theta_{13}$  on Fritzsche-like lepton mass matrices, Phys. Lett. B720 (2013) 366–372. [arXiv:1301.5970](#), [doi:10.1016/j.physletb.2013.02.044](#).
- [831] K. R. Dienes, E. Dudas, T. Gherghetta, Neutrino oscillations without neutrino masses or heavy mass scales: A Higher dimensional seesaw mechanism, Nucl. Phys. B557 (1999) 25. [arXiv:hep-ph/9811428](#), [doi:10.1016/S0550-3213\(99\)00377-6](#).
- [832] N. Arkani-Hamed, S. Dimopoulos, G. R. Dvali, J. March-Russell, Neutrino masses from large extra dimensions, Phys. Rev. D65 (2001) 024032. [arXiv:hep-ph/9811448](#), [doi:10.1103/PhysRevD.65.024032](#).
- [833] P. Q. Hung, Brane world unification of quark and lepton masses and its implication for the masses of the neutrinos, Nucl. Phys. B720 (2005) 89–115. [arXiv:hep-ph/0412262](#), [doi:10.1016/j.nuclphysb.2005.05.023](#).
- [834] Y. Fujimoto, K. Hasegawa, T. Nagasawa, K. Nishiwaki, M. Sakamoto, K. Tatsumi, Active Dirac neutrinos via  $SU(2)_L$  doublets in 5d, JHEP 06 (2016) 178. [arXiv:1601.05265](#), [doi:10.1007/JHEP06\(2016\)178](#).
- [835] N. Arkani-Hamed, L. J. Hall, H. Murayama, D. Tucker-Smith, N. Weiner, Small neutrino masses from supersymmetry breaking, Phys. Rev. D64 (2001) 115011. [arXiv:hep-ph/0006312](#), [doi:10.1103/PhysRevD.64.115011](#).
- [836] S. Abel, A. Dedes, K. Tamvakis, Naturally small Dirac neutrino masses in supergravity, Phys. Rev. D71 (2005) 033003. [arXiv:hep-ph/0402287](#), [doi:10.1103/PhysRevD.71.033003](#).
- [837] R. Kitano, Small Dirac neutrino masses in supersymmetric grand unified theories, Phys. Lett. B539 (2002) 102–106. [arXiv:hep-ph/0204164](#), [doi:10.1016/S0370-2693\(02\)02067-1](#).
- [838] P. Ko, T. Kobayashi, J.-h. Park, Lepton masses and mixing angles from heterotic orbifold models, Phys. Rev. D71 (2005) 095010. [arXiv:hep-ph/0503029](#), [doi:10.1103/PhysRevD.71.095010](#).
- [839] G. C. Branco, G. Senjanovic, The Question of Neutrino Mass, Phys. Rev. D18 (1978) 1621. [doi:10.1103/PhysRevD.18.1621](#).
- [840] D. Chang, R. N. Mohapatra, Small and Calculable Dirac Neutrino Mass, Phys. Rev. Lett. 58 (1987) 1600. [doi:10.1103/PhysRevLett.58.1600](#).
- [841] K. S. Babu, X. G. He, Dirac neutrino masses as two-loop radiative corrections, Mod. Phys. Lett. A4 (1989) 61. [doi:10.1142/S0217732389000095](#).
- [842] P. Q. Hung, On neutrino masses and family replication, Phys. Rev. D59 (1999) 113008. [arXiv:hep-ph/9810419](#), [doi:10.1103/PhysRevD.59.113008](#).
- [843] P.-H. Gu, H.-J. He, Neutrino Mass and Baryon Asymmetry from Dirac Seesaw, JCAP 0612 (2006) 010. [arXiv:hep-ph/0610275](#), [doi:10.1088/1475-7516/2006/12/010](#).
- [844] S. Kanemura, T. Nabeshima, H. Sugiyama, Neutrino Masses from Loop-Induced Dirac Yukawa Couplings, Phys. Lett. B703 (2011) 66–70. [arXiv:1106.2480](#), [doi:10.1016/j.physletb.2011.07.047](#).
- [845] N. Memenga, W. Rodejohann, H. Zhang,  $A_4$  flavor symmetry model for Dirac neutrinos and sizable  $U_{e3}$ , Phys. Rev. D87 (5) (2013) 053021. [arXiv:1301.2963](#), [doi:10.1103/PhysRevD.87.053021](#).
- [846] C.-S. Chen, L.-H. Tsai, Peccei-Quinn symmetry as the origin of Dirac Neutrino Masses, Phys. Rev. D88 (5) (2013) 055015. [arXiv:1210.6264](#), [doi:10.1103/PhysRevD.88.055015](#).
- [847] A. Aranda, C. Bonilla, S. Morisi, E. Peinado, J. W. F. Valle, Dirac neutrinos from flavor symmetry, Phys. Rev. D89 (3) (2014) 033001. [arXiv:1307.3553](#), [doi:10.1103/PhysRevD.89.033001](#).
- [848] A. Esmaili, A. Yu. Smirnov, Discrete symmetries and mixing of Dirac neutrinos, Phys. Rev. D92 (9) (2015) 093012. [arXiv:1510.00344](#), [doi:10.1103/PhysRevD.92.093012](#).
- [849] D. Borah, A. Dasgupta, Naturally Light Dirac Neutrino in Left-Right Symmetric Model, JCAP 1706 (06) (2017) 003. [arXiv:1702.02877](#), [doi:10.1088/1475-7516/2017/06/003](#).
- [850] W. Wang, Z.-L. Han, Naturally Small Dirac Neutrino Mass with Intermediate  $SU(2)_L$  Multiplet Fields, JHEP 1704 (04) (2016) 166. [arXiv:1611.03240](#), [doi:10.1007/JHEP04\(2016\)166](#).

- [851] W. Wang, R. Wang, Z.-L. Han, J.-Z. Han, The  $B - L$  Scotogenic Models for Dirac Neutrino Masses, Eur. Phys. J. C77 (12) (2017) 889. [arXiv:1705.00414](#), [doi:10.1140/epjc/s10052-017-5446-9](#).
- [852] S. S. Correia, R. G. Felipe, F. R. Joaquim, Dirac neutrinos in the 2HDM with restrictive Abelian symmetries [arXiv:1909.00833](#).
- [853] Z.-z. Xing, J.-y. Zhu, Neutrino mass ordering and  $\mu$ - $\tau$  reflection symmetry breaking, Chin. Phys. C41 (12) (2017) 123103. [arXiv:1707.03676](#), [doi:10.1088/1674-1137/41/12/123103](#).
- [854] B. Adhikary, A. Ghosal, P. Roy, mu tau symmetry, tribimaximal mixing and four zero neutrino Yukawa textures, JHEP 10 (2009) 040. [arXiv:0908.2686](#), [doi:10.1088/1126-6708/2009/10/040](#).
- [855] T. Baba, M. Yasue, Majorana CP Violation in Approximately  $\mu$ - $\tau$  Symmetric Models with  $\det(M_\nu) = 0$ , Prog. Theor. Phys. 123 (2010) 659–686. [arXiv:1003.1438](#), [doi:10.1143/PTP.123.659](#).
- [856] Y.-L. Zhou,  $\mu$ - $\tau$  reflection symmetry and radiative corrections [arXiv:1409.8600](#).
- [857] G.-y. Huang, Z.-z. Xing, J.-y. Zhu, Correlation of normal neutrino mass ordering with upper octant of  $\theta_{23}$  and third quadrant of  $\delta$  via RGE-induced  $\mu$ - $\tau$  symmetry breaking, Chin. Phys. C42 (12) (2018) 123108. [arXiv:1806.06640](#), [doi:10.1088/1674-1137/42/12/123108](#).
- [858] Z.-z. Xing, Universal neutrino mass hierarchy and cosmological baryon number asymmetry, Phys. Rev. D70 (2004) 071302. [arXiv:hep-ph/0406047](#), [doi:10.1103/PhysRevD.70.071302](#).
- [859] E. Ma, Plato's fire and the neutrino mass matrix, Mod. Phys. Lett. A17 (2002) 2361–2370. [arXiv:hep-ph/0211393](#), [doi:10.1142/S021773230200909X](#).
- [860] W. Grimus, L. Lavoura, A Nonstandard CP transformation leading to maximal atmospheric neutrino mixing, Phys. Lett. B579 (2004) 113–122. [arXiv:hep-ph/0305309](#), [doi:10.1016/j.physletb.2003.10.075](#).
- [861] P. F. Harrison, W. G. Scott, The Simplest neutrino mass matrix, Phys. Lett. B594 (2004) 324–332. [arXiv:hep-ph/0403278](#), [doi:10.1016/j.physletb.2004.05.039](#).
- [862] T. Kitabayashi, M. Yasue, mu-tau symmetry and maximal CP violation, Phys. Lett. B621 (2005) 133–138. [arXiv:hep-ph/0504212](#), [doi:10.1016/j.physletb.2005.06.052](#).
- [863] T. Baba, M. Yasue, Correlation between Leptonic CP Violation and  $\mu$ - $\tau$  Symmetry Breaking, Phys. Rev. D75 (2007) 055001. [arXiv:hep-ph/0612034](#), [doi:10.1103/PhysRevD.75.055001](#).
- [864] H.-J. He, W. Rodejohann, X.-J. Xu, Origin of Constrained Maximal CP Violation in Flavor Symmetry, Phys. Lett. B751 (2015) 586–594. [arXiv:1507.03541](#), [doi:10.1016/j.physletb.2015.10.066](#).
- [865] A. S. Joshipura, K. M. Patel, Generalized  $\mu$ - $\tau$  symmetry and discrete subgroups of  $O(3)$ , Phys. Lett. B749 (2015) 159–166. [arXiv:1507.01235](#), [doi:10.1016/j.physletb.2015.07.062](#).
- [866] Z.-h. Zhao, Breakings of the neutrino  $\mu$ - $\tau$  reflection symmetry, JHEP 09 (2017) 023. [arXiv:1703.04984](#), [doi:10.1007/JHEP09\(2017\)023](#).
- [867] Z.-h. Zhao, Modifications to the neutrino mixing from the  $\mu$ - $\tau$  reflection symmetry, Nucl. Phys. B935 (2018) 129–143. [arXiv:1803.04603](#), [doi:10.1016/j.nuclphysb.2018.08.007](#).
- [868] Z.-C. Liu, C.-X. Yue, Z.-H. Zhao, On the textures of neutrino mass matrix for maximal atmospheric mixing angle and Dirac CP phase, JHEP 10 (2018) 106. [arXiv:1807.10031](#), [doi:10.1007/JHEP10\(2018\)106](#).
- [869] S. Luo, Z.-z. Xing, Resolving the octant of  $\theta_{23}$  via radiative  $\mu$ - $\tau$  symmetry breaking, Phys. Rev. D90 (7) (2014) 073005. [arXiv:1408.5005](#), [doi:10.1103/PhysRevD.90.073005](#).
- [870] J. R. Ellis, S. Lola, Can neutrinos be degenerate in mass?, Phys. Lett. B458 (1999) 310–321. [arXiv:hep-ph/9904279](#), [doi:10.1016/S0370-2693\(99\)00545-6](#).
- [871] G.-Y. Huang, Z.-Z. Xing, J.-Y. Zhu, Spontaneous  $\mu$ - $\tau$  Reflection Symmetry Breaking in Neutrino Phenomenology, Universe 4 (12) (2018) 141. [doi:10.3390/universe4120141](#).
- [872] J. Elias-Miro, J. R. Espinosa, G. F. Giudice, G. Isidori, A. Riotto, A. Strumia, Higgs mass implications on the stability of the electroweak vacuum, Phys. Lett. B709 (2012) 222–228. [arXiv:1112.3022](#), [doi:10.1016/j.physletb.2012.02.013](#).
- [873] P. H. Frampton, S. L. Glashow, D. Marfatia, Zeroes of the neutrino mass matrix, Phys. Lett. B536 (2002) 79–82. [arXiv:hep-ph/0201008](#), [doi:10.1016/S0370-2693\(02\)01817-8](#).
- [874] Z.-z. Xing, Texture zeros and Majorana phases of the neutrino mass matrix, Phys. Lett. B530 (2002) 159–166. [arXiv:hep-ph/0201151](#), [doi:10.1016/S0370-2693\(02\)01354-0](#).
- [875] Z.-z. Xing, A Full determination of the neutrino mass spectrum from two zero textures of the neutrino mass matrix, Phys. Lett. B539 (2002) 85–90. [arXiv:hep-ph/0205032](#), [doi:10.1016/S0370-2693\(02\)](#)

- 02062-2.
- [876] W.-l. Guo, Z.-z. Xing, Implications of the KamLAND measurement on the lepton flavor mixing matrix and the neutrino mass matrix, *Phys. Rev. D* 67 (2003) 053002. [arXiv:hep-ph/0212142](#), [doi:10.1103/PhysRevD.67.053002](#).
  - [877] Z.-z. Xing, Texture zeros and CP-violating phases in the neutrino mass matrix, in: *Neutrino oscillations and their origin. Proceedings, 5th International Workshop, NOON2004, Tokyo, Japan, February 11-15, 2004*, 2004, pp. 442–449. [arXiv:hep-ph/0406049](#), [doi:10.1142/9789812701824\\_0054](#).
  - [878] B. R. Desai, D. P. Roy, A. R. Vaucher, Three neutrino mass matrices with two texture zeros, *Mod. Phys. Lett. A* 18 (2003) 1355–1366. [arXiv:hep-ph/0209035](#), [doi:10.1142/S0217732303011071](#).
  - [879] M. Frigerio, A. Yu. Smirnov, Neutrino mass matrix: Inverted hierarchy and CP violation, *Phys. Rev. D* 67 (2003) 013007. [arXiv:hep-ph/0207366](#), [doi:10.1103/PhysRevD.67.013007](#).
  - [880] M. Honda, S. Kaneko, M. Tanimoto, Prediction and its stability in neutrino mass matrix with two zeros, *JHEP* 09 (2003) 028. [arXiv:hep-ph/0303227](#), [doi:10.1088/1126-6708/2003/09/028](#).
  - [881] G. Bhattacharyya, A. Raychaudhuri, A. Sil, Can radiative magnification of mixing angles occur for two zero neutrino mass matrix textures?, *Phys. Rev. D* 67 (2003) 073004. [arXiv:hep-ph/0211074](#), [doi:10.1103/PhysRevD.67.073004](#).
  - [882] A. Watanabe, K. Yoshioka, Minimal archi-texture for neutrino mass matrices, *JHEP* 05 (2006) 044. [arXiv:hep-ph/0601152](#), [doi:10.1088/1126-6708/2006/05/044](#).
  - [883] Y. Farzan, A. Yu. Smirnov, Leptonic CP violation: Zero, maximal or between the two extremes, *JHEP* 01 (2007) 059. [arXiv:hep-ph/0610337](#), [doi:10.1088/1126-6708/2007/01/059](#).
  - [884] S. Dev, S. Kumar, S. Verma, S. Gupta, Phenomenology of two-texture zero neutrino mass matrices, *Phys. Rev. D* 76 (2007) 013002. [arXiv:hep-ph/0612102](#), [doi:10.1103/PhysRevD.76.013002](#).
  - [885] E. I. Lashin, N. Chamoun, Zero minors of the neutrino mass matrix, *Phys. Rev. D* 78 (2008) 073002. [arXiv:0708.2423](#), [doi:10.1103/PhysRevD.78.073002](#).
  - [886] S. Choubey, W. Rodejohann, P. Roy, Phenomenological consequences of four zero neutrino Yukawa textures, *Nucl. Phys. B* 808 (2009) 272–291, [Erratum: *Nucl. Phys. B* 818, 136 (2009)]. [arXiv:0807.4289](#), [doi:10.1016/j.nuclphysb.2009.04.021](#), [doi:10.1016/j.nuclphysb.2008.09.031](#).
  - [887] W. Grimus, P. O. Ludl, Maximal atmospheric neutrino mixing from texture zeros and quasi-degenerate neutrino masses, *Phys. Lett. B* 700 (2011) 356–361. [arXiv:1104.4340](#), [doi:10.1016/j.physletb.2011.05.029](#).
  - [888] H. Fritzsch, Z.-z. Xing, S. Zhou, Two-zero Textures of the Majorana Neutrino Mass Matrix and Current Experimental Tests, *JHEP* 09 (2011) 083. [arXiv:1108.4534](#), [doi:10.1007/JHEP09\(2011\)083](#).
  - [889] S. Zhou, Update on two-zero textures of the Majorana neutrino mass matrix in light of recent T2K, Super-Kamiokande and NOvA results, *Chin. Phys. C* 40 (3) (2016) 033102. [arXiv:1509.05300](#), [doi:10.1088/1674-1137/40/3/033102](#).
  - [890] J. Alcaide, J. Salvado, A. Santamaria, Fitting flavour symmetries: the case of two-zero neutrino mass textures, *JHEP* 07 (2018) 164. [arXiv:1806.06785](#), [doi:10.1007/JHEP07\(2018\)164](#).
  - [891] D. Zhang, A modular  $A_4$  symmetry realization of two-zero textures of the Majorana neutrino mass matrix, *Nucl. Phys. B* 952 (2020) 114935. [arXiv:1910.07869](#), [doi:10.1016/j.nuclphysb.2020.114935](#).
  - [892] D. Meloni, A. Meroni, E. Peinado, Two-zero Majorana textures in the light of the Planck results, *Phys. Rev. D* 89 (5) (2014) 053009. [arXiv:1401.3207](#), [doi:10.1103/PhysRevD.89.053009](#).
  - [893] M. Singh, Testing Texture Two Zero Neutrino Mass Matrices Under Current Experimental Scenario [arXiv:1909.01552](#).
  - [894] W. Grimus, L. Lavoura, On a model with two zeros in the neutrino mass matrix, *J. Phys. G* 31 (7) (2005) 693–702. [arXiv:hep-ph/0412283](#), [doi:10.1088/0954-3899/31/7/014](#).
  - [895] C. Hagedorn, J. Kersten, M. Lindner, Stability of texture zeros under radiative corrections in see-saw models, *Phys. Lett. B* 597 (2004) 63–72. [arXiv:hep-ph/0406103](#), [doi:10.1016/j.physletb.2004.06.094](#).
  - [896] Z.-z. Xing, Implications of generalized Frampton-Glashow-Yanagida ansaetze on neutrino masses and lepton flavor mixing, *Phys. Rev. D* 69 (2004) 013006. [arXiv:hep-ph/0307007](#), [doi:10.1103/PhysRevD.69.013006](#).
  - [897] A. Merle, W. Rodejohann, The Elements of the neutrino mass matrix: Allowed ranges and implications of

- texture zeros, Phys. Rev. D73 (2006) 073012. [arXiv:hep-ph/0603111](#), [doi:10.1103/PhysRevD.73.073012](#).
- [898] E. I. Lashin, N. Chamoun, The One-zero Textures of Majorana Neutrino Mass Matrix and Current Experimental Tests, Phys. Rev. D85 (2012) 113011. [arXiv:1108.4010](#), [doi:10.1103/PhysRevD.85.113011](#).
- [899] J. Cao, G.-y. Huang, Y.-F. Li, Y. Wang, L.-J. Wen, Z.-z. Xing, Z.-h. Zhao, S. Zhou, Towards the meV limit of the effective neutrino mass in neutrinoless double-beta decays [arXiv:1908.08355](#).
- [900] M. Fukugita, M. Tanimoto, T. Yanagida, Phenomenological lepton mass matrix, Prog. Theor. Phys. 89 (1993) 263–268. [doi:10.1143/PTP.89.263](#).
- [901] Z.-z. Xing, S. Zhou, Isomeric lepton mass matrices and bilarge neutrino mixing, Phys. Lett. B593 (2004) 156–164. [arXiv:hep-ph/0403261](#), [doi:10.1016/j.physletb.2004.04.059](#).
- [902] S. Zhou, Z.-z. Xing, A Systematic study of neutrino mixing and CP violation from lepton mass matrices with six texture zeros, Eur. Phys. J. C38 (2005) 495–510. [arXiv:hep-ph/0404188](#), [doi:10.1140/epjc/s2004-02065-2](#).
- [903] M. Fukugita, Y. Shimizu, M. Tanimoto, T. T. Yanagida,  $\theta_{13}$  in neutrino mass matrix with the minimal texture, Phys. Lett. B716 (2012) 294–297. [arXiv:1204.2389](#), [doi:10.1016/j.physletb.2012.06.049](#).
- [904] M. Fukugita, Y. Kaneta, Y. Shimizu, M. Tanimoto, T. T. Yanagida, CP violating phase from minimal texture neutrino mass matrix: Test of the phase relevant to leptogenesis, Phys. Lett. B764 (2017) 163–166. [arXiv:1609.01864](#), [doi:10.1016/j.physletb.2016.11.024](#).
- [905] G. C. Branco, T. Morozumi, B. M. Nobre, M. N. Rebelo, A Relation between CP violation of low-energy and leptogenesis, Nucl. Phys. Proc. Suppl. 111 (2002) 303–305. [arXiv:hep-ph/0202036](#), [doi:10.1016/S0920-5632\(02\)01729-2](#).
- [906] H. K. Dreiner, J. S. Kim, O. Lebedev, M. Thormeier, Supersymmetric Jarlskog invariants: The Neutrino sector, Phys. Rev. D76 (2007) 015006. [arXiv:hep-ph/0703074](#), [doi:10.1103/PhysRevD.76.015006](#).
- [907] B. Yu, S. Zhou, The number of sufficient and necessary conditions for CP conservation with Majorana neutrinos: three or four? [arXiv:1908.09306](#).
- [908] M. Obara, Z.-z. Xing, On the Fukugita-Tanimoto-Yanagida ansatz with partially non-degenerate right-handed Majorana neutrinos, Phys. Lett. B644 (2007) 136–146. [arXiv:hep-ph/0608280](#), [doi:10.1016/j.physletb.2006.11.010](#).
- [909] M. Obara, Z.-Z. Xing, Generalized Fukugita-Tanimoto-Yanagida neutrino mass ansatz, Int. J. Mod. Phys. E16 (2007) 1405–1416. [doi:10.1142/S0218301307006769](#).
- [910] H. Fritzsch, S. Zhou, Neutrino Mixing Angles from Texture Zeros of the Lepton Mass Matrices, Phys. Lett. B718 (2013) 1457–1464. [arXiv:1212.0411](#), [doi:10.1016/j.physletb.2012.12.071](#).
- [911] A. Kageyama, S. Kaneko, N. Shimoyama, M. Tanimoto, Seesaw realization of the texture zeros in the neutrino mass matrix, Phys. Lett. B538 (2002) 96–106. [arXiv:hep-ph/0204291](#), [doi:10.1016/S0370-2693\(02\)01964-0](#).
- [912] G. C. Branco, D. Emmanuel-Costa, M. N. Rebelo, P. Roy, Four Zero Neutrino Yukawa Textures in the Minimal Seesaw Framework, Phys. Rev. D77 (2008) 053011. [arXiv:0712.0774](#), [doi:10.1103/PhysRevD.77.053011](#).
- [913] J. Liao, D. Marfatia, K. Whisnant, Seesaw mechanism with four texture zeros in the neutrino Yukawa matrix, Phys. Rev. D87 (2013) 073013. [arXiv:1302.2372](#), [doi:10.1103/PhysRevD.87.073013](#).
- [914] J. Liao, D. Marfatia, K. Whisnant, Neutrino seesaw mechanism with texture zeros, Nucl. Phys. B900 (2015) 449–476. [arXiv:1508.07364](#), [doi:10.1016/j.nuclphysb.2015.09.020](#).
- [915] T. Kitabayashi, M. Yasue, Seesaw model and two zero flavor neutrino texture, Int. J. Mod. Phys. A32 (06n07) (2017) 1750034. [arXiv:1606.01008](#), [doi:10.1142/S0217751X17500348](#).
- [916] T. Morozumi, Y. Shimizu, H. Umeeda, A. Yuu, Hidden relations in three generation seesaw model with Dirac mass matrix of four-zero texture [arXiv:1905.11747](#).
- [917] W. Buchmuller, D. Wyler, CP violation, neutrino mixing and the baryon asymmetry, Phys. Lett. B521 (2001) 291–298. [arXiv:hep-ph/0108216](#), [doi:10.1016/S0370-2693\(01\)01211-4](#).
- [918] Z.-z. Xing, A Predictive ansatz for neutrino mixing and leptogenesis, Phys. Lett. B545 (2002) 352–360. [arXiv:hep-ph/0206245](#), [doi:10.1016/S0370-2693\(02\)02615-1](#).
- [919] L.-J. Hu, S. Dulat, A. Ablat, Neutrino masses and flavor mixing in the Extended Double Seesaw Model with

- two texture zeros, *Eur. Phys. J. C* 71 (2011) 1772. doi:10.1140/epjc/s10052-011-1772-5.
- [920] Y.-L. Zhou, Neutrino masses and flavor mixing in a generalized inverse seesaw model with a universal two-zero texture, *Phys. Rev. D* 86 (2012) 093011. arXiv:1205.2303, doi:10.1103/PhysRevD.86.093011.
- [921] Z.-z. Xing, Massive and Massless Neutrinos on Unbalanced Seesaws, *Chin. Phys. C* 32 (2008) 96–99. arXiv:0706.0052, doi:10.1088/1674-1137/32/2/004.
- [922] S. T. Petcov, S. T. Toshev, Conservation of Lepton Charges, Massive Majorana and Massless Neutrinos, *Phys. Lett.* 143B (1984) 175–178. doi:10.1016/0370-2693(84)90829-3.
- [923] K. S. Babu, E. Ma, Natural Hierarchy of Radiatively Induced Majorana Neutrino Masses, *Phys. Rev. Lett.* 61 (1988) 674. doi:10.1103/PhysRevLett.61.674.
- [924] W. Grimus, L. Lavoura, A Neutrino mass matrix with seesaw mechanism and two loop mass splitting, *Phys. Rev. D* 62 (2000) 093012. arXiv:hep-ph/0007011, doi:10.1103/PhysRevD.62.093012.
- [925] S. Davidson, G. Isidori, A. Strumia, The Smallest neutrino mass, *Phys. Lett.* B646 (2007) 100–104. arXiv:hep-ph/0611389, doi:10.1016/j.physletb.2007.01.015.
- [926] J.-w. Mei, Z.-z. Xing, Radiative corrections to neutrino mixing and CP violation in the minimal seesaw model with leptogenesis, *Phys. Rev. D* 69 (2004) 073003. arXiv:hep-ph/0312167, doi:10.1103/PhysRevD.69.073003.
- [927] J. Zhang, S. Zhou, A Further Study of the Frampton-Glashow-Yanagida Model for Neutrino Masses, Flavor Mixing and Baryon Number Asymmetry, *JHEP* 09 (2015) 065. arXiv:1505.04858, doi:10.1007/JHEP09(2015)065.
- [928] Z.-C. Liu, C.-X. Yue, Z.-h. Zhao, Neutrino  $\mu$ - $\tau$  reflection symmetry and its breaking in the minimal seesaw, *JHEP* 10 (2017) 102. arXiv:1707.05535, doi:10.1007/JHEP10(2017)102.
- [929] Y. Shimizu, K. Takagi, M. Tanimoto, Towards the minimal seesaw model via CP violation of neutrinos, *JHEP* 11 (2017) 201. arXiv:1709.02136, doi:10.1007/JHEP11(2017)201.
- [930] N. Nath, Z.-z. Xing, J. Zhang,  $\mu$ - $\tau$  Reflection Symmetry Embedded in Minimal Seesaw, *Eur. Phys. J. C* 78 (4) (2018) 289. arXiv:1801.09931, doi:10.1140/epjc/s10052-018-5751-y.
- [931] N. Nath,  $\mu$ - $\tau$  Reflection Symmetry and Its Explicit Breaking for Leptogenesis in a Minimal Seesaw Model arXiv:1808.05062.
- [932] S. F. King, C. Luhn, Littlest Seesaw model from  $S_4 \times U(1)$ , *JHEP* 09 (2016) 023. arXiv:1607.05276, doi:10.1007/JHEP09(2016)023.
- [933] S. F. King, J. Zhang, S. Zhou, Renormalisation Group Corrections to the Littlest Seesaw Model and Maximal Atmospheric Mixing, *JHEP* 12 (2016) 023. arXiv:1609.09402, doi:10.1007/JHEP12(2016)023.
- [934] G.-J. Ding, S. F. King, C.-C. Li, Golden Littlest Seesaw, *Nucl. Phys. B* 925 (2017) 470–499. arXiv:1705.05307, doi:10.1016/j.nuclphysb.2017.10.019.
- [935] S. F. King, C. C. Nishi, Mu-tau symmetry and the Littlest Seesaw, *Phys. Lett.* B785 (2018) 391–398. arXiv:1807.00023, doi:10.1016/j.physletb.2018.08.056.
- [936] S. F. King, Y.-L. Zhou, Littlest mu-tau seesaw, *JHEP* 05 (2019) 217. arXiv:1901.06877, doi:10.1007/JHEP05(2019)217.
- [937] S. Goswami, K. N. Vishnudath, N. Khan, Constraining the minimal type-III seesaw model with naturalness, lepton flavor violation, and electroweak vacuum stability, *Phys. Rev. D* 99 (7) (2019) 075012. arXiv:1810.11687, doi:10.1103/PhysRevD.99.075012.
- [938] C. Biggio, E. Fernandez-Martinez, M. Filaci, J. Hernandez-Garcia, J. Lopez-Pavon, Global Bounds on the Type-III Seesaw arXiv:1911.11790.
- [939] E. K. Akhmedov, M. Frigerio, Interplay of type I and type II seesaw contributions to neutrino mass, *JHEP* 01 (2007) 043. arXiv:hep-ph/0609046, doi:10.1088/1126-6708/2007/01/043.
- [940] D. Borah, A. Dasgupta, Charged lepton flavour violation and neutrinoless double beta decay in left-right symmetric models with type I+II seesaw, *JHEP* 07 (2016) 022. arXiv:1606.00378, doi:10.1007/JHEP07(2016)022.
- [941] T. Ohlsson, M. Pernow, Fits to Non-Supersymmetric  $SO(10)$  Models with Type I and II Seesaw Mechanisms Using Renormalization Group Evolution, *JHEP* 06 (2019) 085. arXiv:1903.08241, doi:10.1007/JHEP06(2019)085.
- [942] T. Hambye, G. Senjanovic, Consequences of triplet seesaw for leptogenesis, *Phys. Lett.* B582 (2004) 73–81.

- [arXiv:hep-ph/0307237](#), [doi:10.1016/j.physletb.2003.11.061](#).
- [943] S. Antusch, S. F. King, Type II Leptogenesis and the neutrino mass scale, *Phys. Lett.* B597 (2004) 199–207. [arXiv:hep-ph/0405093](#), [doi:10.1016/j.physletb.2004.07.009](#).
- [944] P.-h. Gu, X.-j. Bi, Thermal leptogenesis with triplet Higgs boson and mass varying neutrinos, *Phys. Rev.* D70 (2004) 063511. [arXiv:hep-ph/0405092](#), [doi:10.1103/PhysRevD.70.063511](#).
- [945] S. Antusch, Flavour-dependent type II leptogenesis, *Phys. Rev.* D76 (2007) 023512. [arXiv:0704.1591](#), [doi:10.1103/PhysRevD.76.023512](#).
- [946] G. Ingelman, J. Rathsmann, Heavy Majorana neutrinos at *ep* colliders, *Z. Phys.* C60 (1993) 243–254. [doi:10.1007/BF01474620](#).
- [947] A. Atre, T. Han, S. Pascoli, B. Zhang, The Search for Heavy Majorana Neutrinos, *JHEP* 05 (2009) 030. [arXiv:0901.3589](#), [doi:10.1088/1126-6708/2009/05/030](#).
- [948] F. F. Deppisch, P. S. Bhupal Dev, A. Pilaftsis, Neutrinos and Collider Physics, *New J. Phys.* 17 (7) (2015) 075019. [arXiv:1502.06541](#), [doi:10.1088/1367-2630/17/7/075019](#).
- [949] M. Hirsch, T. Kernreiter, J. C. Romao, A. Villanova del Moral, Minimal Supersymmetric Inverse Seesaw: Neutrino masses, lepton flavour violation and LHC phenomenology, *JHEP* 01 (2010) 103. [arXiv:0910.2435](#), [doi:10.1007/JHEP01\(2010\)103](#).
- [950] S. Mondal, S. Biswas, P. Ghosh, S. Roy, Exploring novel correlations in trilepton channels at the LHC for the minimal supersymmetric inverse seesaw model, *JHEP* 05 (2012) 134. [arXiv:1201.1556](#), [doi:10.1007/JHEP05\(2012\)134](#).
- [951] A. Abada, M. Lucente, Looking for the minimal inverse seesaw realisation, *Nucl. Phys.* B885 (2014) 651–678. [arXiv:1401.1507](#), [doi:10.1016/j.nuclphysb.2014.06.003](#).
- [952] A. Abada, G. Arcadi, M. Lucente, Dark Matter in the minimal Inverse Seesaw mechanism, *JCAP* 1410 (2014) 001. [arXiv:1406.6556](#), [doi:10.1088/1475-7516/2014/10/001](#).
- [953] A. E. Carcamo Hernandez, S. F. King, Littlest Inverse Seesaw Model, *Nucl. Phys.* B953 (2020) 114950. [arXiv:1903.02565](#), [doi:10.1016/j.nuclphysb.2020.114950](#).
- [954] Y. Koide, Charged Lepton Mass Matrix With Democratic Family Mixing, *Z. Phys.* C45 (1989) 39. [doi:10.1007/BF01556669](#).
- [955] Y. Koide, Neutrino mixing in a democratic seesaw mass matrix model, *Mod. Phys. Lett.* A11 (1996) 2849–2860. [arXiv:hep-ph/9603376](#), [doi:10.1142/S0217732396002836](#).
- [956] Y. Koide, Universal seesaw mass matrix model with an  $S(3)$  symmetry, *Phys. Rev.* D60 (1999) 077301. [arXiv:hep-ph/9905416](#), [doi:10.1103/PhysRevD.60.077301](#).
- [957] W. Rodejohann, Z.-z. Xing, Flavor democracy and type-II seesaw realization of bilarge neutrino mixing, *Phys. Lett.* B601 (2004) 176–183. [arXiv:hep-ph/0408195](#), [doi:10.1016/j.physletb.2004.09.061](#).
- [958] Y. Koide,  $S(3)$  symmetry and neutrino masses and mixings, *Eur. Phys. J.* C50 (2007) 809–816. [arXiv:hep-ph/0612058](#), [doi:10.1140/epjc/s10052-007-0261-3](#).
- [959] S.-F. Ge, A. Kusenko, T. T. Yanagida, Large Leptonic Dirac CP Phase from Broken Democracy with Random Perturbations, *Phys. Lett.* B781 (2018) 699–705. [arXiv:1803.03888](#), [doi:10.1016/j.physletb.2018.04.040](#).
- [960] T. Ghosh, J. Liao, D. Marfatia, T. T. Yanagida, Breaking flavor democracy with symmetric perturbations, *Phys. Lett.* B785 (2018) 268–273. [arXiv:1805.05030](#), [doi:10.1016/j.physletb.2018.08.062](#).
- [961] Z.-g. Si, X.-h. Yang, S. Zhou, Broken  $S_{3L} \times S_{3R}$  Flavor Symmetry and Leptonic CP Violation, *Chin. Phys.* C41 (11) (2017) 113105. [arXiv:1706.03991](#), [doi:10.1088/1674-1137/41/11/113105](#).
- [962] R. N. Mohapatra, S. Nasri, H.-B. Yu,  $S(3)$  symmetry and tri-bimaximal mixing, *Phys. Lett.* B639 (2006) 318–321. [arXiv:hep-ph/0605020](#), [doi:10.1016/j.physletb.2006.06.032](#).
- [963] J. Kubo, A. Mondragon, M. Mondragon, E. Rodriguez-Jauregui, The Flavor symmetry, *Prog. Theor. Phys.* 109 (2003) 795–807, [Erratum: *Prog. Theor. Phys.* 114, 287 (2005)]. [arXiv:hep-ph/0302196](#), [doi:10.1143/PTP.109.795](#).
- [964] J. Kubo, H. Okada, F. Sakamaki, Higgs potential in minimal  $S(3)$  invariant extension of the standard model, *Phys. Rev.* D70 (2004) 036007. [arXiv:hep-ph/0402089](#), [doi:10.1103/PhysRevD.70.036007](#).
- [965] S.-L. Chen, M. Frigerio, E. Ma, Large neutrino mixing and normal mass hierarchy: A Discrete understanding, *Phys. Rev.* D70 (2004) 073008, [Erratum: *Phys. Rev.* D70, 079905 (2004)]. [arXiv:hep-ph/0404084](#),



- doi:10.1103/PhysRevD.70.079905, doi:10.1103/PhysRevD.70.073008.
- [966] W. Grimus, L. Lavoura,  $S(3) \times Z(2)$  model for neutrino mass matrices, JHEP 08 (2005) 013. [arXiv:hep-ph/0504153](#), doi:10.1088/1126-6708/2005/08/013.
- [967] Y. Koide, Permutation symmetry  $S(3)$  and VEV structure of flavor-triplet Higgs scalars, Phys. Rev. D73 (2006) 057901. [arXiv:hep-ph/0509214](#), doi:10.1103/PhysRevD.73.057901.
- [968] S. Morisi, M. Picariello, The Flavor physics in unified gauge theory from an  $S(3) \times P$  discrete symmetry, Int. J. Theor. Phys. 45 (2006) 1267–1277. [arXiv:hep-ph/0505113](#), doi:10.1007/s10773-006-9126-z.
- [969] S. Kaneko, H. Sawanaka, T. Shingai, M. Tanimoto, K. Yoshioka, Flavor Symmetry and Vacuum Aligned Mass Textures, Prog. Theor. Phys. 117 (2007) 161–181. [arXiv:hep-ph/0609220](#), doi:10.1143/PTP.117.161.
- [970] A. Mondragon, M. Mondragon, E. Peinado, Nearly tri-bimaximal mixing in the  $S(3)$  flavour symmetry, AIP Conf. Proc. 1026 (1) (2008) 164–169. [arXiv:0712.2488](#), doi:10.1063/1.2965040.
- [971] E. Ma, Non-Abelian discrete flavor symmetries [arXiv:0705.0327](#).
- [972] C. S. Lam, Mass Independent Textures and Symmetry, Phys. Rev. D74 (2006) 113004. [arXiv:hep-ph/0611017](#), doi:10.1103/PhysRevD.74.113004.
- [973] C. S. Lam, Symmetry of Lepton Mixing, Phys. Lett. B656 (2007) 193–198. [arXiv:0708.3665](#), doi:10.1016/j.physletb.2007.09.032.
- [974] C. S. Lam, The Unique Horizontal Symmetry of Leptons, Phys. Rev. D78 (2008) 073015. [arXiv:0809.1185](#), doi:10.1103/PhysRevD.78.073015.
- [975] T. Araki, J. Mei, Z.-z. Xing, Intrinsic Deviation from the Tri-bimaximal Neutrino Mixing in a Class of  $A_4$  Flavor Models, Phys. Lett. B695 (2011) 165–168. [arXiv:1010.3065](#), doi:10.1016/j.physletb.2010.10.061.
- [976] S. F. King, C. Luhn,  $A_4$  models of tri-bimaximal-reactor mixing, JHEP 03 (2012) 036. [arXiv:1112.1959](#), doi:10.1007/JHEP03(2012)036.
- [977] Y. BenTov, X.-G. He, A. Zee, An  $A_4 \times Z_4$  model for neutrino mixing, JHEP 12 (2012) 093. [arXiv:1208.1062](#), doi:10.1007/JHEP12(2012)093.
- [978] M.-C. Chen, J. Huang, J.-M. O’Bryan, A. M. Wijangco, F. Yu, Compatibility of  $\theta_{13}$  and the Type I Seesaw Model with  $A_4$  Symmetry, JHEP 02 (2013) 021. [arXiv:1210.6982](#), doi:10.1007/JHEP02(2013)021.
- [979] M. Holthausen, M. Lindner, M. A. Schmidt, Lepton flavor at the electroweak scale: A complete  $A_4$  model, Phys. Rev. D87 (3) (2013) 033006. [arXiv:1211.5143](#), doi:10.1103/PhysRevD.87.033006.
- [980] R. Gonzalez Felipe, H. Serodio, J. P. Silva, Neutrino masses and mixing in  $A_4$  models with three Higgs doublets, Phys. Rev. D88 (1) (2013) 015015. [arXiv:1304.3468](#), doi:10.1103/PhysRevD.88.015015.
- [981] A. Kadosh,  $\theta_{13}$  and charged Lepton Flavor Violation in ”warped”  $A_4$  models, JHEP 06 (2013) 114. [arXiv:1303.2645](#), doi:10.1007/JHEP06(2013)114.
- [982] Z.-h. Zhao, Minimal modifications to the Tri-Bimaximal neutrino mixing, JHEP 11 (2014) 143. [arXiv:1405.3022](#), doi:10.1007/JHEP11(2014)143.
- [983] S. Pramanick, A. Raychaudhuri,  $A_4$ -based seesaw model for realistic neutrino masses and mixing, Phys. Rev. D93 (3) (2016) 033007. [arXiv:1508.02330](#), doi:10.1103/PhysRevD.93.033007.
- [984] S. Pascoli, Y.-L. Zhou, The role of flavon cross couplings in leptonic flavour mixing, JHEP 06 (2016) 073. [arXiv:1604.00925](#), doi:10.1007/JHEP06(2016)073.
- [985] S. Pramanick, Ameliorating the popular lepton mixings with  $A_4$  symmetry: A seesaw model for realistic neutrino masses and mixing, Phys. Rev. D98 (7) (2018) 075016. [arXiv:1711.03510](#), doi:10.1103/PhysRevD.98.075016.
- [986] S. F. King, Y.-L. Zhou, Spontaneous breaking of  $SO(3)$  to finite family symmetries with supersymmetry - an  $A_4$  model, JHEP 11 (2018) 173. [arXiv:1809.10292](#), doi:10.1007/JHEP11(2018)173.
- [987] E. Ma, Neutrino mass matrix from  $S(4)$  symmetry, Phys. Lett. B632 (2006) 352–356. [arXiv:hep-ph/0508231](#), doi:10.1016/j.physletb.2005.10.019.
- [988] C. S. Lam, Magic neutrino mass matrix and the Bjorken-Harrison-Scott parameterization, Phys. Lett. B640 (2006) 260–262. [arXiv:hep-ph/0606220](#), doi:10.1016/j.physletb.2006.08.007.
- [989] T. Brown, S. Pakvasa, H. Sugawara, Y. Yamanaka, Neutrino Masses, Mixing and Oscillations in  $S(4)$  Model of Permutation Symmetry, Phys. Rev. D30 (1984) 255. doi:10.1103/PhysRevD.30.255.
- [990] D.-G. Lee, R. N. Mohapatra, An  $SO(10) \times S(4)$  scenario for naturally degenerate neutrinos, Phys. Lett. B329

- (1994) 463–468. [arXiv:hep-ph/9403201](#), [doi:10.1016/0370-2693\(94\)91091-X](#).
- [991] Y. Koide, S(4) flavor symmetry embedded into SU(3) and lepton masses and mixing, JHEP 08 (2007) 086. [arXiv:0705.2275](#), [doi:10.1088/1126-6708/2007/08/086](#).
- [992] G. Altarelli, F. Feruglio, L. Merlo, Revisiting Bimaximal Neutrino Mixing in a Model with S(4) Discrete Symmetry, JHEP 05 (2009) 020. [arXiv:0903.1940](#), [doi:10.1088/1126-6708/2009/05/020](#).
- [993] H. Ishimori, Y. Shimizu, M. Tanimoto, A. Watanabe, Neutrino masses and mixing from  $S_4$  flavor twisting, Phys. Rev. D83 (2011) 033004. [arXiv:1010.3805](#), [doi:10.1103/PhysRevD.83.033004](#).
- [994] Z.-h. Zhao, Realizing Tri-bimaximal Mixing in Minimal Seesaw Model with  $S_4$  Family Symmetry, Phys. Lett. B701 (2011) 609–613. [arXiv:1106.2715](#), [doi:10.1016/j.physletb.2011.06.050](#).
- [995] D. Meloni, Bimaximal mixing and large  $\theta_{13}$  in a SUSY SU(5) model based on  $S_4$ , JHEP 10 (2011) 010. [arXiv:1107.0221](#), [doi:10.1007/JHEP10\(2011\)010](#).
- [996] S. F. King, C. Luhn, Trimaximal neutrino mixing from vacuum alignment in  $A_4$  and  $S_4$  models, JHEP 09 (2011) 042. [arXiv:1107.5332](#), [doi:10.1007/JHEP09\(2011\)042](#).
- [997] F. Bazzocchi, L. Merlo, Neutrino Mixings and the  $S_4$  Discrete Flavour Symmetry, Fortsch. Phys. 61 (2013) 571–596. [arXiv:1205.5135](#), [doi:10.1002/prop.201200123](#).
- [998] Z.-h. Zhao, Understanding for flavor physics in the lepton sector, Phys. Rev. D86 (2012) 096010. [arXiv:1207.2545](#), [doi:10.1103/PhysRevD.86.096010](#).
- [999] R. Krishnan, P. F. Harrison, W. G. Scott, Simplest Neutrino Mixing from  $S_4$  Symmetry, JHEP 04 (2013) 087. [arXiv:1211.2000](#), [doi:10.1007/JHEP04\(2013\)087](#).
- [1000] C. Luhn, Trimaximal  $TM_1$  neutrino mixing in  $S_4$  with spontaneous CP violation, Nucl. Phys. B875 (2013) 80–100. [arXiv:1306.2358](#), [doi:10.1016/j.nuclphysb.2013.07.003](#).
- [1001] I. de Medeiros Varzielas, T. Neder, Y.-L. Zhou, Effective alignments as building blocks of flavor models, Phys. Rev. D97 (11) (2018) 115033. [arXiv:1711.05716](#), [doi:10.1103/PhysRevD.97.115033](#).
- [1002] I. De Medeiros Varzielas, M. Levy, Y.-L. Zhou, Effective alignments and the landscape of  $S_4$  flavour models, Phys. Rev. D100 (3) (2019) 035027. [arXiv:1903.10506](#), [doi:10.1103/PhysRevD.100.035027](#).
- [1003] F. Feruglio, C. Hagedorn, R. Ziegler, Lepton Mixing Parameters from Discrete and CP Symmetries, JHEP 07 (2013) 027. [arXiv:1211.5560](#), [doi:10.1007/JHEP07\(2013\)027](#).
- [1004] M. Holthausen, M. Lindner, M. A. Schmidt, CP and Discrete Flavour Symmetries, JHEP 04 (2013) 122. [arXiv:1211.6953](#), [doi:10.1007/JHEP04\(2013\)122](#).
- [1005] R. de Adelhart Toorop, F. Feruglio, C. Hagedorn, Finite Modular Groups and Lepton Mixing, Nucl. Phys. B858 (2012) 437–467. [arXiv:1112.1340](#), [doi:10.1016/j.nuclphysb.2012.01.017](#).
- [1006] M.-C. Chen, M. Fallbacher, K. T. Mahanthappa, M. Ratz, A. Trautner, CP Violation from Finite Groups, Nucl. Phys. B883 (2014) 267–305. [arXiv:1402.0507](#), [doi:10.1016/j.nuclphysb.2014.03.023](#).
- [1007] M. Gronau, A. Kfir, R. Loewy, Basis Independent Tests of CP Violation in Fermion Mass Matrices, Phys. Rev. Lett. 56 (1986) 1538. [doi:10.1103/PhysRevLett.56.1538](#).
- [1008] G. C. Branco, L. Lavoura, M. N. Rebelo, Majorana Neutrinos and CP Violation in the Leptonic Sector, Phys. Lett. B180 (1986) 264–268. [doi:10.1016/0370-2693\(86\)90307-2](#).
- [1009] T. Ohlsson, G. Seidl, A Flavor symmetry model for bilarge leptonic mixing and the lepton masses, Nucl. Phys. B643 (2002) 247–279. [arXiv:hep-ph/0206087](#), [doi:10.1016/S0550-3213\(02\)00689-2](#).
- [1010] G.-J. Ding, S. F. King, C. Luhn, A. J. Stuart, Spontaneous CP violation from vacuum alignment in  $S_4$  models of leptons, JHEP 05 (2013) 084. [arXiv:1303.6180](#), [doi:10.1007/JHEP05\(2013\)084](#).
- [1011] G.-J. Ding, S. F. King, A. J. Stuart, Generalised CP and  $A_4$  Family Symmetry, JHEP 12 (2013) 006. [arXiv:1307.4212](#), [doi:10.1007/JHEP12\(2013\)006](#).
- [1012] F. Feruglio, C. Hagedorn, R. Ziegler, A realistic pattern of lepton mixing and masses from  $S_4$  and CP, Eur. Phys. J. C74 (2014) 2753. [arXiv:1303.7178](#), [doi:10.1140/epjc/s10052-014-2753-2](#).
- [1013] C.-C. Li, G.-J. Ding, Generalised CP and trimaximal  $TM_1$  lepton mixing in  $S_4$  family symmetry, Nucl. Phys. B881 (2014) 206–232. [arXiv:1312.4401](#), [doi:10.1016/j.nuclphysb.2014.02.002](#).
- [1014] G.-J. Ding, Y.-L. Zhou, Predicting lepton flavor mixing from  $\Delta(48)$  and generalized CP symmetries, Chin. Phys. C39 (2) (2015) 021001. [arXiv:1312.5222](#), [doi:10.1088/1674-1137/39/2/021001](#).
- [1015] G.-J. Ding, Y.-L. Zhou, Lepton mixing parameters from  $\Delta(48)$  family symmetry and generalised CP, JHEP 06 (2014) 023. [arXiv:1404.0592](#), [doi:10.1007/JHEP06\(2014\)023](#).

- [1016] C.-C. Li, G.-J. Ding, Lepton Mixing in  $A_5$  Family Symmetry and Generalized CP, JHEP 05 (2015) 100. [arXiv:1503.03711](#), [doi:10.1007/JHEP05\(2015\)100](#).
- [1017] G. C. Branco, R. Gonzalez Felipe, F. R. Joaquim, H. Serodio, Spontaneous leptonic CP violation and nonzero  $\theta_{13}$ , Phys. Rev. D86 (2012) 076008. [arXiv:1203.2646](#), [doi:10.1103/PhysRevD.86.076008](#).
- [1018] Y. H. Ahn, S. K. Kang, C. S. Kim, Spontaneous CP Violation in  $A_4$  Flavor Symmetry and Leptogenesis, Phys. Rev. D87 (11) (2013) 113012. [arXiv:1304.0921](#), [doi:10.1103/PhysRevD.87.113012](#).
- [1019] S. Antusch, S. F. King, M. Spinrath, Spontaneous CP violation in  $A_4 \times SU(5)$  with Constrained Sequential Dominance 2, Phys. Rev. D87 (9) (2013) 096018. [arXiv:1301.6764](#), [doi:10.1103/PhysRevD.87.096018](#).
- [1020] B. Karmakar, A. Sil, Spontaneous CP violation in lepton-sector: A common origin for  $\theta_{13}$ , the Dirac CP phase, and leptogenesis, Phys. Rev. D93 (1) (2016) 013006. [arXiv:1509.07090](#), [doi:10.1103/PhysRevD.93.013006](#).
- [1021] T. Kobayashi, K. Tanaka, T. H. Tatsuishi, Neutrino mixing from finite modular groups, Phys. Rev. D98 (1) (2018) 016004. [arXiv:1803.10391](#), [doi:10.1103/PhysRevD.98.016004](#).
- [1022] T. Kobayashi, S. Nagamoto, S. Takada, S. Tamba, T. H. Tatsuishi, Modular symmetry and non-Abelian discrete flavor symmetries in string compactification, Phys. Rev. D97 (11) (2018) 116002. [arXiv:1804.06644](#), [doi:10.1103/PhysRevD.97.116002](#).
- [1023] S. Ferrara, D. Lust, A. D. Shapere, S. Theisen, Modular Invariance in Supersymmetric Field Theories, Phys. Lett. B225 (1989) 363. [doi:10.1016/0370-2693\(89\)90583-2](#).
- [1024] T. Kobayashi, N. Omoto, Y. Shimizu, K. Takagi, M. Tanimoto, T. H. Tatsuishi, Modular  $A_4$  invariance and neutrino mixing, JHEP 11 (2018) 196. [arXiv:1808.03012](#), [doi:10.1007/JHEP11\(2018\)196](#).
- [1025] P. P. Novichkov, S. T. Petcov, M. Tanimoto, Trimaximal Neutrino Mixing from Modular  $A_4$  Invariance with Residual Symmetries, Phys. Lett. B793 (2019) 247–258. [arXiv:1812.11289](#), [doi:10.1016/j.physletb.2019.04.043](#).
- [1026] T. Kobayashi, Y. Shimizu, K. Takagi, M. Tanimoto, T. H. Tatsuishi, New  $A_4$  lepton flavor model from  $S_4$  modular symmetry [arXiv:1907.09141](#).
- [1027] G.-J. Ding, S. F. King, X.-G. Liu, Modular  $A_4$  Symmetry Models of Neutrinos and Charged Leptons [arXiv:1907.11714](#).
- [1028] T. Kobayashi, Y. Shimizu, K. Takagi, M. Tanimoto, T. H. Tatsuishi,  $A_4$  lepton flavor model and modulus stabilization from  $S_4$  modular symmetry [arXiv:1909.05139](#).
- [1029] T. Asaka, Y. Heo, T. H. Tatsuishi, T. Yoshida, Modular  $A_4$  invariance and leptogenesis [arXiv:1909.06520](#).
- [1030] J. T. Penedo, S. T. Petcov, Lepton Masses and Mixing from Modular  $S_4$  Symmetry, Nucl. Phys. B939 (2019) 292–307. [arXiv:1806.11040](#), [doi:10.1016/j.nuclphysb.2018.12.016](#).
- [1031] P. P. Novichkov, J. T. Penedo, S. T. Petcov, A. V. Titov, Modular  $S_4$  models of lepton masses and mixing, JHEP 04 (2019) 005. [arXiv:1811.04933](#), [doi:10.1007/JHEP04\(2019\)005](#).
- [1032] I. De Medeiros Varzielas, S. F. King, Y.-L. Zhou, Multiple modular symmetries as the origin of flavour [arXiv:1906.02208](#).
- [1033] S. F. King, Y.-L. Zhou, Trimaximal  $TM_1$  mixing with two modular  $S_4$  groups [arXiv:1908.02770](#).
- [1034] P. P. Novichkov, J. T. Penedo, S. T. Petcov, A. V. Titov, Generalised CP Symmetry in Modular-Invariant Models of Flavour, JHEP 07 (2019) 165. [arXiv:1905.11970](#), [doi:10.1007/JHEP07\(2019\)165](#).
- [1035] A. Baur, H. P. Nilles, A. Trautner, P. K. S. Vaudrevange, Unification of Flavor, CP, and Modular Symmetries, Phys. Lett. B795 (2019) 7–14. [arXiv:1901.03251](#), [doi:10.1016/j.physletb.2019.03.066](#).
- [1036] P. P. Novichkov, J. T. Penedo, S. T. Petcov, A. V. Titov, Modular  $A_5$  symmetry for flavour model building, JHEP 04 (2019) 174. [arXiv:1812.02158](#), [doi:10.1007/JHEP04\(2019\)174](#).
- [1037] G.-J. Ding, S. F. King, X.-G. Liu, Neutrino Mass and Mixing with  $A_5$  Modular Symmetry [arXiv:1903.12588](#).
- [1038] M.-C. Chen, S. Ramos-Sanchez, M. Ratz, A note on the predictions of models with modular flavor symmetries [arXiv:1909.06910](#).
- [1039] E. Witten, Symmetry and Emergence, Nature Phys. 14 (2018) 116–119. [arXiv:1710.01791](#), [doi:10.1038/nphys4348](#).