

Active Learning for Chinese Word Segmentation in Medical Text

Tingting Cai¹, Yangming Zhou¹, Zhiyuan Ma¹, Hong Zheng^{1,*}, Lingfei Zhang¹, Ping He^{2,*} and Ju Gao³

¹School of Information Science and Engineering, East China University of Science and Technology, Shanghai 200237, China

²Shanghai Hospital Development Center, Shanghai 200041, China

³Shuguang Hospital Affiliated to Shanghai University of Traditional Chinese Medicine, Shanghai 200021, China

*Corresponding authors

Emails: zhenghong@ecust.edu.cn, heping@shdc.org.cn

Abstract—Electronic health records (EHRs) stored in hospital information systems completely reflect the patients’ diagnosis and treatment processes, which are essential to clinical data mining. Chinese word segmentation (CWS) is a fundamental and important task for Chinese natural language processing. Currently, most state-of-the-art CWS methods greatly depend on large-scale manually-annotated data, which is a very time-consuming and expensive work, specially for the annotation in medical field. In this paper, we present an active learning method for CWS in medical text. To effectively utilize complete segmentation history, a new scoring model in sampling strategy is proposed, which combines information entropy with neural network. Besides, to capture interactions between adjacent characters, K-means clustering features are additionally added in word segmenter. We experimentally evaluate our proposed CWS method in medical text, experimental results based on EHRs collected from the Shuguang Hospital Affiliated to Shanghai University of Traditional Chinese Medicine show that our proposed method outperforms other reference methods, which can effectively save the cost of manual annotation.

Index Terms—Chinese word segmentation, Active learning, Deep learning, Electronic health records.

I. INTRODUCTION

Electronic health records (EHRs) systematically collect patients’ clinical information, such as health profiles, histories of present illness, past medical histories, examination results and treatment plans [1]. By analyzing EHRs, many useful information, closely related to patients, can be discovered [2]. Since Chinese EHRs are recorded without explicit word delimiters (e.g., “糖尿病酮症酸中毒” (diabetic ketoacidosis)), Chinese word segmentation (CWS) is a prerequisite for processing EHRs. Currently, state-of-the-art CWS methods usually require large amounts of manually-labeled data to reach their full potential. However, there are many challenges inherent in labeling EHRs. First, EHRs have many medical terminologies, such as “高血压性心脏病” (hypertensive heart disease) and “罗氏芬” (Rocephin), so only annotators with medical backgrounds can be qualified to label EHRs. Second, EHRs may involve personal privacies of patients. Therefore, they cannot be openly published on a large scale for labeling. The above two problems lead to the high annotation cost and insufficient training corpus in the research of CWS in medical text.

CWS was usually formulated as a sequence labeling task [3], which can be solved by supervised learning approaches, such as hidden markov model (HMM) [4] and conditional random field (CRF) [5]. However, these methods rely heavily on handcrafted features. To relieve the efforts of feature engineering, neural network-based methods are beginning to thrive [6]–[8]. However, due to insufficient annotated training data, conventional models for CWS trained on open corpus often suffer from significant performance degradation when transferred to a domain-specific text. Moreover, the task in medical domain is rarely dabbled, and only one related work on transfer learning is found in recent literatures [9]. However, researches related to transfer learning mostly remain in general domains, causing a major problem that a considerable amount of manually annotated data is required, when introducing the models into specific domains.

One of the solutions for this obstacle is to use active learning, where only a small scale of samples are selected and labeled in an active manner. Active learning methods are favored by the researchers in many natural language processing (NLP) tasks, such as text classification [10] and named entity recognition (NER) [11]. However, only a handful of works are conducted on CWS [3], and few focuses on medical domain tasks.

Given the aforementioned challenges and current researches, we propose a word segmentation method based on active learning. To model the segmentation history, we incorporate a sampling strategy consisting of word score, link score and sequence score, which effectively evaluates the segmentation decisions. Specifically, we combine information branch and gated neural network to determine if the segment is a legal word, i.e., word score. Meanwhile, we use the hidden layer output of the long short-term memory (LSTM) [12] to find out how the word is linked to its surroundings, i.e., link score. The final decision on the selection of labeling samples is made by calculating the average of word and link scores on the whole segmented sentence, i.e., sequence score. Besides, to capture coherence over characters, we additionally add K-means clustering features to the input of CRF-based word segmenter.

To sum up, the main contributions of our work are summa-

rized as follows:

- We propose a novel word segmentation method incorporating active learning and hybrid features. The former lightens the burden of labeling large amounts of data, and the latter combines K-means feature with CRF-based word segmenter to achieve better representations of the coherence between adjacent characters.
- To improve the proposed active learning method, we propose a sampling strategy based on a scoring model. Instead of solely relying on the uncertainty of classifying boundary to choose the most representative samples for labeling, our proposed method utilizes information entropy to estimate the probability of a string being a word at statistical level. Moreover, we also employ recurrent neural network (RNN) [13] to simulate human understanding of words from the deep learning level.
- Instead of evaluating the performance in simulated data, we use cardiovascular diseases data collected from the Shuguang Hospital Affiliated to Shanghai University of Traditional Chinese Medicine to illustrate the improvements of the proposed method. Experimental results show that our method achieves the highest F_1 -score of 90.62% when the relabeled samples accounts for 2% of the unlabeled set, outperforming the performance of mainstream uncertainty sampling strategy.

The rest of this paper is organized as follows. Section II briefly reviews the related work on CWS and active learning. Section III presents an active learning method for CWS. We experimentally evaluate our proposed method in Section IV. Finally, Section V concludes the paper and envisions on future work.

II. RELATED WORK

A. Chinese Word Segmentation

In past decades, researches on CWS have a long history and various methods have been proposed [14]–[16], which is an important task for Chinese NLP [8]. These methods are mainly focus on two categories: supervised learning and deep learning [3].

Supervised Learning Methods. Initially, supervised learning methods were widely-used in CWS. Xue [14] employed a maximum entropy tagger to automatically assign Chinese characters. Zhao et al. [17] used a conditional random field for tag decoding and considered both feature template selection and tag set selection. However, these methods greatly rely on manual feature engineering [18], while handcrafted features are difficult to design, and the size of these features is usually very large [7].

Deep Learning Methods. Recently, neural networks have been applied in CWS tasks. To name a few, Zheng et al. [15] used deep layers of neural networks to learn feature representations of characters. Chen et al. [7] adopted LSTM to capture the previous important information. Chen et al. [19] proposed a gated recursive neural network (GRNN), which contains reset and update gates to incorporate the complicated combinations

of characters. Jiang and Tang [20] proposed a sequence-to-sequence transformer model to avoid overfitting and capture character information at the distant site of a sentence. Yang et al. [21] investigated subword information for CWS and integrated subword embeddings into a Lattice LSTM (LaLSTM) network. However, general word segmentation models do not work well in specific field due to lack of annotated training data.

Currently, a handful of domain-specific CWS approaches have been studied, but they focused on decentralized domains. In the metallurgical field, Shao et al. [16] proposed a domain-specific CWS method based on Bi-LSTM model. In the medical field, Xing et al. [9] proposed an adaptive multi-task transfer learning framework to fully leverage domain-invariant knowledge from high resource domain to medical domain. Meanwhile, transfer learning still greatly focuses on the corpus in general domain. When it comes to the specific domain, large amounts of manually-annotated data is necessary. Active learning can solve this problem to a certain extent. However, due to the challenges faced by performing active learning on CWS, only a few studies have been conducted. On judgements, Yan et al. [22] adopted the local annotation strategy, which selects substrings around the informative characters in active learning. However, their method still stays at the statistical level. Unlike the above method, we propose an active learning approach for CWS in medical text, which combines information entropy with neural network to effectively reduce annotation cost.

B. Active Learning

Active learning [23] mainly aims to ease the data collection process by automatically deciding which instances should be labeled by annotators to train a model as quickly and effectively as possible [24]. The sampling strategy plays a key role in active learning. In the past decade, the rapid development of active learning has resulted in various sampling strategies, such as uncertainty sampling [25], query-by-committee [26] and information gain [27]. Currently, the most mainstream sampling strategy is uncertainty sampling. It focuses its selection on samples closest to the decision boundary of the classifier and then chooses these samples for annotators to relabel [28].

The formal definition of uncertainty sampling is to select a sample x^* that maximizes the entropy H over the probability of predicted classes:

$$x^* = \arg \max_{x_i \in U} H[p_t(y_i = y|x_i)] \quad (1)$$

where x_i is a multi-dimensional feature vector, $y_i \in \{0, 1\}$ is its binary label, and $p_t(y_i = y|x_i)$ is the predicted probability, through which a classifier trained on training sets can map features to labels. However, in some complicated tasks, such as CWS and NER, only considering the uncertainty of classifier is obviously not enough.

III. ACTIVE LEARNING FOR CHINESE WORD SEGMENTATION

Active learning methods can generally be described into two parts: a learning engine and a selection engine [29]. The learning engine is essentially a classifier, which is mainly used for training of classification problems. The selection engine is based on the sampling strategy, which chooses samples that need to be relabeled by annotators from unlabeled data. Then, relabeled samples are added to training set for classifier to re-train, thus continuously improving the accuracy of the classifier. In this paper, a CRF-based segmenter and a scoring model are employed as learning engine and selection engine, respectively.

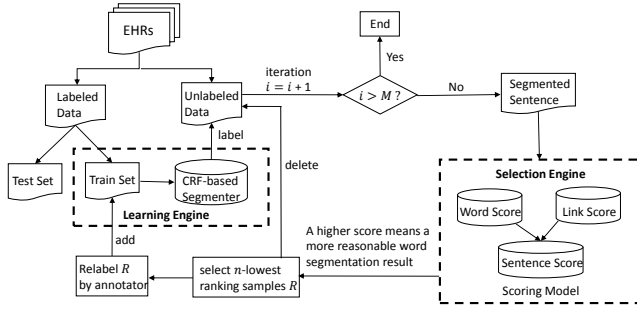

Fig. 1. The diagram of active learning for the Chinese word segmentation.

Fig. 1 and Algorithm 1 demonstrate the procedure of CWS based on active learning. First, we train a CRF-based segmenter by train set. Then, the segmenter is employed to annotate the unlabeled set roughly. Subsequently, information entropy based scoring model picks n -lowest ranking samples for annotators to relabel. Meanwhile, the train sets and unlabeled sets are updated. Finally, we re-train the segmenter. The above steps iterate until the desired accuracy is achieved or the number of iterations has reached a predefined threshold.

A. CRF-based Word Segmenter

CWS can be formalized as a sequence labeling problem with character position tags, which are ('B', 'M', 'E', 'S'). So, we convert the labeled data into the 'BMES' format, in which each character in the sequence is assigned into a label as follows one by one: B=beginning of a word, M=middle of a word, E=end of a word and S=single word.

In this paper, we use CRF as a training model for CWS task. Given the observed sequence, CRF has a single exponential model for the joint probability of the entire sequence of labels, while maximum entropy markov model (MEMM) [30] uses per-state exponential models for the conditional probabilities of next states [5]. Therefore, it can solve the label bias problem effectively. Compared with neural networks, it has less dependency on the corpus size.

First, we pre-process EHRs at the character-level, separating each character of raw EHRs. For instance, given a sentence $L = [C_0 C_1 C_2 \dots C_{n-1} C_n]$, where C_i represents the i -th character, the separated form is $L_s = [C_0, C_1, C_2, \dots, C_{n-1}, C_n]$.

Algorithm 1: Active Learning for Chinese Word Segmentation

Input: labeled data L , unlabeled data U , the number of iterations M , the number of samples selected per iteration n , partitioning function $Split$, size τ

Output: a word segmentation model f^* with the smallest test set loss l_{min}

```

1 begin
2   Initialize:  $Train_\tau, Test_\tau \leftarrow Split(L, \tau)$ 
3   train a word segmenter  $f_\tau$ 
4   estimate the test set loss  $l_\tau$ 
5   label  $U$  by  $f_\tau$ 
6   for  $i = 1$  to  $M$  do
7     for  $Sentence \in U$  do
8       compute  $Score_{Sentence}$  by branch
9         information entropy based scoring model
10    end
11    select  $n$ -lowest ranking samples  $R$ 
12    relabel  $R$  by annotators
13    form a new labeled dataset
14       $Train_R \leftarrow Train_\tau \cup \{R\}$ 
15    form a new unlabeled dataset  $U_R \leftarrow U_\tau \setminus \{R\}$ 
16    train a word segmenter  $f_R$ 
17    estimate the new test loss  $l_R$ 
18    compute the loss reduction  $\delta_R \leftarrow l_R - l_\tau$ 
19    if  $\delta_R < 0$  then
20       $l_{min} \leftarrow l_R$ 
21    end
22    else
23       $l_{min} \leftarrow l_\tau$ 
24    end
25  end
26   $f^* \leftarrow f$  with the smallest test set loss  $l_{min}$ 
27  return  $f^*$ 

```

Then, we employ Word2Vec [31] to train pre-processed EHRs to get character embeddings. To capture interactions between adjacent characters, K-means clustering algorithm [32] is utilized to feature the coherence over characters. In general, K-means divides n EHR characters into k groups of clusters and the similarity of EHR characters in the same cluster is higher. With each iteration, K-means can classify EHR characters into the nearest cluster based on distance to the mean vector. Then, recalculating and adjusting the mean vectors of these clusters until the mean vector converges. K-means features explicitly show the difference between two adjacent characters and even multiple characters. Finally, we additionally add K-means clustering features to the input of CRF-based segmenter. The segmenter makes positional tagging decisions over individual characters. For example, a Chinese segmented sentence “病人/长期/于/我院/肾病科/住院/治疗/。” (The patient was hospitalized for a long time in the nephrology department of our hospital.) is labeled as ‘BEBESBEBMEBEBES’.

B. Information Entropy Based Scoring Model

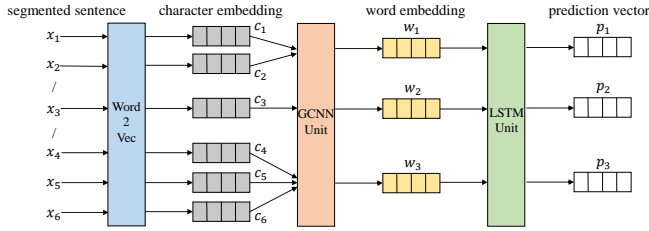

Fig. 2. The architecture of the information entropy based scoring model, where ‘/’ represents candidate word separator, x_i represents the one-hot encoding of the i -th character, c_j represents the j -th character embedding learned by Word2Vec, w_m represents the distributed representation of the m -th candidate word and p_n represents the prediction of the $(n+1)$ -th candidate word.

To select the most appropriate sentences in a large number of unlabeled corpora, we propose a scoring model based on information entropy and neural network as the sampling strategy of active learning, which is inspired by Cai and Zhao [33]. The score of a segmented sentence is computed as follows. First, mapping the segmented sentence to a sequence of candidate word embeddings. Then, the scoring model takes the word embedding sequence as input, scoring over each individual candidate word from two perspectives: (1) the possibility that the candidate word itself can be regarded as a legal word; (2) the rationality of the link that the candidate word directly follows previous segmentation history. Fig. 2 illustrates the entire scoring model. A gated neural network is employed over character embeddings to generate distributed representations of candidate words, which are sent to a LSTM model.

1) *Word Score*: We use gated neural network and information entropy to capture the likelihood of the segment being a legal word. The architecture of word score model is depicted in Fig. 3.

Gated Combination Neural Network (GCNN) To effectively learn word representations through character embeddings, we use GCNN [33]. The architecture of GCNN is demonstrated in Fig. 4, which includes update gate and reset gate. The gated mechanism not only captures the characteristics of the characters themselves, but also utilizes the interaction between the characters. There are two types of gates in this network structure: reset gates and update gates. These two gated vectors determine the final output of the gated recurrent neural network, where the update gate helps the model determine what to be passed, and the reset gate primarily helps the model decide what to be cleared. In particular, the word embedding of a word with n characters can be computed as:

$$w = z_N \odot \hat{w} + \sum_{i=1}^n z_i \odot c_i \quad (2)$$

where z_N and z_i are update gates for new combination vector \hat{w} and the i -th character c_i respectively, the combination vector

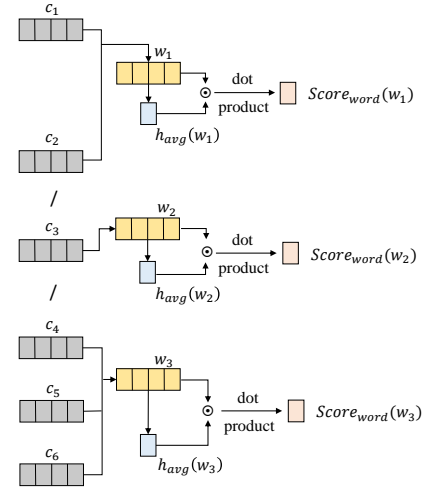

Fig. 3. The architecture of word score, where ‘/’ represents candidate word separator, c_i represents the i -th character embedding, w_j represents the j -th candidate word embedding and $Score_{Word}(w_k)$ represents the word score of the k -th candidate word.

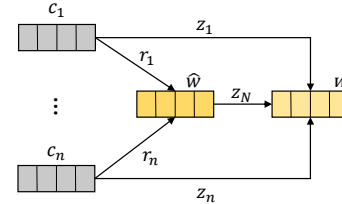

Fig. 4. The architecture of GCNN.

\hat{w} is formalized as:

$$\hat{w} = \tan \left(W^{(n)} \begin{bmatrix} r_1 \odot c_1 \\ \vdots \odot \vdots \\ r_n \odot c_n \end{bmatrix} \right) \quad (3)$$

where $W^{(n)}$ and r_i are reset gates for characters.

Left and Right Branch Information Entropy In general, each string in a sentence may be a word. However, compared with a string which is not a word, the string of a word is significantly more independent. The branch information entropy is usually used to judge whether each character in a string is tightly linked through the statistical characteristics of the string, which reflects the likelihood of a string being a word. The left and right branch information entropy can be formalized as follows:

$$h_L(w_i) = - \sum_{a \in V} p(aw_i|w_i) \cdot \log_2 p(aw_i|w_i) \quad (4)$$

$$h_R(w_i) = - \sum_{b \in V} p(w_ib|w_i) \cdot \log_2 p(w_ib|w_i) \quad (5)$$

where w_i denotes the i -th candidate word, V denotes the character set, $p(aw_i|w_i)$ denotes the probability that character

a is on the left of word w_i and $p(w_i b | w_i)$ denotes the probability that character b is on the right of word w_i . $h_L(w_i)$ and $h_R(w_i)$ respectively represent the left and right branch information entropy of the candidate word w_i . If the left and right branch information entropy of a candidate word is relatively high, the probability that the candidate word can be combined with the surrounded characters to form a word is low, thus the candidate word is likely to be a legal word.

To judge whether the candidate words in a segmented sentence are legal words, we compute the left and right entropy of each candidate word, then take average as the measurement standard:

$$h_{avg}(w_i) = \frac{h_L(w_i) + h_R(w_i)}{2} \quad (6)$$

We represent a segmented sentence with n candidate words as $[w_1, w_2, \dots, w_n]$, so the $Score_{word}(w_i)$ of the i -th candidate word is computed by its average entropy:

$$Score_{word}(w_i) = h_{avg}(w_i) \odot w_i \quad (7)$$

2) *Link Score*: In this paper, we use LSTM to capture the coherence between words in a segmented sentence. This neural network is mainly an optimization for traditional RNN. RNN is widely used to deal with time-series prediction problems. The result of its current hidden layer is determined by the input of the current layer and the output of the previous hidden layer [34]. Therefore, RNN can remember historical results. However, traditional RNN has problems of vanishing gradient and exploding gradient when training long sequences [35]. By adding a gated mechanism to RNN, LSTM effectively solves these problems, which motivates us to get the link score with LSTM. Formally, the LSTM unit performs the following operations at time step t :

$$f_t = \sigma_g(W_f x_t + U_f h_{t-1} + b_f) \quad (8)$$

$$i_t = \sigma_g(W_i x_t + U_i h_{t-1} + b_i) \quad (9)$$

$$o_t = \sigma_g(W_o x_t + U_o h_{t-1} + b_o) \quad (10)$$

$$c_t = c_{t-1} \odot f_t + i_t \odot \sigma_c(W_c x_t + U_c h_{t-1} + b_c) \quad (11)$$

$$h_t = \sigma_h(c_t) \odot o_t \quad (12)$$

where $x_t, c_{t-1}, h_{(t-1)}$ are the inputs of LSTM, all W_* and U_* are a set of parameter matrices to be trained, and b_* is a set of bias parameter matrices to be trained. \odot and σ operation respectively represent matrix element-wise multiplication and sigmoid function. In the LSTM unit, there are two hidden layers (h_t, c_t), where c_t is the internal memory cell for dealing with vanishing gradient, while h_t is the main output of the LSTM unit for complex operations in subsequent layers.

We denotes w_t as the word embedding of time step t , a prediction p_{t+1} of next word embedding w_{t+1} can be computed by hidden layer h_t :

$$p_{t+1} = \tanh(W_p h_t + h_p) \quad (13)$$

Therefore, link score of next word embedding $y_{(t+1)}$ can be computed as:

$$Score_{link}(w_{t+1}) = p_{t+1} \cdot w_{t+1} \quad (14)$$

Due to the structure of LSTM, vector $p_{(t+1)}$ contains important information of entire segmentation decisions. In this way, the link score gets the result of the sequence-level word segmentation, not just word-level.

3) *Sequence Score*: Intuitively, we can compute the score of a segmented sequence by summing up word scores and link scores. However, we find that a sequence with more candidate words tends to have higher sequence scores. Therefore, to alleviate the impact of the number of candidate words on sequence scores, we calculate final scores as follows:

$$Score_{seq}(y_i) = \frac{1}{n} \sum_{t=1}^n [Score_{word}(w_i) + Score_{link}(w_i)] \quad (15)$$

where y_i denotes the i -th segmented sequence with n candidate words, and w_t represents the t -th candidate words in the segmented sequence.

When training the model, we seek to minimize the sequence score of the corrected segmented sentence and the predicted segmented sentence.

$$L = \sum_{i=1}^n [Score_{seq}(\hat{y}_i) - Score_{seq}(y_i)]^2 \quad (16)$$

where L is the loss function.

IV. EXPERIMENTAL STUDIES

A. Datasets

We collect 204 EHRs with cardiovascular diseases from the Shuguang Hospital Affiliated to Shanghai University of Traditional Chinese Medicine and each contains 27 types of records. We choose 4 different types with a total of 3868 records from them, which are first course reports, medical records, chief ward round records and discharge records. The detailed information of EHRs are listed in Table I.

TABLE I
DETAILED INFORMATION OF EHRs

Types	Count	Content
first course reports	957	admission date, history of present illness
medical records	992	chief complaints, physical examination
chief ward round records	952	general, heart rate, laboratory findings
discharged records	967	treatment plans, date of discharge

We split our datasets as follows. First, we randomly select 3200 records from 3868 records as unlabeled set. Then, we manually annotate remaining 668 records as labeled set, which contains 1170 sentences. Finally, we divide labeled set into train set and test set with the ratio of 7:3 randomly. Statistics of datasets are listed in Table II.

TABLE II
STATISTICS OF DATASETS

Datasets	Sentences	Words	Characters
Train set	819	17995	37935
Test set	351	6331	13557
Unlabeled set	6078	/	269220

B. Parameter Settings

To determine suitable parameters, we divide training set into two sets, the first 80% sentences as training set and the rest 20% sentences as validation set.

1) *CRF-based Word Segmenter*: Character embedding dimensions and K-means clusters are two main parameters in the CRF-based word segmenter.

In this paper, we choose character-based CRF without any features as baseline. First, we use Word2Vec to train character embeddings with dimensions of ['50', '100', '150', '200', '300', '400'] respectively, thus we obtain 6 different dimensional character embeddings. Second, these six types of character embeddings are used as the input to K-means algorithm with the number of clusters ['50', '100', '200', '300', '400', '500', '600'] respectively to capture the corresponding features of character embeddings. Then, we add K-means clustering features to baseline for training. As can be seen from Fig. 5, when the character embedding dimension $d = 150$ and the number of clusters $k = 400$, CRF-based word segmenter performs best, so these two parameters are used in subsequent experiments.

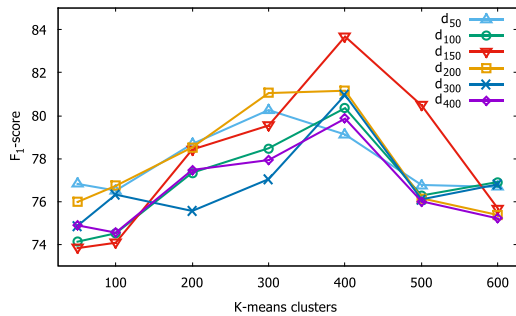

Fig. 5. The relation between F_1 -score and K-means class with different character embedding dimensions.

2) *Scoring Model*: Hyper-parameters of neural network have a great impact on the performance. The hyper-parameters we choose are listed in Table III. The dimension of character embeddings is set as same as the parameter used in CRF-based

TABLE III
HYPER-PARAMETER SETTING.

Hyper-parameters	Setting
Character embedding dimension	$d = 150$
Hidden unit number	$h = 150$
Dropout rate	$p = 0.2$
Maximum word length	$w = 6$

word segmenter and the number of hidden units is also set to be the same as it. Maximum word length is related to the number of parameters in GCNN unit. Since there are many long medical terminologies in EHRs, we set the maximum word length as 6. In addition, dropout is an effective way to prevent neural networks from overfitting [36]. To avoid overfitting, we drop the input layer of the scoring model with the rate of 20%.

C. Experimental Results

1) *Comparisons of Word Segmentation Tools*: Our work experimentally compares two mainstream CWS tools (LTP and Jieba) on training and testing sets. These two tools are widely used and recognized due to their high F_1 -score of word segmentation in general fields. However, in specific fields, there are many terminologies and uncommon words, which lead to the unsatisfactory performance of segmentation results. To solve the problem of word segmentation in specific fields, these two tools provide a custom dictionary for users. In the experiments, we also conduct a comparative experiment on whether external domain dictionary has an effect on the experimental results. We manually construct the dictionary when labeling EHRs. From the results in Table IV, we find that

TABLE IV
EXPERIMENTAL RESULTS WITH DIFFERENT WORD SEGMENTATION TOOLS.

Word segmentation tools	Precision	Recall	F_1 -score
LTP	74.72	73.40	74.05
LTP + Dic	76.37	72.13	74.18
Jieba	78.73	75.32	76.99
Jieba + Dic	80.05	77.44	78.72

Jieba benefits a lot from the external dictionary. However, the Recall of LTP decreases when joining the domain dictionary. Generally speaking, since these two tools are trained by general domain corpus, the results are not ideal enough to cater to the needs of subsequent NLP of EHRs when applied to specific fields.

2) *Effectiveness of K-means Features in CRF-based Segmenter*: To investigate the effectiveness of K-means features in CRF-based segmenter, we also compare K-means with 3 different clustering features, including MeanShift [37], SpectralClustering [38] and DBSCAN [39] on training and testing sets. From the results in Table V, by adding additional clustering features in CRF-based segmenter, there is a significant improvement of F_1 -score, which indicates that clustering

features can effectively capture the semantic coherence between characters. Among these clustering features, K-means performs best, so we utilize K-means results as additional features for CRF-based segmenter.

TABLE V
COMPARISON WITH DIFFERENT CLUSTERING FEATURES.

Model + feature	Precision	Recall	F_1 -score
CRF	79.26	81.57	80.40
CRF + MeanShift	79.45	82.04	80.72
CRF + SpectralClustering	81.14	81.48	81.31
CRF + DBSCAN	82.46	82.97	82.71
CRF + Kmeans	83.76	83.85	83.80

3) *Comparisons between Two Sampling Strategies:* In this experiment, since uncertainty sampling is the most popular strategy in real applications for its simpleness and effectiveness [28], we compare our proposed strategy with uncertainty sampling in active learning. We conduct our experiments as follows. First, we employ CRF-based segmenter to annotate the unlabeled set. Then, sampling strategy in active learning selects a part of samples for annotators to relabel. Finally, the relabeled samples are added to train set for segmenter to re-train. Our proposed scoring strategy selects samples according to the sequence scores of the segmented sentences, while uncertainty sampling suggests relabeling samples that are closest to the segmenter’s decision boundary.

Generally, two main parameters in active learning are the numbers of iterations and samples selected per iteration. To fairly investigate the influence of two parameters, we compare our proposed strategy with uncertainty sampling on the same parameter. We find that though the number of iterations is large enough, it has a limited impact on the performance of segmenter. Therefore, we choose 30 as the number of iterations, which is a good trade-off between speed and performance. As for the number of samples selected per iteration, there are 6078 sentences in unlabeled set, considering the high cost of relabeling, we set four sizes of samples selected per iteration, which are 2%, 5%, 8% and 11%.

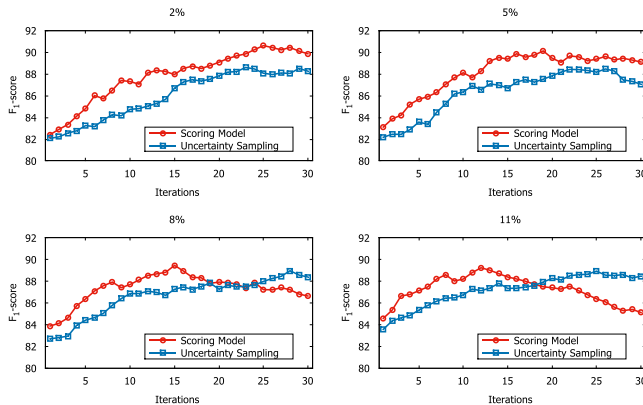

Fig. 6. The results of two sampling strategies with different relabeled sample sizes.

The experimental results of two sampling strategies with 30 iterations on four different proportions of relabeled data are shown in Fig. 6, where x-axis represents the number of iterations and y-axis denotes the F_1 -score of the segmenter. Scoring strategy shows consistent improvements over uncertainty sampling in the early iterations, indicating that scoring strategy is more capable of selecting representative samples.

Furthermore, we also investigate the relations between the best F_1 -score and corresponding number of iteration on two sampling strategies, which is depicted in Fig. 7. It is observed

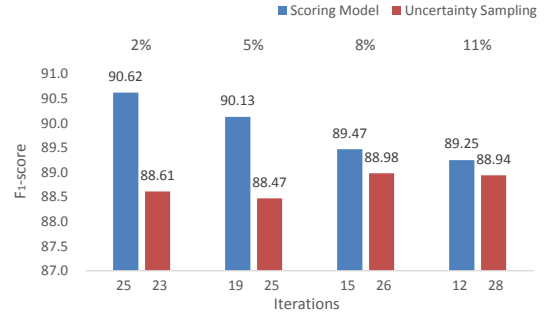

Fig. 7. The relations between the best F_1 -score and corresponding iteration on two sampling strategies with different relabeled sample sizes.

that in our proposed scoring model, with the proportion of relabeled data increasing, the iteration number of reaching the optimal word segmentation result is decreasing, but the F_1 -score of CRF-based word segmenter is also gradually decreasing. When the proportion is 2%, the segmenter reaches the highest F_1 -score: 90.62%. Obviously, our proposed strategy outperforms uncertainty sampling by a large margin. Our proposed method needs only 2% relabeled samples to obtain F_1 -score of 90.62%, while uncertainty sampling requires 8% samples to reach its best F_1 -score of 88.98%, which indicates that with our proposed method, we only need to manually relabel a small number of samples to achieve a desired segmentation result.

V. CONCLUSION AND FUTURE WORK

To relieve the efforts of EHRs annotation, we propose an effective word segmentation method based on active learning, in which the sampling strategy is a scoring model combining information entropy with neural network. Compared with the mainstream uncertainty sampling, our strategy selects samples from statistical perspective and deep learning level. In addition, to capture coherence between characters, we add K-means clustering features to CRF-based word segmenter. Based on EHRs collected from the Shuguang Hospital Affiliated to Shanghai University of Traditional Chinese Medicine, we evaluate our method on CWS task. Compared with uncertainty sampling, our method requires 6% less relabeled samples to achieve better performance, which proves that our method can save the cost of manual annotation to a certain extent.

In future, we plan to employ other widely-used deep neural networks, such as convolutional neural network and attention

mechanism, in the research of EHRs segmentation. Then, we believe that our method can be applied to other tasks as well, so we will fully investigate the application of our method in other tasks, such as NER and relation extraction.

ACKNOWLEDGMENT

The authors would like to appreciate any suggestions or comments from the anonymous reviewers. This work was supported by the National Natural Science Foundation of China (No. 61772201) and the National Key R&D Program of China for "Precision medical research" (No. 2018YFC0910550).

REFERENCES

- [1] J. M. Gesulga, A. Berjame, K. S. Moquiala, and A. Galido, "Barriers to electronic health record system implementation and information systems resources: A structured review," *Procedia Computer Science*, vol. 124, pp. 544–551, 2017.
- [2] J. Yang, Q. Yu, Y. Guan, and Z. Jiang, "An overview of research on electronic medical record oriented named entity recognition and entity relation extraction," *Acta Automatica Sinica*, vol. 40, no. 8, pp. 1537–1562, 2014.
- [3] S. Li, G. Zhou, and C.-R. Huang, "Active learning for chinese word segmentation," in *Proceedings of International Conference on Computational Linguistics 2012: Posters*, 2012, pp. 683–692.
- [4] S. R. Eddy, "Profile hidden markov models," *Bioinformatics (Oxford, England)*, vol. 14, no. 9, pp. 755–763, 1998.
- [5] J. Lafferty, A. McCallum, and F. C. Pereira, "Conditional random fields: Probabilistic models for segmenting and labeling sequence data," 2001.
- [6] R. Collobert, J. Weston, L. Bottou, M. Karlen, K. Kavukcuoglu, and P. Kuksa, "Natural language processing (almost) from scratch," *Journal of Machine Learning Research*, vol. 12, no. Aug, pp. 2493–2537, 2011.
- [7] X. Chen, X. Qiu, C. Zhu, P. Liu, and X. Huang, "Long short-term memory neural networks for chinese word segmentation," in *Proceedings of the 2015 Conference on Empirical Methods in Natural Language Processing*, 2015, pp. 1197–1206.
- [8] J. Liu, F. Wu, C. Wu, Y. Huang, and X. Xie, "Neural chinese word segmentation with dictionary," *Neurocomputing*, vol. 338, pp. 46–54, 2019.
- [9] J. Xing, K. Zhu, and S. Zhang, "Adaptive multi-task transfer learning for chinese word segmentation in medical text," in *Proceedings of the 27th International Conference on Computational Linguistics*, 2018, pp. 3619–3630.
- [10] X. Tang, B. Du, J. Huang, Z. Wang, and L. Zhang, "On combining active and transfer learning for medical data classification," *Institution of Engineering and Technology Computer Vision*, vol. 13, no. 2, pp. 194–205, 2018.
- [11] H. Huang, H. Wang, and D. Jin, "A low-cost named entity recognition research based on active learning," *Scientific Programming*, vol. 2018, 2018.
- [12] S. Hochreiter and J. Schmidhuber, "Long short-term memory," *Neural computation*, vol. 9, no. 8, pp. 1735–1780, 1997.
- [13] J. L. Elman, "Finding structure in time," *Cognitive Science*, vol. 14, no. 2, pp. 179–211, 1990.
- [14] N. Xue and L. Shen, "Chinese word segmentation as lmr tagging," in *Proceedings of the second SIGHAN workshop on Chinese language processing-Volume 17*. Association for Computational Linguistics, 2003, pp. 176–179.
- [15] X. Zheng, H. Chen, and T. Xu, "Deep learning for chinese word segmentation and pos tagging," in *Proceedings of the 2013 Conference on Empirical Methods in Natural Language Processing*, 2013, pp. 647–657.
- [16] D. Shao, N. Zheng, Z. Yang, Z. Chen, Y. Xiang, Y. Xian, and Z. Yu, "Domain-specific chinese word segmentation based on bi-directional long-short term memory model," *IEEE Access*, vol. 7, pp. 12 993–13 002, 2019.
- [17] H. Zhao, C.-N. Huang, M. Li, and B.-L. Lu, "Effective tag set selection in chinese word segmentation via conditional random field modeling," in *Proceedings of the 20th Pacific Asia Conference on Language, Information and Computation*, 2006, pp. 87–94.
- [18] F. Peng, F. Feng, and A. McCallum, "Chinese segmentation and new word detection using conditional random fields," in *Proceedings of the 20th international conference on Computational Linguistics*. Association for Computational Linguistics, 2004, p. 562.
- [19] X. Chen, X. Qiu, C. Zhu, and X. Huang, "Gated recursive neural network for chinese word segmentation," in *Proceedings of the 53rd Annual Meeting of the Association for Computational Linguistics and the 7th International Joint Conference on Natural Language Processing (Volume 1: Long Papers)*, 2015, pp. 1744–1753.
- [20] W. Jiang and Y. Tang, "A seq-to-seq transformer premised temporal convolutional network for chinese word segmentation," *arXiv preprint arXiv:1905.08454*, 2019.
- [21] J. Yang, Y. Zhang, and S. Liang, "Subword encoding in lattice lstm for chinese word segmentation," *arXiv preprint arXiv:1810.12594*, 2018.
- [22] Q. Yan, L. Wang, S. Li, H. Liu, and G. Zhou, "Active learning for chinese word segmentation on judgements," in *National CCF Conference on Natural Language Processing and Chinese Computing*. Springer, 2017, pp. 839–848.
- [23] D. Angluin, "Queries and concept learning," *Machine Learning*, vol. 2, no. 4, pp. 319–342, 1988.
- [24] P. Hu, Z. C. Lipton, A. Anandkumar, and D. Ramanan, "Active learning with partial feedback," 2018.
- [25] D. D. Lewis and W. A. Gale, "A sequential algorithm for training text classifiers," in *SIGIR*. Springer, 1994, pp. 3–12.
- [26] R. Gilad-Bachrach, A. Navot, and N. Tishby, "Query by committee made real," in *Advances in neural information processing systems*, 2006, pp. 443–450.
- [27] N. Houlsby, F. Huszár, Z. Ghahramani, and M. Lengyel, "Bayesian active learning for classification and preference learning," *arXiv preprint arXiv:1112.5745*, 2011.
- [28] K. Konyushkova, R. Sznitman, and P. Fua, "Learning active learning from data," 2017.
- [29] H. Song, T. Yao, C. Kit, and D. Cai, "Active learning based corpus annotation," in *CIPS-SIGHAN Joint Conference on Chinese Language Processing*, 2010. [Online]. Available: <https://www.aclweb.org/anthology/W10-4121>
- [30] A. McCallum, D. Freitag, and F. C. Pereira, "Maximum entropy markov models for information extraction and segmentation," in *International Conference on Machine Learning*, vol. 17, no. 2000, 2000, pp. 591–598.
- [31] Y. Goldberg and O. Levy, "word2vec explained: deriving mikolov et al.'s negative-sampling word-embedding method," *arXiv preprint arXiv:1402.3722*, 2014.
- [32] J. A. Hartigan and M. A. Wong, "Algorithm as 136: A k-means clustering algorithm," *Journal of the Royal Statistical Society. Series C (Applied Statistics)*, vol. 28, no. 1, pp. 100–108, 1979.
- [33] D. Cai and H. Zhao, "Neural word segmentation learning for chinese," *arXiv preprint arXiv:1606.04300*, 2016.
- [34] L. Lei, Y. Zhou, J. Zhai, L. Zhang, Z. Fang, P. He, and J. Gao, "An effective patient representation learning for time-series prediction tasks based on ehrrs," in *IEEE International Conference on Bioinformatics and Biomedicine (BIBM)*. IEEE, 2018, pp. 885–892.
- [35] Y. Bengio, P. Simard, P. Frasconi et al., "Learning long-term dependencies with gradient descent is difficult," *IEEE Transactions on Neural Networks*, vol. 5, no. 2, pp. 157–166, 1994.
- [36] N. Srivastava, G. Hinton, A. Krizhevsky, I. Sutskever, and R. Salakhutdinov, "Dropout: a simple way to prevent neural networks from overfitting," *Journal of Machine Learning Research*, vol. 15, no. 1, pp. 1929–1958, 2014.
- [37] D. Comaniciu and P. Meer, "Mean shift: A robust approach toward feature space analysis," *IEEE Transactions on Pattern Analysis and Machine Intelligence*, no. 5, pp. 603–619, 2002.
- [38] A. Y. Ng, M. I. Jordan, and Y. Weiss, "On spectral clustering: Analysis and an algorithm," in *Advances in Neural Information Processing Systems*, 2002, pp. 849–856.
- [39] M. Ester, H.-P. Kriegel, J. Sander, X. Xu et al., "A density-based algorithm for discovering clusters in large spatial databases with noise," in *Knowledge Discovery in Database*, vol. 96, no. 34, 1996, pp. 226–231.