

# Entanglement subvolume law for 2D frustration-free spin systems

Anurag Anshu <sup>\* †‡</sup>    Itai Arad<sup>§</sup>    David Gosset <sup>\*†</sup>

## Abstract

Let  $H$  be a frustration-free Hamiltonian describing a 2D grid of qudits with local interactions, a unique ground state, and local spectral gap lower bounded by a positive constant. For any bipartition defined by a vertical cut of length  $L$  running from top to bottom of the grid, we prove that the corresponding entanglement entropy of the ground state of  $H$  is upper bounded by  $\tilde{O}(L^{5/3})$ . For the special case of a 1D chain, our result provides a new area law which improves upon prior work, in terms of the scaling with qudit dimension and spectral gap. In addition, for any bipartition of the grid into a rectangular region  $A$  and its complement, we show that the entanglement entropy is upper bounded as  $\tilde{O}(|\partial A|^{5/3})$  where  $\partial A$  is the boundary of  $A$ . This represents the first subvolume bound on entanglement in frustration-free 2D systems. In contrast with previous work, our bounds depend on the local (rather than global) spectral gap of the Hamiltonian. We prove our results using a known method which bounds the entanglement entropy of the ground state in terms of certain properties of an approximate ground state projector (AGSP). To this end, we construct a new AGSP which is based on a robust polynomial approximation of the AND function and we show that it achieves an improved trade-off between approximation error and entanglement.

## 1 Introduction

A regularly arranged collection of locally interacting spins may hardly seem an accurate representation of the sea of molecules that constitute a typical material. But the study of spin systems has provided key insights into widely observed phenomena such as ferromagnetism, superconductivity, superfluidity, and topological order. Such insights have contributed to the technological progress seen in materials science, electronics, and related areas.

Several universal features of quantum spin systems have been discovered based on natural physical assumptions such as locality of the interactions and/or the presence of a spectral gap in the thermodynamic limit. Lieb and Robinson [45] used locality to conclude that, to a very good approximation, the support of local observables expands at a constant rate as the

---

<sup>\*</sup>Institute for Quantum Computing, University of Waterloo, Canada

<sup>†</sup>Department of Combinatorics and Optimization, University of Waterloo, Canada

<sup>‡</sup>Perimeter Institute for Theoretical Physics, Canada

<sup>§</sup>Physics Department, Technion, Israel

system evolves in time. For spin systems with a unique ground state and a spectral gap, it has been shown that correlation functions decay exponentially with distance [27, 29, 49, 4, 25]. Hastings [28] proved that unique gapped ground states of one-dimensional spin systems have bounded mutual information across any bipartition of the lattice. This is the so-called *area law* for 1D quantum spin systems.

More generally, a quantum state of a system of qudits on a lattice is said to obey an area law if for any bipartition of the lattice into a region  $A$  and its complement  $\bar{A}$ , the mutual information between the parts scales as the size  $|\partial A|$  of the boundary of the bipartition. When the quantum state is pure, the mutual information is twice the entropy of either bipartition, also known as the *entanglement entropy*. A quantum state exhibiting an area law is markedly different from a random pure quantum state, as the latter possesses an entanglement entropy that scales as the volume of the smaller part.

The study of the relationship between entanglement and geometry has a long history [24]. Inspired by the work of Bekenstein [13] and Hawking [30], which relates the entropy of a black hole to its surface area, it was shown that the ground state of several models of quantum field theories obey (or nearly obey) area laws [14, 53, 20, 34, 31]. Later, a similar phenomenon was shown to occur in the ground states of several systems with nearest-neighbor interactions in one dimension [11, 41, 55], away from critical points where the Hamiltonian becomes gapless and the entanglement may diverge. This led to *area law conjecture*, which states that the ground states of gapped spin systems on a lattice of any dimension obey an area law.

This conjecture has led to a rich body of work connecting quantum information science, condensed matter physics, and computer science. Hastings' proof [28] itself uses powerful information-theoretic arguments inspired by the monogamy of quantum entanglement [54]. Brandão and Horodecki [16] use ideas from the quantum communication task of quantum state merging [32] to obtain an area law for any state satisfying an exponential decay of correlations in 1D. A series of works [9, 8] have obtained exponential improvements to Hastings' entanglement upper bound, using the *polynomial method*, a widely used technique in theoretical computer science and optimization theory. These works have also led to a rigorous proof that gapped ground states of 1D systems have an efficient classical representation [28, 9, 8] as Matrix Product States [36, 37], which explains the success of the DMRG algorithm [56] in the numerical study of quantum spin systems. The techniques developed in [9, 8] have also been used in the first provably efficient classical algorithm for computing ground states of gapped 1D spin systems [40, 10].

Despite these applications and extensions of Hastings' 1D result, the area law conjecture for two (or higher) dimensional lattices has thus far resisted all attacks. Some works have described additional physical assumptions which are sufficient to guarantee an area law. For example, Ref. [57] proves an area law for the thermal state of any spin system at sufficiently high temperatures. Unfortunately, this bound diverges as the temperature approaches zero, and hence does not provide any information about the ground state. In Ref. [46] the area law was proved under the assumption that the number of eigenstates with vanishing energy density does not grow exponentially with the volume. In Ref. [47] it was proved under the assumption that the Hamiltonian can be adiabatically connected to another Hamiltonian in which the area-law holds, along a path of gapped Hamiltonians. In Ref. [21] the author assumed that the ground state can be gradually built from a sequence of ground states of smaller and smaller gapped Hamiltonians, and that these ground states are, in some sense,

very close to each other. In Ref. [15] the area law was established under the assumption of an exponential decay of the specific heat capacity of the system with respect to the inverse temperature. A counterpart to the above positive results is provided by Ref. [5], which shows that a “generalized” area law for local Hamiltonian systems on arbitrary graphs is false.

In this work we establish a subvolume bound on the entanglement entropy of the unique ground state of a frustration-free local Hamiltonian in two dimensions with a local spectral gap. To state our result, let us introduce some terminology. For the sake of being concrete, we shall focus on a rather specific 2D setup. However, many of the specific settings we assume can be easily generalized.

We consider a system of qudits of local dimension  $d$  located at the vertices of an  $n \times L$  grid where  $n \geq 2$  and  $L \geq 1$ , see Fig. 1. We index qudits by their coordinates  $(i, j) \in [n] \times [L]$ , where  $[q]$  is the set of integers  $\{1, 2, \dots, q\}$ . We define a local Hamiltonian  $H$  which acts on this system of qudits as a sum of local projectors

$$H = \sum_{i=1}^{n-1} \sum_{j=1}^{\max\{L-1, 1\}} P_{ij}, \quad (1)$$

where for  $L \geq 2$ ,  $P_{ij}$  is a projector ( $P_{ij}^2 = P_{ij}$ ) that acts nontrivially only on the four qudits  $\{(i, j), (i, j+1), (i+1, j), (i+1, j+1)\}$ . For the special case  $L = 1$ , Eq. (1) describes a 1D chain  $H = \sum_{i=1}^{n-1} P_{i1}$ , where  $P_{i1}$  acts nontrivially only on qudits  $i, i+1$ .

More generally, it will be convenient to view the system of qudits as a 1D chain of “columns”. In particular, we define the  $i$ th column to be the set of qudits  $\{(i, j) : j \in [L]\}$ , and write the Hamiltonian as

$$H = \sum_{i=1}^{n-1} H_i \quad H_i \stackrel{\text{def}}{=} \sum_{j=1}^{\max\{L-1, 1\}} P_{ij}, \quad (2)$$

where the column Hamiltonian  $H_i$  is the sum of all local projectors which act nontrivially between qudits in columns  $i$  and  $i+1$ .

We further assume the Hamiltonian is frustration-free and has a unique ground state  $|\Omega\rangle$ . Frustration-free means that the ground state of the full Hamiltonian is also a ground state of each of the individual local terms in the Hamiltonian, i.e.,  $P_{ij} |\Omega\rangle = 0$  for all  $i, j$ . This sort of Hamiltonian can be viewed as a satisfiable instance of a *quantum constraint satisfaction* problem — each local term is a constraint and the ground state is a satisfying assignment [17]. Frustration-free quantum spin systems are widely studied in the physics and quantum information literature (see e.g., Refs. [2, 1, 50, 51, 19, 6, 39, 35, 44]).

The entanglement entropy of the ground state  $|\Omega\rangle$  with respect to some bipartition  $[n] \times [L] = A \cup \bar{A}$  of the qudits is

$$S(\rho_A) \stackrel{\text{def}}{=} -\text{Tr}(\rho_A \log(\rho_A)), \quad \text{where} \quad \rho_A \stackrel{\text{def}}{=} \frac{\text{Tr}_{\bar{A}} |\Omega\rangle\langle\Omega|}{\text{Tr}_{\bar{A}} |\Omega\rangle\langle\Omega|}. \quad (3)$$

Without any further assumptions, any nontrivial upper bound on  $S(\rho_A)$  must depend in some way on the spectral properties of the Hamiltonian  $H$ . Indeed, ground states of gapless frustration-free Hamiltonians in 1D can have very high entanglement between the two halves of the chain [18, 48], as large as the maximal linear scaling with chain length [58]. The 1D

area laws established in Refs. [28, 9, 8] depend on the (global) spectral gap of  $H$ , which for a frustration-free Hamiltonian Eq. (2) is its smallest nonzero eigenvalue. In contrast, the bounds we establish here depends on the *local spectral gap*  $\gamma$  of  $H$ , equal to the minimum spectral gap of any Hamiltonian describing a contiguous patch of the system. In particular, for any contiguous subset  $S \subseteq [n] \times [L]$ , define  $\gamma(S)$  to be the smallest nonzero eigenvalue of  $\sum_{(i,j) \in S} P_{ij}$ , and define

$$\gamma = \min\{\min_S \gamma(S), 1\}.$$

Note that  $0 < \gamma \leq 1$ . It is slightly irksome that our results depend on the local rather than the global spectral gap. The relationship between these two quantities has been studied in Refs. [38, 26, 43, 42], see Section 2 of Ref. [42] for a review. While in principle it is possible that the local gap is much smaller than the global gap (potentially in exotic examples constructed in [22, 12]), we do not expect this to occur for physically realistic systems.

Our first result is a bound on the entanglement entropy of the ground state with respect to a “vertical cut” separating columns  $A = \{1, 2, \dots, c\}$  from  $\bar{A} = \{c + 1, c + 2, \dots, n\}$  for some  $c \in [n - 1]$ . We will denote this vertical cut as  $(c, c + 1)$ .

**Theorem 1.1 (Subvolume scaling for a vertical cut).** *Let  $|\Omega\rangle$  be the unique ground state of a frustration-free Hamiltonian Eq. (2) on an  $n \times L$  grid of qudits with local dimension  $d$ . Its entanglement entropy across a vertical cut  $(c, c + 1)$  is at most*

$$S(\rho_A) \leq \frac{CL^{5/3}}{\gamma^{5/6}} \log^{7/3}(dL\gamma^{-1}).$$

where  $C > 0$  is a universal constant.

The above result can be viewed as simultaneously generalizing and improving upon the previous state-of-the art area law in 1D [8]. Indeed, taking a grid of dimensions  $n \times 1$  we recover the 1D case and Theorem 1.1 provides the expected  $O(1)$  bound on entanglement entropy for (locally) gapped 1D systems, for which  $d = O(1)$  and  $\gamma = \Omega(1)$ . Looking more closely we see that Theorem 1.1 improves upon Ref. [8] both in terms of the dependence on the local dimension  $d$ , from  $\log^3(d)$  to  $\log^{7/3}(d)$ , and in terms of the dependence on the spectral gap  $\gamma$ , from  $\gamma^{-1}$  to  $\gamma^{-5/6}$  (here ignoring a polylogarithmic factor as well as the difference between local and global spectral gaps). This is a step closer to the conjectured scaling of  $\approx \frac{1}{\sqrt{\gamma}}$  for 1D frustration-free systems [25, 26] which coincides with the optimal upper bound on correlation length [25].

The proof of Theorem 1.1 is the main technical content of this paper. The proof itself is essentially one dimensional in the sense that it is entirely based on the expression in Eq. (2) for the Hamiltonian as a 1D chain of columns. With only a small modification we are able to establish a similar bound for any bipartition of the 2D grid corresponding to a rectangular region and its complement. The bound is obtained by viewing the Hamiltonian as a 1D chain of concentric rectangular bands and using almost exactly the same proof, see Fig. 3 (c).

**Theorem 1.2 (Subvolume scaling for a rectangular region).** *Let  $|\Omega\rangle$  be the unique ground state of a frustration-free Hamiltonian Eq. (2) on an  $n \times L$  grid of qudits with local dimension  $d$ . Its entanglement entropy with respect to a bipartition of the qudits into a rectangular region  $A$  and its complement  $\bar{A}$  is given by*

$$S(\rho_A) \leq \frac{C|\partial A|^{5/3}}{\gamma^{5/6}} \log^{7/3}(d|\partial A|\gamma^{-1}). \quad (4)$$

where  $C > 0$  is a universal constant.

The bound  $\tilde{O}(|\partial A|^{5/3})$  on the right-hand side represents an improvement over the trivial volume law scaling of  $|\partial A|^2$ , and gives some movement towards the elusive area law conjecture in two dimensions.

While Theorems 1.2 and 1.1 are stated in terms of the usual entanglement entropy of the ground state, we are able to obtain similar subvolume bounds on other so-called Rényi entanglement entropies. In Appendix C we show how this works for the Rényi entanglement entropy of order  $1/2$ . An interesting consequence is then obtained following an argument from the recent works in Refs. [33, 23]. Theorem 3 of Ref. [33] shows that, if some Rényi entanglement entropy (of order less than one) of a quantum state  $|\psi\rangle$  on a 2D lattice satisfies an area law for any bipartition of the lattice into a square region and its complement, then there is a projected entangled pair (PEPS) state of bond dimension  $e^{O(\frac{1}{\delta})}$  which reproduces expectation values of all local observables in the state  $\psi$  up to an additive error  $\delta$ . Following Huang's proof technique and using our subvolume law one can reach almost the same conclusion — but with a weaker upper bound  $e^{\tilde{O}(\frac{1}{\delta^5})}$  on the bond dimension, see Appendix C for details.

Finally, we remark that it may be possible to extend our results to degenerate ground states, using the techniques developed in Ref. [10], although we do not pursue this direction here.

To prove Theorem 1.1 we use a method described in Ref. [8] which is based on the construction of a so-called Approximate Ground State Projector (AGSP). In this context an AGSP is an operator  $K$  which fixes the ground state and its orthogonal complement, i.e.,

$$K |\Omega\rangle = K^\dagger |\Omega\rangle = |\Omega\rangle.$$

The AGSP has two important parameters  $D$  and  $\Delta$  which are defined with respect to a given bipartition of the qudits. The parameter  $D$  is an upper bound on the Schmidt rank of  $K$  across the bipartition. Recall that the Schmidt rank of an operator  $K$  acting on two registers  $A$  and  $B$  is the smallest integer  $R$  such that  $K = \sum_{s=1}^R K_A^s \otimes K_B^s$  for some operators  $\{K_A^s\}_{s=1}^R$  and  $\{K_B^s\}_{s=1}^R$  that are supported only on the registers  $A$  and  $B$ , respectively. The parameter  $\Delta$  is any number such that

$$\|K |\psi\rangle\|^2 \leq \Delta \quad \text{for all } |\psi\rangle \in G_\perp,$$

where  $G_\perp$  is the subspace of  $nL$ -qudit states orthogonal to the ground state  $|\Omega\rangle$ . In other words,  $\Delta$  is a *shrinking factor* which measures the shrinkage of the space orthogonal to  $|\Omega\rangle$  when  $K$  is applied. An AGSP with parameters  $D$  and  $\Delta$  is called a  $(D, \Delta)$ -AGSP. The following theorem relates these AGSP parameters to a bound on the entanglement entropy across the cut.

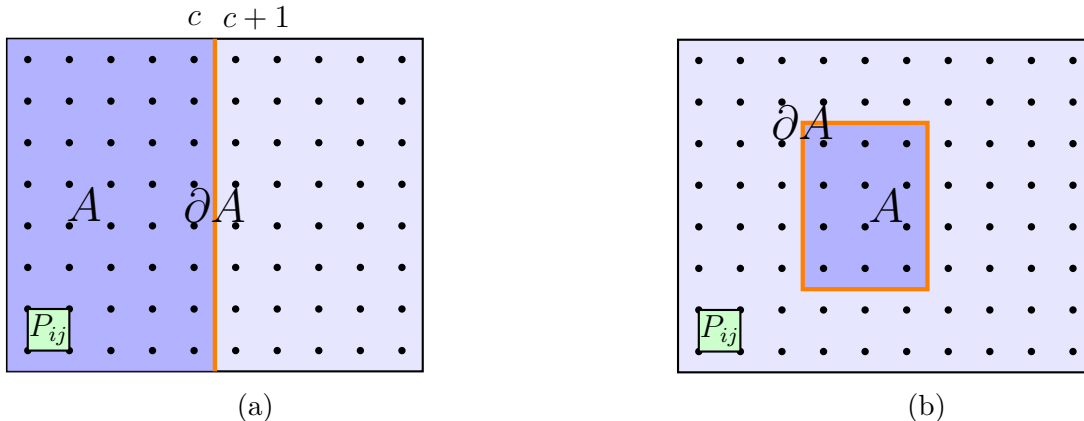

Figure 1: Bipartitions considered in (a) Theorem 1.1 and (b) Theorem 1.2

**Theorem 1.3** (Ref. [9]). *If there exists a  $(D, \Delta)$ -AGSP such that  $D \cdot \Delta \leq \frac{1}{2}$ , then the entanglement entropy of  $|\Omega\rangle$  across the cut is upper bounded by  $10 \cdot \log(D)$ .*

Theorem 1.3 states that the existence of an AGSP with the right parameters implies a bound on the entanglement entropy of the ground state  $|\Omega\rangle$  of our quantum spin system. Most of our work in the remainder of the paper will be to establish bounds on the parameters  $D, \Delta$  of a certain AGSP. At a high level, the AGSP we construct in this paper is based on the detectability lemma operator introduced in Ref. [3] and its coarse-grained version used in Refs. [9, 7]. We are able to improve upon its performance in terms of the parameters  $D$  and  $\Delta$  by modifying the construction using certain polynomial approximations.

The remainder of the paper is organized as follows. In Sec. 2 we describe two families of polynomials. These are building blocks used to construct the AGSP, which is our main object of study, given in Sec. 3. We also include a sketch of the proof of Theorem 1.1 in Sec. 3. In Sections 4 and 5 respectively we upper bound the shrinking factor  $\Delta$  and Schmidt rank  $D$  of this AGSP. In Sec. 6 we combine Theorem 1.3 and the bounds on  $D$  and  $\Delta$  to complete the proof of Theorem 1.1. Finally, in Sec. 7 we describe the minor modifications to the proof which result in Theorem 1.2.

## 2 Polynomials

Here we describe two families of polynomials, which are the building blocks for our AGSP.

We first describe a univariate polynomial function of  $x$  that takes the value 1 at  $x = 0$  but has a very small magnitude in some range of  $x$ -values bounded away from 0. We shall colloquially refer to this as a *step polynomial*. It is well-known that Chebyshev polynomials can be used for this purpose. Let  $T_f$  be the degree- $f$  Chebyshev polynomial of the first kind. For any positive integer  $f$  and  $g \in (0, 1)$ , define

$$\text{Step}_{f,g}(x) \stackrel{\text{def}}{=} \frac{T_f\left(\frac{2(1-x)}{1-g} - 1\right)}{T_f\left(\frac{2}{1-g} - 1\right)}. \quad (5)$$

The following fact is a special case of Lemma 4.1 from Ref. [8]<sup>1</sup>.

**Fact 2.1 (Step polynomial [8]).** For every positive integer  $f$  and  $g \in (0, 1)$ , there exists a univariate polynomial  $\text{Step}_{f,g} : \mathbb{R} \rightarrow \mathbb{R}$  with real coefficients and degree  $f$  such that  $\text{Step}_{f,g}(0) = 1$  and

$$|\text{Step}_{f,g}(x)| \leq 2 \exp(-2f\sqrt{g}) \quad \text{for} \quad g \leq x \leq 1. \quad (6)$$

The only properties of  $\text{Step}_{f,g}$  that we will use in the following are summarized in Fact 2.1. In particular, we will not need its precise form (5), which is included only for completeness.

A key ingredient in our work is the construction of *robust polynomials* due to Sherstov [52]. In this setting a robust polynomial is a real multivariate polynomial that approximates a boolean function even when the input  $x \in \{0, 1\}^m$  is corrupted by a real-valued error vector  $\epsilon \in [-1/20, 1/20]^m$ . We will use a robust polynomial for the ‘AND’ function on  $m$  variables which has properties summarized in the following theorem. The construction of this polynomial and the proof of the theorem, which is provided in Appendix A, follow the technique used by Sherstov in Theorem 3.2 of Ref. [52] to construct a robust polynomial approximation of the PARITY function.

**Theorem 2.2 (Robust AND polynomial, following Sherstov [52]).** *Let  $m$  be a positive integer. There is a multivariate polynomial  $p_{\text{AND}} : \mathbb{R}^m \rightarrow \mathbb{R}$  with real coefficients and degree  $11m$  satisfying*

$$p_{\text{AND}}(1, 1, \dots, 1) = 1,$$

*such that for any bit-string  $y \in \{0, 1\}^m$  and real-valued error vector  $\epsilon \in [-1/20, 1/20]^m$ , we have*

$$|p_{\text{AND}}(y + \epsilon) - y_1 y_2 \dots y_m| \leq e^{-m}. \quad (7)$$

*Moreover, there are univariate polynomials  $A_i : \mathbb{R} \rightarrow \mathbb{R}$  of degree  $2i + 1$  for each  $i \geq 0$  such that*

$$p_{\text{AND}}(x_1, \dots, x_m) = \sum_{\{i_1, \dots, i_m\} : i_1 + \dots + i_m \leq 5m} A_{i_1}(x_1) \cdot A_{i_2}(x_2) \dots A_{i_m}(x_m).$$

### 3 Approximate Ground State Projector

Let us begin by defining a simple AGSP as our starting point. The AGSP depends on a positive integer  $t$ , which is a coarse-graining parameter. For any  $2t \leq k \leq n - 2t$  define  $Q'_k$  as the projection onto the ground space of the Hamiltonian

$$h'_k \stackrel{\text{def}}{=} \sum_{j=k-2t+1}^{k+2t-1} H_j,$$

---

<sup>1</sup>Fact 2.1 is obtained from Lemma 4.1 of Ref. [8] by setting  $\epsilon_0 = 0, \epsilon_1 = g, u = 1, \ell = f$ .

which contains all terms of Eq. (2) supported entirely inside the contiguous region of the  $4t$  columns  $\{k - 2t + 1, k - 2t + 2, \dots, k + 2t\}$ . Here we use a prime superscript because we will soon slightly modify the notation for the subregion Hamiltonians  $h'_k$  and ground space projectors  $Q'_k$ . Note that

$$[Q'_a, Q'_b] = 0 \quad \text{whenever} \quad |a - b| \geq 4t, \quad (8)$$

as the latter condition ensures the projectors have disjoint support.

Let us define the ( $t$ -coarse grained) *Detectability lemma operator* [3] to be the product

$$\text{DL}(t) \stackrel{\text{def}}{=} (Q'_{2t} \cdot Q'_{8t} \cdot Q'_{14t} \cdot \dots) \cdot (Q'_{5t} \cdot Q'_{11t} \cdot Q'_{17t} \cdot \dots), \quad (9)$$

where the terms within each of the parenthesized expressions are mutually commuting. The following Lemma is a slight variant of one established in Ref. [7]. We provide a proof in Appendix B. Recall that  $G_\perp$  is the subspace orthogonal to the ground state.

**Lemma 3.1.** *For any normalized state  $|\psi\rangle \in G_\perp$ ,*

$$\|\text{DL}(t) |\psi\rangle\| \leq 2e^{-t\sqrt{\gamma}/25}.$$

The lemma states that, if the coarse-graining parameter  $t$  is large enough, then the operator  $\text{DL}(t)$  shrinks the space  $G_\perp$  at a rate which decreases exponentially with the *square root* of  $\gamma$ . This square-root is the reason why coarse-graining is useful to us—without it the shrinkage would be quadratically worse as a function of  $\gamma$  (see, e.g., Ref. [7]).

Recall that we are interested in the entanglement of the ground state  $|\Omega\rangle$  across some vertical cut  $(c, c+1)$  where  $c \in [n]$ . For now it will be convenient to assume that  $c \bmod 6t = 2t$ ; later, in Sec. 6, we drop this assumption. In this case the set of qudits  $\{c, c+1\} \times [L]$  are contained in the support of  $Q'_c$  and the cut divides its support into two equal parts, see Fig. 2. Moreover,  $Q'_c$  is the only projector in Eq. (9) with support intersecting this vertical cut. It will be convenient to rewrite Eq. (9) using a different notation which singles out some of the projectors that surround the cut. In particular, let  $m$  be an odd positive integer and consider the  $m$  projectors

$$Q'_{c-3(m-1)t}, \dots, Q'_{c-6t}, Q'_c, Q'_{c+6t}, \dots, Q'_{c+3(m-1)t}. \quad (10)$$

Recall that these operators project onto the ground spaces of subregion Hamiltonians

$$h'_{c-3(m-1)t}, \dots, h'_{c-6t}, h'_c, h'_{c+6t}, \dots, h'_{c+3(m-1)t}. \quad (11)$$

We shall relabel the projectors Eq. (10) from left-to-right as  $Q_1, Q_2, \dots, Q_m$  and the corresponding subregion Hamiltonians Eq. (11) as  $h_1, h_2, \dots, h_m$ . Then  $Q_k$  is the ground space projector of  $h_k$  for each  $k = 1, 2, \dots, m$ . Observe that

$$[Q_i, Q_j] = 0 \quad \text{for all} \quad 1 \leq i \leq j \leq m,$$

which follows from Eq. (8) and our definition of the projectors  $Q_1, Q_2, \dots, Q_m$ . We write

$$\text{DL}(t) = Q_1 Q_2 \dots Q_m Q_{\text{rest}}, \quad (12)$$



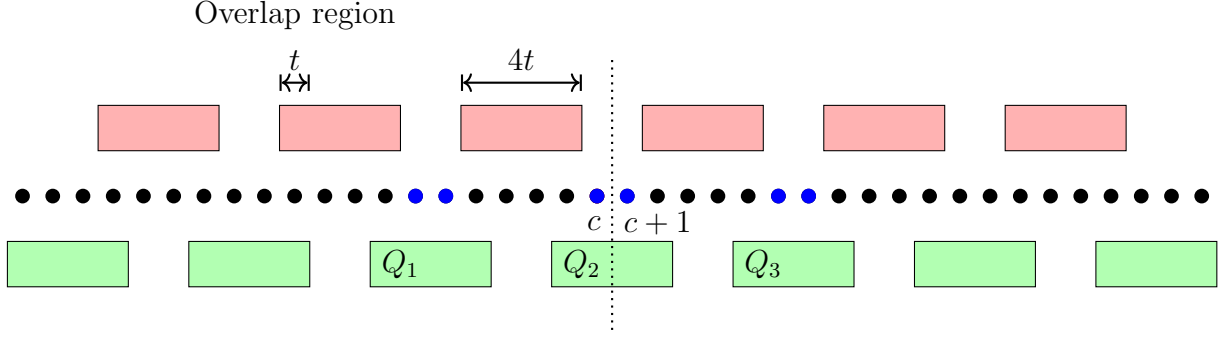

Figure 2: Construction of the AGSP  $K(m, t, \ell)$ , for  $t = 1$  and  $m = 3$ . Here each dot represents a column of  $L$  qudits; the 2D  $n \times L$  grid is represented as a 1D chain of  $n$  columns. Each coarse-grained projector contains  $4t$  columns in its support and neighboring coarse-grained projectors overlap in a region containing  $t$  columns. The  $m$  coarse-grained projectors around the cut are denoted  $Q_1, Q_2, \dots, Q_m$ . The columns shown in blue are members of the set ‘Ind’ defined in Section 5.

where  $Q_{\text{rest}}$  contains the remainder of the terms in Eq. (9), i.e.,

$$Q_{\text{rest}} \stackrel{\text{def}}{=} (Q'_{2t} \cdot \dots \cdot Q'_{c-3(m-1)t-6t} \cdot Q'_{c+3(m+1)t+6t} \cdot \dots) (Q'_{5t} \cdot Q'_{11t} \cdot Q'_{17t} \cdot \dots).$$

Note that the difference between Eqs. (9, 12) is only notation and that the operator  $\text{DL}(t)$  does not have any dependence on the parameter  $m$ . However, we will soon use Eq. (12) as a starting point in defining another AGSP which does depend on this parameter.

To this end, we shall first define polynomial approximations to each of the projectors  $Q_1, Q_2, \dots, Q_m$ . In particular, we use the degree- $f$  *step polynomial*  $\text{Step}_{f,g}(x)$  of Fact 2.1 to define

$$\widehat{Q}_j \stackrel{\text{def}}{=} \text{Step}_{f,g} \left( \frac{1}{4tL} h_j \right) \quad \text{where} \quad f = \left\lceil 4\sqrt{tL/\gamma} \right\rceil \quad \text{and} \quad g = \frac{\gamma}{4tL}. \quad (13)$$

Here  $\lceil x \rceil$  indicates the smallest integer which is at least  $x$ . Note that  $\widehat{Q}_j$  is Hermitian, since  $\text{Step}_{f,g}$  is a polynomial with real coefficients, and  $h_j$  is a Hermitian operator. In addition,  $\|h_j/4tL\| \leq 1$  since  $h_j$  is a sum of at most  $4tL$  projectors, and the smallest nonzero eigenvalue of  $h_j/4tL$  is at least  $\gamma/4tL$  (by definition of the local spectral gap  $\gamma$ ). We use Fact 2.1 to establish the following properties of the spectrum of  $\widehat{Q}_j$ .

**Lemma 3.2.** *For each  $j = 1, 2, \dots, m$ , the projector onto the eigenspace of  $\widehat{Q}_j$  with eigenvalue  $+1$  is equal to  $Q_j$ , and*

$$\|\widehat{Q}_j - Q_j\| \leq \frac{1}{20}. \quad (14)$$

*Proof.* Recall that  $Q_j$  projects onto the zero energy ground space of  $h_j$ , which is mapped to the  $+1$ -eigenspace of  $\widehat{Q}_j$  since  $\text{Step}_{f,g}(0) = 1$ . On the other hand, all nonzero eigenvalues of  $h_j$  are at least  $\gamma/4tL$  and using Eq. (6) and the choices Eq. (13) of  $f$  and  $g$  we see that

$$\|\widehat{Q}_j - Q_j\| \leq 2e^{-2f\sqrt{\gamma/4tL}} \leq 2e^{-4} \leq \frac{1}{20}.$$

□

The AGSP we will define is similar to the  $DL(t)$  operator of Eq. (12), with the following modifications:

- **Outer polynomial approximation using the robust AND:** Use  $p_{\text{AND}}$  described in Theorem 2.2 to approximate the product  $Q_1 Q_2 \dots Q_m$ .
- **Inner polynomial approximation using the step polynomials:** Use the operators  $\widehat{Q}_j$  to approximate  $Q_j$ .
- **Powering:** Amplify the effect of the operator by raising it to a power  $\ell \geq 1$ .

In particular, the AGSP which is the main object of study in this paper is defined as follows:

$$K(m, t, \ell) \stackrel{\text{def}}{=} \left( p_{\text{AND}} \left( \widehat{Q}_1, \widehat{Q}_2, \dots, \widehat{Q}_m \right) Q_{\text{rest}} \right)^\ell. \quad (15)$$

It depends on the choices of coarse-graining parameter  $t$  (a positive integer), the odd positive integer  $m$  describing the number of coarse-grained projectors of interest near the cut, and the positive integer  $\ell$  which is the powering parameter. Note that if  $n$  is too small we may not be able to fit  $m$  coarse-grained projectors around the cut as shown in Fig. 2, and in this case strictly speaking we cannot define  $K(m, t, \ell)$  as above. In the following, we shall without loss of generality assume that  $n$  is sufficiently large that  $K(m, t, \ell)$  is well-defined<sup>2</sup>.

To confirm that the operator  $K(m, t, \ell)$  is an AGSP, we need to check that it fixes the ground state  $|\Omega\rangle$  and its orthogonal space  $G_\perp$ , that is,

$$K(m, t, \ell)^\dagger |\Omega\rangle = K(m, t, \ell) |\Omega\rangle = |\Omega\rangle \quad (16)$$

It suffices to check Eq. (16) with  $\ell = 1$  since the result for higher  $\ell$  follows from this special case. Using the fact that  $Q_{\text{rest}} |\Omega\rangle = |\Omega\rangle$  we get

$$K(m, t, 1) |\Omega\rangle = p_{\text{AND}} \left( \widehat{Q}_1, \widehat{Q}_2, \dots, \widehat{Q}_m \right) |\Omega\rangle = p_{\text{AND}}(1, 1, \dots, 1) |\Omega\rangle = |\Omega\rangle,$$

where in the second equality we used the fact that  $\widehat{Q}_j |\Omega\rangle = |\Omega\rangle$  for all  $j = 1, 2, \dots, m$ , and in the last equality we used the fact that  $p_{\text{AND}}(1, 1, \dots, 1) = 1$  as stated in Thmcorrobust. A very similar argument shows  $K(m, t, 1)^\dagger |\Omega\rangle = |\Omega\rangle$ .

In the next two sections we bound the shrinking factor  $\Delta$  and Schmidt rank  $D$  of the AGSP  $K(m, t, \ell)$  across the vertical cut  $(c, c + 1)$ . We now provide an overview of these bounds and how they are used to establish Theorem 1.1.

---

<sup>2</sup>We can always form a new Hamiltonian  $H'$  on an  $n' \times L$  grid for any  $n' > n$  which has (a) the same local spectral gap  $\gamma$  as  $H$ , and (b) a unique ground state  $|\Omega\rangle \otimes |0^{(n'-n)L}\rangle$  and therefore exactly the same entanglement entropy across the given cut.  $H'$  is obtained from  $H$  by adding new local projectors which act on all the newly added plaquettes of the lattice. For each plaquette with  $q < 4$  old qudits from the original lattice and  $4 - q$  new qudits, we add the projector  $I^{\otimes q} \otimes (I - |0\rangle\langle 0|^{\otimes 4-q})$  to the Hamiltonian.

## Overview of the proof of Theorem 1.1:

In Sec. 4 we use the error bound Eq. (7) for the robust polynomial  $p_{\text{AND}}$  to show that  $K(m, t, 1)$  approximates the coarse-grained detectability lemma operator  $\text{DL}(t)$  in the sense that  $\|K(m, t, 1) - \text{DL}(t)\| \leq e^{-m}$ . In particular, choosing

$$t = \Theta(m\gamma^{-1/2}), \quad (17)$$

is enough to ensure that the shrinking factor  $\Delta$  of  $K(m, t, \ell)$  is asymptotically the same as that of  $(\text{DL}(t))^\ell$  (from Lemma 3.1), that is

$$\Delta = e^{-\Omega(m\ell)}, \quad (18)$$

see Theorem 4.1.

Next, we need to understand the Schmidt rank  $D$  of  $K(m, t, \ell)$ . Fixing  $t$  as in Eq. (17), in Sec. 5 we show that if

$$\ell = \Theta(m^{5/2}L^{1/2}\gamma^{-1/4}), \quad (19)$$

then we have the upper bound

$$D = e^{\tilde{O}(mtL+\ell)} = e^{\tilde{O}(m^2L\gamma^{-1/2}+\ell)}, \quad (20)$$

see Theorem 5.1 (below we give some high level explanation for Eq. (20)). We then choose  $m$  to satisfy  $D \cdot \Delta < 1/2$  so that Theorem 1.3 can be applied. Comparing Eqs. (18, 19, 20) we see that this leads to

$$m = \tilde{\Theta}(L^{1/3}\gamma^{-1/6}). \quad (21)$$

The entanglement entropy of the ground state  $|\Omega\rangle$  is upper bounded using Theorem 1.3 as

$$10 \log(D) = \tilde{O}(L^{5/3}\gamma^{-5/6})$$

as claimed in Theorem 1.1. Here we are hiding factors polylogarithmic in  $d, L, \gamma^{-1}$  in the  $\tilde{O}(\cdot)$  notation, while in Sec. 6 we give a more explicit proof which carries them around.

The most involved technical component of this work is to establish the bound Eq. (20) on  $D$ . We use a variant of an argument from Ref. [8], which can be understood at a high level as follows. Imagine starting with the definition (15) of our AGSP and then expanding the degree- $11m$  polynomial  $p_{\text{AND}}$  and the degree- $f$  polynomials  $\{\hat{Q}_j\}$  where  $f$  is given by Eq. (13). Looking at the total degree of the polynomials we are expanding and multiplying by the power  $\ell$ , we see that  $K(m, t, \ell)$  can be written as a sum of terms, each of which is a product  $P$  of at most  $O(m \cdot f \cdot \ell)$  operators from the set  $Q_{\text{rest}} \cup \{H_i\}_{i \in \text{Loc}}$ , where  $\text{Loc} \subset [n]$  is a set of  $\sim 4mt$  column indices centered around the cut of interest. Consider now a *single* such product  $P$  in the expansion. Since  $|\text{Loc}| = O(mt)$ , we can always find an index  $k \in \text{Loc}$  such that the number of times  $H_k$  occurs in  $P$  is at most  $O(mf\ell/(mt)) = O(f\ell/t)$ . Therefore  $P$  has Schmidt rank at most  $e^{\tilde{O}(f\ell/t)}$  across the cut  $(k, k+1)$ . Since  $k$  is at most  $4mt$  columns away from  $c$ , and since each column contains  $L$  qudits, the operator  $P$  has Schmidt rank at most

$$e^{\tilde{O}(f\ell/t + mtL)} \quad (22)$$

across the cut  $(c, c+1)$  of interest. With our choice of  $m, t, \ell$  given in Eqs. (21,17,19) and with  $f$  given by Eq. (13), one can confirm that the expression Eq. (22) coincides with Eq. (20) which is the bound we are trying to establish. Unfortunately, Eq. (22) is only an upper bound on the Schmidt rank of each product  $P$ , while we are interested in an upper bound on the Schmidt rank of  $K(m, t, \ell)$  which is a sum of many such products. It turns out that naively bounding the latter quantity by the number of products times Eq. (22) is not good enough to obtain the desired result. In other words, the only problem with the above proof technique is that the decomposition of the AGSP as a sum of products  $P$  has too many such terms. In Sec. 5 we prove the bound Eq. (20) using a variant of the above strategy which is based on an expansion of  $K(m, t, \ell)$  as a sum of (far fewer) well-structured operators of a certain form, which take the place of the products  $P$  considered above. Since we were initially guided by the back-of-the-envelope estimate Eq. (22), it is fortunate that the actual proof is close enough in spirit that it provides the same asymptotic bound on Schmidt rank of our AGSP.

## 4 Shrinking factor of the AGSP

In this Section we use the properties of the robust polynomial  $p_{\text{AND}}$  summarized in Theorem 2.2 to upper bound the shrinking factor  $\Delta$  of our AGSP.

**Theorem 4.1 (AGSP shrinking bound).** *Let  $|\psi\rangle \in G_{\perp}$  be a normalized state. Then for all  $\ell \geq 1$  we have*

$$\|K(m, t, \ell) |\psi\rangle\|^2 \leq \Delta \quad \text{where} \quad \Delta = (e^{-m} + 2e^{-t\sqrt{7}/25})^{2\ell}. \quad (23)$$

*Proof.* Note that it suffices to prove the claim for  $\ell = 1$  since the result for higher  $\ell$  follows straightforwardly from this special case. Recall that the Hermitian operators  $\hat{Q}_1, \hat{Q}_2, \dots, \hat{Q}_m$  mutually commute and therefore can be simultaneously diagonalized. Since  $p_{\text{AND}}$  is a polynomial with real coefficients,  $p_{\text{AND}}(\hat{Q}_1, \hat{Q}_2, \dots, \hat{Q}_m)$  is a Hermitian operator. Let us write  $\Pi_j^{(x)}$  for the projector onto the eigenspace of  $\hat{Q}_j$  with eigenvalue  $x$ . Note that Lemma 3.2 states that  $\Pi_j^{(1)} = Q_j$  and all eigenvalues of each operator  $\hat{Q}_j$  lie in the range

$$x \in [-1/20, 1/20] \cup \{1\}. \quad (24)$$

Thus

$$\begin{aligned} p_{\text{AND}}(\hat{Q}_1, \hat{Q}_2, \dots, \hat{Q}_m) &= \sum_{x_1, x_2, \dots, x_m} p_{\text{AND}}(x_1, x_2, \dots, x_m) \Pi_1^{(x_1)} \Pi_2^{(x_2)} \dots \Pi_m^{(x_m)} \\ &= p_{\text{AND}}(1, 1, \dots, 1) Q_1 Q_2 \dots Q_m + \sum_{\substack{x_1, x_2, \dots, x_m: \\ \exists i \text{ with } x_i \in [-1/20, 1/20]}} p_{\text{AND}}(x_1, x_2, \dots, x_m) \Pi_1^{(x_1)} \Pi_2^{(x_2)} \dots \Pi_m^{(x_m)} \end{aligned} \quad (25)$$

Using Theorem 2.2 and Eq. (24) we bound each term appearing the sum on the right-hand-side as

$$|p_{\text{AND}}(x_1, x_2, \dots, x_m)| \leq e^{-m} \quad \text{whenever} \quad \exists i \text{ with } x_i \in [-1/20, 1/20]. \quad (26)$$

Therefore, using the fact that  $p_{\text{AND}}(1, 1, 1 \dots, 1) = 1$  in Eq. (25) and the mutual orthogonality of the operators  $\{\Pi_1^{(x_1)} \Pi_2^{(x_2)} \dots \Pi_m^{(x_m)}\}_{x_1, x_2, \dots, x_m}$ , we get

$$\|p_{\text{AND}}(\widehat{Q}_1, \widehat{Q}_2, \dots, \widehat{Q}_m) - Q_1 Q_2 \dots Q_m\| \leq e^{-m},$$

and so

$$\begin{aligned} \|K(m, t, 1) - \text{DL}(t)\| &\leq \left\| \left( p_{\text{AND}}(\widehat{Q}_1, \widehat{Q}_2, \dots, \widehat{Q}_m) - Q_1 Q_2 \dots Q_m \right) Q_{\text{rest}} \right\| \\ &\leq \|p_{\text{AND}}(\widehat{Q}_1, \widehat{Q}_2, \dots, \widehat{Q}_m) - Q_1 Q_2 \dots Q_m\| \leq e^{-m}, \end{aligned} \quad (27)$$

where we used the fact that  $\|Q_{\text{rest}}\| = 1$ . Finally, for  $|\psi\rangle \in G_\perp$  we get, using the triangle inequality and Eq. (27),

$$\|K(m, t, 1) |\psi\rangle\| \leq \|\text{DL}(t) |\psi\rangle\| + e^{-m} \leq 2e^{-t\sqrt{\gamma}/25} + e^{-m},$$

where we used Lemma 3.1. Squaring both sides completes the proof.  $\square$

## 5 Schmidt Rank of the AGSP

In this section we bound the Schmidt rank of the operator  $K(m, t, \ell)$  across a vertical cut  $(c, c+1)$ . Let us begin by introducing some additional terminology. In the following we shall use the notation  $\text{SR}(O)$  to denote the Schmidt rank of an operator  $O$  across the vertical cut  $(c, c+1)$ .

For each coarse-grained projector  $Q_i$  with  $i \in [m]$ , there is a collection of  $2t$  column indices  $j \in [n]$ , such that column  $j$  is in the support of  $Q_i$  and every other coarse-grained projector  $Q_{i'}$  (with  $i' \neq i$ ) acts trivially on the  $L$  qudits  $j \times [L]$  in the column, see Fig. 2. Let these columns be  $\text{Ind}_i \subset [n]$  and define  $\text{Ind} \stackrel{\text{def}}{=} \cup_{i=1}^m \text{Ind}_i$ , so that

$$|\text{Ind}| = 2mt. \quad (28)$$

The set  $\text{Ind}$  is depicted in blue in Fig. 2.

For each  $i = 1, 2, \dots, m$  we also define the set of indices  $\text{Loc}_i \subset [n-1]$  such that

$$h_i = \sum_{j \in \text{Loc}_i} H_j \quad (29)$$

and let  $\text{Loc} \stackrel{\text{def}}{=} \cup_{i=1}^m \text{Loc}_i$ . Recall that  $Q_i$  is the projector onto the ground space of the Hamiltonian  $h_i$ . Note that  $|\text{Loc}_i| = 4t - 1$  and therefore

$$|\text{Loc}| \leq 4tm. \quad (30)$$

Recall that

$$f \stackrel{\text{def}}{=} \left\lceil 4\sqrt{tL/\gamma} \right\rceil \quad (31)$$

is the degree of the polynomial  $\text{Step}_{f,g}(x)$  that was used in the definition Eq. (13) of  $\widehat{Q}_j$ . We shall also write

$$r \stackrel{\text{def}}{=} 11m \quad (32)$$

for the degree of the polynomial  $p_{\text{AND}}$  defined in Theorem 2.2.

Our bound on  $\text{SR}(K(m, t, \ell))$  is summarized as follows.

**Theorem 5.1.** *Let  $c \in [n - 1]$  be a column label such that  $c \bmod 6t = 2t$ . Let  $\ell, m, t$  be chosen such that*

$$\ell \leq \frac{m^2 t^2 L}{fr}, \quad (33)$$

where  $r, f$  are defined by Eqs. (31, 32). Then the Schmidt rank of  $K(m, t, \ell)$  across the cut  $(c, c + 1)$  is bounded as

$$\text{SR}(K(m, t, \ell)) \leq (6mtr)^{3\ell} (6mtdL)^{16mtL}. \quad (34)$$

In the remainder of this section we prove Theorem 5.1. We shall use a variant of the polynomial interpolation technique introduced in Ref. [8]. We introduce a formal complex variable  $Z_j$  for each  $j \in \text{Loc}$ , and generalize Definition 13 to

$$\widehat{Q}_k(\vec{Z}) \stackrel{\text{def}}{=} \text{Step}_{f,g} \left( \frac{1}{4tL} \sum_{j \in \text{Loc}_k} Z_j H_j \right) \quad k = 1, 2, \dots, m. \quad (35)$$

Note that  $\widehat{Q}_k(1, 1, \dots, 1) = \widehat{Q}_k$  which can be seen from Eqs. (13, 29, 35). We define

$$K(\vec{Z}) \stackrel{\text{def}}{=} \left[ p_{\text{AND}} \left( \widehat{Q}_1(\vec{Z}), \widehat{Q}_2(\vec{Z}), \dots, \widehat{Q}_m(\vec{Z}) \right) Q_{\text{rest}} \right]^\ell, \quad (36)$$

where for brevity, we have suppressed the dependence of  $K(\vec{Z})$  on  $m, t, \ell$ . The operator  $K(\vec{Z})$  coincides with  $K(m, t, \ell)$  when  $\vec{Z} = (1, 1, \dots, 1)$ , and therefore by upper bounding  $\text{SR}(K(\vec{Z}))$  for general  $\vec{Z}$ , we also upper bound  $\text{SR}(K(m, t, \ell))$ . To this end, we use Eqs. (35, 36) and the fact that  $\text{Step}_{f,g}$  is a polynomial to expand  $K(\vec{Z})$  as a multinomial in complex variables with operator coefficients:

$$K(\vec{Z}) = \sum_{\vec{\beta} = \{\beta_j\}_{j \in \text{Loc}}} \text{Op}(\vec{\beta}) \prod_{j \in \text{Loc}} (Z_j)^{\beta_j}, \quad (37)$$

where  $\beta_j \in \{0, 1, 2, \dots\}$  counts the number of times  $H_j$  appears in the operator  $\text{Op}(\vec{\beta})$ . The following lemma upper bounds  $\text{SR}(K(\vec{Z}))$  in terms of the maximum Schmidt rank of one of the operators appearing on the right-hand side of Eq. (37).

**Lemma 5.2.**

$$\text{SR}(K(\vec{Z})) \leq M \cdot \max_{\vec{\beta}} \text{SR} \left( \text{Op}(\vec{\beta}) \right), \quad (38)$$

where

$$M \stackrel{\text{def}}{=} \left( 3 + \frac{3r f \ell}{4tm} \right)^{4tm}. \quad (39)$$

*Proof.* It suffices to show that the number of nonzero terms on the RHS of the expansion (37) is at most  $M$ . Recall that each  $\widehat{Q}_j$  is a polynomial of degree  $f$  and  $p_{AND}$  is a polynomial of degree  $r$ . Therefore, the operator  $p_{AND}(\widehat{Q}_1(\vec{Z}), \widehat{Q}_2(\vec{Z}), \dots, \widehat{Q}_m(\vec{Z}))$  has total degree of at most  $rf$  in the  $\vec{Z}$  variables and by definition Eq. (36), the total degree of  $K(\vec{Z})$  is at most  $fr\ell$ . Comparing with Eq. (37) we see that

$$\sum_{j \in \text{Loc}} \beta_j \leq r f \ell \quad (40)$$

for any tuple  $\vec{\beta}$  that appears on the right-hand side of Eq. (37). Therefore, the number of nonzero terms in the expansion (37) is upper bounded by the number of tuples of non-negative integers  $\{\beta_j\}_{j \in \text{Loc}}$  satisfying Eq. (40).

The number of such tuples is<sup>3</sup>

$$\binom{|\text{Loc}| + fr\ell}{|\text{Loc}|} \leq \binom{4mt + fr\ell}{4mt} \leq \left( e \cdot \frac{4mt + fr\ell}{4mt} \right)^{4mt} \leq M,$$

which completes the proof. Here in the first inequality we used  $|\text{Loc}| \leq 4mt$  and in the second we used the fact that  $\binom{a}{b} \leq (e \cdot a/b)^b$ .  $\square$

The natural next step is to upper bound  $\text{SR}(\text{Op}(\vec{\beta}))$  for any  $\vec{\beta}$  appearing in Eq. (37). Note that  $\text{Op}(\vec{\beta})$  can be expressed as a linear combination of products of the operators taken from the set  $\{H_j : j \in \text{Loc}\} \cup \{Q_{\text{rest}}\}$ . For example, it may contain the product  $H_5 H_1 Q_{\text{rest}} H_2 Q_{\text{rest}} H_1 \dots$ . By definition, any such product only appears in  $\text{Op}(\vec{\beta})$  if the number of occurrence of  $H_j$  is equal to  $\beta_j$ , and the number of occurrence of  $Q_{\text{rest}}$  is equal to  $\ell$ . Equipped with this expansion of  $\text{Op}(\vec{\beta})$ , we can try to upper bound its Schmidt rank by the number of terms in the expansion multiplied by the maximum Schmidt rank of any term. Unfortunately, this strategy does not provide a useful upper bound on  $\text{SR}(\text{Op}(\vec{\beta}))$  because the number of terms in the expansion is too large.

Instead of expressing  $\text{Op}(\vec{\beta})$  as a linear combination of products of operators from the set  $\{H_j : j \in \text{Loc}\} \cup \{Q_{\text{rest}}\}$ , we will show that  $\text{Op}(\vec{\beta})$  can be written as a linear combination of a relatively small number of well-structured operators of a certain form described below. For each of these well-structured operators there is a column label  $k$  (which is close to  $c$ ) such that the Schmidt rank of the operator across the vertical cut  $(k, k+1)$  is small. We will see that this in turn implies a small Schmidt rank for  $\text{Op}(\vec{\beta})$  across the cut  $(c, c+1)$  of interest.

For any  $k \in \text{Loc}$  and positive number  $R$ , we define the aforementioned well-structured operators as follows:

$$K_k^{\leq R}(\vec{Z}) \stackrel{\text{def}}{=} \sum_{\{\beta_j\}_{j \in \text{Loc}}: \beta_k \leq R} \text{Op}(\vec{\beta}) \prod_{j \in \text{Loc}} (Z_j)^{\beta_j}, \quad (41)$$

---

<sup>3</sup>Recall from elementary combinatorics that the number of  $p$ -tuples of non-negative integers  $(c_1, c_2, \dots, c_p)$  such that  $\sum_{j=1}^p c_j \leq q$  is equal to  $\binom{p+q}{p}$ .

which consists of all the terms in Eq. (37) satisfying the additional constraint  $\beta_k \leq R$ . The following lemma shows how the Schmidt rank of  $\text{Op}(\vec{\beta})$  is related to that of one of these well-structured operators.

**Lemma 5.3.** *Let*

$$R \stackrel{\text{def}}{=} \frac{rfl}{2mt}.$$

For any  $\text{Op}(\vec{\beta}')$  in the expansion (37) there exists a column label  $k \in \text{Ind}$  and a complex vector  $\vec{X} = \{X_j\}_{j \in \text{Loc}}$  such that

$$\text{SR}(\text{Op}(\vec{\beta}')) \leq M \cdot \text{SR}\left(K_k^{\leq R}(\vec{X})\right), \quad (42)$$

where  $M$  is defined in Eq. (39).

*Proof.* Consider any operator  $\text{Op}(\vec{\beta}')$  appearing in Eq. (37) and recall that  $\sum_j \beta'_j \leq rfl$ . By Eq. (28), the subset of column labels  $\text{Ind} \subset \text{Loc}$  has size  $|\text{Ind}| = 2mt$  and therefore

$$\sum_{j \in \text{Ind}} \beta'_j \leq \sum_{j \in \text{Loc}} \beta'_j \leq rfl.$$

It follows that there must exist some column label  $k \in \text{Ind}$  such that

$$\beta'_k \leq \frac{rfl}{|\text{Ind}|} = \frac{rfl}{2mt} = R. \quad (43)$$

So let  $k$  be fixed to the column label satisfying the above, and consider the operator  $K_k^{\leq R}(\vec{Z})$  defined in Eq. (41). Note that since the tuple  $\vec{\beta}'$  satisfies Eq. (43), it appears as one of the terms in the sum in Eq. (41). We have the following:

**Claim 5.4.** There exists a collection of complex tuples  $\vec{X}^{(1)}, \vec{X}^{(2)}, \dots, \vec{X}^{(M)}$  such that  $\text{Op}(\vec{\beta}')$  is a linear combination (with complex coefficients) of the operators

$$K_k^{\leq R}(\vec{X}^{(1)}), K_k^{\leq R}(\vec{X}^{(2)}), \dots, K_k^{\leq R}(\vec{X}^{(M)}). \quad (44)$$

*Proof.* Let  $\mathcal{T}$  be the set of all tuples of nonnegative integers  $\vec{\beta} = \{\beta_j\}_{j \in \text{Loc}}$  such that Eq. (40) is satisfied and  $\beta_k \leq R$ . That is,

$$\mathcal{T} = \left\{ \vec{\beta} = \{\beta_j\}_{j \in \text{Loc}} : \sum_{j \in \text{Loc}} \beta_j \leq rfl \quad \text{and} \quad \beta_k \leq R \right\}.$$

The set  $\mathcal{T}$  has size upper bounded as  $|\mathcal{T}| \leq M$  where  $M$  is given by Eq. (39). Consider the following system of equations.

$$\begin{aligned} K_k^{\leq R}(\vec{X}^{(1)}) &= \sum_{\vec{\beta} \in \mathcal{T}} \text{Op}(\vec{\beta}) \prod_{j \in \text{Loc}} \left(X_j^{(1)}\right)^{\beta_j}, \\ K_k^{\leq R}(\vec{X}^{(2)}) &= \sum_{\vec{\beta} \in \mathcal{T}} \text{Op}(\vec{\beta}) \prod_{j \in \text{Loc}} \left(X_j^{(2)}\right)^{\beta_j}, \\ &\vdots \\ K_k^{\leq R}(\vec{X}^{(|\mathcal{T}|)}) &= \sum_{\vec{\beta} \in \mathcal{T}} \text{Op}(\vec{\beta}) \prod_{j \in \text{Loc}} \left(X_j^{(|\mathcal{T}|)}\right)^{\beta_j}. \end{aligned}$$



We now show that there exists at least one choice of  $\vec{X}^{(1)}, \dots, \vec{X}^{(|\mathcal{T}|)}$  such that this system of equations can be inverted to obtain  $\text{Op}(\vec{\beta})$  as a linear combination of the operators appearing on the left-hand-side, for any  $\vec{\beta} \in \mathcal{T}$ . This is sufficient to complete the proof, as  $|\mathcal{T}| \leq M$ .

Consider the (square) matrix

$$G_{\alpha, \vec{\beta}} \stackrel{\text{def}}{=} \prod_{j \in \text{Loc}} \left( X_j^{(\alpha)} \right)^{\beta_j} \quad \alpha = 1, 2, \dots, |\mathcal{T}| \quad \vec{\beta} \in \mathcal{T}$$

We show that this matrix has non-zero determinant for some choice of  $\vec{X}^{(1)}, \dots, \vec{X}^{(|\mathcal{T}|)}$ . This implies the matrix is invertible and completes the proof.

Fix some order over  $\vec{\beta} \in \mathcal{T}$  and let  $\vec{\beta}(\alpha)$  be the  $\alpha$ -th  $\vec{\beta}$  in this order. We have

$$\det(G) = \sum_{\pi} (-1)^{\text{sign}(\pi)} \prod_{\alpha} G_{\alpha, \vec{\beta}(\pi(\alpha))} = \sum_{\pi} (-1)^{\text{sign}(\pi)} \prod_{\alpha} \left( \prod_{j \in \text{Loc}} \left( X_j^{(\alpha)} \right)^{\beta(\pi(\alpha))_j} \right),$$

where  $\pi$  is a permutation over the set  $[1 : |\mathcal{T}|]$ . We would like to show that there exists at least one choice of  $\vec{X}^{(1)}, \dots, \vec{X}^{(|\mathcal{T}|)}$  such  $\det(G) \neq 0$ . To that aim, we consider  $\det(G)$  as a multinomial over the variables  $\vec{X}^{(1)}, \dots, \vec{X}^{(|\mathcal{T}|)}$  and show that it is not identically zero. Indeed, as the tuples  $\vec{\beta}(\alpha)$  are distinct for different  $\alpha$ 's, it follows that for any two distinct permutations  $\pi_1, \pi_2$ , the multinomials  $\prod_{\alpha} \left( \prod_{j \in \text{Loc}} \left( X_j^{(\alpha)} \right)^{\beta(\pi_1(\alpha))_j} \right)$  and  $\prod_{\alpha} \left( \prod_{j \in \text{Loc}} \left( X_j^{(\alpha)} \right)^{\beta(\pi_2(\alpha))_j} \right)$  are distinct. Therefore,  $\det(G)$  is a sum of distinct multinomials with coefficient in  $\{-1, 1\}$ , which implies in particular that  $\det(G)$  is not identically zero.  $\square$

Now Claim 5.4 implies in particular that  $\text{Op}(\vec{\beta}')$  can be expressed as a linear combination of  $M$  operators Eq. (44) and therefore has Schmidt rank upper bounded by  $M$  times the maximum Schmidt rank of one of these operators. This establishes Eq. (42) and completes the proof of Lemma 5.3.  $\square$

Combining Lemma 5.2 with Lemma 5.3 we obtain the following corollary:

**Corollary 5.5.** *Let  $R = \frac{fr\ell}{2mt}$ . There exists a column label  $k \in \text{Ind}$  and a complex vector  $\vec{X} = \{X_j\}_{j \in \text{Loc}}$  such that*

$$\text{SR}(K(\vec{Z})) \leq \left( 3 + \frac{3fr\ell}{4mt} \right)^{8mt} \text{SR} \left( K_k^{\leq R}(\vec{X}) \right).$$

for all complex vectors  $\vec{Z}$ .

The last ingredient we will use to prove Theorem 5.1 is a bound on the Schmidt rank of  $K_k^{\leq R}(\vec{X})$ .

**Lemma 5.6.** *Let  $k \in \text{Ind}$  be a column label,  $N$  be a positive integer, and  $\vec{Z} = \{Z_j\}_{j \in \text{Loc}}$  be a tuple of complex numbers. Then*

$$\text{SR}(K_k^{\leq N}(\vec{Z})) \leq 2^{N+\ell} L^N d^{4N+6mtL_r 3\ell} \left( 3 + \frac{3fr\ell}{2N} \right)^{2\ell+2N}. \quad (45)$$

*Proof.* To bound  $\text{SR}(K_k^{\leq N}(\vec{Z}))$ , which is defined with respect to the cut  $(c, c + 1)$ , we will first bound the Schmidt rank of  $K_k^{\leq N}(\vec{Z})$  across the cut  $(k, k + 1)$ , which we write as

$$\text{SR}_{k,k+1}(K_k^{\leq N}(\vec{Z})). \quad (46)$$

Since the column  $c$  sits in the middle of the  $6mt - 2t$  columns that support  $Q_1, Q_2, \dots, Q_m$  (see Fig. 2), it follows that the distance between  $c$  and  $k$  must not exceed  $3mt$ . Using the fact that for any operator  $O$  we have

$$\text{SR}_{c,c+1}(O) \leq (d^L)^{2|c-k|} \text{SR}_{k,k+1}(O),$$

which follows from the fact that the Hilbert space of each column has dimension  $d^L$ , we find that the Schmidt rank across the cut  $(c, c + 1)$  is bounded as

$$\text{SR}(K_k^{\leq N}(\vec{Z})) \leq d^{6mtL} \text{SR}_{k,k+1}(K_k^{\leq N}(\vec{Z})). \quad (47)$$

Let us then proceed with bounding the the Schmidt rank across the  $(k, k + 1)$  cut. By definition of the set  $\text{Ind}$ , for the given column label  $k \in \text{Ind}$ , there is a unique  $u \in \{1, 2, \dots, m\}$  such that  $k \in \text{Ind}_u$ . Below, we decompose the polynomial operator  $p_{\text{AND}}(\widehat{Q}_1(\vec{Z}), \widehat{Q}_2(\vec{Z}), \dots, \widehat{Q}_m(\vec{Z}))$ , which appears in the definition of  $K(\vec{Z})$  in (36), in powers of  $\widehat{Q}_u(\vec{Z})$ . Using the fact that the operators  $\widehat{Q}_1(\vec{Z}), \widehat{Q}_2(\vec{Z}), \dots, \widehat{Q}_m(\vec{Z})$  commute with each other, Theorem 2.2 implies

$$\begin{aligned} p_{\text{AND}}(\widehat{Q}_1(\vec{Z}), \widehat{Q}_2(\vec{Z}), \dots, \widehat{Q}_m(\vec{Z})) &= \sum_{\substack{\{i_1, \dots, i_m\} \\ i_1 + \dots + i_m \leq 5m}} A_{i_1}(\widehat{Q}_1(\vec{Z})) \cdot A_{i_2}(\widehat{Q}_2(\vec{Z})) \cdot \dots \cdot A_{i_m}(\widehat{Q}_m(\vec{Z})) \\ &= \sum_{i_u=0}^{5m} \sum_{s=0}^{5m-i_u} \mathcal{L}(s) A_{i_u}(\widehat{Q}_u(\vec{Z})) \mathcal{R}(s) \end{aligned} \quad (48)$$

where

$$\mathcal{L}(s) \stackrel{\text{def}}{=} \sum_{i_1 + \dots + i_{u-1} = s} A_{i_1}(\widehat{Q}_1(\vec{Z})) \cdot \dots \cdot A_{i_{u-1}}(\widehat{Q}_{u-1}(\vec{Z}))$$

is supported only on the columns  $j < k$  to the left of  $k$ , and

$$\mathcal{R}(s) \stackrel{\text{def}}{=} \sum_{i_{u+1} + \dots + i_m \leq 5m - s - i_u} A_{i_{u+1}}(\widehat{Q}_{u+1}(\vec{Z})) \cdot \dots \cdot A_{i_m}(\widehat{Q}_m(\vec{Z}))$$

is supported only on the columns  $j \geq k + 1$  to the right of  $k$ . In particular, neither  $\mathcal{L}(s)$  nor  $\mathcal{R}(s)$  increases the Schmidt rank across the cut  $(k, k + 1)$ .

Next, recall from Theorem 2.2 that each  $A_i$  is a polynomial of degree  $2i + 1$ . Expanding  $A_{i_u}(\widehat{Q}_u(\vec{Z}))$  in powers of  $\widehat{Q}_u(\vec{Z})$  in Eq. (48) and using the fact that all operators commute, we see that  $p_{\text{AND}}(\widehat{Q}_1(\vec{Z}), \widehat{Q}_2(\vec{Z}), \dots, \widehat{Q}_m(\vec{Z}))$  can be expressed as a linear combination of at most

$$5m \cdot 5m \cdot (2 \cdot 5m + 1) \leq (11m)^3 = r^3$$

terms of the form

$$\left(\widehat{Q}_u(\vec{Z})\right)^a \mathcal{L} \mathcal{R}$$

where  $a$  is a non-negative integer, the operator  $\mathcal{L}$  is supported only on columns  $j < k$  and the operator  $\mathcal{R}$  is supported only on columns  $j > k + 1$ . Both  $\mathcal{L}$  and  $\mathcal{R}$  depend on  $\vec{Z}$ , but neither of them depend on the variable  $Z_k$  corresponding to column  $k$ . Therefore

$$K(\vec{Z}) = \left(p_{\text{AND}} \left(\widehat{Q}_1(\vec{Z}), \widehat{Q}_2(\vec{Z}), \dots, \widehat{Q}_m(\vec{Z})\right) Q_{\text{rest}}\right)^\ell.$$

can be expressed as a linear combination of at most  $r^{3\ell}$  terms of the form

$$\left(\widehat{Q}_u(\vec{Z})\right)^{a_1} \mathcal{L}^{(1)} \mathcal{R}^{(1)} Q_{\text{rest}} \left(\widehat{Q}_u(\vec{Z})\right)^{a_2} \mathcal{L}^{(2)} \mathcal{R}^{(2)} Q_{\text{rest}} \dots \left(\widehat{Q}_u(\vec{Z})\right)^{a_\ell} \mathcal{L}^{(\ell)} \mathcal{R}^{(\ell)} Q_{\text{rest}}, \quad (49)$$

corresponding to possibly different choices of operators  $\{\mathcal{L}^{(j)}, \mathcal{R}^{(j)}\}$  and powers  $\{a_j\}$  satisfying

$$\sum_{q=0}^{\ell} a_q \leq r\ell. \quad (50)$$

By expanding each of the polynomials  $\widehat{Q}_u(\vec{Z})$  we may expand each term Eq. (49) as a polynomial in  $Z_k$  with operator coefficients. We are interested in  $K_k^{\leq N}(\vec{Z})$  which includes only those terms with at most  $N$  powers of  $Z_k$  (see the definition in Eq. (41)). In the following we fix a term Eq. (49) (i.e., a choice of  $\{\mathcal{L}^{(j)}, \mathcal{R}^{(j)}\}$  and  $\{a_j\}$ ) and bound the Schmidt rank of all such operators with at most  $N$  powers of  $Z_k$  arising from it. Then we multiply by  $r^{3\ell}$  to obtain the desired upper bound on the Schmidt rank of  $K_k^{\leq N}(\vec{Z})$ .

So let us fix a term Eq. (49). Now,  $\widehat{Q}_u(\vec{Z})$  is a polynomial of degree  $f$  in the subregion operator

$$h_u(\vec{Z}) = \sum_{j \in \text{Loc}_u} H_j Z_j.$$

Let

$$C \stackrel{\text{def}}{=} \sum_{j \in \text{Loc}_u: j < k} H_j Z_j \quad \text{and} \quad D \stackrel{\text{def}}{=} \sum_{j \in \text{Loc}_u: j > k} H_j Z_j,$$

so that  $h_u(\vec{Z}) = C + H_k Z_k + D$ . Since  $[C, D] = 0$ , each degree- $(a_q f)$  polynomial  $\left(\widehat{Q}_u(\vec{Z})\right)^{a_q}$  appearing in Eq. (49) is a linear combination of terms of the form

$$\left(C^{\alpha_q^{(0)}} D^{\beta_q^{(0)}}\right) H_k Z_k \left(C^{\alpha_q^{(1)}} D^{\beta_q^{(1)}}\right) H_k Z_k \dots \left(C^{\alpha_q^{(T_q-1)}} D^{\beta_q^{(T_q-1)}}\right) H_k Z_k \left(C^{\alpha_q^{(T_q)}} D^{\beta_q^{(T_q)}}\right)$$

where  $0 \leq T_q \leq a_q f$ , and the nonnegative integers  $\{\alpha_q^{(j)}, \beta_q^{(j)}\}$  satisfy  $\sum_{j=0}^{T_q} (\alpha_q^{(j)} + \beta_q^{(j)}) \leq a_q f$ . Equation (49) then expands into terms of the form

$$\begin{aligned} & \left(C^{\alpha_1^{(0)}} D^{\beta_1^{(0)}}\right) H_k Z_k \left(C^{\alpha_1^{(1)}} D^{\beta_1^{(1)}}\right) H_k Z_k \dots \left(C^{\alpha_1^{(T_1)}} D^{\beta_1^{(T_1)}}\right) (\mathcal{L}^{(1)} \mathcal{R}^{(1)}) Q_{\text{rest}} \cdot \\ & \left(C^{\alpha_2^{(0)}} D^{\beta_2^{(0)}}\right) H_k Z_k \left(C^{\alpha_2^{(1)}} D^{\beta_2^{(1)}}\right) H_k Z_k \dots \left(C^{\alpha_2^{(T_2)}} D^{\beta_2^{(T_2)}}\right) (\mathcal{L}^{(2)} \mathcal{R}^{(2)}) Q_{\text{rest}} \cdot \dots \\ & \left(C^{\alpha_\ell^{(0)}} D^{\beta_\ell^{(0)}}\right) H_k Z_k \left(C^{\alpha_\ell^{(1)}} D^{\beta_\ell^{(1)}}\right) H_k Z_k \dots \left(C^{\alpha_\ell^{(T_\ell)}} D^{\beta_\ell^{(T_\ell)}}\right) (\mathcal{L}^{(\ell)} \mathcal{R}^{(\ell)}) Q_{\text{rest}}. \end{aligned} \quad (51)$$

where

$$\sum_{q=1}^{\ell} \sum_{j=0}^{T_q} (\alpha_q^{(j)} + \beta_q^{(j)}) \leq \sum_{q=1}^{\ell} a_q f \leq fr\ell, \quad (52)$$

and in the second inequality we used Eq. (50). Since we are concerned with  $K_k^{\leq N}(\vec{X})$ , we only consider the terms of the form (51), in which  $H_k Z_k$  occurs at most  $N$  times, that is,

$$\sum_{q=1}^{\ell} T_q \leq N. \quad (53)$$

Let us now count the number of such terms that satisfy the constraints Eqs. (52, 53). There are  $\binom{N+\ell}{\ell} \leq 2^{N+\ell}$  tuples  $(T_1, \dots, T_\ell)$  of nonnegative integers satisfying Eq. (53). For a fixed tuple  $(T_1, \dots, T_\ell)$ , note that the left-hand side of Eq. (52) is a sum of at most

$$2 \sum_{q=1}^{\ell} (T_q + 1) = 2(N + \ell)$$

nonnegative integers. Thus, for each tuple  $(T_1, \dots, T_\ell)$ , the number of choices for these nonnegative integers  $\{\alpha_q^{(j)}, \beta_q^{(j)}\}$  satisfying Eq. (52) is at most

$$\binom{2(N + \ell) + fr\ell}{2(N + \ell)} \leq \left( e \cdot \frac{2(N + \ell) + fr\ell}{2(N + \ell)} \right)^{2N+2\ell} \leq \left( 3 + \frac{3fr\ell}{2N} \right)^{2N+2\ell}.$$

Each choice for  $(T_1, \dots, T_\ell)$  and  $\{\alpha_q^{(j)}, \beta_q^{(j)}\}$  corresponds to exactly one operator as given in Eq. (51). Note that the operator  $H_k$  is a sum of at most  $L$  projectors  $P_{ij}$  which each have Schmidt rank at most  $d^4$  across the cut  $k, k+1$ . Therefore the operator Eq. (51) has Schmidt rank at most  $(Ld^4)^N$  across the cut  $(k, k+1)$ , as the term  $H_k$  occurs at most  $N$  times, and the operators ‘ $\mathcal{L}, \mathcal{R}, C, D$ ’ and  $Q_{\text{rest}}$  do not increase the Schmidt rank. Collecting all the contributions to the Schmidt rank across the cut  $(k, k+1)$ , we find that

$$\text{SR}_{k,k+1}(K_k^{\leq N}(\vec{Z})) \leq \underbrace{\binom{r^{3\ell}}{\# \text{ of terms Eq. (49)}}}_{\# \text{ of terms Eq. (49)}} \cdot \underbrace{2^{N+\ell} \left( 3 + \frac{3fr\ell}{2N} \right)^{2N+2\ell}}_{\substack{\# \text{ of operators Eq. (51)} \\ \text{with } \leq N \text{ powers of } Z_k \\ \text{arising from each term Eq. (49)}}} \cdot \underbrace{(Ld^4)^N}_{\substack{\text{SR of each op. Eq. (51)} \\ \text{with } \leq N \text{ powers of } Z_k}}.$$

Plugging this into Eq. (47) we obtain the desired bound Eq. (45) on the Schmidt rank across the cut  $(c, c+1)$ .  $\square$

*Proof of Theorem 5.1.* Combining Corollary 5.5 and Lemma 5.6 with  $N = R = \frac{fr\ell}{2mt}$ , we see that

$$\text{SR}(K(m, t, \ell)) \leq \left[ \left( 3 + \frac{3fr\ell}{4mt} \right)^{8mt} \right] \left[ 2^{\ell + \frac{fr\ell}{2mt}} L^{\frac{fr\ell}{2mt}} d^{\frac{2fr\ell}{mt} + 6mtL} r^{3\ell} (3 + 3mt)^{2\ell + \frac{fr\ell}{mt}} \right]. \quad (54)$$

Here the two terms in square parentheses come from the corollary and lemma, respectively. Using Eq. (33) we see that

$$\begin{aligned} 2^\ell (3 + 3mt)^{2\ell + \frac{fr\ell}{mt}} d^{\frac{2fr\ell}{mt} + 6mtL} L^{\frac{fr\ell}{2mt}} &\leq 2^\ell (6mt)^{2\ell + mtL} d^{8mtL} L^{mtL/2} \\ &\leq (6mt)^{3\ell + mtL} (dL)^{8mtL}, \end{aligned} \quad (55)$$

and using Eq. (33) again we get

$$2^{\frac{fr\ell}{2mt}} \left(3 + \frac{3fr\ell}{4mt}\right)^{8mt} \leq 2^{mtL/2} \left(3 + \frac{3mtL}{4}\right)^{8mt} \leq (2^{1/16} \cdot 4 \cdot mtL)^{8mtL} \leq (6mtL)^{8mtL}. \quad (56)$$

Plugging the bounds Eqs. (55,56) into Eq. (54), we arrive at Eq. (34) and complete the proof.  $\square$

## 6 Proof of the subvolume law for a vertical cut

We now prove Theorem 1.1.

*Proof.* Let us begin by specifying choices for the positive integers  $t, \ell$  and odd positive integer  $m$  which determine the AGSP  $K(m, t, \ell)$ . We choose the coarse-graining parameter as follows:

$$t = \left\lceil \frac{25m}{\sqrt{\gamma}} \right\rceil. \quad (57)$$

With this choice, the bound on the shrinking factor  $\Delta$  of  $K(m, t, \ell)$  from Eq. (23) can be simplified to

$$\Delta \leq \Delta' \stackrel{\text{def}}{=} 3^{2\ell} e^{-2m\ell}. \quad (58)$$

For future reference we note that since  $m$  is a positive integer and  $\gamma \leq 1$  we have

$$t \leq \frac{26m}{\sqrt{\gamma}}. \quad (59)$$

We choose

$$\ell = \left\lceil \frac{m^2 t^2 L}{fr} \right\rceil \quad (60)$$

so that the condition Eq. (33) is satisfied. For future reference we note that

$$(\ell + 1) \geq \frac{m^2 t^2 L}{fr} = \frac{mt^2 L}{11f} \geq \frac{mt^{3/2} \sqrt{L\gamma}}{55} \geq \frac{(25)^{3/2}}{55} \cdot \frac{m^{5/2} \sqrt{L}}{\gamma^{1/4}}, \quad (61)$$

where the second inequality uses  $f = \lceil 4\sqrt{\frac{tL}{\gamma}} \rceil \leq 5\sqrt{\frac{tL}{\gamma}}$ . Since  $25^{3/2}/55 > 2$  and  $m, L, \gamma^{-1} \geq 1$  we see that

$$\ell \geq \frac{2m^{5/2} \sqrt{L}}{\gamma^{1/4}} - 1 \geq \frac{m^{5/2} \sqrt{L}}{\gamma^{1/4}}. \quad (62)$$

It remains to choose  $m$ . Let us choose it to ensure that the parameters of the AGSP  $K(m, t, \ell)$  satisfy  $D \cdot \Delta \leq 1/2$  so that Theorem 1.3 can be applied.

Here  $D$  is the upper bound on  $\text{SR}(K(m, t, \ell))$  given by Theorem 5.1 and  $\Delta$  is upper bounded in Eq. (58). Using these bounds, plugging in  $r = 11m$ , and taking logs we see that

$$D \cdot \Delta \leq \frac{1}{2} \quad \text{if the following condition holds:}$$

$$3\ell \log(66m^2t) + 16mtL \log(6mtdL) - 2m\ell + 2\ell \log(3) \leq -\log(2). \quad (63)$$

We now choose

$$m \stackrel{\text{def}}{=} \left\lceil \frac{10^4 L^{1/3}}{\gamma^{1/6}} \log^{2/3}(dL\gamma^{-1}) \right\rceil_{\text{Odd}}, \quad (64)$$

where  $\lceil x \rceil_{\text{Odd}}$  denotes the smallest odd integer which is at least  $x$  (recall that in the definition of  $K(m, t, \ell)$ , we require  $m$  to be an odd positive integer). Note that since  $\gamma \leq 1$ ,  $L \geq 1$ , and  $d \geq 1$  we have

$$10^4 \leq m \leq \frac{2 \cdot 10^4 L^{1/3}}{\gamma^{1/6}} \log^{2/3}(dL\gamma^{-1}). \quad (65)$$

**Claim 6.1.** The chosen parameters  $m, t, \ell$  given by Eqs. (64, 57, 60) satisfy the inequality Eq. (63).

The proof of the Claim is provided below. Let us now see how it implies the theorem. First consider the special case where the cut  $(c, c+1)$  satisfies  $c \bmod 6t = 2t$ . Since we have  $D \cdot \Delta \leq D \cdot \Delta' \leq \frac{1}{2}$  we may apply Theorem 1.3 which states that the entanglement entropy of  $|\Omega\rangle$  across the cut  $(c, c+1)$  is upper bounded by

$$10 \log(D) \leq 10 \log\left(\frac{1}{2\Delta'}\right) = 10 \log\left(\frac{3^{-2\ell}}{2} e^{2m\ell}\right) \leq 20m\ell. \quad (66)$$

Now substituting  $f \geq 4\sqrt{tL}/\gamma$ ,  $r = 11m$ , and Eq. (59) in Eq. (60) gives

$$\ell \leq \frac{m\sqrt{L}t^{3/2}}{44} \sqrt{\gamma} \leq \frac{26^{3/2} m^{5/2} \sqrt{L}}{44 \gamma^{1/4}} \leq \frac{4m^{5/2} \sqrt{L}}{\gamma^{1/4}}. \quad (67)$$

Plugging Eq. (67) into Eq. (66) and using Eq. (65) gives

$$10 \log(D) \leq 80 \cdot \frac{m^{7/2} \sqrt{L}}{\gamma^{1/4}} \leq \frac{91 \cdot 10^{15} L^{5/3}}{\gamma^{5/6}} \log^{7/3}(dL\gamma^{-1}). \quad (68)$$

This completes the proof of the theorem in the special case where  $c \bmod 6t = 2t$ . If  $c \bmod 6t \neq 2t$  then we find the nearest  $c$  that satisfies this property, losing an entanglement entropy of  $3tL \log d$ , by the subadditivity of entropy. Note that

$$3tL \log(d) \leq \frac{78mL}{\sqrt{\gamma}} \log(d) \leq \frac{156 \cdot 10^4 L^{4/3}}{\gamma^{2/3}} \log^{5/3}(dL\gamma^{-1}) \leq \frac{156 \cdot 10^4 L^{5/3}}{\gamma^{5/6}} \log^{7/3}(dL\gamma^{-1}) \quad (69)$$

where in the first inequality we used Eq. (59), in the second one we used the upper bound Eq. (65) and the fact that  $\log(d) \leq \log(dL\gamma^{-1})$ , and in the third inequality we used the facts that  $\gamma \leq 1$  and  $L \geq 1$ . The entanglement entropy across the cut of interest is then at most

$$3tL \log(d) + 10 \log(D) \leq \frac{10^{17} L^{5/3}}{\gamma^{5/6}} \log^{7/3}(dL\gamma^{-1}), \quad (70)$$

where we used Eqs. (68, 69), completing the proof.  $\square$

*Proof of Claim 6.1.* Note that for any  $m \geq 2$  (Cf. Eq. (65)) and any  $\ell \geq 1$  we have

$$-2m\ell + 2\ell \log(3) + \log(2) \leq -m\ell. \quad (71)$$

Thus it remains to show that

$$3\ell \cdot \log(66m^2t) + 16mtL \log(6mtdL) - m\ell \leq 0. \quad (72)$$

Below we show that

$$3\ell \log(66m^2t) \leq \frac{m\ell}{2} \quad \text{and} \quad 16mtL \log(6mtdL) \leq \frac{m\ell}{2}, \quad (73)$$

from which (72) follows directly.

It remains to establish Eq. (73). The first part follows using Eq. (59) and Eq. (65) which give

$$3 \log(66m^2t) \leq 3 \log(1716m^3\gamma^{-1/2}) \leq 3 \log(1716m^6) \leq m/2 \quad (74)$$

where in the second inequality we used the fact that  $\gamma^{-1/2} \leq m^3$  and in the third inequality we used the fact that  $3 \log(1716m^6) \leq m/2$  for  $m \geq 10^4$ . The fact that  $\gamma^{-1/2} \leq m^3$  follows from our definition of  $m$  in (64), which implies  $m \leq \frac{10^4 L^{1/3}}{\gamma^{1/6}} \log^{2/3}(dL\gamma^{-1}) \leq \gamma^{-1/6}$ . To establish the second part of Eq. (73), we use Eq. (62) and Eq. (64) to get

$$\frac{m\ell}{2} \geq \frac{m^{7/2} \sqrt{L}}{2\gamma^{1/4}} \geq \frac{(10^4)^{7/2}}{2} \cdot \frac{L^{5/3}}{\gamma^{5/6}} \log^{7/3}(dL\gamma^{-1}). \quad (75)$$

Also note, using Eqs. (59,65), that

$$mtL \leq 26m^2L\gamma^{-1/2} \leq \frac{104 \cdot 10^8 L^{5/3}}{\gamma^{5/6}} \log^{4/3}(dL\gamma^{-1}) \quad (76)$$

and therefore

$$\begin{aligned} 16mtL \log(6mtdL) &\leq 16mtL \left( \log \left( \frac{dL^{5/3}}{\gamma^{5/6}} \right) + \log(6 \cdot 104 \cdot 10^8) + \frac{4}{3} \log(\log(dL\gamma^{-1})) \right) \\ &\leq 16mtL \left( 3 \log(dL\gamma^{-1}) + 11 + \frac{4}{3} \log(dL\gamma^{-1}) \right) \\ &\leq (16 \cdot 16)mtL \log(dL\gamma^{-1}) \\ &\leq \frac{256 \cdot 104 \cdot 10^8 L^{5/3}}{\gamma^{5/6}} \log^{7/3}(dL\gamma^{-1}), \end{aligned} \quad (77)$$

where in the first and last steps we used Eq. (76). Combining Eqs. (75, 77) and using the fact that  $256 \cdot 104 \cdot 10^8 < 10^{14}/2$  establishes the second part of Eq. (73) and completes the proof.  $\square$

## 7 Subvolume law for rectangular regions

In this Section we consider bipartitions of the 2D grid into a rectangular region and its complement (see Fig. 1 (b)) and prove Theorem 1.2. Since the proof closely follows that of Theorem 1.1, we shall describe the (minor) modifications needed.

The main observation that we will need is that the construction of the AGSP  $K(m, t, \ell)$  and the proof of Theorem 1.1 are essentially one-dimensional, as they are entirely based upon the expression Eq. (2) for the Hamiltonian as a 1D nearest-neighbor chain of columns. In particular, we may reproduce the proofs and definitions in Sections 3-6 to bound the entanglement entropy for any bipartition of the 2D grid with the following properties:

1. We can partition the qudits of the 2D grid into subsets  $S_1, S_2, \dots$ , such that the Hamiltonian takes the form  $H = \sum_i H_i$ , where  $H_i$  is a sum of projectors which act nontrivially only on subsets  $S_i$  and  $S_{i+1}$ .
2. The positive integer  $L$  is an upper bound on the number of qudits in each subset, and on the number of projectors in each nearest-neighbor term  $H_i$ .
3. The bipartition of interest corresponds to a bipartition separating subsets  $S_i$  with  $i \leq c$  from those with  $i \geq c + 1$ .

Under these conditions we obtain an upper bound  $\frac{CL^{5/3}}{\gamma^{5/6}} \log^{7/3}(dL\gamma^{-1})$  on the entanglement entropy of the ground state, for some universal constant  $C > 0$ .

Looking more closely, note that **1.**, **3.** allow us to define the coarse grained projectors and AGSP as in Sec. 3 and the proof then only requires the following slightly weaker version of condition **2.** which concerns only a region of  $O(mt)$  subsets  $\{S_i\}$  of the qudits centered around the cut.

- 2'. Let  $J$  be the set of positive integers  $i$  such that  $S_i$  intersects the support of the coarse-grained projectors  $Q_1, Q_2, \dots, Q_m$  centered around the cut. Then  $L$  is an upper bound on the number of qudits in any subset  $S_i$  with  $i \in J$ , and an upper bound on the number of projector terms in  $H_i$  whenever  $i \in J$ .

To establish Theorem 1.2 we will show that conditions **1.**, **2'**, **3.** can be satisfied by a decomposition of the 2D grid into concentric bands as shown in Fig. 3 (c).

**Theorem 7.1 (Subvolume scaling for a rectangular cut).** *Let  $|\Omega\rangle$  be the unique ground state of a frustration-free Hamiltonian Eq. (2) on an  $n \times L$  grid of qudits with local dimension  $d$ . Its entanglement entropy across a rectangular cut with the inner region  $R \stackrel{\text{def}}{=} \{a+1, \dots, a+A\} \times \{b+1, b+2, \dots, b+B\}$  is at most*

$$\frac{10^{17}(4A+4B)^{5/3}}{\gamma^{5/6}} \log^{7/3}(4d(A+B)\gamma^{-1}). \quad (78)$$

*Proof outline.* Without loss of generality, assume that  $A > B$ . For convenience, we shall consider a larger rectangular 2D grid obtained by adding ancilla qudits to ensure the following (see Fig. 3):



- The lattice is a rectangle of dimensions  $(A + 2n') \times (B + 2n')$ , for some large positive integer  $n'$ . As before (see the remark after Eq. (15)) we will need the system size  $n'$  to be sufficiently large in order for our AGSP of interest to be well defined.
- The region  $R$  is centered with respect to the lattice.

We add local terms to the Hamiltonian  $H$  for each new plaquette, in such a way that (a) the local spectral gap  $\gamma$  is unchanged and (b) the new Hamiltonian has a unique ground state  $|\Omega\rangle \otimes |0\rangle^{\otimes N_{\text{anc}}}$  where  $N_{\text{anc}}$  is the number of ancillary qudits added to the grid. Note that the entanglement entropy of the ground state across the given cut is therefore unchanged. The new terms added to the Hamiltonian are as follows: for each plaquette with  $q < 4$  old qudits from original  $n \times L$  grid and  $4 - q$  new ancilla qudits, we add the projector  $\mathbb{1}^{\otimes q} \otimes (\mathbb{1} - |0\rangle\langle 0|^{\otimes 4-q})$ .

Now, as shown in Fig. 3 (c), we group the vertices of the lattice into concentric bands. Let the bands be indexed by positive integers in increasing order, from smallest to largest. The smallest band is the yellow rectangle in Figure 3 (c), of dimensions  $(A - B + 1) \times 1$  if  $B$  is odd and  $(A - B + 2) \times 2$  if  $B$  is even. We may then write the Hamiltonian  $H$  as

$$H = \sum_i H'_i \quad (79)$$

where  $H'_i$  contains all terms of  $H$  which acts nontrivially between the  $i$ th and  $i + 1$ th band. Viewing Eq. (79) as a 1D chain of bands, we are interested in the entanglement entropy of the ground state across the given cut separating the  $c$ th and  $c + 1$ th band, where

$$c \stackrel{\text{def}}{=} \left\lceil \frac{B - 2}{2} \right\rceil$$

The decomposition Eq. (79) therefore satisfies conditions **1.**, **3.** defined above with respect to the partition of the grid into bands. However, note that the number of qudits in the  $i$ th band and the number of local projectors in each term  $H'_i$  increases with the index  $i$ . Previously, for the 1D chain of columns described by Eq. (2), each column consisted of  $L$  qudits and each local term  $H_i$  contained at most  $L$  local projectors. Now, from Figure 3 (c), it can be noted that the number of qudits in the  $i + 1$ th band is 8 more than the number in the  $i$ th band. Similarly, the number of projectors in  $H'_{i+1}$  is at most 8 more than the number of projectors in  $H'_i$ . Write

$$L_0 = 2(A + B)$$

for the number of projectors in the term  $H'_c$  which crosses the cut of interest, and note that the number of qudits in the  $c$ th band is  $L_0 - 4$ .

Now consider an operator  $K(m, t, \ell)$  and choices of  $m, t, \ell$  defined exactly the same way as in Sections 3 and 6, but with the replacements  $H_i \rightarrow H'_i$ , “column”  $\rightarrow$  “band”, and  $L \rightarrow L' = 4(A + B)$ . Note that with these replacements, the coarse grained projectors  $Q_j$  for  $j = 1, 2, \dots, m$  have support contained in a contiguous region around the cut consisting of the bands

$$i \in \{c - 3mt + t + 1, \dots, c, c + 1, \dots, c + 3mt - t\}. \quad (80)$$

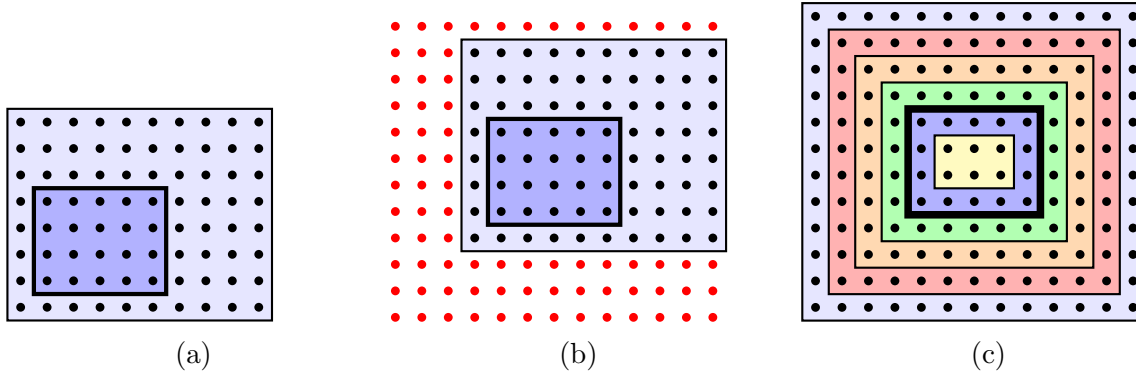

Figure 3: (a) The original lattice and region  $R$ . (b) Added ancilla qudits (in red) are used to transform the lattice into one of similar shape, such that  $R$  is centered. (c) The lattice can be divided into a family of concentric rectangular bands. The cut bipartitioning the lattice into the region  $R$  and its complement is shown in bold.

The number of qudits in each of the bands Eq. (80) is at most

$$L_0 - 4 + 8(3mt - t) \leq 2(A + B) + 24mt \quad (81)$$

and the number of local Hamiltonian terms in  $H_i$  for  $i$  in the set Eq. (80) is also upper bounded by the right-hand side of Eq. (81). As long as  $2(A + B) + 24mt = L'/2 + 24mt$  is at most  $L'$  (given the prescribed choices of  $m$  and  $t$ ), the Hamiltonian Eq. (79) satisfies conditions **1.**, **2'.**, **3.** with  $L \rightarrow L'$  and the proof of Theorem 1.1 goes through exactly the same as before. In this case we obtain the bound Eq. (78) on the entanglement entropy which is just the right-hand side of Eq. (70) with the replacement  $L \rightarrow L'$ . If, on the other hand, we find that the prescribed choices of  $m$  and  $t$  lead to the opposite inequality

$$L'/2 < 24mt,$$

then, substituting Eqs. (59, 65) with  $L \rightarrow L'$ , we get

$$(L')^2 < 48mtL' \leq 48 \cdot 26m^2 L' \gamma^{-1/2} \leq \frac{5 \cdot 10^{11} L^{5/3}}{\gamma^{5/6}} \log^{4/3}(dL\gamma^{-1})$$

In this case the trivial volume bound upper bounds the entanglement entropy as

$$(2(A + B))^2 \log(d) \leq L'^2 \log(d) \leq \frac{5 \cdot 10^{11} L^{5/3}}{\gamma^{5/6}} \log^{7/3}(dL\gamma^{-1}),$$

completing the proof. □

## 8 Acknowledgments

IA acknowledges the support of the Israel Science Foundation (ISF) under the Individual Research Grant No. 1778/17. DG thanks Justin Thaler for helpful discussions about polynomials. DG acknowledges the support of the Natural Sciences and Engineering Research Council of Canada (NSERC) under Discovery grant number RGPIN-2019-04198. IQC and PI are supported in part by the Government of Canada and the Province of Ontario.

## References

- [1] H. Abdul-Rahman, M. Lemm, A. Lucia, B. Nachtergaele, and A. Young. A class of two-dimensional AKLT models with a gap, 2019. arXiv preprint arXiv:1901.09297.
- [2] I. Affleck, T. Kennedy, E. H. Lieb, and H. Tasaki. Rigorous results on valence-bond ground states in antiferromagnets. *Phys. Rev. Lett.*, 59:799–802, Aug 1987.
- [3] D. Aharonov, I. Arad, Z. Landau, and U. Vazirani. The detectability lemma and quantum gap amplification. In *Proc. of STOC '09*, pages 417–426, New York, NY, USA, 2009. ACM.
- [4] D. Aharonov, I. Arad, U. Vazirani, and Z. Landau. The detectability lemma and its applications to quantum Hamiltonian complexity. *New J. Phys.*, 13(11):113043, 2011.
- [5] D. Aharonov, A. W. Harrow, Z. Landau, D. Nagaj, M. Szegedy, and U. Vazirani. Local tests of global entanglement and a counterexample to the generalized area law. In *Proc. of FOCS '14*, pages 246–255. IEEE, 2014.
- [6] F. C. Alcaraz, S. R. Salinas, and W. F. Wreszinski. Anisotropic ferromagnetic quantum domains. *Phys. Rev. Lett.*, 75:930–933, Jul 1995.
- [7] A. Anshu, I. Arad, and T. Vidick. Simple proof of the detectability lemma and spectral gap amplification. *Phys. Rev. B*, 93:205142, May 2016.
- [8] I. Arad, A. Kitaev, Z. Landau, and U. Vazirani. An area law and sub-exponential algorithm for 1D systems, 2013. arXiv preprint arXiv: 1301.1162.
- [9] I. Arad, Z. Landau, and U. Vazirani. An improved 1D area law for frustration-free systems. *Phys. Rev. B*, 85, 2012.
- [10] I. Arad, Z. Landau, U. Vazirani, and T. Vidick. Rigorous RG algorithms and area laws for low energy eigenstates in 1D. *Commun. Math. Phys.*, 356(1):65–105, Nov 2017.
- [11] K. Audenaert, J. Eisert, M. Plenio, and R. Werner. Entanglement properties of the harmonic chain. *Phys. Rev. A*, 66(4):042327, 2002.
- [12] J. Bausch, T. Cubitt, A. Lucia, and D. Perez-Garcia. Undecidability of the spectral gap in one dimension, 2018. arXiv preprint arXiv:1810.01858.
- [13] J. D. Bekenstein. Black holes and entropy. *Phys. Rev. D*, 7:2333–2346, Apr 1973.
- [14] L. Bombelli, R. K. Koul, J. Lee, and R. D. Sorkin. Quantum source of entropy for black holes. *Phys. Rev. D*, 34:373–383, Jul 1986.
- [15] F. G. S. L. Brandão and M. Cramer. Entanglement area law from specific heat capacity. *Phys. Rev. B*, 92:115134, Sep 2015.
- [16] F. G. S. L. Brandão and M. Horodecki. An area law for entanglement from exponential decay of correlations. *Nat Phys.*, 9:721–726, Sep 2013.

- [17] S. Bravyi. Efficient algorithm for a quantum analogue of 2-SAT. *Contemp. Math.*, 536:33–48, 2011.
- [18] S. Bravyi, L. Caha, R. Movassagh, D. Nagaj, and P. W. Shor. Criticality without frustration for quantum spin-1 chains. *Phys. Rev. Lett.*, 109:207202, Nov 2012.
- [19] R. W. C.-T. Gottstein. Ground states of the infinite q-deformed Heisenberg ferromagnet, 1995. arXiv preprint cond-mat/9501123.
- [20] C. Callan and F. Wilczek. On geometric entropy. *Phys. Lett. B*, 333(1-2):55–61, 1994.
- [21] J. Cho. Sufficient condition for entanglement area laws in thermodynamically gapped spin systems. *Phys. Rev. Lett.*, 113:197204, Nov 2014.
- [22] T. S. Cubitt, D. Perez-Garcia, and M. M. Wolf. Undecidability of the spectral gap. *Nature*, 528:207 – 211, Dec 2015. Article.
- [23] A. M. Dalzell and F. G. S. L. Brandao. Locally accurate mps approximations for ground states of one-dimensional gapped local hamiltonians, 2019. arXiv preprint arXiv:1903.10241.
- [24] J. Eisert, M. Plenio, and M. Cramer. Area laws for the entanglement entropy—a review. *Rev. Mod. Phys.*, 82:277–306, 2008.
- [25] D. Gosset and Y. Huang. Correlation length versus gap in frustration-free systems. *Phys. Rev. Lett.*, 116:097202, Mar 2016.
- [26] D. Gosset and E. Mozgunov. Local gap threshold for frustration-free spin systems. *J. Math. Phys.*, 57(9):091901, 2016.
- [27] M. B. Hastings. Lieb-Schultz-Mattis in Higher Dimensions. *Phys. Rev. B*, 69(104431), 2004.
- [28] M. B. Hastings. An area law for one dimensional quantum systems. *J. Stat. Mech.*, P08024, 2007.
- [29] M. B. Hastings and T. Koma. Spectral gap and exponential decay of correlations. *Commun. Math. Phys.*, 265(3):781–804, Aug 2006.
- [30] S. W. Hawking. Particle creation by black holes. *Commun. Math. Phys.*, 43(3):199–220, 1975.
- [31] C. Holzhey, F. Larsen, and F. Wilczek. Geometric and renormalized entropy in conformal field theory. *Nucl. Phys. B*, 424(3):443 – 467, 1994.
- [32] M. Horodecki, J. Oppenheim, and A. Winter. Partial quantum information. *Nature*, 436(7051):673–676, Aug 2005.
- [33] Y. Huang. Approximating local properties by tensor network states with constant bond dimension, 2019. arXiv preprint arXiv:1903.10048.

- [34] D. Kabat and M. Strassler. A comment on entropy and area. *Phys. Lett. B*, 329(1):46 – 52, 1994.
- [35] A. Kitaev. Fault-tolerant quantum computation by anyons. *Ann. Phys.*, 303(1):2 – 30, 2003.
- [36] A. Klumper, A. Schadschneider, and J. Zittartz. Equivalence and solution of anisotropic spin-1 models and generalized tj fermion models in one dimension. *J. Phys. A*, 24(16):L955, 1991.
- [37] A. Klümper, A. Schadschneider, and J. Zittartz. Groundstate properties of a generalized vbs-model. *Z. Phys. B*, 87(3):281–287, 1992.
- [38] S. Knabe. Energy gaps and elementary excitations for certain vbs-quantum antiferromagnets. *J. Stat. Phys.*, 52(3):627–638, Aug 1988.
- [39] T. Koma and B. Nachtergaele. The spectral gap of the ferromagnetic XXZ-chain. *Lett. Math. Phys.*, 40(1):1–16, Apr 1997.
- [40] Z. Landau, U. Vazirani, and T. Vidick. A polynomial time algorithm for the ground state of one-dimensional gapped local hamiltonians. *Nat Phys.*, 11, 2015.
- [41] J. I. Latorre, E. Rico, and G. Vidal. Ground state entanglement in quantum spin chains. *Quantum Info. Comput.*, 4:48–92, 2004.
- [42] M. Lemm. Finite-size criteria for spectral gaps in d-dimensional quantum spin systems, 2019. arXiv preprint arXiv:1902.07141.
- [43] M. Lemm and E. Mozgunov. Spectral gaps of frustration-free spin systems with boundary, 2018. arXiv preprint arXiv:1801.08915.
- [44] M. A. Levin and X.-G. Wen. String-net condensation: A physical mechanism for topological phases. *Phys. Rev. B*, 71:045110, Jan 2005.
- [45] E. Lieb and D. Robinson. The finite group velocity of quantum spin systems. *Commun. Math. Phys.*, 28:251–257, 1972.
- [46] L. Masanes. Area law for the entropy of low-energy states. *Phys. Rev. A*, 80:052104, Nov 2009.
- [47] S. Michalakis. Stability of the area law for the entropy of entanglement. *arXiv preprint arXiv:1206.6900*, 2012.
- [48] R. Movassagh and P. W. Shor. Supercritical entanglement in local systems: Counterexample to the area law for quantum matter. *Proc. Natl. Acad. Sci. U.S.A*, 113(47):13278–13282, 2016.
- [49] B. Nachtergaele and R. Sims. Lieb-robinson bounds and the exponential clustering theorem. *Commun. Math. Phys.*, 265(1):119–130, Jul 2006.

- [50] D. Perez-Garcia, F. Verstraete, M. M. Wolf, and J. I. Cirac. Peps as unique ground states of local hamiltonians. *Quantum Info. Comput.*, 8(6):650–663, July 2008.
- [51] N. Schuch, I. Cirac, and D. Perez-Garcia. Peps as ground states: Degeneracy and topology. *Ann. Phys.*, 325(10):2153 – 2192, 2010.
- [52] A. A. Sherstov. Making polynomials robust to noise. In *Proc. of STOC '12*, pages 747–758, New York, NY, USA, 2012. ACM.
- [53] M. Srednicki. Entropy and area. *Phys. Rev. Lett.*, 71(5):666, 1993.
- [54] B. M. Terhal. Is entanglement monogamous? *IBM J. Res. Dev.*, 48(1):71–78, Jan 2004.
- [55] G. Vidal, J. I. Latorre, E. Rico, and A. Kitaev. Entanglement in quantum critical phenomena. *Phys. Rev. Lett.*, 90:227902, Jun 2003.
- [56] S. R. White. Density-matrix algorithms for quantum renormalization groups. *Phys. Rev. B*, 48:10345–10356, Oct 1993.
- [57] M. M. Wolf, F. Verstraete, M. B. Hastings, and J. I. Cirac. Area laws in quantum systems: Mutual information and correlations. *Phys. Rev. Lett.*, 100:070502, Feb 2008.
- [58] Z. Zhang and I. Klich. Entropy, gap and a multi-parameter deformation of the Fredkin spin chain. *J. Phys. A*, 50(42):425201, 2017.

## A Robust AND polynomial

We now provide a proof of Theorem 2.2, following Ref. [52].

*Proof of Theorem 2.2.* For  $t \in \mathbb{R} \setminus \{0\}$  let  $\text{sign}(t) = t/|t|$  denote the sign of  $t$ . We may equivalently write

$$\text{sign}(t) = \frac{t}{\sqrt{1 + (t^2 - 1)}},$$

and we may then use the binomial series to expand the denominator (see, e.g., Eq. 3.2 of [52]). This gives the following series expansion which converges for  $0 < |t| < \sqrt{2}$

$$\text{sign}(t) = t \sum_{i=0}^{\infty} \left(-\frac{1}{4}\right)^i \binom{2i}{i} (t^2 - 1)^i \quad 0 < |t| < \sqrt{2}. \quad (82)$$

Now consider the following robust function for the Boolean monomial:

$$\text{int}(x) = \frac{1 + \text{sign}(2x - 1)}{2} = \begin{cases} 1 & \text{if } x > \frac{1}{2} \\ 0 & \text{if } x < \frac{1}{2} \end{cases}$$

Define

$$S = \left\{ x \in \mathbb{R} : 0 < |2x - 1| < \sqrt{2} \right\}.$$

For  $x \in S$  we may use Eq. (82) and separate out the  $i = 0$  term to express  $\text{int}(x)$  as

$$\text{int}(x) = x + \frac{2x-1}{2} \sum_{i=1}^{\infty} \binom{2i}{i} (x(1-x))^i = \sum_{i=0}^{\infty} A_i(x)$$

where we define polynomials

$$A_0(x) \stackrel{\text{def}}{=} x \quad \text{and} \quad A_i(x) \stackrel{\text{def}}{=} \frac{2x-1}{2} \binom{2i}{i} (x(1-x))^i \quad \text{for } i \geq 1.$$

Observe that  $A_i$  has real coefficients and degree  $2i+1$ , for all  $i \geq 0$ . For  $(x_1, x_2, \dots, x_m) \in S^m$ ,

$$\begin{aligned} \text{int}(x_1) \cdot \text{int}(x_2) \dots \text{int}(x_m) &= \sum_{i_1, i_2, \dots, i_m} A_{i_1}(x_1) A_{i_2}(x_2) \dots A_{i_m}(x_m) \\ &= \sum_{n=0}^{\infty} \sum_{i_1, i_2, \dots, i_m: i_1 + \dots + i_m = n} A_{i_1}(x_1) A_{i_2}(x_2) \dots A_{i_m}(x_m) \\ &\stackrel{\text{def}}{=} \sum_{n=0}^{\infty} \xi_n(x_1, \dots, x_m). \end{aligned} \tag{83}$$

Below we shall establish the following claim:

**Claim A.1.** For  $(x_1, x_2, \dots, x_m) \in \left( \left[ -\frac{1}{20}, \frac{1}{20} \right] \cup [1 - 1/20, 1 + 1/20] \right)^m$ ,

$$|\xi_n(x_1, x_2, \dots, x_m)| \leq 3^m \left( \frac{3}{5} \right)^n.$$

Let us define the robust polynomial  $p_{AND}$  by truncating the sum in Equation 83 to  $n \leq 5m$ :

$$p_{AND}(x_1, \dots, x_m) \stackrel{\text{def}}{=} \sum_{n=0}^{5m} \xi_n(x_1, \dots, x_m). \tag{84}$$

Since each  $A_i$  is a univariate polynomial with real coefficients and degree  $2i+1$ ,  $p_{AND}$  has real coefficients and degree

$$\max_{i_1+i_2+\dots+i_m \leq 5m} ((2i_1+1) + (2i_2+1) + \dots + (2i_m+1)) = 2(5m) + m = 11m. \tag{85}$$

In addition,

$$p_{AND}(1, 1, \dots, 1) = \sum_{n=0}^{5m} \xi_n(1, 1, \dots, 1) = \xi_0(1, 1, \dots, 1) = 1, \tag{86}$$

where we used the identity  $A_i(1) = 0$  for  $i \geq 1$  and  $A_0(1) = 1$ . Finally, suppose  $x = (x_1, x_2, \dots, x_m) = y + \epsilon$  where  $y \in \{0, 1\}^m$  and  $\epsilon \in [-1/20, 1/20]^m$ . Then for each  $1 \leq i \leq m$  we have

$$x_i \in [-1/20, 1/20] \cup [1 - 1/20, 1 + 1/20] \subset S$$

and

$$|p_{AND}(y + \epsilon) - y_1 y_2 \dots y_m| = |p_{AND}(x_1, x_2, \dots, x_m) - \text{int}(x_1) \text{int}(x_2) \dots \text{int}(x_m)|.$$

Using Eqs. (83, 84) and the triangle inequality to bound the right-hand side gives

$$\begin{aligned} |p_{AND}(y + \epsilon) - y_1 y_2 \dots y_m| &\leq \sum_{n=5m+1}^{\infty} |\xi_n(x_1, \dots, x_m)| \\ &\leq 3^m \sum_{n=5m+1}^{\infty} \left(\frac{3}{5}\right)^n \\ &= 3^m \left(\frac{3}{5}\right)^{5m} \cdot \frac{3}{2} \\ &\leq (3 \cdot (3/5)^5 \cdot (3/2))^m. \end{aligned}$$

Noting that  $3 \cdot (3/5)^5 \cdot (3/2) \leq e^{-1}$  we arrive at Eq. (7) and complete the proof.  $\square$

*Proof of Claim A.1.* Define  $J = [-1/20, 1/20] \cup [1 - 1/20, 1 + 1/20]$  and note that for all  $i \geq 1$  we have

$$\max_{x \in J} |A_i(x)| = \binom{2i}{i} \max_{x \in J} \left| \frac{2x-1}{2} (x(1-x))^i \right| \leq 4^i \cdot \left(\frac{1}{20}\right)^i \left(\frac{21}{20}\right)^i \leq \left(\frac{21}{100}\right)^i, \quad (87)$$

where we used the fact that  $\binom{2i}{i} \leq 4^i$ ,  $\max_{x \in J} \left| \frac{2x-1}{2} \right| \leq 1$ , and  $\max_{x \in J} |x(1-x)| \leq (1/20)(21/20)$ . Furthermore,

$$\max_{x \in J} |A_0(x)| = \max_{x \in J} |x| \leq \frac{21}{20}. \quad (88)$$

Combining Eqs (87, 88) we see that for all  $i \geq 0$ ,

$$\max_{x \in J} |A_i(x)| \leq \left(\frac{21}{20}\right) \left(\frac{21}{100}\right)^i. \quad (89)$$

Consequently, for  $(x_1, \dots, x_m) \in J^m$ , using the definition of  $\xi_n$  and the triangle inequality, we get

$$\begin{aligned} |\xi_n(x_1, \dots, x_m)| &\leq \sum_{i_1, i_2, \dots, i_m: i_1 + \dots + i_m = n} |A_{i_1}(x_1) A_{i_2}(x_2) \dots A_{i_m}(x_m)| \\ &\leq \left(\frac{21}{20}\right)^m \sum_{i_1, i_2, \dots, i_m: i_1 + \dots + i_m = n} \left(\frac{21}{100}\right)^{i_1 + i_2 + \dots + i_m} \end{aligned} \quad (90)$$

$$= \left(\frac{21}{20}\right)^m \left(\frac{21}{100}\right)^n \binom{m+n-1}{n-1}. \quad (91)$$

where we used Eq. (89) and the fact that the number of tuples  $(i_1, i_2, \dots, i_m)$  of nonnegative integers satisfying  $i_1 + i_2 + \dots + i_m = n$  is given by  $\binom{m+n-1}{n-1}$ . Finally, we substitute the bound  $\binom{m+n-1}{n-1} \leq 2^{m+n}$  into Eq. (91) to arrive at

$$|\xi_n(x_1, \dots, x_m)| \leq \left(\frac{42}{20}\right)^m \left(\frac{42}{100}\right)^n \leq 3^m (3/5)^n.$$

$\square$



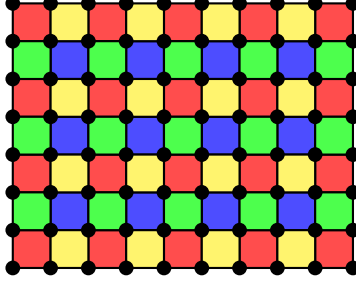

Figure 4: The local projectors can be divided into 4 groups, where the projectors in each group commute with each other.

## B Proof of Lemma 3.1

The proof is similar to that given in [7], which uses a Chebyshev polynomial function of the detectability operator, as suggested in [25]. The projectors  $\{P_{ij}\}$  can be divided into 4 groups as follows (see Figure 4), with the property that the projectors in each group commute with each other:

$$\begin{aligned} \mathcal{G}_1 &\stackrel{\text{def}}{=} \{P_{ij} : i = \text{odd}, j = \text{odd}\}, & \mathcal{G}_2 &\stackrel{\text{def}}{=} \{P_{ij} : i = \text{even}, j = \text{odd}\}, \\ \mathcal{G}_3 &\stackrel{\text{def}}{=} \{P_{ij} : i = \text{odd}, j = \text{even}\}, & \mathcal{G}_4 &\stackrel{\text{def}}{=} \{P_{ij} : i = \text{even}, j = \text{even}\}. \end{aligned}$$

We also define

$$DL_k \stackrel{\text{def}}{=} \prod_{P_{ij} \in \mathcal{G}_k} (\mathbb{1} - P_{ij}), \quad 1 \leq k \leq 4, \quad (92)$$

and define  $DL \stackrel{\text{def}}{=} DL_4 \cdot DL_3 \cdot DL_2 \cdot DL_1$ . From [7, Corollary 3], it holds that for any  $\psi$  satisfying  $\langle \psi | \Omega \rangle = 0$ , we have

$$\|DL |\psi\rangle\|^2 \leq \frac{1}{1 + \frac{\gamma}{8^2}} = \frac{1}{1 + \frac{\gamma}{64}}. \quad (93)$$

Here we used the fact that, for every projector  $P_{ij}$ , at most 8 projectors do not commute with it. Now, we have the following claim, which is proved towards the end. It uses the ‘light cone’ argument from [3].

**Claim B.1.** Let  $F$  be any univariate polynomial of degree at most  $t/6$  satisfying  $F(0) = 1$ . Then

$$DL(t) = (Q'_{2t} \cdot Q'_{8t} \cdot Q'_{14t} \cdot \dots) \cdot F(\mathbb{1} - DL^\dagger DL) \cdot (Q'_{5t} \cdot Q'_{11t} \cdot Q'_{17t} \cdot \dots). \quad (94)$$

Before proving this claim, we show how it can be used to establish Lemma 3.1. We apply the Claim with  $F = \text{Step}_{\frac{t}{6}, \frac{\gamma}{64+\gamma}}$  where the right-hand side is the polynomial from Fact 2.1. From this we see that for any  $\psi \in G_\perp$

$$\|DL(t) |\psi\rangle\|^2 \leq \|\text{Step}_{\frac{t}{6}, \frac{\gamma}{64+\gamma}}(\mathbb{1} - DL^\dagger DL) |\psi'\rangle\|^2$$

where  $\psi' \in G_\perp$  is the state

$$|\psi'\rangle = (Q'_{5t} \cdot Q'_{11t} \cdot Q'_{17t} \cdot \dots) |\psi\rangle / \|(Q'_{5t} \cdot Q'_{11t} \cdot Q'_{17t} \cdot \dots) |\psi\rangle\|.$$

But Eq. (93) ensures that the eigenvalues of  $DL^\dagger DL$  in  $G_\perp$  are at most  $\frac{1}{1+\frac{\gamma}{64}} = 1 - \frac{\gamma}{64+\gamma}$ . Using Fact 2.1 and the fact that  $\gamma \leq 1$ , we get

$$\|DL(t) |\psi\rangle\| \leq 2e^{-\frac{t}{3}\sqrt{\frac{\gamma}{64+\gamma}}} \leq 2e^{-\frac{t}{3}\sqrt{\frac{\gamma}{65}}} \leq 2e^{-\frac{t\sqrt{\gamma}}{25}}$$

*Proof of Claim B.1.* For every  $i \in [n-1]$  and  $k \in [4]$ , let

$$\Pi_{i,k} \stackrel{\text{def}}{=} \prod_{\mathbb{1}-P_{ij} \in \mathcal{G}_k: \text{Supp}(P_{ij}) \in \{i, i+1\}} (\mathbb{1} - P_{ij})$$

be the product of projectors from  $\mathcal{G}_k$  that are supported only on columns  $\{i, i+1\}$ . Since all projectors in  $\mathcal{G}_k$  commute,  $\Pi_{i,k}$  is also a projector and we can write  $DL_k = \prod_{i \in [n-1]} \Pi_{i,k}$ . For any  $S \subset [n]$ , define

$$DL_k^S \stackrel{\text{def}}{=} \prod_{i: \text{Supp}(\Pi_{i,k}) \cap S \neq \emptyset} \Pi_{i,k}$$

as the product of projectors  $\Pi_{i,k}$  that have their support overlapping with  $S$ .

The argument below has been illustrated in Figure 5. Let  $S_0$  be the complement of the support of  $(Q'_{2t} \cdot Q'_{8t} \cdot Q'_{14t} \cdot \dots)$ . Observe, using frustration-freeness, that for any  $\Pi_{i,k}$  whose support is contained in the support of  $(Q'_{2t} \cdot Q'_{8t} \cdot Q'_{14t} \cdot \dots)$ , we have

$$(Q'_{2t} \cdot Q'_{8t} \cdot Q'_{14t} \cdot \dots) \Pi_{i,k} = (Q'_{2t} \cdot Q'_{8t} \cdot Q'_{14t} \cdot \dots).$$

This implies the following identity (c.f. Figure 5 (b)):

$$(Q'_{2t} \cdot Q'_{8t} \cdot Q'_{14t} \cdot \dots) DL_1 = (Q'_{2t} \cdot Q'_{8t} \cdot Q'_{14t} \cdot \dots) DL_1^{S_0}. \quad (95)$$

For all integers  $\alpha \geq 1$ , recursively define  $S_\alpha$  as the set of all columns at distance at most 1 from  $S_{\alpha-1}$ . Clearly, we have the inclusion  $S_0 \subset S_1 \subset S_2 \dots$ . Similar to Eq. (95), we can ‘absorb’ some of the projectors in  $DL_1 DL_2$  and obtain the identity:

$$(Q'_{2t} \cdot Q'_{8t} \cdot Q'_{14t} \cdot \dots) DL_1 DL_2 = (Q'_{2t} \cdot Q'_{8t} \cdot Q'_{14t} \cdot \dots) DL_1^{S_0} DL_2^{S_1}. \quad (96)$$

Applying the same argument recursively, and using the fact that

$$(DL^\dagger DL)^p = (DL_1 \cdot DL_2 \cdot DL_3 \cdot DL_4 \cdot DL_3 \cdot DL_2)^p \cdot DL_1,$$

we conclude (c.f. Figure 5 (c))

$$(Q'_{2t} \cdot Q'_{8t} \cdot Q'_{14t} \cdot \dots) (DL^\dagger DL)^p = (Q'_{2t} \cdot Q'_{8t} \cdot Q'_{14t} \cdot \dots) DL_1^{S_0} \cdot DL_2^{S_1} \cdot DL_3^{S_2} \dots DL_1^{S_{6p}}. \quad (97)$$

If  $6p \leq t$ , the set  $S_{6p}$  is contained in the support of  $(Q'_{5t} \cdot Q'_{11t} \cdot Q'_{17t} \cdot \dots)$ . Furthermore, if  $\Pi_{i,k}$  is in the support of  $(Q'_{5t} \cdot Q'_{11t} \cdot Q'_{17t} \cdot \dots)$ , we have

$$\Pi_{i,k} (Q'_{5t} \cdot Q'_{11t} \cdot Q'_{17t} \cdot \dots) = (Q'_{5t} \cdot Q'_{11t} \cdot Q'_{17t} \cdot \dots).$$

Thus, all the projectors in  $DL_1^{S_0} \cdot DL_2^{S_1} \cdot DL_3^{S_2} \dots DL_1^{S_{6p}}$  can be ‘absorbed’ in  $(Q'_{5t} \cdot Q'_{11t} \cdot Q'_{17t} \dots)$ , which can be formalized as:

$$DL_1^{S_0} \cdot DL_2^{S_1} \cdot DL_3^{S_2} \dots DL_1^{S_{6p}} (Q'_{5t} \cdot Q'_{11t} \cdot Q'_{17t} \dots) = (Q'_{5t} \cdot Q'_{11t} \cdot Q'_{17t} \dots). \quad (98)$$

Combining Eqs. (97) and (98), we find that

$$(Q'_{2t} \cdot Q'_{8t} \cdot Q'_{14t} \dots) (DL^\dagger DL)^p (Q'_{5t} \cdot Q'_{11t} \cdot Q'_{17t} \dots) = (Q'_{2t} \cdot Q'_{8t} \cdot Q'_{14t} \dots) (Q'_{5t} \cdot Q'_{11t} \cdot Q'_{17t} \dots) \quad (99)$$

for any  $p \leq t/6$ . Thus, any such power  $(DL^\dagger DL)^p$  can be replaced by 1 whenever it is sandwiched between the products of projectors in Eq. (101). This implies that for a polynomial  $F$  of degree at most  $t/6$ , we have

$$(Q'_{2t} \cdot Q'_{8t} \cdot Q'_{14t} \dots) F(I - DL^\dagger DL) (Q'_{5t} \cdot Q'_{11t} \cdot Q'_{17t} \dots) = \quad (100)$$

$$(Q'_{2t} \cdot Q'_{8t} \cdot Q'_{14t} \dots) F(0) (Q'_{5t} \cdot Q'_{11t} \cdot Q'_{17t} \dots), \quad (101)$$

and using the fact that  $F(0) = 1$  completes the proof.  $\square$

## C Rényi entanglement entropy and PEPS description

The Rényi entropy of order  $\alpha \in (0, 1)$  is defined as

$$S_\alpha(\rho) = \frac{1}{1 - \alpha} \log \text{Tr}(\rho^\alpha).$$

Below we show that the Rényi entropy of order  $1/2$  satisfies the same subvolume law as in Theorem 1.2. This implies, via an argument from Ref. [33], the following PEPS description of the ground state. In the following we say an operator  $O$  is geometrically local if its support is contained in a contiguous region of  $O(1)$  qudits.

**Theorem C.1.** *Let  $\delta \in (0, 1)$  and suppose  $\gamma, d = \Omega(1)$ . There exists a PEPS state  $|\phi\rangle$  with bond dimension  $e^{O(\frac{1}{\delta^5} \log^{21}(\frac{1}{\delta}))}$  such that*

$$|\langle \Omega | O | \Omega \rangle - \langle \phi | O | \phi \rangle| \leq \delta,$$

for all geometrically local operators  $O$  satisfying  $\|O\| \leq 1$ .

*Proof sketch.* We essentially follow the proof of [33, Theorem 3], with a minor modification arising due to the fact that we are not considering periodic boundary conditions. Consider a partition of the lattice into regions shown in Figure 6. From Claim C.2, we conclude that  $S_{\frac{1}{2}}$  across any of the blue rectangular bi-partitions (with perimeter  $4m$ ) is upper bounded by  $O(m^{5/3} \log^{7/3}(m))$ . The width  $b$  of green rectangles is chosen so that that the reduced ground state in any blue region can be purified (up to an error of  $\frac{\delta}{2}$ ) in the associated green region. Using the upper bound on  $S_{\frac{1}{2}}$  from Claim C.2, the choice  $b = O(m^{2/3} \log^{7/3}(m) \log \frac{1}{\delta})$

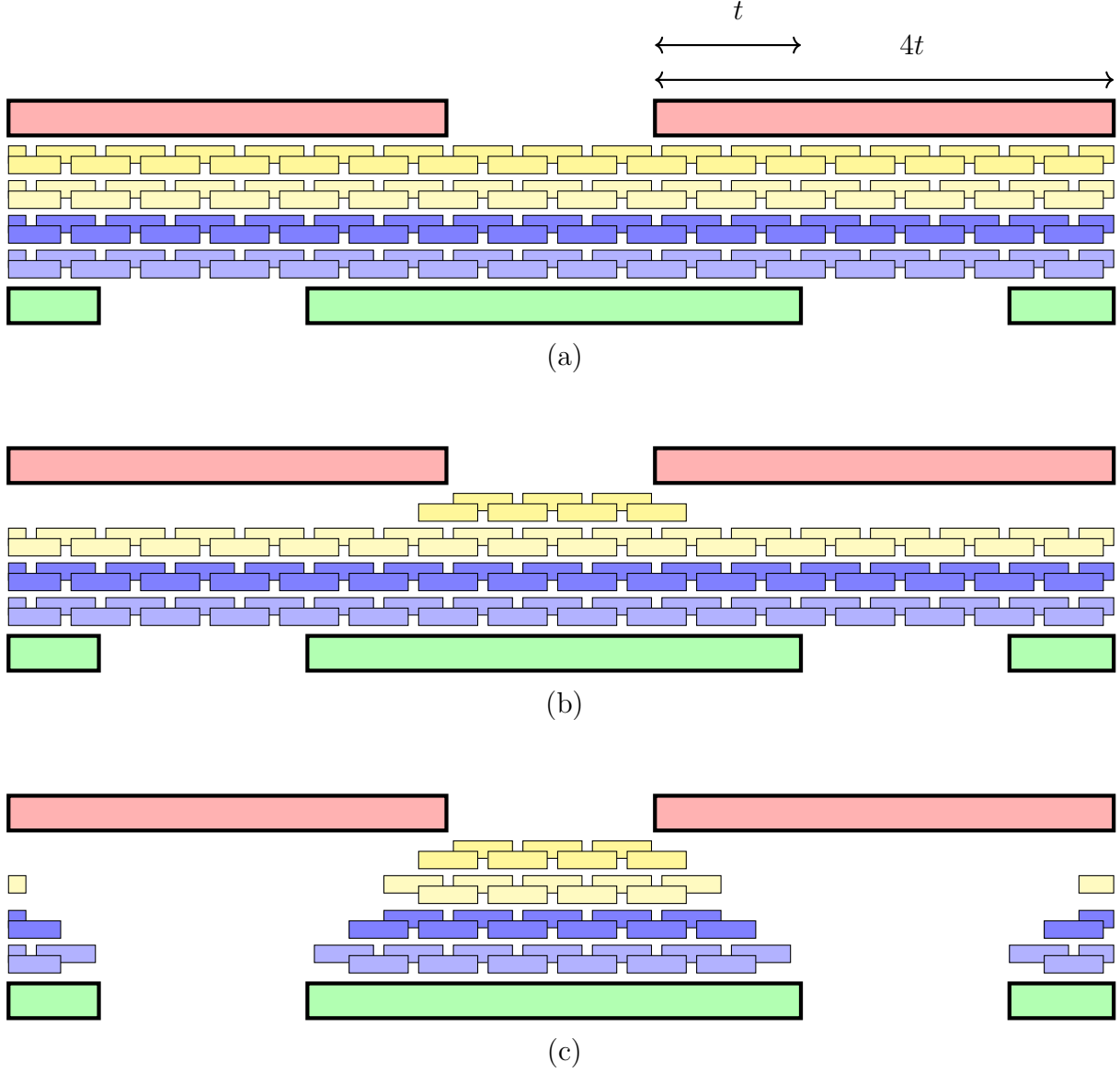

Figure 5: Graphical description of Eq. (97). **(a)** The operators  $DL_1, DL_2, DL_3, DL_4$  correspond to the dark yellow, light yellow, dark blue and light blue layers, respectively. Within each layer, all the projectors (small rectangles representing  $\Pi_{i,k}$ ) mutually commute, although they need not have disjoint support. Two projectors from different layers may not commute if they have overlapping support. **(b)**: Some projectors in  $DL_1$  are ‘absorbed’ by the red coarse-grained layer. Resulting operator is  $DL_1^{S_0}$  from Eqn. (95). **(c)**: The same process occurs for 4 steps, with projectors from  $DL_2, DL_3, DL_4$  absorbed in the red coarse-grained layer. The resulting operator is  $DL_1^{S_0} DL_2^{S_1} DL_3^{S_2} DL_4^{S_3}$  and the support of ‘unabsorbed’ projectors increases its boundary by one at each step. All the remaining projectors can be absorbed in the green coarse-grained layer, as they are contained in its support.

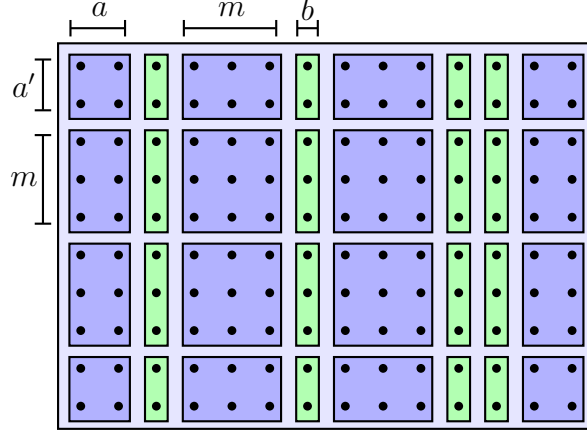

Figure 6: A partition of the lattice into several blue and green parts. The size of green parts is chosen so that the reduced ground state on blue regions (except the rightmost ones) can be purified in the green regions to their immediate right. The reduced ground state on the rightmost blue regions can be purified in the green regions to their immediate left. The subvolume law in Theorem 1.2 ensures that the size of green regions can be chosen much smaller than that of the blue regions. If  $a, a'$  are chosen uniformly and independently at random in the range  $\{1, 2, \dots, m\}$ , the probability that a local operator is not supported in a blue region is  $O\left(\frac{b}{m}\right)$ . This is depicted in Figure 7.

suffices, see Eq. (36) of Ref. [33]. The PEPS state is constructed in the same manner as given in [33, Theorem 3]. The error in approximating the local expectation value arises in two ways: first error of  $\frac{\delta}{2}$  incurred in approximate purification of the reduced density matrix and the second error of  $O\left(\frac{b}{m}\right)$  incurred if a local operator overlaps a green region for some choice of  $a, a'$  (see Figure 7). This gives a total error of (cf. Eq. (38) of Ref. [33])

$$\frac{\delta}{2} + O\left(\frac{b}{m}\right) = \frac{\delta}{2} + O\left(\frac{m^{5/3} \log^{7/3}(m) \log \frac{1}{\delta}}{m^2}\right) \leq \delta,$$

if we choose  $m = \Omega\left(\frac{1}{\delta^3} \log^{11}\left(\frac{1}{\delta}\right)\right)$ . This implies the existence of a PEPS state  $|\phi\rangle$  with bond dimension  $e^{O(m^{5/3} \log^{7/3}(m))} = e^{O\left(\frac{1}{\delta^3} \log^{21}\left(\frac{1}{\delta}\right)\right)}$ , which completes the proof.  $\square$

**Claim C.2.** Under the conditions of Theorem 1.2, for a bipartition corresponding to a rectangular region  $A$  and its complement, we have

$$S_{\frac{1}{2}}(\Omega_A) \leq O\left(\frac{|\partial A|^{5/3}}{\gamma^{5/6}} \log^{7/3}(d|\partial A|\gamma^{-1})\right).$$

*Proof.* The proof of Theorem 1.2 establishes the existence of a  $(D, \Delta)$ -AGSP with respect to the given rectangular bipartition such that  $D\Delta < 1/2$  and (cf. Theorem 1.3)

$$10 \log(D) \leq \frac{C|\partial A|^{5/3}}{\gamma^{5/6}} \log^{7/3}(d|\partial A|\gamma^{-1})$$

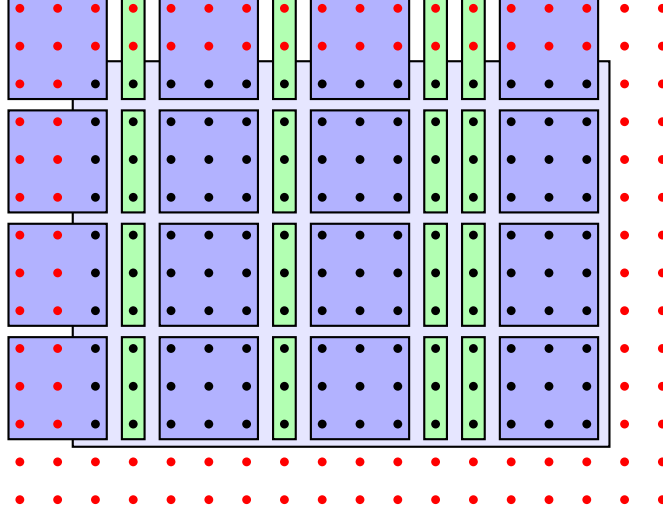

Figure 7: Expand the lattice by adding  $m - 1$  rows and columns of red vertices in each direction. Consider the partition of new lattice, as shown above. Translating this partition by  $a - 1$  steps right and  $a' - 1$  steps down gives the partition of the original lattice in Figure 6. Now consider any local operator within the original lattice. Translating the original partition by  $a - 1$  steps right and  $a' - 1$  steps down is equivalent to translating the operator by  $a - 1$  steps left and  $a' - 1$  steps up. If  $a, a'$  are chosen at random in  $\{1, 2, \dots, m\}$ , the probability that the operator is not contained in a blue region can now easily be computed to be  $O\left(\frac{b}{m}\right)$ .

for some universal constant  $C > 0$ . To complete the proof, we show  $S_{1/2}(\Omega_A) \leq 10 \log(D)$  for any  $(D, \Delta)$ -AGSP satisfying  $D\Delta < 1/2$ .

As shown in [9, Proof of Lemma 3.3], a  $(D, \Delta)$  AGSP with  $D\Delta < \frac{1}{2}$  implies the following bound on the Schmidt coefficients  $\{\lambda_1, \lambda_2, \dots\}$  (arranged in non-increasing order) of  $|\Omega\rangle$ , with respect to the cut:

$$\sum_{i \in \{D^\ell + 1, \dots, D^{\ell+1}\}} \lambda_i^2 \leq \sum_{i > D^\ell} \lambda_i^2 \leq 2D\Delta^\ell \leq \Delta^{\ell-1},$$

for all integers  $\ell \geq 1$ . We will upper bound  $S_{\frac{1}{2}}(\Omega_R) = 2 \log(\sum_i \lambda_i)$ , under the above constraint. Following [9], we can maximize the Rényi entropy by setting  $\lambda_i^2 = \frac{\Delta^{\ell-1}}{D^{\ell+1} - D^\ell}$ , whenever  $i \in \{D^\ell + 1, \dots, D^{\ell+1}\}$ . With this choice,

$$\begin{aligned} \sum_i \lambda_i &= \sum_{i \leq D} \lambda_i + \sum_{\ell=1}^{\infty} \left( (D^{\ell+1} - D^\ell) \sqrt{\frac{\Delta^{\ell-1}}{D^{\ell+1} - D^\ell}} \right) \\ &\leq D + \sum_{\ell=1}^{\infty} \left( \sqrt{D^{\ell+1} \Delta^{\ell-1}} \right) = D + D \sum_{\ell=1}^{\infty} \sqrt{(D\Delta)^{\ell-1}} \\ &\leq D \left( 1 + \sum_{\ell=1}^{\infty} \left( \frac{1}{\sqrt{2}} \right)^{\ell-1} \right) \leq 5D. \end{aligned}$$

Thus,  $S_{\frac{1}{2}}(\Omega_R) \leq 2 \log(5D) \leq 10 \log(D)$ , completing the proof.  $\square$