

# Deep Reinforcement Learning for Scheduling in Cellular Networks

Jian Wang\*, Chen Xu\*, Yourui Huangfu\*, Rong Li\*, Yiqun Ge†, Jun Wang\*

\*Hangzhou Research Center, Huawei Technologies, Hangzhou, China

†Ottawa Research Center, Huawei Technologies, Ottawa, Canada

Emails: {wangjian23, xuchen14, huangfuyourui, lironone.li, yiqun.ge, justin.wangjun}@huawei.com

**Abstract**—Integrating artificial intelligence (AI) into wireless networks has drawn significant interest in both industry and academia. A common solution is to replace partial or even all modules in the conventional systems, which is often lack of efficiency and robustness due to their ignoring of expert knowledge. In this paper, we take deep reinforcement learning (DRL) based scheduling as an example to investigate how expert knowledge can help with AI module in cellular networks. A simulation platform, which has considered link adaption, feedback and other practical mechanisms, is developed to facilitate the investigation. Besides the traditional way, which is learning directly from the environment, for training DRL agent, we propose two novel methods, i.e., learning from a dual AI module and learning from the expert solution. The results show that, for the considering scheduling problem, DRL training procedure can be improved on both performance and convergence speed by involving the expert knowledge. Hence, instead of replacing conventional scheduling module in the system, adding a newly introduced AI module, which is capable to interact with the conventional module and provide more flexibility, is a more feasible solution.

**Index Terms**—artificial intelligence, cellular networks, deep reinforcement learning, scheduling, proportional fair

## I. INTRODUCTION

As the name suggests, artificial intelligence (AI) technology is used to infuse intelligent capability into machines with the target to help the machines behave as well as or even better than human beings. Many trials have been made to investigate how to use AI in wireless networks, which are thoroughly summarised in [1], [2]. Wireless networks are complex systems, which are usually divided into several layers, each contains multiple modules with dedicated functions. The modules are then represented by mathematical models exactly or approximately. Thanks to the modularity, the functions of the system can be designed and optimized in a separate way. Generally, two ways of adopting AI in wireless networks can be found in the literatures. One is to redesign the whole end-to-end system, where both the transmitter and the receiver are replaced by neural networks (NNs). The other is to replace building blocks of the system through some kinds of NNs. In both methods, AI is used to directly replace partial or all modules in the conventional system. These simple replacements usually suffers from low efficiency due to lack of expert knowledge or sub-optimal performance due to no global considerations. Moreover, adopting such schemes in the practical, especially commercial, networks will surely meet with lots of obstructions. For one thing, the interpretability of

NNs is still elusive, which imposes doubts on the stability of such NN-based function modules. For the other, replacement of conventional modules in practical networks will lead to high cost for the operators. In this context, a more feasible way is to add an AI module, which can work along with other function modules, into the conventional system. It can coordinate the working flow of other modules, cooperate with them, and/or temporarily replace them in some situations. It is not supposed to rely on AI to break the whole system and theory, but to enable the system to perform better. This AI-enabled wireless networks will take the advantage of both the learning capability from NNs and the expert knowledge from conventional communication theory.

In this paper, we choose scheduling as a typical example for the AI-enabled wireless networks. Scheduler plays a fundamental role in cellular networks, which makes it the “brain” of the whole system [3]. Its basic function is to make decisions about how radio resources are allocated. Conventional scheduling algorithms usually take channel conditions and QoS requirements into consideration, and make decisions according to some equations. This deterministic way of scheduling suffers from lack of flexibility. To flexibly solve the decision-making problem, a Markov Decision Process (MDP), which is traditionally solved by Dynamic Programming (DP) [4], can be employed. However, with the increment of problem scale and dimension, the computational complexity of DP is no longer affordable. In this context, deep reinforcement learning (DRL), which combines Deep Neural Networks (DNNs) and Reinforcement Learning (RL), provides an alternative way due to its capability of handling multi-dimension data. The DRL agent works as a brain to observe the state from the environment, and makes action decisions for the environment to execute. Then, the environment feeds a reward for the decisions back to the agent and turns to the next state. The agent evolves along with this interaction with the environment.

There are already several studies that investigate scheduling based on DRL. The work in [5] focuses on a Vehicle-to-Infrastructure (V2I) scenario, and uses DRL-based scheduler to extend the lifetime of the battery-powered Road-Side Units (RSUs) while promoting a safe environment that meets acceptable QoS levels. Chinchali et al. uses DRL-based scheduler to optimize the Internet of Things (IoT) traffic without impacting conventional real-time applications such as voice-calling and video [6]. A joint user scheduling and content caching strategy

based on DRL is study in [7], where the decisions of whether to cache certain content and which small-cell base station (SBS) is selected to serve certain UE are made simultaneously. In [8], a DRL-based scheduler is designed to coordinate packet transmission from different buffers through multiple channels in a cognitive IoT network. An uplink scheduling problem is studied in [9], where DRL is used to choose  $K$  from  $N$  UEs to allow their uplink transmission at the aim of throughput maximization under power consumption consideration. The scenarios considered in these works are generally quite complex, where multi-class services (e.g., IoT traffic and conventional traffic) or network devices (e.g., primary users and secondary users in cognitive networks, macro-cell BS and small-cell BS in heterogeneous networks) exist. There are no ready-for-use scheduling algorithms in these scenarios, hence no baseline comparison is provided. Although they also introduce DRL agent as a newly-added module, the capability, performance and efficiency of such scheduler are hard to study without any baseline. Moreover, except [6] which uses real field data to do training and verification, other works use quite simple assumptions to generate the data. For instance, the data rate is calculated directly from Shannon's equation, without considering the impacts of adaptive modulation and coding (AMC) and outer loop link adaption (OLLA). This simplification eases the learning requirement for agents and make them even more dubious to be adopted in practical systems.

In this paper, we go back to the case with the simplest settings in a cellular network and investigate scheduling based on DRL in the proposed AI-enabled network structure. The traditional way of training, i.e., direct-learning, is first tried, where the DRL agent directly learns from the environment. Then, we propose two novel training methods, i.e., dual-learning and expert-learning. For the dual-learning method, two independent agents are trained alternatively and learns from each other. The PF algorithm is employed as expert knowledge in the expert-learning method to help with DRL agent training. Through the comparison between these three learning methodologies, we can clearly verify the learning capability of DRL and study how expert knowledge can help with performance and training speed in the focused scheduling problem. To simulate the practical cellular networks to the maximum extent in our investigation, we developed a system simulator which contains nearly all the link adaption, feedback and scheduling mechanisms used in real LTE networks.

The structure of this paper is as following. The preliminaries are first introduced in Section II. The network scenario, problem formulation and learning methodologies are described in Section III. Then, some trials are carried out in Section IV. Conclusions are made in Section V, where several future work directions are provided.

## II. PRELIMINARIES

### A. Proportional Fair (PF) Scheduling Algorithms

Proportional Fair (PF) perhaps is the most widely used scheduling algorithm. It provides a tradeoff between system

overall throughput and fairness among UEs. Therefore, we set PF as the baseline in this paper. As a preliminary, we brief PF algorithm in this section as follows. Considering a scheduling problem that a total amount of resource (system capacity)  $C$  is allocated among  $N$  UEs in the set  $\mathcal{N}$ . Each UE has a data rate  $x_n, n \in \mathcal{N}$ . A set of rates  $\{x_n, n \in \mathcal{N}\}$  is proportionally fair if it is feasible (that is  $x_n \geq 0$  and sum of  $x_n$  is no larger than  $C$ ) and if for any other feasible set  $\{x_n^*, n \in \mathcal{N}\}$ , the aggregate of proportional changes is zero or negative [10]:

$$\sum_{n \in \mathcal{N}} \frac{x_n^* - x_n}{x_n} \leq 0 \quad (1)$$

F. Kelly formulates the aforementioned scheduling problem into an utility maximization problem as

$$\begin{aligned} \max \quad & \sum_{n \in \mathcal{N}} U_n(x_n) \\ \text{s.t.} \quad & x_n \text{ is feasible} \end{aligned} \quad (2)$$

where the feasible condition is that the data rate should be no smaller than zero and the total data rate should be no larger than the system capacity. It is found that when the utility function  $U_n$  is the logarithm function, the solution of problem (2) is the unique vector of rates that is proportionally fair [10]. Therefore, the PF scheduling algorithm is optimal in term of maximizing the sum of logarithmic rate.

Kelly's result provides a general principle about how to achieve proportional fairness. Later, [11] adopts it in the scenario of wireless networks with a single carrier. The only carrier (or say channel) should be allocated to the UE with the largest metric calculated as  $I_n/T_n$ , where  $I_n$  is the instantaneous throughput estimated from the updated channel condition and  $T_n$  is the average throughput in a past window for the  $n$ -th UE, respectively. The intention of this metric is that the UE with higher instantaneous throughput (i.e., better channel condition) should has higher priority to use the channel resource, which improve the overall throughput of the system, while at the same time, the UE with smaller historic throughput should be given more chance to access the channel, which guarantees some degree of fairness. To summarize, for a single-carrier system, to achieve proportional fair, UE should be chosen according to

$$i = \arg \max_{n \in \mathcal{N}} \frac{I_n}{T_n} \quad (3)$$

where, the average throughput is updated according to

$$T_n(t) = \frac{W-1}{W} T_n(t-1) + \frac{1}{W} I_n(t) \quad (4)$$

with  $W$  as the window size for averaging.

### B. Deep Reinforcement Learning

An MDP is typically defined by state space  $\mathcal{S}$ , action set  $\mathcal{A}$ , reward function  $\mathcal{R}$  and transition probability  $\mathcal{P}$ . The main problem is to find a policy  $\pi$  for decision maker that maximize the expected (discounted) reward. Reinforcement learning (RL) can be utilized to solve MDP if the full

knowledge is unavailable, e.g.,  $\mathcal{R}$  and/or  $\mathcal{P}$  are unknown. The RL agent learns through the interactions with the environment step by step. There are several classical RL algorithms, such as Q-learning, Policy Gradient (PG), Actor Critic, etc. They are proven to be useful to solve MDP with small scales of states. The MDP we meet in practical systems is usually with large-scale states and complicated state transitions. The computational complexity of classical RL algorithms rapidly becomes unaffordable. As a result, DNNs are introduced to improve both the learning performance and training speed.

Deep Q-Network (DQN) algorithm uses a DNN instead of the Q-table to derive an approximate value for Q-function in Q-Learning. Several tricks are employed through the training process. For instance, an experience represented as  $(S^t, A^t, R^t, S^{t+1})$  including the current state, the current action, the current reward and the next state is collected together and saved in a memory pool. Then the algorithm randomly selects a minibatch of samples from the pool and use them to do the training, which is called experience replay. Through this method, not only the new but also the old experiences can be used in training process, which brings data efficiency for off-policy RL algorithm and removes the correlations in data sequences. Usually, two DNNs with the same structure are used in DQN. One is called the target network which is kept fixed for several training steps, and the other is called evaluation network which is updated per episode. After a given period, the values of parameters in the evaluation network is updated to the target network. Meanwhile, the agent is allowed to randomly choose an action with some probability  $\epsilon$ , which helps the agent to make a tradeoff between exploitation and exploration.

While DQN (value-based method) is good at making discrete decisions, systems in many applications have continuous state/action spaces. Policy-based methods are more efficient in these problems since they directly optimize on the policy  $\pi$ . In addition, the actor-critic algorithm learns both a value function and a policy to reduce the gradient variance of PG. Deep deterministic policy gradient (DDPG) [12] is introduced as the extension of DQN and deterministic policy gradient, which is an off-policy actor-critic algorithm suitable for high-dimension continuous problems. DDPG employs experience replay and soft target network similar to DQN in order to improve the training stability.

### III. NETWORK SCENARIO AND SIMULATION PLATFORM

#### A. Network Scenario and Simulation Platform

In this paper, we consider a single cell cellular network following LTE standard. The BS is equipped with an AI module which mainly functions to help with scheduling. As suggested that no conventional modules should be replaced, hence there is still a scheduling module in the considered system.

It has been mentioned in Section II-A that, in a single-carrier system, PF algorithm based on Equation (3) can achieve proportional fairness. Hence, we will investigate this single-carrier system by assuming there is only one resource block

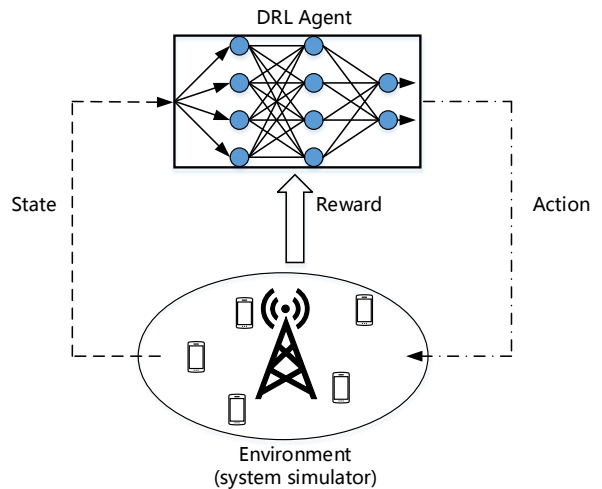

Fig. 1. Simulation platform.

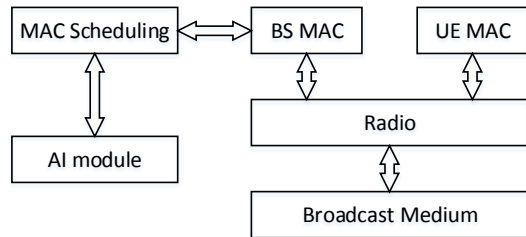

Fig. 2. Functional structure of the system simulator.

group (RBG) which contains all the resource blocks (RBs) in the system. Then, DRL algorithms (DDPG) are installed in the AI module to see if and how they can cooperate with the scheduling module to achieve the optimum.

As shown in Fig. 1, the simulation platform contains a DRL agent realized in Tensorflow [13] and a system simulator working as the environment. The system simulator is packaged to provide the interfaces for the agent to get states and rewards, and set actions.

The structure of the system simulator is shown in Fig. 2. The BS MAC and UE MAC module are responsible to transfer data packets as well as generate and handle control channel signals such as HARQ and CSI reporting. Meanwhile, the BS MAC relies on the scheduling module to allocate resources to UEs. The Radio module has two main functions: to check if the data packets can be decoded successfully or not; to calculate the feedback quantities such as SINR and rank. The Broadcast Medium module keeps track on antenna sets and their channels. The module mainly concerned in this paper is the MAC scheduling module which focuses on making resource allocation decision based on the channel condition and historic throughput information. An AI module is embedded in the system to help with the scheduling procedure. This system simulator realizes nearly all the link adaption and feedback function in LTE. The AMC function follows exactly the LTE standard, that modulation and coding schemes (MCSs) are

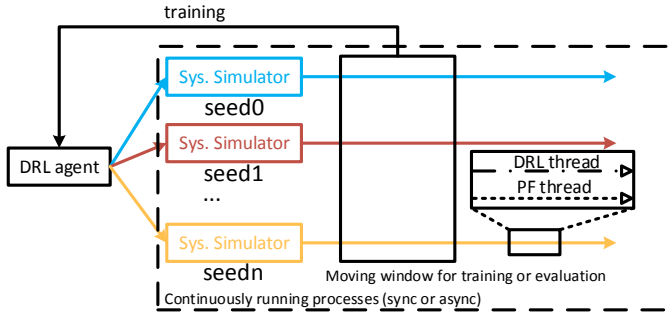

Fig. 3. Simulation framework.

chosen from LTE MCS table with a target block error ratio (BLER). A fixed step outer loop link adaption is also employed to compensate the feedback error due to the imperfection of feedback channel.

As shown in Fig. 3, multiple simulations with different UE positions and data generation seeds are started simultaneously, so that the experience buffer contains samples with different UE deployments. These various samples help DRL agent with generalization, i.e., making good decisions in different situations. For each system simulator, two threads are initialized, one interacts with the DRL agent, and the other runs PF scheduling algorithm for performance comparison. Moving windows is used to delimit the time scope of training and evaluation.

### B. Problem Formulation

The MDP of this scenario is elaborated as follows.

- State: the instantaneous rate  $I_n(t)$  and average rate  $T_n(t)$  for each UE  $n \in \mathcal{N}$  are contained in the state  $S^t$ . Reminding that the update of average rate as shown in Equation (4) involves the influence of the previous action through the term  $I_n(t)$ , thus the transition from state  $S^t \doteq (I_n(t), T_n(t))$  to state  $S^{t+1}$  is Markovian.
- Action: Since a single-carrier scheduling scenario is considered, the action is to decide which UE is scheduled to occupy the only RBG in each scheduling period (i.e., Transmission Time Interval, TTI in LTE). Similar to PF algorithm, for DRL, the action output  $A^t$  is designed to be metrics for each UE. The BS can choose the UE with the largest metric as the scheduled UE in each TTI.
- Reward: The reward design is a fundamental problem in DRL, since it has impacts on both system performance and training speed. In this paper, the total throughput and UE fairness are considered when calculating the reward. To quantify the UE fairness, Jain's fairness index (JFI) [14] is used. The calculation of JFI is shown in Equation (5), where  $V_n, n \in \mathcal{N}$  represents the received average throughput of the  $n$ -th UE. The details of reward calculation, which can be explained from learning methodology perspective, are elaborated in Section III-C.

$$fairness = \frac{\left[ \sum_{n=1}^N V_n \right]}{\left[ N \sum_{n=1}^N V_n^2 \right]} \quad (5)$$

### C. Learning Methodology

In this section, three methods of calculating reward are elaborated. Corresponding to their learning procedures, we view them as three different learning methodologies for DRL as shown in Fig. 4.

#### 1) Direct-Learning:

$$reward = \alpha \times throughput + \beta \times fairness \quad (6)$$

The first learning methodology is direct-learning, where the DRL agent learn directly from the environment without considering the expert knowledge. Taking throughput and fairness into consideration, Equation (6) is the most straightforward reward function. Here, the *throughput* in the reward function is the received instantaneous throughput, hence the UE with the best channel condition is encouraged to be chosen. The *fairness* is calculated through Equation (5).  $\alpha$  and  $\beta$  are weighting factors for throughput and fairness, respectively. Apparently, set  $\alpha = 1$  and  $\beta = 0$  will lead to a performance similar to Max C/I. Without expert knowledge in this reward function, the DRL agent is trained to learning directly from the environment and improve both throughput and fairness simultaneously.

#### Algorithm 1 Dual-learning framework

---

```

Initialize two independent agents
Initialize two environments with the same seed
while not convergent do
    TRAIN( $agent_0, agent_1$ )
    TRAIN( $agent_1, agent_0$ )
end while
function TRAIN( $agent_i, agent_j$ )
    Freeze parameters of  $agent_j$ 
     $agent_i$  and  $agent_j$  interacts with environments
    Calculate reward for  $agent_i$  using the lookup table
    Update parameters of  $agent_i$ 
end function

```

---

TABLE I  
DUAL-LEARNING REWARD LOOK-UP TABLE

		Agent0			
Throughput		>	>	≤	<
JFI	Agent1	>	≤	>	≤
Reward		$\alpha + \beta$	$\alpha$	$\beta$	0

2) *Dual-Learning*: In this subsection, we propose an alternative framework of training DRL agents, i.e., dual-learning, in the specific scheduling problem. As described in Algorithm 1, two independent agents are randomly initialized to interact with the same environment. By training them alternatively, two agents can help each other set up a baseline and then learn from it, eventually achieving global optimum.

The rules of reward calculation for this framework is simple: reward increases by 1 if certain performance metric is better than that of the other agent, or the increment is 0. The

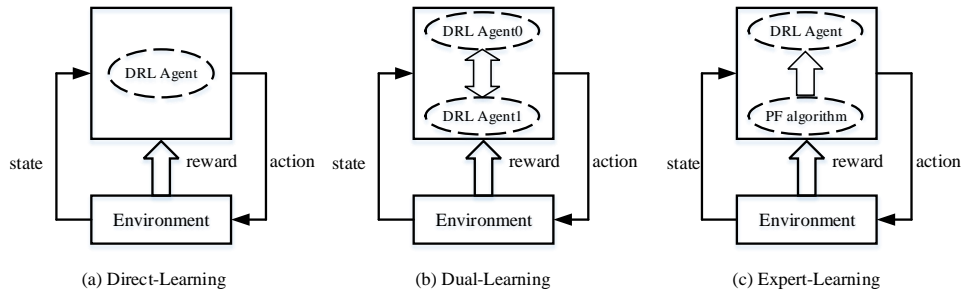

Fig. 4. Learning methodologies.

purpose of the reward is that the DRL agent is encouraged to make better decisions than the opponent agent. To enable flexibility of adjusting contribution weight of throughput and fairness,  $\alpha$  and  $\beta$  are also introduced. Thus the reward can be designed into a look-up table, as seen in Table I. This dual-learning procedure still does not involve expert knowledge from conventional scheduling algorithms.

3) *Expert-Learning*: As the PF algorithm given by Equation (3) is proven to be a good tradeoff between throughput and fairness, we can take advantage of it and speed up the training of DRL agent. For this expert-learning method, the reward rule of dual-learning method is reused, in which one opponent agent is replaced with the PF algorithm. Hence we have a similar reward table Table II. Note that the reward will increase by 0.5 if certain metric is equal to PF algorithm because of PF's optimality.

#### IV. TRIALS AND DISCUSSIONS

In this section, we present the simulation results. A 10MHz bandwidth single cell LTE network is considered with 5 UEs receiving full-buffer traffic packets from the BS. The NNs used in the DRL agent are fully connected ones with 2 hidden layers, each of which contains 320 neurons. ReLU function is used as the activation function for all the hidden layers. Softmax is used at the output layer of the actor network and no activation function is used for the output layer of the critic network. The DRL agents are trained with 28 independently but simultaneously running system simulators for better convergence and generalization ability. We take PF as baseline and compare DRL performance with it every 50 training updates during the training process. The normalized performance difference between DRL and PF algorithm is elaborated in the y-axes in the figures below, where a positive value means DRL algorithm performs better than the baseline. The x-axes present the counts of training updates.

##### A. Direct-Learning

As shown in Fig. 5, the DRL algorithm converges quickly in  $\sim 1000$  updates, and then, nearly no obvious improvement can be obtained. The results show that DRL algorithm can achieve higher throughput with the sacrifice of fairness. To make fairness take higher weight in the reward function, we tried to adjust the weighting factors, e.g., from  $\beta/\alpha = 5$  to  $\beta/\alpha = 10$ . The adjustment on  $\alpha$  and  $\beta$  does help with the

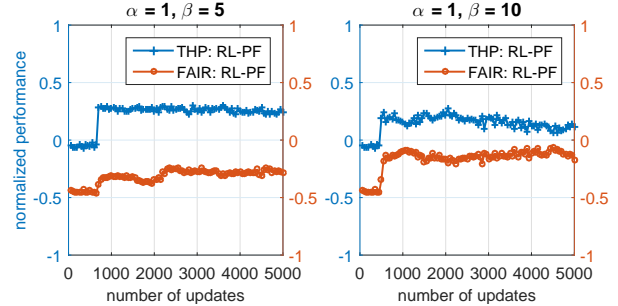

Fig. 5. Comparison between direct-learning RL agent and PF algorithm.

tradeoff between throughput and fairness, but PF state is still difficult to approach according to our simulations. The reason is that the wireless environment is non-stationary, that is, the reward may be different in training even if with the same state and action, thus the agent is hard to converge or quickly falls into local optimum.

##### B. Dual-Learning

For the dual-learning procedure, we choose  $\alpha = 0.85$  and  $\beta = 1.05$  in this experiment.

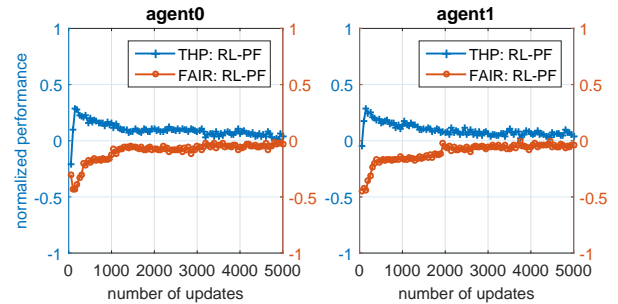

Fig. 6. Comparison between dual-learning RL agent and PF algorithm.

As shown in Fig. 6, after  $\sim 2000$  updates for each agent, two agents both converge to near-optimal. This method helps the DRL agent continuously make progress towards the global optimal solution. The drawback is that still no expert knowledge is used, hence the convergence speed is slow.

##### C. Expert-Learning

We choose  $\alpha = 0.9$  and  $\beta = 1.15$  in this experiment. Fig. 7 records the throughput and JFI differences between DRL agent

TABLE II  
EXPERT-LEARNING REWARD LOOK-UP TABLE

		PF								
Throughput	RL	>	>	<	<	>	=	=	=	<
JFI		>	<	>	<	=	>	=	<	=
Reward		$\alpha + \beta$	$\alpha$	$\beta$	0	$\alpha + 0.5\beta$	$0.5\alpha + \beta$	$0.5(\alpha + \beta)$	$0.5\alpha$	$0.5\beta$

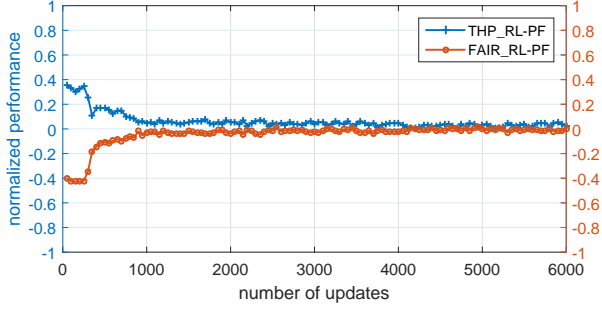

Fig. 7. Comparison between expert-learning RL agent and PF algorithm.

and PF algorithm. It can be seen that after  $\sim 1000$  updates, DRL agent converges to nearly optimal, and has successfully learnt from PF after  $\sim 4000$  updates, achieving optimum.

#### D. Discussions

To conclude the above subsections, it is found for the investigated scheduling problem that:

- 1) DRL agent can learn directly from the environment. By setting different weights for throughput and fairness in the reward function, the algorithm can converge to different points. However, it still has a risk to fall into local optimal points.
- 2) Dual-learning can help with getting rid of falling into local optimum, but the training speed is relatively slow due to ignoring expert knowledge.
- 3) If good expert knowledge exists, learning from it can speed up the training procedure.

The results in this section suggest that instead of replacing the conventional PF scheduler by an AI scheduler, add one is more feasible. This AI scheduler can learn online from the PF scheduler. When number of UEs in the system becomes large and the requirements of them becomes different, PF scheduling is slow and inefficient. The AI scheduler can help to make flexible decisions at one shot. Meanwhile, although the generalization capability of NNs is proven to be strong in some cases, it is more robust to keep the adjustment of NNs according to the changing environment. The AI scheduler can be trained online when the PF scheduler is working in the system. The switch of PF and AI scheduler can be designed so that system performance is optimized and not influenced while the AI scheduler is training.

#### V. CONCLUSIONS AND FUTURE WORK

In this paper, we investigate how DRL can help with solving the scheduling problem in cellular networks. Three learning methodologies are introduced while training the DRL agent.

Results show that, in the scenario of scheduling, learning from the expert knowledge can provide the best performance and the most efficient training. So, instead of replacing the conventional scheduling module, add an AI scheduler is more feasible.

For the future, more state and performance parameters can be considered. For instance, considering a finite-length buffer with non-full buffer traffic and a delay tolerance for each packet, the packet loss due to buffer overflow and time expiration will surely influence the system performance. The DRL agent should take buffer and delay condition as parts of the state, and packet loss ratio as a component of reward calculation.

#### REFERENCES

- [1] Q. Mao, F. Hu, and Q. Hao, "Deep learning for intelligent wireless networks: A comprehensive survey," *IEEE Communications Surveys & Tutorials*, vol. 20, no. 4, pp. 2595–2621, 2018.
- [2] C. Zhang, P. Patras, and H. Haddadi, "Deep learning in mobile and wireless networking: A survey," *IEEE Communications Surveys & Tutorials*, 2019.
- [3] F. Capozzi, G. Piro, L. A. Grieco, G. Boggia, and P. Camarda, "Down-link packet scheduling in LTE cellular networks: Key design issues and a survey," *IEEE Communications Surveys & Tutorials*, vol. 15, no. 2, pp. 678–700, 2013.
- [4] D. P. Bertsekas, D. P. Bertsekas, D. P. Bertsekas, and D. P. Bertsekas, *Dynamic programming and optimal control*. Athena scientific Belmont, MA, 1995, vol. 1, no. 2.
- [5] R. Atallah, C. Assi, and M. Khabbaz, "Deep reinforcement learning-based scheduling for roadside communication networks," in *2017 15th International Symposium on Modeling and Optimization in Mobile, Ad Hoc, and Wireless Networks (WiOpt)*. IEEE, 2017, pp. 1–8.
- [6] S. Chinchali, P. Hu, T. Chu, M. Sharma, M. Bansal, R. Misra, M. Pavone, and S. Katti, "Cellular network traffic scheduling with deep reinforcement learning," in *Thirty-Second AAAI Conference on Artificial Intelligence*, 2018.
- [7] Y. Wei, Z. Zhang, F. R. Yu, and Z. Han, "Joint user scheduling and content caching strategy for mobile edge networks using deep reinforcement learning," in *2018 IEEE International Conference on Communications Workshops (ICC Workshops)*. IEEE, 2018, pp. 1–6.
- [8] J. Zhu, Y. Song, D. Jiang, and H. Song, "A new deep-Q-learning-based transmission scheduling mechanism for the cognitive internet of things," *IEEE Internet of Things Journal*, vol. 5, no. 4, pp. 2375–2385, 2018.
- [9] M. Chu, H. Li, X. Liao, and S. Cui, "Reinforcement learning based multi-access control and battery prediction with energy harvesting in iot systems," *IEEE Internet of Things Journal*, 2018.
- [10] F. Kelly, "Charging and rate control for elastic traffic," *European transactions on Telecommunications*, vol. 8, no. 1, pp. 33–37, 1997.
- [11] D. Tse, "Multiuser diversity in wireless networks," in *Wireless Communications Seminar, Stanford University*, 2001.
- [12] T. P. Lillicrap, J. J. Hunt, A. Pritzel, N. Heess, T. Erez, Y. Tassa, D. Silver, and D. Wierstra, "Continuous control with deep reinforcement learning," *arXiv preprint arXiv:1509.02971*, 2015.
- [13] M. Abadi *et al.*, "TensorFlow: Large-scale machine learning on heterogeneous systems," 2015, software available from tensorflow.org. [Online]. Available: <https://www.tensorflow.org/>
- [14] R. K. Jain, D.-M. W. Chiu, and W. R. Hawe, "A quantitative measure of fairness and discrimination," *Eastern Research Laboratory, Digital Equipment Corporation, Hudson, MA*, 1984.