





Article

Text Classification Algorithms: A Survey

Kamran Kowsari^{1,3,*} , Kiana Jafari Meimandi¹, Mojtaba Heidarysafa¹, Sanjana Mendu¹ ,
 Laura E. Barnes^{1,2,3}  and Donald E. Brown^{1,2} 

¹ Department of Systems and Information Engineering, University of Virginia, Charlottesville, VA, USA

² School of Data Science, University of Virginia, Charlottesville, VA, USA

³ Sensing Systems for Health Lab, University of Virginia, Charlottesville, VA 22911 USA

The source code and the results are shared as free tools at https://github.com/kk7nc/Text_Classification.

* Correspondence: kk7nc@virginia.edu; Tel.: +1-202-812-3013

Received: date; Accepted: date; Published: date

Abstract: In recent years, there has been an exponential growth in the number of complex documents and texts that require a deeper understanding of machine learning methods to be able to accurately classify texts in many applications. Many machine learning approaches have achieved surpassing results in natural language processing. The success of these learning algorithms relies on their capacity to understand complex models and non-linear relationships within data. However, finding suitable structures, architectures, and techniques for text classification is a challenge for researchers. In this paper, a brief overview of text classification algorithms is discussed. This overview covers different text feature extractions, dimensionality reduction methods, existing algorithms and techniques, and evaluations methods. Finally, the limitations of each technique and their application in the real-world problem are discussed.

Keywords: Text Classification; Text mining; Text Representation; Text categorization; Text analysis; Document classification

1. Introduction

Text classification problems have been widely studied and addressed in many real applications [1–8] over the last few decades. Especially with recent breakthroughs in Natural Language Processing (NLP) and text mining, many researchers are now interested in developing applications that leverage text classification methods. Most text classification and document categorization systems can be deconstructed into the following four phases: feature extraction, dimension reductions, classifier selection, and evaluations. In this paper, we discuss the structure and technical implementations of text classification systems in terms of the pipeline illustrated in Figure 1.

The initial pipeline input consists of some raw text dataset. In general, text datasets contain sequences of text in documents as $D = \{X_1, X_2, \dots, X_N\}$ where X_i refers to a data point (i.e. document, text segment) with s number of sentences such that each sentence includes w_s words with l_w letters. Each point is labeled with a class value from a set of k different discrete value indices [7].

Then, we should create a structured set for our training purposes which call this section Feature Extraction. The dimensionality reduction step is an optional part of the pipeline which could be part of classification system (e.g. if we use term frequency-inverse document frequency (tf-idf) as our feature extraction and in train set we have $200k$ unique words, computational time is very expensive, so we could reduce this option by bringing feature space in other dimensional space). The most significant step in document categorization is choosing the best classification algorithm. The other part of the pipeline is the evaluation step which is divided into two parts (prediction the test set and evaluating the model). In general the text classification system contains four different levels of scope that can be applied:

1. **Document level:** In the document level, the algorithm obtains the relevant categories of a full document.
2. **Paragraph level:** In the paragraph level, the algorithm obtains the relevant categories of a single paragraph (a portion of a document).
3. **Sentence level:** In the sentence level, obtains the relevant categories of a single sentence (a portion of a paragraph).
4. **Sub-sentence level:** In the sub-sentence level, the algorithm obtains the relevant categories of sub-expressions within a sentence (a portion of a Sentence)).

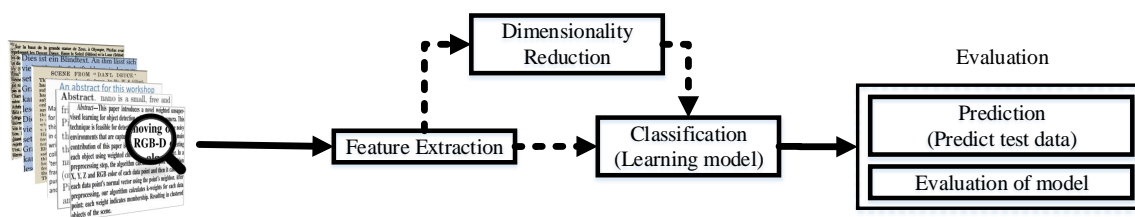

Figure 1. Overview of Text Classification Pipeline

I) **Feature Extraction:** In general, texts and documents are unstructured datasets. However, these unstructured text sequences must be converted into a structured feature space when using mathematical modeling as part of a classifier. First, the data needs to be cleaned to omit unnecessary characters and words. After the data has been cleaned, formal feature extraction methods can be applied. The common techniques of feature extractions are Term Frequency-Inverse Document Frequency (TF-IDF), Term Frequency (TF) [9], Word2Vec [10], and Global Vectors for Word Representation (GloVe) [11]. In Section 2, we categorize these methods as either word embedding or weighted word techniques and discuss the technical implementation details.

II) Dimensionality Reduction:

As text or document datasets often contain many unique words, data pre-processing steps can be lagged by high time and memory complexity. A common solution to this problem is simply using inexpensive algorithms. However, in some datasets, these kinds of cheap algorithms do not perform as well as expected. In order to avoid this decrease in performance, many researchers prefer to use dimensionality reduction to reduce the time and memory complexity for their applications. Using dimensionality reduction for pre-processing could be more efficient than developing inexpensive classifiers.

In Section 3, we outline the most common techniques of dimensionality reduction, including Principle Component Analysis (PCA), Linear Discriminant Analysis (LDA), and non-negative matrix factorization (NMF). We also discuss novel techniques for unsupervised feature extraction dimensionality reduction, such as random projection, autoencoders, and T-distributed Stochastic Neighbor Embedding (T-SNE).

III) **Classification Techniques:** The most important step of the text classification pipeline is choosing the best classifier. Without a complete conceptual understanding of each algorithm, we cannot effectively determine the most efficient model for a text classification application. In Section 4, we discuss the most popular techniques of text classification. First, we cover traditional methods of text classification, such as Rocchio classification. Next, we talk about ensemble-based learning techniques such as Boosting and Bagging, which have been used mainly for query learning strategies and text analysis [12–14]. One of the simplest classification algorithms is Logistic Regression (LR) which has been addressed in most data mining domains [15–18]. In the earliest history of information retrieval as a feasible application, The Naïve Bayes Classifier (NBC) was very popular. We have a brief overview of Naïve Bayes Classifier which is computationally inexpensive and also needs a very low amount of memory [19].

Non-parametric techniques have been studied and used as classification tasks such as K-nearest Neighbor (KNN) [20]. Support Vector Machine (SVM) [21,22] is another popular technique which employs a discriminative classifier for document categorization. This technique can also be used in all domains of data mining such as bioinformatics, image, video, human activity classification, safety and security, etc. This model is also used as a baseline for many researchers to compare against their own works to highlight novelty, and contributions.

Tree-based classifiers such as decision tree and random forest have also been studied with respect to document categorization [23]. Each tree-based algorithm will be covered in a separate sub-section. In recent years graphical classifications have been considered [24] as a classification task such as Conditional random fields (CRFs). However, these techniques are mostly used for document summarization [25] and automatic keyword extraction [26].

Lately, deep learning approaches have achieved surpassing results in comparison to previous machine learning algorithms on tasks such as image classification, natural language processing, face recognition, etc. The success of these deep learning algorithms relies on their capacity to model complex and non-linear relationships within data [27].

IV) Evaluation: The final part of the text classification pipeline is evaluation. Understanding how a model performs is essential to the use and development of text classification methods. There are many methods available for evaluating supervised techniques. Accuracy calculation is the simplest method of evaluation, but does not work for unbalanced datasets [28]. In Section 5, we outline the following evaluation methods for text classification algorithms: F_β Score [29], Matthews Correlation Coefficient (MCC) [30], receiver operating characteristics (ROC) [31], and area under the ROC curve (AUC) [32].

In Section 6, we talk about the limitations and drawbacks of the methods mentioned above. We also briefly compare the steps of pipeline including feature extractions, dimensionality reduction, classification techniques, evaluation methods. The state-of-the-art techniques are compared in this section by many criteria such as architecture of their model, novelty of the work, feature extraction technique, corpus (the dataset(s) is used), validation measure, and limitation of each work. Finding the best system for an application requires choosing a feature extraction methods. This choice completely depends on the goal and dataset of an application. As some feature extraction techniques are not efficient for a specific application. For example, since GloVe is trained on Wikipedia and when used for short text messages like Short Message Service (SMS), this technique does not be performed as well as TF-IDF. Additionally, limited data points this model cannot be trained as well as other techniques due to the small amount of data. The next step or this pipeline is a classification technique, we briefly talk about limitation and drawbacks of each technique.

In Section 7, we will describe the text and document classification applications. Text classification is a major challenge in many domains and fields for researchers. Information retrieval systems [33] and search engine [34,35] applications commonly make use of text classification methods. Extending from these applications, text classification could also be used for applications such as information filtering (e.g. email and text message spam filtering) [36]. Next, we will talk about adoption of document categorization in public health [37] and human behavior [38]. Another area that has been helped by text classification is document organization and knowledge management. Finally, we will discuss recommender systems which are extensively used in marketing and advertising.

2. Text Preprocessing

Feature extraction and pre-processing are crucial steps for text classification applications. In this section, we introduce methods for cleaning text datasets, thus removing implicit noise and allowing for informative featurization. Furthermore, we discuss two common methods of text feature extraction: weighted word and word embedding techniques.

2.1. Text Cleaning and Pre-processing

Most text and document datasets contain many unnecessary words such as stopwords, misspelling, slang, etc. In many algorithms, especially statistical and probabilistic learning algorithms, noise and unnecessary features can have adverse effects on system performance. In this section, we briefly explain some techniques and methods for text cleaning and pre-processing text datasets.

2.1.1. Tokenization

Tokenization is a pre-processing method which breaks a stream of text into words, phrases, symbols, or other meaningful elements called tokens [39,40]. The main goal of this step is the investigation of the words in a sentence [40]. Both text classification and text mining require a parser which processes the tokenization of the documents; for example:

sentence [41] :

After sleeping for four hours, he decided to sleep for another four.

In this case, the tokens are as follows:

{ "After" "sleeping" "for" "four" "hours" "he" "decided" "to" "sleep" "for" "another" "four" }.

2.1.2. Stop words

Text and document classification includes many words which do not contain important significance to be used in classification algorithms such as {"a", "about", "above", "across", "after", "afterwards", "again",...}. The most common technique to deal with these words is to remove them from the texts and documents [42].

2.1.3. Capitalization

Text and document data points have a diversity of capitalization to form a sentence. Since documents consist of many sentences, diverse capitalization can be hugely problematic when classifying large documents. The most common approach for dealing with inconsistent capitalization is to reduce every letter to lower case. This technique projects all words in text and document into the same feature space, but it causes to a significant problem for interpretation of some words (i.e. "US" (United States of America) to "us" (pronoun))[43]. Slang and abbreviation converters can help account for these exceptions[44].

2.1.4. Slang and Abbreviation

Slang and abbreviation are other forms of text anomalies that are handled in the pre-processing step. An abbreviation [45] is a shortened form of a word or phrase which contain mostly first letters form the words, such as SVM which stands for Support Vector Machine. Slang is a subset of the language used in informal talk or text that has different meanings such as "lost the plot", which essentially means that they've gone mad [46]. A common method for dealing with these words is converting them into formal language [47].

2.1.5. Noise Removal

Most of the text and document datasets contain many unnecessary characters such as punctuation and special characters. Critical punctuation and special characters are important for human to understanding of documents, but it can be detrimental for classification algorithms [48].

2.1.6. Spelling Correction

Spelling correction is an optional pre-processing step. Typos (short for typographical errors) are commonly present in texts and documents, especially in social media text datasets (e.g. Twitter). Many algorithms, techniques, and methods have addressed this problem in NLP [49]. Many techniques and methods are available for researchers including hashing-based and context-sensitive spelling

correction techniques [50], as well as spelling correction using Trie and Damerau-Levenshtein distance bigram [51].

2.1.7. Stemming

In NLP, one word could appear in different forms (i.e. singular and plural noun form) while the semantic meaning of each form is the same [52]. One method for consolidating different forms of a word into the same feature space is stemming. Text stemming modifies words to obtain variant word forms using different linguistic processes such as affixation (addition of affixes) [53,54]. For example, the stem of the word "studying" is "study".

2.1.8. Lemmatization

Lemmatization is a NLP process that replaces the suffix of a word with a different one or removes the suffix of a word completely to get the basic word form (lemma) [54–56].

2.2. Syntactic Word Representation

Many researchers have been worked on the this text feature extraction techniques to solve the loosing syntactic and semantic relation between words. Many researchers addressed novel techniques for solving this problem, but many of these techniques still have limitation. In [57] introduced a model which the usefulness of including syntactic and semantic knowledge in the text representation for the selection of sentences from technical genomic texts. The other solution for syntactic problem is using N-gram technique for feature extraction.

2.2.1. N-gram

N-gram technique is a set of $n - word$ which occurs "in that order" in a text set. This is not a representation of a text, but it could be used as a feature to represent a text.

BOW is a representation of a text using its words ($1 - gram$) which losing their order (syntactic). This model is very easy to obtain and the text can be represented through a vector, generally of a manageable size of the text. On the other hand, $n - gram$ is a feature, of BOW for a representation of a text using 1-gram. It's very common to use $2 - gram$ and $3 - gram$. In this way, the text feature extracted could detect more information in comparison to $1 - gram$.

2.2.1.1 Here is an example of 2-gram:

After sleeping for four hours, he decided to sleep for another four.

In this case, the tokens are as follows:

{ "After sleeping", "sleeping for", "for four", "four hours", "four he" "he decided", "decided to", "to sleep", "sleep for", "for another", "another four" }.

2.2.1.2 Here is an example of 3-gram:

After sleeping for four hours, he decided to sleep for another four.

In this case, the tokens are as follows:

{ "After sleeping for", "sleeping for four", "four hours he", " hours he decided", "he decided to", "to sleep for", "sleep for another", "for another four" }.

2.2.2. Syntactic N-gram

In [58], Syntactic n-grams are discussed which defined by paths in syntactic dependency or constituent trees rather than the linear structure of the text.

2.3. Weighted Words

The most basic form of weighted word feature extraction is term-frequency (TF) where each word will be mapped to a number corresponding to the number of occurrences of that word in the whole corpora. Methods that extend the results of TF generally use word frequency as a boolean or logarithmically scaled weighting. In all weight words methods, each document is translated to a vector (with length equal to that of the document) containing the frequency of the words in that document. Although this approach is intuitive, it is limited by the fact that particular words that are commonly used in the language may dominate such representations.

2.3.1. Bag of Words (BoW)

The bag of words model (BoW model) is a reduced and simplified representation of a text document from selected parts of the text, based on specific criteria, such as word frequency.

The BOW technique is used in several domains such as computer vision, natural language processing (NLP), Bayesian spam filters, document classification and information retrieval by Machine Learning.

In a BOW a body of text, such as a document or a sentence, is thought of like a bag of words. Lists of words are created in the BoW process. These words in a matrix are not sentences which structure of sentences, grammar, and semantic relationship between these words are ignored in their collection and construction. The words are often representative of the content of a sentence. While grammar and order of appearance are ignored, multiplicity is counted and may be used later to determine the focus points of the documents.

Here is an example of BOW:

2.3.1.1 Document:

“As the home to UVA’s recognized undergraduate and graduate degree programs in systems engineering. In the UVA Department of Systems and Information Engineering, our students are exposed to a wide range of range”

2.3.1.2 Bag-of-Words (BOW):

{“As”, “the”, “home”, “to”, “UVA’s”, “recognized”, “undergraduate”, “and”, “graduate”, “degree”, “program”, “in”, “systems”, “engineering”, “in”, “Department”, “Information”, “students”, “”, “are”, “exposed”, “wide”, “range” }

2.3.1.3 Bag-of-Feature (BOF):

Feature = {1,1,1,3,2,1,2,1,2,3,1,1,1,2,1,1,1,1,1,1}

2.3.2. Limitation of Bag-of-Words

Bag of words models encode every word in the vocabulary as one-hot-encoded vector i.e. for the vocabulary of size $|\Sigma|$, each word is represented by a $|\Sigma|$ dimensional sparse vector with 1 at index corresponding to the word and 0 at every other index. As vocabulary may potentially run into millions, bag of word models face scalability challenges (e.g.: “This is good” and “Is this good” have exactly the same vector representation. Technical problem of the bag-of-word is also main challenge of the computer science and data science community.

Term frequency, also called bag of words, is the simplest technique of text feature extraction. This method is based on counting the number of the words in each document and assigning it to the feature space.

2.3.3. Term Frequency-Inverse Document Frequency

K Sparck Jones [59] proposed inverse document frequency (IDF) as a method to be used in conjunction with term frequency in order to lessen the effect of implicitly common words in the

corpus. IDF assigns a higher weight to words with either high frequencies low frequencies term in the document. This combination of TF and IDF is well known as term frequency-inverse document frequency (tf-idf). The mathematical representation of the weight of a term in a document by tf-idf is given in Equation 1.

$$W(d, t) = TF(d, t) * \log\left(\frac{N}{df(t)}\right) \tag{1}$$

Here N is the number of documents and $df(t)$ is the number of documents containing the term t in the corpus. The first term in Equation 1 improves the recall while the second term improves the precision of the word embedding [60]. Although tf-idf tries to overcome the problem of common terms in the document, it still suffers from some other descriptive limitations. Namely, tf-idf cannot account for the similarity between the words in the document since each word is independently presented as an index. However, with the development of more complex models in recent years, new methods, such as word embedding, have been presented that can incorporate concepts such as similarity of words and part of speech tagging.

2.4. Word Embedding

Even we have syntactic word representations, it's not meaning to that model captures the semantics meaning of the words. On the other hand, Bag of word models don't respect semantics of the word. For example: words "airplane", "aeroplane", "plane" and "aircraft" are often used in the same context. However, the vectors corresponding to these words are orthogonal in bag of words model. This problem makes the model in serious problem to understand the sentences. The other problem of the bag of word is that order of words in the phrase is not respected. even the *n-gram* did not solve this problem so we need to find similarity of each word in the sentence. Many researchers worked on word embedding to solve this problem. The skip-gram and continuous bag-of-words (CBOW) models of [61] propose a simple single-layer architecture based on the inner product between two word vectors.

Word embedding is a feature learning technique in which each word or phrase from the vocabulary is mapped to a N dimension vector of real numbers. Various word embedding methods have been proposed to translate unigrams into understandable input for machine learning algorithms. This work focuses on Word2Vec, GloVe, and FastText, three of the most common methods that have been successfully used for deep learning techniques. Recently, Novel technique of word representation was introduced that word vectors depend on the context of the word called "Contextualized Word Representations" or "Deep Contextualized Word Representations".

2.4.1. Word2Vec

T. Mikolov et al. [61,62] presented "word to vector" representation as an improved word embedding architecture. The Word2Vec approach uses shallow neural networks with two hidden layers, continuous bag of words (CBOW), and the Skip-Gram model to create a high dimension vector for each word. The Skip-Gram model dives a corpus of words w and context c [10]. The goal is to maximize the probability:

$$\arg \max_{\theta} \prod_{w \in T} \left[\prod_{c \in c(w)} p(c | w; \theta) \right] \tag{2}$$

where T refers to Text, and θ is parameter of $p(c | w; \theta)$

Figure 2 shows a simple CBOW model which tries to find the word based on previous words while Skip-Gram tries to find words that might come in the vicinity of each word. The weights between the input layer and output layer represent $v \times N$ [63] as a matrix of w .

$$h = W^T c = W_{k,}^T := v_{wI}^T \tag{3}$$

This method provides a very powerful tool for discovering relationships in the text corpus as well as the similarity between words. For example, this embedding would consider the two words such as "big" and "bigger" close to each other in the vector space it assigns them.

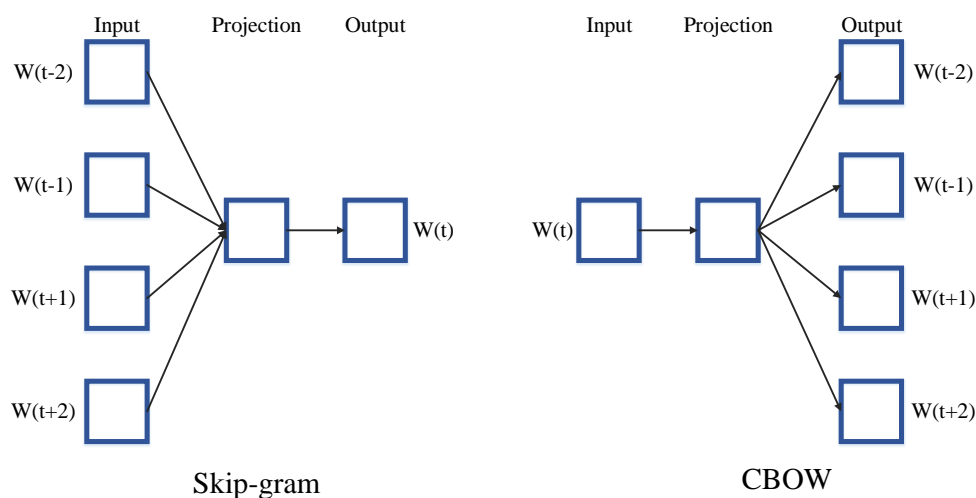

Figure 2. The CBOW architecture predicts the current word based on the context, and the Skip-gram predicts surrounding words given the current word. [61]

2.4.1.1 Continuous Bag-of-Words Model

The continuous bag-of-words model is represented by multiple words for a given target words. For example, The word "airplane" and "military" as context words for "air-force" as the target word. This consists of replicating the input to hidden layer connections β times which is the number of context words [61]. Thus, the bag-of-words model is mostly used to represent an un-ordered collection of words as a vector. the first thing we do is create a vocabulary, which means all unique word in the corpus. The output of the shallow neural network will be w_i that the task as "predicting the word given its context". The number of words we use depends on your setting for the window size (common size is 4-5 words).

2.4.1.2 Continuous Skip-gram Model

The another model architecture which is very similar to CBOW [61] is Continuous Skip-gram Model, but this model instead of predicting the current word based on the context, it tries to maximize classification of a word based on another word in the same sentence. Continuous bag-of-words model and continuous skip-gram model are used to keep syntactic and semantic information of the sentences for machine learning algorithm.

2.4.2. Global Vectors for Word Representation (GloVe)

Another powerful word embedding technique that has been used for text classification is Global Vectors (Glove) [11]. The approach is very similar to the Word2Vec method where each word is presented by a high dimension vector and trained based on the surrounding words over a huge corpus. The pre-trained word embedding used in many works is based on 400,000 vocabularies trained over Wikipedia 2014 and Gigaword 5 as the corpus and 50 dimensions for word presentation. GloVe also provides other pre-trained word vectorizations with 100, 200, 300 dimensions which are trained over even bigger corpora, including Twitter content. Figure 3 shows a visualization of the word distances over a sample dataset using the same T-SNE technique [64]. The objective function is as follows:

$$f(w_i - w_j, \tilde{w}_k) = \frac{P_{ik}}{P_{jk}} \quad (4)$$

where w_i is refer to word vector of word i , and P_{ik} denoted to probability of word k to occurs in context of word i .

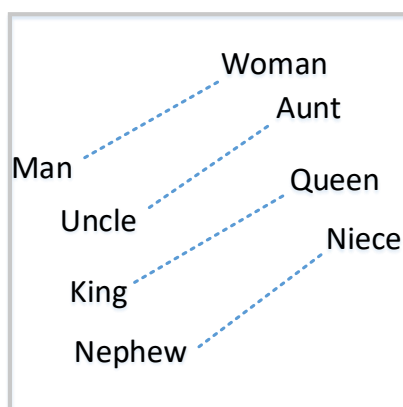

Figure 3. GloVe: Global Vectors for Word Representation

2.4.3. FastText

Many other word embedding representations ignore the morphology of words by assigning a distinct vector to each word [65]. Facebook AI Research lab released a novel technique to solve this issue by introducing a new word embedding method called *FastText*. Each word w is represented as a bag of character n -gram. For example, given the word “introduce” and $n = 3$, FastText will produce the following representation composed of character tri-grams:

$$\langle in, int, ntr, tro, rod, odu, duc, uce, ce \rangle$$

Note that the sequence $\langle int \rangle$, corresponding to the word here is different from the tri-gram “int” from the word introduce.

Suppose we have a dictionary of n -grams of size G , and given a word w which is associated as a vector representation z_g to each n -gram g . The obtained scoring function [65] in this case is:

$$s(w, c) = \sum_{g \in g_w} z_g^T v_c \quad (5)$$

where $g_w \in \{1, 2, \dots, G\}$

Facebook is published pre-trained word vectors for 294 languages which are trained on *Wikipedia* using fastText based on 300 dimension. The FastText used the skip-gram model [65] with default parameters.

2.4.4. Contextualized Word Representations

Contextualized word representations are another word embedding technique which is based on the context2vec [66] technique introduced by *B. McCann et al.* The context2vec method uses bidirectional long short-term memory (LSTM). *ME. Peters et al.* [67] built upon this technique to create the deep contextualized word representations technique. This technique contains both main feature of word representation: I) complex characteristics of word use (*e.g.*, syntax and semantics) II) how these uses vary across linguistic contexts (*i.e.*, to model polysemy) [67].

The main idea behind these word embedding techniques is that the resulting word vectors are learned from a bidirectional language model (biLM), which consist of both forward and backward LMs.

The forward LMs are as follows:

$$p(t_1, t_2, \dots, t_N) = \prod_{k=1}^N p(t_k | t_1, t_2, \dots, t_{k-1}) \tag{6}$$

The backward LMs are as follows:

$$p(t_1, t_2, \dots, t_N) = \prod_{k=1}^N p(t_k | t_{k+1}, t_{k+2}, \dots, t_N) \tag{7}$$

This formulation jointly maximizes the log-likelihood of the forward and backward directions as follows:

$$\sum_{k=1}^N \left(\log p(t_k | t_1, \dots, t_{k-1}; \Theta_x, \vec{\Theta}_{LSTM}, \Theta_s) + \log p(t_k | t_{k+1}, \dots, t_N; \Theta_x, \overleftarrow{\Theta}_{LSTM}, \Theta_s) \right) \tag{8}$$

where Θ_x is the token representation and Θ_x refers to the softmax layer. Then, ELMo is computed as a task-specific weighting for all biLM layers as follows:

$$ELMo_k^{task} = E(R_k; \Theta^{task}) = \gamma^{task} \sum_{j=0}^L s_j^{task} h_{k,j}^{LM} \tag{9}$$

where $h_{k,j}^{LM}$ is calculated by:

$$h_{k,j}^{LM} = \left[\vec{h}_{k,j}^{LM}, \overleftarrow{h}_{k,j}^{LM} \right] \tag{10}$$

Where s^{task} stands for softmax-normalized weights, and γ^{task} is the scalar parameter

2.5. Limitations

Although, continuous bag-of-words model and continuous skip-gram model are used to keep syntactic and semantic information of the per-sentences for machine learning algorithm, but how we could keep full meaning of coherent documents for machine learning.

Example:

Document : {“Maryam went to Paris on July 4th, 2018. She missed the independence day fireworks and celebrations. This day is a federal holiday in the United States commemorating the Declaration of Independence of the United States on July 4, 1776. The Continental Congress declared that the thirteen American colonies were no longer subject to the monarch of Britain and were now united, free, and independent states. She wants to stay in the country for next year and celebrate with her friends.”}

Sentence level of this document:

S1: {“Maryam went to Paris on July 4th, 2018. ”}

S2: {“She missed the independence day fireworks and celebrations.”}

S3: {“This day is a federal holiday in the United States commemorating the Declaration of Independence of the United States on July 4, 1776.”}

S4: {“The Continental Congress declared that the thirteen American colonies were no longer subject to the monarch of Britain and were now united, free, and independent states.”}

S5: {“She has a plan for next year to stay in the country and celebrate with her friends.”}

Limitation:

Regarding to Figure 4, it show how the feature extraction will fails for per-sentence level. The purple color shown in figure is the brief history of “This day”. and Also, “This day” is refer the “July 4th”. In S5 “She” refers from the S1 “Maryam”.

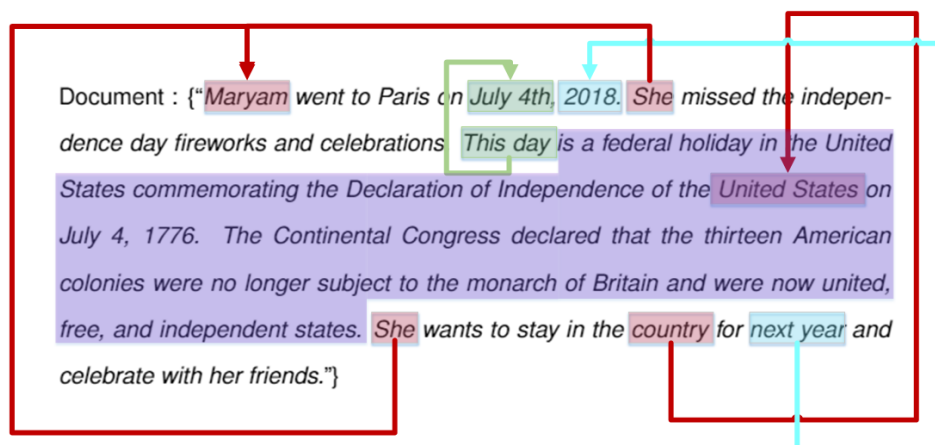

Figure 4. Limitation of Document Feature Extraction by per-sentence level

3. Dimensionality Reduction

Text sequences in term-based vector models consist of many features. Thus, the time complexity and memory consumption are very expensive for these methods. To address this issue, many researchers use dimensionality reduction to reduce the size of the feature space. In this section, existing dimensionality reduction algorithms are discussed in detail.

3.1. Component Analysis

3.1.1. Principal Component Analysis (PCA)

Principle component analysis (PCA) is the most popular technique in multivariate analysis and dimensionality reduction. PCA is a method to identify a subspace in which the data approximately lies [68]. This means finding new variables that are uncorrelated and maximizing the variance to "preserve as much variability as possible"[69].

Suppose a dataset $x^{(i)}; i = 1, \dots, m$ is given and $x^{(i)} \in \mathbb{R}^n$ for each i ($n \ll m$). The j^{th} column of matrix X is vector, x_j that is the observations on the j^{th} variable. The linear combination of x_j s can be written as:

$$\sum_{j=1}^m a_j x_j = Xa \tag{11}$$

where a is a vector of constants a_1, a_2, \dots, a_m . The variance of this linear combination can be given as:

$$var(Xa) = a^T S a \tag{12}$$

where S is the sample co-variance matrix. The goal is to find the linear combination with maximum variance. This translates into maximizing $a^T S a - \lambda(a^T a - 1)$, where λ is a Lagrange multiplier.

PCA can be used as a pre-processing tool to reduce the dimension of a dataset before running a supervised learning algorithm on it ($x^{(i)}$ s as inputs). PCA is also a valuable tool as a noise reduction algorithm and can be helpful in avoiding the over-fitting problem [70]. Kernel Principal Component Analysis (KPCA) is another dimensionality reduction method that generalizes linear PCA into the nonlinear case by using the kernel method [71].

3.1.2. Independent Component Analysis (ICA)

Independent component analysis (ICA) was introduced by *H. Jeanny* [72]. This technique was then further developed by *C. Jutten and J. Herault* [73]. ICA is a statistical modeling method

where the observed data are expressed as a linear transformation [74]. Assume that $4n$ linear mixtures (x_1, x_2, \dots, x_n) are observed where independent components:

$$x_j = a_{j1}s_1 + a_{j2}s_2 + \dots + a_{jn}s_n \quad \forall j \tag{13}$$

The vector-matrix notation is written as:

$$X = As \tag{14}$$

Denoting them by a_i , the model can also be written [75] as follows:

$$X = \sum_{i=1}^n a_i s_i \tag{15}$$

3.2. Linear Discriminant Analysis (LDA)

Linear discriminant analysis (LDA) is a commonly used technique for data classification and dimensionality reduction [76]. LDA is particularly helpful where the within-class frequencies are unequal and their performances have been evaluated on randomly generated test data. Class-dependent and class-independent transformation are two approaches to LDA in which the ratio of between class variance to within class variance and the ratio of the overall variance to within class variance are used respectively [77].

Let $x_i \in \mathbb{R}^d$ which be d -dimensional samples and $y_i \in \{1, 2, \dots, c\}$ be associated target or output [76], where n is the number of document and c is the number of categories. The number of samples in each class is calculated as follows:

$$S_w = \sum_{l=1}^c s_l \tag{16}$$

where

$$S_i = \sum_{x \in w_i} (x - \mu_i)(x - \mu_i)^T, \quad \mu_i = \frac{1}{N_i} \sum_{x \in w_i} x \tag{17}$$

The generalization between class scatter matrix is defined as follows:

$$S_B = \sum_{i=1}^c N_i (\mu_i - \mu)(\mu_i - \mu)^T \tag{18}$$

where

$$\mu = \frac{1}{N} \sum_{\forall x} x \tag{19}$$

Respect to $c - 1$ projection vector of w_i that can be projected into W matrix:

$$W = [w_1 | w_2 | \dots | w_{c-1}] \tag{20}$$

$$y_i = w_i^T x \tag{21}$$

Thus, the μ (mean) vector and S matrices (scatter matrices) for the projected to lower dimension as follows:

$$\tilde{S}_w = \sum_{i=1}^c \sum_{y \in w_i} (y - \tilde{\mu}_i)(y - \tilde{\mu}_i)^T \tag{22}$$

$$\tilde{S}_B = \sum_{i=1}^c (\tilde{\mu}_i - \tilde{\mu})(\tilde{\mu}_i - \tilde{\mu})^T \tag{23}$$

If the projection is not scalar ($c - 1$ dimensions), the determinant of the scatter matrices will be used as follows:

$$J(W) = \frac{|\tilde{S}_B|}{|\tilde{S}_W|} \tag{24}$$

From the Fisher Discriminant Analysis (FDA) [76,78], we can re-write the equation as:

$$J(W) = \frac{|W^T S_B W|}{|W^T S_W W|} \tag{25}$$

3.3. Non-negative Matrix Factorization (NMF)

Non-negative matrix factorization (NMF) or non-negative matrix approximation has been shown to be a very powerful technique very high dimensional data such as text and sequences analysis [79]. This technique is a promising method for dimension reduction [80]. This section a brief overview of NMF is discussed for text and document datasets. Given a non-negative $n \times m$ in matrix V is approximation of:

$$V \approx WH \tag{26}$$

Where $W = \mathbb{R}^{n \times r}$, and $H = \mathbb{R}^{r \times m}$. Suppose $(n + m) r < nm$, then the product WH can be regarded as a compressed form of the data in V . Then v_i and h_i are the corresponding columns of V and H . The computation of each the corresponding column can be re-written as follows:

$$u_i \approx Wh_i \tag{27}$$

The computational time of each iteration, as introduced by *S. Tsuge et al.* [80], can be written as follows:

$$\bar{H}_{ij} = H_{ij} \frac{(W^T V)_{ij}}{(W^T W H)_{ij}} \tag{28}$$

$$\bar{W}_{ij} = W_{ij} \frac{(V H^T)_{ij}}{(W H H^T)_{ij}} \tag{29}$$

Thus, the local minimum of the objective function is calculated as follows:

$$F = \sum_i \sum_j (V_{ij} - (WH)_{ij})^2 \tag{30}$$

The maximization of objective function can be re-written as follows:

$$F = \sum_i \sum_j (V_{ij} \log((WH)_{ij}) - (WH)_{ij}) \tag{31}$$

The objective function, given by the Kullback-Leibler [81,82] divergence, is defined as follows:

$$\bar{H}_{ij} = H_{ij} \sum_k W_{kj} \frac{V_{kj}}{(WH)_{kj}} \tag{32}$$

$$\hat{W}_{ij} = W_{ij} \sum_k \frac{V_{ik}}{(WH)_{ik}} H_{jk} \tag{33}$$

$$\bar{W}_{ij} = \frac{\hat{W}_{ij}}{\sum_k \hat{W}_{kj}} \tag{34}$$

This NMF-based dimensionality reduction contains the following 5 steps [80] (step VI is optional but commonly used in information retrieval:

- (I) Extract index term after pre-processing stem like feature extraction and text cleaning as discussed in Section 2. Then we have n documents with m features.
- (II) Create n documents ($d \in \{d_1, d_2, \dots, d_n\}$), where vector $a_{ij} = L_{ij} \times G_i$ where L_{ij} refers to local weights of i -th term in document j , and G_i is global weights for document i .
- (III) Apply NMF to all terms in all documents one-by-one.
- (IV) Project the trained document vector into r -dimensional space.
- (V) Using the same transformation, map the test set into the r -dimensional space.
- (VI) Calculate the similarity between transformed document vectors and a query vector.

3.4. Random Projection

Random projection is a novel technique for dimensionality reduction which is mostly used for high volume dataset or high dimension feature spaces. Texts and documents, especially with weighted feature extraction, generate a huge number of features. Many researchers have applied random projection to text data [83,84] for text mining, text classification, and dimensionality reduction. In this section, we review some basic random projection techniques. As shown in Figure 5, the overview of random projection is shown.

3.4.1. Random Kitchen Sinks

The key idea of random kitchen sinks [85] is sampling via *monte carlo* integration [86] to approximate the kernel as part of dimensionality reduction. This technique works only for shift-invariant kernel:

$$K(x, x') = \langle \phi(x), \phi(x') \rangle \approx K(x - x') \tag{35}$$

where shift-invariant kernel which is approximation kernel of:

$$K(x - x') = z(x)z(x') \tag{36}$$

$$K(x, x') = \int_{R^D} P(w) e^{iw^T(x-x')} \tag{37}$$

where D is the target number of samples, $P(w)$ is a probability distribution, w stands for random direction, and $w \in \mathbb{R}^{F \times D}$ where F is number of feature and D is the target.

$$K(x, x') = K(x - x') \approx \frac{1}{D} \sum_{j=1}^D e^{iw_j^T(x-x')} = \tag{38}$$

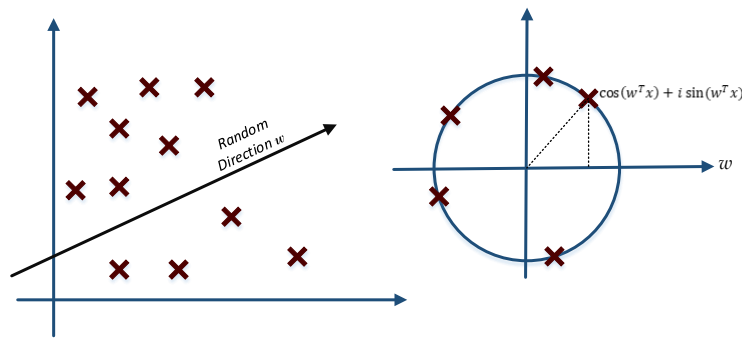

Figure 5. The plot on the left shows how we generate random direction, and the plot on the right shows how we project the data set into the new space using complex numbers

$$\frac{1}{D} \sum_{j=1}^D e^{iw_j^T x} e^{iw_j^T x'} = \tag{39}$$

$$\frac{1}{\sqrt{D}} \sum_{j=1}^D e^{iw_j^T x} \frac{1}{\sqrt{D}} \sum_{j=1}^D e^{iw_j^T x'}$$

$$k(x - x') \approx \phi(x)\phi(x') \tag{40}$$

$$\phi(x) = \cos(w^T x + b_i) \tag{41}$$

where the b_i is uniform random variable ($b_i \in [0, \pi]$).

3.4.2. Johnson Lindenstrauss Lemma

William B Johnson and Joram Lindenstrauss [87,88] proved that for any n point Euclidean space can be bounded in $k = O(\frac{\log n}{\epsilon^2})$ for any u and $v \in n$ and $n \in \mathbb{R}^d$:

$\exists f : \mathbb{R}^d \rightarrow \mathbb{R}^k | \epsilon \in [0, 1]$. We apply lemma 1 and 2 with $x = u - v$ to lower bound of the success probability.

$$(i - \epsilon) \|u - v\|^2 \leq \|f(u) - f(v)\|^2 \leq (i + \epsilon) \|u - v\|^2 \tag{42}$$

Johnson Lindenstrauss Lemma Proof:

For any V sets of data point from n where $V \in n$ and random variable $w \in R^{k \times d}$:

$$Pr[success] \geq 1 - 2m^2 e^{-\frac{k(\epsilon^2 - \epsilon^3)}{4}} \tag{43}$$

If we let $k = \frac{16 \log n}{\epsilon^2}$:

$$\begin{aligned} 1 - 2m^2 e^{-\frac{k(\epsilon^3 - \epsilon^3)}{4}} &\geq 1 - 2m^2 e^{-\frac{(-\frac{8 \log n}{\epsilon^2})(\epsilon^2 - \epsilon^3)}{4}} \\ &= 1 - 2m^2 e^{-\frac{16 \log n}{\epsilon^2} (\epsilon^3 - \epsilon^3)} \\ &= 1 - 2m^{4\epsilon - 2} > 1 - 2m^{-\frac{1}{2}} > 0 \end{aligned} \tag{44}$$

Lemma 1 Proof:

Let Ψ be a random variable with k degrees of freedom, then for $\epsilon \in [0, 1]$

$$Pr[(1 - \epsilon)k \leq \Psi \leq (1 + \epsilon)k] \geq 1 - 2e^{-\frac{k(\epsilon^2 - \epsilon^3)}{4}} \tag{45}$$

We start with Markov's inequality [89]:

$$Pr[(\Psi \geq (1 - \epsilon)k)] \leq \frac{E[\Psi]}{(1 - \epsilon)k} \tag{46}$$

$$Pr[e^{\lambda\Psi} \geq e^{\lambda(1-\epsilon)k}] \leq \frac{E[e^{\lambda\Psi}]}{e^{\lambda(1-\epsilon)k}} \tag{47}$$

$$E[e^{\lambda\Psi}] = (1 - 2\lambda)^{-\frac{k}{2}}$$

where $\lambda < 0.5$ and using the fact of $(1 - \epsilon) \leq e^{-\frac{(\epsilon^2 - \epsilon^3)}{2}}$; thus, we can proof $Pr[(\Psi \geq (1 - \epsilon)k)] \leq \frac{E[\Psi]}{(1-\epsilon)k}$ and the $Pr[(\Psi \leq (1 + \epsilon)k)] \leq \frac{E[\Psi]}{(1+\epsilon)k}$ is similar.

$$\frac{(1 + \epsilon)}{e^\epsilon} \leq \left(\frac{e^{\epsilon - \frac{(\epsilon^2 - \epsilon^3)}{2}}}{e^\epsilon} \right)^{\frac{k}{2}} = e^{-\frac{k(\epsilon^3 - \epsilon^3)}{4}} \tag{48}$$

$$Pr[(1 - \epsilon)k \leq \Psi \leq (1 + \epsilon)k] \leq Pr[(1 - \epsilon)k \geq \Psi \cup \Psi \leq (1 + \epsilon)k] = 2e^{-\frac{k(\epsilon^3 - \epsilon^3)}{4}} \tag{49}$$

Lemma 2 Proof:

Let w is random variable of $w \in \mathbb{R}^{k \times d}$ and $k < d$, x is data points $x \in \mathbb{R}^d$ then for any $\epsilon \in [0, 1]$:

$$Pr[(1 - \epsilon)||x||^2 \leq \left\| \frac{1}{\sqrt{k}}wx \right\|^2 \leq (1 + \epsilon)||x||^2] \geq 1 - 2e^{-\frac{k(\epsilon^3 - \epsilon^3)}{4}} \tag{50}$$

In equation 50, $\frac{1}{\sqrt{k}}wx$ is the random approximation value, and $\hat{x} = wx$, so we can rewrite the equation 50 by $Pr[(1 - \epsilon)||x||^2 \leq \left\| \frac{1}{\sqrt{k}}\hat{x} \right\|^2 \leq (1 + \epsilon)||x||^2] \geq 1 - 2e^{-\frac{k(\epsilon^3 - \epsilon^3)}{4}}$.

Let call $\zeta_i = \frac{\hat{x}_i}{||x||} \sim N(0, 1)$ and $\Psi = \sum_{i=1}^k \zeta_i^2$ thus:

$$Pr[(1 - \epsilon)k \leq \left\| \sum_{i=0}^k \zeta_i \right\|^2 \leq (1 + \epsilon)k] = Pr[(1 - \epsilon)k \leq ||w||^2 \leq (1 + \epsilon)k] \tag{51}$$

Where we can prove equation 51 by using equation 45:

$$Pr[(1 - \epsilon)k \leq \Psi \leq (1 + \epsilon)k] \geq 1 - 2e^{-\frac{k(\epsilon^3 - \epsilon^3)}{4}} \tag{52}$$

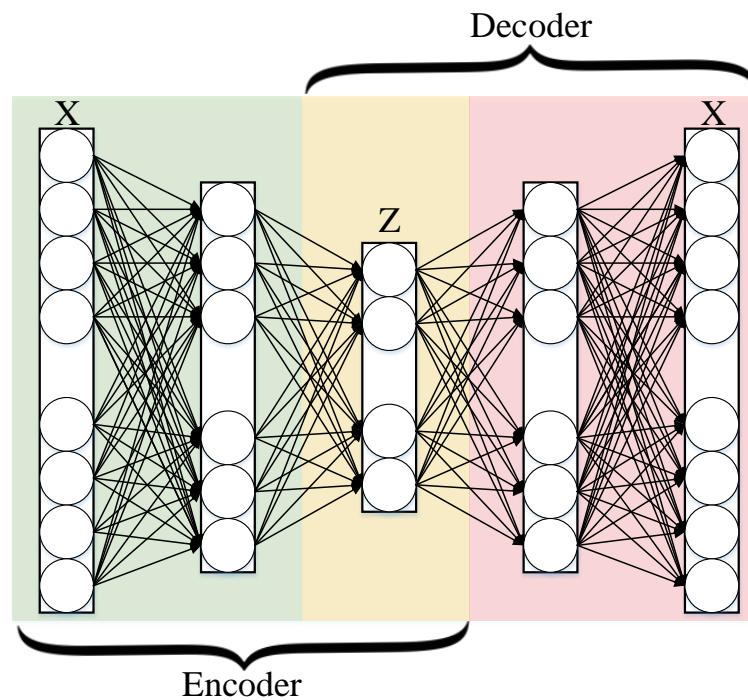

Figure 6. This figure shows how a simple autoencoder works. The model depicted contains the following layers: Z is code and two hidden layers used for encoding and two used for decoding.

3.5. Autoencoder

An autoencoder is a type of neural network that is trained to attempt to copy its input to its output [90]. The autoencoder has achieved great success as a dimensionality reduction method via the powerful rephensibility of neural networks [91]. The first version of autoencoder was introduced by *DE. Rumelhart et al.* [92] in 1985. The main idea is that one hidden layer between input and output layers has fewer units [93] and could thus be used to reduce the dimensions of a feature space. Especially for texts, documents, and sequences that contain many features, using an autoencoder could help allow for faster, more efficient data processing.

3.5.1. General Framework

As shown in Figure 6, the input and output layers of an autoencoder contain n units where $x = \mathbb{R}^n$, and hidden layer Z contains p units respect to $p < n$ [94]. For this technique of dimensionality reduction, the dimensions of the final feature space are reduced from $n \rightarrow p$. The encoder representation involves a sum of the representation of all words (for bag-of-words), reflecting the relative frequency of each word [95]:

$$a(x) = c + \sum_{i=1}^{|x|} W_{.,x_i}, \phi(x) = h(a(x)) \tag{53}$$

where $h(\cdot)$ is an element-wise non-linearity such as the sigmoid (Equation 79)

3.5.2. Conventional Autoencoder Architecture

A convolutional neural networks (CNN)-based autoencoder can be divided into two main steps [96] (encoding and decoding).

$$O_m(i, j) = a \left(\sum_{d=1}^D \sum_{u=-2k-1}^{2k+1} \sum_{v=-2k-1}^{2k+1} F_{m_d}^{(1)}(u, v) I_d(i - u, j - v) \right) \quad \forall m = 1, \dots, n \quad (54)$$

Where $F \in \{F_1^{(1)}, F_2^{(1)}, \dots, F_n^{(1)}\}$ which is convolutional filter, with convolution among an input volume defined by $I = \{I_1, \dots, I_D\}$ which it learns to represent input combining non-linear functions:

$$z_m = O_m = a(I * F_m^{(1)} + b_m^{(1)}) \quad m = 1, \dots, m \quad (55)$$

where $b_m^{(1)}$ is the bias, and the number of zeros we want to pad the input with is such that: $\dim(I) = \dim(\text{decode}(\text{encode}(I)))$ Finally, the encoding convolution is equal to:

$$\begin{aligned} O_w = O_h &= (I_w + 2(2k + 1) - 2) - (2k + 1) + 1 \\ &= I_w + (2k + 1) - 1 \end{aligned} \quad (56)$$

The decoding convolution step produces n feature maps $z_{m=1, \dots, n}$. The reconstructed results \hat{I} is the result of the convolution between the volume of feature maps $Z = \{z_{i=1}\}^n$ and this convolutional filters volume $F^{(2)}$ [96–98].

$$\tilde{I} = a(Z * F_m^{(2)} + b^{(2)}) \quad (57)$$

$$\begin{aligned} O_w = O_h &= (I_w + (2k + 1) - 1) - \\ &(2k + 1) + 1 = I_w = I_h \end{aligned} \quad (58)$$

Where the Equation 58 shows the decoding convolution with I dimensions. Input's dimensions are equal to the output's dimensions.

3.5.3. Recurrent Autoencoder Architecture

A recurrent neural network (RNN) is a natural generalization of feedforward neural networks to sequences [99]. The Figure 7 illustrate the Recurrent Autoencoder Architecture. A standard RNN compute the econding as a sequences of output by iteration:

$$h_t = \text{sigm}(W^{hx} x_t + W^{hh} h_{t-1}) \quad (59)$$

$$y_t = W^{yh} h_t \quad (60)$$

where x is inputs (x_1, \dots, x_T) and y refers to output (y_1, \dots, y_T) . A multinomial distribution (1-of-K coding) can be output using a softmax activation function [100]:

$$p(x_{t,j} = 1 | x_{t-1, \dots, x_1}) = \frac{\exp(w_j h_t)}{\sum_{j=1}^K \exp(w_j h_t)} \quad (61)$$

By combining these probabilities, we can compute the probability of the sequence x as:

$$p(x) = \prod_{t=1}^T p(x_t | x_{t-1}, \dots, x_1) \quad (62)$$

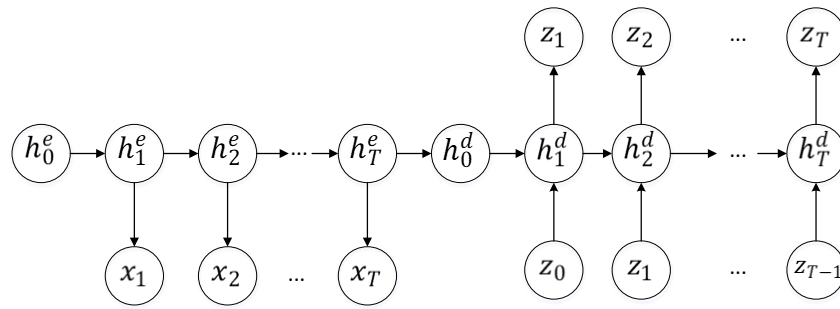

Figure 7. A recurrent autoencoder structure

3.6. T-distributed Stochastic Neighbor Embedding (T-SNE)

T-distributed Stochastic Neighbor Embedding (T-SNE) is a nonlinear dimensionality reduction method for embedding high-dimensional data. This method is mostly commonly used for visualization in a low-dimensional feature space [64], as shown in Figure 8. This approach is based on G. Hinton and ST. Roweis [101]. SNE works by converting the high dimensional Euclidean distances into conditional probabilities which represent similarities [64]. The conditional probability $p_{j|i}$ is calculated by:

$$p_{j|i} = \frac{\exp\left(-\frac{\|x_i - x_j\|^2}{2\sigma_i^2}\right)}{\sum_{k \neq i} \exp\left(-\frac{\|x_i - x_k\|^2}{2\sigma_i^2}\right)} \tag{63}$$

where σ_i is the variance of the centered on data point x_i . The similarity of y_j to y_i is calculated as follows:

$$q_{j|i} = \frac{\exp(-\|y_i - y_j\|^2)}{\sum_{k \neq i} \exp(-\|y_i - y_k\|^2)} \tag{64}$$

The cost function C is as follows:

$$C = \sum_i KL(p_i|Q_i) \tag{65}$$

where $KL(P_i|Q_i)$ is the Kullback-Leibler divergence [102], which is calculated as:

$$KL(P_i|Q_i) = \sum_j p_{j|i} \log \frac{p_{j|i}}{q_{j|i}} \tag{66}$$

The gradient update with a momentum term is as follows:

$$\gamma^{(t)} = \gamma^{(t-1)} + \eta \frac{\delta C}{\delta \gamma} + \alpha(t) \left(\gamma^{(t-1)} - \gamma^{(t-2)} \right) \tag{67}$$

where η is the learning rate, $\gamma^{(t)}$ refers to the solution at iteration t, and $\alpha(t)$ indicates momentum at iteration t. Now we can re-write symmetric SNE in the high-dimensional space and a joint probability distribution, Q, in the low-dimensional space as follows [64]:

$$C = KL(P||Q) = \sum_i \sum_j p_{ij} \log \frac{p_{ij}}{q_{ij}} \tag{68}$$

in the high-dimensional space p_{ij} is:

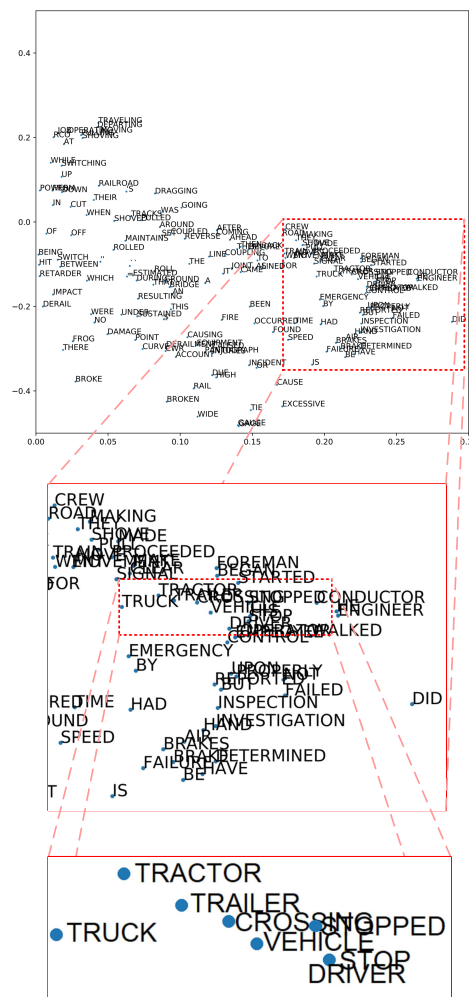

Figure 8. This figure present the T-SNE visualization of Word2vec of g Federal Railroad Administration (FRA) dataset

$$p_{ij} = \frac{\exp\left(-\frac{\|x_i - x_j\|^2}{2\sigma^2}\right)}{\sum_{k \neq l} \exp\left(-\frac{\|x_i - x_l\|^2}{2\sigma^2}\right)} \tag{69}$$

The gradient of symmetric S is as follows:

$$\frac{\delta C}{\delta y_i} = 4 \sum_j (p_{ij} - q_{ij})(y_i - y_j) \tag{70}$$

4. Existing classification Techniques

In this section, we outline existing text and document classification algorithms. First, we describe the Rocchio algorithm which is used for text classification. Then, we address two popular techniques in ensemble learning algorithms: Boosting and Bagging. Some methods, such as logistic regression, Naïve Bayes and K-Nearest neighbor, are more traditional but still commonly used in the scientific community. Support vector machines (SVMs), especially kernel SVMs, are also broadly used as a classification technique. Tree-based classification algorithms, such as decision tree and random forests, are fast and accurate for document categorization. We also describe neural network based algorithms such as Deep Neural Networks (DNN), Convolutional Neural Network (CNN), Recurrent

Neural Networks (RNN), Deep Belief Network (DBN), Hierarchical Attention Networks (HAN), and combination techniques.

4.1. Rocchio classification

The Rocchio algorithm was first introduced by *JJ. Rocchio* [103] in 1971 as method of using relevance feedback to query full-text databases. Since then, many researchers have addressed and developed this technique for text and document classification [104,105]. This classification algorithm uses tf-idf weights for each informative word instead of boolean features. Using a training set of documents, the Rocchio algorithm builds a prototype vector for each class. This prototype is an average vector over the training documents' vectors that belong to a certain class. It then assigns each test document to the class with the maximum similarity between the test document and each of the prototype vectors [106]. The average vector computes the centroid of a class *c* (center of mass of its members):

$$\vec{\mu}(c) = \frac{1}{|D_c|} \sum_{d \in D_c} \vec{v}_d \tag{71}$$

where D_c is the set of documents in D that belongs to class c and \vec{v}_d is the weighted vector representation of document d . The predicted label of document d is the one with the smallest Euclidean distance between the document and the centroid:

$$c^* = \arg \min_c \|\vec{\mu}_c - \vec{v}_d\| \tag{72}$$

Centroids can be normalized to unit-length as follows:

$$\vec{\mu}_c = \frac{\sum_{d \in D_c} \vec{v}_d}{\|\sum_{d \in D_c} \vec{v}_d\|} \tag{73}$$

Therefore, the label of test documents can be obtained as follows:

$$c_* = \arg \min_c \vec{\mu}_c \cdot \vec{v}_d \tag{74}$$

4.1.1. Limitation of Rocchio algorithm

The Rocchio algorithm for text classification contains many limitations such as the fact that the user can only retrieve a few relevant documents using this model [107]. Furthermore, this algorithms' results illustrate by taking semantics into consideration [108].

4.2. Boosting and Bagging

Voting classification techniques, such as Bagging and Boosting, have been successfully developed for document and text dataset classification [109]. While Boosting adaptively changes the distribution of the training set based on the performance of previous classifiers, Bagging does not look at the previous classifier[110].

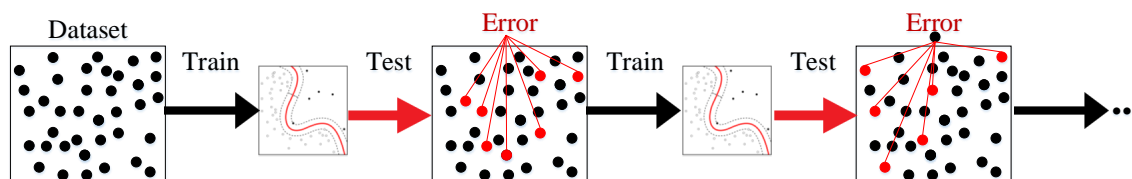

Figure 9. This figure is the Boosting technique architecture

Algorithm 2 The AdaBoost method

input : training set S of size m , inducer τ , integer N

```

for  $i = 1$  to  $N$  do
   $C_i = \tau(S')$ 
   $\epsilon_i = \frac{1}{m} \sum_{x_j \in S'; C_i(x_j) \neq y_i} weight(x)$ 
  if  $\epsilon_i > \frac{1}{2}$  then
    set  $S'$  to a bootstrap sample from  $S$  with weight 1 for
    all instance and go top
  endif
   $\beta_i = \frac{\epsilon_i}{1 - \epsilon_i}$ 
  for  $x_i \in S'$  do
    if  $C_i(x_j) = y_i$  then
       $weight(x_j) = weight(x_j) \cdot \beta_i$ 
    endif
  endfor
  Normalize weights of instances
endfor

```

$$C^*(x) = \arg \max_{y \in Y} \sum_{i, C_i(x)=y} \log \frac{1}{\beta_i}$$

output: Classifier C^*

4.2.1. Boosting

The Boosting algorithm was first introduced by *RE. Schapire* [111] in 1990 as a technique for boosting the performance of a weak learning algorithm. This technique was further developed by Freund [112,113].

The Figure 9 shows how boosting algorithm works for 2D datasets, as it shown we have labeled data then we trained by multi-model architectures (ensemble learning). These developments resulted in the AdaBoost (Adaptive Boosting) [114]. Suppose we construct D_t such that $D_1(i) = \frac{1}{m}$ given D_t and h_t :

$$\begin{aligned} D_{t+1}(i) &= \frac{D_t(i)}{Z_t} \times \begin{cases} e^{-\alpha_t} & \text{if } y_i = h_t(x_i) \\ e^{\alpha_t} & \text{if } y_i \neq h_t(x_i) \end{cases} \\ &= \frac{D_t(i)}{Z_t} \exp(-\alpha_t y_i h_t(x_i)) \end{aligned} \quad (75)$$

where Z_t refers to the normalization factor and α_t is as follows:

$$\alpha_t = \frac{1}{2} \ln \left(\frac{1 - \epsilon_t}{\epsilon_t} \right) \quad (76)$$

The final classifier formulation can be written as:

$$H_f(x) = \text{sign} \left(\sum_t \alpha_t h_t(x) \right) \quad (77)$$

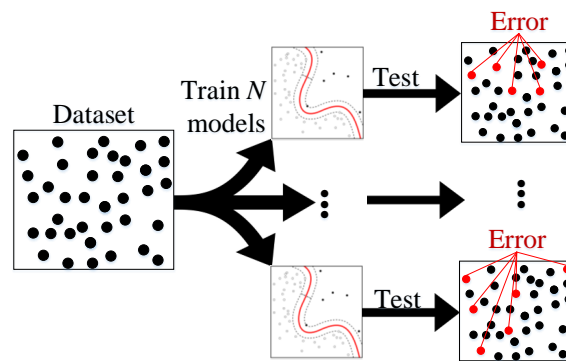

Figure 10. This figure shows a simple model of Bagging technique

Algorithm 3 Bagging

input :training set S , Inducer τ , integer N

for $i = 1$ to N **do**

$S' =$ bootstrap sample from S
 $C_i = \tau(S')$

endfor

$$C^*(x) = \arg \max_{y \in Y} \sum_{i, C_i=y} 1$$

output:Classifier C^*

4.2.2. Bagging

The Bagging algorithm was introduced by *L. Breiman* [115] in 1996 as a voting classifier method. The algorithm is generated by different bootstrap samples[110]. A bootstrap generates a uniform sample from the training set. If N bootstrap samples B_1, B_2, \dots, B_N have been generated, then we have N classifiers (C) which C_i is built from each bootstrap sample B_i . Finally, our classifier C contain or generated from C_1, C_2, \dots, C_N whose output is the class predicted most often by its sub-classifiers, with ties broken arbitrarily[110,115]. Figure 10 shows a simple Bagging algorithm which trained N models.

4.2.3. Limitation of Boosting and Bagging

Boosting and Bagging methods also have many limitations and disadvantages, such as the computational complexity and loss of interpretability [116] which means that the feature importance could not be discovered by these models.

4.3. Logistic Regression

One of the earliest methods of classification is logistic regression (LR). LR was introduced and developed by statistician David Cox in 1958 [117]. LR is a linear classifier with decision boundary of $\theta^T x = 0$. LR predicts probabilities rather than classes [118,119].

4.3.1. Basic Framework

The goal of LR is to trained from the probability of variable Y being 0 or 1 given x . Let's have text data which is $X \in \mathbb{R}^{n \times d}$. If we have binary classification problems, the Bernoulli mixture models function should be used [120] as follows:

$$\begin{aligned}
 L(\theta | x) &= p(y | x; \theta) = \\
 &= \prod_{i=1}^n \beta(y_i | \text{sigm}(x_i \theta)) = \\
 &= \prod_{i=1}^n \text{sigm}(x_i)^{y_i} (1 - \text{sigm}(x_i))^{1-y_i} = \\
 &= \prod_{i=1}^n \left[\frac{1}{1 + e^{-x_i \theta}} \right]^{y_i} \left[1 - \frac{1}{1 + e^{-x_i \theta}} \right]^{(1-y_i)}
 \end{aligned}
 \tag{78}$$

where $x_i \theta = \theta_0 + \sum_{j=1}^d (x_{ij} \theta_j)$, and $\text{sigm}(\cdot)$ is sigmoid function which is defined as shown in Equation 79.

$$\text{sigm}(\eta) = \frac{1}{1 + e^{-\eta}} = \frac{e^\eta}{1 + e^\eta}
 \tag{79}$$

4.3.2. Combining Instance-based Learning and LR

The LR model specifies the probability of binary output $y_i = \{0, 1\}$ given the input x_i . we can consider posterior probability as:

$$\pi_0 = P(y_0 = +1 | y_i)
 \tag{80}$$

where:

$$\frac{\pi_0}{1 - \pi_0} = \frac{P(y_i | y_0 = +1)}{P(y_i | y_0 = -1)} \cdot \frac{p_0}{1 - p_0}
 \tag{81}$$

where p is the likelihood ratio it could be re-written as:

$$\frac{\pi_0}{1 - \pi_0} = p \cdot \frac{p_0}{1 - p_0}
 \tag{82}$$

$$\log \left(\frac{\pi_0}{1 - \pi_0} \right) = \log(p) + w_0
 \tag{83}$$

with respect to:

$$w_0 = \log(p_0) - \log(1 - p_0)
 \tag{84}$$

To obey the basic principle underlying instance-based learning (IBL) [121], the classifier should be a function of the distance δ_i . p will be large if $\delta_i \rightarrow 0$ then $y_i = +1$, and small for $y_i = -1$. p should be close to 1 if $\delta_i \rightarrow \infty$; then, neither in favor of $y_0 = +1$ nor in favor of $y_0 = -1$, so the parameterized function is as follows:

$$p = p(\delta) = \exp \left(y_i \cdot \frac{\alpha}{\delta} \right)
 \tag{85}$$

Finally,

$$\log \left(\frac{\pi_0}{1 - \pi_0} \right) = w_0 + \alpha \sum_{x_i \in N(x_0)} k(x_0, x_i) \cdot y_i
 \tag{86}$$

where $k(x_0, x_i)$ is similarity measure.

4.3.3. Multinomial Logistic Regression

Multinomial (or multilabeled) logistic classification [122] uses the probability of x belonging to class i (as defined in Equation 87)

$$p(y^{(i)} = 1 | x, \theta) = \frac{\exp(\theta^{(i)T} x)}{\sum_{j=1}^m \exp(\theta^{(j)T} x)} \quad (87)$$

where $\theta^{(i)}$ is the weight vector corresponding to class i .

For binary classification ($m = 2$) which is known as a basic LR, but for multinomial logistic regression ($m > 2$) is usually use *softmax* function.

The normalization function is:

$$\sum_{i=1}^m p(y^{(i)} = 1 | x, \theta) = 1 \quad (88)$$

In a classification task as supervised learning context, the component of θ is calculated from the subset of the training data D which belongs to class i where $i \in \{1, \dots, n\}$. To perform maximum likelihood (ML) estimation of θ , we need to maximize the log-likelihood function as follows:

$$\begin{aligned} \ell(\theta) &= \sum_{j=1}^n \log p(y_j = 1 | x_j, \theta) \\ &= \sum_{j=1}^n \left[\sum_{i=1}^m y_j^{(i)} \theta^{(i)T} x_j - \log \sum_{i=1}^m \exp(\theta^{(i)T} x_j) \right] \end{aligned} \quad (89)$$

The adoption of a maximum a posteriori (MAP) estimates as follows:

$$\hat{\theta}_{MAP} = \arg \max_{\theta} L(\theta) = \arg \max_{\theta} [\ell(\theta) + \log p(\theta)] \quad (90)$$

4.3.4. Limitation of Logistic Regression

Logistic Regression classifier works well for predicting categorical outcomes. However, this prediction requires that each data point be independent [123] which is attempting to predict outcomes based on a set of independent variables [124]

4.4. Naïve Bayes Classifier

Naïve Bayes text classification has been widely used for document categorization tasks since the 1950s [125,126]. The Naïve Bayes classifier method is theoretically based on Bayes theorem, which was formulated by *Thomas Bayes* between 1701-1761 [127,128]). Recent studies have widely addressed this technique in Information Retrieval [129]. This technique is a generative model, which is the most traditional method of text categorization. We start with the most basic version of NBC which was developed by using TF (Bag of Word), a feature extraction technique which counts the number of words in documents.

4.4.1. High-Level Description of Naïve Bayes Classifier

If the number of documents (n) fit into k categories where $k \in \{c_1, c_2, \dots, c_k\}$ the predicted class as output is $c \in C$. The Naïve Bayes algorithm can be described as follows:

$$P(c | d) = \frac{P(d | c)P(c)}{P(d)} \quad (91)$$

where d is document, c indicates classes.

$$\begin{aligned}
 C_{MAP} &= \arg \max_{c \in C} P(d | c)P(c) \\
 &= \arg \max_{c \in C} P(x_1, x_2, \dots, x_n | c)p(c)
 \end{aligned}
 \tag{92}$$

This model is used as baseline of many papers which is word-level of Naïve Bayes classifier [3,130] as follows:

$$P(c_j | d_i; \hat{\theta}) = \frac{P(c_j | \hat{\theta})P(d_i | c_j; \hat{\theta}_j)}{P(d_i | \hat{\theta})}
 \tag{93}$$

4.4.2. Multinomial Naïve Bayes Classifier

If the number of documents (n) fit into k categories where $k \in \{c_1, c_2, \dots, c_k\}$ the predicted class as output is $c \in C$. The Naïve Bayes algorithm can be written as:

$$P(c | d) = \frac{P(c) \prod_{w \in d} P(d | c)^{n_{wd}}}{P(d)}
 \tag{94}$$

where n_{wd} is denoted to the number of times word w occurs in document, and $P(w|c)$ is the probability of observing word w given class c [131].

$P(w|c)$ is calculated as

$$P(w | c) = \frac{1 + \sum_{d \in D_c} n_{wd}}{k + \sum_{w'} \sum_{d \in D_c} n_{w'd}}
 \tag{95}$$

4.4.3. Naïve Bayes Classifier for Unbalanced Classes

One of the limitations of NBC is that the technique performs poorly on datasets with unbalanced classes [132].Eibe Frank and Remco R. Bouckaert [131] developed a method for introducing normalization in each class by Equation 96; then use the centroid classifier [22] in NBC for unbalanced classes. The centroid c_c for class c is given in Equation 97.

$$\alpha \times \frac{n_{wd}}{\sum_{w'} \sum_{d \in D_c} n_{w'd}}
 \tag{96}$$

$$c_c = \left\{ \frac{\sum_{d \in D_c} n_{w_1 d}}{\sqrt{\sum_w (\sum_{d \in D_c} n_{wd})^2}}, \dots, \frac{\sum_{d \in D_c} n_{w_i d}}{\sqrt{\sum_w (\sum_{d \in D_c} n_{wd})^2}}, \dots, \frac{\sum_{d \in D_c} n_{w_k d}}{\sqrt{\sum_w (\sum_{d \in D_c} n_{wd})^2}} \right\}
 \tag{97}$$

The scoring function is defined as:

$$x_d \cdot c_1 - x_d \cdot c_2
 \tag{98}$$

So log of multinomial Naïve Bayes classifier can be calculated as:

$$\left[\log P(c_1) + \sum_{i=1}^k n_{w_i d} \log(P(w_i | c_1)) \right] - \left[\log P(c_2) + \sum_{i=1}^k n_{w_i d} \log(P(w_i | c_2)) \right]
 \tag{99}$$

Using Equation 95 and 96, and if $\alpha = 1$ we can rewrite:

$$P(w | c) = \frac{1 + \frac{n_{wd}}{\sum_{w'} \sum_{d \in D_c} n_{w'd}}}{K + 1} \tag{100}$$

with respect to:

$$\frac{\sum_{d \in D_c} n_{wd}}{\sum_{w'} \sum_{d \in D_c} n_{w'd}} \ll 1 \tag{101}$$

For text datasets and $\log(x + 1) \approx x$ and $x \ll 1$ [131]. In this technique of NBC, the experimental results is very similar to centroid classifier [22].

4.4.4. Limitation of Naïve Bayes algorithm

Naïve Bayes algorithm also has several limitations. NBC makes a strong assumption about the shape of the data distribution [133,134]. NBC is also limited by data scarcity for which any possible value in feature space, a likelihood value must be estimated by a frequentist [135].

4.5. K-Nearest Neighbor

The k-nearest-neighbors algorithm (k-NN) is a non-parametric technique used for classification. This method is used for text classification applications in many research domains [136] in past decades.

4.5.1. Basic Concept of k-NN

Given a test document x , the k-NN algorithm finds the k nearest neighbors of x among all the documents in the training set, and scores the category candidates based the class of k neighbors. The similarity of x and each neighbor's document could be the score of the category of the neighbor documents. Multiple k-NN documents may belong to the same category; in this case, the summation of these scores would be the similarity score of the class k with respect to the test document x . After sorting the score values, the algorithm assigns the candidate to the class with the highest score from the test document x [136]. The Figure 11 illustrates the k-NN architecture, but for simplicity, this figure is designed by 2D dataset (similar with higher dimensional space like text dataset). The decision rule of k-NN is:

$$\begin{aligned} f(x) &= \arg \max_j S(x, C_j) \\ &= \sum_{d_i \in k-NN} sim(x, d_i) y(d_i, C_j) \end{aligned} \tag{102}$$

where S refers to score value with respect to $S(x, C_j)$, the score value of candidate i to class of j , and output of $f(x)$ is a label to the test set document.

4.5.2. Weight Adjusted k-Nearest Neighbor Classification

The Weight Adjusted k-Nearest Neighbor Classification (WAKNN) is a version of k-NN which tries to learn the weight vectors for classification [137]. The weighted cosine measure [138] is calculated as follows:

$$\cos(x, y, w) = \frac{\sum_{t \in T} (x_t \times w_t) \times (y_t \times w_t)}{\sqrt{\sum_{t \in T} (x_t \times w_t)^2} \times \sqrt{\sum_{t \in T} (y_t \times w_t)^2}} \tag{103}$$

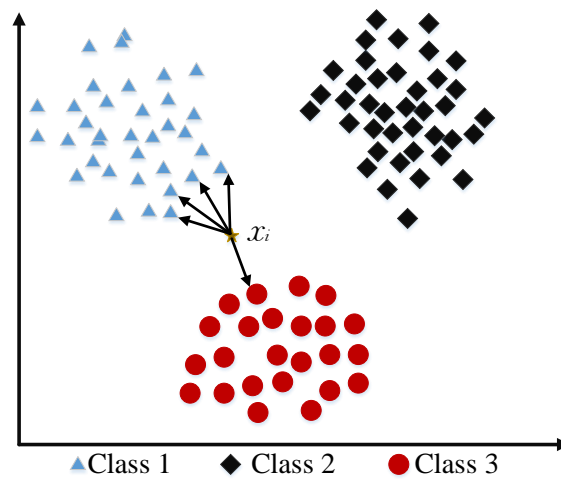

Figure 11. A architecture of k-NN model for 2D dataset and three classes

where T refers to set of words, and x_t and y_t are TF, as discussed in Section 2. For the training model ($d \in D$), let $N_d = \{n_1, n_2, \dots, n_k\}$ be the set of k-nearest neighbors of d . Given N_d , the similarity sum of d neighbors that belong to class c is define as follows:

$$S_c = \sum_{n_i \in N; C(n_i)=c} \cos(d, n_i, w) \tag{104}$$

Total similarity is calculated as follows:

$$T = \sum_{c \in C} S_c \tag{105}$$

The contribution of d is defined in terms of S_c of classes c and T as follows:

$$cont(d) = \begin{cases} 1 & \text{if } \forall c \in C, c \neq class(d), \\ & S_{class(d)} > S_s \text{ and } \frac{S_{class(d)}}{T} \leq p \\ 0 & \text{otherwise} \end{cases} \tag{106}$$

where $cont(d)$ stands for *contribution*(d)

4.5.3. Limitation of K-Nearest Neighbor

k-NN is a classification method that is easy to implement and adapts to any kind of feature space. This model also naturally handles multi-class cases [139,140]. However, k-NN is limited by data storage constraint for large search problem to find nearest neighbors. Additionally, the performance of k-NN is dependent on finding a meaningful distance function, thus making this technique a very data dependent algorithm [141,142].

4.6. Support Vector Machine (SVM)

The original version of SVM was developed by *Vapnik and Chervonenkis* [143] in 1963. *BE. Boser et al.* [144] adapted this version into a nonlinear formulation in the early 1990s. SVM was originally designed for binary classification tasks. However, many researchers work on multi-class problems using this dominate technique [145].

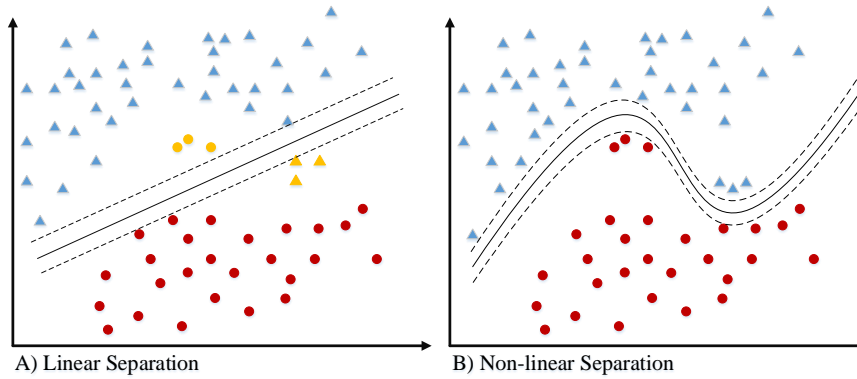

Figure 12. This figure shows the linear and non-linear SVM for 2D dataset (for text data we have thousands of dimitions)

4.6.1. Binary-class SVM

In the context of text classification, let x_1, x_2, \dots, x_l be training examples belonging to one class X , where X is a compact subset of R^N [21]. Then we can formulate a binary classifier as follows:

$$\min \frac{1}{2} \|w\|^2 + \frac{1}{vl} \sum_{i=1}^l \xi_i - p \tag{107}$$

subject to

$$(w \cdot \Phi(x_i)) \geq p - \xi_i \quad i = 1, 2, \dots, l \quad \xi \geq 0 \tag{108}$$

If w and p solve this problem, then the decision function is given by:

$$f(x) = \text{sign}((w \cdot \Phi(x)) - p) \tag{109}$$

4.6.2. Multi-class SVM

Since SVMs are traditionally used for the binary classification, we need to generate a Multiple-SVM (MSVM) [146] for multi-class problems. One-vs-One is a technique for multi-class SVM that builds $N(N-1)$ classifiers as follows:

$$f(x) = \text{arg max}_i \left(\sum_j f_{ij}(x) \right) \tag{110}$$

The natural way to solve the k -class problem is to construct a decision function of all k classes at once [147,148]. In general, multi-class SVM is an optimization problem of the following form:

$$\min_{w_1, w_2, \dots, w_k, \zeta} \frac{1}{2} \sum_k w_k^T w_k + C \sum_{(x_i, y_i) \in D} \zeta_i \tag{111}$$

$$\text{st. } w_{y_i}^T x - w_k^T x \leq i - \zeta_i, \tag{112}$$

$$\forall (x_i, y_i) \in D, k \in \{1, 2, \dots, K\}, k \neq y_i$$

where (x_i, y_i) represent the training data points such that $(x_i, y_i) \in D$, C is the penalty parameter, ζ is a slack parameter, and k stands for the class.

Another technique of multi-class classification using SVM is All-vs-One. Feature extraction via SVM generally uses one of two methods: word sequences feature extracting [149] and tf-idf. But for

an unstructured sequence such as RNA and DNA sequences, string kernel is used. However, string kernel can be used for a document categorization [150].

4.6.3. String Kernel

Text classification is also has been studied using string kernel [150]. The basic idea of string kernel (SK) is using $\Phi(\cdot)$ to map the string in the feature space.

Spectrum Kernel (SP) has been applied to many different application, including text, DNA, and protein classification [151,152]. The basic idea of SP is counting the number of time a word appears in string x_i as a feature map where defining feature maps from $x \rightarrow R^k$.

$$\Phi_k(x) = \Phi_j(x)_{j \in \Sigma^k} \tag{113}$$

where

$$\Phi_j(x) = \text{number of } j \text{ feature appears in } x \tag{114}$$

The feature map $\Phi_i(x)$ is generated by the sequence x_i and kernel defines as follows:

$$F = \Sigma^k \tag{115}$$

$$K_i(x, x') = \langle \Phi_i(x), \Phi_i(x') \rangle \tag{116}$$

The main limitation of SVM when applied to string sequence classification is time complexity [153]. The features are generated using dictionary size Σ and F is the number of features and bounded by Equation 115. The kernel calculation is similar with SP and uses Equation 116, and finally normalize the kernel using Equation 117.

$$K^{Norm}(x, y) \leftarrow \frac{K(x, y)}{\sqrt{K(x, x)} \sqrt{K(y, y)}} \tag{117}$$

$$\langle f^x, f^y \rangle = \sum_{i=1}^{n_1} \sum_{j=1}^{n_2} h(u_i^{s_1}, u_j^{s_2}) \tag{118}$$

where two sequences, $u_i^{s_1}$ and $u_j^{s_2}$, are lengths of s_1 and s_2 respectively.

4.6.4. Stacking Support Vector Machine (SVM)

Stacking SVM is a hierarchical classification method used for category tree structure based on top-down level-based approach [154]. This technique provides a hierarchical model of individual SVM classifiers, and thus generally produces more accurate results than single-SVM models [155].

4.6.5. Multiple Instance learning (MIL)

Multiple Instance learning (MIL) is a supervised learning method [156] and is typically formulated as one of two SVM-based methods (mi-SVM and MI-SVM) [157]. MIL takes in a set of labeled bags as input instead of instances. A bag is labeled positive if there is at least one instance in it with a positive label, and labeled negative if all instances of it are negative. Then, the learner tries to infer a concept that label individual instances correctly [156]. In statistical pattern recognition, it is assumed that a training set of labeled patterns is available where each pair $(x_i, y_i) \in R^d \times Y$ has been generated from an unknown distribution independently. The goal is to find a classifier from patterns to labels *i.e.* $f : R^d \rightarrow Y$. In MIL, the algorithm assumes the input is available as a set of input patterns x_1, \dots, x_n grouped into bags B_1, \dots, B_m where $B_I = \{x_i : i \in I\}$ for the given index sets $I \subseteq \{1, \dots, n\}$. Each bag

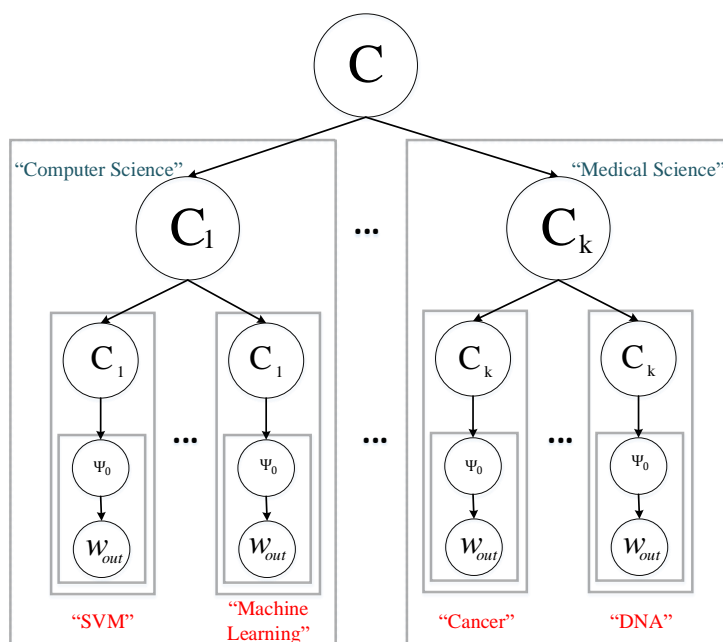

Figure 13. Hierarchical Classification Method

B_I is associated with label Y_I where $Y_I = -1$ if $y_i = -1$ for all $i \in I$ and $Y_I = 1$ if there is at least one instance $x_i \in B_I$ with positive label [157]. The relationship between instance labels y_i and bag labels Y_I can be expressed as $Y_I = \max_{i \in I} y_i$ or a set of linear constraints:

$$\sum_{i \in I} \frac{y_i + 1}{2} \geq 1, \tag{119}$$

$$\forall I \text{ s.t. } Y_I = 1,$$

$$y_i = -1, \forall I \text{ s.t. } Y_I = -1.$$

The discriminant function $f : X \rightarrow R$ is called MI-separating with respect to a multiple-instance data set if $\text{sgn} \max_{i \in I} f(x_i) = Y_I$ for all bags B_I holds.

4.6.6. Limitation of Support Vector Machine (SVM)

SVM has been one of the most efficient machine learning algorithms since its introduction in the 1990s [158]. But the SVM algorithms for text classification are limited by the lack of transparency in results caused by a high number of dimensions. Due to this, it cannot show the company score as a parametric function based on financial ratios nor any other functional form [158]. A further limitation is a variable financial ratios rate [159].

4.7. Decision Tree

One earlier classification algorithm for text and data mining is decision tree [160]. Decision tree classifiers (DTCs) are used successfully in many diverse areas for classification [161]. The structure of this technique is a hierarchical decomposition of the data space [7,160]. Decision tree as classification task was introduced by *D. Morgan* [162] and developed by *JR. Quinlan* [163]. The main idea is creating a tree based on the attribute for categorized data points, but the main challenge of a decision tree is which attribute or feature could be in parents' level and which one should be in child level. To solve

this problem, *De Mántaras* [164] introduced statistical modeling for feature selection in tree. For a training set containing p positive and n negative:

$$H\left(\frac{p}{n+p}, \frac{n}{n+p}\right) = -\frac{p}{n+p} \log_2 \frac{p}{n+p} - \frac{n}{n+p} \log_2 \frac{n}{n+p} \tag{120}$$

Choose attribute A with k distinct value, divides the training set E into subsets of $\{E_1, E_2, \dots, E_k\}$. The expect entropy (EH) remain after trying attribute A (with branches $i = 1, 2, \dots, k$):

$$EH(A) = \sum_{i=1}^K \frac{p_i + n_i}{p+n} H\left(\frac{p_i}{n_i + p_i}, \frac{n_i}{n_i + p_i}\right) \tag{121}$$

Information gain (I) or reduction in entropy for this attribute is :

$$A(I) = H\left(\frac{p}{n+p}, \frac{n}{n+p}\right) - EH(A) \tag{122}$$

Choose the attribute with largest information gain as parent’s node.

4.7.1. Limitation of Decision Tree algorithm

The decision tree is a very fast algorithm for both learning and prediction; but it is also extremely sensitive to small perturbations in the data [165], and can be easily overfit [166]. These effects can be negated by validation methods and pruning, but this is a grey area [165]. This model also has problems with out-of-sample prediction [167].

4.8. Random Forest

Random forests or random decision forests technique is an ensemble learning method for text classification. This method, which used t tree as parallel, was introduced by *T. Kam Ho* [168] in 1995. As shown in Figure 14, main idea of RF is generating random decision trees. This technique was further developed in 1999 by *L. Breiman* [169], who found convergence for RF as margin measures ($mg(X, Y)$) as follows:

$$mg(X, Y) = av_k I(h_k(X) = Y) - \max_{j \neq Y} av_k I(h_k(X) = j) \tag{123}$$

where $I(\cdot)$ refers to indicator function.

4.8.1. Voting

After training all trees as forest, predictions are assigned based on voting [170] as follows:

$$\delta_V = arg \max_i \sum_{j:j \neq i} I_{\{r_{ij} > r_{ji}\}} \tag{124}$$

such that

$$r_{ij} + r_{ji} = 1 \tag{125}$$

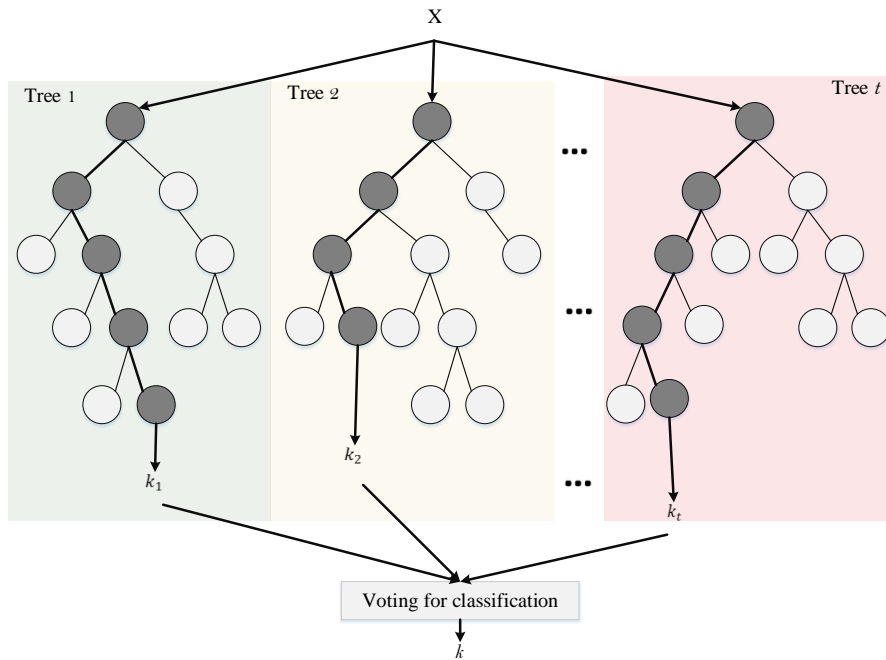

Figure 14. Random Forest

4.8.2. Limitation of Random Forests

Random forests (i.e. ensembles of decision trees) are very fast to train for text datasets in comparison to other techniques such as Deep Learning, but quite slow to create predictions once trained [171]; thus, in order to achieve a faster structure, the number of trees in forest must be reduced, as more trees in forest increases time complexity in the prediction step.

4.9. Conditional Random Field (CRF)

Conditional Random Field (CRF) is an undirected graphical model, as shown in figure 15. CRFs are essentially a way of combining the advantages of classification and graphical modeling which combining the ability to compactly model multivariate data, and the ability to leverage a high dimensional features space for prediction [172] (This model is very powerful for text data due to high feature space). CRFs state the conditional probability of a label sequence Y given a sequence of observation X i.e. $P(Y|X)$. CRFs can incorporate complex features into an observation sequence without violating the independence assumption by modeling the conditional probability of the label sequence rather than the joint probability $P(X, Y)$ [173,174]. Clique (i.e. fully connected subgraph) potential is used for computing $P(X|Y)$. With respect to the potential function for each clique in the graph, the probability of a variable configuration corresponds to the product of a series of a non-negative potential functions. The value computed by each potential function is equivalent to the probability of the variables in the corresponding clique for a particular configuration [173]. That is:

$$P(V) = \frac{1}{Z} \prod_{c \in \text{cliques}(V)} \psi(c) \tag{126}$$

where Z is the normalization term. The conditional probability $P(X|Y)$ can be formulated as:

$$P(Y|X) = \frac{1}{Z} \prod_{t=1}^T \psi(t, y_{t-1}, y_t, X) \tag{127}$$

Given the potential function ($\psi(t, y_{t-1}, y_t, X) = \exp(w \cdot f(t, y_{t-1}, y_t, X))$), the conditional probability can be rewritten as:

$$P(Y|X) = \prod_{t=1}^T \exp(w \cdot f(t, y_{t-1}, y_t, X)) \quad (128)$$

where w is the weight vector associated with a feature vector computed by f .

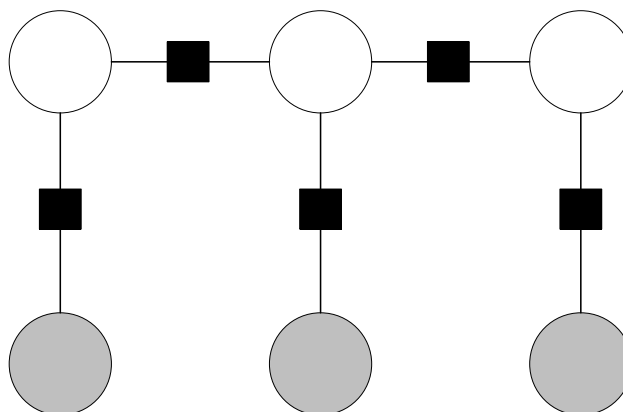

Figure 15. Linear-chain CRF

4.9.1. Limitation of Conditional Random Field (CRF)

With regards to CRF, The most evident disadvantage of CRF is a high computational complexity of the training step [175], especially, for text datasets due to high feature space. And also this algorithm does not perform with unseen words (*i.e.* with words that were not present in training data sample) [176].

4.10. Deep Learning

Deep learning models have achieved state-of-the-art results across many domains, including a wide variety of NLP applications. Deep learning for text and document classification includes three basic architectures of deep learning in parallel. We describe each individual model in detail below.

4.10.1. Deep Neural Networks

Deep neural networks (DNN) are designed to learn by multi-connection of layers that every single layer only receives the connection from previous and provides connections only to the next layer in hidden part [2]. Figure 16 depicts the structure of a standard DNN. The input consists of the connection of the input feature space (as discussed in Section 2) with the first hidden layer of the DNN. The input layer may be constructed via tf-idf, word embedding, or some other feature extraction method. The output layer is equal to the number of classes for multi-class classification or only one for binary classification. In this technique, multi-class DNNs, each learning model is generated (number of nodes in each layer and also the number of layers are completely random assigned). The implementation of DNN is a discriminative trained model that uses standard back-propagation algorithm using sigmoid (equation 129), ReLU [177] (equation 130) as activation function. The output layer for multi-class classification should be a *Softmax* function (as shown in Equation 131).

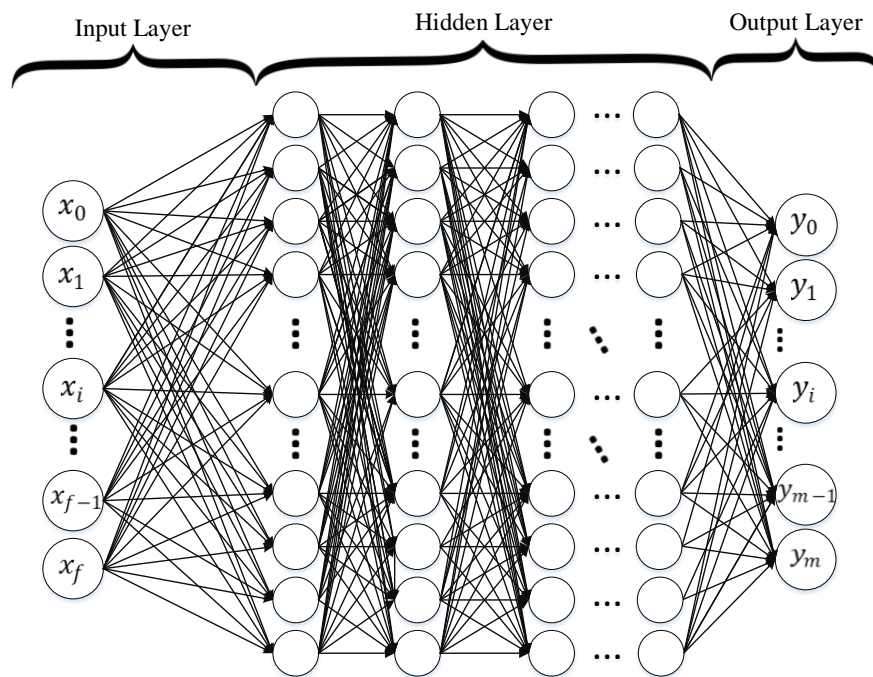

Figure 16. Standard, fully connected Deep Neural Network

$$f(x) = \frac{1}{1 + e^{-x}} \in (0, 1) \tag{129}$$

$$f(x) = \max(0, x) \tag{130}$$

$$\sigma(z)_j = \frac{e^{z_j}}{\sum_{k=1}^K e^{z_k}} \tag{131}$$

$$\forall j \in \{1, \dots, K\}$$

Given a set of example pairs $(x, y), x \in X, y \in Y$, the goal is to learn the relationship between these input and target spaces using hidden layers. In text classification applications, the input is a string which is generated via vectorization of the raw text data.

4.10.2. Recurrent Neural Network (RNN)

Another neural network architecture that researchers have used for text mining and classification is recurrent neural network (RNN) [178,179]. RNN assigns more weights to the previous data points of a sequence. Therefore, this technique is a powerful method for text, string, and sequential data classification. A RNN considers the information of previous nodes in a very sophisticated method which allows for better semantic analysis of a dataset’s structure. RNN mostly works by using LSTM or GRU for text classification, as shown in Figure 17 which contains input layer (word embedding), hidden layers, and finally output layer. This method can be formulated as:

$$x_t = F(x_{t-1}, u_t, \theta) \tag{132}$$

where x_t is the state at time t and u_t refers to the input at step t . More specifically, we can use weights to formulate Equation 132, parameterized by:

$$x_t = \mathbf{W}_{\text{rec}}\sigma(x_{t-1}) + \mathbf{W}_{\text{in}}u_t + \mathbf{b} \tag{133}$$

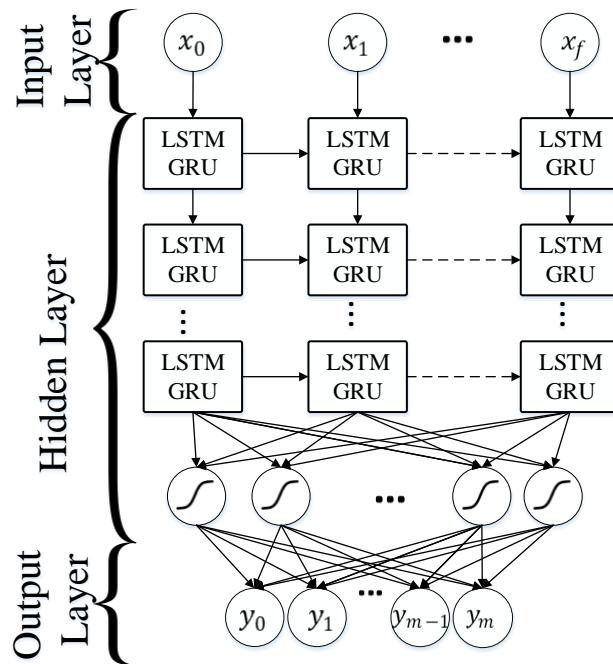

Figure 17. Standard LSTM/GRU Recurrent Neural Networks

where W_{rec} refers to recurrent matrix weight, W_{in} refers to input weights, b is the bias and σ denotes an element-wise function.

Figure 17 illustrates an extended RNN architecture. Despite the benefits described above, RNN is vulnerable to the problems of vanishing gradient and exploding gradient when the error of the gradient descent algorithm is back propagated through the network [180].

4.10.2.1 Long Short-Term Memory (LSTM)

Long Short-Term Memory (LSTM) was introduced by S. Hochreiter and J. Schmidhuber [181], and has since been augmented by many research scientists [182].

Long Short-Term Memory (LSTM) is a special type of RNN that addresses these problems by preserving long term dependency in a more effective way in comparison to the basic RNN. LSTM is particularly useful with respect to overcoming the vanishing gradient problem [183]. Although LSTM has a chain-like structure similar to RNN, LSTM uses multiple gates to carefully regulate the amount of information that is allowed into each node state. Figure 18 shows the basic cell of an LSTM model. A step by step explanation of an LSTM cell is as follows:

$$i_t = \sigma(W_i[x_t, h_{t-1}] + b_i), \tag{134}$$

$$\tilde{C}_t = \tanh(W_c[x_t, h_{t-1}] + b_c), \tag{135}$$

$$f_t = \sigma(W_f[x_t, h_{t-1}] + b_f), \tag{136}$$

$$C_t = i_t * \tilde{C}_t + f_t C_{t-1}, \tag{137}$$

$$o_t = \sigma(W_o[x_t, h_{t-1}] + b_o), \tag{138}$$

$$h_t = o_t \tanh(C_t), \tag{139}$$

where equation 134 represents the input gate, Equation 135 represents the candid memory cell value, Equation 136 defines forget-gate activation, Equation 137 calculates the new memory cell value, and Equation 138 and 139 define the final output gate value. In the above description, each b represents a bias vector, each W represent a weight matrix, and x_t represents input to the memory cell at time t .

Furthermore, i, c, f, o indices refer to input, cell memory, forget and output gates respectively. Figure 18 shows a graphical representation of the structure of these gates.

A RNN can be biased when later words are more influential than earlier ones. Convolutional neural network (CNN) models (discussed in Subsection 4.10.3) were introduced to overcome this bias by deploying a max-pooling layer to determine discriminative phrases in text data [6].

4.10.2.2 Gated Recurrent Unit (GRU)

Gated recurrent units (GRUs) are a gating mechanism for RNN formulated by *J. Chung et al.*[184] and *K.Cho et al.* [100]. GRUs are a simplified variant of the LSTM architecture. However, a GRU differs from LSTM because it contains two gates and a GRU does not possess internal memory (i.e. the C_{t-1} in Figure 18). Furthermore, a second non-linearity is not applied (i.e. tanh in Figure 18). A step by step explanation of a GRU cell is as follows:

$$z_t = \sigma_g(W_z x_t + U_z h_{t-1} + b_z), \tag{140}$$

where z_t refers to the update gate vector of t , x_t stands for input vector, W, U and b represent parameter matrices/vectors. The activation function (σ_g) is either a sigmoid or ReLU and can be formulated as follow:

$$\tilde{r}_t = \sigma_g(W_r x_t + U_r h_{t-1} + b_r), \tag{141}$$

where r_t stands for reset gate vector of t , z_t is update gate vector of t .

$$h_t = z_t \circ h_{t-1} + (1 - z_t) \circ \sigma_h(W_h x_t + U_h(r_t \circ h_{t-1}) + b_h) \tag{142}$$

where h_t is output vector of t , and σ_h indicates the hyperbolic tangent function.

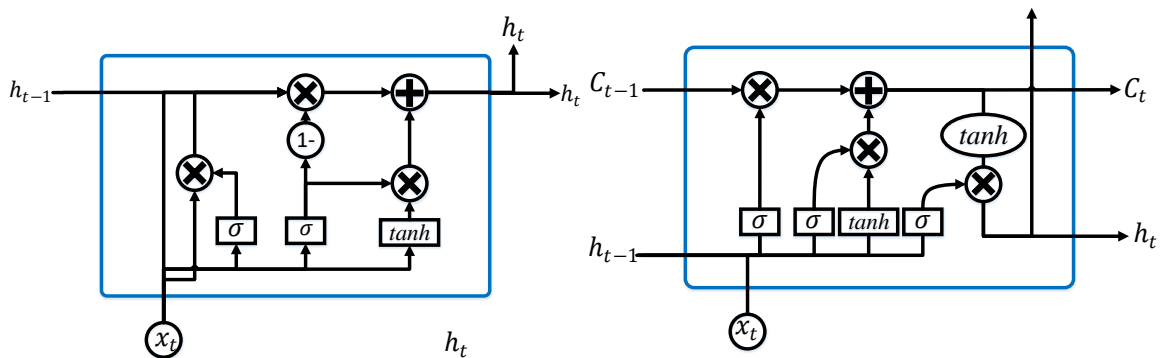

Figure 18. The left Figure is a GRU cell while the right figure is a LSTM cell

4.10.3. Convolutional Neural Networks (CNN)

A convolutional neural network (CNN) is a deep learning architecture that is commonly used for hierarchical document classification [6,185]. Although originally built for image processing, CNNs have also been effectively used for text classification [27,186]. In a basic CNN for image processing, an image tensor is convolved with a set of kernels of size $d \times d$. These convolution layers are called feature maps and can be stacked to provide multiple filters on the input. To reduce the computational complexity, CNNs use pooling to reduce the size of the output from one layer to the next in the network. Different pooling techniques are used to reduce outputs while preserving important features [187].

The most common pooling method is max pooling where the maximum element in the pooling window is selected. In order to feed the pooled output from stacked featured maps to the next layer, the

maps are flattened into one column. The final layers in a CNN are typically fully connected. In general, during the back-propagation step of a convolutional neural network, both the weights and the feature detector filters are adjusted. A potential problem that arises when using CNN for text classification is the number of 'channels', Σ (size of the feature space). While image classification application generally have few channels (e.g. only 3 channels of RGB), Σ may be very large (e.g. 50K) for text classification applications [188], thus resulting in very high dimensionality. Figure 19 illustrate the CNN architecture for text classification which contains word embedding as input layer 1D convolutional layers, 1D pooling layer, fully connected layers, and finally output layer.

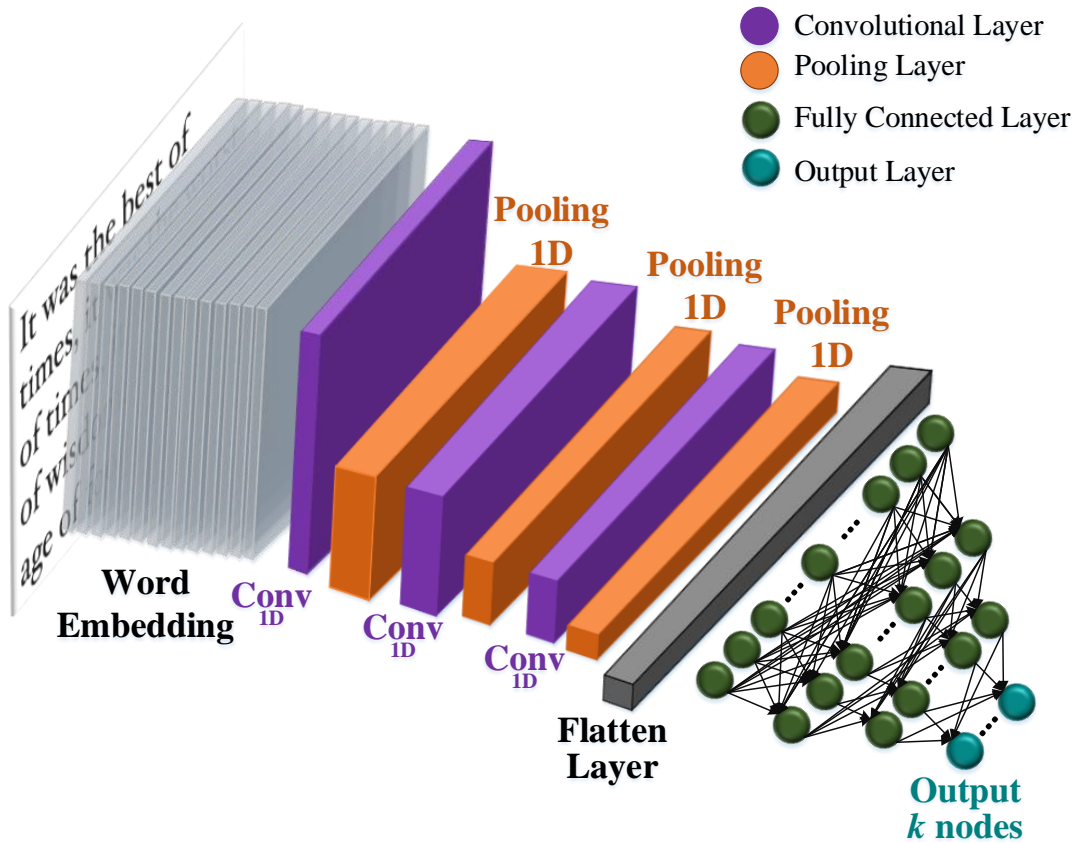

Figure 19. CNN architecture for text classification

4.10.4. Deep Belief Network (DBN)

A deep belief network (DBN) is a deep learning structure that is superposed by restricted Boltzmann machines (RBMs) [1]. A RBM is a generative artificial neural network which could learn probability distribution over samples. Contrastive divergence (CD) [189] is a training technique used for RBMs [190,191].

The energy function is as follows:

$$E(v, h) = - \sum_i a_i v_i - \sum_j b_j h_j - \sum_i \sum_j v_i w_{i,j} h_j \tag{143}$$

where a_i is visible units, and b_i refers to hidden units in matrix notation. This expression can be simplified as:

$$E(v, h) = -a^T v - b^T h - v^T W h \tag{144}$$

Given a configuration of the hidden units h is define as follows:

$$P(v|h) = \prod_{i=1}^m P(v_i|h) \tag{145}$$

For Bernoulli, the logistic function for visible units is replaced as follows:

$$P(v_i^k = 1|h) = \frac{\exp(a_i^k + \sum_j W_{ij}^k h_j)}{\sum_{k'=1}^K \exp(a_i^{k'} + \sum_j W_{ij}^{k'} h_j)} \tag{146}$$

The update function with gradient descent is as follows:

$$w_{ij}(t+1) = w_{ij}(t) + \eta \frac{\partial \log(p(v))}{\partial w_{ij}} \tag{147}$$

4.10.5. Hierarchical Attention Networks (HAN)

One of the successful deep architecture for text and document classification is hierarchical attention networks (HAN). This technique was introduced by Z. Yang *et al.* [192] and SP. Hongsuck *et al.* [193]. The structure of a HAN focuses on the document-level classification which a document has L sentences and each sentence contains T_i words, where w_{it} with $t \in [1, T]$ represents the words in the i th sentence. The HAN architecture is illustrated in Figure 20, where the lower level contains word encoding and word attention in lower level and the upper level contains sentence encoding and sentence attention.

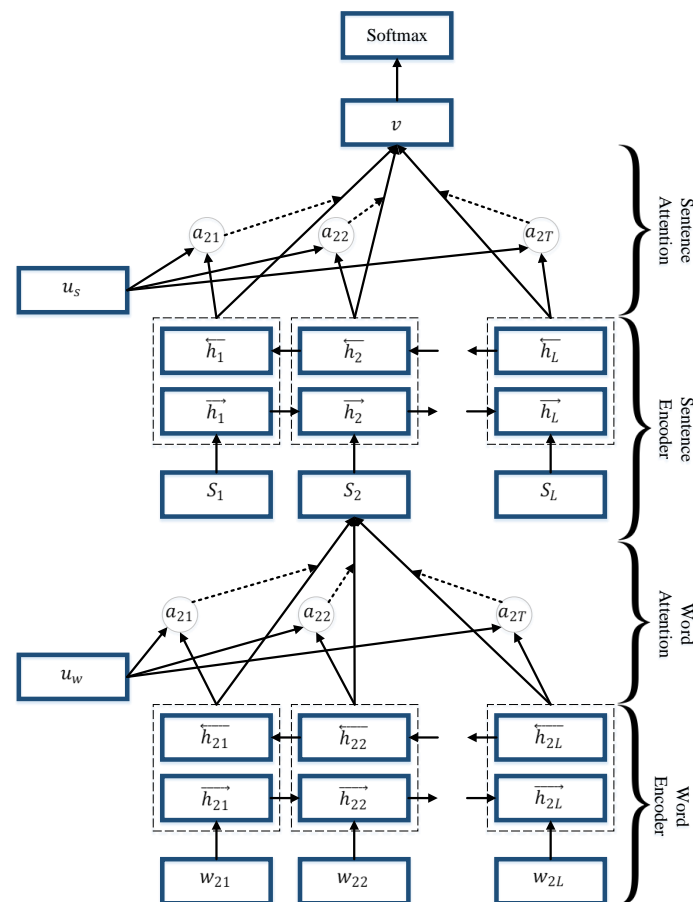

Figure 20. Hierarchical Attention Networks for document classification

4.10.6. Combination Techniques

Many researchers combine or concatenate standard deep learning architectures in order to develop novel techniques of with more robust and accurate architectures for classification tasks. In this sub-section, we describe the recent and popular deep learning architectures and structure.

4.10.6.1 Random Multimodel Deep Learning (RMDL)

Random Multimodel Deep Learning (RMDL) was introduced by *K. Kowsari et al.* [4,5] as a novel deep learning technique for classification. RMDL can be used in any kind of dataset for classification. An overview of this technique is shown in Figure 21 which illustrates the architecture using multi-DNN, deep CNN, and deep RNN. The number of layers and nodes for all of these deep learning multi models are generated randomly (e.g. 9 random models in RMDL constructed from 3 CNNs, 3 RNNs, and 3 DNNs, all of which are unique due to randomly creation).

$$M(y_{i1}, y_{i2}, \dots, y_{in}) = \left[\frac{1}{2} + \frac{(\sum_{j=1}^n y_{ij}) - \frac{1}{2}}{n} \right] \tag{148}$$

where n is the number of random models, and y_{ij} is the output prediction of model for data point i in model j (Equation 148 is used for binary classification, $k \in \{0, 1\}$). The output space uses majority vote to calculate the final value of \hat{y}_i . Therefore, \hat{y}_i is given as follows:

$$\hat{y}_i = [\hat{y}_{i1} \dots \hat{y}_{ij} \dots \hat{y}_{in}]^T \tag{149}$$

where n is number of random model, and \hat{y}_{ij} shows the prediction of label of data point (e.g. document) of $D_i \in \{x_i, y_i\}$ for model j and $\hat{y}_{i,j}$ is defined as follows:

$$\hat{y}_{i,j} = \underset{k}{\operatorname{arg\,max}} [\operatorname{softmax}(y_{i,j}^*)] \tag{150}$$

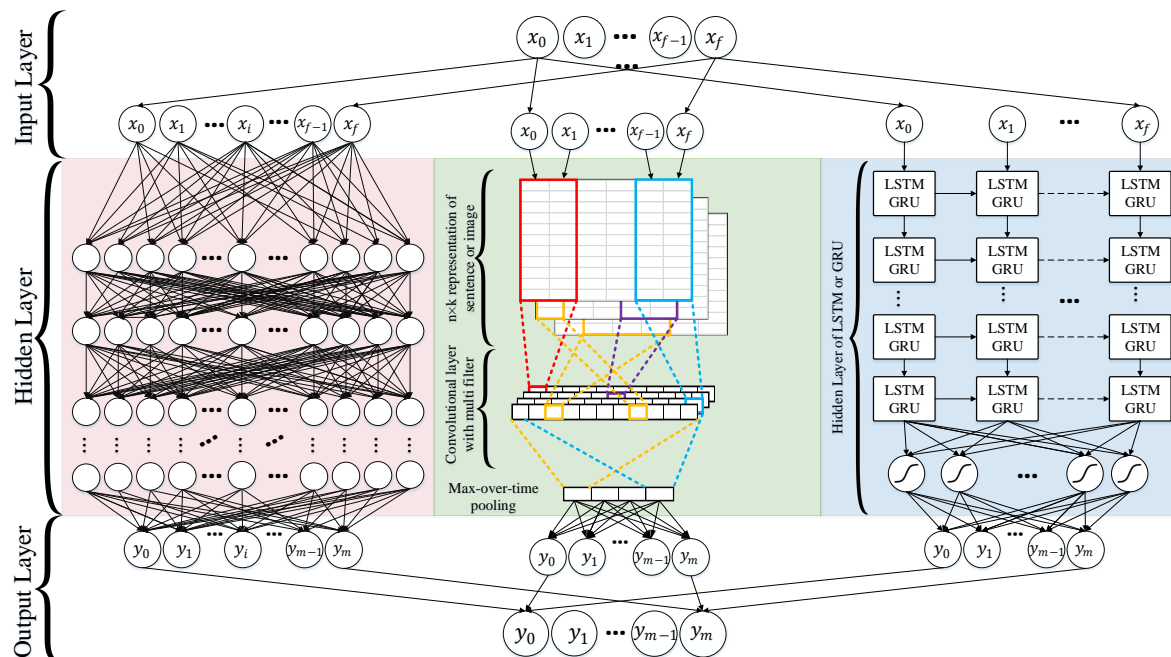

Figure 21. Random Multimodel Deep Learning (RDML) architecture for classification. RMDL includes 3 Random models: a DNN classifier (left), a deep CNN classifier (middle), and a deep RNN classifier (right). Each unit could be a LSTM or GRU.

After all the RDL models (RMDL) are trained, the final prediction is calculated using majority vote on the output of these models. The main idea of using multi-model with different optimizers is that if one optimizer does not provide a good fit for a specific dataset, the RMDL model with n random models (where some of them might use different optimizers) could ignore k models which are not efficient if and only if $n > k$. Using multi-techniques of optimizers (e.g. SGD, Adam, RMSProp, Adagrad, Adamax) helps the RMDL model be more suitable for any type of datasets. While we only used 2 optimizers (Adam, and RMSProp) for evaluating the model in this research, the RMDL model can use any kind of optimizer. In this part, we describe common optimization techniques used in deep learning architectures.

Stochastic Gradient Descent (SGD) Optimizer:

The basic equation for Stochastic Gradient Descent (SGD) [194] is shown in Equation 151. SGD uses a momentum on re-scaled gradient which is shown in equation 152 for updating parameters.

$$\theta \leftarrow \theta - \alpha \nabla_{\theta} J(\theta, x_i, y_i) \quad (151)$$

$$\theta \leftarrow \theta - (\gamma \theta + \alpha \nabla_{\theta} J(\theta, x_i, y_i)) \quad (152)$$

RMSprop:

T. Tieleman and G. Hinton [195] introduced RMSprop as a novel optimizer which divides the learning rate for a weight by a running average of the magnitudes of recent gradients for that weight. The equation of the momentum method for RMSprop is as follows:

$$v(t) = \alpha v(t-1) - \epsilon \frac{\partial E}{\partial w}(t) \quad (153)$$

$$\begin{aligned} \Delta w(t) &= v(t) \\ &= \alpha v(t-1) - \epsilon \frac{\partial E}{\partial w}(t) \\ &= \alpha \Delta v(t-1) - \epsilon \frac{\partial E}{\partial w}(t) \end{aligned} \quad (154)$$

RMSProp does not do bias correction, which causes significant problems when dealing with a sparse gradient.

Adam Optimizer

Adam is another stochastic gradient optimizer which uses only the first two moments of gradient (v and m , shown in Equation 155, 156, 157, and 158) and calculate the average over them. It can handle non-stationary of the objective function as in RMSProp while overcoming the sparse gradient issue limitation of RMSProp [196].

$$\theta \leftarrow \theta - \frac{\alpha}{\sqrt{\hat{v}} + \epsilon} \hat{m} \quad (155)$$

$$g_{i,t} = \nabla_{\theta} J(\theta_i, x_i, y_i) \quad (156)$$

$$m_t = \beta_1 m_{t-1} + (1 - \beta_1) g_{i,t} \quad (157)$$

$$v_t = \beta_2 v_{t-1} + (1 - \beta_2) g_{i,t}^2 \quad (158)$$

where m_t is the first moment and v_t indicates second moment that both are estimated. $\hat{m}_t = \frac{m_t}{1 - \beta_1^t}$ and $\hat{v}_t = \frac{v_t}{1 - \beta_2^t}$.

Adagrad:

Adagrad is addressed in [197] as a novel family of sub-gradient methods which dynamically absorb knowledge of the geometry of the data to perform more informative gradient-based learning.

AdaGrad is an extension of SGD. In iteration k , the gradient is defined as:

$$G^{(k)} = \text{diag} \left[\sum_{i=1}^k g^{(i)} (g^{(i)})^T \right]^{1/2} \tag{159}$$

diagonal matrix:

$$G_{jj}^{(k)} = \sqrt{\sum_{i=1}^k (g_i^{(i)})^2} \tag{160}$$

update rule:

$$\begin{aligned} x^{(k+1)} &= \arg \min_{x \in X} \{ \langle \nabla f(x^{(k)}), x \rangle + \\ &\quad \frac{1}{2\alpha_k} \|x - x^{(k)}\|_{G^{(k)}}^2 \} \\ &= x^{(k)} - \alpha B^{-1} \nabla f(x^{(k)}) \quad (\text{if } X = \mathbb{R}^n) \end{aligned} \tag{161}$$

Adadelta:

AdaDelta, introduced by MD. Zeiler [198], uses the exponentially decaying average of g_t as 2_{nd} moment of gradient. This method is an updated version of Adagrad which relies on only first order information. The update rule for Adadelta is:

$$g_{t+1} = \gamma g_t + (1 - \gamma) \nabla \mathcal{L}(\theta)^2 \tag{162}$$

$$x_{t+1} = \gamma x_t + (1 - \gamma) v_{t+1}^2 \tag{163}$$

$$v_{t+1} = -\frac{\sqrt{x_t + \epsilon} \delta L(\theta_t)}{\sqrt{g_{t+1} + \epsilon}} \tag{164}$$

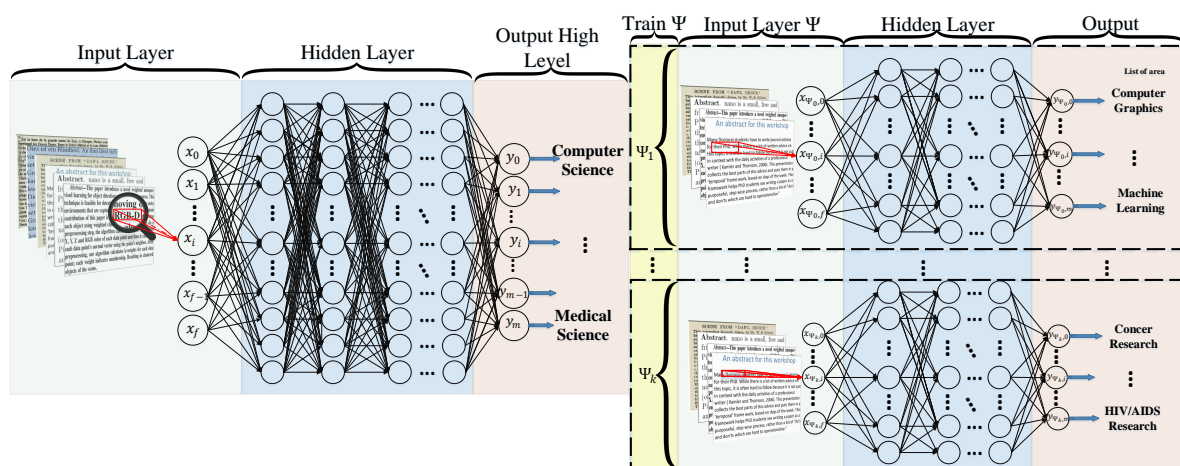

Figure 22. HDLTex: Hierarchical Deep Learning for Text Classification. DNN approach for the text classification. The top figure depicts the parent-level of our model, and the bottom figure depicts child-level models (Ψ_i) as input documents in the parent level.

4.10.6.2 Hierarchical Deep Learning for Text (HDLTex)

The primary contribution of the Hierarchical Deep Learning for Text (HDLTex) architecture is hierarchical classification of documents [2]. A traditional multi-class classification technique can work well for a limited number classes, but performance drops with increasing number of classes, as is present in hierarchically organized documents. In this hierarchical deep learning model, this problem was solved by creating architectures that specialize deep learning approaches for their level of the document hierarchy (e.g. see Figure 22). The structure of the HDLTex architecture for each deep learning model is as follows:

DNN: 8 hidden layers with 1024 cells in each hidden layer.

RNN: GRU and LSTM are used in this implementation, 100 cells with GRU with two hidden layers.

CNN: Filter sizes of $\{3, 4, 5, 6, 7\}$ and max-pool of 5, layer sizes of $\{128, 128, 128\}$ with max pooling of $\{5, 5, 35\}$, the CNN contains 8 hidden layers.

All models were constructed using the following parameters: *Batch Size = 128, learning parameters = 0.001, $\beta_1=0.9, \beta_2=0.999, \epsilon = 1e^{08}, decay = 0.0, Dropout=0.5$ (DNN) and $Dropout=0.25$ (CNN and RNN).*

HDLTex used the following cost function for the deep learning models evaluation:

$$Acc(X) = \sum_{\varrho} \left[\frac{Acc(X_{\Psi_{\varrho}})}{k_{\varrho} - 1} \sum_{\Psi \in \{\Psi_1, \dots, \Psi_k\}} Acc(X_{\Psi_i}) \cdot n_{\Psi_k} \right] \quad (165)$$

where ϱ is the number of levels, k indicates number of classes for each level, and Ψ refers to the number of classes in the child's level of the hierarchical model.

4.10.6.3 Other Techniques

In this section, we discuss other techniques of text classification that come from combining deep learning architectures. Recurrent Convolutional Neural Networks (RCNN) is used for text classification [6,199]. RCNNs can capture contextual information with the recurrent structure and construct the representation of text using a CNN [6]. This architecture is a combination of RNN and CNN that leverages the advantages of both techniques in a model.

C-LSTM is another technique of text and document classification that was introduced by C. Zhou et al. [200]. C-LSTM combines CNN with LSTM in order to learn phrase-level features using convolutional layers. This architecture feeds sequences of higher level representations into the LSTM to learn long-term dependent.

4.10.7. Limitation of Deep Learning

Model Interpretability of Deep Learning (DL), specially Deep Neural Networks (DNN), has always been a limiting factor for use cases requiring explanations of the features involved in modelling and such is the case for many healthcare problems. This problem is due to scientists prefer to use traditional techniques such as Linear Models, Bayesian Models, SVM, decision trees, etc. for their works. The weights in a neural network are a measure of how strong each connection is between each neuron to find the important feature space. Deep Learning (DL) is one of the most powerful techniques in artificial intelligence (AI), and many researchers and scientists focus on deep learning architectures to improve robustness and computational power of this tool. However, deep learning architectures also have some disadvantages and limitations when applied to classification tasks. One of the main problems of this model is that DL does not facilitate comprehensive theoretical understanding of learning [201]. A well-known disadvantage of DL methods is their "black box" nature [202,203]. That

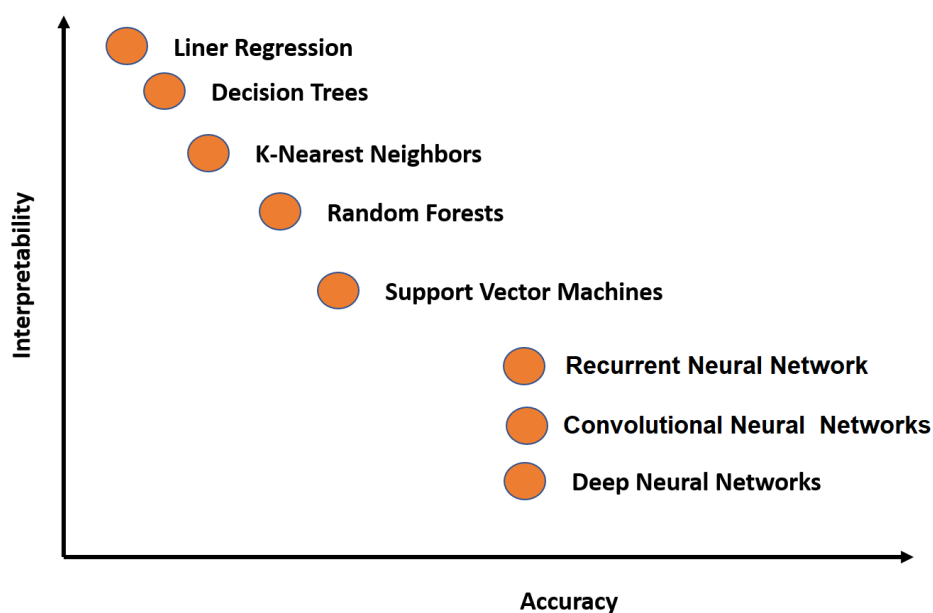

Figure 23. The Model Interpretability comparison between traditional and Deep Learning techniques

is, the method by which DL methods come up with the convolved output is not readily understandable. Another limitation of DL is that it usually requires much more data than traditional machine learning algorithms, which means that this technique cannot be applied to classification tasks over small datasets [204,205]. Additionally, the massive amount of data needed for DL classification algorithms further exacerbates the computational complexity during the training step [206].

4.11. Semi-supervised learning for Text classification

Many researchers have developed many efficient classifiers for both labeled and unlabeled documents. Semi-supervised learning is a type of supervised learning problem that uses unlabeled data to train a model. Usually, researchers and scientists prefer to use semi-supervised techniques when a small part of the dataset contains labeled data point and a large amount of dataset does not include labels [207]. Most of the semi-supervised learning algorithms for classification tasks use a clustering technique (generally used for unsupervised learning [208]) as follows: Initially a clustering technique is applied on D^T with $K = K$ (the number of classes), since D^T has labeled samples of all K classes [207]. If a partition P_i has labeled samples, then, all data points on that cluster belongs to that label.

The research goal for clustering techniques is to determine if we have more than one class labeled on one cluster, and what happens if we have no labeled data point in one cluster [209]. In this part, we briefly describe the most popular technique of semi-supervised text and document classification. *O. Chapelle and A. Zien* [210] worked on semi-supervised classification via low density separation, which combines graph distance computation with Transductive Support Vector Machine (TSVM) training. *K. Nigam et al.* [211] developed a technique for text classification using expectation-maximization (EM) and generative models for semi-supervised learning with labeled and the unlabeled data in the field of text classifications. *L. Shi et al.* [212] introduced a method for transferring classification knowledge across languages via translated features. This technique uses an EM algorithm that naturally takes into account the ambiguity associated with the translation of a word. *J. Su et al.* [212] introduced “Semi-supervised Frequency Estimate (SFE)”, a MNBC method for large scale text classification. *S. Zhou et al.* [213] invented a novel deep learning method that uses fuzzy DBN for semi-supervised

sentiment classification. This method employs a fuzzy membership function for each category of reviews based on the learned architecture.

5. Evaluation

In the research community, having shared and comparable performance measures to evaluate algorithms is preferable. However, in reality such measures may only exist for a handful of methods. The major problem when evaluating text classification methods is the absence of standard data collection protocols. Even if a common collection method existed (e.g. Reuters news corpus), simply choosing different training and test sets can introduce inconsistencies in model performance [214]. Another challenge with respect to method evaluation is being able to compare different performance measures used in separate experiments. Performance measures generally evaluate specific aspects of classification task performance, and thus do not always present identical information. In this section, we discuss evaluation metrics and performance measures and highlight ways in which the performance of classifiers can be compared.

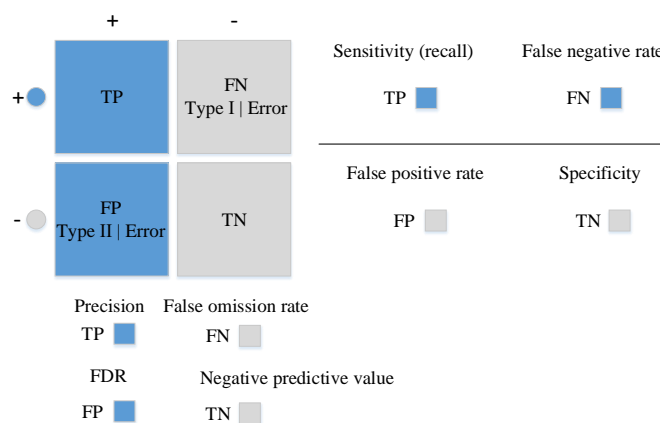

Figure 24. Confusion matrix

Since the underlying mechanics of different evaluation metrics may vary, understanding what exactly each of these metrics represents and what kind of information they are trying to convey is crucial for comparability. Some examples of these metrics include recall, precision, accuracy, F-measure, micro-average, and macro average. These metrics are based on a “confusion matrix” (shown in Figure 24) that comprises true positives (TP), false positives (FP), false negatives (FN) and true negatives (TN) [215]. The significance of these four elements may vary based on the classification application. The fraction of correct predictions over all predictions is called accuracy (Eq. 166). The fraction of known positives that are correctly predicted is called sensitivity *i.e.* true positive rate or recall (Eq. 167). The ratio of correctly predicted negatives is called specificity (Eq. 168). The proportion of correctly predicted positives to all positives is called precision, *i.e.* positive predictive value (Eq. 169).

$$accuracy = \frac{(TP + TN)}{(TP + FP + FN + TN)} \tag{166}$$

$$sensitivity = \frac{TP}{(TP + FN)} \tag{167}$$

$$specificity = \frac{TN}{(TN + FP)} \tag{168}$$

$$Precision = \frac{\sum_{l=1}^L TP_l}{\sum_{l=1}^L TP_l + FP_l} \tag{169}$$

$$Recall = \frac{\sum_{l=1}^L TP_l}{\sum_{l=1}^L TP_l + FN_l} \quad (170)$$

$$F1 - Score = \frac{\sum_{l=1}^L 2TP_l}{\sum_{l=1}^L 2TP_l + FP_l + FN_l} \quad (171)$$

The pitfalls of each of the above-mentioned metrics are listed in Table 6.

5.1. Macro-Averaging and Micro-Averaging

A single aggregate measure is required when several two-class classifiers are being used to process a collection. Macro-averaging gives a simple average over classes while micro-averaging combines per-document decisions across classes and then outputs an effective measure on the pooled contingency table [216]. Macro-averaged results can be computed as follows:

$$B_{macro} = \frac{1}{q} \sum_{\lambda=1}^q B(TP_{\lambda} + FP_{\lambda} + TN_{\lambda} + FN_{\lambda}) \quad (172)$$

where B is a binary evaluation measure calculated based on true positives (TP), false positives (FP), false negatives (FN) and true negatives (TN), and $L = \{\lambda_j : j = 1..q\}$ is the set of all labels.

Micro-averaged results [155,217] can be computed as follows:

$$B_{macro} = B\left(\sum_{\lambda=1}^q TP_{\lambda}, \sum_{\lambda=1}^q FP_{\lambda}, \sum_{\lambda=1}^q TN_{\lambda}, \sum_{\lambda=1}^q FN_{\lambda}\right) \quad (173)$$

Micro-average score assigns equal weights to every document and as a consequence, and it is considered to be a per-document average. On the other hand, macro-average score assigns equal weights to each category without accounting for frequency and therefore it is a per-category average.

5.2. F_{β} Score

F_{β} is one of the most popular aggregated evaluation metrics for classifier evaluation [215]. The parameter β is used to balance recall and precision and defined as follows:

$$F_{\beta} = \frac{(1 + \beta^2)(precision \times recall)}{\beta^2 \times precision + recall} \quad (174)$$

For commonly used $\beta = 1$ i.e. F_1 , recall and precision are given equal weights and Eq. 174 can be simplified to:

$$F_1 = \frac{2TP}{2TP + FP + FN} \quad (175)$$

Since F_{β} is based on recall and precision, it does not represent the confusion matrix fully.

5.3. Matthews Correlation Coefficient (MCC)

The Matthews correlation coefficient (MCC) [30] captures all the data in a confusion matrix and measures the quality of binary classification methods. MCC can be used for problems with uneven class sizes and is still considered a balanced measure. MCC ranges from -1 to 0 (i.e. the classification is always wrong and always true respectively). MCC can be calculated as follows:

$$MCC = \frac{TP \times TN - FP \times FN}{\sqrt{(TP + FP) \times (TP + FN) \times (TN + FP) \times (TN + FN)}} \quad (176)$$

While comparing two classifiers, one may have a higher score using MCC and the other one has a higher score using F_1 and as a result one specific metric cannot capture all the strengths and weaknesses of a classifier [215].

5.4. Receiver Operating Characteristics (ROC)

Receiver operating characteristics (ROC) [218] curves are valuable graphical tools for evaluating classifiers. However, class imbalances (i.e. differences in prior class probabilities [219]) can cause ROC curves to poorly represent the classifier performance. ROC curve plots true positive rate (TPR) and false positive rate (FPR):

$$TPR = \frac{TP}{TP + FN} \quad (177)$$

$$FPR = \frac{FP}{FP + TN} \quad (178)$$

5.5. Area Under ROC Curve (AUC)

The area under ROC curve (AUC) [31,32] measures the entire area underneath the ROC curve. AUC leverages helpful properties such as increased sensitivity in the analysis of variance (ANOVA) tests, independence from decision threshold, invariance to *a priori* class probabilities, and indication of how well negative and positive classes are regarding decision index [220].

For binary classification tasks, AUC can be formulated as:

$$\begin{aligned} AUC &= \int_{-\infty}^{\infty} TPR(T)FPR'(T)dT \\ &= \int_{-\infty}^{\infty} \int_{-\infty}^{\infty} I(T' > T)f_1(T')f_0(T)dTdT' \\ &= P(X_1 > X_0) \end{aligned} \quad (179)$$

For multi-class AUC, an average AUC can be defined [221] as follows:

$$AUC = \frac{2}{|C|(|C| - 1)} \sum_{i=1}^{|C|} AUC_i \quad (180)$$

where C is the number of the classes.

Yang [214] evaluated statistical approaches for text categorization and reported the following important factors that should be considered when comparing classifier algorithms:

- Comparative evaluation across methods and experiments which gives insight about factors underlying performance variations and will lead to better evaluation methodology in the future
- Impact of collection variability such as including unlabelled documents in training or test set and treat them as negative instances can be a serious problem.
- Category ranking evaluation and binary classification evaluation show the usefulness of classifier in interactive applications and emphasize their use in a batch mode respectively. Having both types of performance measurements to rank classifiers is helpful in detecting the effects of thresholding strategies.
- Evaluation of the scalability of classifiers in large category spaces is rarely investigated area.

Table 1. Feature Extraction Comparison

Model	Advantages	Limitation
Weighted Words	<ul style="list-style-type: none"> • Easy to compute • Easy to compute the similarity between 2 documents using it • Basic metric to extract the most descriptive terms in a document • Works with unknown word (e.g. New words in languages) 	<ul style="list-style-type: none"> • It does not capture position in text (syntactic) • It does not capture meaning in text (semantics) • Common words effect on the results (e.g. "am", "is", etc.)
TF-IDF	<ul style="list-style-type: none"> • Easy to compute • Easy to compute the similarity between 2 documents using it • Basic metric to extract the most descriptive terms in a document • common words does not effect on the results due to IDF (e.g. "am", "is", etc.) 	<ul style="list-style-type: none"> • It does not capture position in text (syntactic) • It does not capture meaning in text (semantics)
Word2Vec	<ul style="list-style-type: none"> • It capture position of the words in the text (syntactic) • It capture meaning in of the words (semantics) 	<ul style="list-style-type: none"> • It cannot capture the meaning of the word from text (Fails to capture polysemy) • it cannot capture out-of-vocabulary words from corpus
GloVe (Pre-Trained)	<ul style="list-style-type: none"> • It capture position of the words in the text (syntactic) • It capture meaning in of the words (semantics) • Trained on huge corpus 	<ul style="list-style-type: none"> • It cannot capture the meaning of the word from text (Fails to capture polysemy) • Memory consumption for storage • it cannot capture out-of-vocabulary words from corpus
GloVe (Trained)	<ul style="list-style-type: none"> • It is very straightforward, i.e., to enforce the word vectors to capture sub-linear relationships in the vector space (perform better than Word2vec). • Lower weight for highly frequent word pairs such as stop words like "am", "is", and etc. will not dominate the training progress. 	<ul style="list-style-type: none"> • Memory consumption for storage • Need huge corpus to learn • it cannot capture out-of-vocabulary words from corpus • It cannot capture the meaning of the word from text (Fails to capture polysemy)
FastText	<ul style="list-style-type: none"> • Works for rare words (rare in their character n-grams which are still shared with other words) • Solve out of vocabulary words with n-gram in character level 	<ul style="list-style-type: none"> • It cannot capture the meaning of the word from text (Fails to capture polysemy) • Memory consumption for storage • Computationally is more expensive in comparing with GloVe and Word2Vec
Contextualized Word Representations	<ul style="list-style-type: none"> • It capture the meaning of the word from text (incorporates context, handling polysemy) 	<ul style="list-style-type: none"> • Memory consumption for storage • Improves performance notably on downstream tasks Computationally is more expensive in comparing with others • Need another word embedding for all LSTM and feed forward layers • it cannot capture out-of-vocabulary words from corpus • Works only sentence and document level (it cannot work for individual word-level)

6. Discussion

In this article, we aimed to present a brief overview of text classification techniques, alongside a discussion of corresponding pre-processing steps and evaluation methods. In this section, we compare and contrast each of these techniques and algorithms. Moreover, we discuss the limitations of existing classification techniques and evaluation methods. The main challenge to choosing an efficient classification system is understanding similarity and differences of available techniques in different pipeline steps.

6.1. Text and Document Feature Extraction

We outlined the following two main feature extraction approaches: weighted words (bag-of-words) and word embedding. Word embedding techniques learn from sequences of words by taking into consideration their occurrence and co-occurrence information. Also, these methods are unsupervised models for generating word vectors. In contrast, weighted words features are based on counting words in documents and can be used as a simple scoring scheme of word representation. Each technique presents unique limitations. Weighted words computes document similarity directly from the word-count space which increases the computational time for large vocabularies [222]. While counts of unique words provide independent evidence of similarity, they do not account for semantic similarities between words (*e.g.* “Hello” and “Hi”). Word embedding methods address this issue but are limited by the necessitation of a huge corpus of text datasets for training [223]. As a result, scientists prefer to use pre-trained word embedding vectors [223]. However, this approach cannot work for words missing from these text data corpora. For example, in some short message service (SMS) datasets, people use words with multiple meaning such as slang or abbreviation which do not have semantic similarities. Furthermore, abbreviations are not included in the pre-trained word embedding vectors. To solve these problems, many researchers work on text cleaning as we discussed in Section 2. The word embedding techniques such as GloVe, FastText, and Word2Vec were trained based on the word and nearest neighbor of that word, and this contains a very critical limitation (meaning of a word could be different in two different sentences). To solve this problem, scientist come up with the novel methods called Contextualized Word Representations which trained based on the context of the word into a document.

As shown in Table 1, we compare each evaluate each techniques including Weighted Words, TFIDF, Word2Vec, Glove, FastText, and Contextualized Word Representations.

6.2. Dimensionality Reduction

In Section 3, we outlined many Dimensionality Reduction techniques. In this section, we discuss how efficacy of this step with respect to a text classification system’s computational time and robustness. Dimensionality Reduction is mostly used for improving computational time and reducing memory complexity.

PCA attempts to find orthogonal projections of the dataset which contains the highest variance possible in order to extract linear correlations between variables of the dataset. The main limitation of the PCA is the computational complexity of this technique for dimensionality reduction [224]. For solving this problem, scientists introduced Random Projection technique (Section 3).

LDA is a supervised technique for dimension reduction that can improve the predictive performance of the extracted features. However, LDA requires researchers to manually input the number of components, requires labeled data, and produces features that are not easily interpretable [225]

Random projection is much faster computationally than PCA. However, this method does not perform well for small datasets [226].

Autoencoders requires more data to train than other DR methods, and thus cannot be used as a general-purpose dimensionality reduction algorithm without sufficient data.

T-SNE is mostly used for data visualization in text and document datasets.

Table 2. Text Classification Comparison (Rocchio Algorithm, Boosting, Bagging, Logistic Regression, Naïve Bayes Classifier, K-Nearest Neighbor, and Support Vector Machine)

Model	Advantages	Pitfall
Rocchio Algorithm	<ul style="list-style-type: none"> • Easy to implement • computationally is very cheap • Relevance feedback mechanism (benefits to ranking documents as not-relevant) 	<ul style="list-style-type: none"> • The user can only retrieve a few relevant documents • Rocchio often misclassifies the type for multimodal class • This techniques is not very robust • linear combination in this algorithm is not good for multi-class datasets
Boosting and Bagging	<ul style="list-style-type: none"> • Improves the stability and accuracy (takes the advantage of ensemble learning where in multiple weak learner outperform a single strong learner.) • Reducing variance which helps to avoid overfitting problems. 	<ul style="list-style-type: none"> • Computational complexity • loss of interpretability (if number of model is high, understanding the model is very difficult) • Requires careful tuning of different hyper-parameters.
Logistic Regression	<ul style="list-style-type: none"> • Easy to implement • does not require too many computational resources • it does not require input features to be scaled (pre-processing) • It does not require any tuning 	<ul style="list-style-type: none"> • it cannot solve non-linear problems • prediction requires that each data point be independent • attempting to predict outcomes based on a set of independent variables
Naïve Bayes Classifier	<ul style="list-style-type: none"> • It works very well with text data • Easy to implement • Fast in comparing to other algorithms 	<ul style="list-style-type: none"> • A strong assumption about the shape of the data distribution • limited by data scarcity for which any possible value in feature space, a likelihood value must be estimated by a frequentist
K-Nearest Neighbor	<ul style="list-style-type: none"> • Effective for text datasets • non-parametric • More local characteristics of text or document are considered • Naturally handles multi-class datasets 	<ul style="list-style-type: none"> • computational of this model is very expensive • difficult to find optimal value of k • Constraint for large search problem to find nearest neighbors • Finding a meaningful distance function is difficult for text datasets
Support Vector Machine (SVM)	<ul style="list-style-type: none"> • SVM can model non-linear decision boundaries • Performs similarly to logistic regression when linear separation • robust against overfitting problems (especially for text dataset due to high-dimensional space) 	<ul style="list-style-type: none"> • lack of transparency in results caused by a high number of dimensions (especially for text data). • Choosing an efficient kernel function is difficult (Susceptible to overfitting/training issues depending on kernel) • Memory complexity

6.3. Existing Classification Techniques

In this section, we discuss the limitations and advantages of existing text and document classification algorithms. Then we compare state-of-the-art techniques in two tables.

6.3.1. Limitations and Advantages

As shown in Table 2 and Table 3, the Rocchio algorithm is limited by the fact that the user can only retrieve a few relevant documents using this model [107]. Furthermore, this algorithm's results illustrate several limitations in text classification, which could be addressed by taking semantics into consideration [108]. Boosting and Bagging methods also have many limitations and disadvantages, such as the computational complexity and loss of interpretability [116]. LR works well for predicting categorical outcomes. However, this prediction requires that each data point be independent [123] which is attempting to predict outcomes based on a set of independent variables [124]. Naïve Bayes algorithm also has several limitations. NBC makes a strong assumption about the shape of the data distribution [133,134]. NBC is also limited by data scarcity for which any possible value in feature space, a likelihood value must be estimated by a frequentist [135]. k-NN is a classification method that is easy to implement and adapts to any kind of feature space. This model also naturally handles multi-class cases [139,140]. However, k-NN is limited by data storage constraint for large search problem to find nearest neighbors. Additionally, the performance of k-NN is dependent on finding a meaningful distance function, thus making this technique a very data dependent algorithm [141,142]. SVM has been one of the most efficient machine learning algorithms since its introduction in the 1990s [158]. But they are limited by the lack of transparency in results caused by a high number of dimensions. Due to this, it cannot show the company score as a parametric function based on financial ratios nor any other functional form [158]. A further limitation is a variable financial ratios rate [159]. The decision tree is a very fast algorithm for both learning and prediction; but it is also extremely sensitive to small perturbations in the data [165], and can be easily overfit [166]. These effects can be negated by validation methods and pruning, but this is a grey area [165]. This model also has problems with out-of-sample prediction [167]. Random forests (i.e. ensembles of decision trees) are very fast to train in comparison to other techniques, but quite slow to create predictions once trained [171]; thus, in order to achieve a faster structure, the number of trees in forest must be reduced, as more trees in forest increases time complexity in the prediction step. With regards to CRF, The most evident disadvantage of CRF is a high computational complexity of the training step [175], and also this algorithm does not perform with unknown words (*i.e.* with words that were not present in training data sample) [176]. Deep Learning (DL) is one of the most powerful techniques in artificial intelligence (AI), and many researchers and scientists focus on deep learning architectures to improve robustness and computational power of this tool. However, deep learning architectures also have some disadvantages and limitations when applied to classification tasks. One of the main problems of this model is that DL does not facilitate comprehensive theoretical understanding of learning [201]. A well-known disadvantage of DL methods is their "black box" nature [202,203]. That is, the method by which DL methods come up with the convoluted output is not readily understandable. Another limitation of DL is that it usually requires much more data than traditional machine learning algorithms, which means that this technique cannot be applied to classification tasks over small datasets [204,205]. Additionally, the massive amount of data needed for DL classification algorithms further exacerbates the computational complexity during the training step [206].

6.3.2. State-of-the-art Techniques' comparison

As regarding to Table 4 and Table 5, the text classification techniques are compared with including criteria : architecture, author(s), model, novelty, feature extraction, details, corpus, validation measure, and limitation of each techniques. Each text classification technique (system) contains a model which is the classifier algorithm, and also need a feature extraction technique which mean convert texts or

documents dataset into numerical data (as discussed in Section 2). The another important part in our comparison is the validation measure which is used to evaluate the system.

Table 3. Text Classification Comparison (Decision Tree, Conditional Random Field(CRF), Random Forest, and Deep Learning)

Model	Advantages	Pitfall
Decision Tree	<ul style="list-style-type: none"> • Can easily handle qualitative (categorical) features • Works well with decision boundaries parallel to the feature axis • Decision tree is a very fast algorithm for both learning and prediction 	<ul style="list-style-type: none"> • Issues with diagonal decision boundaries • Can be easily overfit • extremely sensitive to small perturbations in the data • Problems with out-of-sample prediction
Conditional Random Field (CRF)	<ul style="list-style-type: none"> • Its feature design is flexible • Since CRF computes the conditional probability of global optimal output nodes, it overcomes the drawbacks of label bias • Combining the advantages of classification and graphical modeling which combining the ability to compactly model multivariate data 	<ul style="list-style-type: none"> • High computational complexity of the training step • this algorithm does not perform with unknown words • Problem about online learning (It makes it very difficult to re-train the model when newer data becomes available.)
Random Forest	<ul style="list-style-type: none"> • Ensembles of decision trees are very fast to train in comparison to other techniques • Reduced variance (relative to regular trees) • Not require preparation and pre-processing of the input data 	<ul style="list-style-type: none"> • Quite slow to create predictions once trained • more trees in forest increases time complexity in the prediction step • Not as easy to visually interpret • Overfitting can easily occur • Need to choose the number of trees at forest
Deep Learning	<ul style="list-style-type: none"> • Flexible with features design (Reduces the need for feature engineering, one of the most time-consuming parts of machine learning practice.) • Architecture that can be adapted to new problems • Can deal with complex input-output mappings • Can easily handle online learning (It makes it very easy to re-train the model when newer data becomes available.) • Parallel processing capability (It can perform more than one job at the same time) 	<ul style="list-style-type: none"> • Requires a large amount of data (if you only have small sample text data, deep learning is unlikely to outperform other approaches. • Is extremely computationally expensive to train. • Model Interpretability is most important problem of deep learning (Deep learning in most of the time is black-box) • Finding an efficient architecture and structure is still the main challenge of this technique

Table 4. Comparison of the text classification techniques

Model	Author(s)	Architecture	Novelty	Feature Extraction	Details	Corpus	Validation Measure	Limitation
Rocchio Algorithm	Sowmya B J et al. [105]	Hierarchical Rocchio	Classification on hierarchical data	TFIDF	Use CUDA on GPU to compute and compare the distances.	Wikipedia	F1-Macro	Work only on hierarchical datasets, and retrieve a few relevant documents
Boosting	S. Bloehdorn et al. [113]		AdaBoost for with Semantic Features	BOW	Ensemble learning algorithm	Reuters-21578	F1-Macro and F1-Micro	computational complexity and loss of interpretability
Logistic Regression	A. Genkin et al. [119]	Bayesian Logistic Regression	Logistic regression analysis of high-dimensional data	TFIDF	It is based on Gaussian Priors and Ridge Logistic Regression	RCV1-v2	F1-Macro	Prediction outcomes is based on a set of independent variables
Naïve Bayes	Kim, S.B et al. [130]	weight enhancing method	Multivariate Poisson Model for Text Classification	Weights words	per-document term frequency normalization to estimate the Poisson parameter	Reuters-21578	F1-Macro	This method makes a strong assumption about the shape of the data distribution
SVM and kNN	K. Chen et al. [147]	Inverse gravity moment	Introduced TFIGM (term frequency & inverse gravity moment)	TFIDF and TFIGM	incorporates a statistical model to precisely measure the class distinguishing power of a term	20 Newsgroups and Reuters-21578	F1-Macro	Fails to capture polysemy and also still semantic and sentatics is not solved
Support Vector Machines	H. Lodhi et al. [150]	String Subsequence Kernel	Use of a special kernel	Similarity using TFIDF	The kernel is an inner product in the feature space generated by all subsequences of length k	Reuters-21578	F1-Macro	e lack of transparency in results
Conditional Random Field (CRF)	T. Chen et al. [174]	BiLSTM-CRF	Apply a neural network based sequence model to classify opinionated sentences into three types according to the number of targets appeared in a sentence	Word embedding	improve sentence-level sentiment analysis via sentence type classification	Customer Reviews	Accuracy	high computational complexity and this algorithm does not perform with unseen words

Table 5. Comparison of the text classification techniques (continue)

Model	Author(s)	Architecture	Novelty	Feature Extraction	Details	Corpus	Validation Measure	Limitation
Deep Learning	Z. Yang et al. [192]	Hierarchical Attention Networks	it has a hierarchical structure	Word embedding	two levels of attention mechanisms applied at the word and sentence-level	Yelp, IMDB review and Amazon review	Accuracy	Works only for document-level
Deep Learning	J. Chen et al. [227]	Deep Neural Networks	Convolutional neural networks (CNN) using 2-dimensional TF-IDF features	2D TFIDF	A new solution to the verbal aggression detection task.	Twitter comments	F1-Macro and F1-Micro	Data dependent for designed a model architecture
Deep Learning	M. Jiang et al. [1]	Deep Belief Network	Hybrid text classification model based on deep belief network and softmax regression.	DBN	DBN completes the feature learning to solve the high dimension and sparse matrix problem and softmax regression is employed to classify the texts	Reuters-21578 and 20-NewsGroup	Error-rate	Computationally is expensive and model interpretability is still a problem of this model
Deep Learning	X. Zhang et al. [228]	CNN	Character-level convolutional networks (ConvNets) for text classification	Encoded Characters	Character-level ConvNet contains 6 convolutional layers and 3 fully-connected layers	Yelp, Amazon review and Yahoo! Answers dataset	Relative errors	This model is only designed to discover position-invariant features of their inputs
Deep Learning	K. Kowsari [4]	Ensemble deep learning algorithm (CNN, DNN and RNN)	Solves the problem of finding the best deep learning structure and architecture	TFIDF and GloVe	Random Multimodel Deep Learning (RDMML)	IMDB review, Reuters-21578, 20NewsGroup, and WOS	Accuracy	Computationally is expensive
Deep Learning	K. Kowsari [2]	Hierarchical structure	employs stacks of deep learning architectures to provide specialized understanding at each level of the document hierarchy	TFIDF and GloVe	Hierarchical Deep Learning for Text Classification (HDLTex)	Web of Science Dataset	Accuracy	Works only for Hierarchical datasets

6.4. Evaluation

The experimental evaluation of text classifiers measures effectiveness (*i.e.* capacity to make the right classification or categorization decision). Precision and recall are widely used to measure the effectiveness of text classifiers. Accuracy and error ($\frac{FP+FN}{TP+TN+FP+FN} = 1 - \text{accuracy}$), on the other hand, are not widely used for text classification applications because they are insensitive to variations in the number of correct decisions due to the large value of the denominator ($TP + TN$) [214].

Table 6. Metrics Pitfalls

	Limitation
Accuracy	gives us no information on FN and FP
Sensitivity	does not evaluate TN and FP and any classifier that predicts data points as positives considered to have high sensitivity
Specificity	similar to sensitivity and does not account for FN and TP
Precision	does not evaluate TN and FN and considered to be very conservative and goes for a case which is most certain to be positive

7. Text Classification Usage

In the earliest history of ML and AI, text classification techniques have mostly been used for information retrieval systems; however, as technological advances have emerged over time, text classification and document categorization have been globally used in many domains such as medicine, social sciences, health-care, psychology, law, engineering, and etc. In this section, we highlight several domains which make use of text classification techniques.

7.1. Text Classification Applications

7.1.1. Information Retrieval

Information retrieval is finding documents of an unstructured data that meet an information need from within large collections of documents [229]. With the rapid growth of online information, particularly in text format, text classification has become a significant technique for managing this type of data [230]. Some of the important methods used in this area are Naïve Bayes, SVM, decision tree, J48, k-NN and IBK [231]. One of the most challenging applications for document and text dataset processing is applying document categorization methods for information retrieval [34,232].

7.1.2. Information Filtering

Information filtering refers to selection of relevant information or rejection of irrelevant information from a stream of incoming data. Information filtering systems are typically used to measure and forecast users' long-term interests [233]. Probabilistic models, such as Bayesian inference network, are commonly used in information filtering systems. Bayesian inference networks employ recursive inference to propagate values through the inference network and return documents with the highest ranking [34]. [234] used vector space model with iterative refinement for filtering task.

7.1.3. Sentiment Analysis

Sentiment analysis is a computational approach toward identifying opinion, sentiment, and subjectivity in text [235]. Sentiment classification methods classify a document associated with an opinion to be positive or negative. The assumption is that document d is expressing an opinion on a single entity e and opinions are formed via a single opinion holder h [236]. Naive Bayesian classification and SVM are some of the most popular supervised learning methods that have been used for sentiment classification [237]. Features such as terms and their respective frequency, part of

speech, opinion words and phrases, negations and syntactic dependency have been used in sentiment classification techniques.

7.1.4. Recommender Systems

Content-based recommender systems suggest items to users based on the description of an item and a profile of the user's interests [238]. A user's profile can be learned from user feedback (history of the search queries or self reports) on items as well as self-explained features (filter or conditions on the queries) in one's profile. In this way, input to such recommender systems can be semi-structured such that some attributes are extracted from free-text field while others are directly specified [239]. Many different types of text classification methods, such as decision trees, nearest neighbor methods, Rocchio's algorithm, linear classifiers, probabilistic methods, and Naive Bayes, have been used to model user's preference.

7.1.5. Knowledge Management

Textual databases are significant sources of information and knowledge. A large percentage of corporate information (nearly 80%) exists in textual data formats (unstructured). In knowledge distillation, patterns or knowledge are inferred from immediate forms that can be semi-structured (*e.g.* conceptual graph representation) or structured/relational data representation). A given intermediate form can be document-based such that each entity represents an object or concept of interest in a particular domain. Document categorization is one of the most common methods for mining document-based intermediate forms [240]. In the other work, text classification has been used to find the relationship between railroad accidents' causes and their correspondent descriptions in reports [241].

7.1.6. Document Summarization

Text classification used for document summarizing which summary of a document may employ words or phrases which do not appear in the original document [242]. Multi-document summarization also is necessitated due to increasing online information rapidly [243]. So, many researchers focus on this task using text classification to extract important feature out of a document.

7.2. Text Classification Support

7.2.1. Health

Most textual information in the medical domain is presented in an unstructured or narrative form with ambiguous terms and typographical errors. Such information needs to be available instantly throughout the patient-physicians encounters in different stages of diagnosis and treatment [244]. Medical coding, which consists of assigning medical diagnoses to specific class values obtained from a large set of categories, is an area of healthcare applications where text classification techniques can be highly valuable. In the other research, *J. Zhang et al.* introduced Patient2Vec, to learn an interpretable deep representation of longitudinal electronic health record (EHR) data which is personalized for each patient [245]. Patient2Vec is a novel technique of text dataset feature embedding that can learn a personalized interpretable deep representation of EHR data based on recurrent neural networks and the attention mechanism. Text classification has also been applied in the development of Medical Subject Headings (MeSH) and Gene Ontology (GO) [246].

7.2.2. Social Sciences

Text classification and document categorization has increasingly been applied to understanding human behavior in past decades [38,247]. Recent data-driven efforts in human behavior research have focused on mining language contained in informal notes and text datasets, including short message

service (SMS), clinical notes, social media, etc. [38]. These studies have mostly focused on using approaches based on frequencies of word occurrence (*i.e.*, how often a word appears in a document) or features based on Linguistic Inquiry Word Count (LIWC) [248], a well-validated lexicon of categories of words with psychological relevance [249].

7.2.3. Business and Marketing

profitable companies and organizations are progressively using social media for marketing purposes [250]. Opening mining from social media such as Facebook, Twitter, and so on is main target of companies to rapidly increase their profits [251]. Text and documents classification is a powerful tool for companies to find their customers easier than ever.

7.2.4. Law

Huge volumes of legal text information and documents have been generated by governmental institutions. Retrieving this information and automatically classifying it can not only help lawyers but also their clients [252]. In the United States, the law is derived from five sources: constitutional law, statutory law, treaties, administrative regulations, and the common law [253]. Also, many new legal documents are created each year. Categorization of these documents is the main challenge of the lawyer community.

8. Conclusion

The classification task is one of the most indispensable problems in the machine learning. As text and document datasets proliferate, the development and documentation of supervised machine learning algorithms becomes an imperative issue, especially for text classification. Having a better document categorization system for this information requires discerning these algorithms. However, the existing text classification algorithms work more efficiently if we have a better understanding of feature extraction methods and how to evaluate them correctly. currently, text classification algorithms can be chiefly classified in the following manner: I) Feature extraction methods, such as Term Frequency-Inverse Document Frequency (tf-idf), term frequency (TF), word-embedding (*e.g.* Word2Vec, Contextualized Word Representations, Global Vectors for Word Representation (GloVe), and FastText), are widely used in both academic and commercial applications. In this paper, we had addressed these techniques. However, text and document cleaning could help the accuracy and robustness of an application. Also, we described the basic methods of text pre-processing step. II) Dimensionality reduction methods, such as Principle Component Analysis (PCA), Linear Discriminant Analysis (LDA), Non-negative Matrix Factorization (NMF), Random Projection, Autoencoder, and T-distributed Stochastic Neighbor Embedding (T-SNE), can be useful for reducing the time complexity and memory complexity of existing text classification algorithms. In a separate section, the most common methods of dimensionality reduction were presented. III) Existing classification algorithms, such as Rocchio algorithm, Bagging and Boosting, Logistic Regression (LR), Naïve Bayes Classifier (NBC), K-Nearest Neighbor (k-NN), Support Vector Machine (SVM), Decision Tree Classifier (DTC), Random Forest, Conditional Random Field (CRF), and Deep Learning, are the primary focus of this paper. IV) Evaluation methods, such as Accuracy, F_β , Matthew correlation coefficient (MCC), Receiver Operating Characteristics (ROC), and Area Under Curve (AUC), are explained. With these metrics, the text classification algorithm can be evaluated. V) Critical limitations of each component of the text classification pipeline (*i.e.* feature extraction, dimensionality reduction, existing classification algorithms, and evaluation) were addressed in order to each technique. And finally we compare the most common text classification algorithm in this section. V) Finally, the usage of text classification as an application and or support other majors such as lay, medicine, etc. are covered in a separate section.

In this survey, Recent techniques and trending of text classification algorithm have discussed.

Acknowledgements

Feedback and comments: the authors would like to thank professor Matthew S. Gerber for his feedback and comments.

Funding: This work was supported by The United States Army Research Laboratory under Grant W911NF-17-2-0110.

Conflicts of Interest: The authors declare no conflict of interest. The founding sponsors had no role in the design of the study; in the collection, analyses or interpretation of data; in the writing of the manuscript; nor in the decision to publish the results.

References

- Jiang, M.; Liang, Y.; Feng, X.; Fan, X.; Pei, Z.; Xue, Y.; Guan, R. Text classification based on deep belief network and softmax regression. *Neural Computing and Applications* **2018**, *29*, 61–70.
- Kowsari, K.; Brown, D.E.; Heidarysafa, M.; Jafari Meimandi, K.; ; Gerber, M.S.; Barnes, L.E. HDLTex: Hierarchical Deep Learning for Text Classification. Machine Learning and Applications (ICMLA), 2017 16th IEEE International Conference on. IEEE, 2017.
- McCallum, A.; Nigam, K.; others. A comparison of event models for naive bayes text classification. AAAI-98 workshop on learning for text categorization. Citeseer, 1998, Vol. 752, pp. 41–48.
- Kowsari, K.; Heidarysafa, M.; Brown, D.E.; Jafari Meimandi, K.; Barnes, L.E. RMDL: Random Multimodel Deep Learning for Classification. Proceedings of the 2018 International Conference on Information System and Data Mining. ACM, 2018. doi:https://doi.org/10.1145/3206098.3206111.
- Heidarysafa, M.; Kowsari, K.; Brown, D.E.; Jafari Meimandi, K.; Barnes, L.E. An Improvement of Data Classification Using Random Multimodel Deep Learning (RMDL) **2018**. *8*, 298–310. doi:https://doi.org/10.18178/ijmlc.2018.8.4.703.
- Lai, S.; Xu, L.; Liu, K.; Zhao, J. Recurrent Convolutional Neural Networks for Text Classification. AAAI, 2015, Vol. 333, pp. 2267–2273.
- Aggarwal, C.C.; Zhai, C. A survey of text classification algorithms. In *Mining text data*; Springer, 2012; pp. 163–222.
- Aggarwal, C.C.; Zhai, C.X. *Mining Text Data*; Springer Publishing Company, Incorporated, 2012.
- Salton, G.; Buckley, C. Term-weighting approaches in automatic text retrieval. *Information processing & management* **1988**, *24*, 513–523.
- Goldberg, Y.; Levy, O. word2vec explained: Deriving mikolov et al.'s negative-sampling word-embedding method. *arXiv preprint arXiv:1402.3722* **2014**.
- Pennington, J.; Socher, R.; Manning, C.D. Glove: Global Vectors for Word Representation. EMNLP, 2014, Vol. 14, pp. 1532–1543.
- Mamitsuka, N.A.H.; others. Query learning strategies using boosting and bagging. Machine learning: proceedings of the fifteenth international conference (ICML'98). Morgan Kaufmann Pub, 1998, Vol. 1.
- Kim, Y.H.; Hahn, S.Y.; Zhang, B.T. Text filtering by boosting naive Bayes classifiers. Proceedings of the 23rd annual international ACM SIGIR conference on Research and development in information retrieval. ACM, 2000, pp. 168–175.
- Schapire, R.E.; Singer, Y. BoosTexter: A boosting-based system for text categorization. *Machine learning* **2000**, *39*, 135–168.
- Harrell, F.E. Ordinal logistic regression. In *Regression modeling strategies*; Springer, 2001; pp. 331–343.
- Hosmer Jr, D.W.; Lemeshow, S.; Sturdivant, R.X. *Applied logistic regression*; Vol. 398, John Wiley & Sons, 2013.
- Dou, J.; Yamagishi, H.; Zhu, Z.; Yunus, A.P.; Chen, C.W. TXT-tool 1.081-6.1 A Comparative Study of the Binary Logistic Regression (BLR) and Artificial Neural Network (ANN) Models for GIS-Based Spatial Predicting Landslides at a Regional Scale. In *Landslide Dynamics: ISDR-ICL Landslide Interactive Teaching Tools*; Springer, 2018; pp. 139–151.
- Chen, W.; Xie, X.; Wang, J.; Pradhan, B.; Hong, H.; Bui, D.T.; Duan, Z.; Ma, J. A comparative study of logistic model tree, random forest, and classification and regression tree models for spatial prediction of landslide susceptibility. *Catena* **2017**, *151*, 147–160.

19. Larson, R.R. Introduction to information retrieval. *Journal of the American Society for Information Science and Technology* **2010**, *61*, 852–853.
20. Li, L.; Weinberg, C.R.; Darden, T.A.; Pedersen, L.G. Gene selection for sample classification based on gene expression data: study of sensitivity to choice of parameters of the GA/KNN method. *Bioinformatics* **2001**, *17*, 1131–1142.
21. Manevitz, L.M.; Yousef, M. One-class SVMs for document classification. *Journal of machine Learning research* **2001**, *2*, 139–154.
22. Han, E.H.S.; Karypis, G. Centroid-based document classification: Analysis and experimental results. European conference on principles of data mining and knowledge discovery. Springer, 2000, pp. 424–431.
23. Xu, B.; Guo, X.; Ye, Y.; Cheng, J. An Improved Random Forest Classifier for Text Categorization. *JCP* **2012**, *7*, 2913–2920.
24. Lafferty, J.; McCallum, A.; Pereira, F.C. Conditional random fields: Probabilistic models for segmenting and labeling sequence data **2001**.
25. Shen, D.; Sun, J.T.; Li, H.; Yang, Q.; Chen, Z. Document Summarization Using Conditional Random Fields. *IJCAI*, 2007, Vol. 7, pp. 2862–2867.
26. Zhang, C. Automatic keyword extraction from documents using conditional random fields. *Journal of Computational Information Systems* **2008**, *4*, 1169–1180.
27. LeCun, Y.; Bengio, Y.; Hinton, G. Deep learning. *Nature* **2015**, *521*, 436–444.
28. Huang, J.; Ling, C.X. Using AUC and accuracy in evaluating learning algorithms. *IEEE Transactions on knowledge and Data Engineering* **2005**, *17*, 299–310.
29. Lock, G. Acute mesenteric ischemia: classification, evaluation and therapy. *Acta gastro-enterologica Belgica* **2002**, *65*, 220–225.
30. Matthews, B.W. Comparison of the predicted and observed secondary structure of T4 phage lysozyme. *Biochimica et Biophysica Acta (BBA)-Protein Structure* **1975**, *405*, 442–451.
31. Hanley, J.A.; McNeil, B.J. The meaning and use of the area under a receiver operating characteristic (ROC) curve. *Radiology* **1982**, *143*, 29–36.
32. Pencina, M.J.; D’Agostino, R.B.; Vasan, R.S. Evaluating the added predictive ability of a new marker: from area under the ROC curve to reclassification and beyond. *Statistics in medicine* **2008**, *27*, 157–172.
33. Jacobs, P.S. *Text-based intelligent systems: Current research and practice in information extraction and retrieval*; Psychology Press, 2014.
34. Croft, W.B.; Metzler, D.; Strohman, T. *Search engines: Information retrieval in practice*; Vol. 283, Addison-Wesley Reading, 2010.
35. Yammahi, M.; Kowsari, K.; Shen, C.; Berkovich, S. An efficient technique for searching very large files with fuzzy criteria using the pigeonhole principle. 2014 Fifth International Conference on Computing for Geospatial Research and Application. IEEE, 2014, pp. 82–86.
36. Chu, Z.; Gianvecchio, S.; Wang, H.; Jajodia, S. Who is tweeting on Twitter: human, bot, or cyborg? Proceedings of the 26th annual computer security applications conference. ACM, 2010, pp. 21–30.
37. Gordon Jr, R.S. An operational classification of disease prevention. *Public health reports* **1983**, *98*, 107.
38. Nobles, A.L.; Glenn, J.J.; Kowsari, K.; Teachman, B.A.; Barnes, L.E. Identification of Imminent Suicide Risk Among Young Adults using Text Messages. Proceedings of the 2018 CHI Conference on Human Factors in Computing Systems. ACM, 2018, p. 413.
39. Gupta, G.; Malhotra, S. Text Document Tokenization for Word Frequency Count using Rapid Miner (Taking Resume as an Example). *International Journal of Computer Applications (0975–8887)*, International Conference on Advancement in Engineering and Technology. Citeseer, 2015.
40. Verma, T.; Renu, R.; Gaur, D. Tokenization and filtering process in RapidMiner. *International Journal of Applied Information Systems* **2014**, *7*, 16–18.
41. Aggarwal, C.C. *Machine learning for text*; Springer, 2018.
42. Saif, H.; Fernández, M.; He, Y.; Alani, H. On stopwords, filtering and data sparsity for sentiment analysis of twitter **2014**.
43. Gupta, V.; Lehal, G.S.; others. A survey of text mining techniques and applications. *Journal of emerging technologies in web intelligence* **2009**, *1*, 60–76.
44. Dalal, M.K.; Zaveri, M.A. Automatic text classification: a technical review. *International Journal of Computer Applications* **2011**, *28*, 37–40.

45. Whitney, D.L.; Evans, B.W. Abbreviations for names of rock-forming minerals. *American mineralogist* **2010**, *95*, 185–187.
46. Helm, A. Recovery and reclamation: a pilgrimage in understanding who and what we are. *Psychiatric and mental health nursing: The craft of caring* **2003**, pp. 50–55.
47. Dhuliawala, S.; Kanojia, D.; Bhattacharyya, P. SlangNet: A WordNet like resource for English Slang. LREC, 2016.
48. Pahwa, B.; Taruna, S.; Kasliwal, N. Sentiment Analysis-Strategy for Text Pre-Processing.
49. Mawardi, V.C.; Susanto, N.; Naga, D.S. Spelling Correction for Text Documents in Bahasa Indonesia Using Finite State Automata and Levinshstein Distance Method. MATEC Web of Conferences. EDP Sciences, 2018, Vol. 164.
50. Dziadek, J.; Henriksson, A.; Duneld, M. Improving Terminology Mapping in Clinical Text with Context-Sensitive Spelling Correction. In *Informatics for Health: Connected Citizen-Led Wellness and Population Health*; IOS Press, 2017; Vol. 235, pp. 241–245.
51. Mawardi, V.C.; Rudy, R.; Naga, D.S. Fast and Accurate Spelling Correction Using Trie and Bigram. *TELKOMNIKA (Telecommunication Computing Electronics and Control)* **2018**, *16*, 827–833.
52. Spirovski, K.; Stevanoska, E.; Kulakov, A.; Popeska, Z.; Velinov, G. Comparison of different model's performances in task of document classification. Proceedings of the 8th International Conference on Web Intelligence, Mining and Semantics. ACM, 2018, p. 10.
53. Singh, J.; Gupta, V. Text stemming: Approaches, applications, and challenges. *ACM Computing Surveys (CSUR)* **2016**, *49*, 45.
54. Sampson, G. *The 'Language Instinct' Debate: Revised Edition*; A&C Black, 2005.
55. Plisson, J.; Lavrac, N.; Mladenić, D.; others. A rule based approach to word lemmatization **2004**.
56. Korenius, T.; Laurikkala, J.; Järvelin, K.; Juhola, M. Stemming and lemmatization in the clustering of finnish text documents. Proceedings of the thirteenth ACM international conference on Information and knowledge management. ACM, 2004, pp. 625–633.
57. Caropreso, M.F.; Matwin, S. Beyond the bag of words: a text representation for sentence selection. Conference of the Canadian Society for Computational Studies of Intelligence. Springer, 2006, pp. 324–335.
58. Sidorov, G.; Velasquez, F.; Stamatatos, E.; Gelbukh, A.; Chanona-Hernández, L. Syntactic dependency-based n-grams as classification features. Mexican International Conference on Artificial Intelligence. Springer, 2012, pp. 1–11.
59. Sparck Jones, K. A statistical interpretation of term specificity and its application in retrieval. *Journal of documentation* **1972**, *28*, 11–21.
60. Tokunaga, T.; Makoto, I. Text categorization based on weighted inverse document frequency. Special Interest Groups and Information Process Society of Japan (SIG-IPSJ). Citeseer, 1994.
61. Mikolov, T.; Chen, K.; Corrado, G.; Dean, J. Efficient estimation of word representations in vector space. *arXiv preprint arXiv:1301.3781* **2013**.
62. Mikolov, T.; Sutskever, I.; Chen, K.; Corrado, G.S.; Dean, J. Distributed representations of words and phrases and their compositionality. *Advances in neural information processing systems*, 2013, pp. 3111–3119.
63. Rong, X. word2vec parameter learning explained. *arXiv preprint arXiv:1411.2738* **2014**.
64. Maaten, L.v.d.; Hinton, G. Visualizing data using t-SNE. *Journal of machine learning research* **2008**, *9*, 2579–2605.
65. Bojanowski, P.; Grave, E.; Joulin, A.; Mikolov, T. Enriching word vectors with subword information. *arXiv preprint arXiv:1607.04606* **2016**.
66. Melamud, O.; Goldberger, J.; Dagan, I. context2vec: Learning generic context embedding with bidirectional lstm. Proceedings of The 20th SIGNLL Conference on Computational Natural Language Learning, 2016, pp. 51–61.
67. Peters, M.E.; Neumann, M.; Iyyer, M.; Gardner, M.; Clark, C.; Lee, K.; Zettlemoyer, L. Deep contextualized word representations. *arXiv preprint arXiv:1802.05365* **2018**.
68. Abdi, H.; Williams, L.J. Principal component analysis. *Wiley interdisciplinary reviews: computational statistics* **2010**, *2*, 433–459.
69. Jolliffe, I.T.; Cadima, J. Principal component analysis: a review and recent developments. *Phil. Trans. R. Soc. A* **2016**, *374*, 20150202.

70. Ng, A. Principal components analysis. *Generative Algorithms, Regularization and Model Selection.* CS **2015**, 229.
71. Cao, L.; Chua, K.S.; Chong, W.; Lee, H.; Gu, Q. A comparison of PCA, KPCA and ICA for dimensionality reduction in support vector machine. *Neurocomputing* **2003**, *55*, 321–336.
72. Héroult, J. Réseaux de neurones à synapses modifiables: décodage de messages sensoriels composites par une apprentissage non supervisé et permanent. *CR Acad. Sci. Paris* **1984**, pp. 525–528.
73. Jutten, C.; Héroult, J. Blind separation of sources, part I: An adaptive algorithm based on neuromimetic architecture. *Signal processing* **1991**, *24*, 1–10.
74. Hyvärinen, A.; Hoyer, P.O.; Inki, M. Topographic independent component analysis. *Neural computation* **2001**, *13*, 1527–1558.
75. Hyvärinen, A.; Oja, E. Independent component analysis: algorithms and applications. *Neural networks* **2000**, *13*, 411–430.
76. Sugiyama, M. Dimensionality reduction of multimodal labeled data by local fisher discriminant analysis. *Journal of machine learning research* **2007**, *8*, 1027–1061.
77. Balakrishnama, S.; Ganapathiraju, A. Linear discriminant analysis—a brief tutorial. *Institute for Signal and information Processing* **1998**, *18*, 1–8.
78. Sugiyama, M. Local fisher discriminant analysis for supervised dimensionality reduction. Proceedings of the 23rd international conference on Machine learning. ACM, 2006, pp. 905–912.
79. Pauca, V.P.; Shahnaz, F.; Berry, M.W.; Plemmons, R.J. Text mining using non-negative matrix factorizations. Proceedings of the 2004 SIAM International Conference on Data Mining. SIAM, 2004, pp. 452–456.
80. Tsuge, S.; Shishibori, M.; Kuroiwa, S.; Kita, K. Dimensionality reduction using non-negative matrix factorization for information retrieval. Systems, Man, and Cybernetics, 2001 IEEE International Conference on. IEEE, 2001, Vol. 2, pp. 960–965.
81. Kullback, S.; Leibler, R.A. On information and sufficiency. *The annals of mathematical statistics* **1951**, *22*, 79–86.
82. Johnson, D.; Sinanovic, S. Symmetrizing the kullback-leibler distance. *IEEE Transactions on Information Theory* **2001**.
83. Bingham, E.; Mannila, H. Random projection in dimensionality reduction: applications to image and text data. Proceedings of the seventh ACM SIGKDD international conference on Knowledge discovery and data mining. ACM, 2001, pp. 245–250.
84. Chakrabarti, S.; Roy, S.; Soundalgekar, M.V. Fast and accurate text classification via multiple linear discriminant projections. *The VLDB journal* **2003**, *12*, 170–185.
85. Rahimi, A.; Recht, B. Weighted sums of random kitchen sinks: Replacing minimization with randomization in learning. *Advances in neural information processing systems*, 2009, pp. 1313–1320.
86. Morokoff, W.J.; Cafilisch, R.E. Quasi-monte carlo integration. *Journal of computational physics* **1995**, *122*, 218–230.
87. Johnson, W.B.; Lindenstrauss, J.; Schechtman, G. Extensions of lipschitz maps into Banach spaces. *Israel Journal of Mathematics* **1986**, *54*, 129–138. doi:10.1007/BF02764938.
88. Dasgupta, S.; Gupta, A. An elementary proof of a theorem of Johnson and Lindenstrauss. *Random Structures & Algorithms* **2003**, *22*, 60–65.
89. Mao, X.; Yuan, C. *Stochastic differential equations with Markovian switching*; World Scientific, 2016.
90. Goodfellow, I.; Bengio, Y.; Courville, A.; Bengio, Y. *Deep learning*; Vol. 1, MIT press Cambridge, 2016.
91. Wang, W.; Huang, Y.; Wang, Y.; Wang, L. Generalized autoencoder: A neural network framework for dimensionality reduction. Proceedings of the IEEE conference on computer vision and pattern recognition workshops, 2014, pp. 490–497.
92. Rumelhart, D.E.; Hinton, G.E.; Williams, R.J. Learning internal representations by error propagation. Technical report, California Univ San Diego La Jolla Inst for Cognitive Science, 1985.
93. Liang, H.; Sun, X.; Sun, Y.; Gao, Y. Text feature extraction based on deep learning: a review. *EURASIP journal on wireless communications and networking* **2017**, *2017*, 211.
94. Baldi, P. Autoencoders, unsupervised learning, and deep architectures. Proceedings of ICML Workshop on Unsupervised and Transfer Learning, 2012, pp. 37–49.

95. AP, S.C.; Lauly, S.; Larochelle, H.; Khapra, M.; Ravindran, B.; Raykar, V.C.; Saha, A. An autoencoder approach to learning bilingual word representations. *Advances in Neural Information Processing Systems*, 2014, pp. 1853–1861.
96. Masci, J.; Meier, U.; Cireşan, D.; Schmidhuber, J. Stacked convolutional auto-encoders for hierarchical feature extraction. *International Conference on Artificial Neural Networks*. Springer, 2011, pp. 52–59.
97. Chen, K.; Seuret, M.; Liwicki, M.; Hennebert, J.; Ingold, R. Page segmentation of historical document images with convolutional autoencoders. *Document Analysis and Recognition (ICDAR), 2015 13th International Conference on*. IEEE, 2015, pp. 1011–1015.
98. Geng, J.; Fan, J.; Wang, H.; Ma, X.; Li, B.; Chen, F. High-resolution SAR image classification via deep convolutional autoencoders. *IEEE Geoscience and Remote Sensing Letters* **2015**, *12*, 2351–2355.
99. Sutskever, I.; Vinyals, O.; Le, Q.V. Sequence to sequence learning with neural networks. *Advances in neural information processing systems*, 2014, pp. 3104–3112.
100. Cho, K.; Van Merriënboer, B.; Gulcehre, C.; Bahdanau, D.; Bougares, F.; Schwenk, H.; Bengio, Y. Learning phrase representations using RNN encoder-decoder for statistical machine translation. *arXiv preprint arXiv:1406.1078* **2014**.
101. Hinton, G.E.; Roweis, S.T. Stochastic neighbor embedding. *Advances in neural information processing systems*, 2003, pp. 857–864.
102. Joyce, J.M. Kullback-leibler divergence. In *International encyclopedia of statistical science*; Springer, 2011; pp. 720–722.
103. Rocchio, J.J. Relevance feedback in information retrieval. *The SMART retrieval system: experiments in automatic document processing* **1971**, pp. 313–323.
104. Partalas, I.; Kosmopoulos, A.; Baskiotis, N.; Artieres, T.; Paliouras, G.; Gaussier, E.; Androutsopoulos, I.; Amini, M.R.; Galinari, P. LSHTC: A benchmark for large-scale text classification. *arXiv preprint arXiv:1503.08581* **2015**.
105. Sowmya, B.; Srinivasa, K.; others. Large scale multi-label text classification of a hierarchical dataset using Rocchio algorithm. *2016 International Conference on Computation System and Information Technology for Sustainable Solutions (CSITSS)*. IEEE, 2016, pp. 291–296.
106. Korde, V.; Mahender, C.N. Text classification and classifiers: A survey. *International Journal of Artificial Intelligence & Applications* **2012**, *3*, 85.
107. Selvi, S.T.; Karthikeyan, P.; Vincent, A.; Abinaya, V.; Neeraja, G.; Deepika, R. Text categorization using Rocchio algorithm and random forest algorithm. *Advanced Computing (ICoAC), 2016 Eighth International Conference on*. IEEE, 2017, pp. 7–12.
108. Albitar, S.; Espinasse, B.; Fournier, S. Towards a Supervised Rocchio-based Semantic Classification of Web Pages. *KES*, 2012, pp. 460–469.
109. Farzi, R.; Bolandi, V. Estimation of organic facies using ensemble methods in comparison with conventional intelligent approaches: a case study of the South Pars Gas Field, Persian Gulf, Iran. *Modeling Earth Systems and Environment* **2016**, *2*, 105.
110. Bauer, E.; Kohavi, R. An empirical comparison of voting classification algorithms: Bagging, boosting, and variants. *Machine learning* **1999**, *36*, 105–139.
111. Schapire, R.E. The strength of weak learnability. *Machine learning* **1990**, *5*, 197–227.
112. Freund, Y. An improved boosting algorithm and its implications on learning complexity. *Proceedings of the fifth annual workshop on Computational learning theory*. ACM, 1992, pp. 391–398.
113. Bloehdorn, S.; Hotho, A. Boosting for text classification with semantic features. *International workshop on knowledge discovery on the web*. Springer, 2004, pp. 149–166.
114. Freund, Y.; Kearns, M.; Mansour, Y.; Ron, D.; Rubinfeld, R.; Schapire, R.E. Efficient algorithms for learning to play repeated games against computationally bounded adversaries. *Foundations of Computer Science, 1995. Proceedings., 36th Annual Symposium on*. IEEE, 1995, pp. 332–341.
115. Breiman, L. Bagging predictors. *Machine learning* **1996**, *24*, 123–140.
116. Geurts, P. Some enhancements of decision tree bagging. *European Conference on Principles of Data Mining and Knowledge Discovery*. Springer, 2000, pp. 136–147.
117. Cox, D.R. *Analysis of binary data*; Routledge, 2018.
118. Fan, R.E.; Chang, K.W.; Hsieh, C.J.; Wang, X.R.; Lin, C.J. LIBLINEAR: A library for large linear classification. *Journal of machine learning research* **2008**, *9*, 1871–1874.

119. Genkin, A.; Lewis, D.D.; Madigan, D. Large-scale Bayesian logistic regression for text categorization. *Technometrics* **2007**, *49*, 291–304.
120. Juan, A.; Vidal, E. On the use of Bernoulli mixture models for text classification. *Pattern Recognition* **2002**, *35*, 2705–2710.
121. Cheng, W.; Hüllermeier, E. Combining instance-based learning and logistic regression for multilabel classification. *Machine Learning* **2009**, *76*, 211–225.
122. Krishnapuram, B.; Carin, L.; Figueiredo, M.A.; Hartemink, A.J. Sparse multinomial logistic regression: Fast algorithms and generalization bounds. *IEEE transactions on pattern analysis and machine intelligence* **2005**, *27*, 957–968.
123. Huang, K. Unconstrained smartphone sensing and empirical study for sleep monitoring and self-management. PhD thesis, University of Massachusetts Lowell, 2015.
124. Guerin, A. *Using Demographic Variables and In-College Attributes to Predict Course-Level Retention for Community College Spanish Students*; Northcentral University, 2016.
125. Kaufmann, S. CUBA: Artificial conviviality and user-behaviour analysis in web-feeds. PhD thesis, Citeseer, 1969.
126. Porter, M.F. An algorithm for suffix stripping. *Program* **1980**, *14*, 130–137.
127. Pearson, E.S. Bayes' theorem, examined in the light of experimental sampling. *Biometrika* **1925**, *17*, 388–442.
128. Hill, B.M. Posterior distribution of percentiles: Bayes' theorem for sampling from a population. *Journal of the American Statistical Association* **1968**, *63*, 677–691.
129. Qu, Z.; Song, X.; Zheng, S.; Wang, X.; Song, X.; Li, Z. Improved Bayes Method Based on TF-IDF Feature and Grade Factor Feature for Chinese Information Classification. Big Data and Smart Computing (BigComp), 2018 IEEE International Conference on. IEEE, 2018, pp. 677–680.
130. Kim, S.B.; Han, K.S.; Rim, H.C.; Myaeng, S.H. Some effective techniques for naive bayes text classification. *IEEE transactions on knowledge and data engineering* **2006**, *18*, 1457–1466.
131. Frank, E.; Bouckaert, R.R. Naive bayes for text classification with unbalanced classes. European Conference on Principles of Data Mining and Knowledge Discovery. Springer, 2006, pp. 503–510.
132. Liu, Y.; Loh, H.T.; Sun, A. Imbalanced text classification: A term weighting approach. *Expert systems with Applications* **2009**, *36*, 690–701.
133. Soheily-Khah, S.; Marteau, P.F.; Béchet, N. Intrusion detection in network systems through hybrid supervised and unsupervised mining process—a detailed case study on the ISCX benchmark dataset **2017**.
134. Wang, Y.; Khardon, R.; Protopapas, P. Nonparametric bayesian estimation of periodic light curves. *The Astrophysical Journal* **2012**, *756*, 67.
135. Ranjan, M.N.M.; Ghorpade, Y.R.; Kanthale, G.R.; Ghorpade, A.R.; Dubey, A.S. Document Classification using LSTM Neural Network. *Journal of Data Mining and Management* **2017**, *2*.
136. Jiang, S.; Pang, G.; Wu, M.; Kuang, L. An improved K-nearest-neighbor algorithm for text categorization. *Expert Systems with Applications* **2012**, *39*, 1503–1509.
137. Han, E.H.S.; Karypis, G.; Kumar, V. Text categorization using weight adjusted k-nearest neighbor classification. Pacific-asia conference on knowledge discovery and data mining. Springer, 2001, pp. 53–65.
138. Salton, G. Automatic text processing: The transformation, analysis, and retrieval of. *Reading: Addison-Wesley* **1989**.
139. Sahgal, D.; Ramesh, A. ON ROAD VEHICLE DETECTION USING GABOR WAVELET FEATURES WITH VARIOUS CLASSIFICATION TECHNIQUES **2015**.
140. Patel, D.; Srivastava, T. Ant Colony Optimization Model for Discrete Tomography Problems. Proceedings of the Third International Conference on Soft Computing for Problem Solving. Springer, 2014, pp. 785–792.
141. Sahgal, D.; Parida, M. Object Recognition Using Gabor Wavelet Features with Various Classification Techniques. Proceedings of the Third International Conference on Soft Computing for Problem Solving. Springer, 2014, pp. 793–804.
142. Sanjay, G.P.; Nagori, V.; Sanjay, G.P.; Nagori, V. Comparing Existing Methods for Predicting the Detection of Possibilities of Blood Cancer by Analyzing Health Data. *International Journal*, *4*, 10–14.
143. Vapnik, V.; Chervonenkis, A.Y. A class of algorithms for pattern recognition learning. *Avtomat. i Telemekh* **1964**, *25*, 937–945.

144. Boser, B.E.; Guyon, I.M.; Vapnik, V.N. A training algorithm for optimal margin classifiers. Proceedings of the fifth annual workshop on Computational learning theory. ACM, 1992, pp. 144–152.
145. Bo, G.; Xianwu, H. SVM Multi-Class Classification [J]. *Journal of Data Acquisition & Processing* **2006**, *3*, 017.
146. Mohri, M.; Rostamizadeh, A.; Talwalkar, A. *Foundations of machine learning*; MIT press, 2012.
147. Chen, K.; Zhang, Z.; Long, J.; Zhang, H. Turning from TF-IDF to TF-IGM for term weighting in text classification. *Expert Systems with Applications* **2016**, *66*, 245–260.
148. Weston, J.; Watkins, C. Multi-class support vector machines. Technical report, Technical Report CSD-TR-98-04, Department of Computer Science, Royal Holloway, University of London, May, 1998.
149. Zhang, W.; Yoshida, T.; Tang, X. Text classification based on multi-word with support vector machine. *Knowledge-Based Systems* **2008**, *21*, 879–886.
150. Lodhi, H.; Saunders, C.; Shawe-Taylor, J.; Cristianini, N.; Watkins, C. Text classification using string kernels. *Journal of Machine Learning Research* **2002**, *2*, 419–444.
151. Leslie, C.S.; Eskin, E.; Noble, W.S. The spectrum kernel: A string kernel for SVM protein classification. Pacific symposium on biocomputing, 2002, Vol. 7, pp. 566–575.
152. Eskin, E.; Weston, J.; Noble, W.S.; Leslie, C.S. Mismatch string kernels for SVM protein classification. Advances in neural information processing systems, 2002, pp. 1417–1424.
153. Singh, R.; Kowsari, K.; Lanchantin, J.; Wang, B.; Qi, Y. GaKCo: a Fast and Scalable Algorithm for Calculating Gapped k-mer string Kernel using Counting. *bioRxiv* **2017**.
154. Sun, A.; Lim, E.P. Hierarchical text classification and evaluation. Data Mining, 2001. ICDM 2001, Proceedings IEEE International Conference on. IEEE, 2001, pp. 521–528.
155. Sebastiani, F. Machine learning in automated text categorization. *ACM computing surveys (CSUR)* **2002**, *34*, 1–47.
156. Maron, O.; Lozano-Pérez, T. A framework for multiple-instance learning. Advances in neural information processing systems, 1998, pp. 570–576.
157. Andrews, S.; Tsochantaridis, I.; Hofmann, T. Support vector machines for multiple-instance learning. Advances in neural information processing systems, 2003, pp. 577–584.
158. Karamizadeh, S.; Abdullah, S.M.; Halimi, M.; Shayan, J.; javad Rajabi, M. Advantage and drawback of support vector machine functionality. Computer, Communications, and Control Technology (I4CT), 2014 International Conference on. IEEE, 2014, pp. 63–65.
159. Guo, G. Soft biometrics from face images using support vector machines. In *Support Vector Machines Applications*; Springer, 2014; pp. 269–302.
160. Morgan, J.N.; Sonquist, J.A. Problems in the analysis of survey data, and a proposal. *Journal of the American statistical association* **1963**, *58*, 415–434.
161. Safavian, S.R.; Landgrebe, D. A survey of decision tree classifier methodology. *IEEE transactions on systems, man, and cybernetics* **1991**, *21*, 660–674.
162. Magerman, D.M. Statistical decision-tree models for parsing. Proceedings of the 33rd annual meeting on Association for Computational Linguistics. Association for Computational Linguistics, 1995, pp. 276–283.
163. Quinlan, J.R. Induction of decision trees. *Machine learning* **1986**, *1*, 81–106.
164. De Mántaras, R.L. A distance-based attribute selection measure for decision tree induction. *Machine learning* **1991**, *6*, 81–92.
165. Giovanelli, C.; Liu, X.; Sierla, S.; Vyatkin, V.; Ichise, R. Towards an aggregator that exploits big data to bid on frequency containment reserve market. Industrial Electronics Society, IECON 2017-43rd Annual Conference of the IEEE. IEEE, 2017, pp. 7514–7519.
166. Quinlan, J.R. Simplifying decision trees. *International journal of man-machine studies* **1987**, *27*, 221–234.
167. Jasim, D.S. Data Mining Approach and Its Application to Dresses Sales Recommendation **2016**.
168. Ho, T.K. Random decision forests. Proceedings of 3rd International Conference on Document Analysis and Recognition, 1995, Vol. 1, pp. 278–282 vol.1. doi:10.1109/ICDAR.1995.598994.
169. Breiman, L. Random forests. *UC Berkeley TR567* **1999**.
170. Wu, T.F.; Lin, C.J.; Weng, R.C. Probability estimates for multi-class classification by pairwise coupling. *Journal of Machine Learning Research* **2004**, *5*, 975–1005.
171. Bansal, H.; Shrivastava, G.; Nhu, N.; STANCIU, L. *Social Network Analytics for Contemporary Business Organizations*; 2018.

172. Sutton, C.; McCallum, A.; others. An introduction to conditional random fields. *Foundations and Trends® in Machine Learning* **2012**, *4*, 267–373.
173. Vail, D.L.; Veloso, M.M.; Lafferty, J.D. Conditional random fields for activity recognition. Proceedings of the 6th international joint conference on Autonomous agents and multiagent systems. ACM, 2007, p. 235.
174. Chen, T.; Xu, R.; He, Y.; Wang, X. Improving sentiment analysis via sentence type classification using BiLSTM-CRF and CNN. *Expert Systems with Applications* **2017**, *72*, 221–230.
175. Sutton, C.; McCallum, A. *An introduction to conditional random fields for relational learning*; Vol. 2, Introduction to statistical relational learning. MIT Press, 2006.
176. Tseng, H.; Chang, P.; Andrew, G.; Jurafsky, D.; Manning, C. A conditional random field word segmenter for sighthan bakeoff 2005. Proceedings of the fourth SIGHAN workshop on Chinese language Processing, 2005.
177. Nair, V.; Hinton, G.E. Rectified linear units improve restricted boltzmann machines. Proceedings of the 27th international conference on machine learning (ICML-10), 2010, pp. 807–814.
178. Sutskever, I.; Martens, J.; Hinton, G.E. Generating text with recurrent neural networks. Proceedings of the 28th International Conference on Machine Learning (ICML-11), 2011, pp. 1017–1024.
179. Mandic, D.P.; Chambers, J.A.; others. *Recurrent neural networks for prediction: learning algorithms, architectures and stability*; Wiley Online Library, 2001.
180. Bengio, Y.; Simard, P.; Frasconi, P. Learning long-term dependencies with gradient descent is difficult. *IEEE transactions on neural networks* **1994**, *5*, 157–166.
181. Hochreiter, S.; Schmidhuber, J. Long short-term memory. *Neural computation* **1997**, *9*, 1735–1780.
182. Graves, A.; Schmidhuber, J. Framewise phoneme classification with bidirectional LSTM and other neural network architectures. *Neural Networks* **2005**, *18*, 602–610.
183. Pascanu, R.; Mikolov, T.; Bengio, Y. On the difficulty of training recurrent neural networks. *ICML (3)* **2013**, *28*, 1310–1318.
184. Chung, J.; Gulcehre, C.; Cho, K.; Bengio, Y. Empirical evaluation of gated recurrent neural networks on sequence modeling. *arXiv preprint arXiv:1412.3555* **2014**.
185. Jaderberg, M.; Simonyan, K.; Vedaldi, A.; Zisserman, A. Reading text in the wild with convolutional neural networks. *International Journal of Computer Vision* **2016**, *116*, 1–20.
186. LeCun, Y.; Bottou, L.; Bengio, Y.; Haffner, P. Gradient-based learning applied to document recognition. *Proceedings of the IEEE* **1998**, *86*, 2278–2324.
187. Scherer, D.; Müller, A.; Behnke, S. Evaluation of pooling operations in convolutional architectures for object recognition. *Artificial Neural Networks–ICANN 2010* **2010**, pp. 92–101.
188. Johnson, R.; Zhang, T. Effective use of word order for text categorization with convolutional neural networks. *arXiv preprint arXiv:1412.1058* **2014**.
189. Hinton, G.E. Training products of experts by minimizing contrastive divergence. *Neural computation* **2002**, *14*, 1771–1800.
190. Hinton, G.E.; Osindero, S.; Teh, Y.W. A fast learning algorithm for deep belief nets. *Neural computation* **2006**, *18*, 1527–1554.
191. Mohamed, A.r.; Dahl, G.E.; Hinton, G. Acoustic modeling using deep belief networks. *IEEE Transactions on Audio, Speech, and Language Processing* **2012**, *20*, 14–22.
192. Yang, Z.; Yang, D.; Dyer, C.; He, X.; Smola, A.J.; Hovy, E.H. Hierarchical Attention Networks for Document Classification. HLT-NAACL, 2016, pp. 1480–1489.
193. Seo, P.H.; Lin, Z.; Cohen, S.; Shen, X.; Han, B. Hierarchical attention networks. *arXiv preprint arXiv:1606.02393* **2016**.
194. Bottou, L. Large-scale machine learning with stochastic gradient descent. In *Proceedings of COMPSTAT'2010*; Springer, 2010; pp. 177–186.
195. Tieleman, T.; Hinton, G. Lecture 6.5-rmsprop: Divide the gradient by a running average of its recent magnitude. *COURSERA: Neural networks for machine learning* **2012**, *4*, 26–31.
196. Kingma, D.; Ba, J. Adam: A method for stochastic optimization. *arXiv preprint arXiv:1412.6980* **2014**.
197. Duchi, J.; Hazan, E.; Singer, Y. Adaptive subgradient methods for online learning and stochastic optimization. *Journal of Machine Learning Research* **2011**, *12*, 2121–2159.
198. Zeiler, M.D. ADADELTA: an adaptive learning rate method. *arXiv preprint arXiv:1212.5701* **2012**.

199. Wang, B.; Xu, J.; Li, J.; Hu, C.; Pan, J.S. Scene text recognition algorithm based on faster RCNN. *Electronics Instrumentation & Information Systems (EIIS), 2017 First International Conference on*. IEEE, 2017, pp. 1–4.
200. Zhou, C.; Sun, C.; Liu, Z.; Lau, F. A C-LSTM neural network for text classification. *arXiv preprint arXiv:1511.08630* **2015**.
201. Shwartz-Ziv, R.; Tishby, N. Opening the black box of deep neural networks via information. *arXiv preprint arXiv:1703.00810* **2017**.
202. Gray, A.; MacDonell, S. Alternatives to regression models for estimating software projects **1996**.
203. Shrikumar, A.; Greenside, P.; Kundaje, A. Learning important features through propagating activation differences. *arXiv preprint arXiv:1704.02685* **2017**.
204. Anthes, G. Deep learning comes of age. *Communications of the ACM* **2013**, *56*, 13–15.
205. Lampinen, A.K.; McClelland, J.L. One-shot and few-shot learning of word embeddings. *arXiv preprint arXiv:1710.10280* **2017**.
206. Severyn, A.; Moschitti, A. Learning to rank short text pairs with convolutional deep neural networks. *Proceedings of the 38th international ACM SIGIR conference on research and development in information retrieval*. ACM, 2015, pp. 373–382.
207. Gowda, H.S.; Suhil, M.; Guru, D.; Raju, L.N. Semi-supervised text categorization using recursive K-means clustering. *International Conference on Recent Trends in Image Processing and Pattern Recognition*. Springer, 2016, pp. 217–227.
208. Kowsari, K. Investigation of fuzzyfind searching with golay code transformations. PhD thesis, M. Sc. Thesis, The George Washington University, Department of Computer Science, 2014.
209. Kowsari, K.; Yammahi, M.; Bari, N.; Vichr, R.; Alsaby, F.; Berkovich, S.Y. Construction of fuzzyfind dictionary using golay coding transformation for searching applications. *arXiv preprint arXiv:1503.06483* **2015**.
210. Chapelle, O.; Zien, A. Semi-Supervised Classification by Low Density Separation. *AISTATS*. Citeseer, 2005, pp. 57–64.
211. Nigam, K.; McCallum, A.; Mitchell, T. Semi-supervised text classification using EM. *Semi-Supervised Learning* **2006**, pp. 33–56.
212. Shi, L.; Mihalcea, R.; Tian, M. Cross language text classification by model translation and semi-supervised learning. *Proceedings of the 2010 Conference on Empirical Methods in Natural Language Processing*. Association for Computational Linguistics, 2010, pp. 1057–1067.
213. Zhou, S.; Chen, Q.; Wang, X. Fuzzy deep belief networks for semi-supervised sentiment classification. *Neurocomputing* **2014**, *131*, 312–322.
214. Yang, Y. An evaluation of statistical approaches to text categorization. *Information retrieval* **1999**, *1*, 69–90.
215. Lever, J.; Krzywinski, M.; Altman, N. Points of significance: Classification evaluation, 2016.
216. Manning, C.D.; Raghavan, P.; Schütze, H. Matrix decompositions and latent semantic indexing. *Introduction to Information Retrieval* **2008**, pp. 403–417.
217. Tsoumakas, G.; Katakis, I.; Vlahavas, I. Mining multi-label data. In *Data mining and knowledge discovery handbook*; Springer, 2009; pp. 667–685.
218. Yonelinas, A.P.; Parks, C.M. Receiver operating characteristics (ROCs) in recognition memory: a review. *Psychological bulletin* **2007**, *133*, 800.
219. Japkowicz, N.; Stephen, S. The class imbalance problem: A systematic study. *Intelligent data analysis* **2002**, *6*, 429–449.
220. Bradley, A.P. The use of the area under the ROC curve in the evaluation of machine learning algorithms. *Pattern recognition* **1997**, *30*, 1145–1159.
221. Hand, D.J.; Till, R.J. A simple generalisation of the area under the ROC curve for multiple class classification problems. *Machine learning* **2001**, *45*, 171–186.
222. Wu, H.C.; Luk, R.W.P.; Wong, K.F.; Kwok, K.L. Interpreting tf-idf term weights as making relevance decisions. *ACM Transactions on Information Systems (TOIS)* **2008**, *26*, 13.
223. Rezaeinia, S.M.; Ghodsi, A.; Rahmani, R. Improving the Accuracy of Pre-trained Word Embeddings for Sentiment Analysis. *arXiv preprint arXiv:1711.08609* **2017**.
224. Sharma, A.; Paliwal, K.K. Fast principal component analysis using fixed-point algorithm. *Pattern Recognition Letters* **2007**, *28*, 1151–1155.

225. Putthividhya, D.P.; Hu, J. Bootstrapped named entity recognition for product attribute extraction. *Proceedings of the Conference on Empirical Methods in Natural Language Processing*. Association for Computational Linguistics, 2011, pp. 1557–1567.
226. Banerjee, M. *A utility-aware privacy preserving framework for distributed data mining with worst case privacy guarantee*; University of Maryland, Baltimore County, 2011.
227. Chen, J.; Yan, S.; Wong, K.C. Verbal aggression detection on Twitter comments: Convolutional neural network for short-text sentiment analysis. *Neural Computing and Applications*, pp. 1–10.
228. Zhang, X.; Zhao, J.; LeCun, Y. Character-level convolutional networks for text classification. *Advances in neural information processing systems*, 2015, pp. 649–657.
229. Schütze, H.; Manning, C.D.; Raghavan, P. *Introduction to information retrieval*; Vol. 39, Cambridge University Press, 2008.
230. Hoogeveen, D.; Wang, L.; Baldwin, T.; Verspoor, K.M. Web forum retrieval and text analytics: A survey. *Foundations and Trends® in Information Retrieval* **2018**, *12*, 1–163.
231. Dwivedi, S.K.; Arya, C. Automatic Text Classification in Information retrieval: A Survey. *Proceedings of the Second International Conference on Information and Communication Technology for Competitive Strategies*. ACM, 2016, p. 131.
232. Jones, K.S. Automatic keyword classification for information retrieval. *The Library Quarterly* **1971**, *41*, 338–340. doi:10.1086/619985.
233. O’Riordan, C.; Sorensen, H. Information filtering and retrieval: An overview. *Proceedings of the 16th Annual International Conference of the IEEE*, 1997, pp. A42–A49.
234. Buckley, C. Implementation of the SMART information retrieval system. Technical report, Cornell University, 1985.
235. Pang, B.; Lee, L.; others. Opinion mining and sentiment analysis. *Foundations and Trends® in Information Retrieval* **2008**, *2*, 1–135.
236. Liu, B.; Zhang, L. A survey of opinion mining and sentiment analysis. In *Mining text data*; Springer, 2012; pp. 415–463.
237. Pang, B.; Lee, L.; Vaithyanathan, S. Thumbs up?: sentiment classification using machine learning techniques. *Proceedings of the ACL-02 conference on Empirical methods in natural language processing-Volume 10*. Association for Computational Linguistics, 2002, pp. 79–86.
238. Aggarwal, C.C. Content-based recommender systems. In *Recommender systems*; Springer, 2016; pp. 139–166.
239. Pazzani, M.J.; Billsus, D. Content-based recommendation systems. In *The adaptive web*; Springer, 2007; pp. 325–341.
240. Sumathy, K.; Chidambaram, M. Text mining: concepts, applications, tools and issues-an overview. *International Journal of Computer Applications* **2013**, *80*.
241. Heidarysafa, M.; Kowsari, K.; Barnes, L.E.; Brown, D.E. Analysis of Railway Accidents’ Narratives Using Deep Learning **2018**.
242. Mani, I. *Advances in automatic text summarization*; MIT press, 1999.
243. Cao, Z.; Li, W.; Li, S.; Wei, F. Improving Multi-Document Summarization via Text Classification. *AAAI*, 2017, pp. 3053–3059.
244. Lauria, E.J.; March, A.D. Combining Bayesian text classification and shrinkage to automate healthcare coding: A data quality analysis. *Journal of Data and Information Quality (JDIQ)* **2011**, *2*, 13.
245. Zhang, J.; Kowsari, K.; Harrison, J.H.; Lobo, J.M.; Barnes, L.E. Patient2Vec: A Personalized Interpretable Deep Representation of the Longitudinal Electronic Health Record. *IEEE Access* **2018**, *6*, 65333–65346. doi:10.1109/ACCESS.2018.2875677.
246. Trieschnigg, D.; Pezik, P.; Lee, V.; De Jong, F.; Kraaij, W.; Rebholz-Schuhmann, D. MeSH Up: effective MeSH text classification for improved document retrieval. *Bioinformatics* **2009**, *25*, 1412–1418.
247. Ofoghi, B.; Verspoor, K. Textual Emotion Classification: An Interoperability Study on Cross-Genre Data Sets. *Australasian Joint Conference on Artificial Intelligence*. Springer, 2017, pp. 262–273.
248. Pennebaker, J.; Booth, R.; Boyd, R.; Francis, M. Linguistic Inquiry and Word Count: LIWC2015. *Austin, TX: Pennebaker Conglomerates (www.LIWC.net)*.
249. Paul, M.J.; Dredze, M. Social Monitoring for Public Health. *Synthesis Lectures on Information Concepts, Retrieval, and Services* **2017**, *9*, 1–183. doi:10.2200/ S00791ED1V01Y201707ICR060.

250. Yu, B.; Kwok, L. Classifying business marketing messages on Facebook. *Association for Computing Machinery Special Interest Group on Information Retrieval, Beijing, China* **2011**.
251. Kang, M.; Ahn, J.; Lee, K. Opinion mining using ensemble text hidden Markov models for text classification. *Expert Systems with Applications* **2018**, *94*, 218–227.
252. Turtle, H. Text retrieval in the legal world. *Artificial Intelligence and Law* **1995**, *3*, 5–54.
253. Bergman, P.; Berman, S.J. *Represent yourself in court: How to prepare & try a winning case*; Nolo, 2016.



© 2019 by the authors. Licensee MDPI, Basel, Switzerland. This article is an open access article distributed under the terms and conditions of the Creative Commons Attribution (CC BY) license (<http://creativecommons.org/licenses/by/4.0/>).