

We introduce some definitions; see also [6,7,13]. A *rooted tree* T is a tree with one distinguished node, which is called the *root* of T and is denoted by $r(T)$. As usual in the literature about tree drawings, we will always assume trees to be rooted, even when not explicitly mentioned. Trees of maximum degree 3 and 4 are also called *binary* and *ternary* trees, respectively. For every node $s \neq r(T)$ in a tree T , the neighbor of s in the path between s and $r(T)$ is the *parent* of s ; all the other neighbors of s are its *children*. In a binary tree each node has at most 2 children, while in a ternary tree each node has at most 3 children; note that this requires the root to have degree at most 2 or 3, respectively. A *leaf* is a node with no children. For any non-leaf node s of a tree T , removing s and its incident edges from T splits T into several connected components; the ones containing children of s are the *subtrees of s* ; the subtrees of s are rooted at the children of s . A *subtree* in a tree T is either the tree T itself, or a subtree of some non-leaf node s in T . A tree is *complete* if every non-leaf node has the same number of children and every root-to-leaf path has the same length. We denote by T_h the complete ternary tree such that every root-to-leaf path has length h , i.e., it consists of h nodes. We denote by $|T|$ the number of nodes of a tree T .

It has been known since the 70's that n -node complete binary trees admit planar straight-line orthogonal drawings in $O(n)$ area [5,15]. Concerning general binary trees, $O(n \log \log n)$ has long stood as the best known area bound [3,16]; however, a recent breakthrough result of Chan [2] has improved that to $n2^{O(\log^* n)}$, where \log^* denotes the iterated logarithm.

In this paper we prove the first sub-quadratic area bound for planar straight-line orthogonal drawings of ternary trees. In fact, our main result is that every n -node ternary tree admits a planar straight-line orthogonal drawing in $O(n^{1.576})$ area. In Section 2, we present a recursive geometric construction, together with the (non-trivial) analysis of its area requirements, from which our main result follows.

In Section 3, we study the area requirements of planar straight-line orthogonal drawings of n -node complete ternary trees. A recent result of Ali [1] proved that such drawings can be constructed in $O(n^{1.118})$ area. We focus on drawings that satisfy the *subtree separation property*: the smallest axis-parallel rectangles enclosing the drawings of any two node-disjoint subtrees do not overlap. We prove that n -node complete ternary trees have planar straight-line orthogonal drawings with the subtree separation property in $O(n^{1.149})$ area. We also present an algorithm that constructs a minimum-area planar straight-line orthogonal drawing with the subtree separation property of a complete ternary tree in polynomial time. This allowed us to experimentally compute the area required by planar straight-line orthogonal drawings with the subtree separation property for complete ternary trees with up to 2 billion nodes. The outcomes of these experiments led us to conjecture that complete ternary trees do not admit planar straight-line orthogonal drawings with the subtree separation property in near-linear area.

Finally, in Section 4, we prove that any planar straight-line orthogonal drawing of a complete ternary tree with n nodes requires $\Omega(n^{\log_3 \phi}) \in \Omega(n^{0.438})$ height *and* width, where $\phi = (1 + \sqrt{5})/2$ is the golden ratio. This marks a notable difference between binary trees and ternary trees; in fact for the former planar straight-line orthogonal drawings can be constructed in which one side has logarithmic length, while for the latter our result proves that polynomial length might be required for both side lengths. Our lower bound holds true even for drawings that do not satisfy the subtree separation property. For n -node complete ternary trees, we prove that our bound is tight: they admit planar straight-line orthogonal drawings in which one side has length in $O(n^{\log_3 \phi})$.

Section 5 concludes the paper with some open problems. In the remainder of the paper, a *drawing* will always mean a planar straight-line orthogonal drawing in which nodes lie at grid points.

2 General Ternary Trees

In this section we prove the following theorem.

Theorem 1. *Every n -node ternary tree admits a planar straight-line orthogonal drawing with width $O(n)$, with height $O(n^{0.576})$, and with area $O(n^{1.576})$.*

In the following we show an inductive algorithm that takes in input an n -node ternary tree T and constructs a drawing Γ of T that satisfies the *top-visibility property*, i.e., the vertical half-line emanating from the root $r(T)$ and directed upwards does not intersect Γ , except at $r(T)$.

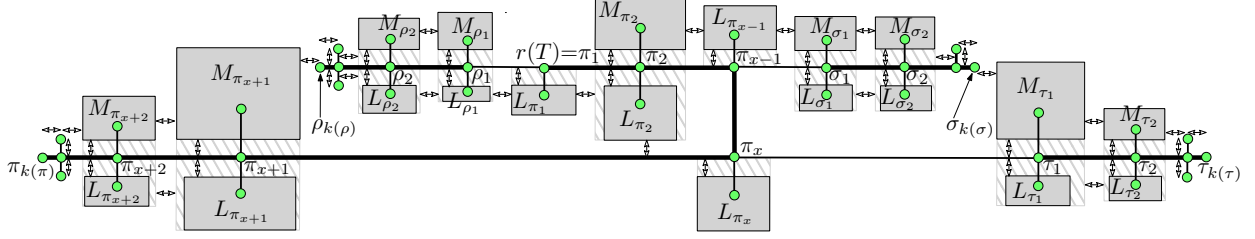

Fig. 2. Construction of Γ if $n > 1$. Fat lines represent π , ρ , σ , and τ . Double-headed arrows indicate unit distances. Gray boxes represent inductively constructed drawings.

For a node v in T , we denote as T_v the subtree of T rooted at v ; further, we denote the subtrees of v as the *heaviest* subtree H_v , the *second heaviest* subtree M_v , and the *lightest* subtree L_v of v , according to the non-increasing order of the number of their nodes, with ties broken arbitrarily. A *heavy path* in T is a path (v_1, \dots, v_k) such that $r(T) = v_1$, such that v_{i+1} is the root of H_{v_i} , for $i = 1, \dots, k-1$, and such that v_k is a leaf. We denote by $(\pi_1, \dots, \pi_k(\pi))$ the nodes of a heavy path π .

The base case of the construction is the one in which $n = 1$. Then Γ is trivially constructed by placing $r(T)$ at any grid point of the plane.

If $n > 1$, then let π be a heavy path in T . Further, let ρ be a heavy path in $M_{r(T)}$. Let $p > 4$ be a parameter to be determined later and let x be the smallest index such that π_x has at least two subtrees with at least n/p nodes each, if any such an index exists. We first describe our construction by assuming that x exists and is greater than 2; we will deal with the other cases later. Let σ be a heavy path in $M_{\pi_{x-1}}$ and let τ be a heavy path in M_{π_x} . Finally, let $P = (\rho_k(\rho), \dots, \rho_1, \pi_1, \dots, \pi_{x-1}, \sigma_1, \dots, \sigma_k(\sigma))$ and $Q = (\pi_k(\pi), \dots, \pi_x, \tau_1, \dots, \tau_k(\tau))$.

Fig. 2 shows the construction of Γ . The paths P and Q are drawn on two horizontal lines ℓ_P and ℓ_Q , respectively, with ℓ_P above ℓ_Q and with the nodes in left-to-right order as they appear in P and Q . Let $\mathcal{V} = V(P) \cup V(Q)$. For every subtree T^* of T rooted at a node $r^* \notin \mathcal{V}$ that is child of a node in \mathcal{V} , a drawing Γ^* of T^* is constructed inductively. Then Γ^* is attached to the parent p^* of r^* as follows (note that $p^* \in \mathcal{V}$). If T^* is the lightest subtree of p^* , then Γ^* is placed with r^* on the same vertical line as p^* and with its top side one unit below p^* (we call T^* a *bottom subtree* of P or Q , depending on whether p^* is in $V(P)$ or $V(Q)$, respectively). Otherwise, T^* is the second heaviest subtree of p^* (note that T^* is not the heaviest subtree of p^* , as $r^* \notin \mathcal{V}$); then Γ^* is rotated by 180° and placed with r^* on the same vertical line as p^* and with its bottom side one unit above p^* (we call T^* a *top subtree* of P or Q , depending on whether p^* is in $V(P)$ or $V(Q)$, respectively). There is one exception to this rule, which happens if T^* is the lightest subtree of $p^* = \pi_{x-1}$; then Γ^* is rotated by 180° and placed with r^* on the same vertical line as p^* and with its bottom side one unit above p^* , as if it were a second heaviest subtree (then T^* is a *top subtree* of P).

The horizontal distance of the nodes in \mathcal{V} is determined so to ensure that, for any two nodes x and y such that x comes immediately before y on P or Q , the rightmost vertical line intersecting x or its attached subtrees is one unit to the left of the leftmost vertical line intersecting y or its attached subtrees. There are two exceptions to this rule, involving the distance between π_x and its children π_{x+1} and τ_1 . Indeed, the distance between π_x and π_{x+1} is determined so that the rightmost vertical line intersecting π_{x+1} or its attached subtrees is one unit to the left of the leftmost vertical line intersecting P , or its attached subtrees, or π_x , or its attached subtree L_{π_x} ; the distance between π_x and τ_1 is determined similarly. The reason for “pushing” π_{x+1} (resp. τ_1) and its attached subtrees to the left (resp. to the right) of P and its attached subtrees is to allow for a vertical compaction of Γ . In fact, the vertical distance between P and Q can now be chosen so that the bottommost horizontal line intersecting P or its attached subtrees is one unit above Q . This completes the construction of Γ .

It is easy to see that Γ is a planar straight-line orthogonal drawing satisfying the top-visibility property. Further, every grid column that intersects Γ contains at least one node of T , hence the width of Γ is in $O(n)$.

We now analyze the height of Γ . Denote by $\eta(n)$ the maximum height of a drawing of a ternary tree with n nodes constructed by the described algorithm. Then the height of Γ is at most $\eta(n)$. Note that $\eta(1) = 1$.

Let a (resp. b) be the maximum number of nodes of a top (resp. bottom) subtree of P . Let r (resp. s) be the maximum number of nodes of a top (resp. bottom) subtree of Q . By the definition of the index x and since $|M_{\pi_i}|, |L_{\pi_i}| < |H_{\pi_i}|$, we have $|M_{\pi_i}|, |L_{\pi_i}| < n/p$, for any $i \in \{1, \dots, x-1\}$. Hence:

$$a, b < n/p. \quad (1)$$

Since the lightest subtree of the root of a tree with m nodes has less than $m/3$ nodes, we have

$$s \leq (n - a - b)/3. \quad (2)$$

We also have the following inequality, whose proof needs some case analysis.

$$r + s \leq \frac{2(p-1)}{3p}n. \quad (3)$$

Proof: Let R and S be a top and bottom subtree of Q , respectively, with $|R| = r$ and $|S| = s$. By construction $R = M_{\pi_i}$, for some $x < i < k(\pi)$, or $R = M_{\tau_i}$, for some $1 \leq i < k(\tau)$. Further, $S = L_{\pi_j}$, for some $x \leq j < k(\pi)$, or $S = L_{\tau_j}$, for some $1 \leq j < k(\tau)$. We first assume that $R = M_{\pi_i}$, for some $x < i < k(\pi)$. We distinguish five cases.

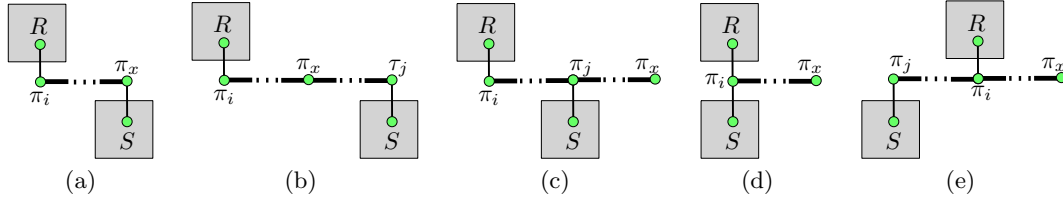

Fig. 3. The five cases for the proof of inequality (3).

Case 1: $S = L_{\pi_x}$ (see Fig. 3(a)). We have that $|H_{\pi_i}| \geq r$; also, $|M_{\pi_x}| \geq s$. Since $L_{\pi_x}, M_{\pi_x}, M_{\pi_i}$, and H_{π_i} are vertex-disjoint, we have $2r + 2s \leq n$, which implies $r + s \leq \frac{2(p-1)}{3p}n$ if $p \geq 4$.

Case 2: $S = L_{\tau_j}$, for some $1 \leq j < k(\tau)$ (see Fig. 3(b)). We have $|H_{\pi_i}| \geq r$; also, $|H_{\tau_j}| \geq s$. Since $L_{\tau_j}, H_{\tau_j}, M_{\pi_i}$, and H_{π_i} are vertex-disjoint, we have $2r + 2s \leq n$, which implies $r + s \leq \frac{2(p-1)}{3p}n$ if $p \geq 4$.

Case 3: $S = L_{\pi_j}$, for some $x < j < i$ (see Fig. 3(c)). We have $|H_{\pi_i}| \geq r$; also, $|M_{\pi_j}| \geq s$. Since $L_{\pi_j}, M_{\pi_j}, M_{\pi_i}$, and H_{π_i} are vertex-disjoint, we have $2r + 2s \leq n$, which implies $r + s \leq \frac{2(p-1)}{3p}n$ if $p \geq 4$.

Case 4: $S = L_{\pi_i}$ (see Fig. 3(d)). By definition of x we have $|M_{\pi_x}| \geq n/p$. Since T_{π_i} and M_{π_x} are vertex-disjoint, we have $|T_{\pi_i}| \leq \frac{p-1}{p}n$. Since $|H_{\pi_i}| \geq |M_{\pi_i}|, |L_{\pi_i}|$, we have $r + s \leq \frac{2(p-1)}{3p}n$.

Case 5: $S = L_{\pi_j}$, for some $x < i < j < k(\pi)$ (see Fig. 3(e)). As in Case 4, we have $|T_{\pi_i}| \leq \frac{p-1}{p}n$. Since $T_{\pi_{i+1}} = H_{\pi_i}$, we have $r \leq |T_{\pi_{i+1}}|$. Since $|H_{\pi_j}|, |M_{\pi_j}| \geq |L_{\pi_j}|$, we have $s \leq |T_{\pi_{i+1}}|/3$, hence $r + s \leq 4|T_{\pi_{i+1}}|/3$. On the other hand, at least $|T_{\pi_{i+1}}| - |L_{\pi_j}| \geq 2|T_{\pi_{i+1}}|/3$ nodes of $T_{\pi_{i+1}}$ do not belong to R or S , hence $\frac{4|T_{\pi_{i+1}}|}{3} + \frac{2|T_{\pi_{i+1}}|}{3} = 2|T_{\pi_{i+1}}| \leq \frac{p-1}{p}n$, which is $|T_{\pi_{i+1}}| \leq \frac{p-1}{2p}n$. It follows that $r + s \leq \frac{2(p-1)}{3p}n$.

This concludes the discussion if $R = M_{\pi_i}$, for some $x < i < k(\pi)$. Note that our arguments above do not make use of the fact that $|T_{\pi_{x+1}}| \geq |T_{\tau_1}|$ (which is true since $T_{\pi_{x+1}} = H_{\pi_x}$ and $T_{\tau_1} = M_{\pi_x}$). Hence, symmetric arguments handle the case in which $R = M_{\tau_i}$, for some $1 \leq i < k(\tau)$. \square

The height of the part of Γ below ℓ_Q is given by the height of a bottom subtree of Q . Further, since ℓ_Q is one unit below the bottommost horizontal line intersecting P or its attached subtrees, the height of the

part of Γ above ℓ_Q is given by the maximum between the height of a top subtree of Q , and the height of a top subtree of P plus the height of a bottom subtree of P plus one (corresponding to ℓ_P). Since the heights of a top subtree of P , of a bottom subtree of P , of a top subtree of Q , and of a bottom subtree of Q are at most $\eta(a)$, $\eta(b)$, $\eta(r)$, and $\eta(s)$, respectively, by taking into account the grid row of ℓ_Q we get:

$$\eta(n) \leq \max\{\eta(r) + \eta(s) + 1, \eta(a) + \eta(b) + \eta(s) + 2\}. \quad (4)$$

We are going to inductively prove that

$$\eta(n) \leq 2 \cdot n^c - 1, \text{ where } c = \frac{1}{\log_2 \frac{3p}{p-1}}. \quad (5)$$

Note that inequality (5) is trivially true if $n = 1$. Now inductively assume that inequality (5) is true for all integer values of the variable less than n . By inequality (4), it suffices to prove that $\max\{\eta(r) + \eta(s) + 1, \eta(a) + \eta(b) + \eta(s) + 2\} \leq 2 \cdot n^c - 1$.

- First, we need to have $\eta(r) + \eta(s) + 1 \leq 2 \cdot n^c - 1$. By induction, $\eta(r) + \eta(s) + 1 \leq 2 \cdot r^c - 1 + 2 \cdot s^c - 1 + 1$, hence we need that $r^c + s^c \leq n^c$.

Here we use Hölder's inequality, which states that $\sum a_i b_i \leq (\sum a_i^x)^{\frac{1}{x}} (\sum b_i^y)^{\frac{1}{y}}$ for every x and y such that $1/x + 1/y = 1$. By employing the values $1/x = c$, $1/y = 1 - c$, $a_1 = r^c$, $a_2 = s^c$, $b_1 = b_2 = 1$, we get:

$$r^c + s^c \leq (r + s)^c \cdot 2^{1-c} \leq \left(\frac{2(p-1)}{3p}n\right)^c \cdot 2^{1-c} = 2 \cdot \left(\frac{p-1}{3p}n\right)^c,$$

where we exploited inequality (3). Thus, we need $2 \cdot \left(\frac{p-1}{3p}n\right)^c \leq n^c$, which is $2 \cdot \left(\frac{p-1}{3p}\right)^{1/(\log_2 \frac{3p}{p-1})} \leq 1$. Set $x = \frac{3p}{p-1}$; then the previous inequality becomes $(1/x)^{1/\log_2 x} \leq 1/2$; taking the base-2 logarithms, we have $\log_2(1/x)^{1/\log_2 x} \leq \log_2(1/2)$, hence $\frac{1}{\log_2 x} \log_2(1/x) \leq -1$ which is $-1 \leq -1$. This proves that $\eta(r) + \eta(s) + 1 \leq 2 \cdot n^c - 1$.

- Second, we need to have $\eta(a) + \eta(b) + \eta(s) + 2 \leq 2 \cdot n^c - 1$. By inequality (2), we have $\eta(a) + \eta(b) + \eta(s) + 2 \leq \eta(a) + \eta(b) + \eta\left(\frac{n-a-b}{3}\right) + 2$. By induction, $\eta(a) \leq 2 \cdot a^c - 1$, $\eta(b) \leq 2 \cdot b^c - 1$, and $\eta\left(\frac{n-a-b}{3}\right) \leq 2 \cdot \left(\frac{n-a-b}{3}\right)^c - 1$, hence we need that $a^c + b^c + \left(\frac{n-a-b}{3}\right)^c \leq n^c$.

We prove that $f(a, b) = a^c + b^c + \left(\frac{n-a-b}{3}\right)^c$ grows monotonically with a , by assuming that $0.5 < c < 1$; this assumption will be verified later. We have $\frac{\partial f(a, b)}{\partial a} = c \cdot a^{c-1} - \frac{c}{3} \cdot \left(\frac{n-a-b}{3}\right)^{c-1}$, which is greater than zero as long as $a^{c-1} > \frac{1}{3^c} \cdot (n-a-b)^{c-1}$. Since $c < 1$, we have that $c-1$ is negative, hence by raising the previous inequality to the power of $1/(c-1)$ we get $a < 3^{c/(1-c)} \cdot (n-a-b)$, which is $a < \frac{3^{c/(1-c)}}{1+3^{c/(1-c)}} \cdot (n-b)$.

By inequality (1) the latter is true as long as $\frac{n}{p} < \frac{3^{c/(1-c)}}{1+3^{c/(1-c)}} \cdot \frac{p-1}{p} \cdot n$, that is $\frac{3^{c/(1-c)}}{1+3^{c/(1-c)}} \cdot (p-1) > 1$. Since $c > 0.5$ we get that $3^{c/(1-c)} > 3$, hence $\frac{3^{c/(1-c)}}{1+3^{c/(1-c)}} > \frac{3}{4}$. Since $p > 4$, the inequality $\frac{3^{c/(1-c)}}{1+3^{c/(1-c)}} \cdot (p-1) > 1$ is satisfied, hence $\frac{\partial f(a, b)}{\partial a} > 0$ and $f(a, b)$ grows monotonically with a .

It can be proved analogously that $f(a, b)$ grows monotonically with b , as long as $0.5 < c < 1$.

By inequality (1) we have $a, b < n/p$, hence the monotonicity of $f(a, b)$ we proved above implies $a^c + b^c + \left(\frac{n-a-b}{3}\right)^c < 2 \cdot (n/p)^c + \left(\frac{n-2n/p}{3}\right)^c$. Thus, we need $2 \cdot (n/p)^c + \left(\frac{n-2n/p}{3}\right)^c \leq n^c$. Dividing by

n^c , the inequality becomes $2 \cdot (1/p)^c + \left(\frac{1-2/p}{3}\right)^c - 1 \leq 0$. Thus, we need to choose p so to satisfy

$2 \cdot (1/p)^{1/\log_2 \frac{3p}{p-1}} + \left(\frac{1-2/p}{3}\right)^{1/\log_2 \frac{3p}{p-1}} - 1 \leq 0$; the latter inequality is true¹ if $p \geq 9.956$. Thus setting $p = 9.956$ we have $\eta(a) + \eta(b) + \eta(s) + 2 \leq 2 \cdot n^c - 1$.

From $p = 9.956$ we get $c = 0.576$. By inequality (5) the height of Γ is in $O(n^{0.576})$. This completes the proof of the height and area bounds for Γ .

¹ We used the software at WWW.WOLFRAMALPHA.COM in order to solve the inequality.

Finally, we describe how to modify the construction if $x = 1$, if $x = 2$, or if x is undefined. If x is undefined, then π “never turns down”, that is, the construction coincides with the one above with $x = k(\pi) + 1$. If $x = 1$, then the construction coincides with the one above starting from π_x , that is, ignoring the paths ρ , σ , and $(\pi_1, \dots, \pi_{x-1})$ and their attached subtrees. If $x = 2$, then π “immediately turns down”: the second heaviest subtree of $r(T) = \pi_1 = \pi_{x-1}$ is drawn as above, while its lightest subtree is drawn as the second heaviest subtree of π_{x-1} above (σ is drawn straight with its subtrees attached to it); the rest of the construction, starting from π_x , coincides with the one above. In each of these cases, the analysis on the width, height, and area of the constructed drawings does not change. This concludes the proof of Theorem 1.

3 Complete Ternary Trees

In this section we study the area requirements of planar straight-line orthogonal drawings of complete ternary trees. Restricting the attention to complete ternary trees allows one to achieve better area bounds than the one from Theorem 1. Indeed, Ali [1] proved that planar straight-line orthogonal drawings can be constructed in $O(n^{1.118})$ area²; the recursive construction achieving such a bound is depicted in Fig. 4.

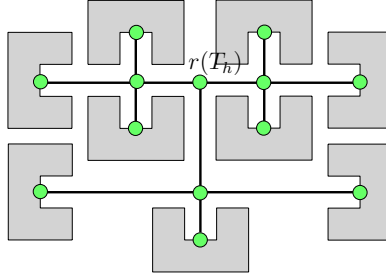

Fig. 4. Ali’s [1] construction of a planar straight-line orthogonal drawing of the complete ternary tree T_h with height h uses 9 copies of the inductively constructed drawing of T_{h-2} .

We aim at investigating what area bounds can be achieved for planar straight-line orthogonal drawings of the complete ternary tree T_h with height h that are constructed by using (suitable combinations of) the two inductive constructions depicted in Figs. 5(a) and 5(b). These constructions are called Construction 1 and Construction 2, respectively. Before formally defining such constructions, we need to introduce the following definitions. For a drawing of a ternary tree, the *left width* is the number of grid columns intersecting the drawing to the left of the root; the *right width*, the *top height*, and the *bottom height* are defined analogously.

A *1-2 drawing* of T_h is formally defined as follows. If $h = 1$, then a drawing of T_h in which the root $r(T_h)$ of T_h is placed at a grid point of the plane is a 1-2 drawing; observe that this drawing is unique up to a translation by any vector with integer coordinates. If $h > 1$, then consider any three (not necessarily congruent) 1-2 drawings of T_{h-1} , call them Γ_{h-1}^a , Γ_{h-1}^b , and Γ_{h-1}^c . Arrange such drawings as in Construction 1 or as in Construction 2; then the resulting drawing of T_h is a 1-2 drawing.

Construction 1 is more precisely defined as follows:

- draw $r(T_h)$ at any grid point of the plane;
- place Γ_{h-1}^a in the plane so that the highest horizontal line intersecting it is one unit below $r(T_h)$ and so that the root $r(T_{h-1})$ in Γ_{h-1}^a is on the same vertical line as $r(T_h)$;
- rotate Γ_{h-1}^b in clockwise direction by 90° and then place it in the plane so that the rightmost vertical line intersecting it is one unit to the left of the leftmost vertical line intersecting Γ_{h-1}^a and so that the root $r(T_{h-1})$ in Γ_{h-1}^b is on the same horizontal line as $r(T_h)$; and

² This result improved on an earlier $O(n^{1.262})$ bound [8], which will be discussed later.

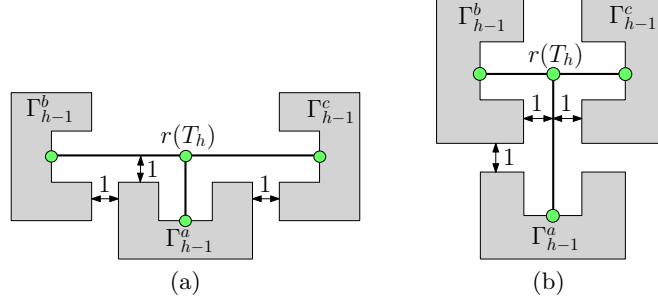

Fig. 5. (a) Construction 1 and (b) Construction 2. Each of them constructs a planar straight-line orthogonal drawing of T_h out of 3 (not necessarily congruent) 1-2 drawings Γ_{h-1}^a , Γ_{h-1}^b , and Γ_{h-1}^c of T_{h-1} . A “ \sqcup ”-shape is used to represent a 1-2 drawing to emphasize that the vertical half-line emanating from the root and directed upwards does not intersect the drawing other than at the root.

- rotate Γ_{h-1}^c in counterclockwise direction by 90° and then place it in the plane so that the leftmost vertical line intersecting it is one unit to the right of the rightmost vertical line intersecting Γ_{h-1}^a and so that the root $r(T_{h-1})$ in Γ_{h-1}^c is on the same horizontal line as $r(T_h)$.

The following descends immediately by construction.

Property 1. Let $h \geq 2$ and, for $i \in \{a, b, c\}$, let ω_i , η_i , λ_i , and ρ_i be the width, the height, the left width and the right width of Γ_{h-1}^i , respectively. Then the width of the 1-2 drawing constructed by means of Construction 1 is $\omega_a + \eta_b + \eta_c$ and its height is $\max\{\lambda_b, \rho_c\} + \max\{\rho_b, \eta_a, \lambda_c\} + 1$.

Construction 2 is analogously defined as follows:

- draw $r(T_h)$ at any grid point of the plane;
- rotate Γ_{h-1}^b in clockwise direction by 90° and then place it in the plane so that the rightmost vertical line intersecting it is one unit to the left of $r(T_h)$ and so that the root $r(T_{h-1})$ in Γ_{h-1}^b is on the same horizontal line as $r(T_h)$;
- rotate Γ_{h-1}^c in counterclockwise direction by 90° and then place it in the plane so that the leftmost vertical line intersecting it is one unit to the right of $r(T_h)$ and so that the root $r(T_{h-1})$ in Γ_{h-1}^c is on the same horizontal line as $r(T_h)$; and
- place Γ_{h-1}^a in the plane so that the highest horizontal line intersecting it is one unit below the lowest horizontal line intersecting Γ_{h-1}^b or Γ_{h-1}^c and so that the root $r(T_{h-1})$ in Γ_{h-1}^a is on the same vertical line as $r(T_h)$.

The following descends immediately by construction.

Property 2. Let $h \geq 2$ and, for $i \in \{a, b, c\}$, let ω_i , η_i , λ_i , and ρ_i be the width, the height, the left width and the right width of Γ_{h-1}^i , respectively. Then the width of the 1-2 drawing constructed by means of Construction 2 is $\max\{\lambda_a, \eta_b\} + \max\{\rho_a, \eta_c\} + 1$ and its height is $\max\{\lambda_b, \rho_c\} + \max\{\rho_b, \lambda_c\} + \eta_a + 1$.

A 1-2 drawing has a nice feature that the drawings of Ali [1] do not have, called *subtree separation* property: the smallest axis-parallel rectangles enclosing the drawings of any two node-disjoint subtrees do not overlap. This property has been frequently considered in the tree drawing literature (see, e.g., [3,10,13,14]), both because of the readability of the drawings that have it and because it is directly guaranteed by the following natural approach for drawing trees: Inductively construct drawings of the subtrees of the root and place them together so that the smallest axis-parallel rectangles enclosing them do not overlap; a placement of the root in the plane then completes the drawing. The notorious *H-drawings* [15] and *HV-drawings* [5] are planar

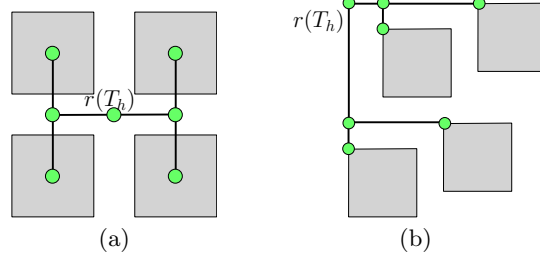

Fig. 6. (a) H-drawings, as in [15]. (b) HV-drawings, as in [5].

straight-line orthogonal drawings that satisfy the subtree separation property; they can be constructed in linear area for complete binary trees (see Figs. 6(d) and 6(e), respectively).

In Section 3.2 we prove that, for complete ternary trees, 1-2 drawings require minimum area among all the planar straight-line orthogonal drawings satisfying the subtree separation property. Motivated by this result and exploiting a polynomial-time algorithm for computing minimum-area 1-2 drawings of complete ternary trees, in Section 3.3 we devise an extensive experimentation of the minimum area required by any 1-2 drawing of a complete ternary tree. However, we first analytically prove some asymptotic upper bounds for the area required by such drawings. This is done in the upcoming Section 3.1.

3.1 Upper Bounds for the Area Requirements of 1-2 Drawings

We start by considering 1-2 drawings that are constructed by using only one between Constructions 1 and 2. These drawings do not have the best area bounds, however they are natural to look at and easy to analyze. We have the following.

Lemma 1. *Let Γ_h be the 1-2 drawing of T_h that is constructed by using Construction 1 only. Then Γ_h has width $\omega_h = 2^h - 1$ and height $\eta_h = 2^{h-1}$.*

Proof: We prove, by induction on h , that Γ_h has width $\omega_h = 2^h - 1$, has height $\eta_h = 2^{h-1}$, and has the left width λ_h equal to the right width ρ_h (hence $\lambda_h = \rho_h = 2^{h-1} - 1$).

The base case, in which $h = 1$, is trivially proved, given that $\omega_1 = \eta_1 = 1$ and $\lambda_1 = \rho_1 = 0$.

For the inductive case, assume that $\omega_{h-1} = 2^{h-1} - 1$, $\eta_{h-1} = 2^{h-2}$, and $\lambda_{h-1} = \rho_{h-1} = 2^{h-2} - 1$. By Property 1 and since $\lambda_{h-1} = \rho_{h-1}$, we have $\omega_h = \omega_{h-1} + 2 \cdot \eta_{h-1} = (2^{h-1} - 1) + 2 \cdot 2^{h-2} = 2^h - 1$ and $\eta_h = (2^{h-2} - 1) + 2^{h-2} + 1 = 2^{h-1}$. Finally, $\lambda_h = \eta_{h-1} + \lambda_{h-1}$ and $\rho_h = \eta_{h-1} + \rho_{h-1}$, hence $\lambda_h = \rho_h$. \square

Lemma 2. *Let Γ_h be the 1-2 drawing of T_h that is constructed by using Construction 2 only. Then Γ_h has:*

- width $\omega_h = (2^{h+1} - 1)/3$ and height $\eta_h = (2^{h+1} - 1)/3$ if h is odd; and
- width $\omega_h = (2^{h+1} + 1)/3$ and height $\eta_h = (2^{h+1} - 2)/3$ if h is even.

Proof: We prove, by induction on h , that Γ_h has width and height as in the statement of the lemma, and that its left width λ_h is equal to its right width ρ_h (hence $\lambda_h = \rho_h = (2^h - 2)/3$ if h is odd and $\lambda_h = \rho_h = (2^h - 1)/3$ if h is even).

We prove the statement by induction on h . The base case, in which $h \leq 2$, is trivially proved, given that $\omega_1 = \eta_1 = 1$, $\lambda_1 = \rho_1 = 0$, $\omega_2 = 3$, $\eta_2 = 2$, and $\lambda_2 = \rho_2 = 1$.

For the inductive case, assume that the statement holds for Γ_{h-1} . By Property 2 and since $\eta_{h-1} > \lambda_{h-1} = \rho_{h-1}$, we have $\omega_h = \eta_{h-1} + \eta_{h-1} + 1 = 2 \cdot \eta_{h-1} + 1$ and $\eta_h = \lambda_{h-1} + \rho_{h-1} + \eta_{h-1} + 1 = \omega_{h-1} + \eta_{h-1}$.

- If h is odd, then $\omega_{h-1} = (2^h + 1)/3$ and $\eta_{h-1} = (2^h - 2)/3$, hence $\omega_h = 2 \cdot (2^h - 2)/3 + 1 = (2^{h+1} - 1)/3$ and $\eta_h = (2^h + 1)/3 + (2^h - 2)/3 = (2^{h+1} - 1)/3$.

- If h is even, then $\omega_{h-1} = (2^h - 1)/3$ and $\eta_{h-1} = (2^h - 1)/3$, hence $\omega_h = 2 \cdot (2^h - 1)/3 + 1 = (2^{h+1} + 1)/3$ and height $\eta_h = (2^h - 1)/3 + (2^h - 1)/3 = (2^{h+1} - 2)/3$.

Finally, since $\eta_{h-1} > \lambda_{h-1} = \rho_{h-1}$, we have $\lambda_h = \rho_h = \eta_{h-1}$. \square

Corollary 1. *The 1-2 drawing of the complete ternary tree with n nodes that is constructed by using Construction 1 only or by using Construction 2 only has width $O(n^{\log_3 2}) \in O(n^{0.631})$, height $O(n^{\log_3 2}) \in O(n^{0.631})$, and area $O(n^{\log_3 4}) \in O(n^{1.262})$.*

Proof: The statement follows by Lemma 1, by Lemma 2, and by $h = \log_3(2n + 1)$. \square

Our next algorithm constructs 1-2 drawings with height $O(n^{\log_3 \phi}) \in O(n^{0.439})$, where ϕ is the golden ratio. It turns out that this height bound is the smallest possible. In fact, in Section 4 we will prove that every planar straight-line orthogonal drawing of a complete ternary tree with n nodes requires height $\Omega(n^{\log_3 \phi})$, even if the drawing is not required to satisfy the subtree separation property.

Theorem 2. *The complete ternary tree with n nodes has a 1-2 drawing with height $O(n^{\log_3((1+\sqrt{5})/2)}) \in O(n^{0.439})$, with width $O(n^{\log_3(1+\sqrt{2})}) \in O(n^{0.803})$, and with area $O(n^{1.242})$.*

Proof: In order to prove the theorem, we use induction on h . We will construct *two* 1-2 drawings Γ_h^1 and Γ_h^2 of T_h , the first one with small height and the second one with small width.

If $h \leq 2$, then both Γ_h^1 and Γ_h^2 coincide with the unique 1-2 drawing of T_h . Suppose now that Γ_{h-1}^1 and Γ_{h-1}^2 have been defined, for some $h \geq 3$. We show how to construct Γ_h^1 and Γ_h^2 .

We construct Γ_h^1 as follows. Let $\Gamma_{h-1}^a = \Gamma_{h-1}^1$ (this is the drawing of the subtree of $r(T_h)$ whose root is on the same vertical line as $r(T_h)$) and let $\Gamma_{h-1}^b = \Gamma_{h-1}^c = \Gamma_{h-1}^2$ (these are the drawings of the subtrees of $r(T_h)$ whose roots are on the same horizontal line as $r(T_h)$); recall that Γ_{h-1}^b and Γ_{h-1}^c are rotated by 90° , respectively clockwise and counterclockwise, in Γ_h^1 . We arrange such drawings together by means of Construction 1. Analogously, in order to construct Γ_h^2 , let $\Gamma_{h-1}^a = \Gamma_{h-1}^2$ and let $\Gamma_{h-1}^b = \Gamma_{h-1}^c = \Gamma_{h-1}^1$. We arrange such drawings together by means of Construction 2.

We now analyze the height, the width, and the area of Γ_h^1 and Γ_h^2 . Denote by ω_h^1 , by η_h^1 , by λ_h^1 , and by ρ_h^1 (by ω_h^2 , by η_h^2 , by λ_h^2 , and by ρ_h^2) the width, the height, the left width, and the right width of Γ_h^1 (of Γ_h^2), respectively. We will prove that:

- (a) $\eta_h^1 = \eta_{h-1}^1 + \eta_{h-2}^1 + 1$, for $h \geq 3$;
- (b) $\lambda_h^2 = \rho_h^2$, for $h \geq 1$; and
- (c) $\eta_h^1 > \lambda_h^2$, for $h \geq 1$.

We now prove the above inductive hypotheses by induction on h . The base case, in which $h \leq 2$, is trivially proved. Indeed, by construction we have $\lambda_1^2 = \rho_1^2 = 0$ and $\lambda_2^2 = \rho_2^2 = 1$, hence inductive hypothesis (b) is verified; further, $\eta_1^1 = 1 > 0 = \lambda_1^2$ and $\eta_2^1 = 2 > 1 = \lambda_2^2$, hence inductive hypothesis (c) is verified. Inductive hypothesis (a) is vacuous if $h \leq 2$. Assume next that $h \geq 3$.

We prove that inductive hypothesis (a) is verified for h . By Property 1 and by inductive hypotheses (b) and (c) for $h - 1$, we have $\eta_h^1 = \lambda_{h-1}^2 + \eta_{h-1}^1 + 1$. By inductive hypothesis (b) for $h - 1$, we have $\lambda_{h-1}^2 = (\omega_{h-1}^2 - 1)/2$. By Property 2 and by inductive hypothesis (c) for $h - 2$, we have $\omega_{h-1}^2 = 2\eta_{h-2}^1 + 1$, hence $\lambda_{h-1}^2 = \eta_{h-2}^1$ and $\eta_h^1 = \eta_{h-1}^1 + \eta_{h-2}^1 + 1$.

We prove that inductive hypothesis (b) is verified for h . This comes from the fact that inductive hypothesis (b) is satisfied for $h - 1$ (which ensures that the left and right width of Γ_{h-1}^a are equal) and from the fact that Γ_{h-1}^b and Γ_{h-1}^c have the same height (and hence the same width once they are rotated by 90°).

We prove that inductive hypothesis (c) is verified for h . By construction, we have $\lambda_h^2 = \max\{\eta_{h-1}^1, \lambda_{h-1}^2\}$. By inductive hypothesis (c) for $h - 1$, we have $\eta_{h-1}^1 > \lambda_{h-1}^2$ and hence $\lambda_h^2 = \eta_{h-1}^1$. By inductive hypothesis (a) for h , we have $\eta_h^1 > \eta_{h-1}^1$ and hence $\eta_h^1 > \lambda_h^2$.

We are now ready to analyze the height η_h^1 of Γ_h^1 . By inductive hypothesis (a), we have that η_h^1 grows asymptotically as the terms of the Fibonacci sequence; it is known that the ratio between two consecutive

terms of such a sequence tends to the golden ratio $\phi = (1 + \sqrt{5})/2 \approx 1.618$, hence $\eta_h^1 \in O(\phi^h)$. This can be formalized as follows. We prove, by induction on h , that $\eta_h^1 \leq k \cdot \phi^h - 1$, where k is a constant that is large enough so that $\eta_h^1 \leq k \cdot \phi^h - 1$ holds true in the base case, in which $h \leq 2$. If $h \geq 3$ then, by inductive hypothesis (a), we have $\eta_h^1 = \eta_{h-1}^1 + \eta_{h-2}^1 + 1$. By induction, the latter is smaller than or equal to $(k \cdot \phi^{h-1} - 1) + (k \cdot \phi^{h-2} - 1) + 1 = k \cdot (\phi^{h-1} + \phi^{h-2}) - 1$. Hence, it suffices to prove that $\phi^{h-1} + \phi^{h-2} \leq \phi^h$. Dividing both sides by ϕ^{h-2} , we get $\phi^2 - \phi - 1 \geq 0$. Since $(1 + \sqrt{5})/2$ is one of the solutions of the equation $\phi^2 - \phi - 1 = 0$, it follows that $\phi^2 - \phi - 1 \geq 0$ and hence $\eta_h^1 \leq k \cdot \phi^h - 1 \in O(\phi^h)$. Since $h \in O(\log_3 n)$ we get the height bound claimed in the theorem.

The width ω_h^1 of Γ_h^1 needs to be analyzed together with the height η_h^2 of Γ_h^2 . In fact, by construction and by Properties 1 and 2, we have $\omega_h^1 = \omega_{h-1}^1 + 2 \cdot \eta_{h-1}^2$ and $\eta_h^2 = \omega_{h-1}^1 + \eta_{h-1}^2$. Substituting repeatedly the first equation into the second one, we get $\eta_h^2 = \eta_{h-1}^2 + 2 \cdot \eta_{h-2}^2 + 2 \cdot \eta_{h-3}^2 + \dots + 2 \cdot \eta_1^2 + \omega_1^1$. In the same way, we get $\eta_{h-1}^2 = \eta_{h-2}^2 + 2 \cdot \eta_{h-3}^2 + 2 \cdot \eta_{h-4}^2 + \dots + 2 \cdot \eta_1^2 + \omega_1^1$. Subtracting the latter from the former, we get $\eta_h^2 - \eta_{h-1}^2 = \eta_{h-1}^2 + 2 \cdot \eta_{h-2}^2 - \eta_{h-2}^2$, that is, $\eta_h^2 = 2 \cdot \eta_{h-1}^2 + \eta_{h-2}^2$. Now assume that $\eta_h^2 \leq k \cdot c^h$, for some suitable constant k and c , where we want c as small as possible, while k is sufficiently large so that $\eta_h^2 \leq k \cdot c^h$ holds true for small values of h . Then we need to have $2 \cdot (k \cdot c^{h-1}) + (k \cdot c^{h-2}) \leq k \cdot c^h$, hence $c^2 - 2c - 1 \geq 0$. The associated equation has solutions $c = (1 \pm \sqrt{2})$, hence we have $\eta_h^2 \leq k \cdot (1 + \sqrt{2})^h \in O((1 + \sqrt{2})^h)$. The width ω_h^1 of Γ_h^1 has the same asymptotic value of η_h^2 . For example, from $\eta_{h+1}^2 = \omega_h^1 + \eta_h^2$ one derives $\omega_h^1 \leq k \cdot (1 + \sqrt{2})^{h+1} \in O((1 + \sqrt{2})^h)$. By using $h \in O(\log_3 n)$ we get the width bound claimed in the theorem. The area bound also follows. \square

The best area upper bound we could analytically prove for 1-2 drawings of n -node complete ternary trees is $O(n^{1.149})$; this is pretty close to the $O(n^{1.118})$ bound by Ali [1] for planar straight-line orthogonal drawings that do not satisfy the subtree separation property.

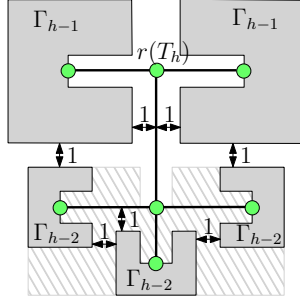

Fig. 7. The construction of an $O(n^{1.149})$ -area 1-2 drawing of T_h satisfying the subtree separation property.

Theorem 3. *The complete ternary tree with n nodes has a 1-2 drawing in $O(n^{1.149})$ area.*

Proof: We show how to construct a 1-2 drawing Γ_h of T_h in $O(n^{1.149})$ area. If $h \leq 2$, then Γ_h coincides with the unique 1-2 drawing of T_h . Suppose now that $h \geq 3$. We construct Γ_h as follows (refer to Fig. 7). We construct Γ_{h-1}^a (this is the drawing of the subtree of $r(T_h)$ whose root is on the same vertical line as $r(T_h)$) out of three copies of Γ_{h-2} arranged by means of Construction 1. Further, let $\Gamma_{h-1}^b = \Gamma_{h-1}^c = \Gamma_{h-1}$ (these are the drawings of the subtrees of $r(T_h)$ whose roots are on the same horizontal line as $r(T_h)$); recall that Γ_{h-1}^b and Γ_{h-1}^c are rotated by 90° , respectively clockwise and counterclockwise, in Γ_h . We arrange such drawings together by means of Construction 2.

We now establish upper bounds on the width ω_h and on the height η_h of Γ_h . In order to do that, we exploit that the left width λ_h of Γ_h is equal to the right width ρ_h . This is easily proved by induction. Indeed, in the base case, we have $\lambda_1 = \rho_1 = 0$ and $\lambda_2 = \rho_2 = 1$. Further, if $h \geq 3$, then $\lambda_h = \max\{\eta_{h-1}, \omega_{h-2} + \lambda_{h-2}\}$ and $\rho_h = \max\{\eta_{h-1}, \omega_{h-2} + \rho_{h-2}\}$, hence $\lambda_h = \rho_h$ follows by $\lambda_{h-2} = \rho_{h-2}$.

We are now ready to analyze the asymptotic behavior of ω_h and η_h . In the base case, we have $\omega_1 = \eta_1 = 1$, $\omega_2 = 3$, and $\eta_2 = 2$. By Properties 1 and 2 and since $\lambda_h = \rho_h$, we have:

$$\omega_h = \max\{2\eta_{h-1} + 1, \omega_{h-2} + 2\eta_{h-2}\}. \quad (6)$$

Again by Properties 1 and 2 and since $\lambda_{h-1} = \rho_{h-1}$ and $\lambda_{h-2} = \rho_{h-2}$, we have:

$$\eta_h = \omega_{h-1} + \max\{\omega_{h-2}, (\omega_{h-2} + 1)/2 + \eta_{h-2}\}. \quad (7)$$

We now inductively prove that $\omega_h \leq k \cdot c^h - 1$ and $\eta_h \leq \alpha \cdot k \cdot c^h - 1$, for any $h = 1, 2, \dots$, where α , k , and c are suitable constants (to be determined) such that $1/2 < \alpha < 1$, $k > 1$, and $1 < c < 2$; in particular, we would like c to be as small as possible. If $h = 1$ or $h = 2$, then, for any constants $c > 1$ and $1/2 < \alpha < 1$, a constant k can be chosen large enough so that $\omega_h \leq k \cdot c^h - 1$ and $\eta_h \leq \alpha \cdot k \cdot c^h - 1$. Indeed, it suffices to choose $k \geq 4/(\alpha \cdot c)$ in order to have $k \cdot c^h - 1 > \alpha \cdot k \cdot c^h - 1 \geq 3 \geq \omega_1, \eta_1, \omega_2, \eta_2$.

For the inductive case, assume that $\omega_{h'} \leq k \cdot c^{h'} - 1$ and $\eta_{h'} \leq \alpha \cdot k \cdot c^{h'} - 1$, for every integer $h' < h$; we prove the same inequalities for h .

By applying induction in equation (7), we get $\eta_h \leq k \cdot c^{h-1} - 1 + \max\{k \cdot c^{h-2} - 1, (k \cdot c^{h-2} - 1 + 1)/2 + \alpha \cdot k \cdot c^{h-2} - 1\} \leq k \cdot c^{h-1} - 1 + k \cdot c^{h-2} \cdot \max\{1, \alpha + 1/2\} \leq k \cdot c^{h-1} - 1 + (\alpha + 1/2) \cdot k \cdot c^{h-2}$, where we exploited $\alpha > 1/2$. Hence, we want $k \cdot c^{h-1} - 1 + (\alpha + 1/2) \cdot k \cdot c^{h-2} \leq \alpha \cdot k \cdot c^h - 1$, that is

$$\alpha \cdot c^2 - c - (\alpha + 1/2) \geq 0. \quad (8)$$

In order to establish $\omega_h \leq k \cdot c^h - 1$ we distinguish two cases, based on which term determines the maximum in equation (6).

If $\omega_{h-2} + 2\eta_{h-2} \geq 2\eta_{h-1} + 1$, then $\omega_h = \omega_{h-2} + 2\eta_{h-2}$. By applying induction, we get $\omega_h \leq k \cdot c^{h-2} - 1 + 2(\alpha \cdot k \cdot c^{h-2} - 1) = (2\alpha + 1) \cdot k \cdot c^{h-2} - 3$. Hence, we want $(2\alpha + 1) \cdot k \cdot c^{h-2} - 3 \leq k \cdot c^h - 1$, which is true as long as $c^2 \geq 2\alpha + 1$, hence

$$c \geq \sqrt{2\alpha + 1}. \quad (9)$$

If $2\eta_{h-1} + 1 > \omega_{h-2} + 2\eta_{h-2}$, then $\omega_h = 2\eta_{h-1} + 1$. By applying induction, we get $\omega_h \leq 2(\alpha \cdot k \cdot c^{h-1} - 1) + 1 = 2\alpha \cdot k \cdot c^{h-1} - 1$. Hence, we want $2\alpha \cdot k \cdot c^{h-1} - 1 \leq k \cdot c^h - 1$, which is true as long as

$$c \geq 2\alpha. \quad (10)$$

Now pick $c = 2\alpha$, thus satisfying inequality (10). Substituting $c = 2\alpha$ in inequality (8), we want $4\alpha^3 - 3\alpha - 1/2 \geq 0$, which is true if $\alpha \geq 0.9397$. So take $\alpha = 0.9397$, implying that inequality (8) is satisfied and note that $c = 2\alpha = 1.8794 > 1.6969 > \sqrt{2\alpha + 1}$, hence inequality (9) is satisfied as well. This completes the induction and hence proves that $\omega_h, \eta_h \in O(1.8794^h)$.

Since $h \in O(\log_3 n)$, we have $\omega_h, \eta_h \in O(n^{\log_3 1.8794}) \in O(n^{0.5744})$. The theorem follows. \square

3.2 1-2 Drawings vs Drawings with the Subtree Separation Property

In this section we show that 1-2 drawings require minimum area among the planar straight-line orthogonal drawings satisfying the subtree separation property. This is proved in the following lemma.

Lemma 3. *Suppose that the complete ternary tree T_h has a planar straight-line orthogonal drawing Γ with the subtree separation property, with left width λ , with right width ρ , with height η , and such that, if $h \geq 2$, then the three children of $r(T_h)$ are to the left, below, and to the right of $r(T_h)$.*

Then there is a 1-2 drawing Γ' of T_h with the following properties:

- the left and right widths of Γ' are both equal to a value $\mu \leq \min\{\lambda, \rho\}$;
- the height of Γ' is at most η ; and

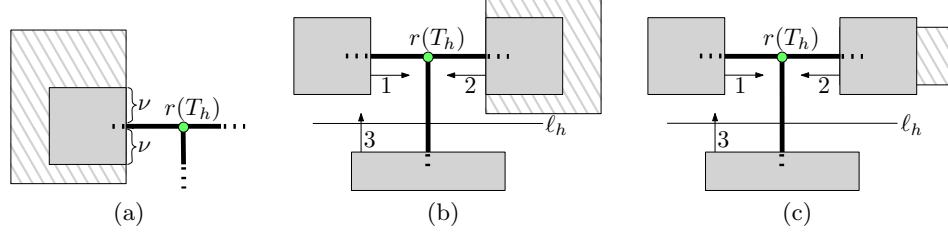

Fig. 8. (a) Replacement of the drawing Γ_L , which is represented by a shaded rectangle, by a (rotated) 1-2 drawing Γ'_L , which is represented by a filled rectangle. (b)-(c) Modifications to Γ in Case 1, assuming that the width of Γ'_L is smaller than or equal to the width of Γ'_R . The drawings Γ'_R and Γ''_R are represented by a shaded and a filled rectangle, respectively. The case in which the height of Γ'_L is smaller than the height of Γ'_R and the case in which the height of Γ'_L is larger than or equal to the height of Γ'_R are represented in (b) and (c), respectively. The arrows show the final translations of the drawings of L , R , and B .

- if $h \geq 2$, then let L , B , and R be the subtrees of $r(T_h)$ rooted at the children of $r(T_h)$ to the left, below, and to the right of $r(T_h)$, respectively; then the 1-2 drawings of L and R in Γ' are congruent, up to a rotation of 180° .

Proof: We prove the statement by induction on h . The statement is trivially true if $h = 1$, as the only (up to translations) planar straight-line orthogonal drawing of T_1 is a 1-2 drawing.

Assume next that $h \geq 2$. We perform a sequence of modifications to Γ , eventually resulting in a 1-2 drawing Γ' as required by the statement.

First, we replace the drawings Γ_L , Γ_B , and Γ_R of L , B , and R in Γ by 1-2 drawings of L , B , and R , respectively; refer to Fig. 8(a). Construct a copy Λ_L of Γ_L and rotate it counterclockwise by 90° ; the children of $r(L)$, if any, are to the left, below, and to the right of $r(L)$ in Λ_L . Inductively construct a 1-2 drawing Γ'_L of L such that the left and right widths of Γ'_L are both equal to a value ν which is smaller than or equal to the minimum between the left and right widths of Λ_L , and such that the height of Γ'_L is smaller than or equal to the height of Λ_L . Rotate Γ'_L clockwise by 90° . We now replace Γ_L by Γ'_L so that the rightmost vertical line intersecting Γ'_L coincides with the rightmost vertical line intersecting Γ_L and so that $r(L)$ is on the horizontal line through $r(T_h)$. This replacement does not increase (and possibly decreases) the left width and the height of Γ . The right width of Γ is not altered by the modification. Note that, after the rotation and the replacement, the top and bottom heights of Γ'_L are equal. The replacements of Γ_B and Γ_R by 1-2 drawings Γ'_B and Γ'_R are performed similarly (actually the replacement of Γ_B by Γ'_B does not require any rotations).

Since Γ (even after the above modification) satisfies the subtree separation property and since $r(L)$ and $r(B)$ are to the left and below $r(T_h)$, respectively, there is a horizontal line (not necessarily a grid row) having Γ'_L above and Γ'_B below, or there is a vertical line (not necessarily a grid column) having Γ'_L to the left and Γ'_B to the right. Possibly both such lines exist. Analogously, there is a horizontal line having Γ'_R above and Γ'_B below, or there is a vertical line having Γ'_R to the right and Γ'_B to the left. We distinguish four cases.

Case 1: There is a horizontal line ℓ_h having Γ'_L and Γ'_R above and Γ'_B below. We first make the drawings of L and R congruent, up to a rotation of 180° . This is done as follows (refer to Figs. 8(b) and 8(c)). Assume that the width of Γ'_L is smaller than or equal to the width of Γ'_R ; the case in which the width of Γ'_R is smaller than the width of Γ'_L is dealt with symmetrically. We construct a copy of Γ'_L and rotate it by 180° ; denote by Γ''_R the resulting drawing. We replace Γ'_R by Γ''_R , so that so that the leftmost vertical line intersecting Γ''_R coincides with the leftmost vertical line intersecting Γ'_R and so that $r(R)$ is on the horizontal line through $r(T_h)$. Because of the assumption on the widths of Γ'_L and Γ'_R , this modification does not increase the width of Γ . Further, since the top and bottom heights of Γ'_L are equal and the same is true for the top and bottom heights of Γ'_R , the modification does not increase the height of Γ . In particular, if the height of Γ'_L is smaller

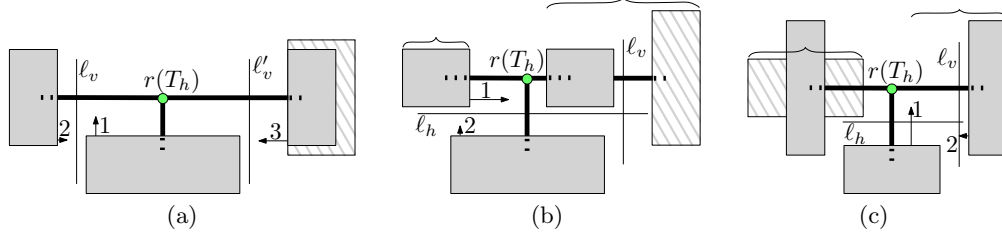

Fig. 9. (a) Modifications to Γ in Case 2, assuming that the width of Γ'_L is smaller than or equal to the width of Γ'_R . (b) Modifications to Γ in Case 3, assuming that the width of Γ'_L is smaller than or equal to the right width of Γ . (c) Modifications to Γ in Case 3, assuming that the width of Γ'_L is larger than the right width of Γ .

than the height of Γ'_R , as in Fig. 8(b), then the height of Γ decreases, while if the height of Γ'_L is larger than or equal to the height of Γ'_R , as in Fig. 8(c), then the height of Γ stays unchanged.

Finally, we act on the distances between the drawings of L , R , and B . We translate the drawing of L rightwards, so that the rightmost vertical line intersecting it is one unit to the left of $r(T_h)$, we translate the drawing of R leftwards, so that the leftmost vertical line intersecting it is one unit to the right of $r(T_h)$, and we translate the drawing of B upwards, so that the topmost horizontal line intersecting it is one unit below the bottommost horizontal line intersecting the drawing of L . This results in a 1-2 drawing Γ' with the required properties; note that Γ' arranges 1-2 drawings of L , B , and R as in Construction 2.

Case 2: There are a vertical line ℓ_v having Γ'_L to the left and Γ'_B to the right and a vertical line ℓ'_v having Γ'_B to the left and Γ'_R to the right. Refer to Fig. 9(a). We first make the drawings of L and R congruent, up to a rotation of 180° , as in Case 1. We now translate the drawing of B upwards, so that the topmost horizontal line intersecting it is one unit below $r(T_h)$, we then translate the drawing of L rightwards, so that the rightmost vertical line intersecting it is one unit to the left of the leftmost vertical line intersecting the drawing of B , and we finally translate the drawing of R leftwards, so that the leftmost vertical line intersecting it is one unit to the right of the rightmost vertical line intersecting the drawing of B . This results in a 1-2 drawing Γ' with the required properties; note that Γ' arranges 1-2 drawings of L , B , and R as in Construction 1.

Case 3: There are a horizontal line ℓ_h having Γ'_L above and Γ'_B below and a vertical line ℓ_v having Γ'_R to the right and Γ'_B to the left. In order to replace Γ'_L or Γ'_R with a rotated copy of the other one, we need to follow a different strategy than in Cases 1 and 2. In fact, rather than comparing the width of Γ'_L with the width of Γ'_R , as we did in Cases 1 and 2, we now compare the width of Γ'_L with the right width of Γ . The reason for this is that, if the width of Γ'_R is smaller than the width of Γ'_L , we cannot just replace Γ'_L with a rotated copy Γ''_L of Γ'_R so that the rightmost vertical lines intersecting Γ'_L and Γ''_L coincide, as this might create intersections between Γ''_L and Γ'_B .

If the width of Γ'_L is smaller than or equal to the right width of Γ , as in Fig. 9(b), then we construct a copy of Γ'_L and rotate it by 180° ; denote by Γ''_R the resulting drawing. We replace Γ'_R by Γ''_R , so that the leftmost vertical line intersecting Γ''_R is one unit to the right of $r(T_h)$ and so that $r(R)$ is on the horizontal line through $r(T_h)$. Because of the assumption on the width of Γ'_L and on the right width of Γ , this modification does not increase the width of Γ . Note that Γ''_R does not cross Γ'_B since ℓ_h has Γ'_L above and Γ'_B below and since the top and bottom heights of Γ'_L are equal. The construction of Γ' is completed by translating the drawings of L and B as in Case 1.

If the width of Γ'_L is larger than the right width of Γ , as in Fig. 9(c), then we construct a copy of Γ'_R and rotate it by 180° ; denote by Γ''_L the resulting drawing. We replace Γ'_L by Γ''_L , so that the rightmost vertical line intersecting Γ''_L is one unit to the left of the leftmost vertical line intersecting Γ'_B and so that $r(L)$ is on the horizontal line through $r(T_h)$. Because of the assumption on the width of Γ'_L and on the right width of Γ , and since the left width and the right width of Γ'_B are equal, we have that this modification does not

increase the width of Γ . The construction of Γ' is completed by translating the drawings of B and R as in Case 2.

Case 4: There are a horizontal line ℓ_h having Γ'_R above and Γ'_B below and a vertical line ℓ_v having Γ'_L to the left and Γ'_B to the right. This case can be discussed symmetrically to Case 3. This concludes the proof of the lemma. \square

Lemma 3 immediately implies the following.

Theorem 4. *For any positive integer h , there is a 1-2 drawing of the complete ternary tree T_h with height h achieving minimum area among all the planar straight-line orthogonal drawings of T_h satisfying the subtree separation property.*

Proof: Consider any planar straight-line orthogonal drawing Γ of T_h satisfying the subtree separation property. If the children of $r(T_h)$ are to the left, below, and to the right of $r(T_h)$ in Γ , then Lemma 3 can be applied in order to construct a 1-2 drawing Γ' of T_h whose width and height are at most equal to the width and height of Γ , respectively. If the children of $r(T_h)$ are not to the left, below, and to the right of $r(T_h)$ in Γ , then Γ can be rotated clockwise by 90° , 180° , or 270° so that they are, and then Lemma 3 can be applied in order to construct a 1-2 drawing Γ' of T_h whose width and height are at most equal to the width and height of the rotated drawing Γ . \square

3.3 Computing Minimum-Area 1-2 Drawings

Theorem 4 motivates the study of 1-2 drawings. In this section we perform an experimental evaluation of the area requirements of 1-2 drawings. This is mainly possible due to the following theorem.

Theorem 5. *A minimum-area 1-2 drawing of a complete ternary tree can be computed in polynomial time.*

The proof of Theorem 5 is based on the following strategy³, which resembles the approach proposed in [9] in order to compute minimum-area *LR-drawings* of binary trees.

For any value of h we aim at computing all the *Pareto-optimal* width-height pairs (ω, η) for the 1-2 drawings of T_h ; these are the pairs such that: (i) T_h admits a 1-2 drawing with width ω and height η ; and (ii) there exists no pair (ω', η') such that T_h admits a 1-2 drawing with width ω' and height η' , where $\omega' \leq \omega$, $\eta' \leq \eta$, and at least one of these inequalities is strict.

In the following lemma, we bound the number of Pareto-optimal width-height pairs.

Lemma 4. *There are $O(n)$ Pareto-optimal width-height pairs for the 1-2 drawings of a complete ternary tree with n nodes.*

Proof: The statement comes from the following two observations.

First, for any integer value ω there is at most one Pareto-optimal pair (ω, η) .

Second, any Pareto-optimal pair (ω, η) has $\omega \leq n$, as any 1-2 drawing with width greater than n has a grid column not containing any vertex; then the part of the drawing to the right of such a grid column can be moved one unit to the left, resulting in a 1-2 drawing with the same height and with smaller width. \square

Next, we show how to compute all the Pareto-optimal width-height pairs in polynomial time.

Lemma 5. *The Pareto-optimal width-height pairs for the 1-2 drawings of T_h can be computed in polynomial (in the number of nodes of T_h) time.*

³ We claim that Theorem 5 can be generalized to ternary trees that are not necessarily complete. However, since our main interest in 1-2 drawings comes from the study of the area requirements of complete ternary trees, we opted for keeping the exposition simple and present the theorem and its proof for complete ternary trees only.

Proof: In this proof by *pair* we always mean Pareto-optimal width-height pair. Suppose that the pairs for the 1-2 drawings of T_{h-1} have been computed already (note that $(1, 1)$ is the only pair for the 1-2 drawings of T_1). We compute the pairs for the 1-2 drawings of T_h by considering all the possible triples (p_l, p_b, c) where $p_l = (\omega_l, \eta_l)$ and $p_b = (\omega_b, \eta_b)$ are pairs for the 1-2 drawings of T_{h-1} and c is either 1 or 2. By Lemma 4 there are $O(n)$ pairs for the 1-2 drawings of T_{h-1} , hence there are $O(n^2)$ such triples. For each triple (p_l, p_b, c) we consider the 1-2 drawing Γ_h defined as follows:

- Γ_{h-1}^a is a 1-2 drawing with width ω_b and height η_b ;
- Γ_{h-1}^b is a 1-2 drawing with width ω_l and height η_l , clockwise rotated by 90° ; note that, after the rotation, Γ_{h-1}^b has width η_l and height ω_l ;
- Γ_{h-1}^c is a 1-2 drawing with width ω_l and height η_l , counterclockwise rotated by 90° ; note that, after the rotation, Γ_{h-1}^c has width η_l and height ω_l ;
- Γ_{h-1}^a , Γ_{h-1}^b , and Γ_{h-1}^c are arranged as in Construction *c*.

The width and height of Γ_h can be computed in $O(1)$ time by Properties 1 and 2.

Out of the $O(n^2)$ 1-2 drawings of T_h constructed as above we only keep the $O(n)$ drawings corresponding to Pareto-optimal width-height pairs – it comes again from Lemma 4 that there are this many Pareto-optimal width-height pairs. This can be accomplished in polynomial time by ordering the $O(n^2)$ width-height pairs by increasing width and, secondarily, by increasing height, and by removing every width-height pair that is preceded by a pair with smaller or equal height.

The correctness of the described algorithm follows by Lemma 3. In particular, the algorithm uses, in every constructed drawing of T_h , two drawings for the left and right subtrees of $r(T_h)$ that are congruent, up to a rotation of 180° , which can be done without loss of generality by Lemma 3. Further, the algorithm constructs the Pareto-optimal pairs for the 1-2 drawings of T_h starting from the Pareto-optimal pairs for the 1-2 drawings of T_{h-1} . This is also not a loss of generality, as any 1-2 drawing of T_{h-1} which does not correspond to a Pareto-optimal pair can be replaced by a (possibly rotated) 1-2 drawing of T_{h-1} which corresponds to a Pareto-optimal pair, without increasing the width and height of the drawing of T_h ; the existence of such a drawing again follows by Lemma 3. \square

Lemmata 4 and 5 imply Theorem 5, as the minimum area for a 1-2 drawing of T_h is equal to $\min\{\omega \cdot \eta\}$, where the minimum is taken over all the Pareto-optimal width-height pairs (ω, η) for the 1-2 drawings of T_h .

We run a mono-thread C implementation of the algorithm that computes the Pareto-optimal width-height pairs for the 1-2 drawings of T_h described in the proof of Lemma 5 on a machine with two 4-core 3.16GHz Intel(R) Xeon(R) CPU X5460 processors, with 48GB of RAM, running Ubuntu 14.04.2 LTS. We could compute the Pareto-optimal width-height pairs (ω, η) and the minimum area for the 1-2 drawings of T_h with h up to 20. The computation of the pairs for $h = 20$ took roughly 5 days. The table below shows the value of h , the corresponding value of n , which is $(3^h - 1)/2$, and the minimum area required by any 1-2 drawing (and by Theorem 4 by any planar straight-line orthogonal drawing satisfying the subtree separation property) of T_h .

h	1	2	3	4	5	6	7	8	9	10
n	1	4	13	40	121	364	1093	3280	9841	29524
Area	1	6	25	99	342	1184	4030	13320	44457	144690
h	11	12	13	14	15	16	17	18	19	20
n	88 573	265 720	797 161	2 391 484	7 174 453	21 523 360	64 570 081	193 710 244	581 130 733	1 743 392 200
Area	469 221	1 520 189	4 840 478	15 550 542	49 461 933	157 388 427	498 895 215	1 580 110 511	4 990 796 080	15 765 654 805

By means of the Mathematica software [18] we searched for the function of the form $a \cdot n^b + c$ that better fits the values of the table above, according to the least squares optimization method. The optimal function we got is $3.3262 \cdot x^{1.047} - 181\,209.1337$. While the large absolute value of the additive constant suggests the need for a lower order term or for a different optimization method, the experimentation also seems to indicate that planar straight-line orthogonal drawings with the subtree separation property cannot be constructed within almost-linear area. We hence state the following conjecture.

Conjecture 1. There exists a constant $\varepsilon > 0$ such that n -node complete ternary trees require $\Omega(n^{1+\varepsilon})$ area in any planar straight-line orthogonal drawing satisfying the subtree separation property.

4 Lower Bound for the Minimum Side Length

In this section we show that the minimum side length of any planar straight-line orthogonal drawing of a complete ternary tree with n nodes is in $\Omega(n^{\log_3 \phi}) \in \Omega(n^{0.438})$, where $\phi = (1 + \sqrt{5})/2$ is the golden ratio. We remark that this lower bound holds true even for drawings that do not satisfy the subtree separation property. Thus, with respect to the minimum side length of a planar straight-line orthogonal drawing, binary and ternary trees are in sharp contrast. Namely, *any* n -node binary tree admits a planar straight-line orthogonal drawing in which the minimum side length is in $O(\log n)$ [5]. We have the following.

Theorem 6. *The minimum side length of any planar straight-line orthogonal drawing of an n -node complete ternary tree is in $\Omega(n^{\log_3((1+\sqrt{5})/2)}) \in \Omega(n^{0.438})$.*

Proof: Let Γ be any planar straight-line orthogonal drawing of the complete ternary tree T_h with height h , as in Fig. 10(a). One of the children of $r(T_h)$, call it v_1 , is such that no other child of $r(T_h)$ is drawn on the line ℓ through $r(T_h)$ and v_1 . Moreover, for $i = 1, 2, \dots, h-2$, the node v_i has exactly one child v_{i+1} drawn on ℓ . Hence, in Γ there is a root-to-leaf path with h nodes that is drawn all on the same (horizontal or vertical) line ℓ , and that is such that no other child of $r(T_h)$ is on ℓ . We call *leg* of Γ such a path. Analogously, in Γ there are two root-to-leaf paths with h nodes each that are both drawn on the same (horizontal or vertical) line. We call *left arm* and *right arm* of Γ such paths, so that the left arm, the leg, and the right arm of Γ occur in this counterclockwise order around $r(T_h)$. Denote by $\gamma(\Gamma)$, $\lambda(\Gamma)$, and $\rho(\Gamma)$ the length of the leg of Γ , the length of the left arm of Γ , and the length of the right arm of Γ , respectively.

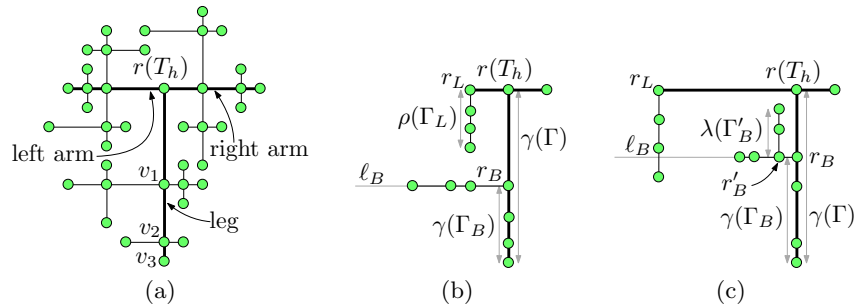

Fig. 10. (a) Leg and arms (shown by thick lines) in a planar straight-line orthogonal drawing of a complete ternary tree T_h . (b) The length of the leg of Γ is greater than or equal to $f(h-1) + f(h-2)$ if ℓ_B lies below the right arm of Γ_L . (c) The length of the leg of Γ is greater than or equal to $f(h-1) + f(h-2)$ if ℓ_B intersects the right arm of Γ_L .

We now define the function $f(h) = \min_{\Gamma} \{\gamma(\Gamma), \lambda(\Gamma), \rho(\Gamma)\}$, where the minimum is taken over all the planar straight-line orthogonal drawings Γ of T_h . Note that $f(h) \geq h$, as every planar straight-line orthogonal drawing of T_h has the leg, the left arm, and the right arm of length at least h .

We claim that, for any $h \geq 3$, we have $f(h) \geq f(h-1) + f(h-2)$. The claim implies the theorem; this comes from the following two observations.

First, consider any planar straight-line orthogonal drawing Γ of T_h . If $r(T_h)$ has two children on the same horizontal line in Γ , then the width of Γ is larger than or equal to $\lambda(\Gamma)$ and the height of Γ is larger than or equal to $\gamma(\Gamma)$. Otherwise, $r(T_h)$ has two children on the same vertical line in Γ , and then the height of Γ is larger than or equal to $\lambda(\Gamma)$ and the width of Γ is larger than or equal to $\gamma(\Gamma)$.

Second, since $f(h) \geq f(h-1) + f(h-2)$, we have that $f(h)$ grows asymptotically as the terms of the Fibonacci sequence; it is known that the ratio between two consecutive terms of the Fibonacci sequence tends to the golden ratio $\phi = (1 + \sqrt{5})/2 \approx 1.618$. Hence $f(h) \in \Omega(\phi^h) \in \Omega(n^{\log_3 \phi}) \in \Omega(n^{0.438})$. Formally, it can be proved by induction that $f(h) \geq k \cdot \phi^h$, for a constant $k > 0$ that is sufficiently small so that $f(h) \geq k \cdot \phi^h$ is verified for $h = 1$ and $h = 2$. By induction, $f(h-1) + f(h-2) \geq k \cdot \phi^{h-1} + k \cdot \phi^{h-2}$. Hence, we need to prove that $k \cdot \phi^{h-1} + k \cdot \phi^{h-2} \geq k \cdot \phi^h$, that is, $\phi^2 - \phi - 1 \leq 0$. Since $\phi = (1 + \sqrt{5})/2$ is one of the solutions to the equation $\phi^2 - \phi - 1 = 0$, it follows that $\phi^2 - \phi - 1 \leq 0$, and hence the induction is completed and $f(h) \geq k \cdot \phi^h \in \Omega(\phi^h)$.

It remains to prove the claim: for any $h \geq 3$, we have $f(h) \geq f(h-1) + f(h-2)$. Consider any planar straight-line orthogonal drawing Γ of T_h . Assume that the children of $r(T_h)$ are to the left, below, and to the right of $r(T_h)$ in Γ ; the other three cases can be discussed symmetrically. Denote by Γ_L , Γ_B , and Γ_R the drawings in Γ of the subtrees of $r(T_h)$ that are rooted at the children r_L , r_B , and r_R that are to the left, below, and to the right of $r(T_h)$, respectively. Then the arms of Γ_L and Γ_R lie on two vertical lines, while the arms of Γ_B lie on a horizontal line ℓ_B .

We prove that $\gamma(\Gamma) \geq f(h-1) + f(h-2)$. We distinguish two cases. In the first case, shown in Fig. 10(b), ℓ_B lies below the right arm of Γ_L . Then $\gamma(\Gamma) \geq \gamma(\Gamma_B) + \rho(\Gamma_L)$. Since $\gamma(\Gamma_B) \geq f(h-1)$ and $\rho(\Gamma_L) \geq f(h-1)$, and since $f(h-1) \geq f(h-2)$, we have $\gamma(\Gamma) \geq f(h-1) + f(h-2)$. In the second case, shown in Fig. 10(c), ℓ_B intersects the right arm of Γ_L . Let r'_B be the child of r_B that is to the left of r_B in Γ and let Γ'_B be the drawing in Γ of the subtree of r_B that is rooted at r'_B . Then $\gamma(\Gamma) \geq \gamma(\Gamma_B) + \lambda(\Gamma'_B)$ (observe that the sum $\gamma(\Gamma_B) + \lambda(\Gamma'_B)$ counts twice the grid line ℓ_B , however does not count the horizontal line through $r(T_h)$). Since $\gamma(\Gamma_B) \geq f(h-1)$ and $\lambda(\Gamma'_B) \geq f(h-2)$, we have $\gamma(\Gamma) \geq f(h-1) + f(h-2)$.

Next, we prove that $\lambda(\Gamma) \geq f(h-1) + f(h-2)$. We again distinguish two cases. If ℓ_B intersects the right arm of Γ_L , then $\lambda(\Gamma) \geq \lambda(\Gamma_B) + \gamma(\Gamma_L)$. Since $\lambda(\Gamma_B) \geq f(h-1)$ and $\gamma(\Gamma_L) \geq f(h-1)$, and since $f(h-1) \geq f(h-2)$, we have $\lambda(\Gamma) \geq f(h-1) + f(h-2)$. Otherwise, ℓ_B lies below the right arm of Γ_L . Let r'_L be the child of r_L that is below r_L in Γ and let Γ'_L be the drawing in Γ of the subtree of r_L that is rooted at r'_L . Then $\lambda(\Gamma) \geq \gamma(\Gamma_L) + \rho(\Gamma'_L)$. Since $\gamma(\Gamma_L) \geq f(h-1)$ and $\rho(\Gamma'_L) \geq f(h-2)$, we have $\lambda(\Gamma) \geq f(h-1) + f(h-2)$.

Finally, the proof that $\rho(\Gamma) \geq f(h-1) + f(h-2)$ is symmetric to the proof that $\lambda(\Gamma) \geq f(h-1) + f(h-2)$. \square

5 Conclusions and Open Problems

In this paper we studied the area requirements of planar straight-line orthogonal drawings of ternary trees. Several problems related to this topic remain open.

Open Problem 1 *Let $f(n)$ be the smallest function such that every n -node ternary tree admits a planar straight-line orthogonal drawing in area $f(n)$. What is the (asymptotic) value of $f(n)$?*

We proved the first sub-quadratic area upper bound for $f(n)$; namely, our bound is $O(n^{1.576})$. For complete ternary trees better area bounds can be achieved, however the following is also open.

Open Problem 2 *Let $g(n)$ be the smallest function such that an n -node complete ternary tree admits a planar straight-line orthogonal drawing in area $g(n)$. What is the (asymptotic) value of $g(n)$?*

We suspect that $f(n)$ and $g(n)$ are super-linear functions of n . In particular, motivated by an extensive experimental analysis, we conjectured in this paper that $g(n)$ (and hence $f(n)$) is in $\Omega(n^{1+\epsilon})$, for some suitable constant ϵ , if one restricts the attention to drawings that satisfy the subtree separation property.

It is interesting that, differently from binary trees, $O(n \text{ polylog}(n))$ area upper bounds cannot be achieved by “squeezing” the drawings in one direction only. Indeed, we proved that an n -node complete ternary tree requires polynomial width *and* height in any planar straight-line orthogonal drawing; our lower bound for the minimum side length of a planar straight-line orthogonal drawing of an n -node complete ternary tree is $\Omega(n^{\log_3 \phi}) \in \Omega(n^{0.438})$, where ϕ is the golden ratio. As a consequence, the following problem seems central to the study of the area requirements of planar straight-line orthogonal drawings of ternary trees.

Open Problem 3 *Does every n -node ternary tree admit a planar straight-line orthogonal drawing in which both the width and the height are in $o(n)$?*

Finally, it is not clear to us whether planar straight-line orthogonal drawings in which one side has length matching our $\Omega(n^{\log_3 \phi})$ lower bound can be achieved for all n -node ternary trees. While we proved that this can be done for n -node complete ternary trees, for general n -node ternary trees our best bound is only $O(n^{0.576})$. Thus, we ask the following.

Open Problem 4 *Does every n -node ternary tree admit a planar straight-line orthogonal drawing in which one side has length in $O(n^{\log_3 \phi})$, where ϕ is the golden ratio?*

Clearly, a positive answer to Open Problem 4 would imply an improved upper bound for the function $f(n)$ from Open Problem 1.

References

1. Ali, A.: Straight line orthogonal drawings of complete ternary trees. Tech. rep., MIT Summer Program in Undergraduate Research Final Paper (July 2015), [HTTPS://MATH.MIT.EDU/RESEARCH/UNDERGRADUATE/SPUR/DOCUMENTS/2015ALI.PDF](https://math.mit.edu/research/undergraduate/spur/documents/2015ali.pdf)
2. Chan, T.M.: Tree drawings revisited. In: Speckmann, B., Tóth, C.D. (eds.) Symposium on Computational Geometry (SoCG '18). LIPIcs, vol. 99, pp. 23:1–23:15. Schloss Dagstuhl - Leibniz-Zentrum fuer Informatik (2018)
3. Chan, T.M., Goodrich, M.T., Kosaraju, S.R., Tamassia, R.: Optimizing area and aspect ratio in straight-line orthogonal tree drawings. *Comput. Geom.* 23(2), 153–162 (2002)
4. Covella, B., Frati, F., Patrignani, M.: On the area requirements of straight-line orthogonal drawings of ternary trees. In: Iliopoulos, C.S., Leong, H.W., Sung, W. (eds.) 29th International Workshop on Combinatorial Algorithms (IWOCOA 2018). LNCS, vol. 10979, pp. 128–140. Springer (2018)
5. Crescenzi, P., Di Battista, G., Piperno, A.: A note on optimal area algorithms for upward drawings of binary trees. *Comput. Geom.* 2, 187–200 (1992)
6. Di Battista, G., Eades, P., Tamassia, R., Tollis, I.G.: *Graph Drawing: Algorithms for the Visualization of Graphs*. Prentice-Hall (1999)
7. Di Battista, G., Frati, F.: Drawing trees, outerplanar graphs, series-parallel graphs, and planar graphs in a small area. In: Pach, J. (ed.) *Thirty Essays on Geometric Graph Theory*, pp. 121–165. Springer-Verlag New York (2013)
8. Frati, F.: Straight-line orthogonal drawings of binary and ternary trees. In: Hong, S., Nishizeki, T., Quan, W. (eds.) *Symposium on Graph Drawing (GD '07)*. LNCS, vol. 4875, pp. 76–87. Springer (2008)
9. Frati, F., Patrignani, M., Roselli, V.: LR-drawings of ordered rooted binary trees and near-linear area drawings of outerplanar graphs. In: Klein, P.N. (ed.) *Symposium on Discrete Algorithms (SODA 2017)*. pp. 1980–1999. SIAM (2017)
10. Garg, A., Rusu, A.: Straight-line drawings of binary trees with linear area and arbitrary aspect ratio. In: Kobourov, S.G., Goodrich, M.T. (eds.) *Symposium on Graph Drawing (GD 2002)*. LNCS, vol. 2528, pp. 320–331. Springer (2002)
11. Garg, A., Tamassia, R.: On the computational complexity of upward and rectilinear planarity testing. *SIAM J. Comput.* 31(2), 601–625 (2001)
12. Nomura, K., Tayu, S., Ueno, S.: On the orthogonal drawing of outerplanar graphs. *IEICE Transactions* 88-A(6), 1583–1588 (2005)
13. Rusu, A.: Tree drawing algorithms. In: Tamassia, R. (ed.) *Handbook of Graph Drawing and Visualization*, chap. 5, pp. 155–192. CRC Press (2016)
14. Rusu, A., Santiago, C.: Grid drawings of binary trees: An experimental study. *J. Graph Algorithms Appl.* 12(2), 131–195 (2008)
15. Shiloach, Y.: *Linear and Planar Arrangement of Graphs*. Ph.D. thesis, Weizmann Institute of Science, Rehovot (February 1976)
16. Shin, C., Kim, S.K., Chwa, K.: Area-efficient algorithms for straight-line tree drawings. *Comput. Geom.* 15(4), 175–202 (2000)
17. Tamassia, R.: On embedding a graph in the grid with the minimum number of bends. *SIAM J. Comput.* 16(3), 421–444 (1987)
18. Wolfram Research Inc.: *Mathematica 10* (2014), [HTTP://WWW.WOLFRAM.COM](http://www.wolfram.com)