

# Optimizing Network Performance for Distributed DNN Training on GPU Clusters: ImageNet/AlexNet Training in 1.5 Minutes

Peng Sun\*, Wansen Feng\*, Ruobing Han\*, Shengen Yan\* and Yonggang Wen†

\*SenseTime Research †Nanyang Technological University, Singapore  
 {sunpeng1, fengwansen, yanshengen}@sensetime.com, ygwen@ntu.edu.sg

## Abstract

It is important to scale out deep neural network (DNN) training for reducing model training time. The high communication overhead is one of the major performance bottlenecks for distributed DNN training across multiple GPUs. Our investigations have shown that popular open-source DNN systems could only achieve 2.5 speedup ratio on 64 GPUs connected by 56 Gbps network. To address this problem, we propose a communication backend named GradientFlow for distributed DNN training, and employ a set of network optimization techniques. First, we integrate ring-based allreduce, mixed-precision training, and computation/communication overlap into GradientFlow. Second, we propose lazy allreduce to improve network throughput by fusing multiple communication operations into a single one, and design coarse-grained sparse communication to reduce network traffic by only transmitting important gradient chunks. When training ImageNet/AlexNet on 512 GPUs, our approach achieves 410.2 speedup ratio and completes 95-epoch training in 1.5 minutes, which outperforms existing approaches.

## 1 Introduction

Deep neural network (DNN) builds models from training data, and uses them to make predictions on new data. It has been used in a wide range of applications, including image recognition, natural language processing and recommender systems. Typically, a DNN model has tens or hundreds of layers, each of which consists of a large number of parameters represented by tensors. To minimize the prediction error, a DNN training task usually uses an iterative-convergent algorithm to iteratively compute gradients from training datasets, and aggregate them with the current version of parameters.

With the ever-increasing sizes of training datasets and bigger models, DNNs are getting more computationally expensive to train on a single node. For example, completing 90-epoch ResNet-50 [1] training on the ImageNet-1K [2] dataset takes 14 days using a single M40 GPU, and takes 29 hours

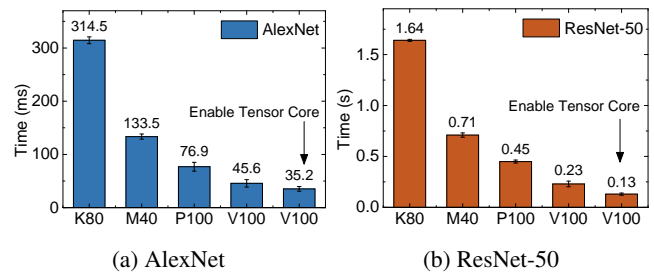

Figure 1: Single-GPU per-iteration training time for AlexNet (batch size 128) and ResNet-50 (batch size 64) measured with CuDNN-7 on K80, M40, P100 and V100 GPUs, which were launched on 2014, 2015, 2016 and 2017, and use Kepler, Maxwell, Pascal and Volta micro-architectures, respectively.

using a machine with 8 NVLink-connected P100 GPUs [3]. This is true even when leveraging high-performance DNN computation libraries like cuDNN [4], which could achieve near the theoretical peak computation performance on GPUs in many cases. Moreover, users often run multiple training tasks to achieve the best result for a specific mission [5]. In this case, extremely long model training time significantly impedes the research and development progress. It has been shown that training time is a key challenge at the root of the development of new DNN architectures [6].

Various distributed DNN systems have been proposed to accelerate model training, such as MxNet [7], PyTorch [8], TensorFlow [9] and Petuum [10], Adam [11] and GeePS [12]. These systems usually adopt data parallelism to parallelize model training across multiple GPUs or multiple machines. In this method, the training dataset is split into  $N$  parts stored on each GPU. During model training, each GPU performs computation on a batch of allocated training dataset, and leverages parameter server [13] or allreduce [14] to exchange its generated gradients with other GPUs via network for updating the DNN model's parameters. This is done iteratively to bring all layers' parameters closer to the optimal values.

A major performance bottleneck of large-scale distributed

DNN training is the high communication overhead due to following factors. First, the computation power of GPU accelerators dramatically increases in recent years, causing bandwidth deficiency. Figure 1 shows that the single-GPU per-iteration processing time of two classic DNNs, AlexNet [15] and ResNet-50 [1], has decreased by 8.9x and 12.6x from 2014 to 2017, respectively. The increasing computation power demands a similar increase in network bandwidth to avoid communication bottleneck. However, upgrading datacenter networks is expensive: network bandwidth on major cloud datacenters and HPC clusters has improved little across generational upgrades [16]. For example, the first HPC cluster built for DNN training incorporates 56Gbps network in 2013 [17], and a recent one uses 100Gbps network in 2018 [18]. Second, DNNs are trending to learn large models with tens or hundreds of millions of parameters, generating a large amount of network traffic for distributed training. Considering the increasing GPU computation power, distributed DNN systems may spend a significant portion of time on communication. For example, when training AlexNet with 61M single-precision parameters, the total amount of data transferred through every GPU is 488MB in each iteration. Even if the communication backend maximizes the throughput of 56Gbps network, each GPU still takes 69.7ms for communication, which could be even longer than the per-iteration computation time (see Figure 1). Third, the communication strategies used in popular distributed DNN systems could not fully utilize cluster network resources. When training AlexNet on a 64 GPU-cluster connected by 56Gbps network, our experiments show that PyTorch, which uses Gloo as its default communication backend, roughly takes 2150ms for communication per iteration, and only utilizes 3.3% of the cluster’s available network bandwidth. Hence, it is important to reduce the communication overhead for training DNNs on large-scale GPU clusters.

A number of approaches have been proposed to reduce the communication cost for distributed DNN. Compared to commodity network (e.g., 1/10Gbps network), high-performance network fabrics like InfiniBand could provide much higher bandwidth (e.g., 56/100 Gbps) for GPUs to exchange gradients [17], [19], [20], [21]. Remote Direct Memory Access (RDMA), GPUDirect RDMA and CUDA-aware MPI further reduce GPU-GPU communication latency by enabling direct data exchange between GPUs on different nodes [22], [23]. When exchanging gradients with ring-based allreduce, the communication cost is constant and independent of the number of GPUs in the system [24], [25]. Model compression approaches represent parameters and gradients with limited numerical precision or sufficient factors, thus reducing data size for transmission [18], [26], [27], [28], [29], [30]. Asynchronous and stale-synchronous parallelisms do not force all GPUs to wait for the slowest one in every iteration, thus reducing the synchronization time in heterogeneous environments [31], [32]. Overlapping the communication of the DNN’s top layers with the computation of bottom layers could

also help to reduce communication time for distributed DNN training [22], [30], [33], [34]. Some distributed DNN systems support to select and transmit important gradients at the level of elements [13], [35], [36], [37], reducing network traffic.

The relative performance characteristics of aforementioned approaches are still unclear. Although each one reports performance results, they are not easily comparable, since their experiments are conducted with different models and on different infrastructures (usually with less than 100 GPUs). Our first goal is to address this issue. Specifically, we implement GradientFlow, a communication library for distributed DNN, with multiple network optimizations (including ring-based allreduce, mixed-precision training, layer-based communication/computation overlap and element-level sparse communication), and integrates it with our internal distributed DNN system. To evaluate the performance, we measure processing throughput to train two classic DNNs, AlexNet and ResNet-50, on the ImageNet-1K dataset using two physical GPU clusters with 56 Gbps network.

Based on the benchmarking results, communication is still a big challenge for distributed DNN. Our second goal is to tackle this problem with following two techniques in GradientFlow: 1) To improve network throughput, we propose lazy allreduce for gradient exchanging. Instead of immediately transmitting generated gradients with allreduce, GradientFlow tries to fuse multiple sequential communication operations into a single one, avoiding sending a huge number of small tensors via network. 2) To reduce network traffic, we design coarse-grained sparse communication. Instead of transmitting all gradients in every iteration, GradientFlow only sends important gradients for allreduce at the level of chunk (for example, a chunk may consist of 32K gradients). GradientFlow imposes momentum SGD correction and warm-up dense training to guarantee model quality. Compared to existing fine-grained sparse communication strategies, e.g., [13], [35], [36], coarse-grained sparse communication could keep high bandwidth utilization by using allreduce with dense inputs.

When training ImageNet/AlexNet, our internal distributed DNN system could achieve 410.2 speedup ratio on 512 GPUs, and complete 95-epoch training in 1.5 minutes. Compared to Jia et al. [18], which finishes 95-epoch ImageNet/AlexNet training in 4 minutes with 1024 GPUs, our work could achieve 2.6x speedup. When training ImageNet/ResNet-50, our approach could achieve 418.5 speedup ratio on 512 GPUs, and complete 90-epoch training in 7.3 minutes. Compared to Akiba et al. [38], which finishes ResNet-50 training in 15 minutes with 1024 GPUs, our work is 2.1x faster.

The rest of this paper is structured as follows. We show the background of distributed DNN, and introduce existing network optimizations for distributed DNN with performance evaluations. in Section 2. Section 3 describes system design of lazy allreduce and coarse-grained sparse communication. The overall evaluation results are detailed in Section 4. Section 5 concludes this paper.

## 2 Distributed DNN Training

In this section, we briefly summarize basic concepts of distributed DNN training. Then, we describe the baseline implementation of a distributed DNN training system. Finally, we show existing network optimizations for distributed DNN training and evaluate their performance.

### 2.1 Background of DNN

DNNs learn models from training data, and use them to make predictions on new data. Typically, a DNN consists of many layers, from as few as 5 to as many as more than 1000 [39]. Figure 2 shows a DNN with 7 layers. In this example, the data layer is in charge of reading and preprocessing input data. The first layer is connected to a sequence of intermediate layers (two convolutional layers, two pooling layers, one innerproduct layer and one loss layer), each of which uses a specific function and a number of parameters to transform its input to an output. Finally, the DNN transforms the raw input data into the desired output or prediction.

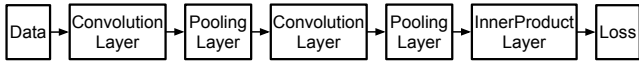

Figure 2: A deep neural network with 7 layers.

To give accurate predictions, most DNNs need to be trained. We use  $W$  to represent all parameters of a DNN. DNN training could be described as an optimization problem: given training dataset  $\mathcal{D}$  with  $m$  examples, it tries to find optimum  $W$  to minimize the objective function  $J(\cdot)$ ,

$$\min_W J(W) = \sum_{i=1}^m f(W, \mathcal{D}_i) + r(W),$$

where  $f(\cdot)$  is the loss function to represent the DNN’s prediction error on one example of training dataset, and  $r(\cdot)$  is the regularizer to limit the learned DNN model’s complexity.

It is common to use an iterative-convergent algorithm and backpropagation (BP) to train DNNs. Each iteration has three sequential phases. 1) The forward pass transforms a batch of input examples into predictions, which would be compared with given labels to calculate prediction error. 2) With respect to this error, the backward pass calculates gradients for each layer’s learnable parameters through BP. 3) In the model update stage, each parameter is updated using its corresponding gradient and a variant of the gradient descent optimization algorithm, such as stochastic gradient descent (SGD).

### 2.2 Data-Parallel Distributed DNN Training

It is hard to finish model training with big training datasets in acceptable time on a single node. To address this issue, many distributed DNN systems, such as TensorFlow and PyTorch,

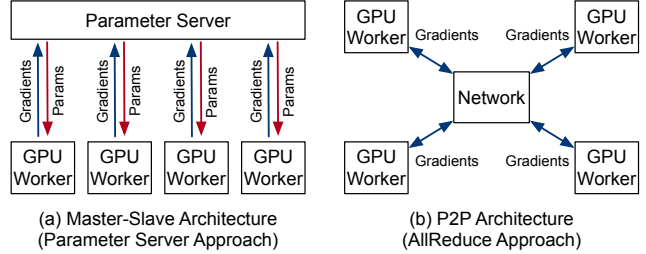

Figure 3: System architectures for distributed DNN. In master-slave architecture, all GPU workers push local gradients to parameter servers for model update, and pull latest parameters. In P2P architecture, every GPU worker communicates with each other to exchange gradients using allreduce.

have been proposed to parallel DNN training in a cluster using data-parallel strategy<sup>1</sup>, where the same model is replicated for every GPU, but is fed with different parts of training data.

As shown in Figure 3, there are two design choices to implement data-parallel DNN training: the parameter server (PS) approach using master-slave architecture and the allreduce approach with P2P architecture. In PS, one or more *server* nodes are set up to centrally manage the model’s parameters. For every iteration, each worker pushes its computed gradients to server nodes for aggregation and model update, and pulls latest parameters from server nodes. In the allreduce approach, all workers directly communicate with each other to exchange local gradients using allreduce operations. After the allreduce operation, every GPU has aggregated gradients, and uses them to update replicated parameters locally.

**Assumptions.** In this paper, we have following assumptions for DNN training in a distributed setting: 1) A single GPU has enough storage capacity to manage a complete replica of the model; 2) Each layer’s parameters and its corresponding gradients could be represented by one or more dense tensors; and 3) Training tasks are deployed in a homogeneous cluster: all GPUs have same computation capacity, and all machines are provided with same network bandwidth.

Considering aforementioned assumptions, we focus on network optimization for allreduce-based DNN training. While PS provides flexible synchronization models (which is useful in heterogeneous environments) and supports extra-big model training, its scalability is limited due to the high communication overhead [22]. Specifically, when using  $M$  server nodes and  $N$  GPU workers in PS, the total amount of data transferred to and from each server node is  $|W|N/M$ . Thus, server nodes can easily be the performance bottleneck in large-scale clusters. Allreduce-based systems avoid this problem by distributing the communication cost across all  $N$  GPU worker.

<sup>1</sup>Model-parallelism is another approach, which is designed to deal with DNN applications with extreme-big models. In this work, we focus on data parallel DNN training.

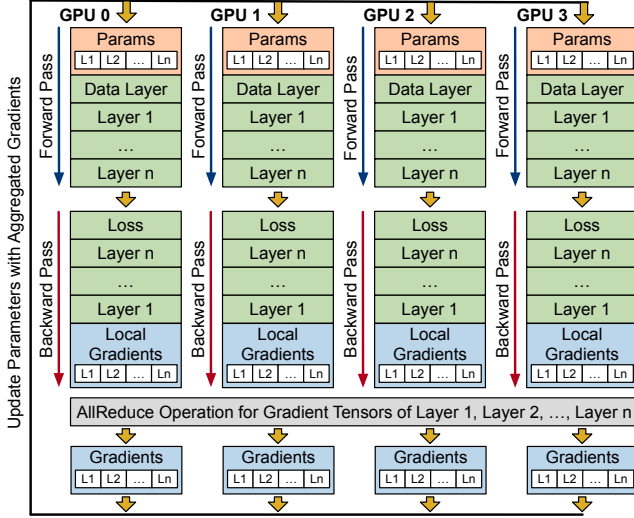

Figure 4: Baseline system for distributed DNN training.

### 2.3 Baseline System Design & Cluster Setting

Figure 4 illustrates the baseline system design for allreduce-based distributed DNN training. In the forward pass, each GPU fetches a batch of training data as input, and processes them through the neural network from layer-1 to layer- $n$ . Assuming each GPU processes  $B$  images per iteration, the training task’s batch size is  $NB$  with  $N$  GPUs. At the end of the forward pass, each GPU outputs a loss value to measure the prediction error. Next, GPUs start backward computation through the neural work from layer- $n$  to layer-1. When completing the backward computation of layer- $i$ , this layer’s gradients are generated for its learnable parameters. Noted that not all layers have learnable parameters, such as ReLu layer and pooling Layer. Some layers may use multiple tensors to represent its parameters and gradients. For instance, convolutional layer writes a *weight* gradient tensor and a *bias* gradient tensor during backward computation. After the backward pass, a set of gradient tensors are generated on every GPU. An allreduce operation is applied to each tensor for gradient aggregation. After the communication stage, each GPU has summed gradients, which could be used to update replicated parameters locally. By default, all parameter and gradient tensors are composed of single-precision (FP32) values in the baseline system.

#### 2.3.1 Benchmarked DNNs

To evaluate system performance, we measure the training time of two classic DNNs, AlexNet and ResNet-50, on the ImageNet-1K dataset, which contains more than 1.2M labeled images and 1000 classes. The neural network structure of AlexNet used in this paper is slightly different with the origin one in [15]. To achieve better model quality, we use the version of AlexNet in [18] with proper batch normaliza-

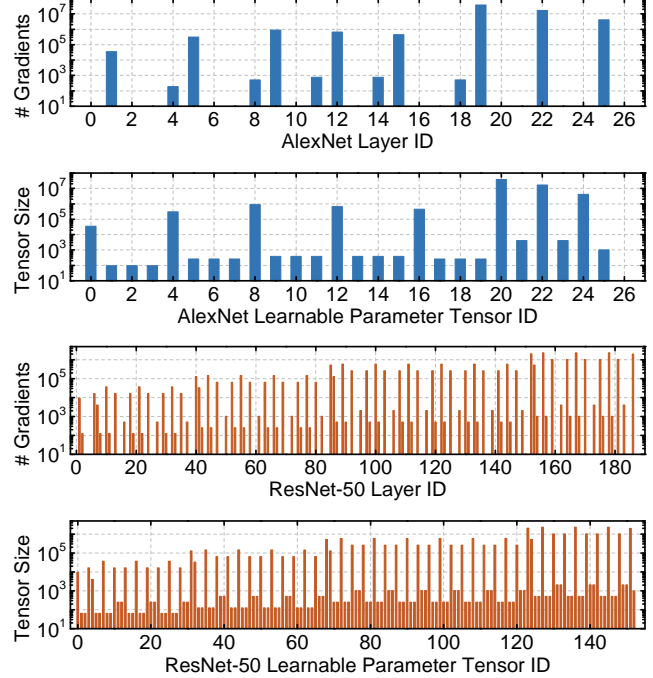

Figure 5: Information of AlexNet and ResNet-50. AlexNet has 27 layers with 60.9M learnable parameters managed by 26 tensors. ResNet-50 has 188 layers with 25.5M learnable parameters managed by 152 tensors.

tion layers. Note that we do not consider synchronized batch normalization in this work. Figure 5 shows the information of AlexNet and ResNet-50. Specifically, AlexNet contains 27 layers with 60.9M learnable parameters. The corresponding values for ResNet-50 are 188 and 25.5M. Since the training system should output a gradient tensor for each learnable parameter tensor, the backward computation generates 26 and 153 gradient tensors for AlexNet and ResNet-50, respectively. In Figure 5, we label learnable parameter tensors with ID in ascending order from layer-1 to layer- $n$ . Since the backward pass performs computation from layer- $n$  to layer-1, gradient tensors are generated in descending order by ID.

#### 2.3.2 Cluster Hardware & Software Setting

We use two clusters for performance measurement: Cluster-P and Cluster-V.

- Cluster-P contains 16 physical machines and 128 GPUs with Pascal microarchitecture.
- Cluster-V contains 64 physical machines and 512 GPUs with Volta microarchitecture. Compared to Pascal GPUs, Volta GPUs could use Tensor Cores to accelerate matrix operations by performing mixed-precision matrix multiply and accumulate calculations in a single operation.

In both clusters, a physical machine is installed with 8 GPUs.

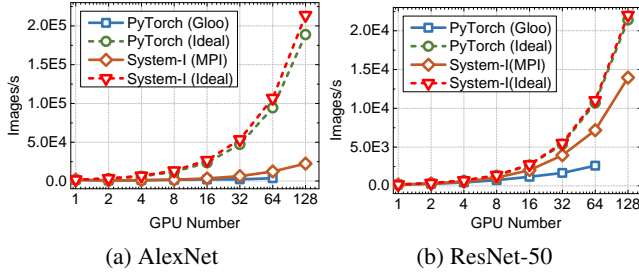

Figure 6: Baseline system (single-precision) performance evaluation in Cluster-P. The per-GPU batch size is 128 and 64 for AlexNet and ResNet-50 respectively.

All GPUs are connected by PCIe in the same machine. All machines of a cluster are connected by 56Gbps InfiniBand, and share a distributed file system, which is used for training dataset management. In this paper, two distributed DNN training systems are used to benchmark different communication strategies: PyTorch-0.4 and our internal system (System-I). Both systems are compiled with Cuda-9.0 and CuDNN-7.2, and use SGD for model training.

### 2.3.3 Baseline System Performance Evaluation

We scale out PyTorch and System-I based on the design shown in Figure 4. In this set of experiments, we use Gloo, the default communication backend of PyTorch, to perform allreduce operations in PyTorch, and use OpenMPI-3.1 in System-I. Both Gloo and OpenMPI support to use RDMA for iter-node communication. Each GPU processes 128 and 64 images at each iteration for AlexNet and ResNet-50, respectively. The two baseline systems perform single-precision training on Cluster-P. Figure 6 shows the performance evaluation results.

PyTorch and System-I have similar processing throughput when training AlexNet and ResNet-50 on a single GPU. Specifically, PyTorch and System-I could respectively process 1475 and 1670 images per second for AlexNet. The corresponding values for ResNet-50 are 167 and 172.

Due to the high communication cost, PyTorch and System-I with the baseline design have poor scalability. When training AlexNet, PyTorch (Gloo) could only process 3.6K images per second using 64 GPUs (with speedup ratio 2.5), and fails to run on 128 GPUs. While System-I (MPI) has better scalability than PyTorch (Gloo), the throughput is 22.3K image/s with 128 GPUs (with speedup ratio 13.1). Since ResNet-50 has less learnable parameters and takes longer forward/backward computation time than AlexNet (see Figure 5), its communication overhead is not as significant as AlexNet. However, there is still a huge performance gap between the ideal system with two baseline implementations. Specifically, the speedup ratio is 15.5 with on GPUs with PyTorch (Gloo), and is 81.2 on 128 GPUs with System-I (MPI), when training ResNet-50.

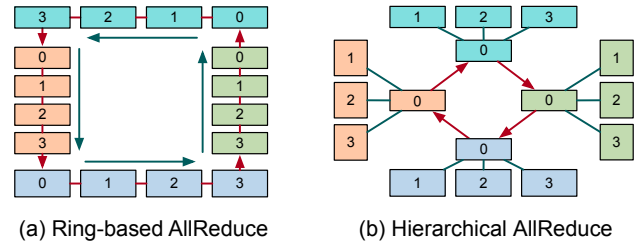

Figure 7: Ring-based allreduce and hierarchical allreduce. In this example, there are 4 machines, each of which has 4 GPUs. In (a), all 16 GPUs are arranged in a logical ring. In (b), the 16 GPUs are partitioned into 4 groups, and only the master GPU of each group constructs a logical ring for allreduce.

## 2.4 Ring-based AllReduce

An efficient allreduce algorithm and implementation is vital for distributed DNN. Ring-based allreduce [24] is an algorithm to performance allreduce with constant communication cost, which is measured by the amount of data transferred to and from every GPU. As shown in Figure 7(a), all  $N$  GPUs is arranged in a logical directed ring, and the  $K$  bytes of input tensor is equally partitioned into  $N$  chunks. Each GPU sends and receives  $K/N$  bytes of data  $2(N-1)$  times to complete an allreduce operation. Thus, the total amount of network traffic through each GPU is  $2(N-1)K/N$ , which is independent of the number of GPUs. In large-scale clusters, the ring-based allreduce algorithm may not fully utilize bandwidth due to small message size. Hierarchical allreduce [18] is proposed to address this issue. As shown in Figure 7(b), this method groups  $N$  GPUs into  $M$  groups, and uses three phases to do allreduce: 1) each group does a reduce to store partial results to its master GPU, 2) a ring-based allreduce is launched on  $M$  master GPUs, after each master GPU gets the final result, and 3) each master GPU do a broadcast within each group to propagate the final result to every GPU. With this method, the message size per send/receive in phase 2 is  $KM/N$  bytes.

We evaluate the performance of ring-based and hierarchical allreduce algorithms on Cluster-P using FP32 tensors as inputs. NCCL is a library of multi-GPU collective communication primitives, and it contains an efficient implementation of ring-based allreduce. NCCL-H is our implementation of hierarchical allreduce using NCCL APIs. Figure 8 shows the results. Compared to OpenMPI, NCCL and NCCL-H could significantly improve the performance of allreduce operations. When the input tensor size is greater than 1MB, NCCL outperforms NCCL-H in all test cases. Intra-group reduce and broadcast operations become the performance bottleneck in NCCL-H, since they are not bandwidth optimal. Note that NCCL-H may have better performance than NCCL if the intra-group bandwidth is large enough: for example, GPUs in the same group are connected by NVLink.

We measure the performance of distributed DNN training

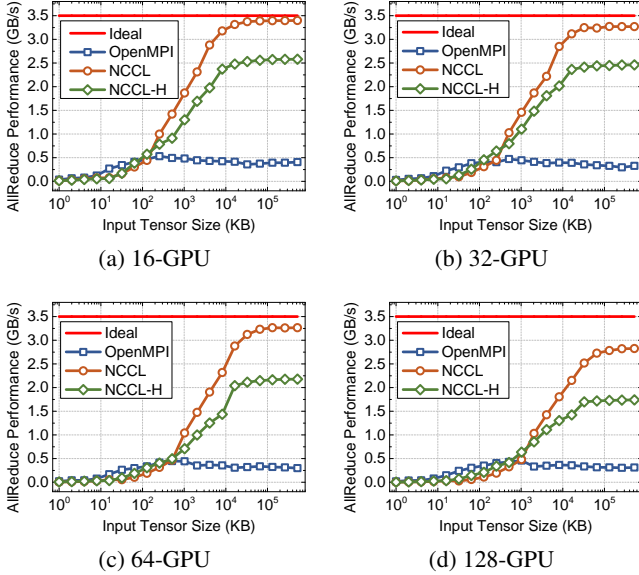

Figure 8: Performance evaluation of FP32 tensor allreduce on Cluster-P with OpenMPI, NCCL and NCCL-H.

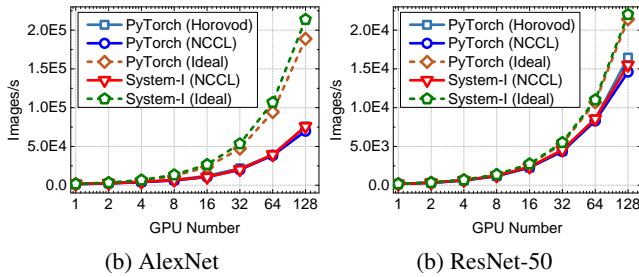

Figure 9: PyTorch and System-I (single-precision) performance evaluation with ring-based allreduce on Cluster-P. The per-GPU batch size is 128 and 64 for AlexNet and ResNet-50.

with ring-based allreduce. In this set of experiments, we use NCCL to perform allreduce in PyTorch and System-I, and measure training throughput on Cluster-P. We also measure the performance of Horovod [34] on PyTorch. In addition to ring-based allreduce, Horovod has other network optimization techniques, such as tensor fusion. Figure 9 shows the results.

Compared to MPI, NCCL could improve the performance of distributed DNN training to a certain degree. PyTorch (NCCL) can respectively process 69.7K and 14.6K images per second for AlexNet and ResNet-50 with 128 GPUs. The corresponding values for System-I (NCCL) are 75.7K and 15.5K. Compared to MPI, NCCL improves the processing throughput by 3.3x and 1.1x for AlexNet and ResNet-50 on System-I. However, even with NCCL, expensive communication operations still significantly reduce the system performance. On 128 GPUs, PyTorch and System-I with NCCL could only achieve 47.1 and 45.3 speedup ratio for AlexNet training, and achieves 87.3 and 90.1 speedup ratio for ResNet-50 train-

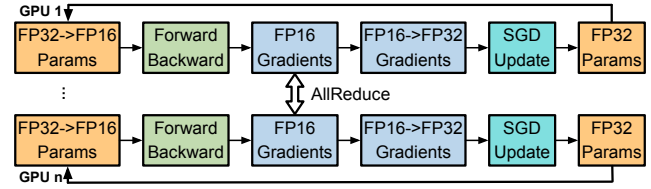

Figure 10: Mixed-precision training uses half-precision gradient tensors as the input of allreduce operations.

ing. While Horovod employs other network optimizations like tensor fusion, it has similar training performance with NCCL. PyTorch (Horovod) could process 75.8K and 16.5K images per second for AlexNet and ResNet-50 training on 128 GPUs. Just using ring-based allreduce could not address the communication challenge of distributed DNN training.

## 2.5 Mixed-Precision Training

Parameters and gradients can be stored in IEEE half-precision (FP16) format instead of single-precision (FP32) format during DNN training. The motivation of using FP16 in the training phase is to lower GPU memory bandwidth pressure, reduce GPU memory storage requirement, and increase arithmetic throughput. Specifically, GPU memory bandwidth pressure and memory storage requirement are reduced since the same number of values could be stored using fewer bits. Half-precision math throughput in GPUs with Tensor Cores is 2x to 8x higher than for single-precision. To avoid accuracy decrease, mixed-precision training [29] is proposed by using FP16 parameters and gradients in forward/backward computation phases, and using FP32 values in model update phase.

Micikevicius et al. [29] runs mixed-precision training on a single GPU. In this paper, we scale mixed-precision training to a distributed setting. Figure 10 shows that the distributed design of mixed-precision training. We can see that mix-precision also helps to reduce communication overhead, since network transmits fewer bits for the same number of gradients. We implement distributed mixed-precision training strategy in System-I and evaluate its performance on Cluster-P and Cluster-V. When training ResNet-50, Cluster-P only supports 64 per-GPU batch size with FP32 training, and supports 128 per-GPU batch size with mixed-precision training due to reduced memory usage. In this set of experiments, for a fair comparison, the per-GPU batch size is 64 on Cluster-P with mixed-precision training. In addition, we use NCCL as the communication backend. Figure 11 shows the results.

Compared to FP32 training, mixed-precision training improves system performance on a single GPU. The single-GPU training throughput (images/s) of AlexNet increases to 1.9K from 1.7K on a Pascal GPU, and increases to 3.7K from 2.9K on a Volta GPU. The performance gain of mixed-precision training is not significant for AlexNet, since AlexNet needs to perform 60.9M FP32-to-FP16 and 60.9M FP16-to-FP32 con-

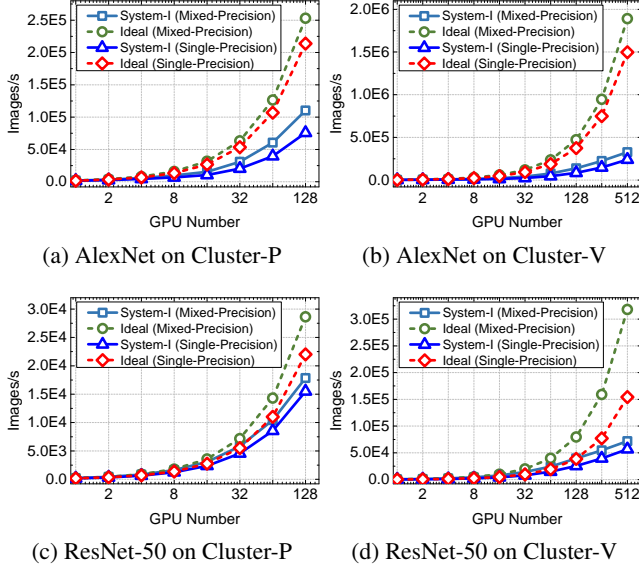

Figure 11: System-I performance evaluation on Cluster-P and Cluster-V using single- and mixed-precision training and NCCL. On Cluster-P, the per-GPU batch size is 128 and 64 for AlexNet and ResNet-50, respectively. On Cluster-V, the per-GPU batch size is 128 for both AlexNet and ResNet-50.

ventions. When training ResNet-50, the single-GPU throughput increases to 223 images/s from 172 images/s on Pascal GPU, and increases to 621 images/s from 301 images/s on Volta GPU with the help of Tensor Core.

Although mix-precision training reduces half of network traffic, the communication overhead is still significant for both AlexNet and ResNet-50 training, as shown in Figure 11. When training AlexNet and ResNet-50 with 128 Pascal GPUs, System-I (mixed-precision) only achieves 55.8 and 79.7 speedup ratio, respectively. When training AlexNet and ResNet-50 with Volta 512 GPUs, System-I (mixed-precision) achieves 88.5 and 115.6 speedup ratio, respectively. We can see that there is still a huge performance gap between System-I with the ideal system with linear speedup ratio.

## 2.6 Computation/Communication Overlap

Distributed DNN training systems can overlap allreduce operations of upper layers with computation of lower layers, reducing dedicated communication time [30]. As mentioned in Section 2.3, when finishing the backward computation of layer- $i$ , this layer’s gradient tensors are immediately generated, and would not be changed by backward computation of layer- $j$ , where  $j < i$ . Thus, we can enforce each layer  $i$  to start its communication once its gradient tensors are generated. The time spent on this layer’s allreduce operation could be overlapped with the backward computation time of layer- $j$ , where  $j < i$ , as shown in Figure 12. We call this strategy layer-based computation/communication overlap.

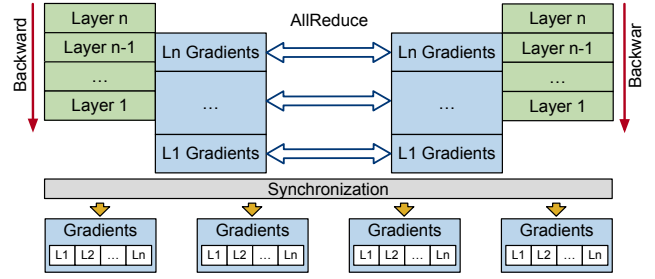

Figure 12: Layer-based computation/communication overlap. In this method, upper layer’s communication operations could be overlapped with lower layers’ computation operations, thus reducing dedicated communication time of an iteration.

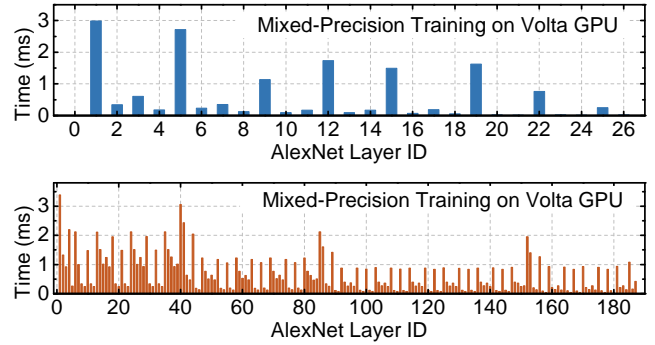

Figure 13: Single-GPU, per-layer backward computation time of AlexNet and ResNet-50 on a single Volta GPU.

Both AlexNet and ResNet-50 can benefit from layer-based computation/communication overlap. Figure 13 illustrates the average backward computation time of each layer on Volta GPU with mixed-precision training method. For AlexNet with 27 layers, the top 8 layers generate 96.2% of gradients, and consumes 7.1% of backward computation time. For ResNet-50 with 188 layers, the top 20 layers generate 56.3% of gradients, and consumes 8.9% of backward computation time. Thus, it is possible to reduce dedicated communication time by overlapping upper layers’ communication with lower layer’s computation. We implement layer-based computation/communication overlap in System-I, and measure its performance on Cluster-P and Cluster-V. We use mixed-precision training and NCCL in this set of experiments.

Layer-based computation/communication overlap only improves the performance of distributed DNN training to a certain degree. As shown in Figure 14, when training AlexNet on 512 Volta GPUs, System-I with overlap approach could improve the training throughput by a factor of 1.068 (from 326.7K images/s to 349.1K images/s), compared to System-I with just NCCL and mixed-precision training. The corresponding speedup ratio for ResNet-50 is 1.057 (from 718.2K images/s to 759.9K images/s). System-I, which enables NCCL, mixed-precision training and layer-based computa-

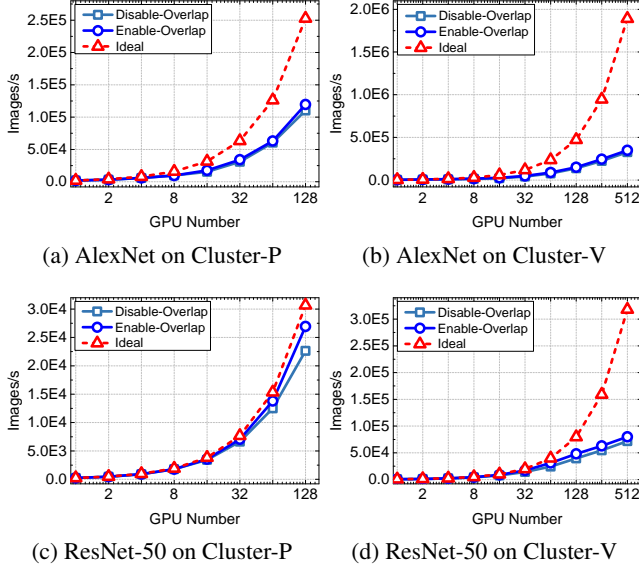

Figure 14: System-I (with mixed-precision training and NCCL) performance evaluation on Cluster-P and Cluster-V using layer-based computation/communication overlap. The per-GPU batch size is 128 for AlexNet and ResNet-50.

tion/communication overlap, could achieve 60.5 and 112.3 speedup ratio for AlexNet and ResNet-50 training on 128 Pascal GPUs, and achieve 94.5 and 134.1 speedup ratio for AlexNet and ResNet-50 training on 512 Volta GPUs. Compared to the ideal system, these achieved speedup ratios for AlexNet and ResNet-50 training are still quite low.

## 2.7 Conclusion

Compared to the MPI-based baseline system design, System-I with ring-based allreduce, mixed-precision training, and computation/communication overlap could respectively improve system throughput by 1.49x and 3.82x for training AlexNet and ResNet-50 on 512 Volta GPUs. However, compared to the ideal system with linear speedup ratio, the communication overhead is still significant, since System-I only achieves 18.5% and 26.2% cluster GPU resource utilization for AlexNet and ResNet-50 training on Cluster-V. There are still two problems not addressed: 1) the network utilization is low when performing allreduce on small gradient tensors; 2) the network traffic is huge when training DNNs with a large number of learnable parameters, such as AlexNet.

## 3 GradientFlow System Design

We propose GradientFlow to tackle the high communication cost of distributed DNN training. GradientFlow is a communication backend for System-I, and supports a number of network optimization techniques, including ring-based allreduce,

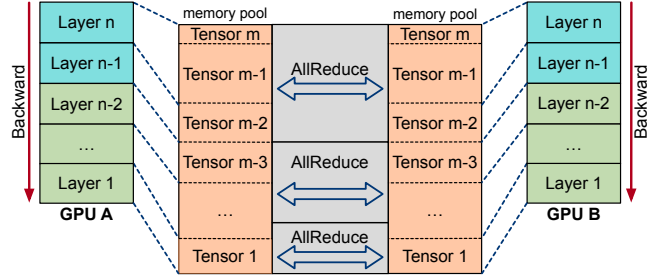

Figure 15: Lazy allreduce would not immediately perform allreduce when a gradient tensor is generated. It tries to fuse multiple allreduce operations into a single one, thus increasing network throughput with large message size. In this example, lazy allreduce overlaps the communication of upper layers with backward computation of lower layers.

mixed-precision training, and computation/communication overlap. To further reduce network cost, GradientFlow employs lazy allreduce to improve network throughput by fusing multiple allreduce operations into a single one, and employs coarse-graining sparse communication to reduce network traffic by only sending important gradient chunks. In this section, we show the workflow of lazy allreduce and coarse-graining sparse communication, and measure their effectiveness.

### 3.1 Lazy AllReduce

Figure 5 shows that AlexNet and ResNet-50 generates a number of small gradient tensors for allreduce in each iteration. We can find that NCCL cannot efficiently utilize available network bandwidth to perform allreduce on these small tensors from Figure 8. To solve this problem, lazy allreduce tries to fuse multiple allreduce operations into a single one with minimal GPU memory copy overhead. Horovod [34] employs gradient fusion strategy for allreduce. However, the indiscriminate fusion results in unnecessary memory copy, resulting in no significant gains in our clusters (see Section 2.4).

When a layer with learnable parameters completes its backward computation, it generates one or more gradient tensors. The baseline system allocates a separated GPU memory space for each tensor. With lazy allreduce, all gradient tensors are placed in a memory pool. As shown in Figure 15, an  $n$ -layer DNN sequentially generates  $m$  gradient tensors during the backward phase of an iteration. The elements of all  $m$  tensors are placed in a memory pool based on their generated order, from tensor- $m$  to tensor-1. The memory pool should manage  $\sum_{i=1}^m \text{sizeof}(\text{tensor-}i)$  FP32 or FP16 gradients in total. When the backward phase computes tensor- $j$ , all its gradients are actually written into the memory pool from offset  $\sum_{i=j+1}^m \text{sizeof}(\text{tensor-}i)$  to offset  $\sum_{i=j}^m \text{sizeof}(\text{tensor-}i)$ .

Instead of immediately performing allreduce for a generated gradient tensor, lazy allreduce would wait for lower layer’s gradient tensors, until the total size of waited tensors



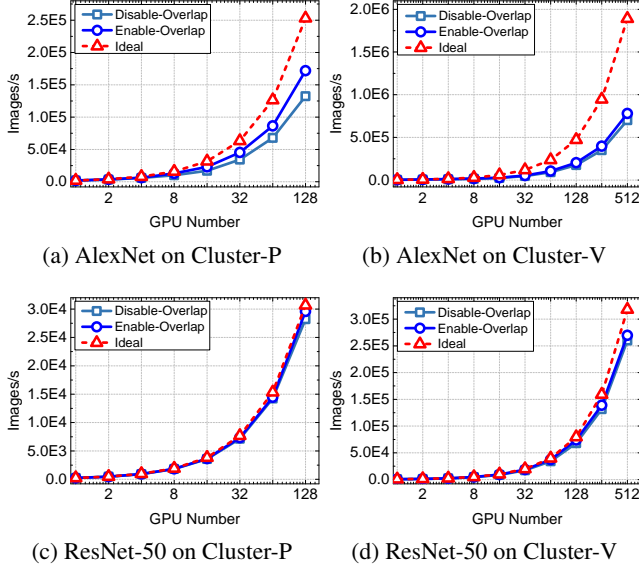

Figure 16: System-I performance evaluation with NCCL, mixed-precision training and lazy allreduce. The per-GPU batch size is 128. In disable-overlap method, System-I performs a single allreduce operation for all gradient tensors after the backward computation. In enable-overlap method, System-I performs multiple allreduce operations, and could overlap parts of communication with computation.

is greater than a given threshold  $\theta$ . Then, we perform a single allreduce operation on all waited gradient tensors. Lazy allreduce thus avoids transmitting small tensors via network and improves network utilization. Since we place all gradient tensors in a memory pool based on their generation order, lazy allreduce could directly perform fused allreduce on the memory pool, without additional memory copy cost.

We implement lazy allreduce in System-I and evaluate its performance on Cluster-P and Cluster-V along with ring-based allreduce (implemented by NCCL) and mixed-precision training. There are two settings in this set of experiments: disable-overlap and enable-overlap. In disable-overlap setting, System-I uses a large communication threshold  $\theta$ , and performs a single allreduce operation for all gradient tensors after backward phase. In enable-overlap setting, System-I selects a proper communication threshold  $\theta$ , and could overlap parts of allreduce operations with backward computation. Figure 16 shows the results.

Compared to System-I with NCCL, mixed-precision training and computation/communication overlap, System-I with lazy allreduce (enable-overlap) speeds up AlexNet training by 1.2x (from 110.3K images/s to 132.3K images/s) on 128 Pascal GPUs, as shown in Figure 16(a)(b). The corresponding speedup ratio is 2.1 (from 326.7K images/s to 701.1K images/s) for AlexNet training on 512 Volta GPUs. Since AlexNet generates a huge number of network traffic, System-I still has a huge performance gap with the ideal system even

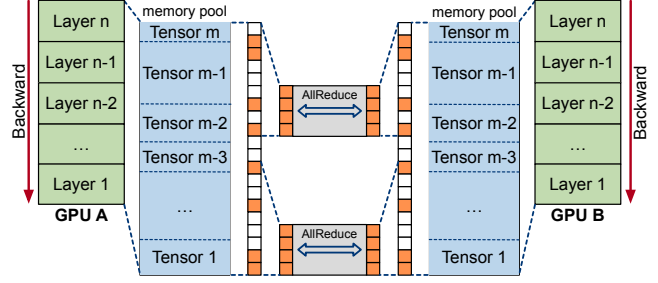

Figure 17: Design of coarse-grained sparse communication (CSC). The gradient memory pool is equally partitioned into a number of small chunks. GPUs could select same important chunks, and copy them into a buffer for allreduce using NCCL. In this example, CSC overlaps the communication of upper layers with backward computation of lower layers.

with lazy allreduce. In particular, System-I only achieves 211.3 speedup ratio on 512 Volta GPUs for AlexNet training.

Lazy allreduce significantly improves ResNet-50 training performance by avoiding transmitting small messages. Lazy allreduce (disable-overlap) helps System-I to process 28.2K images per second with 117.7 speedup ratio on 128 Pascal GPUs. The throughput of System-I with lazy allreduce (disable-overlap) is 260.0K images/s with 418.5 speedup ratio on 512 Volta GPUs. If we select a proper communication threshold  $\theta$  and enable computation/communication overlap, System-I could process 29.6K images per second with 123.5 speedup ratio on 128 Pascal GPUs, and processes 269.5K images with 434.1 speedup ratio on 512 Volta GPUs.

### 3.2 Coarse-Grained Sparse Communication

Deep gradient compression [36] uses fine-grained sparse communication (FCS) to reduce network traffic: only gradients greater than a threshold are selected for transmission. FCS can reduce up to 99.9% traffic without losing accuracy. However, FCS runs sparse allreduce with high computation cost and low network utilization, resulting in no significant gains on our clusters. More specifically, each GPU selects different gradients for transmission in FCS, and stores selected values in  $k-v$  format. Given a sparse allreduce operation, each GPU uses its own selected  $k-v$  pairs as input. During allreduce, when a GPU receives a list of  $k-v$  pairs, it accumulates them with its own  $k-v$  pairs, and sends out new  $k-v$  data. Compared to dense algebra operations, these sparse accumulation operations are quite expensive, especially on GPUs. It is also time-consuming to packet a list of  $k-v$  pairs into a buffer for transmission due to the data structure traversal cost and memory copy cost. Our experiments show that an implementation of FCS cannot perform better than NCCL on a physical cluster with 56Gbps network.

We propose coarse-grained sparse communication (CSC) to reduce network traffic with high bandwidth utilization by

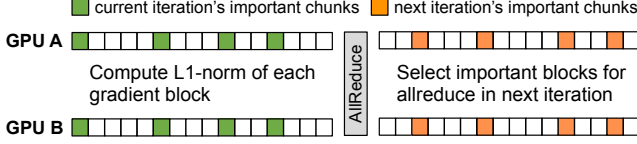

Figure 18: Design of coarse-grained sparse communication.

selecting important gradient chunks for allreduce. Figure 17 shows the system design of CSC. In CSC, the generated  $m$  tensors are also placed in a memory pool with continuance address space based on their generated order. CSC equally partitions the gradient memory pool into chunks, each of which contains a number of gradients. In this work, each chunk contains 32K gradients. In this case, CSC partitions the gradient memory pool of AlexNet and ResNet-50 into 1903 and 797 chunks respectively. A percent (e.g., 10%) of gradient chunks are selected as important chunks at the end of each iteration. Note that all GPUs should communicate with each other to select same important chunks. CSC also relies on lazy allreduce to avoid transmitting small messages over network. Specifically, when a layer finishes its backward computation, its gradients are written into the corresponding position of the gradient memory pool. If an important chunk is filled, CSC copies its data to a buffer. When the buffer size is greater than a given threshold, CSC starts an allreduce operation using this buffer as input. Since all GPUs select same important chunks, CSC could directly use NCCL to accumulate and broadcast gradients in important chunks with low computation cost and high bandwidth utilization.

---

#### Algorithm 1: Momentum SGD Correction

---

- 1  $g_t$ : a gradient computed on  $t$ -th iteration;
  - 2  $u_t$ : a update computed on  $t$ -th iteration;
  - 3  $w_t$ : a weight computed on  $t$ -th iteration;
  - 4  $hg_t$ : a historical gradient computed on  $t$ -th iteration;
  - 5  $hu_t$ : a historical update computed on  $t$ -th iteration;
  - 6 **In AllReduce Preprocess Step:**
  - 7  $g_t = g_t + hg_{t-1}$ ;
  - 8 **if** this gradient tensor is important **then**
  - 9      $hg_t = 0$ ;
  - 10 **else**
  - 11      $hg_t = \text{momentum} * g_t$ ;
  - 12 **In SGD Update Step:**
  - 13 **if** this gradient tensor is important **then**
  - 14      $u_t = hu_t = \text{momentum} * hu_{t-1} + \text{learningrate} * g_t$ ;
  - 15      $w_t = w_t + u_t$ ;
  - 16 **else**
  - 17      $hu_t = hu_{t-1}$ ;
- 

Figure 18 shows important chunk selection strategy. After the completion of gradient allreduce operations, each GPUs

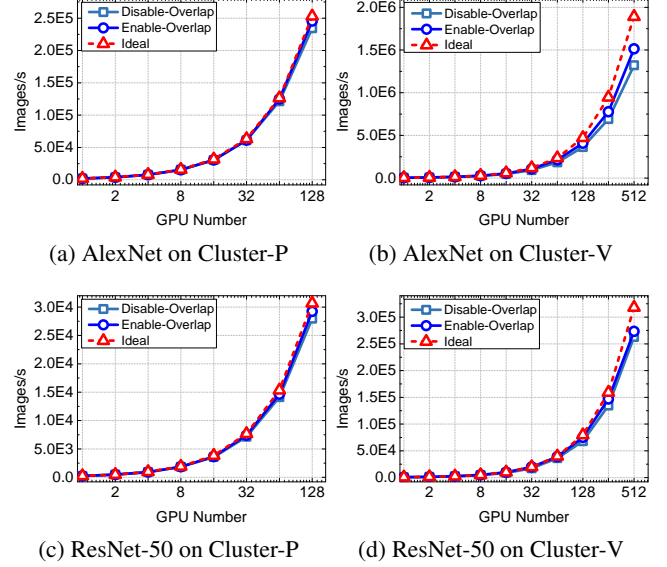

Figure 19: System-I performance evaluation with NCCL, mixed-precision training and coarse-grained sparse communication. The per-GPU batch size is 128. In disable-overlap method, System-I performs a single allreduce operation for all selected gradient chunks. In enable-overlap method, System-I performs multiple allreduce operations, and could overlap parts of communication with computation.

have the same gradients located in important chunks, and keep their own gradients located in other chunks. Then, every GPU computes L1 norm for each chunk. If a chunk is selected as an important chunk in this iteration, an additional computation is needed to divide its L1 norm by the number of GPUs. CSC next performs an allreduce operation for GPUs to exchange and accumulate these L1 norm values. Finally, GPUs could select a percent of chunks with the largest L1 norms, and mark them as important chunks for the next iteration.

CSC employs momentum SGD correction and warm-up dense training to avoid losing model accuracy.

**Momentum SGD Correction.** Algorithm 1 the momentum SGD correction algorithm. Given a gradient  $g_t$  computed on  $t$ -th iteration, if it is not located in an important chunk, its value is stored as a historical value:  $hg_t = \text{momentum} * g_t$ . In the following iteration, historical gradients would be accumulated with newly computed gradients before allreduce:  $g_t = g_t + hg_{t-1}$ . In this way, SCS does not lose any learned information. In momentum SGD update step, if  $g_t$  is not in an important chunk, it would not generate an update  $u_t$  for updating its corresponding weight  $w_t$ . Note that the historical update  $hu_t$  keeps unchanged with  $hu_{t-1}$ .

**Warm-Up Dense Training.** In early iterations of training, DNN parameters rapidly change with more aggressive gradients. If we limit the exchange of these aggressive gradients using sparse communication, the DNN training process may have wrong optimization direction. We adopt the warm-up

Table 1: Compare AlexNet training throughput (image/s) and speedup ratio with different network optimizations using System-I on Cluster-P (128 Pascal GPUs) and Cluster-V (512 Volta GPUs). MP: Mixed-Precision Training; LA: Lazy AllReduce; CSC: Coarse-Grained Sparse Communication; Overlap: Computation/Communication Overlap.

	MPI	NCCL	NCCL+MP	NCCL+MP +Overlap	NCCL+MP +LA+Overlap	NCCL+MP+LA +CSC+Overlap
Cluster-P	22.3K (1x)	75.7K (3.4x)	110.3K (4.9x)	119.5K (5.4x)	172.8K (7.7x)	245.4K (11.0x)
Cluster-V	56.2K (1x)	240.0K (4.3x)	326.7K (5.8x)	349.1K (6.2x)	780.3K (13.9x)	1514.3K (26.9x)

Table 2: Compare ResNet-50 training throughput (image/s) and speedup ratio with different network optimizations using System-I on Cluster-P (128 Pascal GPUs) and Cluster-V (512 Volta GPUs). MP: Mixed-Precision Training; LA: Lazy AllReduce; CSC: Coarse-Grained Sparse Communication; Overlap: Computation/Communication Overlap.

	MPI	NCCL	NCCL+MP	NCCL+MP +Overlap	NCCL+MP +LA+Overlap	NCCL+MP+LA +CSC+Overlap
Cluster-P	13.9K (1x)	15.5K (1.1x)	17.8K (1.3x)	26.9K (1.9x)	29.6K (2.1x)	29.6K (2.1x)
Cluster-V	30.2K (1x)	56.8K (1.9x)	71.8K (2.4x)	80.0K (2.6x)	269.5K (8.9x)	273.2K (9.0x)

strategy introduced in [36]. We set the first several percents of iterations as warm-up iterations. During the warm-up period, we start from dense training with zero sparsity ratio and linearly ramping up the sparsity ratio to the final value.

We implement CSC in System-I and evaluate its performance for Alexnet and ResNet-50 training. Figure 19 shows the average throughput. In this set of experiments, we enable ring-based allreduce and mixed-precision training to maximize the performance. Due to reduced network traffic and low additional computation cost, CSC significantly improves AlexNet’s training performance, as shown in Figure 19(a)(b). When enabling computation/communication overlap by selecting a proper communication threshold, System-I with CSC could process 245.4K images per second, and achieves 124.2 speedup ratio on 128 Pascal GPUs. The corresponding training throughput on 512 Volta GPUs is 1514.3K images/s with 410.2 speedup ratio. Compared to System-I with just lazy allreduce, CSC improves the performance of AlexNet training by 1.42x and 1.94 on 128 Pascal GPUs and 512 Volta GPUs, respectively. Since the communication bottleneck of ResNet-50 training is not network traffic, CSC does not improve its training throughput too much. Noted that System-I could already achieve high speedup ratio for ResNet-50 training with lazy-allreduce.

## 4 Overall Performance Evaluation

In this section, we show the overall performance evaluation results of System-I with GradientFlow to train AlexNet and ResNet-50 with 128 Pascal GPUs and 512 Volta GPUs. We first show the effectiveness of employed network optimization techniques and their combinations. Then we show System-I’s overall training time, and compare it with other approaches.

### 4.1 Effectiveness of Network Optimizations

Table 1 and Table 2 show the effectiveness of integrated network optimization techniques and their combinations. NCCL, mixed-precision training and communication/computation overlap could improve training throughput to a certain degree, but not significant. Compared to MPI-based baseline system, GradientFlow with NCCL, mixed-precision training and communication/computation overlap would improve the throughput of System-I by 6.2x and 2.6x for AlexNet and ResNet-50 training on 512 Volta GPUs. If GradientFlow enables lazy allreduce, the corresponding speedup ratio increases to 13.9 and 8.9, respectively. Due to reduced network traffic, System-I with coarse-grained sparse communication speeds up AlexNet training by 26.9 on Cluster-V. Since the communication bottleneck of ResNet-50 training is not network traffic, System-I with coarse-grained sparse communication has similar performance with System-I with lazy allreduce.

### 4.2 End-to-End Training Time

In this set of experiments, we measure the overall training time of AlexNet and ResNet-50 on the ImageNet-1K dataset. To maximize network performance of distributed DNN training, System-I enables ring-based allreduce, mixed-precision training, computation/communication overlap, lazy allreduce and coarse-grained sparse communication. The per-GPU batch size is 128 for both AlexNet and ResNet-50. The overall batch size of the training task is 64K with 512 GPUs. To avoid losing model quality with large batch size training, System-I employs layer-wise adaptive rate scaling (LARS) [40] algorithm, and make it work in conjunction with mixed-precision training. We adopt the linear scaling rule with warm-up scheme to adjust the learning rate. Also, System-I performs all data preprocessing tasks on GPUs to further improve system per-

Table 3: Compare AlexNet training with different approaches.

	Batch Size	Processor	GPU Interconnect	Time	Top-1 Accuracy
You et al. [40]	512	DGX-1 station	NVLink	6 hours 10 mins	58.8%
You et al. [40]	32K	CPU x 1024	-	11 mins	58.6%
Jia et al. [18]	64K	Pascal GPU x 1024	100 Gbps	5 mins	58.8%
Jia et al. [18]	64K	Pascal GPU x 2048	100 Gbps	4 mins	58.7%
<b>This Work (DenseCommu)</b>	<b>64K</b>	<b>Volta GPU x 512</b>	<b>56 Gbps</b>	<b>2.6 mins</b>	<b>58.7%</b>
<b>This Work (SparseCommu)</b>	<b>64K</b>	<b>Volta GPU x 512</b>	<b>56 Gbps</b>	<b>1.5 mins</b>	<b>58.2%</b>

Table 4: Compare ResNet-50 training with different approaches.

	Batch Size	Processor	GPU Interconnect	Time	Top-1 Accuracy
Goyal et al. [3]	8K	Pascal GPU x 256	56 Gbps	1 hour	76.3%
Smith et al. [41]	16K	Full TPU Pod	-	30 mins	76.1%
Codreanu et al. [42]	32K	KNL x 1024	-	42 mins	75.3%
You et al. [40]	32K	KNL x 2048	-	20 mins	75.4%
Akiba et al. [38]	32K	Pascal GPU x 1024	56 Gbps	15 mins	74.9%
Jia et al. [18]	64K	Pascal GPU x 1024	100 Gbps	8.7 mins	76.2%
Jia et al. [18]	64K	Pascal GPU x 2048	100 Gbps	6.6 mins	75.8%
Mikami et al. [43]	68K	Volta GPU x 2176	200 Gbps	3.7 mins	75.0%
This Work (DenseCommu)	64K	Volta GPU x 512	56 Gbps	7.3 mins	75.3%

formance. We complete AlexNet training in 95 epochs, and complete ResNet-50 training in 90 epochs.

Jia et al. [18] could complete ImageNet/AlexNet training in 4 minutes on 2048 Pascal GPUs. As shown in Table 3, we break this record and complete AlexNet training in 2.6 minutes using System-I without coarse-grained sparse communication. If we enable coarse-grained sparse communication with sparsity ratio 85% (15% of gradient chunks are selected for allreduce), System-I completes AlexNet training in 1.5 minutes. System-I provides shorter training time with less amount of GPUs and lower network bandwidth. Also, System-I achieves >58% top-1 accuracy in both cases.

Table 4 shows that System-I can finish ImageNet/ResNet-50 training in 7.3 minutes on 512 Volta GPUs without enabling sparse communication. Jia et al. [18] finish the training in 8.7 minutes with 1024 Pascal GPUs connected by 100 Gbps network. Compared to this work, System-I could also achieve shorter training time with less amount of GPUs and lower network bandwidth. Since ResNet-50 training is computation intensive, adding more GPUs could achieve faster training speed. Mikami et al. [43] achieve 1.97 speedup ratio than our work with 4x more GPUs and 4x higher bandwidth.

## 5 Conclusion

In this paper, we propose a communication backend named GradientFlow to improve network performance for distributed DNN training. Our first contribution is showing the performance gain of recently proposed ring-based allreduce, mixed-

precision training, and computation/communication overlap. Our results show that a real system with aforementioned approaches still have huge performance gap with the ideal system. To further reduce network cost, we propose lazy allreduce to improve network throughput by fusing multiple communication operations into a single one, and design coarse-graining sparse communication to reduce network traffic by only transmitting important gradient chunks. The results show that GradientFlow could significantly reduce the communication overhead of distributed DNN training. When training ImageNet/AlexNet on 512 GPUs, our work could achieve up to 410.2 speedup ratio, and complete 95-epoch training in 1.5 minutes, which outperforms existing approaches.

## Acknowledgement

We gratefully acknowledge contributions from our colleagues within SenseTime and our collaborators from Cloud Application and Platform Lab, Nanyang Technological University.

## References

- [1] Kaiming He, Xiangyu Zhang, Shaoqing Ren, and Jian Sun. Deep residual learning for image recognition. In *Proceedings of the IEEE conference on computer vision and pattern recognition*, pages 770–778, 2016.
- [2] Olga Russakovsky, Jia Deng, Hao Su, Jonathan Krause, Sanjeev Satheesh, Sean Ma, Zhiheng Huang, Andrej

- Karpathy, Aditya Khosla, Michael Bernstein, et al. Imagenet large scale visual recognition challenge. *International Journal of Computer Vision*, pages 1–42, 2014.
- [3] Priya Goyal, Piotr Dollár, Ross Girshick, Pieter Noordhuis, Lukasz Wesolowski, Aapo Kyrola, Andrew Tulloch, Yangqing Jia, and Kaiming He. Accurate, large minibatch sgd: training imagenet in 1 hour. *arXiv preprint arXiv:1706.02677*, 2017.
- [4] Sharan Chetlur, Cliff Woolley, Philippe Vandermersch, Jonathan Cohen, John Tran, Bryan Catanzaro, and Evan Shelhamer. cudnn: Efficient primitives for deep learning. *arXiv preprint arXiv:1410.0759*, 2014.
- [5] Wencong Xiao, Romil Bhardwaj, Ramachandran Ramjee, Muthian Sivathanu, Nipun Kwatra, Zhenhua Han, Pratyush Patel, Xuan Peng, Hanyu Zhao, Quanlu Zhang, Fan Yang, and Lidong Zhou. Gandiva: Introspective cluster scheduling for deep learning. In *13th USENIX Symposium on Operating Systems Design and Implementation (OSDI 18)*, pages 595–610, Carlsbad, CA, 2018. USENIX Association.
- [6] Jeffrey Dean. Large scale deep learning, 2014.
- [7] Tianqi Chen, Mu Li, Yutian Li, Min Lin, Naiyan Wang, Minjie Wang, Tianjun Xiao, Bing Xu, Chiyuan Zhang, and Zheng Zhang. Mxnet: A flexible and efficient machine learning library for heterogeneous distributed systems. *arXiv preprint arXiv:1512.01274*, 2015.
- [8] Pytorch. <https://pytorch.org>.
- [9] Martín Abadi, Paul Barham, Jianmin Chen, Zhifeng Chen, Andy Davis, Jeffrey Dean, Matthieu Devin, Sanjay Ghemawat, Geoffrey Irving, Michael Isard, Manjunath Kudlur, Josh Levenberg, Rajat Monga, Sherry Moore, Derek G. Murray, Benoit Steiner, Paul Tucker, Vijay Vasudevan, Pete Warden, Martin Wicke, Yuan Yu, and Xiaoqiang Zheng. Tensorflow: A system for large-scale machine learning. In *12th USENIX Symposium on Operating Systems Design and Implementation (OSDI 16)*, GA, November 2016. USENIX Association.
- [10] Eric P Xing, Qirong Ho, Wei Dai, Jin Kyu Kim, Jinliang Wei, Seunghak Lee, Xun Zheng, Pengtao Xie, Abhimanu Kumar, and Yaoliang Yu. Petuum: a new platform for distributed machine learning on big data. *Big Data, IEEE Transactions on*, 1(2):49–67, 2015.
- [11] Trishul Chilimbi, Yutaka Suzue, Johnson Apacible, and Karthik Kalyanaraman. Project adam: Building an efficient and scalable deep learning training system. In *11th USENIX Symposium on Operating Systems Design and Implementation (OSDI 14)*, pages 571–582, Broomfield, CO, 2014. USENIX Association.
- [12] Henggang Cui, Hao Zhang, Gregory R Ganger, Phillip B Gibbons, and Eric P Xing. Geeps: Scalable deep learning on distributed gpus with a gpu-specialized parameter server. In *Proceedings of the Eleventh European Conference on Computer Systems*, page 4. ACM, 2016.
- [13] Mu Li, David G. Andersen, Jun Woo Park, Alexander J. Smola, Amr Ahmed, Vanja Josifovski, James Long, Eugene J. Shekita, and Bor-Yiing Su. Scaling distributed machine learning with the parameter server. In *11th USENIX Symposium on Operating Systems Design and Implementation (OSDI 14)*, pages 583–598, Broomfield, CO, 2014. USENIX Association.
- [14] Evan R Sparks, Ameet Talwalkar, Virginia Smith, Jey Kottalam, Xinghao Pan, Joseph Gonzalez, Michael J Franklin, Michael I Jordan, and Tim Kraska. Mli: An api for distributed machine learning. In *Data Mining (ICDM), 2013 IEEE 13th International Conference on*, pages 1187–1192. IEEE, 2013.
- [15] Alex Krizhevsky, Ilya Sutskever, and Geoffrey E Hinton. Imagenet classification with deep convolutional neural networks. In *Advances in neural information processing systems*, pages 1097–1105, 2012.
- [16] Liang Luo, Jacob Nelson, Luis Ceze, Amar Phanishayee, and Arvind Krishnamurthy. Parameter hub: A rack-scale parameter server for distributed deep neural network training. In *Proceedings of the ACM Symposium on Cloud Computing*, SoCC '18, pages 41–54, New York, NY, USA, 2018. ACM.
- [17] Adam Coates, Brody Huval, Tao Wang, David Wu, Bryan Catanzaro, and Ng Andrew. Deep learning with COTS HPC systems. In *Proceedings of the 30th international conference on machine learning*, pages 1337–1345, 2013.
- [18] Xianyan Jia, Shutao Song, Wei He, Yangzihao Wang, Haidong Rong, Feihu Zhou, Liqiang Xie, Zhenyu Guo, Yuanzhou Yang, Liwei Yu, Tiegang Chen, Guangxiao Hu, Shaohuai Shi, and Xiaowen Chu. Highly scalable deep learning training system with mixed-precision: Training imagenet in four minutes. *arXiv preprint arXiv:1807.11205*, 2018.
- [19] Ren Wu, Shengen Yan, Yi Shan, Qingqing Dang, and Gang Sun. Deep image: Scaling up image recognition. *arXiv preprint arXiv:1501.02876*, 2015.
- [20] Hao Li, Asim Kadav, Erik Kruus, and Cristian Ungureanu. Malt: distributed data-parallelism for existing ml applications. In *Proceedings of the Tenth European Conference on Computer Systems*, page 3. ACM, 2015.

- [21] Forrest N Iandola, Matthew W Moskewicz, Khalid Ashraf, and Kurt Keutzer. Firecaffe: near-linear acceleration of deep neural network training on compute clusters. In *Proceedings of the IEEE Conference on Computer Vision and Pattern Recognition*, pages 2592–2600, 2016.
- [22] Ammar Ahmad Awan, Khaled Hamidouche, Jahanzeb Maqbool Hashmi, and Dhabaleswar K Panda. S-caffe: co-designing mpi runtimes and caffe for scalable deep learning on modern gpu clusters. *Acm Sigplan Notices*, 52(8):193–205, 2017.
- [23] Hao Wang, Sreeram Potluri, Miao Luo, Ashish Kumar Singh, Sayantan Sur, and Dhabaleswar K Panda. Mvapi2-gpu: optimized gpu to gpu communication for infiniband clusters. *Computer Science-Research and Development*, 26(3-4):257, 2011.
- [24] Baidu-allreduce. <https://github.com/baidu-research/baidu-allreduce>.
- [25] Nccl. <https://github.com/NVIDIA/nccl>.
- [26] Frank Seide, Hao Fu, Jasha Droppo, Gang Li, and Dong Yu. On parallelizability of stochastic gradient descent for speech dnns. In *2014 IEEE International Conference on Acoustics, Speech and Signal Processing (ICASSP)*, pages 235–239. IEEE, 2014.
- [27] Frank Seide, Hao Fu, Jasha Droppo, Gang Li, and Dong Yu. 1-bit stochastic gradient descent and its application to data-parallel distributed training of speech dnns. In *INTERSPEECH*, pages 1058–1062, 2014.
- [28] Suyog Gupta, Ankur Agrawal, Kailash Gopalakrishnan, and Pritish Narayanan. Deep learning with limited numerical precision. In *International Conference on Machine Learning*, pages 1737–1746, 2015.
- [29] Paulius Micikevicius, Sharan Narang, Jonah Alben, Gregory Diamos, Erich Elsen, David Garcia, Boris Ginsburg, Michael Houston, Oleksii Kuchaev, Ganesh Venkatesh, and Hao Wu. Mixed precision training. *arXiv preprint arXiv:1710.03740*, 2017.
- [30] Hao Zhang, Zeyu Zheng, Shizhen Xu, Wei Dai, Qirong Ho, Xiaodan Liang, Zhiting Hu, Jinliang Wei, Pengtao Xie, and Eric P. Xing. Poseidon: An efficient communication architecture for distributed deep learning on GPU clusters. In *2017 USENIX Annual Technical Conference (USENIX ATC 17)*, pages 181–193, Santa Clara, CA, 2017. USENIX Association.
- [31] Qirong Ho, James Cipar, Henggang Cui, Seunghak Lee, Jin Kyu Kim, Phillip B Gibbons, Garth A Gibson, Greg Ganger, and Eric P Xing. More effective distributed ML via a stale synchronous parallel parameter server. In *Advances in neural information processing systems*, pages 1223–1231, 2013.
- [32] Benjamin Recht, Christopher Re, Stephen Wright, and Feng Niu. Hogwild: A lock-free approach to parallelizing stochastic gradient descent. In *Advances in neural information processing systems*, pages 693–701, 2011.
- [33] Sayed Hadi Hashemi, Sangeetha Abdu Jyothi, and Roy H. Campbell. Tictac: Accelerating distributed deep learning with communication scheduling, 2018.
- [34] Alexander Sergeev and Mike Del Balso. Horovod: fast and easy distributed deep learning in tensorflow. *arXiv preprint arXiv:1802.05799*, 2018.
- [35] Peng Sun, Yonggang Wen, Ta Nguyen Binh Duong, and Shengen Yan. Timed dataflow: Reducing communication overhead for distributed machine learning systems. In *2016 IEEE 22nd International Conference on Parallel and Distributed Systems (ICPADS)*, pages 1110–1117. IEEE, 2016.
- [36] Yujun Lin, Song Han, Huizi Mao, Yu Wang, and William J Dally. Deep gradient compression: Reducing the communication bandwidth for distributed training. *arXiv preprint arXiv:1712.01887*, 2017.
- [37] Alham Fikri Aji and Kenneth Heafield. Sparse communication for distributed gradient descent. In *Proceedings of the 2017 Conference on Empirical Methods in Natural Language Processing*, pages 440–445. Association for Computational Linguistics, 2017.
- [38] Takuya Akiba, Shuji Suzuki, and Keisuke Fukuda. Extremely large minibatch sgd: Training resnet-50 on imagenet in 15 minutes. *arXiv preprint arXiv:1711.04325*, 2017.
- [39] Yann LeCun, Yoshua Bengio, and Geoffrey Hinton. Deep learning. *nature*, 521(7553):436, 2015.
- [40] Yang You, Zhao Zhang, Cho-Jui Hsieh, James Demmel, and Kurt Keutzer. Imagenet training in minutes. In *Proceedings of the 47th International Conference on Parallel Processing*, page 1. ACM, 2018.
- [41] Samuel L Smith, Pieter-Jan Kindermans, Chris Ying, and Quoc V Le. Don’t decay the learning rate, increase the batch size. *arXiv preprint arXiv:1711.00489*, 2017.
- [42] Valeriu Codreanu, Damian Podareanu, and Vikram Salefore. Scale out for large minibatch sgd: Residual network training on imagenet-1k with improved accuracy and reduced time to train. *arXiv preprint arXiv:1711.04291*, 2017.
- [43] Hiroaki Mikami, Hisahiro Sugauma, Yoshiki Tanaka, Yuichi Kageyama, et al. Imagenet/resnet-50 training in 224 seconds. *arXiv preprint arXiv:1811.05233*, 2018.