

Graph-theoretic Simplification of Quantum Circuits with the ZX-calculus

Ross Duncan 

University of Strathclyde / Cambridge Quantum Computing Ltd
ross.duncan@strath.ac.uk

Aleks Kissinger 

Radboud University Nijmegen
aleks@cs.ru.nl

Simon Perdrix 

CNRS LORIA, Inria-MOCQUA, Université de Lorraine, F 54000 Nancy, France
simon.perdrix@loria.fr

John van de Wetering 

Radboud University Nijmegen
john@vdwetering.name

Abstract

We present a new circuit-to-circuit optimisation routine based on an equational theory called the ZX-calculus. We first interpret quantum circuits as ZX-diagrams, a flexible, lower-level language for describing quantum computations graphically. Then, using the rules of the ZX-calculus, we derive a terminating simplification procedure for ZX-diagrams inspired by the graph-theoretic transformations of *local complementation* and *pivoting*. Finally, we use the preservation of a graph invariant called *focused gFlow* to derive a deterministic strategy for re-extracting a (simpler) quantum circuit from the resultant ZX-diagram. This procedure enables us to temporarily break the rigid quantum circuit structure and ‘see around’ obstructions (namely non-Clifford quantum gates) to produce more simplifications than naïve circuit transformation techniques alone.

2012 ACM Subject Classification Theory of computation → Quantum computation Theory

Keywords and phrases Quantum Circuit Optimisation, ZX-calculus, Rewriting, Graph Theory, Pivot- and vertex-minors

1 Introduction

Quantum circuits provide a *de facto* ‘assembly language’ for quantum computation, in which computations are described as the composition of many simple unitary linear maps called *quantum gates*. An important topic in the study of quantum circuits is *quantum circuit optimisation*, whereby quantum circuits which realise a given computation are transformed into new circuits involving fewer or simpler gates. While some strides have already been made in this area [21, 4, 3, 2, 28, 1], the topic is still in its infancy.

This paper lays a theoretical foundation for a new quantum circuit optimisation technique based on the ZX-calculus [9]. A key point of departure of our technique is that we break the rigid structure of quantum circuits and perform reductions on a more flexible, lower-level representation of a quantum circuit called a *ZX-diagram*. The ZX-calculus itself refers to the equational theory of ZX-diagrams. It has long been known to be complete for Clifford circuits [5], and several recent extensions have been proven sound and complete for Clifford+T circuits [22] and exact-universal families of quantum circuits [19, 23, 36].

Since ZX-diagrams provide a more flexible representation of a quantum computation than a circuit, we can find many new simplifications using the ZX-calculus which have no analogue for quantum circuits. However, this added flexibility comes at a price: while any quantum circuit can be interpreted as a ZX-diagram by decomposing gates into smaller pieces,

the converse is not true. For a generic ZX-diagram corresponding to a unitary, there is no general-purpose procedure for efficiently recovering a quantum circuit. Hence, an important part of our optimisation procedure is keeping enough information about the quantum circuit structure to get a circuit back at the end. Schematically:

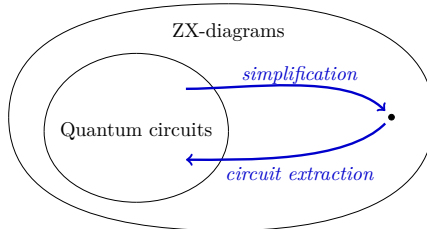

Until recently, this extraction step was poorly understood, and the only techniques for doing circuit-to-circuit translation with the ZX-calculus did so without departing (much) from the structure of the original quantum circuit [18], essentially avoiding the extraction problem.

In this paper we adopt a more ambitious approach. First, building on prior work of two of the authors [15, 16, 17], we use the rules of the ZX-calculus to derive a sound, terminating simplification procedure for ZX-diagrams. The key simplification steps involve the graph-theoretic transformations of local complementation and pivoting [27, 7], which allow certain generators to be deleted from ZX-diagrams one-by-one or in pairs, respectively. When applied to Clifford circuits, the diagram resulting from the simplification procedure is represented in the form of a *graph-state with local Cliffords* (GS-LC) [20], a pseudo-normal form for representing Clifford circuits whose size is at most quadratic in the number of qubits. Hence, one side effect of our simplification procedure is it gives a simple, graph-theoretic alternative to the normalisation of a ZX-diagram to GS-LC form proposed by Backens [5]. For non-Clifford circuits, the simplified ZX-diagram represents a ‘skeleton’ of the circuit we started with, consisting only of generators arising from non-Clifford phase gates and their nearest neighbours. Although this is no longer a canonical form, it can still be significantly smaller than the input circuit, especially when there is a relatively low proportion of non-Clifford gates.

We then show that, even though this simplification breaks the circuit structure, it preserves a graph-theoretic invariant called *focused gFlow* [8, 29], from which we can derive an efficient circuit extraction strategy. In the case of Clifford circuits, this procedure will produce circuits comparable in size to those described by standard techniques [1, 35]. In the non-Clifford case, this can already find more simplifications than naïvely ‘cutting’ the circuit and simplifying purely-Clifford sections. More interestingly, this simplify-and-extract setup provides a new framework for implementing further simplifications on the ‘skeleton’, e.g. for *T*-count reduction. We will comment briefly on the latter point—and its implementation in a tool called PyZX [26] developed by two of the authors—as a topic of future work.

The paper is organised as follows. After giving a brief introduction to the ZX-calculus in Section 2, we will introduce *graph-like* ZX-diagrams in Section 3. This mild restriction to the family of all ZX-diagrams will enable us to speak more readily about graph-theoretic properties of the diagram, like the existence of a focused gFlow. In Section 4 we will show that both local complementation and pivoting preserve focused gFlow. Then in Section 5 we will derive a simplification routine using these graph-theoretic notions. In Sections 6 and 7 we will show how the diagrams produced by this routine can be extracted into a circuit in the Clifford and non-Clifford cases, respectively. In Section 8, we conclude and discuss future work.

2 The ZX-calculus

We will provide a brief overview of the ZX-calculus. For an in-depth reference see Ref. [10].

The ZX-calculus is a diagrammatic language similar to the familiar quantum circuit notation. A ZX-diagram (or simply *diagram*) consists of *wires* and *spiders*. Wires entering the diagram from the left are *inputs*; wires exiting to the right are *outputs*. Given two diagrams we can compose them by joining the outputs of the first to the inputs of the second, or form their tensor product by simply putting the two diagrams side-by-side.

Spiders are linear operations which can have any number of input or output wires. There are two varieties: *Z* spiders depicted as green dots and *X* spiders depicted as red dots:¹

$$\begin{array}{c} \vdots \\ \vdots \\ \textcircled{\alpha} \\ \vdots \\ \vdots \end{array} := |0\dots 0\rangle\langle 0\dots 0| + e^{i\alpha} |1\dots 1\rangle\langle 1\dots 1| \quad \begin{array}{c} \vdots \\ \vdots \\ \textcircled{\alpha} \\ \vdots \\ \vdots \end{array} := |+\dots +\rangle\langle +\dots +| + e^{i\alpha} |-\dots -\rangle\langle -\dots -|$$

The diagram as a whole corresponds to a linear map built from the spiders (and permutations) by the usual composition and tensor product of linear maps. As a special case, diagrams with no inputs represent (unnormalised) state preparations.

► **Example 2.1.** We can immediately write down some simple state preparations and unitaries in the ZX-calculus:

$$\begin{array}{l} \textcircled{\alpha} = |0\rangle + |1\rangle \propto |+\rangle \qquad \textcircled{\alpha} = |+\rangle + |-\rangle \propto |0\rangle \\ \textcircled{\alpha} = |0\rangle\langle 0| + e^{i\alpha} |1\rangle\langle 1| = Z(\alpha) \qquad \textcircled{\alpha} = |+\rangle\langle +| + e^{i\alpha} |-\rangle\langle -| = X(\alpha) \end{array}$$

In particular we have the Pauli matrices:

$$\textcircled{\pi} = Z \qquad \textcircled{\pi} = X$$

It will be convenient to introduce a symbol – a yellow square – for the Hadamard gate. This is defined by the equation:

$$\square = \textcircled{-\frac{\pi}{2}} \textcircled{\frac{\pi}{2}} \textcircled{-\frac{\pi}{2}} \tag{1}$$

We will often use an alternative notation to simplify the diagrams, and replace a Hadamard between two spiders by a blue dotted edge, as illustrated below.

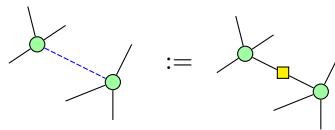

Both the blue edge notation and the Hadamard box can always be translated back into spiders when necessary. We will refer to the blue edge as a *Hadamard edge*.

Two diagrams are considered *equal* when one can be deformed to the other by moving the vertices around in the plane, bending, unbending, crossing, and uncrossing wires, so long as the connectivity and the order of the inputs and outputs is maintained. The ZX-calculus also has a further set of equations we call the *rules* of the calculus; these are shown in Figure 1. Equal diagrams correspond to equal linear maps².

¹ If you are reading this document in monochrome or otherwise have difficulty distinguishing green and red, *Z* spiders will appear lightly-shaded and *X* darkly-shaded.

² We will consider linear maps *A* and *B* to be “equal” if they satisfy $A = zB$ for some non-zero $z \in \mathbb{C}$. Backens [6] presents a version of the ZX-calculus where equality is “on the nose”.

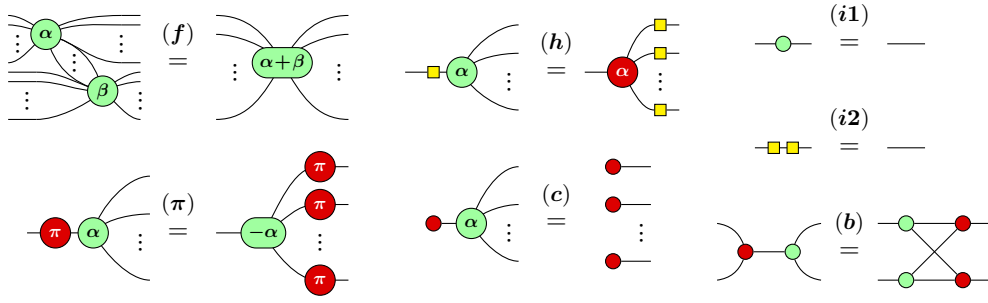

■ **Figure 1** A convenient presentation for the ZX-calculus. These rules hold for all $\alpha, \beta \in [0, 2\pi)$, and due to (h) and (i2) all rules also hold with the colours interchanged.

Later we will use two derived rules, the *antipode* rule³ and the π -*copy* rule.

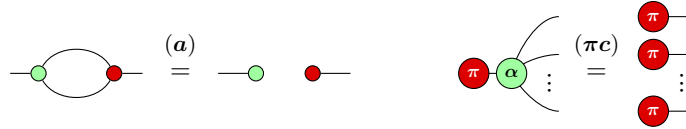

Their derivations are found in Appendix B.

► **Remark 2.2.** The ZX-calculus is *universal* in the sense that there is a diagram for every linear map. However, the version of the calculus we have presented here is not *complete*: it is possible for two diagrams to represent the same linear map, while the diagrams can't be proved equal using the rules of the calculus [14]. This question is addressed in a series of recent papers [32, 25, 22, 31, 23, 24, 36] which propose extensions of the calculus which are complete in this sense.

Quantum circuits can in a straightforward manner be translated into ZX-diagrams. We will take as our starting point circuits constructed from the following universal set of basic gates:

$$\text{CNOT} := \begin{pmatrix} 1 & 0 & 0 & 0 \\ 0 & 1 & 0 & 0 \\ 0 & 0 & 0 & 1 \\ 0 & 0 & 1 & 0 \end{pmatrix} \quad Z_\alpha := \begin{pmatrix} 1 & 0 \\ 0 & e^{i\alpha} \end{pmatrix} \quad H := \frac{1}{\sqrt{2}} \begin{pmatrix} 1 & 1 \\ 1 & -1 \end{pmatrix}$$

Other gates can easily be expressed in terms of these gates. In particular, X_α , S and T gates are expressed as

$$X_\alpha = HZ_\alpha H \quad S = Z_{\frac{\pi}{2}} \quad T = Z_{\frac{\pi}{4}}$$

where the equations above hold up to a global phase. We fix this gate set because they admit a convenient representation in terms of spiders:

$$\text{CNOT} = \begin{array}{c} \text{---} \text{green spider} \text{---} \\ | \\ \text{---} \text{red dot} \text{---} \end{array} \quad Z_\alpha = \text{---} \text{green spider} \text{---} \quad X_\alpha = \text{---} \text{red spider} \text{---} \quad H = \text{---} \text{yellow square} \text{---} \quad (2)$$

Note that green vertex is the control qubit of the CNOT and the red vertex is the target qubit.

³ Also known as the *complementarity* rule [10] and the *Hopf* rule [9].

► **Example 2.3.** It is well known that the CZ gate can be obtained from the CNOT by applying Hadamard gates to the target qubit. We use this to derive a simple form for the CZ gate in the ZX-calculus:

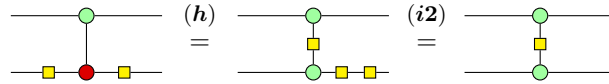

Note that we can directly read from the diagram that a CZ gate is symmetric.

We can now give a formal definition of what a circuit is in terms of a ZX-diagram.

► **Definition 2.4.** A circuit is a ZX-diagram generated by compositions and tensor products of the ZX-diagrams of (2).

3 Graph-like ZX-diagrams

Our simplification procedure cannot be run on an arbitrary ZX-diagram. We must first transform the diagram into a more convenient form.

► **Definition 3.1.** A ZX-diagram is graph-like when:

1. All spiders are Z-spiders.
2. Z-spiders are only connected via Hadamard edges.
3. At most 1 such connection exists between any two spiders.
4. No spider is wired to itself.
5. Every input or output is connected, either directly or via a Hadamard gate, to a Z-spider.

► **Lemma 3.2.** Every ZX-diagram is equal to a graph-like diagram.

Proof. See Appendix B.2 for a procedure that transforms any ZX-diagram into a graph-like diagram. ◀

► **Remark 3.3.** In general a ZX-diagram may have multiple inputs or outputs wired to the same spider. However for diagrams derived from circuits, which are our sole concern here, every spider is connected to at most a single input and a single output. We will assume this in the rest of the paper.

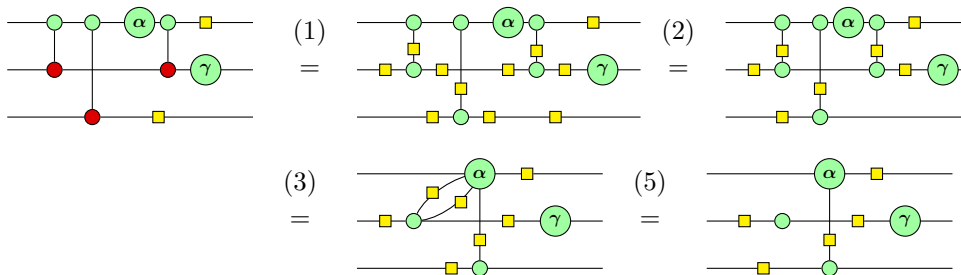

■ **Figure 2** Translating a circuit to a graph-like ZX-diagram. The numbers on the equations refer the steps of the procedure described in Appendix B.2; since the diagram has no self loops, there is no (4).

► **Definition 3.4.** An open graph is a triple (G, I, O) where $G = (V, E)$ is an undirected graph, and $I, O \subseteq V$ are the sets of inputs and outputs respectively.

6 Circuit Simplification with the ZX-calculus

When discussing open graphs we will use the notation $I^c := V \setminus I$ and $O^c := V \setminus O$ for the non-inputs and non-outputs respectively. The set of neighbours of a vertex $v \in V$ will be denoted by $N(v)$.

► **Definition 3.5.** Let D be a graph-like ZX-diagram; its underlying graph, $G(D)$, is an open graph where:

- The vertices of $G(D)$ are the spiders of D .
- v and u are adjacent in $G(D)$ if and only if their corresponding spiders are connected via a Hadamard edge in D .
- A vertex v lies in the set of inputs I if and only if the corresponding spider of D is wired to an input in D (either directly or via a Hadamard gate), and similarly $v \in O$ if and only if its spider is wired to an output (either directly or via a Hadamard gate).

► **Example 3.6.** The underlying graph of the graph-like diagram from Figure 2 is constructed as follows:

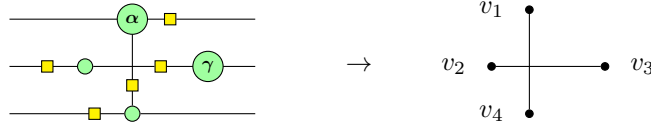

Here $I = \{v_1, v_2, v_4\}$ and $O = \{v_1, v_3, v_4\}$. Note that in particular v_1 and v_4 lie in both I and O .

The following graph-theoretic property will prove instrumental in transforming ZX-diagrams back into circuits⁴.

► **Definition 3.7.** [29] Given an open graph G , a focused gFlow (g, \prec) on G consists of a function $g : O^c \rightarrow 2^{I^c}$ and a partial order \prec on the vertices V of G such that for all $u \in V$,

- $\text{Odd}_G(g(u)) \cap O^c = \{u\}$
- $\forall v \in g(u), u \prec v$

where $\text{Odd}_G(A) := \{v \in V(G) \mid |N(v) \cap A| = 1 \pmod{2}\}$ is the odd neighbourhood of A .

► **Remark 3.8.** Gflow techniques were introduced in the context of measurement-based quantum computing [12, 13]. *Focused gFlow* is a special case of the standard notion of gFlow [8], in that the latter only requires $u \in \text{Odd}_G(g(u)) \cap O^c$ for the first condition above. However, as a property of graphs, the two notions are equivalent: an open graph has a gFlow if and only if it has a focused gFlow. It was shown in [30] that one can efficiently decide whether a given open graph has a (focused) gFlow.

► **Lemma 3.9.** Let D be a graph-like ZX-diagram obtained from a circuit (cf. Def 2.4) by the procedure of Lemma 3.2; then the underlying graph of D admits a focused gFlow.

Proof. See Appendix B.3. ◀

4 Local complementation and pivoting

Local complementation is a graph transformation introduced by Kotzig [27]:

⁴ A simpler, but more restrictive condition is presented in Appendix B.3.

► **Definition 4.1.** Let G be a (simple, undirected) graph and let u be a vertex of G . The local complementation of G according to u , written as $G \star u$, is a graph which has the same vertices as G , but all the neighbours v, w of u are connected in $G \star u$ if and only if they are not connected in G , and vice versa. All other edges are unchanged.

► **Example 4.2.**

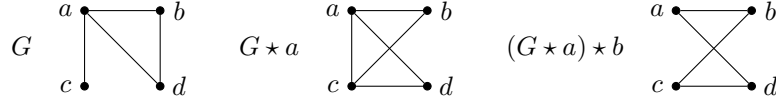

To every graph we can associate a *graph state* [20], and on these graph states a local complementation corresponds to doing several local Clifford operations [34]. Written in terms of ZX-diagrams, this correspondence becomes (see Ref. [10, Proposition 9.125]):

(3)

► **Remark 4.3.** To see how this is related to a complementation of the vertices, note that when there are two parallel Hadamard edges between two vertices, that they cancel each other out because of (\mathbf{a}) , and hence any edges already present in the left diagram will be removed by this operation.

The second graph operation we will need is pivoting.

► **Definition 4.4.** Let G be a (simple, undirected) graph, and let u and v be a pair of connected vertices in G . The pivot of G along the edge uv is the graph $G \wedge uv := G \star u \star v \star u$.

On a graph, pivoting consists of complementing the edges in-between three particular subsets of the vertices: the common neighbourhood of u and v (i.e. $N_G(u) \cap N_G(v)$), the exclusive neighbourhood of u (i.e. $N_G(u) \setminus (N_G(v) \cup \{v\})$), and exclusive neighbourhood of v (i.e. $N_G(v) \setminus (N_G(u) \cup \{u\})$):

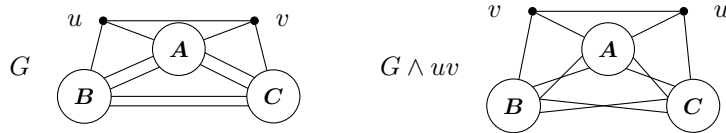

Pivoting can also be implemented on graph states by means of local operations [30], which for ZX-diagrams becomes the following equality:

(4)

The following lemmas will prove pivotal in our extraction routine. Since the proof of them is rather technical, they can be found in Appendix B.4. The lemmas state that when we start

with a graph that has gFlow, the graph produced by either doing a local complementation and removing the complemented vertex, or doing a pivot and removing the pivoted vertices will also have a gFlow.

► **Lemma 4.5.** *If (g, \prec) is a focused gFlow for (G, I, O) then (g', \prec) is a focused gFlow for $(G \wedge uv \setminus \{u, v\}, I, O)$ where $\forall w \in O^c \setminus \{u, v\}$, $g'(w) := g(w) \setminus \{u, v\}$.*

► **Lemma 4.6.** *If (g, \prec) is a focused gFlow for (G, I, O) then (g', \prec) is a focused gFlow for $(G \star u \setminus \{u\}, I, O)$ where $g' : O^c \setminus \{u\} \rightarrow 2^{I^c \setminus \{u\}}$ is inductively defined as*

$$g'(w) := \begin{cases} g(w) \Delta_{t \in R_w} g'(t) & \text{if } u \notin g(w) \\ g(w) \Delta \{u\} \Delta g(u) \Delta_{t \in R_u} \Delta_{R_w} g'(t) & \text{otherwise} \end{cases}$$

where $R_w := N_G(u) \cap g(w) \cap O^c$, and $\Delta \cdot$ is the symmetric difference.

► **Remark 4.7.** Notice that the simpler function $\tilde{g} = w \mapsto \begin{cases} g(w) & \text{if } u \notin g(w) \\ g(w) \Delta \{u\} \Delta g(u) & \text{otherwise} \end{cases}$ also leads to a gFlow for $(G \star u \setminus \{u\}, I, O)$, which is however not necessarily focused. There is a procedure to make any gFlow focused [29], transforming for instance \tilde{g} into g' . In Lemma 4.6, it is however crucial for the initial gFlow (g, \prec) to be a focused, otherwise both g' and \tilde{g} might not be gFlow.

5 A simplification strategy for circuits

We now have all the necessary machinery to introduce our simplification routine. The general idea is to use local complementation and pivoting based rewrite rules to remove as many *interior* spiders as possible. A spider is called interior when it is not connected (either directly or via a Hadamard gate) to an input or an output.

► **Definition 5.1.** *We call a spider Pauli if its phase is a multiple of π , and Clifford if its phase is a multiple of $\frac{\pi}{2}$. If the phase of a Clifford spider is an odd multiple of $\frac{\pi}{2}$ (and hence non-Pauli), we call this a proper Clifford spider.*

The graph-like ZX-diagram resulting from the translation of a Clifford circuit contains only Clifford spiders, since the only time the phase changes on a spider is during a spider-fusion step, in which case the phases are added together.

We will show that our procedure is able to eliminate *all* interior proper Clifford spiders and all Pauli spiders adjacent either to any non-interior spider or any interior Pauli spider. In particular, for Clifford circuits, we will obtain a pseudo-normal form which contains no interior spiders, cf. Section 6.

The main rewrite rules we use are based on local complementation and pivoting. The first one allows us to remove any interior proper Clifford spider while the second one removes any two connected interior spiders.

► **Lemma 5.2.**

$$\begin{array}{c} \text{Spider } \pm \frac{\pi}{2} \\ \text{connected to } \alpha_1, \alpha_2, \dots, \alpha_{n-1}, \alpha_n \end{array} = \begin{array}{c} \text{Spider } \alpha_1 \pm \frac{\pi}{2} \\ \text{Spider } \alpha_2 \pm \frac{\pi}{2} \\ \dots \\ \text{Spider } \alpha_{n-1} \pm \frac{\pi}{2} \\ \text{Spider } \alpha_n \pm \frac{\pi}{2} \end{array} \quad (5)$$

► **Lemma 5.3.**

$$(6)$$

The proof of these lemmas can be found in Appendix B.5. For the rest of the paper when we refer to “applying” equations (5) and (6) we mean that we find a match for the lefthandside and transform it to the righthandside, and that we remove parallel edges that have been introduced by this rewrite using the rule (a).

► **Proposition 5.4.** *Let D be a graph-like ZX-diagram such that the underlying graph has a focused gFlow. Then the diagram D' produced by applying equation (5) or (6) is also graph-like and its underlying graph also has a focused gFlow.*

Proof. These rewrite rules obviously preserve the graph-like structure of the diagram, so it remains to show that the new underlying graph still has a gFlow. It is straightforward to see that if D' is produced by applying (5) on a vertex u in D that we have $G(D') = G(D) \star u \setminus \{u\}$. By Lemma 4.6 this new open graph then still has a focused gFlow. Similarly if (6) is applied on vertices u and v then the resulting diagram D' has underlying graph $G(D') = G(D) \wedge uv \setminus \{u, v\}$ which still has a gFlow by Lemma 4.5. ◀

Suppose we have a graph where we have applied rewrite rules (5) and (6) until they cannot be applied any more (since these rewrite rules remove vertices this will happen after a finite amount of applications). At that point we might still have interior Clifford vertices. This phase can't be proper Clifford since it would have been taken care of by (5), so it must be Pauli. If this vertex were connected to any other interior Clifford vertex (which by necessity must also be Pauli) then (6) would have removed the vertex. If the diagram is a Clifford diagram the vertex can therefore not be connected to any other interior vertex and it must have a neighbour on the boundary, since otherwise it would be disconnected from the rest of the diagram and be a scalar. If we have an interior Pauli vertex with a neighbour on the boundary than we apply the following transformation:

$$(7)$$

The unfuse on the right marked vertex should be done along an input or output such that the marked node is an internal vertex. If the marked vertex is both an input and an output than an additional identity spider must be inserted to also disconnect the vertex from that other in- or output. After this transformation, we can apply (6) on the marked vertices. Note that the combination of this transformation and the rewrite rule removes an interior vertex at the cost of introducing a local phase gate on one of the inputs or outputs. For the purposes of determining which vertices are interior or exterior we will ignore this phase gate, so that this procedure indeed removes an interior vertex. This step only changes phases of neighbouring vertices by zero or π and hence it does not make new interior proper Clifford vertices. It also does not connect interior Pauli vertices: the left marked vertex is only connected to boundary vertices and non-Clifford interior vertices. The Pauli vertices

that might get connected by the pivot are therefore neighbours of the right marked vertex. The pivot will however only connect them to neighbours of the left vertex, which as noted, cannot be interior Pauli vertices.

We conclude that since this last step removes an interior vertex and it does not introduce interior proper Clifford vertices, nor connect interior Pauli vertices, that we can simply repeat this procedure until all interior Pauli vertices are only connected to interior non-Clifford vertices. Additionally, since (7) only adds spiders on the inputs or outputs, it should be clear how a gFlow on the original diagram can be modified into a gFlow on the resulting diagram. The simplification procedure hence proceeds as follows:

1. Starting with a graph-like ZX-diagram, apply (5) until there are no interior proper Clifford spiders.
2. Apply (6) until there are no connected pairs of interior Pauli spiders.
3. For every interior Pauli node unfuse the phase of one of its neighbours on the boundary as in equation (7) and apply (6) to remove the interior vertex.

► **Proposition 5.5.** *Suppose D is a graph-like ZX-diagram with a focused gFlow, then the graph D' produced by running the above simplification routine also has a focused gFlow.*

Proof. By Proposition 5.4, every application of the rewrite rules used in the first two steps in the algorithm preserve the gFlow. It should be clear how (7) preserves gFlow, and hence step 3 also preserves the gFlow. ◀

6 Circuits from Clifford diagrams

As described in the previous section, when a Clifford circuit is fed into our simplification routine, no interior spiders will be left, and hence the diagram is in *GS-LC* form (*graph-state with local Cliffords*).

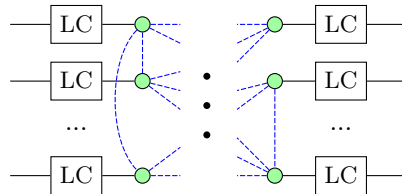

It is straightforward to extract a Clifford circuit from a GS-LC form. First, we unfuse spiders to create CZ gates, and colour change to add Hadamards:

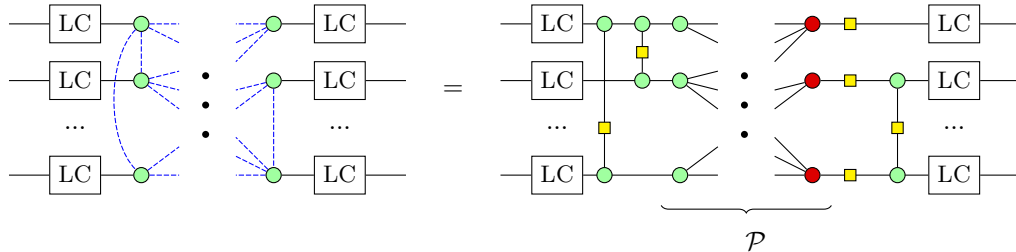

The part of the diagram marked \mathcal{P} is now simply a classical parity circuit. That is, it is a permutation of computational basis states where the output basis is given in terms of parities of the inputs, e.g. $|x_1, x_2, x_3, x_4\rangle \mapsto |x_1 \oplus x_2, x_1 \oplus x_3, x_4, x_3\rangle$. Such a unitary can always be realised via CNOT gates, using standard techniques (see e.g. [28]). Hence, we can extract a reduced Clifford circuit:

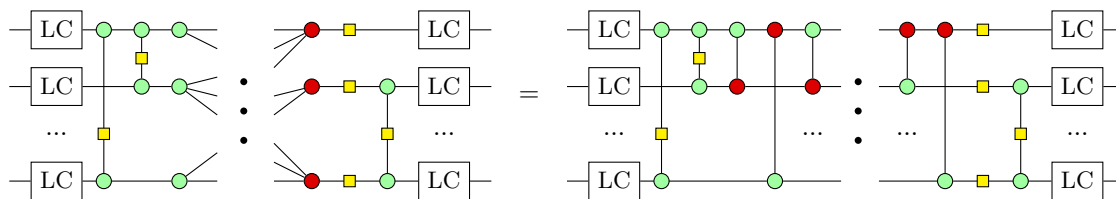

This Clifford circuit now consists of 6 layers of gates:

Local Cliffords + CZs + CNOTS + Hadamards + CZs + Local Cliffords

► Remark 6.1. In Ref. [35], a pseudo-normal form for Clifford circuits is found which consists of 7 layers. This extra layer corresponds to an additional set of CNOTs after the layer of Hadamards.

► Remark 6.2. In Ref. [5] it is also shown that the rules of the ZX-calculus allows one to reduce an arbitrary Clifford diagram to a GS-LC pseudo-normal form. The proof in Ref. [5] however relies on showing that a GS-LC normal form composed with every generator of the ZX-calculus can be brought back into GS-LC form, and hence is quite involved. Our method relies on straightforward application of local complementation and pivoting.

7 Circuits from non-Clifford diagrams

If a Clifford+T circuit – or a more general circuit containing gates Z_α or X_α for $\alpha \neq k\frac{\pi}{2}$ – is fed into our simplification routine, there might still be interior spiders left, and hence the diagram will not be in GS-LC form. In fact, the amount of interior spiders is directly related to the T-count of the starting circuit.

Our general strategy for extracting a circuit from a diagram produced by our simplification routine is to progress through the diagram, starting from the outputs, step by step ‘extracting’ each vertex into something resembling a circuit. In this process we will then have a set of vertices on the right that have been extracted, connected to a layer of vertices which we call the *frontier*, with the diagram to the left of the frontier not yet having been extracted. The goal then, is to find ways to progress the frontier further and further until all vertices have been consumed and we are left with a circuit. The tool we will use to show that this can always be done with diagrams produced by our simplification procedure is gFlow.

The following proposition shows that we can simplify the connectivity of our diagram by extracting CNOT gates.

► Proposition 7.1. *The following equation holds.*

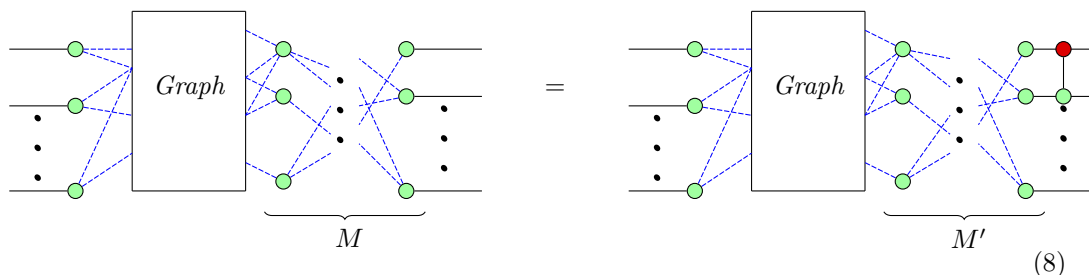

Here M describes the biadjacency matrix of the relevant vertices, and M' is the matrix produced by starting with M and then adding row 2 to row 1, taking sums modulo 2. Furthermore, if the diagram on the lefthandside has a focused gFlow, then so does the righthandside.

Proof. See Appendix B.5. ◀

We can now start describing our extraction procedure. To start, let the frontier F consist of all the output vertices. If a vertex of the frontier has a non-zero phase, unfuse this phase in the direction of the output. Whenever two vertices of the frontier are connected, unfuse this connection into a CZ gate as in the previous section. If the diagram started out having a gFlow, then the resulting diagram still has a gFlow since we only affected output vertices. Let g be the gFlow of the diagram. We push the frontier onto new vertices in the following way:

1. Find an unextracted vertex v such that $g(v) \subseteq F$. Such a vertex always exists: take for instance any non-frontier vertex that is maximal in the gFlow order.
2. We know that $\text{Odd}(g(v)) = \{v\}$ hence we can pick a designated vertex $w \in F$ such that w is connected to v .
3. Write the biadjacency matrix of $g(v) \subseteq F$ and their neighbours to the left of the frontier ('the past'). Because $\text{Odd}(g(v)) = \{v\}$ we know that the sum of all the rows in this matrix modulo 2 is an all-zero vector except for a 1 corresponding to v . Hence, if we apply row operations with w as the target from every other vertex in $g(v)$ we know that w will have only a single vertex connected to it in its past, namely v . Do these row operations using Proposition 7.1. As a result, CNOT gates will be pushed onto the extracted circuit. By that same proposition, the diagram will still have a gFlow.
4. At this point it might be that v is still connected to vertices of F that are not w . For each of these vertices $w' \in F$, do a row operation from w to w' by adding the corresponding CNOT to the extracted diagram in order to disconnect w' from v . At this point v 's only connection to F is via w . We can therefore conclude that the gFlow of the resulting diagram is such that the only vertex u that has $w \in g(u)$ is v .
5. The vertex w has arity 2 and since it is phaseless we can remove it from the diagram by (i1). Remove w from the frontier, and replace it by v . By the remarks in the previous point the resulting diagram still has a gFlow. Unfuse the phase of v as a phase gate to the extracted part.
6. If there is any vertex in F that is not connected to an input, go back to step 1, otherwise we are done.

After all vertices have been extracted by the above procedure, we will have some permutation of the frontier vertices to the inputs. The extraction is finished by realising this permutation as a series of SWAP gates.

► **Remark 7.2.** We could do a similar extraction routine where *all* the v with $g(v) \subseteq F$ are extracted simultaneously. The depth of the extracted circuit is then directly related to the depth of the gFlow partial order. In this modified routine, an extra step must be added to the loop above to deal with edges between simultaneously extracted vertices resulting in CZ gates.

► **Remark 7.3.** We do not actually need any explicitly calculated gFlow for this algorithm; the fact that one exists is enough, because the key step of finding a set of CNOT gates to simplify the adjacency matrix can be done using regular Gaussian elimination. The existence of a gFlow implies that this Gaussian elimination will always find a next vertex for the frontier, and gFlow is not needed beyond that.

For a pseudocode description of the extraction algorithm, see Appendix C in the Appendix. For extended examples we refer to Appendix A

8 Conclusions and Future Work

We have introduced a terminating rewrite strategy for ZX-diagrams that simplifies Clifford circuits to GS-LC form using the graph-theoretic notions of local complementation and pivoting. We have shown how the diagrams produced by the rewrite strategy applied to non-Clifford circuits can be turned back into a circuit using the fact that our rewrites preserve gFlow.

The question of how a circuit can be extracted from a general ZX-diagram is still open. We speculate that this problem is not tractable in the general case, as it seems to be related to the problem of finding an ancilla-free unitary from a circuit containing ancillae. This observation does however not preclude finding larger classes of rewrites and ZX-diagrams such that we can efficiently extract a circuit.

The next step for optimising quantum circuits using ZX-diagrams is to find additional rewrite rules that allows one to produce smaller diagrams, while still being able to extract the diagrams into a circuit. An approach based on replacing non-Clifford phase gates with certain ZX-diagrams called *phase gadgets* during the simplification procedure has shown some promise. These enable phases to propagate non-locally through the circuit, much like they do in *phase-polynomial* approaches to quantum circuit optimisation [21, 4, 3]. However, unlike those approaches, the framework we described in this paper (with the addition of phase gadgets) applies to arbitrary circuits, rather than only $\{\text{CNOT}, Z_\alpha\}$ circuits. Various heuristics involving phase gadgets have been implemented in the circuit optimisation tool PyZX [26], however a detailed description of these techniques and analysis of their performance is a topic of future work.

A second avenue of future work is to adapt the circuit extraction procedure to work in constrained qubit topologies. Many near-term quantum devices only allow interactions between certain pairs of qubits (e.g. nearest neighbours in some fixed planar graph). A notable feature of the circuit extraction procedure described in Section 7 is that we have some freedom in choosing which CNOTs to apply in reducing the bi-adjacency matrix of the ZX-diagram. We are currently exploring techniques by which this extraction can be constrained to only apply CNOTs in ‘allowed’ locations to produce circuits suitable for hardware with topological constraints.

Acknowledgements: SP acknowledges support from the projects ANR-17-CE25-0009 SoftQPro, ANR-17-CE24-0035 VanQuTe, PIA-GDN/Quantex, and LUE / UOQ. AK and JvdW are supported in part by AFOSR grant FA2386-18-1-4028.

References

- 1 Scott Aaronson and Daniel Gottesman. Improved simulation of stabilizer circuits. *Physical Review A*, 70(5):052328, 2004.
- 2 Nabila Abdessaied, Mathias Soeken, and Rolf Drechsler. Quantum circuit optimization by hadamard gate reduction. In *International Conference on Reversible Computation*, pages 149–162. Springer, 2014.
- 3 Matthew Amy, Dmitri Maslov, and Michele Mosca. Polynomial-time T-depth optimization of Clifford+ T circuits via matroid partitioning. *IEEE Transactions on Computer-Aided Design of Integrated Circuits and Systems*, 33(10):1476–1489, 2014.
- 4 Matthew Amy and Michele Mosca. T-count optimization and Reed-Muller codes. *arXiv preprint arXiv:1601.07363*, 2016.
- 5 Miriam Backens. The zx-calculus is complete for stabilizer quantum mechanics. *New Journal of Physics*, 16(9):093021, 2014.

- 6 Miriam Backens. Making the stabilizer zx-calculus complete for scalars. In Chris Heunen, Peter Selinger, and Jamie Vicary, editors, *Proceedings of the 12th International Workshop on Quantum Physics and Logic (QPL 2015)*, volume 195 of *Electronic Proceedings in Theoretical Computer Science*, pages 17–32, 2015. arXiv:arXiv:1507.03854, doi:10.4204/EPTCS.195.2.
- 7 André Bouchet. Graphic presentations of isotropic systems. *J. Comb. Theory Ser. A*, 45:58–76, July 1987. URL: <http://dl.acm.org/citation.cfm?id=51355.51360>.
- 8 Daniel E Browne, Elham Kashefi, Mehdi Mhalla, and Simon Perdrix. Generalized flow and determinism in measurement-based quantum computation. *New Journal of Physics*, 9(8):250, 2007. URL: <http://stacks.iop.org/1367-2630/9/i=8/a=250>.
- 9 B. Coecke and R. Duncan. Interacting quantum observables: categorical algebra and diagrammatics. *New Journal of Physics*, 13:043016, 2011. arXiv:quant-ph/09064725.
- 10 B. Coecke and A. Kissinger. *Picturing Quantum Processes*. Cambridge University Press, 2014.
- 11 V. Danos and E. Kashefi. Determinism in the one-way model. *Phys. Rev. A*, 74(052310), 2006. doi:10.1103/PhysRevA.74.052310.
- 12 V. Danos, E. Kashefi, and P. Panangaden. The Measurement Calculus. *ArXiv e-prints*, April 2007. arXiv:0704.1263.
- 13 Vincent Danos, Elham Kashefi, Prakash Panangaden, and Simon Perdrix. *Extended Measurement Calculus*. Cambridge University Press, 2010.
- 14 Christian Schröder de Witt and Vladimir Zamdzhiev. The zx-calculus is incomplete for quantum mechanics. In *Proceedings QPL 2014*, volume 172 of *EPTCS*, pages 285–292, 2014. arXiv:arXiv:1404.3633, doi:10.4204/EPTCS.172.20.
- 15 R. Duncan and S. Perdrix. Graph states and the necessity of Euler decomposition. *Mathematical Theory and Computational Practice*, pages 167–177, 2009.
- 16 R. Duncan and S. Perdrix. Rewriting measurement-based quantum computations with generalised flow. In *Proceedings of ICALP*, Lecture Notes in Computer Science, pages 285–296. Springer, 2010.
- 17 Ross Duncan and Simon Perdrix. Pivoting makes the zx-calculus complete for real stabilizers. In Bob Coecke and Matty Hoban, editors, *Proceedings of the 10th International Workshop on Quantum Physics and Logic (QPL)*, volume 171 of *Electronic Proceedings in Theoretical Computer Science*, pages 50–62. Open Publishing Association, 2014. doi:10.4204/EPTCS.171.5.
- 18 Andrew Fagan and Ross Duncan. Optimising clifford circuits with quantomatic. In Peter Selinger and Giulio Chiribella, editors, *Proceedings of the 15th International Conference on Quantum Physics and Logic (QPL)*, volume 287 of *Electronic Proceedings in Theoretical Computer Science*, pages 85–105. Open Publishing Association, 2019. doi:10.4204/EPTCS.287.5.
- 19 Amar Hadzihasanovic, Kang Feng Ng, and Quanlong Wang. Two complete axiomatisations of pure-state qubit quantum computing. In *Proceedings of the 33rd Annual ACM/IEEE Symposium on Logic in Computer Science, LICS '18*, pages 502–511, New York, NY, USA, 2018. ACM. URL: <http://doi.acm.org/10.1145/3209108.3209128>, doi:10.1145/3209108.3209128.
- 20 Marc Hein, Wolfgang Dür, Jens Eisert, Robert Raussendorf, M Nest, and H-J Briegel. Entanglement in graph states and its applications. *arXiv preprint quant-ph/0602096*, 2006.
- 21 Luke Ellis Heyfron and Earl Campbell. An efficient quantum compiler that reduces T count. *Quantum Science and Technology*, 2018.
- 22 Emmanuel Jeandel, Simon Perdrix, and Renaud Vilmart. A complete axiomatisation of the zx-calculus for clifford+t quantum mechanics. In *Proceedings of the 33rd Annual ACM/IEEE Symposium on Logic in Computer Science, LICS '18*, pages 559–568, New York, NY, USA, 2018. ACM. URL: <http://doi.acm.org/10.1145/3209108.3209131>, doi:10.1145/3209108.3209131.
- 23 Emmanuel Jeandel, Simon Perdrix, and Renaud Vilmart. Diagrammatic reasoning beyond clifford+t quantum mechanics. In *Proceedings of the 33rd Annual ACM/IEEE Symposium on*

- Logic in Computer Science*, LICS '18, pages 569–578, New York, NY, USA, 2018. ACM. URL: <http://doi.acm.org/10.1145/3209108.3209139>, doi:10.1145/3209108.3209139.
- 24 Emmanuel Jeandel, Simon Perdrix, and Renaud Vilmart. A generic normal form for zx-diagrams and application to the rational angle completeness. *arXiv preprint arXiv:1805.05296*, 2018.
 - 25 Emmanuel Jeandel, Simon Perdrix, Renaud Vilmart, and Quanlong Wang. ZX-Calculus: Cyclotomic Supplementarity and Incompleteness for Clifford+T Quantum Mechanics. In Kim G. Larsen, Hans L. Bodlaender, and Jean-Francois Raskin, editors, *42nd International Symposium on Mathematical Foundations of Computer Science (MFCS 2017)*, volume 83 of *Leibniz International Proceedings in Informatics (LIPIcs)*, pages 11:1–11:13, Dagstuhl, Germany, 2017. Schloss Dagstuhl–Leibniz-Zentrum fuer Informatik. URL: <http://drops.dagstuhl.de/opus/volltexte/2017/8117>, doi:10.4230/LIPIcs.MFCS.2017.11.
 - 26 Aleks Kissinger and John van de Wetering. PyZX: A circuit optimisation tool based on the ZX-calculus. <http://github.com/Quantomatic/pyzx>.
 - 27 Anton Kotzig. Eulerian lines in finite 4-valent graphs and their transformations. In *Colloquium on Graph Theory Tihany 1966*, pages 219–230. Academic Press, 1968.
 - 28 Ketan Markov, Igor Patel, and John Hayes. Optimal synthesis of linear reversible circuits. *Quantum Information and Computation*, 8(3&4):0282–0294, 2008.
 - 29 Mehdi Mhalla, Mio Murao, Simon Perdrix, Masato Someya, and Peter S Turner. Which graph states are useful for quantum information processing? In *Conference on Quantum Computation, Communication, and Cryptography*, pages 174–187. Springer, 2011.
 - 30 Mehdi Mhalla and Simon Perdrix. Graph States, Pivot Minor, and Universality of (X, Z)-Measurements. *International Journal of Unconventional Computing*, 9(1-2):153–171, 2013.
 - 31 Kang Feng Ng and Quanlong Wang. A universal completion of the zx-calculus. *arXiv preprint arXiv:1706.09877*, 2017.
 - 32 Simon Perdrix and Quanlong Wang. Supplementarity is necessary for quantum diagram reasoning. In *41st International Symposium on Mathematical Foundations of Computer Science (MFCS 2016)*, volume 58 of *Leibniz International Proceedings in Informatics (LIPIcs)*, pages 76:1–76:14, Krakow, Poland, August 2016. URL: <https://hal.archives-ouvertes.fr/hal-01361419>, doi:10.4230/LIPIcs.MFCS.2016.76.
 - 33 Robert Raussendorf and Hans J. Briegel. A one-way quantum computer. *Phys. Rev. Lett.*, 86:5188–5191, May 2001. URL: <http://link.aps.org/doi/10.1103/PhysRevLett.86.5188>, doi:10.1103/PhysRevLett.86.5188.
 - 34 M. Van den Nest, J. Dehaene, and B. De Moor. Graphical description of the action of local Clifford transformations on graph states. *Physical Review A*, 69(2):9422, 2004.
 - 35 Maarten Van Den Nest. Classical simulation of quantum computation, the Gottesman-Knill theorem, and slightly beyond. *Quantum Information & Computation*, 10(3):258–271, 2010.
 - 36 Renaud Vilmart. A near-optimal axiomatisation of zx-calculus for pure qubit quantum mechanics. 2018. URL: <https://arxiv.org/abs/1812.09114>, arXiv:arXiv:1812.09114.

A Example derivation

In this section we will work through a few complete examples of our simplification algorithm. While it is difficult to show significant reductions on such small circuits, except in very contrived examples, the following two examples start from circuits in the gate set $\{\text{CNOT}, \text{CZ}, X_\alpha, Z_\alpha, H\}$ which don't have any (obvious) gate-cancellations that would reduce the number of two-qubit gates. However, in both cases, we show reductions using our technique that eliminate 1-2 two-qubit gates and a handful of single-qubit gates.

First, let us start with the following circuit:

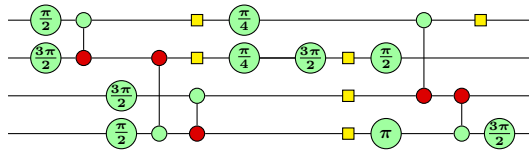

It has 5 two-qubit gates and 16 single-qubit gates.

We will need to convert it to a graph-like ZX-diagram first. Start by changing all the X-spiders into Z-spiders:

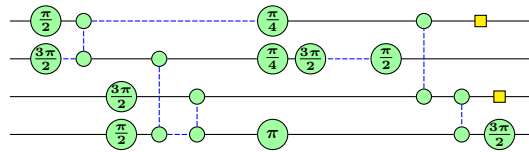

Next, fuse together all Z-spiders that are adjacent via a regular (non-Hadamard) edge:

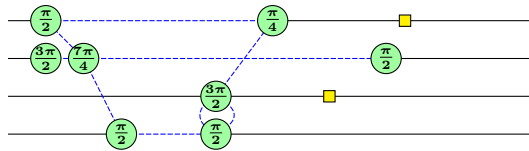

We remove the double edge between qubits 3 and 4 and reorganise the diagram a bit:

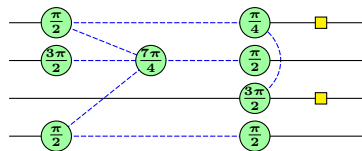

We see that in this case there is only a single interior vertex and it is non-Clifford, hence our main simplification routine does not need to do anything. The next step is to extract a circuit from this diagram. In this case this is relatively straightforward:

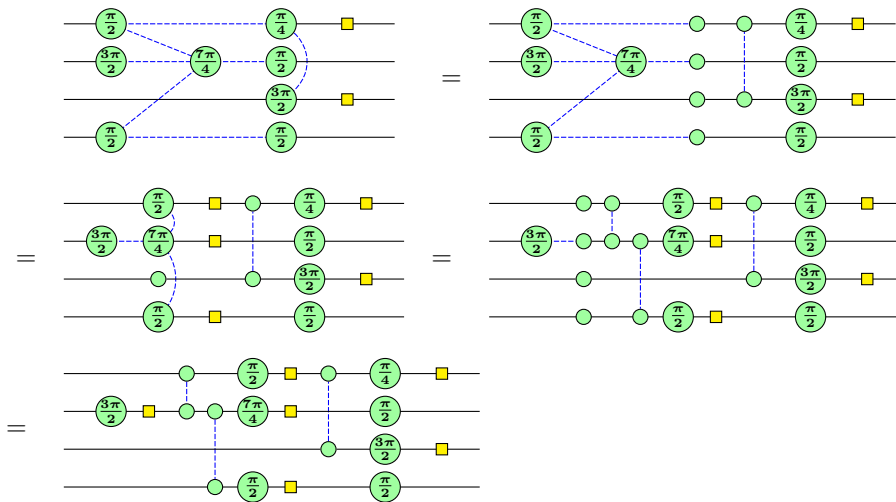

The resulting circuit has 3 two-qubit gates and 14 single-qubit gates.

Now, let's consider a harder example, of a similar size:

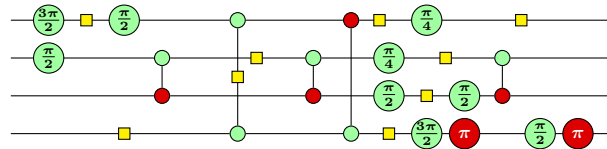

This has 5 two-qubit gates and 19 single-qubit gates. Doing the transformation to get it into graph-like form we get:

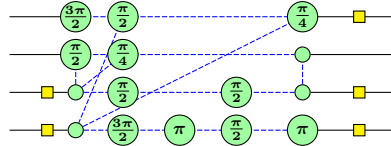

We see that in this case we have multiple interior Pauli and proper Clifford phases and hence we must do local complementations and pivots. We start by doing a sequence of local complementations. The locations of these operations are marked

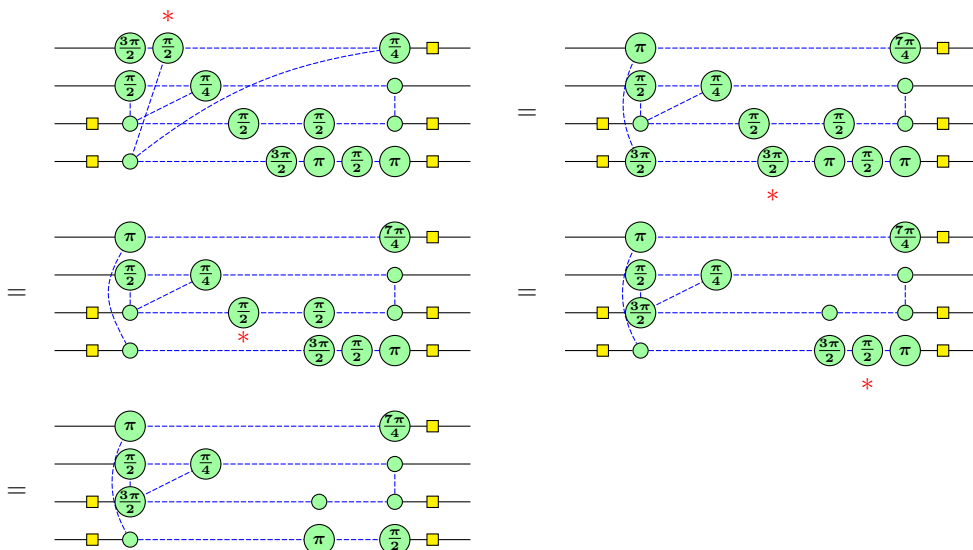

We now have two internal Pauli vertices left, but they are not connected. Hence we must use equation (7), to be able to get rid of them:

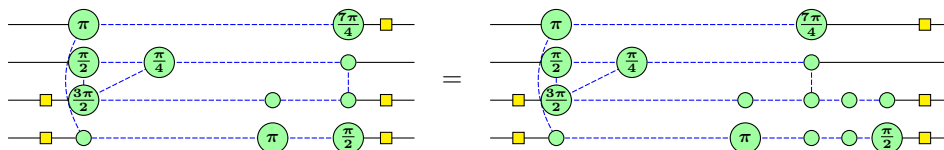

Applying the pivots to the designated vertices gives us:

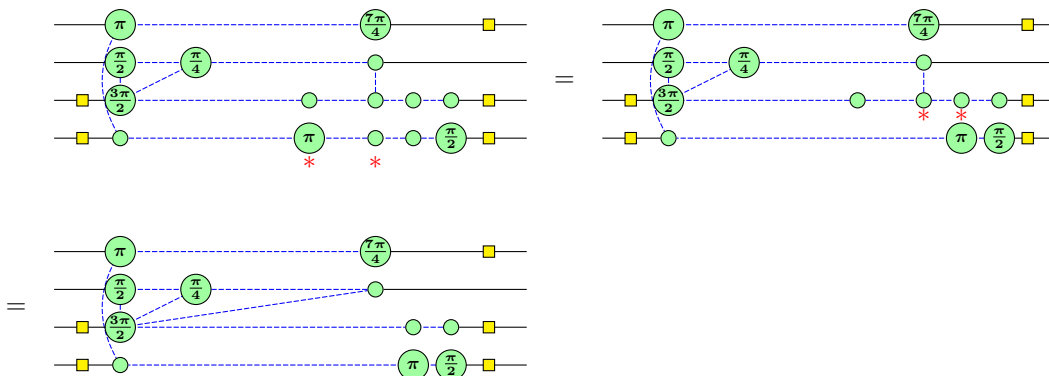

Note that in the bottom qubit we end up where we started before doing the pivots, but now we have marked the $\pi/2$ vertex as a local Clifford, and hence the π vertex now counts as a boundary vertex. This means the simplification procedure has ended. The final step is extracting a circuit.

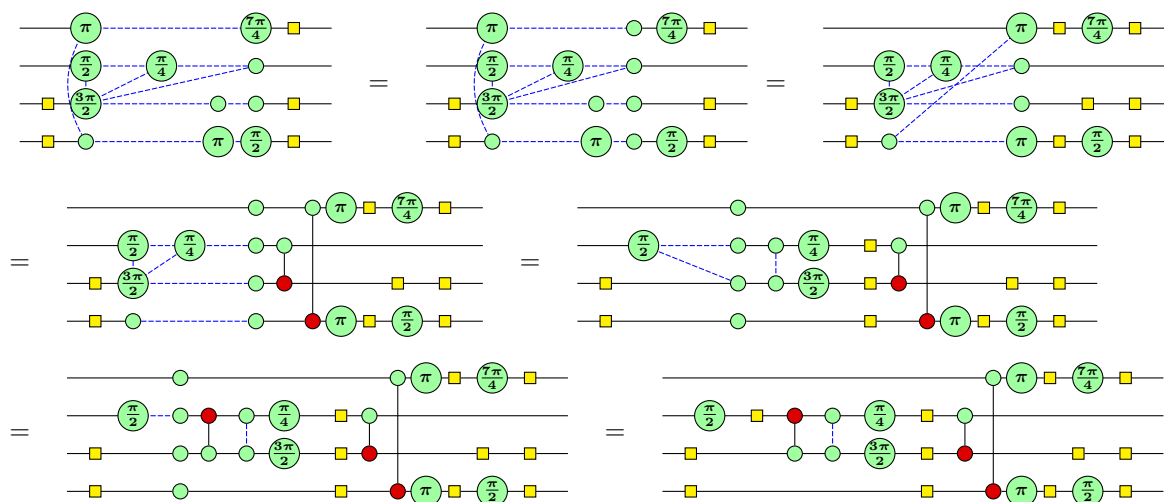

The extracted circuit has 4 two-qubit gates and 18 single-qubit gates. Applying some final cancellations between Hadamards on the inputs and outputs gets the number of single-qubit gates down to 14:

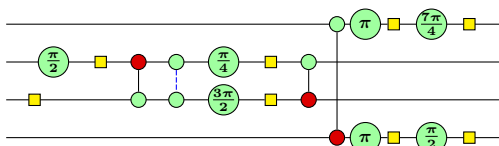

B Proofs

B.1 Derived Rules

► **Lemma B.1.** *The antipode rule,*

$$\text{---} \circlearrowleft \text{---} \stackrel{(a)}{=} \text{---} \circ \text{---}$$

is derivable in the ZX-calculus.

Proof. To derive the (a) rule we take advantage of the freedom to deform the diagram as shown below.

$$\begin{aligned} \text{---} \circlearrowleft \text{---} &= \text{---} \circlearrowright \text{---} \stackrel{(i1)}{=} \text{---} \circlearrowleft \text{---} \stackrel{(f)}{=} \text{---} \circlearrowright \text{---} \\ &\stackrel{(b)}{=} \text{---} \circ \text{---} \stackrel{(c)}{=} \text{---} \circ \text{---} \end{aligned}$$

The final equation is simply dropping the scalar. ◀

► **Lemma B.2.** *The π -copy rule,*

$$\text{---} \circlearrowleft \text{---} \stackrel{(\pi c)}{=} \begin{matrix} \pi \text{---} \\ \pi \text{---} \\ \vdots \\ \pi \text{---} \end{matrix}$$

is derivable in the ZX-calculus.

Proof. To derive the (πc) rule we use the (f) rule first to split the π -labelled vertex, and the (π) and (c) rules do the bulk of the work as shown below:

$$\begin{aligned} \text{---} \circlearrowleft \text{---} &\stackrel{(f)}{=} \text{---} \circlearrowleft \text{---} \stackrel{(\pi)}{=} \text{---} \circlearrowleft \text{---} \stackrel{(c)}{=} \begin{matrix} \pi \text{---} \\ \pi \text{---} \\ \vdots \\ \pi \text{---} \end{matrix} \stackrel{(f)}{=} \begin{matrix} \pi \text{---} \\ \pi \text{---} \\ \vdots \\ \pi \text{---} \end{matrix} \end{aligned}$$

B.2 Making ZX-diagrams graph-like

Here we prove Lemma 3.2 by giving a procedure to transform any ZX-diagram into a graph-like ZX-diagram.

1. First turn all the X-spiders into Z-spiders by introducing Hadamard gates using rules (i2) (backwards) and (h).
2. Apply rule (i2) to remove any two connected Hadamard gates. As a result each Hadamard gate is only connected to inputs, outputs and Z-spiders.
3. Fuse any two Z-spiders that are connected by a regular (non-Hadamard) edge, so that all connections between Z-spiders are via Hadamard edges.

4. Remove self-loops using the following rules:

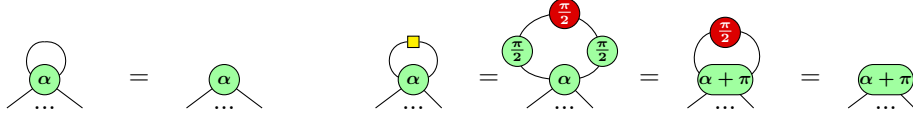

where the last equation follows from the **(a)** rule.

5. Remove parallel Hadamard-edges between Z-spiders using the **(a)** rule until only zero or one connections between all spiders are left:

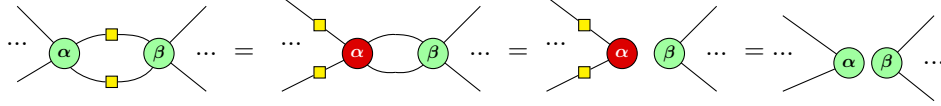

B.3 Circuits and Causal Flow

In Section 3 we presented *focused gFlow* as a sufficient condition for a ZX-diagram to correspond to a circuit. Here we give a simpler but weaker condition, *causal flow*.

► **Definition B.3.** [11] Given an open graph G , a causal flow (f, \prec) on G consists of a function $f : O^c \rightarrow I^c$ and a partial order \prec on the set V satisfying the following properties:

1. $f(v) \sim v$
2. $v \prec f(v)$
3. If $u \sim f(v)$ then $v \prec u$

where $v \sim u$ means that u and v are adjacent in the graph.

► **Remark B.4.** Causal flow, and focused gFlow are both examples of gFlow, but the converse does not hold. However, given a gFlow, we can efficiently transform it into a focused gFlow. A graph which has a gFlow does not necessarily have a causal flow [8].

In the one-way model [33], the existence of a causal flow on a graph implies that measurement-based quantum computation on the corresponding graph state is deterministic [11]. It plays a similar role for ZX-diagrams.

► **Definition B.5.** A graph-like ZX-diagram is called circuit-like if has the same number of inputs and outputs and its underlying graph admits a causal flow.

► **Proposition B.6.** Every circuit-like diagram corresponds to a quantum circuit.

Proof. Using the given flow (f, \prec) We will translate a circuit-like diagram into a circuit over the universal gate set Z_α , H , and CNOT.

We must first determine which edges in the diagram correspond to qubits and which correspond to interactions between qubits. Note that for each input i , the flow function f defines a path through the diagram $i \rightarrow f(i) \rightarrow f(f(i)) \rightarrow \dots$. By 2 and the fact that \prec is a partial order, such a path must terminate at an output; and by 3 each such input-to-output path is disjoint. Further, since the numbers of inputs and outputs are the same then every vertex of the diagram must occur on one such path.

Now we translate the vertices into gates tracing along the qubit paths. If the vertex has degree 2 it immediately yields a Z_α gate and an optional Hadamard gate if it was connected to its predecessor by a Hadamard edge. If vertex v has higher degree, let its neighbours, excluding its immediate predecessor and successor, be u_1, \dots, u_n . We decompose v into v_0, v_1, \dots, v_n as shown below:

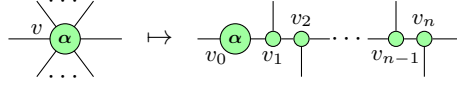

Note that the new vertices must be compatible with the original ordering, in the sense that if $u_i \sim v \sim u_j$ where $u_i \prec u_j$ then we require that $v_i \prec v_j$. By the flow conditions, none of the u_i belong to the same qubit as v , and since the diagram is graph-like all the u_i are connected via a Hadamard edge to v . Note that the updated diagram also admits a causal flow, obtained from the original one in the obvious manner. Hence all the higher degree vertices may be decomposed in the same way, to leave the diagram with no vertex of higher degree than three, and non-zero phases only in the degree two vertices. Then all the links between qubits may be replaced by CZ gates; since \prec defines a partial order on the vertices, we are guaranteed this is well-defined. \blacktriangleleft

The following proof of Lemma 3.9 shows that the diagrams produced by making a circuit graph-like according to the procedure outlined in Lemma 3.2 have causal flow.

Proof of Lemma 3.9. Let D denote the circuit, and let D' denote the diagram produced by applying the procedure of Lemma 3.2 to D .

In order to prove that D' has a focussed gFlow, we will show that it has a causal flow, which by the remarks above is sufficient.

With every spider v of the circuit D we associate a number q_v specifying on which ‘qubit-line’ it appears. We also associate a ‘row-number’ $r_v \geq 0$ specifying how ‘deep’ in the circuit it appears. Suppose now that $v \sim w$ in D . If they are on the same qubit, so $q_v = q_w$, then necessarily $r_v \neq r_w$. Conversely, if they are on different qubits, $q_v \neq q_w$, then they must be part of a CZ or CNOT gate, and hence $r_v = r_w$.

In the diagram resulting from Lemma 3.2, every spider arises from fusing together adjacent spiders on the same qubit line from the original diagram. For a spider v in D' we can thus associate two numbers s_v , and t_v , where s_v is the lowest row-number of a spider fused into v , and t_v is the highest. Spider fusion from D only happens for spiders on the same qubit-line, and hence v also inherits a q_v from all the spiders that got fused into it. Any two spiders v and w in D' with $q_v = q_w$ must have been produced by fusing together adjacent spiders on the same qubit-line, and hence we must have $t_v < s_w$ or $t_w < s_v$, depending on which of the spiders is most to the left. If instead $v \sim w$ and $q_v \neq q_w$, then their connection must have arisen from some CNOT or CZ gate in D , and hence the intervals $[s_v, t_v]$ and $[s_w, t_w]$ must have overlap, so that necessarily $s_w \leq t_v$ and $s_v \leq t_w$.

Now we let O be the set of spiders connected to an output, and I the set of spiders connected to an input in D' . For all $v \in O^c$ we let $f(v)$ be the unique connected spider to the right of v on the same qubit-line. We define the partial order as follows: $v \prec w$ if and only if $v = w$ or $t_v < t_w$. It is straightforward to check that this is indeed a partial order.

By construction $f(v) \sim v$ and the property $v \prec f(v)$, follows from $t_v < s_{f(v)}$ discussed above, so let us look at the third property of causal flow.

Suppose $w \sim f(v)$. We need to show that $v \prec w$. If $v = w$ this is trivial so suppose $v \neq w$. First suppose that $q_w = q_{f(v)}$ (which is also equal to q_v). $f(v)$ has a maximum of two neighbours on the same qubit-line, and since one of them is v , this can only be if $w = f(f(v))$ and hence $v \prec f(v) \prec w$, and we are done. So suppose that $q_w \neq q_{f(v)}$. By the discussion above, we must then have $s_w \leq t_{f(v)}$ and $s_{f(v)} \leq t_w$. Since we also have $t_v < s_{f(v)}$ we get $t_v < s_{f(v)} \leq t_w$ so that indeed $v \prec w$. \blacktriangleleft

B.4 Preservation of focused gFlow

B.4.1 Local complementation

The following lemma will be needed in the other proofs.

► **Lemma B.7.** *Given a graph $G = (V, E)$, $A \subseteq V$ and $u \in V$,*

$$\text{Odd}_{G \star u}(A) = \begin{cases} \text{Odd}_G(A) \Delta (N_G(u) \cap A) & \text{if } u \notin \text{Odd}_G(A) \\ \text{Odd}_G(A) \Delta (N_G(u) \setminus A) & \text{if } u \in \text{Odd}_G(A) \end{cases}$$

where $A \Delta B := (A \cup B) \setminus (A \cap B)$ is the symmetric difference of A and B .

Proof. First notice that $\text{Odd}_G(\cdot)$ is linear: $\forall A, B, \text{Odd}_G(A \Delta B) = \text{Odd}_G(A) \Delta \text{Odd}_G(B)$. Moreover $\forall v, \text{Odd}_G(\{v\}) = N_G(v)$, the neighbourhood of v in G . As a consequence, $\forall A, \text{Odd}_G(A) = \Delta_{v \in A} N_G(v)$.

The local complementation is acting as follows on the neighbourhoods:

$$\forall v, N_{G \star u}(v) = \begin{cases} N_G(v) \Delta N_G(u) \Delta \{v\} & \text{if } v \in N_G(u) \\ N_G(v) & \text{otherwise} \end{cases}$$

As a consequence,

$$\begin{aligned} \text{Odd}_{G \star u}(A) &= \Delta_{v \in A} N_{G \star u}(v) \\ &= (\Delta_{v \in A \cap N_G(u)} N_G(v) \Delta N_G(u) \Delta \{v\}) \Delta (\Delta_{v \in A \setminus N_G(u)} N_G(v)) \\ &= (\Delta_{v \in A} N_G(v)) \Delta (\Delta_{v \in A \cap N_G(u)} N_G(u)) \Delta (\Delta_{v \in A \cap N_G(u)} \{v\}) \\ &= \text{Odd}_G(A) \Delta (\Delta_{v \in A \cap N_G(u)} N_G(u)) \Delta (A \cap N_G(u)) \end{aligned}$$

Notice that $|A \cap N_G(u)| = 1 \pmod 2$ iff $u \in \text{Odd}_G(A)$. Hence, if $u \notin \text{Odd}_G(A)$, $\text{Odd}_{G \star u}(A) = \text{Odd}_G(A) \Delta (A \cap N_G(u))$. Otherwise, if $u \in \text{Odd}_G(A)$, $\text{Odd}_{G \star u}(A) = \text{Odd}_G(A) \Delta N_G(u) \Delta (A \cap N_G(u)) = \text{Odd}_G(A) \Delta (N_G(u) \setminus A)$. ◀

Proof of Lemma 4.6. If (g, \prec) is a focused gFlow for (G, I, O) then (g', \prec) is a focused gFlow for $(G \star u \setminus u, I, O)$ where $g' : O^c \setminus \{u\} \rightarrow 2^{I^c \setminus \{u\}}$ is inductively defined as

$$g'(w) := \begin{cases} g(w) \Delta_{t \in R_w} g'(t) & \text{if } u \notin g(w) \\ g(w) \Delta \{u\} \Delta g(u) \Delta_{t \in R_u} \Delta_{R_w} g'(t) & \text{otherwise} \end{cases}$$

where $R_w := N_G(u) \cap g(w) \cap O^c$.

First of all, g' can indeed be defined inductively by starting at the maximal elements in the partial order, since for any $t \in R_w$, $t \in g(w)$ so that $w \prec t$, and similarly when $u \in g(w)$, $w \prec u$ so $t \in R_u$ implies $u \prec t$ hence $w \prec t$. That g' preserves the order, i.e. $v \in g'(w) \implies w \prec v$, follows similarly. Moreover, it is easy to show that $\forall w \in O^c \setminus \{u\}$, $g'(w) \subseteq I^c \setminus \{u\}$. It remains to show that $\forall w \in O^c \setminus \{u\}, \text{Odd}_{G \star u \setminus u}(g'(w)) \cap O^c = \{w\}$, or equivalently, $\forall w \in O'^c, \text{Odd}_{G \star u}(g'(w)) \cap O'^c = \{w\}$ where $O' := O \cup \{u\}$.

First notice that for any $w \in O'^c$, $u \notin \text{Odd}_G(g(w))$, so, according to Lemma B.7, and using the linearity of $\text{Odd}(\cdot)$ and the distributivity of \cap over Δ ,

$$\begin{aligned} \text{Odd}_{G \star u}(g(w)) \cap O'^c &= \text{Odd}_G(g(w)) \cap O'^c \Delta (N_G(u) \cap g(w) \cap O'^c) \\ &= \{w\} \Delta R_w \end{aligned}$$

Moreover, $u \in \text{Odd}_G(g(u))$, so

$$\begin{aligned}
\text{Odd}_{G \star u}(\{u\} \Delta g(u)) \cap O'^c &= (N_{G \star u}(u) \Delta \text{Odd}_{G \star u}(g(u))) \cap O'^c \\
&\stackrel{\text{(Lemma B.7)}}{=} (N_G(u) \Delta \text{Odd}_G(g(u)) \Delta (N_G(u) \setminus g(u))) \cap O'^c \\
&= (\text{Odd}_G(g(u)) \cap O'^c) \Delta (N_G(u) \cap g(u) \cap O'^c) \\
&= N_G(u) \cap g(u) \cap O'^c \\
&= R_u
\end{aligned}$$

As a consequence,

$$\text{Odd}_{G \star u}(g'(w)) \cap O'^c = \begin{cases} \{w\} \Delta R_w \Delta_{t \in R_w} \text{Odd}_{G \star u}(g'(t)) \cap O'^c & \text{if } u \notin g(w) \\ \{w\} \Delta R_w \Delta R_u \Delta_{t \in R_u \Delta R_w} \text{Odd}_{G \star u}(g'(t)) \cap O'^c & \text{otherwise} \end{cases}$$

Now, we prove that $\forall w \in O'^c, \text{Odd}_{G \star u}(g'(w)) \cap O'^c = \{w\}$ by induction on w starting at maximal elements in the order.

Let $w_0 \in O'^c$ be maximal for \prec i.e. $\forall w \in O'^c, \neg(w_0 \prec w)$. By maximality we must have $g(w_0) \subseteq O'$ and hence $R_{w_0} = \emptyset$. If $u \notin g(w_0)$, it implies that $\text{Odd}_{G \star u}(g'(w_0)) \cap O'^c = \{w_0\}$. If $u \in g(w_0)$, then $w_0 \prec u$, so u is maximal, so $g(u) \subset O$ and $R_u = \emptyset$, as a consequence $\text{Odd}_{G \star u}(g'(w)) \cap O'^c$ is also equal to $\{w_0\}$ in this case.

By induction, for any $w \in O'^c$,

- If $u \notin g(w)$,
$$\begin{aligned}
\text{Odd}_{G \star u}(g'(w)) \cap O'^c &= \{w\} \Delta R_w \Delta_{t \in R_w} \text{Odd}_{G \star u}(g'(t)) \cap O'^c \\
&\stackrel{(IH)}{=} \{w\} \Delta R_w \Delta_{t \in R_w} t \\
&= \{w\} \Delta R_w \Delta R_w \\
&= \{w\}
\end{aligned}$$
- If $u \in g(w)$,
$$\begin{aligned}
\text{Odd}_{G \star u}(g'(w)) \cap O'^c &= \{w\} \Delta R_w \Delta R_u \Delta_{t \in R_u \Delta R_w} \text{Odd}_{G \star u}(g'(t)) \cap O'^c \\
&\stackrel{(IH)}{=} \{w\} \Delta R_w \Delta R_u \Delta_{t \in R_u \Delta R_w} t \\
&= \{w\} \Delta R_w \Delta R_u \Delta R_u \Delta R_w \\
&= \{w\}
\end{aligned}$$

◀

► **Remark B.8.** If (g, \prec) is a focused gFlow for (G, I, O) then (g', \prec) is a gFlow for $(G \star u \setminus u, I, O)$ where $g' : O^c \setminus \{u\} \rightarrow 2^{I^c \setminus \{u\}}$ is defined as

$$g'(w) := \begin{cases} g(w) & \text{if } u \notin g(w) \\ g(w) \Delta \{u\} \Delta g(u) & \text{otherwise} \end{cases}$$

Notice that (g', \prec) is not necessarily a *focused* gFlow.

B.4.2 Pivoting

The action of the pivoting on the odd-neighbourhood can be described as follows:

► **Lemma B.9.** *Given a graph $G = (V, E)$, $A \subseteq V$, $u \in V$, and $v \in N_G(u)$,*

$$\text{Odd}_{G \wedge uv}(A) = \begin{cases} \text{Odd}_G(A) & \text{if } u, v \notin \text{Odd}_G[A] \\ \text{Odd}_G(A) \Delta N_G[v] & \text{if } u \in \text{Odd}_G[A], v \notin \text{Odd}_G[A] \\ \text{Odd}_G(A) \Delta N_G[u] & \text{if } u \notin \text{Odd}_G[A], v \in \text{Odd}_G[A] \\ \text{Odd}_G(A) \Delta N_G[u] \Delta N_G[v] & \text{if } u, v \in \text{Odd}_G[A] \end{cases}$$

where $N_G[u] := N_G(u) \Delta \{u\}$ and $\text{Odd}_G[A] := \text{Odd}_G(A) \Delta A$ are the closed neighbourhood and the closed odd neighbourhood respectively.

Proof. The pivoting acts as follows on neighbourhoods:

$$\forall w, N_{G \wedge uv}(w) = \begin{cases} N_G(w) \Delta N_G[u] \Delta N_G[v] & \text{if } w \in N_G[u] \cap N_G[v] \\ N_G(w) \Delta N_G[v] & \text{if } w \in N_G[u] \setminus N_G[v] \\ N_G(w) \Delta N_G[u] & \text{if } w \in N_G[v] \setminus N_G[u] \\ N_G(w) & \text{otherwise} \end{cases}$$

As a consequence,

$$\begin{aligned} \text{Odd}_{G \wedge uv}(A) &= \Delta_{w \in A} N_{G \wedge uv}(w) \\ &= \Delta_{w \in A \cap N_G[u] \cap N_G[v]} N_{G \wedge uv}(w) \Delta_{w \in A \cap N_G[u]^c \cap N_G[v]^c} N_{G \wedge uv}(w) \\ &\quad \Delta_{w \in A \cap N_G[u]^c \cap N_G[v]} N_{G \wedge uv}(w) \Delta_{w \in A \cap N_G[u] \cap N_G[v]^c} N_{G \wedge uv}(w) \\ &= \Delta_{w \in A \cap N_G[u] \cap N_G[v]} (N_G(w) \Delta N_G[u] \Delta N_G[v]) \Delta_{w \in A \cap N_G[u]^c \cap N_G[v]^c} N_G(w) \\ &\quad \Delta_{w \in A \cap N_G[u]^c \cap N_G[v]} (N_G(w) \Delta N_G[u]) \Delta_{w \in A \cap N_G[u] \cap N_G[v]^c} (N_G(w) \Delta N_G[v]) \\ &= \text{Odd}_G(A) \Delta_{w \in A \cap N_G[v]} N_G[u] \Delta_{w \in A \cap N_G[u]} N_G[v] \end{aligned}$$

Notice that $|A \cap N_G[u]| = 1 \pmod 2$ iff $u \in \text{Odd}_G[A]$. Thus

$$\text{Odd}_{G \wedge uv}(A) = \begin{cases} \text{Odd}_G(A) & \text{if } u, v \notin \text{Odd}_G[A] \\ \text{Odd}_G(A) \Delta N_G[v] & \text{if } u \in \text{Odd}_G[A], v \notin \text{Odd}_G[A] \\ \text{Odd}_G(A) \Delta N_G[u] & \text{if } u \notin \text{Odd}_G[A], v \in \text{Odd}_G[A] \\ \text{Odd}_G(A) \Delta N_G[u] \Delta N_G[v] & \text{if } u, v \in \text{Odd}_G[A] \end{cases}$$

◀

Proof of Lemma 4.5. If (g, \prec) is a focused gFlow for (G, I, O) then (g', \prec) is a focused gFlow for $(G \wedge uv \setminus uv, I, O)$ where g' is defined as follows: $\forall w \in O^c \setminus \{u, v\}$

$$g'(w) := g(w) \setminus \{u, v\}$$

It remains to show that $\forall w \in O^c \setminus \{u, v\}, \text{Odd}_{G \wedge uv \setminus uv}(g'(w)) \cap O^c = \{w\}$, or equivalently, $\forall w \in O^c, \text{Odd}_{G \wedge uv}(g'(w)) \cap O^c = \{w\}$ where $O' := O \cup \{u, v\}$.

Let $w \in O'^c$. Note that $\text{Odd}_G[g(w)] = \text{Odd}_G(g(w)) \Delta g(w) = \{w\} \Delta g(w) = g(w) \cup \{w\}$, and thus $u \in \text{Odd}_G[g(w)] \iff u \in g(w)$ and similarly for v . Hence:

$$\begin{aligned} \blacksquare \text{ If } u, v \in g(w), \\ \text{Odd}_{G \wedge uv}(g'(w)) \cap O'^c &= \text{Odd}_{G \wedge uv}(g(w) \Delta \{u, v\}) \cap O'^c \\ &= \text{Odd}_{G \wedge uv}(g(w)) \cap O'^c \Delta \text{Odd}_{G \wedge uv}(\{u, v\}) \cap O'^c \\ &= \text{Odd}_G(g(w)) \cap O'^c \Delta (N_G[u] \Delta N_G[v]) \cap O'^c \Delta \text{Odd}_G(\{u, v\}) \cap O'^c \\ &= \text{Odd}_G(g(w)) \cap O'^c \Delta \text{Odd}_G(\{u, v\}) \cap O'^c \Delta \text{Odd}_G(\{u, v\}) \cap O'^c \\ &= \{w\} \\ \blacksquare \text{ If } u \in g(w) \text{ and } v \notin g(w), \\ \text{Odd}_{G \wedge uv}(g'(w)) \cap O'^c &= \text{Odd}_{G \wedge uv}(g(w) \Delta \{u\}) \cap O'^c \\ &= \text{Odd}_{G \wedge uv}(g(w)) \cap O'^c \Delta \text{Odd}_{G \wedge uv}(\{u\}) \cap O'^c \\ &= \text{Odd}_G(g(w)) \cap O'^c \Delta N_G[v] \cap O'^c \Delta \text{Odd}_G(\{v\}) \cap O'^c \\ &= \{w\} \end{aligned}$$

Here we have used that $\text{Odd}_{G \wedge uv}(\{u\}) = N_G(v)$ and that $N_G[v] \cap O'^c = N_G(v) \cap O'^c$.

- If $u \notin g(w)$ and $v \in g(w)$ we prove it similarly to the previous case.
- If $u, v \notin g(w)$,

$$\begin{aligned} \text{Odd}_{G \wedge uv}(g'(w)) \cap O'^c &= \text{Odd}_{G \wedge uv}(g(w)) \cap O'^c \\ &= \text{Odd}_G(g(w)) \cap O'^c \\ &= \{w\} \end{aligned}$$



B.5 ZX reduction rules

▷ Lemma (5.2).

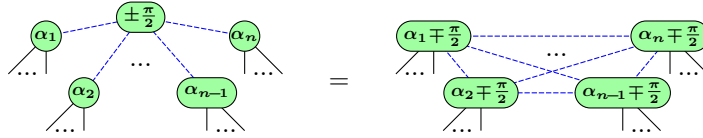

Proof. First of all, we will need the following equation:

$$\textcircled{\pm \frac{\pi}{2}} = \textcircled{\pm \frac{\pi}{2}} \textcircled{\square} = \textcircled{\pm \frac{\pi}{2}} \textcircled{\pm \frac{\pi}{2}} \textcircled{\pm \frac{\pi}{2}} \textcircled{\pm \frac{\pi}{2}} = \textcircled{\pm \frac{\pi}{2}} \textcircled{\pm \frac{\pi}{2}} \textcircled{\pm \frac{\pi}{2}} = \textcircled{\pm \frac{\pi}{2}} \textcircled{\pm \frac{\pi}{2}} = \textcircled{\pm \frac{\pi}{2}} \quad (9)$$

And now, using the ZX-calculus rules and the local complementation lemma:

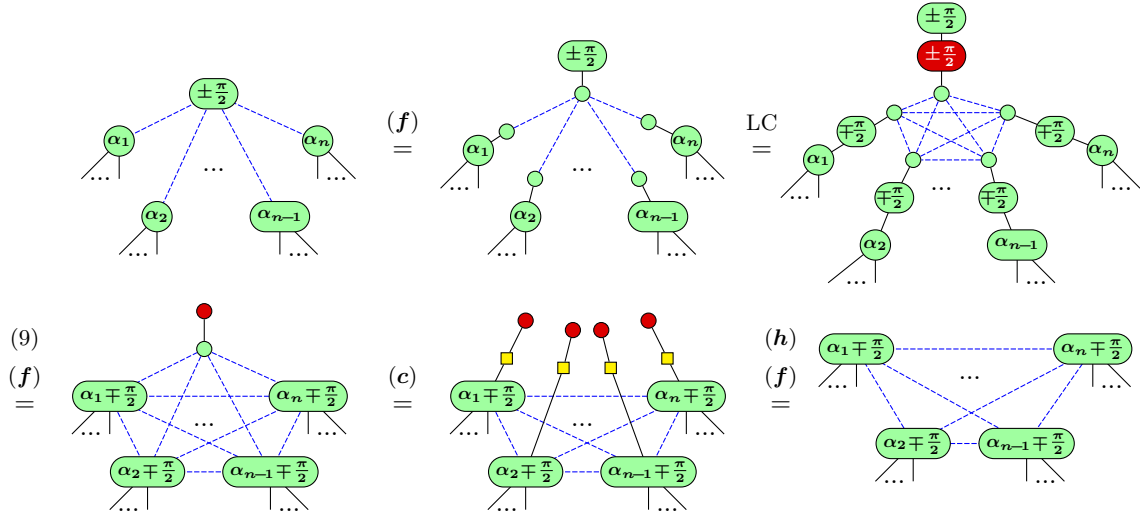

▷ Lemma (5.3).

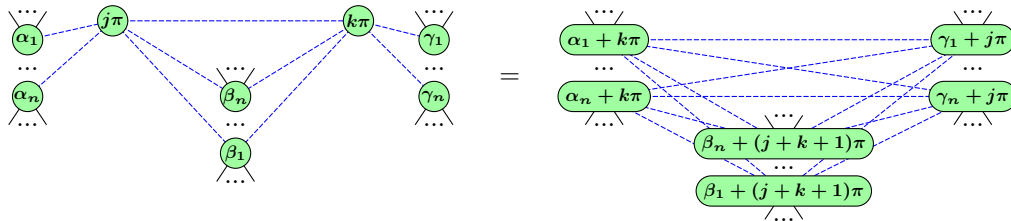

Proof. Using the ZX-calculus rules and the pivoting lemma:



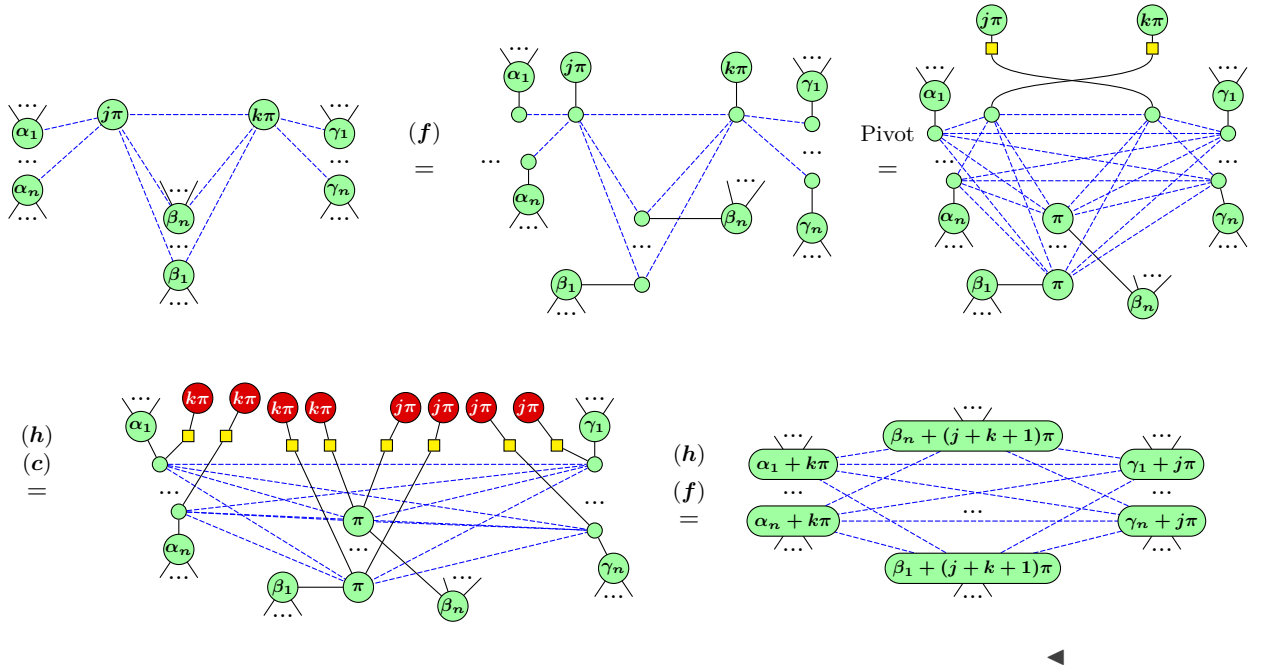

▷ Proposition (7.1). The following equation holds.

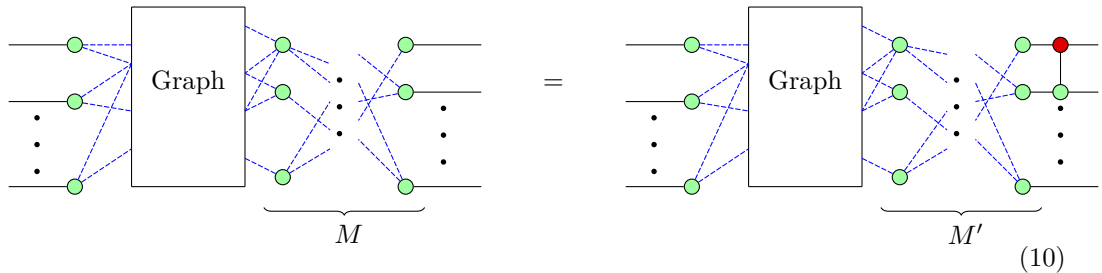

Here M describes the biadjacency matrix of the relevant vertices, and M' is the matrix produced by starting with M and then adding row 2 to row 1, taking sums modulo 2. Furthermore, if the diagram on the lefthandside has a focused gFlow, then so does the righthandside.

Proof. We will show how to transform the first diagram into the second in such a way that gFlow and equality is preserved at every step. For clarity we will not draw the entire diagram, but instead we focus on the relevant part. First of all we note that we can add CNOTs in the following way while preserving equality:

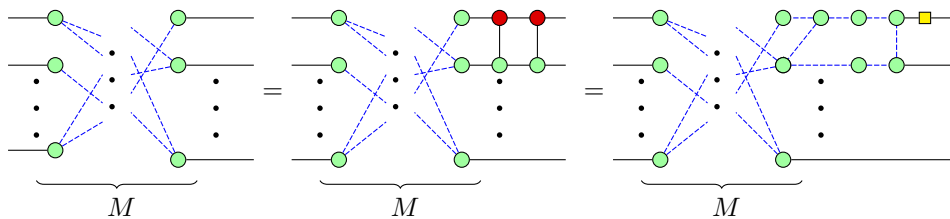

As we are only adding vertices at the outputs, it should be clear how the gFlow can be extended to incorporate these new vertices.

Now let A denote the set of vertices connected to the top vertex, but not to the vertex beneath it, B the set of vertices connected to both, and C the vertices connected only to the bottom one. Further restricting our view of the diagram to just these two lines, we see that we can apply a pivot rewrite as in (6):

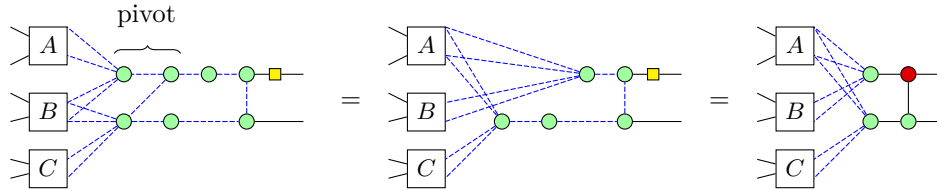

By Proposition 5.4 this rewrite preserves the gFlow. Looking at the connectivity matrix, it is straightforward to see that the matrix M has now been changed in exactly the way described. ◀

C Pseudo-code for extraction algorithm



Algorithm 1 Extraction algorithm

```

1: procedure EXTRACT( $D$ )                                     ▷ Input is graph-like diagram  $D$ 
2:   Init empty circuit  $C$ 
3:    $G, I, O \leftarrow \text{Graph}(D)$                              ▷ Get the underlying graph of  $D$ 
4:    $F \leftarrow O$                                            ▷ Initialize the frontier
5:   for  $v \in F$  do
6:     if  $v$  connected to output by Hadamard then
7:        $C \leftarrow \text{Hadamard}(\text{Qubit}(v))$ 
8:       Remove Hadamard from  $v$  to output
9:     if  $v$  has nonzero phase then
10:       $C \leftarrow \text{Phase-gate}(\text{Phase}(v), \text{Qubit}(v))$ 
11:    for edge between  $v$  and  $w$  in  $F$  do
12:       $C \leftarrow \text{CZ}(\text{Qubit}(v), \text{Qubit}(w))$ 
13:      Remove edge between  $v$  and  $w$ 
14:    while  $\exists v \in D \setminus F$  do                             ▷ There are still vertices to be processed
15:       $D, F, C \leftarrow \text{UpdateFrontier}(D, F, C)$ 
16:    for  $v \in F$  do                                           ▷ At this point, the only vertices of  $D$  are in  $F$ 
17:      if  $v$  connected to input via Hadamard then
18:         $C \leftarrow \text{Hadamard}(\text{Qubit}(v))$ 
19:      Perm  $\leftarrow$  Permutation of Qubits of  $F$  to qubits of inputs
20:      for swap( $q_1, q_2$ ) in PermutationAsSwaps(Perm) do
21:         $C \leftarrow \text{swap}(q_1, q_2)$ 
22:    return  $C$ 
23: procedure UPDATEFRONTIER( $D, F, C$ )
24:    $N \leftarrow \text{Neighbours}(F)$ 
25:    $M \leftarrow \text{biadjacency}(F, N)$  ▷ Biadjacency matrix between frontier and its neighbours
26:    $M' \leftarrow \text{GaussReduce}(M)$                                ▷ Do full Gaussian reduce on  $M$ 
27:   Init  $ws$                                                     ▷ Initialize empty set  $ws$ 
28:   for row  $r$  in  $M'$  do
29:     if sum( $r$ ) == 1 then                                     ▷ There is a single 1 on row  $r$ 
30:       Set  $w$  to vertex corresponding to nonzero column of  $r$ 
31:       Add  $w$  to  $ws$                                            ▷  $w$  will be part of the new frontier
32:    $M \leftarrow \text{biadjacency}(F, ws)$                              ▷ Smaller biadjacency matrix
33:   for  $r_1, r_2 \in \text{GaussRowOperations}(M)$  do
34:      $C \leftarrow \text{CNOT}(\text{Qubit}(r_1), \text{Qubit}(r_2))$ 
35:     Update  $D$  based on row operation
36:   for  $w \in ws$  do                                           ▷ Now, all  $w$  have a unique neighbour in  $F$ 
37:      $v \leftarrow$  Unique neighbour of  $w$  in  $F$ 
38:      $C \leftarrow \text{Hadamard}(\text{Qubit}(v))$ 
39:      $C \leftarrow \text{Phase-gate}(\text{Phase}(w), \text{Qubit}(v))$ 
40:     Remove phase from  $w$ 
41:     Remove  $v$  from  $F$ 
42:     Add  $w$  to  $F$ 
43:   for edge between  $w_1$  and  $w_2$  of  $ws$  do
44:      $C \leftarrow \text{CZ}(\text{Qubit}(w_1), \text{Qubit}(w_2))$ 
45:     Remove edge between  $w_1$  and  $w_2$ 
46:   return  $D, F, C$ 

```
