

FROM A KAC ALGEBRA SUBFACTOR TO DRINFELD DOUBLE

SANDIPAN DE

ABSTRACT. Given a finite-index and finite-depth subfactor, we define the notion of *quantum double inclusion* - a certain unital inclusion of von Neumann algebras constructed from the given subfactor - which is closely related to that of Ocneanu's asymptotic inclusion. We show that the quantum double inclusion when applied to the Kac algebra subfactor $R^H \subset R$ produces Drinfeld double of H where H is a finite-dimensional Kac algebra acting outerly on the hyperfinite II_1 factor R and R^H denotes the fixed-point subalgebra. More precisely, quantum double inclusion of $R^H \subset R$ is isomorphic to $R \subset R \rtimes D(H)^{cop}$ where $D(H)$ denotes the Drinfeld double of H .

INTRODUCTION

Ocneanu introduced a new construction of a finite-index and finite-depth subfactor, the *asymptotic inclusion*, associated to a finite-index and finite-depth subfactor and announced that the asymptotic inclusion could be viewed as the subfactor analogue of Drinfeld's quantum double construction. This connection has since been clarified by a number of authors including Evans-Kawahigashi [5], Izumi [7, 8] and Müger [17] and the precise formulation of Ocneanu's analogy is that the bimodule category arising from the asymptotic inclusion is the Drinfeld center of the bimodule category of the original subfactor. In [17] Müger remarked that - see [17, Remark 8.7] - the asymptotic subfactor of $R^H \subset R$, where H is a finite-dimensional Kac algebra acting outerly on the hyperfinite II_1 factor R and R^H is the fixed-point subalgebra, cannot be isomorphic to $R^{D(H)} \subset R$ or its dual, where $D(H)$ is the Drinfeld double of H , since the index of the asymptotic subfactor of $R^H \subset R$ coincides with the index of $R^H \subset R$. This gave rise to a natural question: Starting with $R^H \subset R$, is it possible to obtain $R^{D(H)} \subset R$ or its dual by some procedure. This answer is known to the experts but does not appear to have been published anywhere with details and we feel it deserves to be better known. Algebraic version of this result appears in [2] while this paper treats the subfactor theoretic aspect. In this article, we show that a modification of the asymptotic inclusion, which we call *quantum double inclusion*, does the job. More precisely, we show that quantum double inclusion of $R^H \subset R$ is isomorphic to $R \subset R \rtimes D(H)^{cop}$ for some outer action of $D(H)^{cop}$ on R and this is the main result of this article.

Let $N \subset M$ be a finite-index subfactor of finite-depth and let $N(= M_0) \subset M(= M_1) \subset M_2 \subset M_3 \subset \dots$ be the Jones' basic construction tower of $N \subset M$. Let M_∞ denote the II_1 factor obtained as the von Neumann closure $(\cup_{n=0}^\infty M_n)''$ in the GNS representation with respect to the trace on $\cup_{n=0}^\infty M_n$. Recall that - see [4], for instance - the inclusion $M \vee (M' \cap M_\infty) \subset M_\infty$ is defined as the asymptotic inclusion constructed from $N \subset M$ where, of course, $M \vee (M' \cap M_\infty)$ denotes the von Neumann algebra generated by M and $M' \cap M_\infty$. We define the inclusion $N \vee (M' \cap M_\infty) \subset M_\infty$ to be the *quantum double inclusion* of $N \subset M$ where $N \vee (M' \cap M_\infty)$ denotes the von Neumann algebra generated by N and $M' \cap M_\infty$.

One of the main steps towards understanding the quantum double inclusion associated to the subfactor $R^H \subset R$ is to construct a model of this. Given any finite-dimensional Kac algebra H , let H^i , where i is any integer, denote H or H^* according as i is odd or even. In §3 we construct a

2010 *Mathematics Subject Classification.* 46L37, 16S40, 16T05.

Key words and phrases. Subfactors, Hopf algebras, Planar algebras.

subfactor $\mathcal{N} \subset \mathcal{M}$ where $\mathcal{N} = ((\cdots \rtimes H^{-3} \rtimes H^{-2} \rtimes H^{-1}) \otimes (H^2 \rtimes H^3 \rtimes \cdots))''$, $\mathcal{M} = (\cdots \rtimes H^{-1} \rtimes H^0 \rtimes H^1 \rtimes \cdots)''$ and show that $\mathcal{N} \subset \mathcal{M}$ is a model for the quantum double inclusion of $R^H \subset R$. In §5, we give an explicit description of the planar algebra associated to the subfactor $\mathcal{N} \subset \mathcal{M}$ which turns out to be an interesting planar subalgebra of ${}^{*(2)}P(H^*)$ (the adjoint of the 2-cabling of the planar algebra of H^*). The proofs all rely on explicit pictorial computations in the planar algebra of H^* . Finally, the description of the planar algebra of $\mathcal{N} \subset \mathcal{M}$ obtained in §5 is used in §6 to prove that $\mathcal{N} \subset \mathcal{M}$ is isomorphic to $R \subset R \rtimes D(H)^{cop}$ for some outer action of $D(H)^{cop}$ on the hyperfinite II_1 factor R .

We give below a brief section-wise description of the contents of this paper.

§1: The goal of this section is to summarise relevant facts concerning crossed products by Kac algebras. We begin with recalling the notion of action of a Kac algebra on a complex $*$ -algebra and given such an action, we describe the construction of the crossed product algebra. We then introduce the notion of infinite iterated crossed products. Using this we define a family, indexed by positive integers, of inclusions of (infinite-dimensional) algebras which will be used in §3 in order to understand the model for quantum double inclusion of $R^H \subset R$.

§2: In section §2.1, we collect together results concerning subfactor planar algebras. We begin with introducing a few important tangles we need. Next, we discuss two methods of constructing new planar algebras from the old, namely, cabling and adjoint and also recall two important theorems - one concerning ‘generating set of tangles’ and the other being the fundamental theorem due to Jones relating subfactors and subfactor planar algebras - which we shall use in §5 in order to describe $P^{\mathcal{N} \subset \mathcal{M}}$. In §2.2 we briefly discuss the planar algebra associated to a Kac algebra in terms of generators and relations and identify its vector spaces explicitly in terms of iterated crossed products of the Kac algebra and its dual.

The material of the first 2 sections is all very well known and is meant just to establish notation for the convenience of the reader.

§3: This section is devoted to constructing a model for the quantum double inclusion of $R^H \subset R$. The main result of this section is Proposition 19 which shows that the subfactor $\mathcal{N} \subset \mathcal{M}$, where $\mathcal{N} = ((\cdots \rtimes H^{-3} \rtimes H^{-2} \rtimes H^{-1}) \otimes (H^2 \rtimes H^3 \rtimes \cdots))''$ and $\mathcal{M} = (\cdots \rtimes H^{-1} \rtimes H^0 \rtimes H^1 \rtimes \cdots)''$, is a model for the quantum double inclusion of $R^H \subset R$.

§4: This section begins with §4.1 which paves the way for constructing the basic construction tower of the subfactor $\mathcal{N} \subset \mathcal{M}$ by studying some finite-dimensional basic constructions associated to inclusions of finite iterated crossed product algebras, the main result being Proposition 22. In §4.2 the basic construction tower of $\mathcal{N} \subset \mathcal{M}$ is explicitly constructed in Proposition 28. In §3.3, we compute the relative commutants of the basic construction towers using Ocneanu’s compactness theorem.

§5: The penultimate §5 is devoted to studying the planar algebra associated to $\mathcal{N} \subset \mathcal{M}$. The main result of this section is Theorem 38 which describes the subfactor planar algebra associated to $\mathcal{N} \subset \mathcal{M}$, which turns out to be a planar subalgebra of ${}^{*(2)}P(H^*)$, the adjoint of the 2-cabling of the planar algebra of the Kac algebra H^* .

§6: The final §6 is devoted to proving the main result, Theorem 40, which says that $\mathcal{N} \subset \mathcal{M}$ is isomorphic to $R \subset R \rtimes D(H)^{cop}$ for some outer action of $D(H)^{cop}$ on the hyperfinite II_1 factor R .

1. CROSSED PRODUCT BY KAC ALGEBRAS

In this section we briefly review the notion of crossed product by a Kac algebra. For a detailed exposition of this concept, the reader may consult [9]. We refer to §4 of [12] for the standard facts

concerning finite-dimensional Kac algebras which will be used frequently throughout this article. Unless otherwise specified, $H(= H(\mu, \eta, \Delta, \epsilon, S, *))$ will denote a finite-dimensional Kac algebra and δ , the positive square root of $\dim H$. We set $H^i = H$ or H^* according as i is odd or even. The letters x, y, z will always denote an element of H and for any odd integer i , the symbols x^i, y^i or z^i will always represent an element of $H^i(= H)$. The letters f, g will always denote an element of H^* and for any even integer i , the symbols f^i, g^i will always represent an element of $H^i(= H^*)$. For the rest of this paper, the unique non-zero idempotent integrals of H^* and H will be denoted by ϕ and h respectively and moreover, for any non-negative integer i , the symbols ϕ^i and h^i will always denote a copy of ϕ and h respectively.

Definition 1. *By an action of H on a finite-dimensional complex $*$ -algebra A we will mean a linear map $\alpha : H \rightarrow \text{End}(A)$ (references to endomorphisms without further qualification will be to \mathbb{C} -linear endomorphisms) satisfying (i) $\alpha_1 = \text{id}_A$, (ii) $\alpha_{xy} = \alpha_x \circ \alpha_y$, (iii) $\alpha_x(1_A) = \epsilon(x)1_A$, (iv) $\alpha_x(ab) = \alpha_{x_1}(a)\alpha_{x_2}(b)$, and (v) $\alpha_x(a)^* = \alpha_{Sx^*}(a^*)$ for all $x, y \in H$ and $a, b \in A$. To clarify notation, α_x stands for $\alpha(x)$ and $\Delta(x)$ is denoted by $x_1 \otimes x_2$. For simplicity, we often use the notation $x.a$ to denote $\alpha_x(a)$.*

Suppose that α is an action of H on A . The crossed product algebra, denoted $A \rtimes_\alpha H$ (or mostly, simply as $A \rtimes H$, when the action is understood) is defined to be the $*$ -algebra whose underlying vector space is $A \otimes H$ (where we denote $a \otimes x$ by $a \rtimes x$) and the multiplication is defined by $(a \rtimes x)(b \rtimes y) = a\alpha_{x_1}(b) \rtimes x_2y$. The $*$ -structure on $A \rtimes H$ is given by $(a \rtimes x)^* = \alpha_{x_1^*}(a^*) \rtimes x_2^*$. We often use the notation $x.a$ to denote $\alpha_x(a)$. This is an algebra with unit $1_A \rtimes 1_H$ and there are natural inclusions (which are $*$ -maps also) of algebras $A \subseteq A \rtimes H$ given by $a \mapsto a \rtimes 1_H$ and $H \subseteq A \rtimes H$ given by $x \mapsto 1_A \rtimes x$. We draw the reader's attention to a notational abuse of which we will often be guilty. We denote elements of a tensor product as decomposable tensors with the understanding that there is an implied omitted summation. Thus, when we write 'suppose $f \otimes x \in H^* \otimes H$ ', we mean 'suppose $\sum_i f^i \otimes x^i \in H^* \otimes H$ ' (for some $f^i \in H^*$ and $x^i \in H$, the sum over a finite index set).

There is a natural action of H^* on H given by $f.x = f(x_2)x_1$ for $f \in H^*, x \in H$. Similarly we have action of H on H^* . If H acts on A , then H^* also acts on $A \rtimes H$ just by acting on H -part and ignoring the A -part, meaning that, $f.(a \rtimes x) = a \rtimes f.x = f(x_2) a \rtimes x_1$ for f in H^* and $a \rtimes x \in A \rtimes H$ and consequently, we can construct $A \rtimes H \rtimes H^*$. Continuing this way, we may construct $A \rtimes H \rtimes H^* \rtimes \dots$.

For integers $i \leq j$, we define $H_{[i,j]}$ to be the crossed product algebra $H^i \rtimes H^{i+1} \rtimes \dots \rtimes H^j$. If $i = j$, we will simply write H_i to denote $H_{[i,i]}$ and if $i > j$, we take $H_{[i,j]}$ to be \mathbb{C} . A typical element of $H_{[i,j]}$ will be denoted by $x^i/f^i \rtimes f^{i+1}/x^{i+1} \rtimes \dots$ ($j-i+1$ terms). For instance, a typical element of $H_{[0,3]}$ will be denoted by $f^0 \rtimes x^1 \rtimes f^2 \rtimes x^3$. The multiplication rule shows that if $p \leq i \leq j \leq q$, the natural inclusion of $H_{[i,j]}$ into $H_{[p,q]}$ is an algebra map. Define the algebra $H_{(-\infty, \infty)}$ to be the 'union' of all the $H_{[i,j]}$. We may suggestively write $H_{(-\infty, \infty)} = \dots \rtimes H \rtimes H^* \rtimes H \rtimes \dots$ and represent a typical element of $H_{(-\infty, \infty)}$ as $\dots \rtimes x^{-1} \rtimes f^0 \rtimes x^1 \rtimes \dots$. We repeat that this means that a typical element of $H_{(-\infty, \infty)}$ is in fact a finite sum of such terms. Note that in any such term all but finitely many of the f^i are ϵ and all but finitely many of the x^i are 1. Next, for each $m \geq 1$, we define a subalgebra of $H_{(-\infty, \infty)}$ which, in suggestive notation, is $H_{(-\infty, -1]} \otimes H_{[m, \infty)}$. A little more clearly, it consists of all (finite sums of) elements $\dots \rtimes x^{-1} \rtimes f^0 \rtimes x^1 \rtimes \dots$ of $H_{(-\infty, \infty)}$ where for $0 \leq i \leq m-1$, $f^i = \epsilon$ if i is even and $x^i = 1$ if i is odd. Thus for each $m \geq 1$, we have an inclusion $H_{(-\infty, -1]} \otimes H_{[m, \infty)} \subset H_{(-\infty, \infty)}$ of (infinite-dimensional) algebras which will be useful in §3 to understand the quantum double inclusion of $R^H \subset R$. Note that H^i and H^j commute whenever $|i-j| \geq 2$.

The following results will be very useful. We refer to [1, Theorem 2.1, Corollary 2.3(ii)] for the proof of Lemma 2, [9, Lemma 4.5.3] or [2, Proposition 3] for the proof of Lemma 3 and [9, Lemma 4.2.3] for the proof of Lemma 4.

Lemma 2. $H \rtimes H^* \rtimes H \rtimes \cdots$ ($2k$ -terms) is isomorphic to the matrix algebra $M_n(\mathbb{C})$ where $n = \dim H$.

Lemma 3. For any $p \in \mathbb{Z}$, the subalgebras $H_{(-\infty, p]}$ and $H_{[p+2, \infty)}$ are mutual commutants in $H_{(-\infty, \infty)}$.

Given integers $i \leq j$ and $p \leq q$ such that $j - i = q - p$ and assume that j and p (resp., i and q) have the same parity. Given $X \in H_{[i, j]}$, let X' denote the element obtained by ‘flipping X about i (equivalently, j)’ and then applying $S^{\otimes(j-i+1)}$ on this flipped element. For instance, if we assume i to be odd and j to be even and if $X = x^i \rtimes f^{i+1} \rtimes \cdots \rtimes f^j \in H_{[i, j]}$, then X' is given by $Sf^j \rtimes Sx^{j-1} \rtimes \cdots \rtimes Sf^{i+1} \rtimes Sx^i$. It is evident that $X' \in H_{[p, q]}$.

Lemma 4. The map $X \mapsto X'$ is a $*$ -anti-isomorphism of $H_{[i, j]}$ onto $H_{[p, q]}$.

We now need to recall the Fourier transform map for H . The Fourier transform map $F_H : H \rightarrow H^*$ is defined by $F_H(a) = \delta\phi_1(a)\phi_2$ and satisfies $F_{H^*}F_H = S$. We will usually omit the subscript of F_H and F_{H^*} and write both as F with the argument making it clear which is meant.

2. SUBFACTOR PLANAR ALGEBRAS AND PLANAR ALGEBRAS OF KAC ALGEBRAS

2.1. Subfactor planar algebras. The notion of planar algebras was introduced in [10]. For the basics of (subfactor) planar algebras, we refer to [10], [13] and [12]. We will use the older notion of planar algebras where Col , the set of colours, is given by $\{(0, \pm), 1, 2, \dots\}$ (note that only 0 has two variants, namely, $(0, +)$ and $(0, -)$). This is equivalent to the newer notion of planar algebras where $Col = \{(k, \pm) : k \geq 0 \text{ integer}\}$ and we refer to [3, Proposition 1] for the proof of this equivalence. We will use the notation $T_{k_1, k_2, \dots, k_b}^{k_0}$ to denote a tangle T of colour k_0 (i.e., the colour of the external box of T is k_0) with b internal boxes (b may be zero also) such that the colour of the i -th internal box is k_i . Given a tangle $T = T_{k_1, k_2, \dots, k_b}^{k_0}$ and a planar algebra P , Z_T^P will always denote the associated linear map from $P_{k_1} \otimes P_{k_2} \otimes \cdots \otimes P_{k_b}$ to P_{k_0} induced by the tangle T .

In Figures 1 - 7 we show and describe several tangles that will be useful to us in the sequel. Observe that Figure 7 shows some elements of a family of tangles. In Figure 7 we have the tangles T^n of colour n for $n \geq 2$, with exactly $n - 1$ internal 2-boxes and no internal regions illustrated for $n = 3$ and $n = 4$.



FIGURE 1. Inclusion tangles : $I_{0,+}^1, I_k^{k+1}$ ($k \geq 1$)

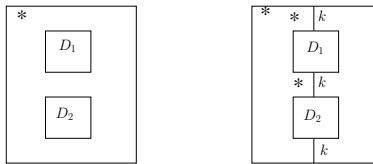

FIGURE 2. Multiplication tangle : $M_{(0,+), (0,+)}^{(0,+)}, M_{k,k}^k$

We will also find it useful to recall the notions of cabling and adjoint for tangles and for planar algebras. Given any positive integer m , and a tangle T , say $T = T_{k_1, k_2, \dots, k_b}^{k_0}$, the m -cabling of T ,

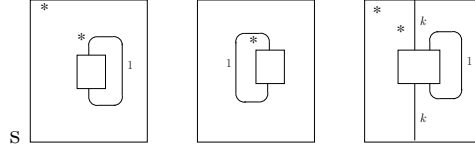

FIGURE 3. Conditional expectation Tangles : $E_1^{0,+}, E_1^{0,-}, E_{k+1}^k$



FIGURE 4. trace tangle : $tr_k^{(0,+)}$ (left) and rotation tangle : $R_k^k(= R_k)(k \geq 2)$ (right)

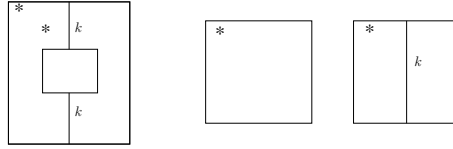

FIGURE 5. Identity tangles : I_k^k (left) and Unit tangles : $1^{0,+}$ (middle), 1^k (right)

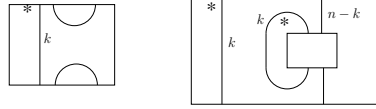

FIGURE 6. $\mathcal{E}^{k+2}(k \geq 0)$ (Jones projection tangles) (left) and $(Q(k))_n^n(1 \leq k \leq n)$ (right)

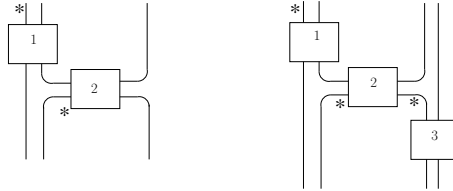

FIGURE 7. The tangles T^3 (left) and T^4 (right)

denoted by $T^{(m)}$, is the tangle obtained from T by replacing each string of T by a parallel cable of m -strings. It is worth noting that the number of internal boxes of $T^{(m)}$ and T are the same and that if $k_i(T^{(m)})$ denotes the colour of the i -th internal disc of $T^{(m)}$, then

$$k_i(T^{(m)}) = \begin{cases} mk_i, & \text{if } k_i > 0 \\ (0, +), & \text{if } k_i = (0, +) \\ (0, -), & \text{if } k_i = (0, -) \text{ and } m \text{ is odd} \\ (0, +), & \text{if } k_i = (0, -) \text{ and } m \text{ is even.} \end{cases}$$

Now given any planar algebra P , construct a new planar algebra ${}^{(m)}P$, called m -cabling of P , by setting

$${}^{(m)}P_k = \begin{cases} P_{mk}, & \text{if } k > 0 \\ P_{(0,+)}, & \text{if } k = (0, +) \\ P_{(0,-)}, & \text{if } k = (0, -) \text{ and } m \text{ is odd} \\ P_{(0,+)}, & \text{if } k = (0, -) \text{ and } m \text{ is even} \end{cases}$$

and defining $Z_T^{(m)P} = Z_{T^{(m)}}^P$ for any tangle T . Similarly, given a planar algebra P , we construct a new planar algebra $*P$, called the adjoint of P , where for any $k \in \text{Col}$, $(*P)_k = P_k$ as vector spaces and given any tangle T , the action Z_T^{*P} of T on $*P$ is specified by $Z_{T^*}^P$ where T^* is the tangle obtained by reflecting the tangle T across any line in the plane.

The following theorem on generating tangles will be useful.

Theorem 5. [13, Theorem 3.5] *Let \mathcal{T} denote the set of all tangles, and suppose \mathcal{T}_0 is a subclass of \mathcal{T} which satisfies:*

- (a) $\{1^{0,+}, 1^{0,-}\} \cup \{R_k : k \geq 2\} \cup \{E_{k+1}^k, M_{k,k}^k, I_k^{k+1} : k \in \text{Col}\} \subset \mathcal{T}_0$; and
- (b) \mathcal{T}_0 is closed under composition, when it makes sense.

Then, $\mathcal{T} = \mathcal{T}_0$.

Among planar algebras, the ones that we will be interested in are the subfactor planar algebras. If P is a subfactor planar algebra of modulus d , then for each $k \geq 0$, we refer to the (faithful, positive, normalised) trace $\tau : P_k \rightarrow \mathbb{C}$ defined for $x \in P_k$ by $\tau(x) = d^{-k} Z_{tr_k^{(0,+)}}(x)$ as the normalised pictorial trace on P_k .

The following fundamental theorem due to Jones [Jones] relates subfactors and subfactor planar algebras.

Theorem 6. *Let $N(= M_0) \subset M(= M_1) \subset^{e_2} M_2 \subset^{e_3} M_3 \subset \dots$ be the tower of the basic construction associated to an extremal subfactor with $[M : N] = d^2 < \infty$, where, of course, $M_{n+2} = \langle M_{n+1}, e_{n+2} \rangle$ ($n \geq 0$) is the result of basic construction applied to the initial inclusion $M_n \subset M_{n+1}$. Then there exists a unique subfactor planar algebra $P = P^{N \subset M}$ of modulus d satisfying the following conditions:*

- (i) $P_k = N' \cap M_k$ for all $k \geq 1$ - where this is regarded as an equality of $*$ -algebras which is consistent with the inclusions on the two sides;
- (ii) $Z_{E_k^k}^P(1) = de_k$ for all $k \geq 2$;
- (iii) $Z_{(E')_k^k}(x) = dE_{M' \cap M_k}(x)$, for all $x \in N' \cap M_k$ ($k \geq 1$) where $(E')_n^n = Q(1)_n^n$;
- (iv) $Z_{E_{k+1}^k}(x) = dE_{N' \cap M_{k+1}}(x)$ for all $x \in N' \cap M_{k+1}$ and this is required to hold for all k in Col where for $k = (0, \pm)$; the equation is interpreted as

$$Z_{E_1^{(0,\pm)}}(x) = dtr_M(x), \forall x \in N' \cap M.$$

Conversely, any subfactor planar algebra P with modulus d arises from an extremal subfactor of index d^2 in this fashion.

Remark 7. *It is a consequence of Theorem 6 that for $1 \leq k \leq n$, $P_{k,n} \stackrel{\text{def}}{=} \text{ran}(Z_{Q(k)_n^n})$ is equal to $M'_k \cap M_n$ where $Q(k)_n^n$ is the tangle as shown on the right in Figure 6.*

2.2. Planar algebra associated to a Kac algebra. Suppose that H acts outerly on the hyperfinite II_1 factor M . Let $P(H, \delta)$ (or, simply, $P(H)$) denote the subfactor planar algebra associated to $M^H \subset M$ where M^H is the fixed-point subalgebra of M . The following theorem (which is a

reformulation of Theorem 5.1 of [12]) gives a presentation of the planar algebra $P(H)$. We now make a brief digression concerning notation. Given a label set $L = \coprod_{k \in \text{col}} L_k$, and a subset R of the universal planar algebra $P(L)$ defined on the label set L , the notation $P(L, R)$ is used to denote the quotient of $P(L)$ by the planar ideal generated by the subset R of $P(L)$.

Theorem 8. [12, Theorem 5.1] *There is an isomorphism $P(L, R) \rightarrow P(H)$ of planar algebras which is a $*$ -isomorphism where*

$$L_k = \begin{cases} H, & \text{if } k = 2 \\ \emptyset, & \text{otherwise} \end{cases}$$

and R being given by the set of relations in Figures 8 - 11 (where (i) we write the relations as identities - so the statement $a = b$ is interpreted as $a - b \in R$; (ii) $\zeta \in k$ and $a, b \in H$; and (iii) the external boxes of all tangles appearing in the relations are left undrawn and it is assumed that all external $*$ -arcs are the leftmost arcs).

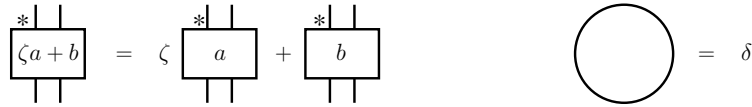

FIGURE 8. The L(inearity) and M(odulus) relations



FIGURE 9. The U(nit) and I(ntegral) relations



FIGURE 10. The C(ounit) and T(race) relations

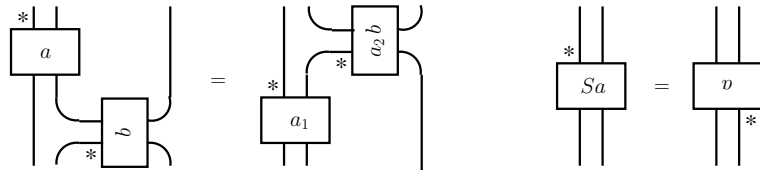

FIGURE 11. The E(xchange) and A(ntipode) relations

In these figures, note that the shading is such that all the 2-boxes that occur are of colour 2. Also note that the modulus relation is a pair of relations - one for each choice of shading the circle.

We recall (a reformulation of) a result from [14]. Let $\mathcal{T}(k, p)$ ($p \leq k - 1$) denote the set of k tangles (interpreted as 0 for $k = 0$) with p internal boxes of colour $(2, +)$ and no ‘internal regions’. If $p = k - 1$, we will simply write $\mathcal{T}(k)$ instead of $\mathcal{T}(k, k - 1)$. The result then asserts:

Lemma 9. [reformulation of Lemma 16 of [14]] For each tangle $X \in \mathcal{T}(k, p)$, the map $Z_X^{P(H)} : (P(H)_2)^{\otimes p} \rightarrow P(H)_k$ is an injective linear map and if $p = k - 1$, then $Z_X^{P(H)} : (P(H)_2)^{\otimes k-1} \rightarrow P(H)_k$ is a linear isomorphism.

The following lemma (a reformulation of [9, Proposition 4.3.1]) establishes algebra isomorphisms between $P(H)_k$ and finite iterated crossed product algebras.

Lemma 10. For each $k \geq 2$, the map from $\underbrace{H \rtimes H^* \rtimes \cdots}_{k-1 \text{ terms}}$ to $P(H)_k$ given by

$$\underbrace{x^1 \rtimes f^2 \rtimes \cdots}_{k-1 \text{ terms}} \mapsto Z_{T^k}^{P(H)} \left(\underbrace{x^1 \otimes F f^2 \otimes \cdots}_{k-1 \text{ terms}} \right)$$

is a $*$ -algebra isomorphism.

We will use this identification of $\underbrace{H \rtimes H^* \rtimes \cdots}_{k-1 \text{ terms}}$ with $P(H)_k$ very frequently without mention. If $i \leq j$, let $tr_{H_{[i,j]}}$ denote the faithful, positive, tracial state on $H_{[i,j]}$ obtained by pulling back the normalised pictorial trace on $P(H^i)_{j-i+2}$ using the algebra isomorphism of Lemma 10. It is easy to see that $tr_{H_{[i,j]}}$ indeed is the linear functional on $H_{[i,j]}$ given by

$$\begin{cases} h^i \otimes \phi^{i+1} \otimes h^{i+2} \otimes \cdots (j-i+1\text{-terms}), & \text{if } i \text{ is even} \\ \phi^i \otimes h^{i+1} \otimes \phi^{i+2} \otimes \cdots (j-i+1\text{-terms}), & \text{if } i \text{ is odd.} \end{cases}$$

Thus, for instance, if we assume i to be odd, j to be even and if $X \in H_{[i,j]}$, say, $X = x^i \rtimes f^{i+1} \rtimes \cdots \rtimes x^{j-1} \rtimes f^j$, then $tr_{H_{[i,j]}}(X) = \phi^i(x^i) f^{i+1}(h^{i+1}) \cdots \phi^{j-1}(x^{j-1}) f^j(h^j)$.

3. A MODEL FOR THE QUANTUM DOUBLE INCLUSION OF $R^H \subset R$

The notion of quantum double inclusion associated to a finite-index and finite-depth subfactor has already been defined in the introduction of this article. The main goal of this section is to construct a model for the quantum double inclusion associated to the Kac algebra subfactor $R^H \subset R$ where H is a finite-dimensional Kac algebra acting outerly on the hyperfinite II_1 factor R and R^H is the fixed point subalgebra under this action. Our construction of the model for the quantum double inclusion of $R^H \subset R$ closely follows the construction of the model for the asymptotic inclusion of $R^H \subset R$ as given in [9].

We begin with recalling from [15] the notion of finite pre-von Neumann algebras. By a finite pre-von Neumann algebra, we will mean a pair (A, τ) consisting of a complex $*$ -algebra A that is equipped with a normalised trace τ such that (i) the sesquilinear form defined by $\langle a, b \rangle = \tau(b^* a)$ defines an inner-product on A and such that (ii) for each $a \in A$, the left-multiplication map $\lambda_A(a) : A \rightarrow A$ is bounded for the trace induced norm of A . By a compatible pair of finite pre-von Neumann algebras, we will mean a pair (A, τ_A) and (B, τ_B) of finite pre-von Neumann algebras such that $A \subseteq B$ and $\tau_B|_A = \tau_A$.

If A is a finite pre-von Neumann algebra with trace τ_A , the symbol $L^2(A)$ will always denote the Hilbert space completion of A for the associated norm. Obviously, the left regular representation $\lambda_A : A \rightarrow \mathcal{L}(L^2(A))$ is well-defined, i.e., for each $a \in A$, $\lambda_A(a) : A \rightarrow A$ extends to a bounded operator on $L^2(A)$. The notation A'' will always denote the von Neumann algebra $(\lambda_A(A))'' \subset \mathcal{L}(L^2(A))$. The following lemma (a reformulation of [15, Proposition 4.6(1)]) will be of great use in the sequel.

Lemma 11. [15, Proposition 4.6(1)] Let (A, τ_A) and (B, τ_B) be a compatible pair of finite pre-von Neumann algebras. The inclusion $A \subseteq B$ extends uniquely to a normal inclusion of A'' into B'' with image $(\lambda_B(A))''$.

Let $A_0 \subseteq A_1$ be a unital *connected* inclusion of finite-dimensional C^* -algebras and let $A_0 \subseteq A_1 \subseteq A_2 \subseteq \dots$ be the Jones' basic construction tower of $A_0 \subseteq A_1$. For each $n \geq 1$, let τ_n denote the unique trace on A_n which is a Markov trace (see [6, §2.7] for the notion of Markov trace) for the inclusion $A_{n-1} \subseteq A_n$. Set $\tau_0 = \text{trace on } A_0 (= \tau_1|_{A_0})$. Clearly, $A = \cup_{n=0}^{\infty} A_n$ comes equipped with a tracial state τ (whose restriction to A_n is τ_n) making A into a finite pre-von Neumann algebra; in fact this is the unique tracial state on A and consequently, A'' turns out to be a (hyperfinite) II_1 factor.

Proposition 12. *Let H be a finite-dimensional Kac algebra acting on each A_n and let α^n denote the action of H on A_n . Assume that $\tau_n \circ \alpha_h^n = \tau_n$ for all $n \geq 0$ where, as usual, h denotes the unique non-zero idempotent integral of H . Suppose further that for any $n \geq 0$ and any $x \in H$, the following diagram commutes.*

$$\begin{array}{ccc} A_{n+1} & \xrightarrow{\alpha_x^{n+1}} & A_{n+1} \\ \cup & & \cup \\ A_n & \xrightarrow{\alpha_x^n} & A_n \end{array}$$

Clearly, commutativity of the preceding diagram yields an action α of H on A . This action of H on A can be extended to A'' .

Before we proceed to prove Proposition 12 we will need the following result whose proof is exactly similar to that of [12, Lemma 4.4(b)] and hence, we omit its proof.

Lemma 13. *Let A be a finite-dimensional C^* -algebra equipped with a faithful tracial state τ and suppose that H is a finite-dimensional Kac algebra acting on A satisfying $\tau(h.a) = \tau(a)$ for all $a \in A$. Then there exists a unique morphism of C^* -algebras $H \ni x \rightarrow L_x \in \mathcal{L}(L^2(A))$ such that $L_x(a) = x.a \forall a \in A$ where $L^2(A)$ denotes the Hilbert space completion of the inner product space A equipped with the inner product induced by τ .*

We now return to the proof of Proposition 12.

Proof of Proposition 12. Let $\lambda : A \rightarrow \mathcal{L}(L^2(A))$ denote the left regular representation. For any $a \in A$, let the notation λ_a stand for $\lambda(a)$. Let a'' be an element of A'' . Then there exists a net (a_j) in A such that λ_{a_j} converges in strong operator topology (SOT) to a'' . Given $x \in H$, we show that the net $(\lambda_{\alpha_x(a_j)})$ converges in SOT. To this end it suffices to see that the net $(\lambda_{\alpha_x(a_j)})$ is bounded and converges pointwise on A (i.e., on a dense subspace of $L^2(A)$). Note that for any $a \in A$,

$$(3.1) \quad \lambda_{\alpha_x(a_j)}(a) = \alpha_x(a_j)a = \alpha_{x_1}(a_j)\alpha_{x_2}(\alpha_{Sx_3}(a)) = \alpha_{x_1}(a_j)\alpha_{Sx_2}(a)$$

and consequently,

$$\|\lambda_{\alpha_x(a_j)}(a)\| = \|\alpha_{x_1}(a_j)\alpha_{Sx_2}(a)\| \leq \|x_1\| \|a_j\alpha_{Sx_2}(a)\| \leq \|x_1\| \|a_j\| \|Sx_2\| \|a\|$$

where the last two inequalities follow by an appeal to Lemma 13 and this shows that $(\lambda_{\alpha_x(a_j)})$ is bounded since (a_j) is so. Note that

$$(\lambda_{\alpha_x(a_j)} - \lambda_{\alpha_x(a_k)})(a) = (\alpha_x(a_j - a_k))(a) = \alpha_{x_1}((a_j - a_k)\alpha_{Sx_2}(a))$$

where the second equality is a consequence of (3.1). Therefore, $(\lambda_{\alpha_x(a_j)}(a))$ is Cauchy and hence, converges in $L^2(A)$. Thus we have shown that $(\lambda_{\alpha_x(a_j)})$ converges in SOT. We define $\alpha_x(a'') \in A''$ to be the SOT-limit of $(\lambda_{\alpha_x(a_j)})$. Thus, we have a linear map $\alpha : H \rightarrow \text{End}_{\mathbb{C}}(A'')$ carrying $x \in H$ to α_x . It is not hard to see that α satisfies conditions (i)-(iv) of Definition 1. To verify condition (v), we note that given $a'' \in A''$, write $a'' = b'' + ic''$ with b'', c'' being self-adjoint elements of A'' . By Kaplansky's density theorem, there exists nets $(b_j)_{j \in J}, (c_k)_{k \in K}$ of self-adjoint elements in A such

that (b_j) converges to b'' in SOT and (c_k) converges to c'' in SOT. Consider the net $(d_{(j,k)} \in I \times J)$ such that $d_{(j,k)} = b_j + ic_k$. Clearly, $d_{(j,k)}$ converges in SOT to a'' as well as $d_{(j,k)}^*$ converges in SOT to $(a'')^*$. Consequently,

$$\alpha_{Sx^*}((a'')^*) = \text{SOT-lim } (\alpha_{Sx^*}(d_{(j,k)}^*)) = \text{SOT-lim } (\alpha_x(d_{(j,k)}))^* = (\text{SOT-lim } (\alpha_x(d_{(j,k)})))^* = (\alpha_x(a''))^*.$$

Thus condition (v) of Definition 1 is satisfied and hence, α is an action of H on A'' . \square

Recall that the algebra $H_{(-\infty, \infty)}$ was introduced in §1. Note $H_{(-\infty, \infty)}$ is the union of the increasing chain of C^* -algebras given by $\mathbb{C} \subset H_{[-1,1]} \subset H_{[-2,2]} \subset H_{[-3,3]} \subset \dots$ and it is evident that for any positive integer k , $\text{tr}_{H_{[-(k+1), k+1]}}$ restricts $\text{tr}_{H_{[-k, k]}}$. Consequently, there is a consistently defined trace on $H_{(-\infty, \infty)}$ making it into a finite pre-von Neumann algebra. Let $H''_{(-\infty, \infty)}$ denote the von Neumann algebra $(H_{(-\infty, \infty)})''$. Later we will see that $H''_{(-\infty, \infty)}$ is indeed a hyperfinite II_1 factor.

It is well-known that for any integer k , $\mathbb{C} \subset H_k \subset H_{[k-1, k]} \subset H_{[k-2, k]} \subset H_{[k-3, k]} \subset \dots$ is the basic construction tower associated to the initial (connected) inclusion $\mathbb{C} \subset H_k$. Consequently, it follows immediately from the discussion contained in the paragraph preceding Proposition 12 that

$$H''_{(-\infty, k]} := (\cup_{i=0}^{\infty} H_{[k-i, k]})'' = (H_{(-\infty, k]})''$$

is a hyperfinite II_1 factor. Further, there is an obvious action of H^{k+1} ($= H$ or H^* according as k is even or odd) on each $H_{[n, k]}$ ($n \leq k$) and it is easy to check that all the hypotheses of Proposition 12 are satisfied. Therefore, by an appeal to Proposition 12 we conclude that this action of H^{k+1} on $H_{(-\infty, k]}$ extends to $H''_{(-\infty, k]}$. It is thus natural to ask the fixed point subalgebra of $H''_{(-\infty, k]}$ under this action of H^{k+1} and whether this action of H^{k+1} on $H''_{(-\infty, k]}$ is outer. It is obvious that for any integer k , $H_{(-\infty, k]} \subset H_{(-\infty, \infty)}$ is a compatible pair of finite pre-von Neumann algebras and hence, by virtue of Lemma 11, the inclusion $H_{(-\infty, k]} \subset H_{(-\infty, \infty)}$ extends uniquely to a unital normal inclusion of $H''_{(-\infty, k]} \subseteq H''_{(-\infty, \infty)}$. It will be useful to know the relative commutant $(H''_{(-\infty, k]})' \cap H''_{(-\infty, \infty)}$. The following Proposition, which is proved in [9] (see [9, Lemma 4.5.2, Lemma 4.5.3]), answers to all these questions. For the sake of completeness we provide a proof of this.

Proposition 14. 1. For integers $k < l$,

$$(H''_{(-\infty, k]})' \cap H''_{(-\infty, l]} = \begin{cases} \mathbb{C}, & \text{if } l = k + 1 \\ H_{[k+2, l]}, & \text{if } l \geq k + 2. \end{cases}$$

2. For any integer k , $(H''_{(-\infty, k]})' \cap H''_{(-\infty, \infty)} = H''_{[k+2, \infty)}$.

Proof. 1. Given integers $k < l$, it is easy to see that the square of finite-dimensional C^* -algebras as shown in Figure 12 is a symmetric commuting square. Further, all the inclusions are connected since the lower left corner is \mathbb{C} and by an appeal to Lemma 2 we have that the lower right corner $H_{[k-1, k]}$ is a matrix algebra, the upper left corner $H_{[k, l]}$ is a matrix algebra if $l - k$ is odd while the upper right corner $H_{[k-1, l]}$ is a matrix algebra if $l - k$ is even. We have already mentioned that for any integer

$$\begin{array}{ccc} H_{[k, l]} & \subset & H_{[k-1, l]} \\ \cup & & \cup \\ \mathbb{C} & \subset & H_{[k-1, k]} \end{array}$$

FIGURE 12. Commuting square

m , $\mathbb{C} \subset H_m \subset H_{[m-1, m]} \subset H_{[m-2, m]} \subset H_{[m-3, m]} \subset \dots$ is the basic construction tower of $\mathbb{C} \subset H_m$. From this it follows that $H_{[k, l]} \subset H_{[k-1, l]} \subset H_{[k-2, l]} \subset H_{[k-3, l]} \subset \dots$ is the basic construction tower of $H_{[k, l]} \subset H_{[k-1, l]}$ with $(\cup_{i=0}^{\infty} H_{[k-i, l]})'' = H''_{(-\infty, l]}$. Again it follows, by an appeal to [11, Proposition 4.3.6], that $\mathbb{C} \subset H_{[k-1, k]} \subset H_{[k-3, k]} \subset H_{[k-5, k]} \subset \dots$ is the basic construction tower of

$\mathbb{C} \subset H_{[k-1,k]}$ with $(\cup_{i=1}^{\infty} H_{[k-2i+1,k]})'' = H''_{(-\infty,k]}$. Hence, by Ocneanu's compactness theorem (see [11, Theorem 5.7.6]) we conclude that $(H''_{(-\infty,k]})' \cap H''_{(-\infty,l]}$ equals $(H_{[k-1,k]})' \cap H_{[k,l]}$ which, by an appeal to Lemma 3, equals \mathbb{C} or $H_{[k+2,l]}$ according as $l = k + 1$ or $l \geq k + 2$.

2. Let k be a fixed integer. For each $m \geq 2$, let E_m denote the conditional expectation of $H''_{(-\infty,\infty)}$ onto $H''_{(-\infty,k+m]}$. Given $x \in (H''_{(-\infty,k]})' \cap H''_{(-\infty,\infty)}$, if we set $x_m = E_m(x)$ ($m \geq 2$), then it is not hard to see that x_m converges in weak operator topology to x . Further note that for any $y \in (H''_{(-\infty,k]})$, $yx_m = yE_m(x) = E_m(yx) = E_m(xy) = E_m(x)y = x_my$ so that $x_m \in (H''_{(-\infty,k]})' \cap H''_{(-\infty,k+m]}$ for all $m \geq 2$. Consequently, by an appeal to Lemma 14(1) we conclude that $x_m \in H_{[k+2,k+m]} \subset H''_{[k+2,\infty)}$ for all $m \geq 2$. Therefore, $x \in H''_{[k+2,\infty)}$. The reverse inclusion is trivial. \square

It was shown in [9] that

Lemma 15. $(H''_{(-\infty,k]})^{H^{k+1}} = H''_{(-\infty,k-1]}$, $H''_{(-\infty,k]} \rtimes H^{k+1} = H''_{(-\infty,k+1]}$.

It follows immediately from the preceding lemma together with an appeal to Lemma 14 that for any integer k , $((H''_{(-\infty,k]})^{H^{k+1}})' \cap H''_{(-\infty,k]} = H''_{(-\infty,k-1]} \cap H''_{(-\infty,k]} = \mathbb{C}$. Thus we see that

Lemma 16. *The action of H^{k+1} on $H''_{(-\infty,k]}$ is outer.*

Therefore, we conclude from Lemmas 15 and 16 that

Lemma 17. *For any integer k , $H''_{(-\infty,k-1]} \subset H''_{(-\infty,k]}$ is a model for $R^{H^{k+1}} \subset R$ for some outer action of H^{k+1} on the hyperfinite II_1 factor R and $H''_{(-\infty,k-1]} \subset H''_{(-\infty,k]} \subset H''_{(-\infty,k+1]} \subset H''_{(-\infty,k+2]} \subset \dots$ is a model for the basic construction tower of $R^{H^{k+1}} \subset R$.*

Since, by Lemma 17, $H''_{(-\infty,k-1]} \subset H''_{(-\infty,k]} \subset H''_{(-\infty,k+1]} \subset H''_{(-\infty,k+2]} \subset \dots$ is the basic construction tower of $H''_{(-\infty,k-1]} \subset H''_{(-\infty,k]}$, $\cup_{i=-1}^{\infty} H''_{(-\infty,k+i]}$ is a finite pre-von Neumann algebra and $(\cup_{i=-1}^{\infty} H''_{(-\infty,k+i]})''$ is a II_1 factor which is hyperfinite since each of $H''_{(-\infty,k-1]}$, $H''_{(-\infty,k]}$ is hyperfinite. It is easy to see that $(\cup_{i=-1}^{\infty} H''_{(-\infty,k+i]})'' = H''_{(-\infty,\infty)}$. Thus we have shown that $H''_{(-\infty,\infty)}$ is a hyperfinite II_1 factor.

With $k = 0$ in Lemma 17, we have that $H''_{(-\infty,-1]} \subset H''_{(-\infty,0]}$ is a model for $R^H \subset R$ and thus, a model for the quantum double inclusion of $R^H \subset R$ is given by

$$H''_{(-\infty,-1]} \vee ((H''_{(-\infty,0]})' \cap H''_{(-\infty,\infty)}) \subseteq H''_{(-\infty,\infty)}.$$

By an appeal to Lemma 14(2), one can easily see that

$$(H''_{(-\infty,0]})' \cap H''_{(-\infty,\infty)} = H''_{[2,\infty)}$$

and consequently,

$$H''_{(-\infty,-1]} \vee ((H''_{(-\infty,0]})' \cap H''_{(-\infty,\infty)}) = H''_{(-\infty,-1]} \vee H''_{[2,\infty)} = (H_{(-\infty,-1]} \otimes H_{[2,\infty)})''.$$

Definition 18. *Set $\mathcal{N} = (H_{(-\infty,-1]} \otimes H_{[2,\infty)})''$ and $\mathcal{M} = H''_{(-\infty,\infty)}$.*

We have thus shown that

Proposition 19. *The subfactor $\mathcal{N} \subset \mathcal{M}$ is a model for the quantum double inclusion of $R^H \subset R$.*

4. BASIC CONSTRUCTION TOWER OF $\mathcal{N} \subset \mathcal{M}$ AND RELATIVE COMMUTANTS

The purpose of this section is to prove that the subfactor $\mathcal{N} \subset \mathcal{M}$ is hyperfinite, find the basic construction tower associated to $\mathcal{N} \subset \mathcal{M}$ and also to compute the relative commutants.

4.1. Some finite-dimensional basic constructions. This subsection is devoted to analysing the basic constructions associated to certain unital inclusions of finite-dimensional C^* -algebras. We begin with recalling the following lemma (a reformulation of Lemma 5.3.1 of [11]) which provides an abstract characterisation of the basic construction associated to a unital inclusion of finite-dimensional C^* -algebras.

Lemma 20. [11, Lemma 5.3.1] *Let $A \subseteq B \subseteq C$ be a unital inclusion of finite-dimensional C^* -algebras. Let tr_B denote a faithful tracial state on B and let E_A denote the tr_B -preserving conditional expectation of B onto A . Let $f \in C$ be a projection. Then C is isomorphic to the basic construction for $A \subseteq B$ with f as the Jones projection if the following conditions are satisfied:*

- (i) f commutes with every element of A and $a \mapsto af$ is an injective map of A into C ,
- (ii) f implements the trace-preserving conditional expectation of B onto A i.e., $fbf = E_A(b)f$ for all $b \in B$, and
- (iii) $BfB = C$.

In the next lemma, we explicitly compute certain conditional expectation maps.

Lemma 21. (i) *Given a sequence of integers $k_1 \leq k_2 < k_3 \leq k_4 < \dots < k_{2r-1} \leq k_{2r}$ in $[p, q]$, where r is any positive integer, then the trace-preserving conditional expectation of $H_{[p, q]}$ onto $H_{[k_1, k_2]} \otimes H_{[k_3, k_4]} \otimes \dots \otimes H_{[k_{2r-1}, k_{2r}]}$ is given by the map $tr_{H_{[p, k_1-1]}} \otimes Id_{H_{[k_1, k_2]}} \otimes tr_{H_{[k_2+1, k_3-1]}} \otimes Id_{H_{[k_3, k_4]}} \otimes \dots \otimes Id_{H_{[k_{2r-1}, k_{2r}]}} \otimes tr_{H_{[k_{2r+1}, q]}}$, with the obvious interpretations when, say, $k_{2i} + 1 > k_{2i+1} - 1$.*

(ii) *Given integers $l \geq 1$ and $s \geq 0$, let $\psi_{l, s}$ denote the embedding of $H_{[-l, 2+s]}$ inside $H_{[-l, -1]} \otimes H_{[2, 6+s]}$ specified as follows:*

$$\text{Let } X = x^{-l}/f^{-l} \rtimes \dots \rtimes x^{2+s}/f^{2+s} \in H_{[-l, 2+s]},$$

then $\psi_{l, s}(X) \in H_{[-l, -1]} \otimes H_{[2, 6+s]}$ is given by

$$(x^{-l}/f^{-l} \rtimes \dots \rtimes f^{-2} \rtimes x_1^{-1}) \otimes (\epsilon \rtimes x_2^{-1} \rtimes f^0 \rtimes \dots \rtimes x^{2+s}/f^{2+s}).$$

Then the trace-preserving conditional expectation E of $H_{[-l, -1]} \otimes H_{[2, 6+s]}$ onto $H_{[-l, 2+s]}$ is given by

$$\begin{aligned} E((x^{-l}/f^{-l} \rtimes \dots \rtimes x^{-1}) \otimes (f^2 \rtimes x^3 \rtimes \dots \rtimes x^{6+s}/f^{6+s})) \\ = \phi(Sx_2^{-1}x^3)f^2(h) x^{-l}/f^{-l} \rtimes \dots \rtimes f^{-2} \rtimes x_1^{-1} \rtimes f^4 \rtimes \dots \rtimes x^{6+s}/f^{6+s}. \end{aligned}$$

Proof. (i) Follows easily by direct computations and is left to the reader.

(ii) For notational convenience, we assume $l = 1$ and $s = 0$. The proof for the general case will follow in a similar fashion. It is trivial to verify that E is trace-preserving. To see that E is $H_{[-1, 2]}$ - $H_{[-1, 2]}$ linear, consider

$$X = x^{-1} \rtimes f^0 \rtimes x^1 \rtimes f^2 \in H_{[-1, 2]}$$

whose image in $H_{[-1, -1]} \otimes H_{[2, 6]}$ under $\psi_{1, 0}$, also denoted by the same symbol X , is given by

$$x_1^{-1} \otimes (\epsilon \rtimes x_2^{-1} \rtimes f^0 \rtimes x^1 \rtimes f^2)$$

and let

$$Y = y^{-1} \otimes (g^2 \rtimes y^3 \rtimes g^4 \rtimes y^5 \rtimes g^6) \in H_{[-1, -1]} \otimes H_{[2, 6]}.$$

Then,

$$XY = g_2^2(x_2^{-1}) f_1^0(y_2^3) g_2^4(x_1^1) f_1^2(y_2^5) x_1^{-1} y^{-1} \otimes (g_1^2 \rtimes x_3^{-1} y_1^3 \rtimes f_2^0 g_1^4 \rtimes x_2^1 y_1^5 \rtimes f_2^2 g^6)$$

and hence,

$$\begin{aligned} E(XY) &= \phi(S(x_2^{-1}y_2^{-1})x_4^{-1}y_1^3) g_1^2(h) g_2^2(x_3^{-1}) f_1^0(y_2^3) g_2^4(x_1) f_1^2(y_2^5) x_1^{-1}y_1^{-1} \rtimes f_2^0g_1^4 \rtimes x_2^1y_1^5 \rtimes f_2^2g^6 \\ &= \phi(Sy_2^{-1}y_1^3) g^2(h) f_1^0(y_2^3) g_2^4(x_1)f_1^2(y_2^5) x^{-1}y_1^{-1} \rtimes f_2^0g_1^4 \rtimes x_2^1y_1^5 \rtimes f_2^2g^6. \end{aligned}$$

On the other hand, a little computation shows that

$$\begin{aligned} XE(Y) &= \phi(Sy_2^{-1}y_3) g^2(h) (x^{-1} \rtimes f^0 \rtimes x^1 \rtimes f^2) (y_1^{-1} \rtimes g^4 \rtimes y^5 \rtimes g^6) \\ &= \phi(Sy_3^{-1}y^3) g^2(h) f_1^0(y_2^{-1}) g_2^4(x_1) f_1^2(y_2^5) x^{-1}y_1^{-1} \rtimes f_2^0g_1^4 \rtimes x_2^1y_1^5 \rtimes f_2^2g^6 \\ &= S\phi_1(y_3^{-1}) \phi_2(y^3) f_1^0(y_2^{-1}) g^2(h) g_2^4(x_1) f_1^2(y_2^5) x^{-1}y_1^{-1} \rtimes f_2^0g_1^4 \rtimes x_2^1y_1^5 \rtimes f_2^2g^6 \\ &= (f_1^0S\phi_1)(y_2^{-1}) \phi_2(y^3) g^2(h) g_2^4(x_1) f_1^2(y_2^5) x^{-1}y_1^{-1} \rtimes f_2^0g_1^4 \rtimes x_2^1y_1^5 \rtimes f_2^2g^6 \end{aligned}$$

which, by an appeal to the formula $fS\phi_1 \otimes \phi_2 = S\phi_1 \otimes \phi_2f$, is seen to be equal to

$$\begin{aligned} &(S\phi_1)(y_2^{-1}) (\phi_2f_1^0) (y^3) g^2(h) g_2^4(x_1) f_1^2(y_2^5) x^{-1}y_1^{-1} \rtimes f_2^0g_1^4 \rtimes x_2^1y_1^5 \rtimes f_2^2g^6 \\ &= \phi(Sy_2^{-1}y_1^3) g^2(h) f_1^0(y_2^3) g_2^4(x_1)f_1^2(y_2^5) x^{-1}y_1^{-1} \rtimes f_2^0g_1^4 \rtimes x_2^1y_1^5 \rtimes f_2^2g^6 \end{aligned}$$

and this clearly equals $E(XY)$. Similarly, we can show that $E(YX) = E(Y)X$, completing the proof. \square

Next, we apply Lemma 20 and Lemma 21 to explicitly describe certain basic constructions and their associated Jones projections.

Proposition 22. *The following are instances of basic constructions with the Jones projections being specified pictorially in appropriate planar algebras.*

- (i) For integers $k \leq p \leq q \leq l$, $H_{[p,q]} \subset H_{[k,l]} \subset H_{[2k-p,2l-q]}$ is an instance of the basic construction with the Jones projection in $P(H^{2k-p})_{2l-2k-q+p+2}$ given by

$$\delta^{-(p+l-k-q)} \begin{array}{c} \overbrace{p-k} \\ \underbrace{p-k} \end{array} \left| \begin{array}{c} q-p+2 \\ \end{array} \right| \begin{array}{c} \overbrace{l-q} \\ \underbrace{l-q} \end{array}$$

and $tr_{H_{[k,l]}}$ is a Markov trace of modulus $\delta^{2(p+l-k-q)}$ for the inclusion $H_{[p,q]} \subset H_{[k,l]}$.

- (ii) For any non-negative integer k , $\mathbb{C} \subset H_{[0,k]} \subset H_{[0,2k+1]}$ is an instance of the basic construction with the Jones projection in $P(H^*)_{2k+3}$ given by

$$\delta^{-(k+1)} \left| \begin{array}{c} \overbrace{k+1} \\ \underbrace{k+1} \end{array} \right| 1$$

and $tr_{H_{[0,k]}}$ is a Markov trace of modulus $\delta^{2(k+1)}$ for the inclusion $\mathbb{C} \subset H_{[0,k]}$.

- (iii) For any non-negative integer k , $\mathbb{C} \subset H_{[-k,0]} \subset H_{[-2k-1,0]}$ is an instance of the basic construction with the Jones projection in $P(H)_{2k+3}$ given by

$$\delta^{-(k+1)} \begin{array}{c} \overbrace{k+1} \\ \underbrace{k+1} \end{array} \left| \begin{array}{c} 1 \end{array} \right|$$

and $tr_{H_{[-k,0]}}$ is a Markov trace of modulus $\delta^{2(k+1)}$ for the inclusion $\mathbb{C} \subset H_{[-k,0]}$.

- If $l \geq 1, s \geq 0$ are integers, $H_{[-l,-1]} \otimes H_{[2,2+s]} \subset H_{[-l,2+s]} \subset H_{[-l,-1]} \otimes H_{[2,6+s]} (\subset H_{[-l,6+s]} \cong P(H^l)_{s+l+8})$ is an instance of the basic construction with the Jones projection given by the following figure

$$\delta^{-2} \left| \begin{array}{c} l+2 \\ \overbrace{2} \\ \underbrace{2} \end{array} \right| \begin{array}{c} s+2 \end{array}$$

where the first inclusion is natural and the second inclusion is given by the map $\psi_{l,s}$ as defined in the statement of Lemma 21(ii). Furthermore, $tr_{H_{[-l,2+s]}}$ is a Markov trace of modulus δ^4 for the inclusion $H_{[-l,-1]} \otimes H_{[2,2+s]} \subset H_{[-l,2+s]}$.

- If $l \geq 1, s \geq 0$ are integers, $H_{[-l,2+s]} \subset H_{[-l,-1]} \otimes H_{[2,6+s]} \subset H_{[-l,6+s]} (\cong P(H^l)_{s+l+8})$ is an instance of the basic construction with the Jones projection given by

$$\delta^{-2} \left| \begin{array}{c} l \\ \left. \begin{array}{c} \curvearrowright \\ 2 \\ \curvearrowright \end{array} \right\} \\ s+4 \end{array} \right|$$

where the first inclusion is given by the map $\psi_{l,s}$ as defined in the statement of Lemma 21(ii) and the second inclusion is the natural inclusion. Also, $\text{tr}_{H_{[-l,-1]} \otimes H_{[2,6+s]}}$ is a Markov trace of modulus δ^4 for the inclusion $H_{[-l,s+2]} \subset H_{[-l,-1]} \otimes H_{[2,6+s]}$.

Proof. The strategy for the proof of Proposition 22 is to verify, in each case, conditions (i), (ii), and (iii) of Lemma 20. We will frequently use Lemma 9 without any mention in the proofs of all parts of Proposition 22.

- (i) For notational convenience, we assume that k, p, q, l are all odd so that we may identify $H_{[2k-p, 2l-q]}$ with $P(H)_{2l-2k+p-q+2}$ and we regard $H_{[k,l]}$, $H_{[p,q]}$ as subalgebras of $P(H)_{2l-2k+p-q+2}$. Let e_1 denote the projection defined in the statement of Proposition 22(1)(i). Conditions (i) and (ii) of Lemma 20 are straightforward to verify. For condition (iii), one can easily observe that if we take

$$\begin{aligned} X &= x^k \rtimes f^{k+1} \rtimes \dots \rtimes x^l, \\ Y &= y^k \rtimes g^{k+1} \rtimes \dots \rtimes g^{p-1} \underbrace{\rtimes 1 \rtimes \epsilon \rtimes \dots \rtimes 1}_{q-p+1 \text{ terms}} \rtimes g^{q+1} \rtimes \dots \rtimes y^l \end{aligned}$$

in $H_{[k,l]}$, then Xe_1Y equals the element

$$\begin{aligned} \delta^{-(p+l-k-q)} Z_U^{P(H)} &(x^k \otimes Ff^{k+1} \otimes \dots \otimes Ff^{l-1} \otimes x^l \otimes y^k \otimes Fg^{k+1} \otimes \dots \otimes Fg^{p-1} \\ &\otimes Fg^{q+1} \otimes y^{q+2} \otimes \dots \otimes y^l) \end{aligned}$$

where $U \in \mathcal{T}(2l-2k+p-q+2)$ is the tangle as shown in Figure 13. Thus we see that

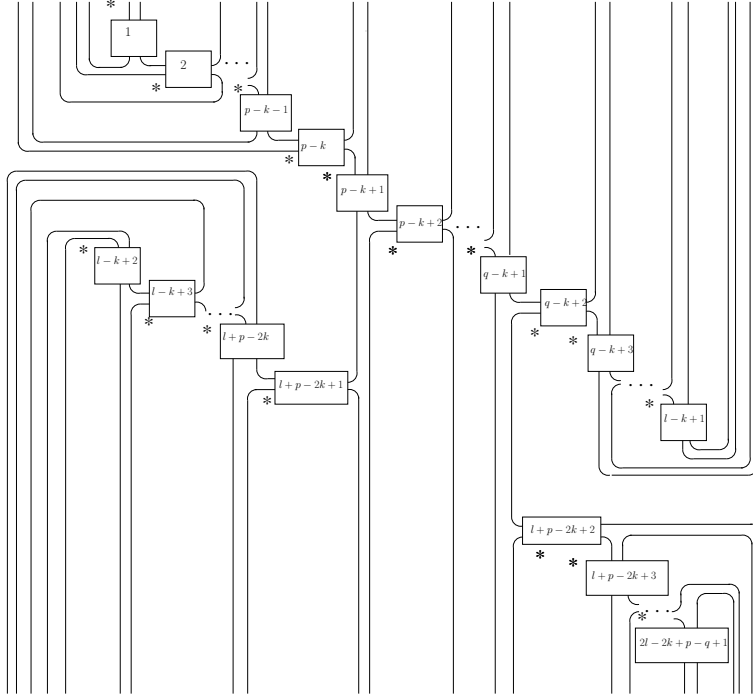

FIGURE 13. Tangle U

$H_{[k,l]}e_1H_{[k,l]}$ contains the image of the linear isomorphism Z_U and thus, $\dim(H_{[k,l]}e_1H_{[k,l]}) \geq$

rank of $Z_U = (\dim H)^{2l-2k+p-q+1}$ and whence the equality $H_{[k,l]}e_1H_{[k,l]} = H_{[2k-p,2l-q]}$ follows. A routine computation in $P(H)_{2l-2k+p-q+2}$ verifies that $\text{tr}_{H_{[k,l]}}$ is a Markov trace of modulus $\delta^{2(p+l-k-q)}$ for the inclusion $H_{[p,q]} \subset H_{[k,l]}$ and we leave the verification to the reader. The proof for the case when k, p, q, l are not all odd follows in a similar way and the reader should note that if $2k-p$ is even, then $H_{[2k-p,2l-q]}$ is identified with $P(H^*)_{2l-2k+p-q+2}$ and consequently, $H_{[k,l]}, H_{[p,q]}$ are regarded as subalgebras of $P(H^*)_{2l-2k+p-q+2}$.

(ii) Identify $H_{[0,2k+1]}$ with $P(H^*)_{2k+3}$. Then $H_{[0,k]}$ is identified with the subalgebra $P(H^*)_{k+2}$ of $P(H^*)_{2k+3}$ while \mathbb{C} is identified with the space of scalar multiples of the unit element of $P(H^*)_{2k+3}$. Let us use the symbol e_2 to denote the projection defined in the statement of Proposition 22(1)(ii). Note that conditions (i) and (ii) of Lemma 20 are easy to verify. A simple computation in $P(H^*)_{2k+3}$ shows that $H_{[0,k]}e_2H_{[0,k]}$ equals the image of the linear isomorphism Z_T induced by the tangle $T \in \mathcal{T}(2k+3)$ as depicted in Figure 14 and by comparing dimensions we conclude that $H_{[0,k]}e_2H_{[0,k]} = \text{Range of } Z_T = P(H^*)_{2k+3}$, verifying the condition (iii) of Lemma 20.

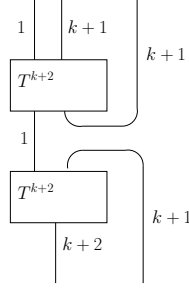

FIGURE 14. Tangle T

- (iii) Proceed along the same line of argument as in the proof of part (ii).
- Again, for notational convenience, rather than proving the result in its full generality, we shall just present the proof when $l = 1, s = 0$. The proof for the general case will follow in a similar fashion. Given

$$X = x^{-1} \rtimes f^0 \rtimes x^1 \rtimes f^2 \in H_{[-1,2]},$$

note that the image of X under $\psi_{1,0}$, also denoted X , can be identified with the element of $P(H)_9$ as shown on the left in Figure 15 and consequently, $Z = z^{-1} \otimes g^2 \in H_{-1} \otimes H_2$ is

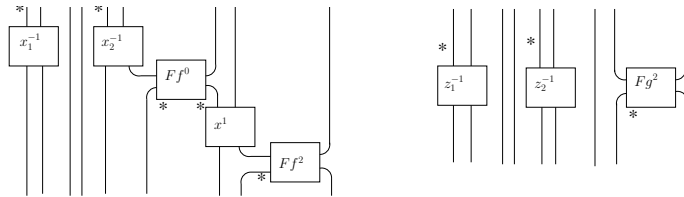
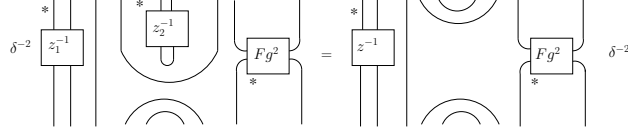

FIGURE 15. X (left) and $Z \in H_{-1} \otimes H_2$ (right)

identified with the element of $P(H)_9$ as shown on the right in Figure 15. Let e denote the projection defined in the statement of Proposition 22(2).

Note that the element Ze is as shown on the left in Figure 16 which, by an appeal to the relation C, is easily seen to be equal to the element shown on the right in Figure 16. From this it follows immediately that $Z = 0$ whenever $Ze = 0$, verifying condition (i) of Lemma 20.

It follows from Lemma 21(i) that $E(X) = f^0(h)\phi(x^1) x^{-1} \otimes f^2$ where E is the trace-preserving conditional expectation of $H_{[-1,2]}$ onto $H_{-1} \otimes H_2$. Observe that the element

FIGURE 16. Ze

eXe equals the element shown on the left in Figure 17. Now applying the relations C and T, we reduce the element on the left in Figure 17 to that on the right in Figure 17. Now comparison with the pictorial description of the element Ze as shown on the right in Figure 16 immediately yields that the element on the right in Figure 17 is indeed $E(X)e$, verifying condition (ii) of Lemma 20.

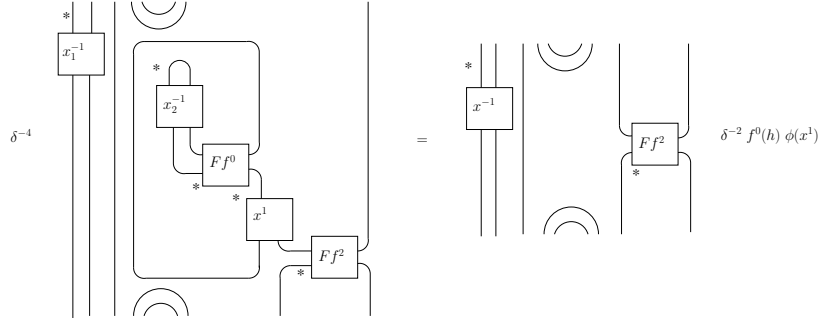
FIGURE 17. eXe

To verify condition (iii), we note that if we take elements

$$X = 1 \times f^0 \times x^1 \times f^2, \quad Y = y^{-1} \times g^0 \times y^1 \times \epsilon$$

in $H_{[-1,2]}$, then XeY equals the element

$$\delta^{-2} Z_S^{P(H)}(y^{-1} \otimes Ff^0 \otimes x^1 \otimes Ff^2 \otimes Fg^0 \otimes y^1)$$

where $Z_S : H^{\otimes 6} \rightarrow P(H)_9$ is the injective linear map induced by the tangle $S \in \mathcal{T}(9, 6)$ as shown in Figure 18. It thus follows that $H_{[-1,2]}eH_{[-1,2]}$ contains the image of the map Z_S .

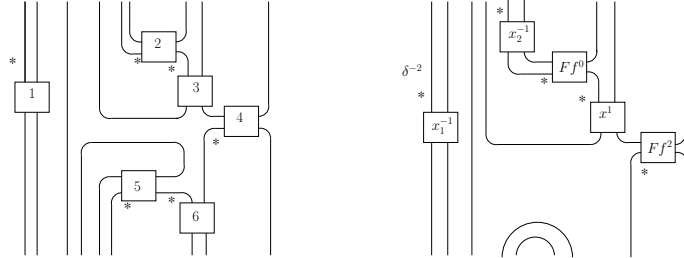
FIGURE 18. Tangle S (left) and Xe (right)

Now, by comparison of dimensions we see that,

$$\dim(H_{[-1,2]}eH_{[-1,2]}) \geq \text{rank of } Z_S = (\dim H)^6 = \dim(H_{[-1,-1]} \otimes H_{[2,6]})$$

and obviously

$$\dim(H_{[-1,-1]} \otimes H_{[2,6]}) \geq \dim(H_{[-1,2]}eH_{[-1,2]})$$

as $H_{[-1,2]}eH_{[-1,2]}$ is contained in $H_{[-1,-1]} \otimes H_{[2,6]}$. Thus, condition (iii) of Lemma 20 is verified.

Note that if $X \in H_{[-1,2]}$ is as before, then Xe equals the element shown on the right in Figure 18. It is then a routine computation to verify that $\text{tr}(Xe) = \delta^{-4}\text{tr}(X)$, proving that $\text{tr}_{H_{[-1,2]}}$ is a Markov trace of modulus δ^4 for the inclusion $H_{-1} \otimes H_2 \subset H_{[-1,2]}$.

3. As before, we only present the proof when $l = 1$ and $s = 0$, omitting the proof for the general case which is analogous. Let e denote the projection defined in the statement of Proposition 22(3). We identify as usual $H_{[-1,6]}$ with $P(H)_9$.

Given

$$X = x^{-1} \rtimes f^0 \rtimes x^1 \rtimes f^2 \in H_{[-1,2]},$$

its image in $H_{[-1,6]}$ is given by

$$x^{-1} \rtimes \epsilon \rtimes 1 \rtimes \epsilon \rtimes x_2^{-1} \rtimes f^0 \rtimes x^1 \rtimes f^2.$$

The element eX is shown on the left in Figure 19. An application of the relation E shows that eX equals the element on the right in Figure 19. Similarly, by an appeal to the relations A and E, one can easily see that the element Xe equals the element on the right in Figure 19 so that $eX = Xe$. Thus, we conclude that e commutes with X . Further, it is evident from the pictorial representation of the element Xe as shown on the right in Figure 19 that the map $X \mapsto Xe$ of $H_{[-1,2]}$ into $H_{[-1,6]}$ is injective, verifying condition (i) of Lemma 20.

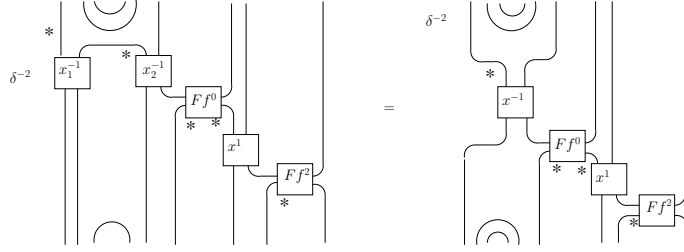

FIGURE 19. $eX = Xe$

Given

$$X = x^{-1} \otimes (f^2 \rtimes x^3 \rtimes f^4 \rtimes x^5 \rtimes f^6) \in H_{-1} \otimes H_{[2,6]},$$

we observe that eXe equals the element in $P(H)_9$ shown on the left in Figure 20. Firstly an

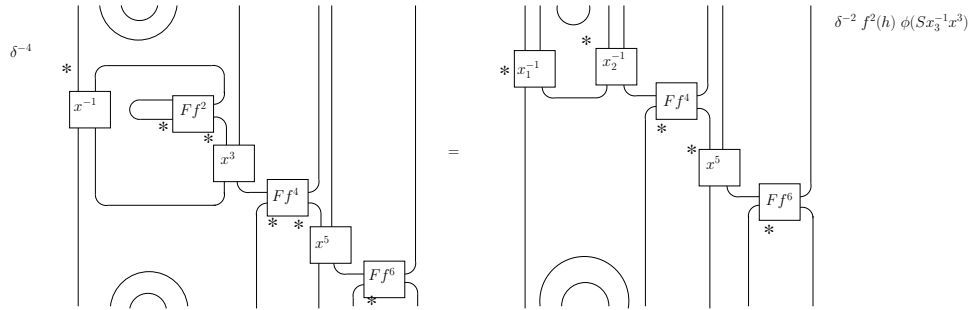

FIGURE 20. $eXe = E(X)e$

application of the relation C, then repeated applications of the relations A and E and finally, an application of the relation T reduces the element on the left in Figure 20 to that on the right in Figure 20. If E denotes the trace-preserving conditional expectation of $H_{[-1,-1]} \otimes H_{[2,6]}$ onto $H_{[-1,2]}$, then, by Lemma 21(ii), $E(X) = \phi(Sx_2^{-1}x^3) f^2(h) x_1^{-1} \rtimes f^4 \rtimes x^5 \rtimes f^6$. Representing $E(X)e$ pictorially in $P(H)_9$, one can easily see that $E(X)e$ indeed equals the element on the right in Figure 20. Therefore, $eXe = E(X)e$, verifying condition (ii) of Lemma 20.

Finally it just remains to verify that $(H_{-1} \otimes H_{[2,6]}) e (H_{-1} \otimes H_{[2,6]}) = H_{[-1,6]}$. Consider elements X, Y in $H_{-1} \otimes H_{[2,6]}$ given by

$$X = x^{-1} \otimes (f^2 \rtimes x^3 \rtimes f^4 \rtimes x^5 \rtimes f^6), \text{ and } Y = 1 \otimes (g^2 \rtimes y^3 \rtimes \epsilon \rtimes 1 \rtimes \epsilon).$$

Then one can easily see that XeY equals the element

$$Z_T^{P(H)}(x^{-1} \otimes Ff^2 \otimes x^3 \otimes Ff^4 \otimes x^5 \otimes Ff^6 \otimes Fg^2 \otimes y^3)$$

where Z_T is the linear isomorphism induced by the tangle $T \in \mathcal{T}(9)$ as shown in Figure 21. Thus we see that $(H_{-1} \otimes H_{[2,6]}) e (H_{-1} \otimes H_{[2,6]})$ contains the image of Z_T . Then by comparing dimensions of spaces we have that $H_{[-1,6]} = (H_{-1} \otimes H_{[2,6]}) e (H_{-1} \otimes H_{[2,6]})$.

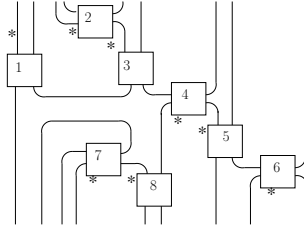

FIGURE 21. Tangle T

Finally, a routine computation shows that for any $X \in H_{-1} \otimes H_{[2,6]}$, $tr(Xe) = \delta^{-4}tr(X)$, so that $tr_{H_{-1} \otimes H_{[2,6]}}$ is a Markov trace of modulus δ^4 for the inclusion $H_{[-1,2]} \subset H_{-1} \otimes H_{[2,6]}$, completing the proof. □

4.2. Jones' basic construction tower of $\mathcal{N} \subset \mathcal{M}$ and relative commutants. The goal of this subsection is to explicitly determine the basic construction tower of $\mathcal{N} \subset \mathcal{M}$.

We begin with proving that certain squares of finite-dimensional C^* -algebras are symmetric commuting squares.

Lemma 23. *If $k < p < q < l$ are positive integers, then the square in Figure 22 is an instance of a symmetric commuting square with respect to $tr_{H_{[k,l]}}$ which is a Markov trace of modulus $\delta^{2(p-k+l-q+2)}$ for the inclusion $H_{[p+1,q-1]} \subset H_{[k,l]}$.*

$$\begin{array}{ccc} H_{[p+1,q-1]} & \subset & H_{[k,l]} \\ \cup & & \cup \\ \mathbb{C} & \subset & H_{[k,p]} \otimes H_{[q,l]} \end{array}$$

FIGURE 22. Commuting square

Proof. By Lemma 21(i) the square of finite-dimensional C^* -algebras in Figure 22 is a commuting square with respect to $tr_{H_{[k,l]}}$. In order to show that this is symmetric, we need to verify that $H_{[k,l]}$ is linearly spanned by $(H_{[k,p]} \otimes H_{[q,l]})H_{[p+1,q-1]}$. Assume that k, p, q, l are all odd so that we may identify $H_{[k,l]}$ with $P(H)_{l-k+2}$ and also identify $H_{[k,p]} \otimes H_{[q,l], H_{[p+1,q-1]}$ as subalgebras of $P(H)_{l-k+2}$. A little computation in $P(H)$ shows that $(H_{[k,p]} \otimes H_{[q,l]})H_{[p+1,q-1]}$ equals the image of the linear isomorphism Z_W where $W \in \mathcal{T}(l-k+2)$ is as shown in Figure 23 which in turn implies, by comparing dimensions of spaces, that $(H_{[k,p]} \otimes H_{[q,l]})H_{[p+1,q-1]} = H_{[k,l]}$ and the desired result

follows. Further, it is a direct consequence of the Proposition 22(1)(i) that $tr_{H_{[k,l]}}$ is a Markov trace of modulus $\delta^{2(p-k+l-q+2)}$ for the inclusion $H_{[p+1,q-1]} \subset H_{[k,l]}$. The general proof follows in a similar fashion with the difference that when k is even, we identify $H_{[k,l]}$ with $P(H^*)_{l-k+2}$. \square

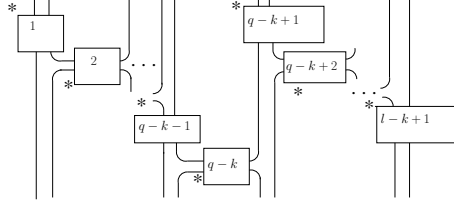

FIGURE 23. Tangle W

We set $A_{0,0} = \mathbb{C}$, $A_{1,0} = H_{-1} \otimes H_2$, $A_{0,1} = H_{[0,1]}$ and $A_{1,1} = H_{[-1,2]}$. It is an immediate consequence of Lemma 23 that the square in Figure 24 is a symmetric commuting square with respect to $tr_{A_{1,1}}$ which is a Markov trace of modulus δ^4 for the inclusion $A_{0,1} \subset A_{1,1}$. Further, all the inclusions are connected since the lower left corner is \mathbb{C} while the upper right corner is a matrix algebra by Lemma 2.

$$\begin{array}{ccc} A_{0,1} & \subset & A_{1,1} \\ \cup & & \cup \\ A_{0,0} & \subset & A_{1,0} \end{array}$$

FIGURE 24. Commuting square

We also set $A_{k,1} = H_{[-k,k+1]}, \forall k \geq 2$. It is then a consequence of Proposition 22(1)(i) that $A_{0,1} \subset A_{1,1} \subset A_{2,1} \subset A_{3,1} \subset \dots$ is the basic construction tower associated to the initial inclusion $A_{0,1} \subset A_{1,1}$ and for any $k \geq 0$, if e'_{k+2} denotes the Jones projection lying in $A_{k+2,1}$ for the basic construction of $A_{k,1} \subset A_{k+1,1}$, then e'_{k+2} is given by Figure 25.

$$\delta^{-2} \begin{array}{c} \cup \\ 1 \\ \cup \\ 1 \end{array} \Bigg|_{2k+3} \begin{array}{c} \cup \\ 1 \\ \cup \\ 1 \end{array}$$

FIGURE 25. e'_{k+2}

Further, we define inductively

$$A_{k+2,0} = \langle A_{k+1,0}, e'_{k+2} \rangle$$

for each $k \geq 0$. It is well-known that $A_{0,0} \subset A_{1,0} \subset A_{2,0} \subset A_{3,0} \subset \dots$ is the basic construction tower of $A_{0,0} \subset A_{1,0}$. The following lemma explicitly describes the C^* -algebras $A_{k,0}$ for $k > 0$.

Lemma 24. $A_{k,0} = H_{[-k,-1]} \otimes H_{[2,k+1]}, k > 0$.

Proof. Note first that since for any $k \geq 0, A_{k,0} \subset A_{k+1,0} \subset A_{k+2,0}$ is an instance of the basic construction with the Jones projection $e'_{k+2} \in A_{k+2,0}$, we must have that $A_{k+2,0} = A_{k+1,0} e'_{k+2} A_{k+1,0}$.

Our proof proceeds by induction on k . The case $k = 1$ is obvious from the definition of $A_{1,0}$. Now suppose that there is a positive integer $r \geq 2$ such that the statement holds for all positive integers $k < r$ so that in particular, $A_{r-1,0} = H_{[-(r-1),-1]} \otimes H_{[2,r]}$. Regard $H_{[-r,-1]} \otimes H_{[2,r+1]}$ as a subalgebra of $H_{[-r,r+1]} \cong P(H^r)_{2r+3}$. Noting that $e'_r \in H_{[-r,-1]} \otimes H_{[2,r+1]}$, we conclude that $A_{r,0} = A_{r-1,0} e'_r$. $A_{r-1,0} \subseteq H_{[-r,-1]} \otimes H_{[2,r+1]}$. To prove the reverse inclusion, consider the elements in $A_{r-1,0}$ given by

$$X = (f^{-(r-1)}/x^{-(r-1)}) \rtimes \cdots \rtimes f^{-2} \rtimes x^{-1} \otimes (f^2 \rtimes x^3 \rtimes \cdots \rtimes x^r/f^r), \quad Y = g^{-(r-1)}/y^{-(r-1)} \otimes y^r/g^r.$$

A little computation in $P(H^r)_{2r+3}$ shows that $H_{[-r,-1]} \otimes H_{[2,r+1]}$ is linearly spanned by elements of the form $X e'_r Y$, proving the reverse inclusion. Hence the proof follows. \square

Note that $\cup_{k=0}^{\infty} A_{k,0} (= H_{(-\infty,-1]} \otimes H_{[2,\infty)})$ as well as $\cup_{k=0}^{\infty} A_{k,1} (= H_{(-\infty,\infty)})$ are finite pre-von Neumann algebras (see §4). It follows from Definition 1 that

$$(\cup_{k=0}^{\infty} A_{k,0})'' = (H_{(-\infty,-1]} \otimes H_{[2,\infty)})'' = \mathcal{N} \text{ and } (\cup_{k=0}^{\infty} A_{k,1})'' = (H_{(-\infty,\infty)})'' = \mathcal{M}.$$

Thus, we have proved that

Lemma 25. \mathcal{N} and \mathcal{M} are hyperfinite II_1 factors.

The following lemma shows that $\mathcal{N} \subset \mathcal{M}$ is of finite index equal to δ^4 .

Lemma 26. $[\mathcal{M} : \mathcal{N}] = \delta^4$.

Proof. It is well-known that (see [11, Corollary 5.7.4]) $[\mathcal{M} : \mathcal{N}]$ equals the square of the norm of the inclusion matrix for $A_{0,0} \subset A_{0,1}$ which further equals the modulus of the Markov trace $tr_{A_{0,1}}$ for the inclusion $A_{0,0} (= \mathbb{C}) \subset A_{0,1} (= H_{[0,1]})$ which, again, by an application of Proposition 22(1)(iii), equals δ^4 . \square

For each $k \geq 0$ and $n \geq 2$, we now define a finite-dimensional C^* -algebra, denoted $A_{k,n}$, as follows.

$$A_{k,n} = \begin{cases} H_{[-k,-1]} \otimes H_{[2, 2n+k+1]}, & \text{if } n \geq 0 \text{ is even, } k > 0 \\ H_{[-k, 2n+k-1]}, & \text{if } n > 0 \text{ is odd, } k > 0 \\ H_{[-2(n-1), 1]}, & \text{if } n > 0, k = 0 \end{cases}$$

For $k, n \geq 0$, we regard $A_{k,n}$ as a unital C^* -subalgebra of both $A_{k+1,n}$ and $A_{k,n+1}$ via the embeddings as described below.

- For any $n \geq 0, k > 0$, $A_{k,n}$ sits inside $A_{k+1,n}$ in the natural way.
- If $n \geq 0$ is even and $k > 0$, then $A_{k,n}$ sits inside $A_{k,n+1}$ in the natural way.
- If $n > 0$ is odd and $k > 0$, the embedding of $A_{k,n}$ inside $A_{k,n+1}$ is given by $\psi_{l,s}$ as defined in the statement of Lemma 21(ii) with $l = k, s = 2n + k - 3$.
- If n is odd, then $A_{0,n}$ is identified with the subalgebra $H_{[0, 2n-1]}$ of $A_{1,n} = H_{[-1, 2n]}$.
- If $n > 0$ is even, then $A_{0,n}$ is identified with the subalgebra $H_{[2, 2n+1]}$ of $A_{1,n} = H_{-1} \otimes H_{[2, 2n+2]}$.
- Embedding of $A_{0,n}$ inside $A_{0,n+1}$ is natural for all $n \geq 0$.

Thus, we have a grid $\{A_{k,n} : k, n \geq 0\}$ of finite-dimensional C^* -algebras. The following remark contains several useful facts concerning the grid $\{A_{k,n} : k, n \geq 0\}$.

Remark 27. (i) *We have already seen (as an application of Lemma 23) that the square of finite-dimensional C^* -algebras as shown in Figure 24 is a symmetric commuting square with respect to $tr_{A_{1,1}}$ which is a Markov trace of modulus δ^4 for the inclusion $A_{0,1} \subset A_{1,1}$ and all the inclusions are connected. Further, by Lemmas 25 and 26, $(\cup_{k=0}^{\infty} A_{k,0})'' (= \mathcal{N})$ as well as $(\cup_{k=0}^{\infty} A_{k,1})'' (= \mathcal{M})$ are hyperfinite II_1 factors with $[\mathcal{M} : \mathcal{N}] = \delta^4$.*

- (ii) It follows from the embedding prescriptions that the following diagram (see Figure 26) commutes for all $k, n \geq 0$.

$$\begin{array}{ccc} A_{k,n+1} & \subset & A_{k+1,n+1} \\ \cup & & \cup \\ A_{k,n} & \subset & A_{k+1,n} \end{array}$$

FIGURE 26. Commuative diagram

- (iii) It is a direct consequence of Proposition 22 that for any $k, n \geq 0$, $A_{k,n} \subset A_{k,n+1} \subset A_{k,n+2}$ is an instance of the basic construction and further, $\text{tr}_{A_{k,n+1}}$ is a Markov trace of modulus δ^4 for the inclusion $A_{k,n} \subset A_{k,n+1}$. Also, if $e_{k,n+2}$ ($k \geq 0, n \geq 0$) denotes the Jones projection lying in $A_{k,n+2}$ applied to the basic construction $A_{k,n} \subset A_{k,n+1}$, then $e_{k,n+2}$ is shown in Figure 27.

$$\delta^{-2} \left| \begin{array}{c} \smile_2 \\ k \\ \smile_2 \end{array} \right|_{2n+k+1} \quad \delta^{-2} \left| \begin{array}{c} \smile_2 \\ k+2 \\ \smile_2 \end{array} \right|_{2n+k+1}$$

FIGURE 27. $e_{k,n+2}$ ($k > 0, n$ odd or $k = 0, n \geq 0$) (left) and $e_{k,n+2}$ ($k > 0, n$ even) (right)

- (iv) For any $k \geq 0, n \geq 2$, the embedding of $A_{k,n}$ inside $A_{k+1,n}$ carries $e_{k,n}$ to $e_{k+1,n}$.

Consider the tower of finite pre-von Neumann algebras $\cup_{k=0}^{\infty} A_{k,0} \subset \cup_{k=0}^{\infty} A_{k,1} \subset \cup_{k=0}^{\infty} A_{k,2} \subset \dots$. Observe that for any $m \geq 0$, $\cup_{k=0}^{\infty} A_{k,m} \subset \cup_{k=0}^{\infty} A_{k,m+1}$ is a compatible pair. Note also that $\cup_{k=0}^{\infty} A_{k,n} = H_{(-\infty, -1]} \otimes H_{[2, \infty)}$ or $H_{(-\infty, \infty)}$ according as n is even or odd. For each $m \geq 0$, we define $\mathcal{M}_m := (\cup_{k=0}^{\infty} A_{k,m})''$. Then $\mathcal{M}_m = (H_{(-\infty, -1]} \otimes H_{[2, \infty)})''$ or $H''_{(-\infty, \infty)}$ according as m is even or odd. In view of the facts concerning the grid $\{A_{k,n} : k, n \geq 0\}$ as mentioned in Remark 27, one can conclude that

Proposition 28. $\mathcal{M}_0 (= \mathcal{N}) \subset \mathcal{M}_1 (= \mathcal{M}) \subset \mathcal{M}_2 \subset \mathcal{M}_3 \subset \dots$ is the basic construction tower of $\mathcal{N} \subset \mathcal{M}$.

4.3. Computation of the relative commutants. We now proceed to compute the relative commutants. By virtue of Ocneanu's compactness theorem (see [11, Theorem 5.7.6]), the relative commutant $\mathcal{N}' \cap \mathcal{M}_k$ ($k > 0$) is given by

$$\mathcal{N}' \cap \mathcal{M}_k = A_{0,k} \cap (A_{1,0})', \quad k \geq 1.$$

The following proposition describes the spaces $A_{0,k} \cap (A_{1,0})', k \geq 1$.

Proposition 29. Let $m \geq 1$ be an integer. Then,

- (a) $A_{0,2m} \cap (A_{1,0})' \cong \tilde{Q}_{2m} := \{X \in H_{[2, 4m]} : X \text{ commutes with } \Delta_{m-1}(x) \in \otimes_{i=1}^m H_{4i-1}, \forall x \in H\}$
and
(b) $A_{0,2m-1} \cap (A_{1,0})' \cong \tilde{Q}_{2m-1} := \{X \in H_{[0, 4m-4]} : X \text{ commutes with } \Delta_{m-1}(x) \in \otimes_{i=0}^{m-1} H_{4i-1}, \forall x \in H\}$.

Proof. (a) We observe from the embedding prescription of $A_{1,0}$ inside $A_{1,2m}$ that given $Y = x \otimes f \in A_{1,0}$, its image in $A_{1,2m}$ is given by

$$\Delta_m(x) \otimes f = \otimes_{i=1}^{m+1} x_i \otimes f \in \otimes_{i=0}^m H_{4i-1} \otimes H_{4m+2}.$$

Recall that $A_{0,2m}$ is identified with the subalgebra $H_{[2,4m+1]}$ of $A_{1,2m}$. Thus, given $X \in A_{0,2m}$, its image in $A_{1,2m}$ is given by $1 \otimes (X \rtimes \epsilon)$. Consequently, $A_{0,2m} \cap (A_{1,0})'$ equals

$$\{X \in H_{[2,4m+1]} : 1 \otimes (X \rtimes \epsilon) \in H_{-1} \otimes H_{[2,4m+2]} \text{ commutes with } \\ \Delta_m(x) \otimes f \in \otimes_{i=0}^m H_{4i-1} \otimes H_{4m+2}, \forall f \otimes x \in H^* \otimes H\}.$$

Thus given $X \in A_{0,2m} \cap (A_{1,0})'$, since $X \in H_{[2,4m+1]}$ commutes with H_{4m+2} , it commutes with every element of $H_{[4m+2, \infty)}$ and consequently, by an appeal to Lemma 3 we conclude that X indeed lies in $H_{[2,4m]}$. Thus, $A_{0,2m} \cap (A_{1,0})'$ can be identified with

$$\{X \in H_{[2,4m]} : 1 \otimes X \in H_{-1} \otimes H_{[2,4m]} \text{ commutes with } \Delta_m(x) \in \otimes_{i=0}^m H_{4i-1}, \forall x \in H\}$$

and a little thought should convince the reader that this space equals

$$\{X \in H_{[2,4m]} : X \text{ commutes with } \Delta_{m-1}(x) \in \otimes_{i=1}^m H_{4i-1}, \forall x \in H\}$$

- (b) It follows from the embedding formula of $A_{1,0}$ inside $A_{1,2m}$ that given $Y = x \otimes f \in A_{1,0}$, its image in $A_{1,2m-1}$ is given by

$$\Delta_{m-1}(x) \otimes f \in \otimes_{i=0}^{m-1} H_{4i-1} \otimes H_{4m-2}.$$

Recall that $A_{0,2m-1}$ is identified with the subalgebra $H_{[0,4m-3]}$ of $A_{1,2m-1}$. Thus, given $X \in A_{0,2m-1}$, its image in $A_{1,2m-1}$ is given by $1 \rtimes X \rtimes \epsilon$. Consequently, $A_{0,2m-1} \cap (A_{1,0})'$ equals

$$\{X \in H_{[0,4m-3]} : 1 \rtimes X \rtimes \epsilon \in H_{[-1,4m-2]} \text{ commutes with } \\ \Delta_{m-1}(x) \otimes f \in \otimes_{i=0}^{m-1} H_{4i-1} \otimes H_{4m-2}, \forall x \otimes f \in H \otimes H^*\}.$$

Similar kind of argument as in the proof of part (a) shows that this space can be identified with

$$\{X \in H_{[0,4m-4]} : X \text{ commutes with } \Delta_{m-1}(x) \in \otimes_{i=0}^{m-1} H_{4i-1}, \forall x \in H\}.$$

□

It follows from Remark 27(iii) that the Jones projection lying in $\mathcal{N}' \cap \mathcal{M}_{m+2} = A_{0,m+2} \cap (A_{1,0})'$ ($m \geq 0$) is given by $e_{0,m+2}$ (see Figure 27), which, under the identification of $A_{0,m+2} \cap (A_{1,0})'$ with \tilde{Q}_{m+2} as given by Proposition 29, is easily seen to be identified with the projection \tilde{e}_{m+2} in \tilde{Q}_{m+2} as shown on the left in Figure 28.

$$\begin{array}{ccc} \delta^{-2} \begin{array}{c} \cup \\ 2 \\ \cup \\ 2 \end{array} & \left| \begin{array}{c} \\ \\ \\ \\ \end{array} \right. & \begin{array}{ccc} \mathcal{N}' \cap \mathcal{M}_{m+1} & \longrightarrow & \tilde{Q}_{m+1} \\ \cup & & \cup \\ \mathcal{N}' \cap \mathcal{M}_m & \longrightarrow & \tilde{Q}_m \end{array} \end{array}$$

FIGURE 28. \tilde{e}_{m+2} (left) and a commutative diagram (right)

Remark 30. It is worth knowing the embedding of \tilde{Q}_m inside \tilde{Q}_{m+1} ($m \geq 1$). It follows easily from the embedding formulae of $A_{1,m}$ inside $A_{1,m+1}$ and Proposition 29 that given $X \in \tilde{Q}_m$, it sits inside \tilde{Q}_{m+1} as $\epsilon \rtimes 1 \rtimes X$ and the diagram on the right in Figure 28 commutes where each horizontal arrow indicates the $*$ -isomorphism.

For each integer $m \geq 1$, we define a subspace Q_m of $H_{[0,2m-2]}$ as follows:

$$Q_m = \{X \in H_{[0,2m-2]} : X \leftrightarrow \Delta_{k-1}(x) \in \otimes_{i=1}^k H_{4i-3}, \forall x \in H \text{ where } \\ k = \frac{m}{2} \text{ if } m \text{ is even or } \frac{m+1}{2} \text{ if } m \text{ is odd}\}$$

This is an immediate consequence of Lemma 4 that for any $m \geq 1$, \tilde{Q}_m is $*$ -anti-isomorphic to Q_m and let $\gamma_m : \tilde{Q}_m \rightarrow Q_m$ denote this anti-isomorphism. We then have the following commutative diagram.

$$\begin{array}{ccc} \tilde{Q}_{m+1} & \xrightarrow{\gamma_{m+1}} & Q_{m+1} \\ \cup & & \cup \\ \tilde{Q}_m & \xrightarrow{\gamma_m} & Q_m \end{array}$$

FIGURE 29. Commutative diagram

Further, if $e_m \in Q_m$ ($m \geq 2$) denotes the projection which is the image of $\tilde{e}_m \in \tilde{Q}_m$ under γ_m , it is then not hard to see that e_m is given by Figure 30. Note that the opposite algebra Q_m^{op} of Q_m is

$$\delta^{-2} \left| \begin{array}{c} 2(m-2) \\ \cup \\ 2 \\ \cup \end{array} \right.$$

FIGURE 30. e_m

given by

$$Q_m^{op} = \{X \in H_{[0,2m-2]}^{op} : X \leftrightarrow \Delta_{k-1}(x) \in \otimes_{i=1}^k H_{4i-3}, \forall x \in H \text{ where} \\ k = \frac{m}{2} \text{ if } m \text{ is even or } \frac{m+1}{2} \text{ if } m \text{ is odd}\}$$

Obviously, the identity map of Q_m onto Q_m^{op} is anti- $*$ -isomorphism. For each $m \geq 1$, let $\Psi_m : \mathcal{N}' \cap \mathcal{M}_m \rightarrow Q_m^{op}$ denote the following composite map:

$$\mathcal{N}' \cap \mathcal{M}_m \xrightarrow{* \text{-isom}} \tilde{Q}_m \xrightarrow{\gamma_m(* \text{-anti-isom})} Q_m \xrightarrow{\text{Identity}} Q_m^{op}.$$

Obviously Ψ_m is $*$ -isomorphism for each $m \geq 1$ and for $m \geq 2$, it carries $e_{0,m}$ to e_m . The commutative diagram on the right in Figure 28 and the commutative diagram of Figure 29 together imply commutativity of the following diagram (see Figure 31).

$$\begin{array}{ccc} \mathcal{N}' \cap \mathcal{M}_{m+1} & \xrightarrow{\Psi_{m+1}} & Q_{m+1}^{op} \\ \cup & & \cup \\ \mathcal{N}' \cap \mathcal{M}_m & \xrightarrow{\Psi_m} & Q_m^{op} \end{array}$$

FIGURE 31. Commutative diagram

Once again applying Ocneanu's compactness theorem and then proceeding along the same line of argument as in the proof of Proposition 29, one can show that:

Lemma 31. *The $*$ -isomorphism Ψ_m of $\mathcal{N}' \cap \mathcal{M}_m$ onto Q_m^{op} carries $\mathcal{M}' \cap \mathcal{M}_m$ onto the subspace of Q_m^{op} given by*

$$\{X \in H_{[2,2m-2]}^{op} : X \text{ commutes with } \Delta_{k-1}(x) \in \otimes_{i=1}^k H_{4i-3}, \forall x \in H\},$$

where $k = \frac{m}{2}$ or $\frac{m+1}{2}$ according as m is even or odd.

We conclude this section with the following lemma.

Lemma 32. $\mathcal{N} \subseteq \mathcal{M}$ is irreducible.

Proof. An appeal to Lemma 3 immediately shows that the space $Q_1 = \{f \in H_0 : f \text{ commutes with } H_1\}$ is trivial so that $\mathcal{N} \subseteq \mathcal{M}$ is irreducible. \square

5. ON PLANAR ALGEBRA OF $\mathcal{N} \subset \mathcal{M}$

In this section we give an explicit description of the planar algebra associated to $\mathcal{N} \subset \mathcal{M}$ and it turns out to be an interesting planar subalgebra of $^{*(2)}P(H^*)$.

For each $m \geq 1$, consider the linear map $\alpha^m : H \rightarrow \text{End}(P(H^*)_{2m})$ defined for $x \in H$ and $X \in P(H^*)_{2m}$ by Figure 32 where the notation α_x^m stands for $\alpha^m(x)$.

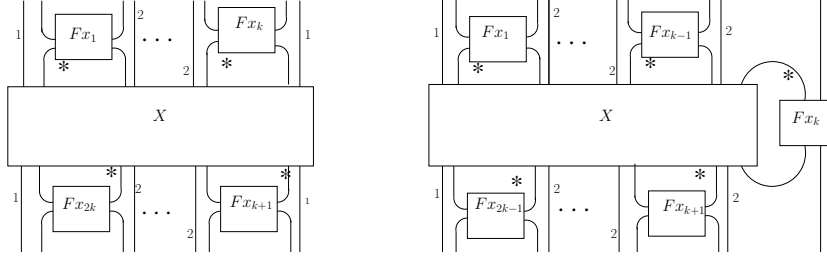

FIGURE 32. $\alpha_x^{2k}(X)$ (Left) and $\alpha_x^{2k-1}(X)$ (Right), where $k \geq 1$

With the help of the maps α^m defined above we give an alternative description of the spaces Q_m ($m \geq 1$).

Proposition 33. *For any $m \geq 1$,*

$$Q_m = \{X \in P(H^*)_{2m} : \alpha_h^m(X) = X\}.$$

Before we proceed to prove Proposition 33, we pause for a simple Hopf algebraic lemma.

Lemma 34. *Let $k \geq 1$ be an integer.*

- (a) *If $X \in H_{[0,4k-4]}$, the following are equivalent :*
 - (i) $X \rtimes 1$ commutes with $\Delta_{k-1}(x) \in \otimes_{i=1}^k H_{4i-3}, \forall x \in H$,
 - (ii) $\Delta_{k-1}(h_1)(X \rtimes 1)\Delta_{k-1}(Sh_2) = X \rtimes 1$, where $\Delta_{k-1}(h_1) \otimes \Delta_{k-1}(Sh_2) \in (\otimes_{i=1}^k H_{4i-3})^{\otimes 2}$.
- (b) *If $X \in H_{[0,4k-2]}$, the following are equivalent :*
 - (i) X commutes with $\Delta_{k-1}(x) \in \otimes_{i=1}^k H_{4i-3}, \forall x \in H$,
 - (ii) $\Delta_{k-1}(h_1)X\Delta_{k-1}(Sh_2) = X$, where $\Delta_{k-1}(h_1) \otimes \Delta_{k-1}(Sh_2) \in (\otimes_{i=1}^k H_{4i-3})^{\otimes 2}$.

Proof. (a) (i) \Rightarrow (ii) : Observe that

$$\Delta_{k-1}(h_1)\Delta_{k-1}(Sh_2) = \otimes_{i=1}^k h_i Sh_{2k-i+1} \in \otimes_{i=1}^k H_{4i-3}$$

which obviously equals 1 of $H_{[0,4k-3]}$. Therefore,

$$\Delta_{k-1}(h_1)(X \rtimes 1)\Delta_{k-1}(Sh_2) = (X \rtimes 1)\Delta_{k-1}(h_1)\Delta_{k-1}(Sh_2) = X \rtimes 1.$$

(ii) \Rightarrow (i) : Note that

$$\begin{aligned} \Delta_{k-1}(x)(X \rtimes 1) &= \Delta_{k-1}(x)\Delta_{k-1}(h_1)(X \rtimes 1)\Delta_{k-1}(Sh_2) \\ &= \Delta_{k-1}(xh_1)(X \rtimes 1)\Delta_{k-1}(Sh_2) \\ &= \Delta_{k-1}(h_1)(X \rtimes 1)\Delta_{k-1}(Sh_2x) \text{ (using } xh_1 \otimes Sh_2 = h_1 \otimes Sh_2x\text{)} \\ &= (\Delta_{k-1}(h_1)(X \rtimes 1)\Delta_{k-1}(Sh_2))\Delta_{k-1}(x) \\ &= (X \rtimes 1)\Delta_{k-1}(x) \end{aligned}$$

(b) Proof is similar to that of part (a).

□

We are now ready to prove Proposition 33.

Proof of Proposition 33. We prove the result for m odd say, $m = 2k - 1 (k \geq 1)$, leaving the case when m is even for the reader. This is an immediate consequence of Lemma 34(a) that the space Q_{2k-1} can equivalently be described as

$$Q_{2k-1} = \{X \in H_{[0,4k-4]} : \Delta_{k-1}(h_1)(X \rtimes 1)\Delta_{k-1}(Sh_2) = X \rtimes 1\}$$

where $\Delta_{k-1}(h_1) \otimes \Delta_{k-1}(h_2) \in (\otimes_{i=1}^k H_{4i-3})^{\otimes 2}$. Interpreting this equivalent description of Q_{2k-1} pictorially in $P(H^*)$, we note that Q_{2k-1} consists of precisely those elements $X \in P(H^*)_{4k-2}$ such that the pictorial equation of Figure 33 holds. Now applying the conditional expectation tangle E_{4k-1}^{4k-2} and then using once the multiplication relation in $P(H^*)$ we reduce the element on the left in Figure 33 to that on the left in Figure 34. On the other hand an application of the conditional expectation tangle E_{4k-1}^{4k-2} and then an appeal to the modulus relation reduces the element on the right in Figure 33 to that on the right in Figure 34. Now note that for any $x \in H$,

$$Fx_1Fx_2 = \delta^2\phi_2(x_1)\tilde{\phi}_2(x_2)\phi_1\tilde{\phi}_1 = \delta^2(\phi_2\tilde{\phi}_2)(x)\phi_1\tilde{\phi}_1 = \delta F(x).$$

Using this Hopf algebraic identity, one can easily see that the element on the left in Figure 34 just equals $\delta\alpha_h^{2k-1}(X)$ and consequently, we obtain from the pictorial equation of Figure 34 that $\alpha_h^{2k-1}(X) = X$, showing that $Q_{2k-1} \subseteq \{X \in P(H^*)_{4k-2} : \alpha_h^{2k-1}(X) = X\}$. To see the reverse inclusion, let $X \in P(H^*)_{4k-2}$ be such that $\alpha_h^{2k-1}(X) = X$. In order to verify that $X \in Q_{2k-1}$, it

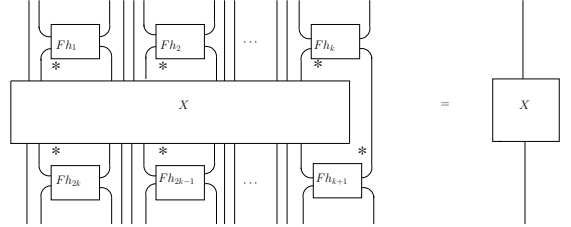

FIGURE 33. A characterisation of $X \in Q_{2k-1}$

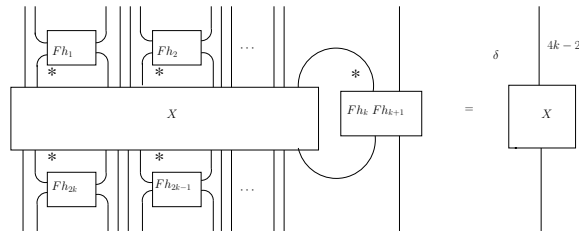

FIGURE 34. Another characterisation of $X \in Q_{2k-1}$

suffices to show, by Lemma 34, that

$$\Delta_{k-1}(\tilde{h}_1)(X \rtimes 1)\Delta_{k-1}(S\tilde{h}_2) = X \rtimes 1$$

with $\Delta_{k-1}(\tilde{h}_1) \otimes \Delta_{k-1}(S\tilde{h}_2) \in (\otimes_{i=1}^k H_{4i-3})^{\otimes 2}$ and where \tilde{h} , of course, denotes another copy of the unique non-zero idempotent integral of H . Applying multiplication rule in $P(H^*)$, it is easy to see

that the element of $P(H^*)_{4k-1}$ as depicted in Figure 35 represents $\Delta_{k-1}(\tilde{h}_1)(X \rtimes 1)\Delta_{k-1}(S\tilde{h}_2) \in H_{[0,4k-3]}$. Now, using the Hopf algebraic identity $\phi_1 \otimes \phi_2 f = \phi_1 S f \otimes \phi_2$ and the antipode, integral

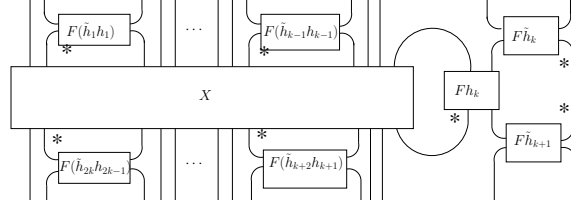

FIGURE 35. Pictorial description of $\Delta_{k-1}(\tilde{h}_1)(X \rtimes 1)\Delta_{k-1}(S\tilde{h}_2)$

and exchange relations in $P(H^*)$, the equation of Figure 36 can be verified to hold in $P(H^*)$ for all $x, y \in H$ and we leave this pleasant verification to the reader. Using the equation of Figure 36

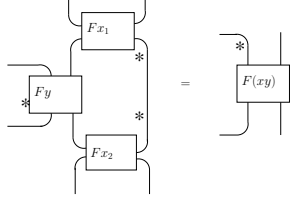

FIGURE 36. A relation in $P(H)^*$

and the fact that $\tilde{h}_1 h_1 \otimes \tilde{h}_2 h_2 \otimes \cdots \otimes \tilde{h}_{2k-1} h_{2k-1} = \Delta_{2k-2}(\tilde{h}h) = \Delta_{2k-2}(h)$, one can easily see that the element in Figure 35 indeed equals $\alpha_h^{2k-1}(X) \rtimes 1$ which, again by virtue of the fact that $\alpha_h^{2k-1}(X) = X$, equals $X \rtimes 1$ and the proof is complete. \square

Thus, we have a family $\{Q_m : m \geq 1\}$ of vector spaces where for each $m \geq 1$, Q_m is a subspace of $P(H^*)_{2m} = {}^{(2)}P(H^*)_m$. Setting $Q_{0,\pm} = \mathbb{C}$, we note that $Q := \{Q_m : m \in \text{Col}\}$ is a subspace of ${}^{(2)}P(H^*)$. The following proposition shows that Q is indeed a planar subalgebra of ${}^{(2)}P(H^*)$.

Proposition 35. Q is a planar subalgebra of ${}^{(2)}P(H^*)$.

Proof. By an appeal to Theorem 5, it suffices to prove that Q is closed under the action of the following set of tangles

$$\{1^{0,+}, 1^{0,-}\} \cup \{R_k^k : k \geq 2\} \cup \{M_{k,k}^k, E_{k+1}^k, I_k^{k+1} : k \in \text{Col}\}.$$

It is obvious that Q is closed under the action of the tangles $1^{0,\pm}$ and $M_{k,k}^k, I_k^{k+1}$ ($k \in \text{Col}$).

To see that Q is closed under the action of the rotation tangle R_k^k ($k \geq 2$), we note that for any $X \in Q_k$ ($k \geq 2$), we have

$$Z_{R_k^k}^{(2)P(H^*)}(X) = Z_{R_k^k}^{(2)P(H^*)}(\alpha_h^k(X)) = \alpha_h^k(Z_{R_k^k}^{(2)P(H^*)}(X))$$

where the first equality follows from the fact that $\alpha_h^k(X) = X$ and to see the second equality we need to use the Hopf algebra identity $h_1 \otimes h_2 \otimes \cdots \otimes h_l = h_2 \otimes h_3 \otimes \cdots \otimes h_l \otimes h_1$ ($l \geq 2$) which basically follows from $h_1 \otimes h_2 = h_2 \otimes h_1$ (which essentially expresses traciality of h).

Verifying that Q is closed under the action of E_{k+1}^k ($k \geq 1$) amounts to verification of the following identity

$$(5.2) \quad Z_{E_{k+1}^k}^{(2)P(H^*)}(X) = Z_{E_{k+1}^k}^{(2)P(H^*)}(\alpha_h^{k+1}(X)) = \alpha_h^k(Z_{E_{k+1}^k}^{(2)P(H^*)}(X))$$

for $X \in Q_{k+1}$. We observe that the first equality of (5.2) is obvious from the fact $\alpha_h^{k+1}(X) = X$. If k is even, the second equality of (5.2) follows easily by pictorially representing in $P(H^*)$ both sides of the equality and then using the relation C. When k is odd, verification of the second equality needs more effort. We first claim that the equation of Figure 37 holds in $P(H^*)$ for all $x \in H$. To see this note that for any $x \in H$, $Fx_1 \otimes Fx_2 = \delta^2(\phi_2\tilde{\phi}_2)(x)\phi_1 \otimes \tilde{\phi}_1$ which, by an appeal to the formula $\phi_1 \otimes \phi_2 f = \phi_1 S f \otimes \phi_2$, equals $\delta^2 \phi_2(x) \phi_1 S \tilde{\phi}_2 \otimes \tilde{\phi}_1$. Using this expression for $Fx_1 \otimes Fx_2$, we can reduce the element on the left in Figure 37 to that on the left in Figure 38. Using the multiplication and antipode relations in $P(H^*)$, one can easily see that the equation of Figure 38 holds. Finally, an application of the exchange relation and then the integral relation reduces the element on the right in Figure 38 to that on the right in 37, establishing our claim. When k is odd, to verify the second equality of (5.2), we just need to present pictorially elements on both sides of the equality in $P(H^*)$ and then apply the equation of Figure 37. This completes the proof of the proposition. \square

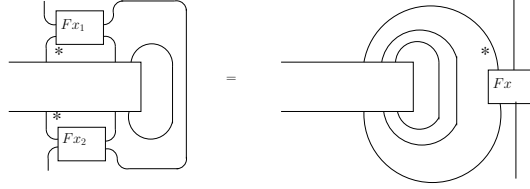

FIGURE 37. An equation in $P(H^*)$

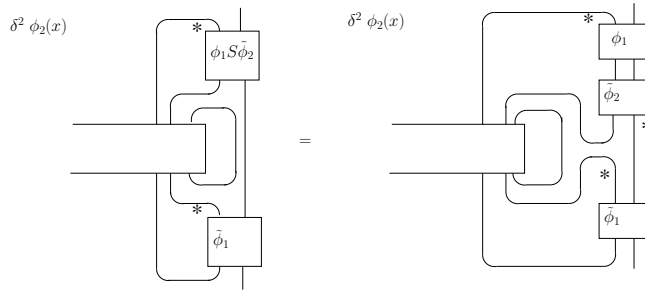

FIGURE 38. An equation in $P(H^*)$

As an immediate corollary of Proposition 35 we obtain that

Corollary 36. $*Q$ is a planar subalgebra of $^{*(2)}P(H^*)$.

The next proposition shows that $P^{\mathcal{N} \subset \mathcal{M}}$, the planar algebra associated to $\mathcal{N} \subset \mathcal{M}$, is given by the adjoint of the planar algebra Q .

Proposition 37. $P^{\mathcal{N} \subset \mathcal{M}} = *Q$.

Proof. In order to establish that $P^{\mathcal{N} \subset \mathcal{M}} = *Q$, we need to verify all the conditions of Theorem 6. We note first that the subfactor $\mathcal{N} \subset \mathcal{M}$ is extremal since it is irreducible by Lemma 32.

Obviously, $*Q$ has modulus δ^2 . In view of the commutative diagram in Figure 31, we note that for each $m \geq 1$, the identification of $*Q_m (= Q_m^{op})$ with $\mathcal{N}' \cap \mathcal{M}_m$ as $*$ -algebras (via Ψ^m) respects inclusion, verifying the condition (i) of Theorem 6. Verification of the condition (ii) follows from the trivial observation that $\delta^2 e_m = Z_{\mathcal{E}^m}^{*Q}(1)$ (see Figure 30 for the definition of e_m) for each $m \geq 2$. Since $*Q$ is a planar subalgebra of $^{*(2)}P(H^*)$, condition (iv) of Theorem 6 is automatically satisfied. We next observe, by virtue of Theorem 6 and Remark 7, that the linear map $Z_{(E')_k^k}^{*(2)P(H^*)}$ induced by the tangle $(E')_k^k$ ($k \geq 1$) is such that $\delta^{-2} Z_{(E')_k^k}^{*(2)P(H^*)} (= Z_{*(2)(E')_k^k}^{P(H^*)})$ equals the conditional expectation of $^{*(2)}P(H^*)_k (\cong H_{[0,2k-2]})$ onto the subspace $^{*(2)}P(H^*)_{1,k} (\cong H_{[2,2k-2]})$. Now, by Corollary 36, $*Q$ is a planar subalgebra of $^{*(2)}P(H^*)$ and hence, $Z_{(E')_k^k}^{*Q}$ carries $*Q_k (= \mathcal{N}' \cap \mathcal{M}_k)$ into $*Q_k \cap ^{*(2)}P(H^*)_{1,k}$. By definition of $*Q_k (= Q_k^{op})$ as given in §4.3 and Lemma 31, one can easily see that $*Q_k \cap ^{*(2)}P(H^*)_{1,k}$ indeed equals $\mathcal{M}' \cap \mathcal{M}_k$ so that $\delta^{-2} Z_{(E')_k^k}^{*Q}$ induces the conditional expectation of $\mathcal{N}' \cap \mathcal{M}_k$ onto $\mathcal{M}' \cap \mathcal{M}_k$, verifying the condition (iii) of Theorem 6. This completes the proof of the proposition. \square

We collect the results of the previous statements into a single main theorem.

Theorem 38. *$*Q$ is a planar subalgebra of $^{*(2)}P(H^*)$ and $*Q = P^{\mathcal{N} \subset \mathcal{M}}$. For each $k \geq 1$, $*Q_k$ consists of all $X \in P(H^*)_{2k}$ such that the element shown in Figure 39 equals X .*

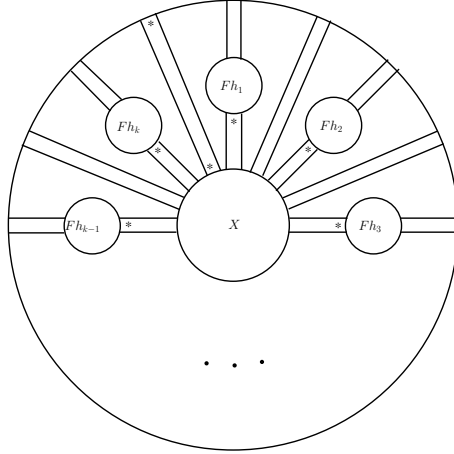

FIGURE 39. Characterisation of the image

Proof. It follows immediately from Proposition 37 after observing that $\alpha_h^k(X)$ in Figure 32 is equivalent to the element in Figure 39. \square

6. MAIN RESULT

In this section we show that $\mathcal{M} \cong \mathcal{N} \rtimes D(H)^{cop}$ by showing that the planar algebra of $\mathcal{N} \subset \mathcal{M}$ is isomorphic to the planar algebra of $R \subset R \rtimes D(H)^{cop}$ for an outer action of $D(H)^{cop}$ on the hyperfinite II_1 factor R where $D(H)$ is the Drinfeld double of H . We refer to [16] for the Drinfeld double construction.

In [3], the authors produced an explicit embedding of the planar algebra of the Drinfeld double of a finite-dimensional, semisimple and cosemisimple Hopf algebra (and hence, in particular, a Kac

algebra) H into ${}^{(2)}P(H^*)$ and characterised the image. Let Q denote the image of planar algebra of $D(H)$ inside ${}^{(2)}P(H^*)$. The following theorem, which is a reformulation of [3, Theorem 9], gives an explicit characterisation of the image Q . It is worth mentioning that this statement uses the newer version of planar algebras with spaces indexed by $\{\mathbb{N} \cup 0\} \times \{+, -\}$. We refer to §2.1 for the older and newer notions of planar algebras.

Theorem 39. [3, Theorem 9]

Q is characterised as follows: $Q_{k,+}$ (resp. $Q_{k,-}$) is the set of all $X \in P(H^*)_{2k,+}$ such the element on the left (resp. right) in Figure 40 equals X where $h \in H$ is the unique non-zero idempotent integral.

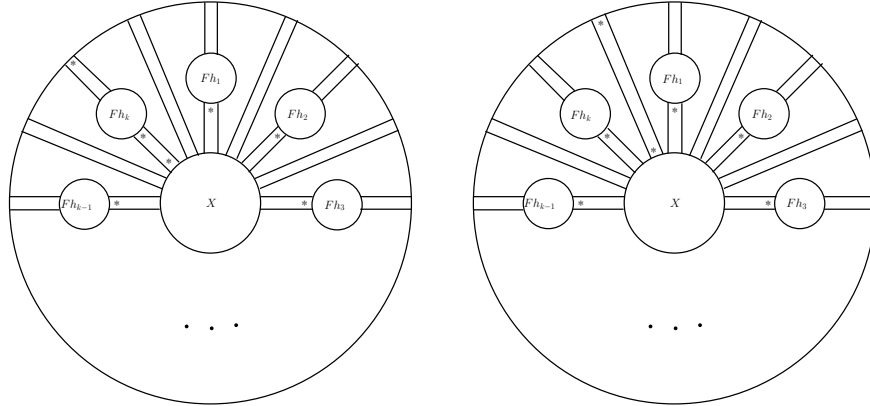

FIGURE 40. Characterisation of the image

Let Q_1 and Q_2 be planar subalgebras of ${}^{(2)}P(H^*)$ in the older sense defined by setting $(Q_1)_{0,\pm} = (Q_2)_{0,\pm} = \mathbb{C}$ and for any positive integer k , $(Q_1)_k = Q_{k,+}$, $(Q_2)_k = Q_{k,-}$. Then note that Q_1 is isomorphic to the planar algebra associated to $D(H)$ in the older sense and corresponds to the subfactor $R^{D(H)} \subset R$ whereas Q_2 corresponds to its dual i.e., to $R \subset R \rtimes D(H)$ for some outer action of $D(H)$ on R . Using the fact - see [13, Remark 4.18] - that for any Kac algebra K , $*P(K) \cong P(K^{op})$, we conclude that $*Q_1$ corresponds to the subfactor $R^{D(H)^{op}} \subset R$ and consequently, $*Q_2$ corresponds to $R \subset R \rtimes D(H)^{op} \cong R \subset R \rtimes D(H)^{cop}$. It is now an immediate consequence of these observations together with Theorem 39 and the description of the planar algebra of $\mathcal{N} \subset \mathcal{M}$ as given by Theorem 38 that $P^{\mathcal{N} \subset \mathcal{M}} = *Q_2$. Finally, an application of Jones' theorem - see Theorem 6 - immediately yields our main result.

Theorem 40. *The quantum double inclusion $\mathcal{N} \subset \mathcal{M}$ of $R^H \subset R$ is isomorphic to $R \subset R \rtimes D(H)^{op} (\cong R \subset R \rtimes D(H)^{cop})$ for some outer action of $D(H)^{op} (\cong D(H)^{cop})$ on the hyperfinite II_1 factor R .*

ACKNOWLEDGEMENT

The author sincerely thanks Prof. Vijay Kadiyalam, IMSc, for a careful reading of the manuscript and suggestions for improvement and also for his support, constructive comments and several fruitful discussions during the whole project. He also thanks Prof. David Evans for his support in making it possible to attend the inspiring programme “Operator Algebras: Subfactors and their Applications” held at INI, 2017 while this paper was being written up. The author is supported by the National Board of Higher Mathematics, India.

REFERENCES

- [1] Robert J. Blattner and Susan Montgomery, *A duality theorem for Hopf module algebras*, Journal of Algebra, 95, No. 1 (1985), 153-172.

- [2] Sandipan De and Vijay Kodiyalam, *Note on infinite iterated crossed products of Hopf algebras and the Drinfeld double*, Journal of Pure and Applied Algebra, 219, No. 12 (2015), 5305-5313.
- [3] Sandipan De and Vijay Kodiyalam, *Planar algebras, cabling and the Drinfeld double*, Quantum Topology, 9, No. 1 (2018), 141-165.
- [4] D. E. Evans and Y. Kawahigashi, *Quantum Symmetry on operator algebras*, Oxford Univ. Press, 1998.
- [5] D. E. Evans and Y. Kawahigashi, *On Ocneanu theory of asymptotic inclusions for subfactors, topological quantum field theories and quantum doubles*, Internat. J. Math., 6, No. 2 (1995), 205-228.
- [6] F.M. Goodman, P. de la Harpe and V.F.R Jones, *Coxeter graphs and towers of algebras*, MSRI Publ., 14, Springer, New York, 1989.
- [7] M. Izumi, *The structure of sectors associated with Longo-Rehren inclusions I. General theory*, Comm. Math. Phys., 213, No. 1 (2000), 127-179.
- [8] M. Izumi, *The structure of sectors associated with Longo-Rehren inclusions. II. Examples*, Rev. Math. Phys., 13, No. 5 (2001), 603-674.
- [9] S. Jijo, *Planar algebra associated to the Asymptotic inclusion of a Kac algebra subfactor*, Ph.D. thesis, Homi Bhabha National Institute, 2008.
- [10] V. F. R. Jones, *Planar algebras*, To appear in New Zealand J. Math. arXiv:math/9909027.
- [11] V.F.R. Jones and V.S. Sunder, *Introduction to Subfactors*, Cambridge University Press, 1997.
- [12] Vijay Kodiyalam, Zeph Landau, V.S. Sunder, *The planar algebra associated to a Kac algebra*, Functional analysis (Kolkata, 2001). Proc. Indian Acad. Sci. Math. Sci. 113, No. 1 (2003), 15-51.
- [13] Vijay Kodiyalam and V. S. Sunder, *On Jones' planar algebras*, Journal of Knot Theory and its Ramifications, 13, No. 2 (2004), 219-248.
- [14] Vijay Kodiyalam and V. S. Sunder, *The planar algebra of a semisimple and cosemisimple Hopf algebra*, Proceedings of the Indian Academy of Sciences, 116, No. 4 (2006), 443-458.
- [15] Vijay Kodiyalam and V.S. Sunder, *From subfactor planar algebras to subfactors*, Internat. J. Math. 20, No. 10 (2009), 1207-1231.
- [16] Shahn Majid, *A Quantum Groups Primer*, London Mathematical Society Lecture Note Series 292, Cambridge University Press, Cambridge, 2002.
- [17] Michael Muger *From subfactors to categories and topology II. The quantum double of tensor categories and subfactors*, J. Pure Appl. Algebra, 180 (2003), 159-219.
- [18] W. Szymanski, *Finite index subfactors and Hopf algebra crossed products*, Proc. Amer. Math. Soc. 120, (2) (1994) 519-528.

STAT-MATH UNIT, INDIAN STATISTICAL INSTITUTE, 8TH MILE, MYSORE ROAD, BANGALORE-560059

E-mail address: sandipan-vs@isibang.ac.in