

# Dynamic Flows with Adaptive Route Choice

Lukas Graf and Tobias Harks\*

Augsburg University, Institute of Mathematics, 86135 Augsburg  
[lukas.graf,tobias.harks}@math.uni-augsburg.de](mailto:{lukas.graf,tobias.harks}@math.uni-augsburg.de)

Leon Sering

Technische Universität Berlin, Institute of Mathematics, 10587 Berlin  
[sering@math.tu-berlin.de](mailto:sering@math.tu-berlin.de)

June 4, 2019

We study dynamic network flows and introduce a notion of *instantaneous dynamic equilibrium (IDE)* requiring that for any positive inflow into an edge, this edge must lie on a currently shortest path towards the respective sink. We measure current shortest path length by current waiting times in queues plus physical travel times. As our main results, we show:

1. existence and constructive computation of IDE flows for single-source single-sink networks assuming constant network inflow rates,
2. finite termination of IDE flows for multi-source single-sink networks assuming bounded and finitely lasting inflow rates,
3. the existence of IDE flows for multi-source multi-sink instances assuming general measurable network inflow rates,
4. the existence of a complex single-source multi-sink instance in which any IDE flow is caught in cycles and flow remains forever in the network.

## 1 Introduction

Dynamic network flows have been studied for decades in the optimization and transportation literature, see the classical book of Ford and Fulkerson [6] or the more recent surveys of Skutella [20] and Peeta [15]. A fundamental model describing the dynamic

---

\*The research of the authors was funded by the Deutsche Forschungsgemeinschaft (DFG, German Research Foundation) - HA 8041/1-1 and HA 8041/4-1.

flow propagation process is the so-called *deterministic queue model*, see Vickrey [23]. Here, a directed graph  $G = (V, E)$  is given, where edges  $e \in E$  are associated with a queue with positive rate capacity  $\nu_e \in \mathbb{R}_+$  and a physical transit time  $\tau_e \in \mathbb{R}_+$ . If the total inflow into an edge  $e = vw \in E$  exceeds the rate capacity  $\nu_e$ , a queue builds up and agents need to wait in the queue before they are forwarded along the edge. The total travel time along  $e$  is thus composed of the waiting time spent in the queue plus the physical transit time  $\tau_e$ . A schematic illustration of the inflow and outflow mechanics of an edge  $e$  is given in Figure 1.

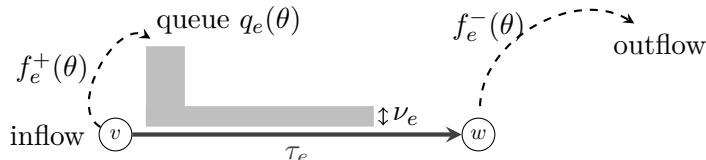

Figure 1: An edge  $e = vw$  with a nonempty queue.

The fluid queue model has been mostly studied from a game-theoretic perspective, where it is assumed that agents act selfishly and travel along shortest routes under prevailing conditions. This behavioral model is known as *dynamic equilibrium* and has been analyzed in the transportation science literature for decades, see Friesz et al. [7], Meunier and Wagner [14] and Zhu and Marcotte [24]. In the past years, however, several new exciting developments have emerged: Koch and Skutella [12] elegantly characterized dynamic equilibria by their derivatives, which gives a template for their computation. Subsequently, Cominetti, Correa and Larré [4] derived alternative characterizations and proved existence and uniqueness in terms of experienced travel times of equilibria even for multi-commodity networks. Very recently, Cominetti, Correa and Olver [5] shed light on the behavior of steady state queues assuming single commodity networks and constant inflow rates. Sering and Vargas-Koch [19] analyzed the impact of spillbacks in the fluid queuing model and Bhaskar et al. [1] devised Stackelberg strategies in order to improve the efficiency of dynamic equilibria.

The concept ‘dynamic equilibrium’ assumes *complete knowledge and simultaneous route choice* by all travelers. Complete knowledge requires that a traveler is able to exactly forecast future travel times along the chosen path effectively anticipating the whole evolution of the flow propagation process across the network. This assumption has been justified by letting travelers learn good routes over several trips and a dynamic equilibrium then corresponds to an attractor of the underlying learning dynamic. While certainly relevant, this concept may not accurately reflect the behavioral changes caused by the wide-spread use of navigation devices. As also discussed in Marcotte et al. [13], Hamdouch et al. [10] and Unnikrishnan and Waller [22], drivers may not always learn good routes over several trips but are now informed in real-time about the current traffic situations and, if beneficial, reroute instantaneously no matter how good or bad that route was in hindsight. Also, the information available to a navigation device is usually not complete, that is, congestion information is available only as an aggregate

(estimated waiting times for road traversal) but the individual routes and/or source and destinations of travelers are unknown – for good reason.<sup>1</sup>

In this paper, we consider an adaptive route choice model, where at every node (intersection), travelers may alter their route depending on the current network conditions, that is, based on current travel times and queuing delays. The needed information is anonymous and indeed available by navigation devices. We assume that, if a traveler arrives at the end of an edge, she may change the current route and opt for a currently shorter one. This type of reasoning does neither rely on personalized information nor on the capability of unraveling the future flow propagation process. We term a dynamic flow an *instantaneous dynamic equilibrium (IDE)*, if for every point in time and every edge with positive inflow (of some commodity), this edge lies on a currently shortest path towards the respective sink. In the following, we illustrate IDE in comparison to classical dynamic equilibrium with an example.

### 1.1 An Example

Consider the network in Figure 2 (left). There are two source nodes  $s_1$  and  $s_2$  with constant inflow rates  $u_1(\theta) \equiv 3$  for  $\theta \in [0, 1)$  and  $u_2(\theta) \equiv 4$  for  $\theta \in [1, 2)$ . Commodity 1 (red) has two simple paths connecting  $s_1$  with the sink  $t$ . Since both have equal length ( $\sum_e \tau_e = 3$ ), in an IDE both can be used by commodity 1. In Figure 2, the flow takes the direct edge to  $t$  with a rate of one, while edge  $s_1v$  is used at a rate of two. This is actually the only split possible in an IDE, since any other split (different in more than just a subset of measure zero of  $[0, 1)$ ) would result in a queue forming on one of the two edges, which would make the respective path longer than the other one. At time  $\theta = 1$ , the inflow at  $s_1$  stops and a new inflow of commodity 2 (blue) at  $s_2$  starts. This new flow again has two possible paths to  $t$ , however, here the direct path ( $\sum_e \tau_e = 1$ ) is shorter than the alternative ( $\sum_e \tau_e = 4$ ). So all flow enters edge  $s_2t$  and starts to form a queue. At time  $\theta = 2$ , the first flow particles of commodity 1 arrive at  $s_2$  with a rate of 2. Since the flow of commodity 2 has built up a queue of length 3 on edge  $s_2t$  by this time, the estimated travel times  $\sum_e (\tau_e + q_e(\theta))$  are the same on both simple  $s_2-t$  paths. Thus, the red flow is split evenly between both possible paths. This results in the queue-length on edge  $s_2t$  remaining constant and therefore this split gives us an IDE flow for the interval  $[2, 3)$ . At time  $\theta = 3$ , red particles will arrive at  $s_1$  again, thus, completing a full cycle (namely  $s_1, v, s_2, s_1$ ). This example shows that IDE flows may involve a flow decomposition along cycles. In contrast, the (classical) dynamic equilibrium flow will just send more of the red flow along the direct path  $s_1, t$  since the future queue growth at edge  $s_2t$  of the alternative path is already anticipated.

Note that cycles can appear even in the case of only a single player (and therefore a single-source and sink) - see Example 3.7 for such an instance. This shows that the differences between the two equilibrium concepts are quite fundamental and occur even in simple examples.

---

<sup>1</sup>Some navigation systems have a large population of customers from which they infer even personalized information, but complete knowledge over all travelers seems unrealistic.

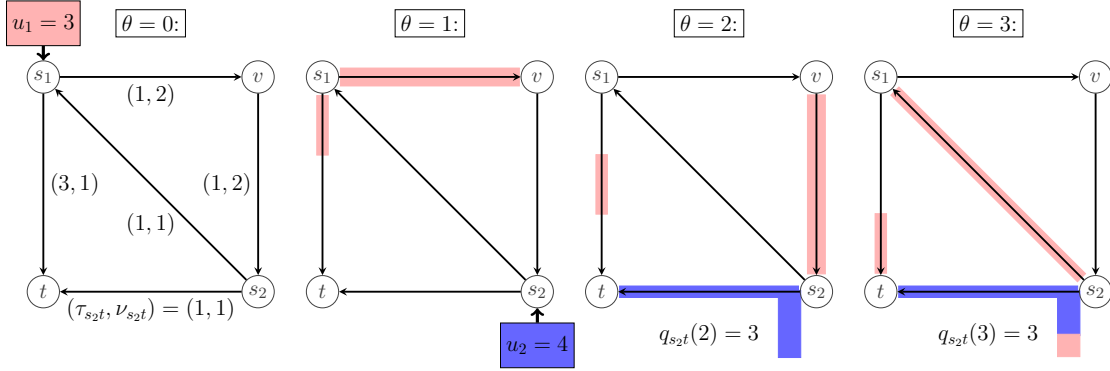

Figure 2: *The evolution of an IDE flow over the time horizon  $[0, 3]$ .*

## 1.2 Related Work

In the transportation science literature, the idea of an instantaneous user or dynamic equilibrium has already been proposed since the late 80's, see Ran and Boyce [16, § VII-IX], Boyce, Ran and LeBlanc [2, 17], Friesz et al. [8]. These works develop an optimal control-theoretic formulation and characterize instantaneous user equilibria by Pontryagin's optimality conditions. However, not much is known regarding IDE existence and their structural properties. In fact, the underlying equilibrium concept of Boyce, Ran and LeBlanc [2, 17] and Friesz et al. [8] is different from ours. While the verbally written concept of an IDE is similar to the one we use here, the mathematical definition of an IDE in [2, 8, 17] requires that instantaneous travel times are minimal for *used paths* towards the sink. A path is used, if every arc of the path has positive flow. As, for instance, the authors in Boyce, Ran and LeBlanc [2, p.130] admit: "Specifically with our definition of a used route, it is possible that no route is ever 'used' because vehicles stop entering the route before vehicles arrive at the last link on the route. Thus, for some networks every flow can be in equilibrium." Ran and Boyce [16, § VII, pp.148 ] present a link-based definition of IDE. They define node labels at nodes  $v \in V$  indicating the current shortest travel time from the source node to some intermediate node  $v$  and require that whenever edge  $vw$  has positive flow, edge  $vw$  must be contained in a shortest  $s$ - $w$  path. This is different from our definition of an IDE, because we require that whenever there is positive inflow into an edge  $vw$ , it must be contained in a currently shortest  $v$ - $t$  path, where  $t$  is the sink of the considered inflow.

Another important difference to our model is the assumed time horizon. The previous works [2, 16, 8, 17] all assume a *finite time horizon* on which the control problems are defined, thus, only describing the flow trajectories over the given time horizon. All numerical studies and simulation results appearing in these works further implicitly assume that for given finitely lasting bounded inflow rates, there exists a finite time horizon  $[0, T]$  with  $T$  large enough so that eventually all travelers reach their destination. Our results reveal that this is in fact not true: there are multi-commodity instances with finitely lasting bounded inflows that admit IDE flows cycling forever. For the discrete version of this model, such a behavior was already discovered in Ismaili [11, Theorem

8], though his instance makes critical use of edges with zero transit time (which we do not allow) and the instantaneous travel time is allowed to increase even when the edge inflow rate is smaller than the rate capacity. Based on this flexibility, the generated instance is considerably simpler than ours but one can show that continuous IDE flows do terminate in that instance.

### 1.3 Our Results

We define in this paper a notion of instantaneous dynamic equilibrium (IDE) stating that a dynamic flow is an IDE, if at any point in time, for every edge with positive inflow (of some commodity), this edge lies on a currently shortest path towards the respective sink.

Our first main result (Theorem 3.3) shows that IDE exist for multi-source single-sink networks with piecewise constant inflow rates (generating the volume of agents originating at the sources). The existence proof relies on a constructive method extending any IDE flow up to time  $\theta$  to an IDE flow on a strictly larger interval  $\theta + \epsilon$  for some  $\epsilon > 0$ . The key insight for the extension procedure relies on solving a sequence of nonlinear programs, each associated with finding the right outflow split for given node inflows. We also show that such solutions can be found by a simple water filling procedure. With the extension property we can apply a limit argument on the real numbers implying the existence of IDE on the whole  $\mathbb{R}_{\geq 0}$ .

Given that, unlike the classical dynamic equilibrium, IDE flows may involve cycling behavior (see the example in Figure 2), we turn to the issue of whether it is possible that positive flow volume remains forever in the network (assuming finitely lasting bounded inflows). Our second main result (Theorem 4.6) shows that for multi-source single-sink networks, this is impossible: Even for arbitrary bounded and finitely lasting inflow rate functions, there exists a finite time  $T > 0$  at which the network is cleared, that is, all flow particles have reached their destination within the time horizon  $[0, T]$ .

We then turn to general multi-source multi-sink networks. Here, we also derive an extension property by describing IDE flows as solutions of a suitable variational inequality in a Hilbert space for which we can use standard existence theorems. Then, again a limit argument proves existence of IDE over the whole  $\mathbb{R}_{\geq 0}$  (Theorem 5.3).

Finally, we show that for bounded and finitely lasting inflow rates, termination in finite time is *not* guaranteed anymore as soon as the network contains more than one sink (Theorem 6.1). We construct a quite complex instance where IDE flows exist, but all IDE flows are caught in cycles and travel forever. This instance reveals that the assumption of a finite time horizon  $[0, T]$  made previously in the transportation literature cannot be made without loss of generality. We also show that the instance can be modified in such a way that only a single-source is needed.

## 2 The Flow Model

In the following, we describe a fluid queuing model as used before by Koch and Skutella [12] and Cominetti, Correa and Larré [4].

We consider a finite directed graph<sup>2</sup>  $G = (V, E)$  with positive rate capacities  $\nu_e \in \mathbb{R}_+$  and positive transit times  $\tau_e \in \mathbb{R}_+$  for every  $e \in E$ . There is a finite set of commodities  $I = \{1, \dots, n\}$ , each with a commodity-specific source node  $s_i \in V$  and a commodity-specific sink node  $t_i \in V$ . We will always assume that there is at least one  $s_i$ - $t_i$  path for each  $i \in I$ . The (infinitesimally small) agents of every commodity  $i \in I$  enter the network according to a integrable network inflow rate function  $u_i : \mathbb{R}_{\geq 0} \rightarrow \mathbb{R}_{\geq 0}$ .

A *flow over time* is a tuple  $f = (f^+, f^-)$ , where  $f^+, f^- : \mathbb{R}_{\geq 0} \times E \times I \rightarrow \mathbb{R}_{\geq 0}$  are integrable functions modeling the edge inflow rate  $f_{i,e}^+(\theta)$  and edge outflow rate  $f_{i,e}^-(\theta)$  of commodity  $i$  of an edge  $e \in E$  at time  $\theta \geq 0$ .

The *queue length* of edge  $e$  at time  $\theta$  is given by

$$q_e(\theta) := \sum_{i \in I} F_{i,e}^+(\theta) - \sum_{i \in I} F_{i,e}^-(\theta + \tau_e) \quad \text{for all } \theta \in \mathbb{R}_{\geq 0}, \quad (1)$$

where

$$F_{i,e}^+(\theta) := \int_0^\theta f_{i,e}^+(z) dz \quad \text{and} \quad F_{i,e}^-(\theta) := \int_0^\theta f_{i,e}^-(z) dz$$

denote the *cumulative (edge) inflow* and *cumulative (edge) outflow*. We implicitly assume  $f_{i,e}^-(\theta) = 0$  for all  $\theta \in [0, \tau_e)$ , which will ensure together with Constraint (4) (see below) that the queue lengths are always non-negative. Furthermore, we define the cumulative network inflow rate by  $U_i(\theta) := \int_0^\theta u_i(z) dz$  and, for the sake of simplicity, we denote the aggregated flow over all commodities by  $f_e^+ := \sum_{i \in I} f_{i,e}^+$  and  $f_e^- := \sum_{i \in I} f_{i,e}^-$ , as well as,  $F_e^+ := \sum_{i \in I} F_{i,e}^+$  and  $F_e^- := \sum_{i \in I} F_{i,e}^-$ .

A *feasible* flow over time satisfies the following conditions (2), (3), (4), and (6). The *flow conservation constraints* are modeled for a commodity  $i \in I$  and all nodes  $v \neq t_i$  as

$$\sum_{e \in \delta_v^+} f_{i,e}^+(\theta) - \sum_{e \in \delta_v^-} f_{i,e}^-(\theta) = \begin{cases} u_i(\theta), & \text{if } v = s_i \\ 0, & \text{if } v \neq s_i, \end{cases} \quad (2)$$

where  $\delta_v^+ := \{vu \in E\}$  and  $\delta_v^- := \{uv \in E\}$  are the sets of outgoing edges from  $v$  and incoming edges into  $v$ , respectively. For the sink node  $t_i$  of commodity  $i$  we require

$$\sum_{e \in \delta_{t_i}^+} f_{i,e}^+(\theta) - \sum_{e \in \delta_{t_i}^-} f_{i,e}^-(\theta) \leq 0. \quad (3)$$

We assume that the queue operates at capacity which can be modeled by

$$f_e^-(\theta + \tau_e) = \begin{cases} \nu_e, & \text{if } q_e(\theta) > 0 \\ \min \{ f_e^+(\theta), \nu_e \}, & \text{if } q_e(\theta) = 0 \end{cases} \quad \text{for all } e \in E, \theta \in \mathbb{R}_{\geq 0}. \quad (4)$$

---

<sup>2</sup>Note that all results of this paper also hold for multigraphs.

Since  $q'_e(\theta) = \sum_{i \in I} f_{i,e}^+(\theta) - \sum_{i \in I} f_{i,e}^-(\theta + \tau_e)$ , this condition is equivalent to the following equation describing the queue length dynamics (cf. [4, Section 2.2]):

$$q'_e(\theta) = \begin{cases} f_e^+(\theta) - \nu_e, & \text{if } q_e(\theta) > 0 \\ \max\{0, f_e^+(\theta) - \nu_e\}, & \text{if } q_e(\theta) = 0 \end{cases} \quad \text{for all } e \in E, \theta \in \mathbb{R}_{\geq 0}. \quad (5)$$

In order to prevent flow from changing its commodity on an edge, we require the total amount of flow of every commodity that has left an edge to not exceed the total amount of flow of this commodity that has reached the head of this edge to that point in time. More precisely, we have the following condition:

$$F_{i,e}^-(\theta) \leq F_{i,e}^+(\theta - \tau_e) \quad \text{for all } i \in I, e \in E, \theta \in \mathbb{R}_{\geq 0}. \quad (6)$$

Note that it is possible that flow of some commodity can overtake flow of other commodities within the queues. If we want the flow to follow a strict FIFO principle on the queues, we can replace (6) by the following condition (see [18]):

$$f_{i,e}^-(\theta) := \begin{cases} f_e^-(\theta) \cdot \frac{f_{i,e}^+(\vartheta)}{f_e^+(\vartheta)} & \text{if } f_e^+(\vartheta) > 0, \\ 0 & \text{else,} \end{cases} \quad (7)$$

where  $\vartheta := \min \{ \vartheta \leq \theta \mid \vartheta + \tau_e + \frac{q_e(\vartheta)}{\nu_e} = \theta \}$  is the earliest point in time a particle can enter edge  $e$  in order to leave it at time  $\theta$ . The quotient  $\frac{q_e(\vartheta)}{\nu_e}$  is hereby the current waiting time to be spent in the queue of edge  $e$ . In other words, Constraint (7) ensures that the share of commodity  $i$  of the aggregated outflow rate at some point in time  $\theta$  equals the share of commodity  $i$  of the aggregated inflow rate at the time the particles entered the edge. If (7) is satisfied, we call  $f$  a *feasible flow over time with FIFO*.

We assume that, whenever an agent arrives at an intermediate node  $v$  at time  $\theta$ , she is given the information about the current queue lengths and transit times  $q_e(\theta), \tau_e, e \in E$ , and, based on this information, she computes a shortest  $v$ - $t$  path and enters the first edge on this path (breaking potential ties arbitrarily). We define the *instantaneous travel time* of an edge  $e$  at time  $\theta$  as

$$c_e(\theta) = \tau_e + \frac{q_e(\theta)}{\nu_e}. \quad (8)$$

We can now define commodity-specific node labels  $\ell_{i,v}(\theta)$  corresponding to current shortest path distances from  $v$  to the sink  $t_i$ . For  $i \in I, v \in V$  and  $\theta \in \mathbb{R}_{\geq 0}$ , define

$$\ell_{i,v}(\theta) := \begin{cases} 0, & \text{for } v = t_i \\ \min_{e=vw \in E} \{ \ell_{i,w}(\theta) + c_e(\theta) \}, & \text{else.} \end{cases} \quad (9)$$

We say that edge  $e = vw$  is *active* for  $i \in I$  at time  $\theta$ , if  $\ell_{i,v}(\theta) = \ell_{i,w}(\theta) + c_e(\theta)$  and we denote the set of active edges for commodity  $i$  by  $E_\theta^i \subseteq E$ . We call a  $v$ - $t_i$  path  $P$

an *active  $v$ - $t_i$  path for commodity  $i$  at time  $\theta$* , if all edges of  $P$  are active for  $i$  at  $\theta$  or, equivalently,  $\sum_{e \in P} c_e(\theta) = \ell_{i,v}(\theta)$ . For differentiation we call paths that are minimal with respect to the transit times  $\tau$  *physical shortest paths*.

Now we are ready to formally define an instantaneous dynamic equilibrium for multi-commodity flows over time:

**Definition 2.1.** A feasible flow over time  $f$  is an *instantaneous dynamic equilibrium (IDE)*, if for all  $i \in I, \theta \in \mathbb{R}_{\geq 0}$  and  $e \in E$  it satisfies

$$f_{i,e}^+(\theta) > 0 \Rightarrow e \in E_\theta^i. \quad (10)$$

In other words, a feasible flow over time  $f$  is an IDE, if, whenever flow of commodity  $i$  enters an edge  $e = vw$  at some point  $\theta$ , this edge is contained in the set of active edges  $E_\theta^i$ , i.e.,  $e$  lies on a currently shortest path from  $v$  to  $t_i$ .

Note that, while the set of active edges  $E_\theta^i$  changes over time, the set of nodes, from which  $t_i$  is reachable via  $E_\theta^i$  (i.e.  $\{v \in V \mid \ell_{i,v}(\theta) < \infty\}$ ) does not. In particular, this means that, whenever flow of commodity  $i$  enters an active edge  $uv, v \neq t_i$ , there will be at least one active edge leaving  $v$  by the time the flow reaches  $v$  – possibly different edges than those active when the flow entered  $u$ .

### 3 Existence and Computation of IDE Flows in Single-Sink Networks

In this and the following chapter we only consider single-sink networks, i.e., networks where all commodities have one common sink node  $t$ . In this case all commodities have the same label function, which we will denote by  $\ell_v$ . Since the origin of a particle in the network is not important for its route to the sink, we do not distinguish the commodities, and instead, only consider the aggregated flow functions  $f_e^+$  and  $f_e^-$ . Furthermore, we restrict the network inflow functions  $u_i$  to be right-constant, where a function  $u : [a, b) \rightarrow \mathbb{R}$  is *right-constant*, if for every  $\theta \in [a, b)$  there exists an  $\varepsilon > 0$  such that  $u$  is constant on  $[\theta, \theta + \varepsilon)$ . For this case, we will now describe an algorithm computing an IDE flow.

Let  $f = (f^+, f^-)$  denote a feasible flow over time. We denote by

$$b_v^-(\theta) := \sum_{e \in \delta_v^-} f_e^-(\theta) + \sum_{i \in I: s_i=v} u_i(\theta) \quad (11)$$

the current inflow at node  $v$  at time  $\theta$ . Moreover, let  $\delta_v^+(\theta) := \delta_v^+ \cap E_\theta$  denote the set of outgoing edges of  $v$  that are active at time  $\theta$ . The main idea of our algorithm works as follows. Starting from time  $\theta = 0$  we compute inductively a sequence of intervals  $[0, \theta_1), [\theta_1, \theta_2), \dots$  with  $0 < \theta_i < \theta_{i+1}$  and corresponding *constant* edge inflows  $(f_e^+(\theta))_e$  for  $\theta \in [\theta_i, \theta_{i+1})$  that form together with the corresponding edge outflows  $(f_e^-(\theta))_e$  an IDE. Suppose we are given an *IDE flow up to time  $\theta_k$* , that is, a tuple  $(f^+, f^-)$  of right-constant functions  $f_e^+ : [0, \theta_k) \rightarrow \mathbb{R}_{\geq 0}$  and  $f_e^- : [0, \theta_k + \tau_e) \rightarrow \mathbb{R}_{\geq 0}$



satisfying Constraints (2) to (4) and (10). Note that this is enough information to compute  $F_e^+(\theta_k)$  and  $F_e^-(\theta_k + \tau_e)$ , and thus also  $q_e(\theta_k)$ ,  $c_e(\theta_k)$  and  $\ell_v(\theta_k)$  for all  $e \in E$  and  $v \in V$ . We now describe how to extend this feasible flow over time to the interval  $[\theta_k, \theta_k + \varepsilon)$  for some  $\varepsilon > 0$ . The idea is that whenever there is positive inflow  $b_v^-(\theta_k) > 0$  into some node  $v \in V$ , we assign this inflow to outgoing edges that are currently active. Since the node labels at the heads of these edges depend themselves on queue dynamics at other nodes along a currently shortest path towards  $t$ , we need to handle *time-varying* labels  $\ell_w(\theta)$  when distributing the flow among the edges in  $\delta_v^+(\theta)$ . In the following, we describe how to define the flow-split in order to maintain the invariant that flow is only assigned to edges that are active for at least some interval even if adjacent labels vary linearly over time.

Assume that  $b_v^-(\theta)$  is constant for  $\theta \in [\theta_k, \theta_k + \varepsilon)$  for a node  $v \in V$  and some  $\varepsilon > 0$ . Moreover, let  $\delta_v^+(\theta_k) = \{vw_1, vw_2, \dots, vw_{p_k}\}$  for some  $p_k \geq 1$  and  $[p_k] := \{1, \dots, p_k\}$ . Thus, we have

$$\ell_v(\theta_k) = c_{vw_i}(\theta_k) + \ell_{w_i}(\theta_k) \quad \text{for all } i \in [p_k]. \quad (12)$$

Suppose that the labels of nodes  $w_i$  change linearly after  $\theta_k$ , that is, there are constants  $a_{w_i} \in \mathbb{R}$  for  $i \in [p_k]$  with

$$\ell_{w_i}(\theta) = \ell_{w_i}(\theta_k) + a_{w_i}(\theta - \theta_k) \quad \text{for all } \theta \in [\theta_k, \theta_k + \varepsilon).$$

Our goal is to find constant edge inflow rates  $f_{vw_i}^+(\theta)$  during  $[\theta_k, \theta_k + \varepsilon)$  satisfying the supply  $b_v^-(\theta)$  and, for some  $\varepsilon' > 0$ , fulfilling the following invariant for all  $i \in [p_k]$  and  $\theta \in [\theta_k, \theta_k + \varepsilon')$ :

$$f_{vw_i}^+(\theta) > 0 \quad \Rightarrow \quad \ell_v(\theta) = c_{vw_i}(\theta) + \ell_{w_i}(\theta), \quad (13)$$

$$f_{vw_i}^+(\theta) = 0 \quad \Rightarrow \quad \ell_v(\theta) \leq c_{vw_i}(\theta) + \ell_{w_i}(\theta). \quad (14)$$

Note that a constant inflow rate  $f_{vw_i}^+$  implies by (5) that the queue length  $q_{vw_i}$  is piecewise linear. Hence, the instantaneous travel time  $c_{vw_i}$  is also piecewise linear on  $[\theta_k, \theta_k + \varepsilon')$  for some  $\varepsilon' > 0$ , with derivative

$$c'_{vw_i}(\theta) = \frac{q'_{vw_i}(\theta)}{\nu_{vw_i}}.$$

Since all edges  $vw_i$  are active at time  $\theta_k$ , we have  $\ell_v(\theta_k) = c_{vw_i}(\theta_k) + \ell_{w_i}(\theta_k)$  and, thus, a flow with constant inflow rates satisfies (13) and (14) for all  $\theta \in [\theta_k, \theta_k + \varepsilon')$ , if

$$f_{vw_i}^+(\theta_k) > 0 \quad \Rightarrow \quad \ell'_v(\theta_k) = c'_{vw_i}(\theta_k) + \ell'_{w_i}(\theta_k) \quad (15)$$

$$f_{vw_i}^+(\theta_k) = 0 \quad \Rightarrow \quad \ell'_v(\theta_k) \leq c'_{vw_i}(\theta_k) + \ell'_{w_i}(\theta_k). \quad (16)$$

This condition ensures that whenever an edge  $vw_i$  has positive inflow, the remaining distance towards  $t$  grows from  $\theta_k$  onwards at the lowest speed.

For a given value  $b_v^-(\theta_k)$  and given vector  $(a_{w_i})_{i \in [p_k]}$  we consider the following optimization problem in variables  $x_{vw_i}$  for  $i \in [p_k]$  in order to obtain inflow rates that satisfy the conditions (15) and (16).

$$\begin{aligned} \min \quad & \sum_{i=1}^{p_k} \int_0^{x_{vw_i}} \frac{g_{vw_i}(z)}{\nu_{vw_i}} + a_{w_i} dz && (\text{OPT-}b_v^-(\theta_k)) \\ \text{s.t.} \quad & \sum_{i=1}^{p_k} x_{vw_i} = b_v^-(\theta_k) && (17) \\ & x_{vw_i} \geq 0 \text{ for all } i \in [p_k]. \end{aligned}$$

Each function  $g_{vw_i}$  maps an edge inflow rate  $z$  to the change of the queue size if a constant flow with rate  $z$  would enter the edge  $vw_i$ , i.e.,

$$g_{vw_i}(z) := \begin{cases} z - \nu_{vw_i} & \text{if } q_{vw_i}(\theta_k) > 0, \\ \max\{z - \nu_{vw_i}, 0\} & \text{if } q_{vw_i}(\theta_k) = 0. \end{cases} \quad (18)$$

Hence,  $g_{vw_i}(f_{vw_i}^+(\theta_k))$  is the derivative of  $q_{vw_i}$  at  $\theta_k$  (cf. Equation (5)).

**Lemma 3.1.** *There exists an optimal solution  $(x_{vw_i})_{i \in [p_k]}$  to (OPT- $b_v^-(\theta_k)$ ) and for every optimal solution  $f_{vw_i}^+(\theta_k) := x_{vw_i}$  satisfies (15) and (16) for all  $i \in [p_k]$ .*

*Proof.* The objective function is continuous and the feasible region is non-empty and compact. Hence, by the theorem of Weierstraß at least one optimal solution exists. Moreover, the objective is differentiable over the feasible domain, thus, first order optimality conditions hold. Assigning a multiplier  $\lambda \in \mathbb{R}$  to (17) and taking partial derivatives of the Lagrangian over the positive orthant, we obtain

$$x_{vw_i} > 0 \quad \Rightarrow \quad \frac{g_{vw_i}(x_{vw_i})}{\nu_{vw_i}} + a_{w_i} + \lambda = 0 \quad (19)$$

$$x_{vw_i} = 0 \quad \Rightarrow \quad \frac{g_{vw_i}(x_{vw_i})}{\nu_{vw_i}} + a_{w_i} + \lambda \geq 0. \quad (20)$$

These conditions imply (15) and (16) with  $\ell'_v(\theta_k) := -\lambda$ . □

**Lemma 3.2.** *Let  $f = (f^+, f^-)$  be an IDE flow up to time  $\theta_k \geq 0$  and suppose there are constant inflow rate functions  $b_v^- : [\theta_k, \theta_k + \varepsilon) \rightarrow \mathbb{R}_{\geq 0}$  for some  $\varepsilon > 0$  and all nodes  $v \in V$  (in particular, this means  $\varepsilon \leq \min\{\tau_e \mid e \in E\}$ ). Then, there exists some  $\varepsilon' > 0$  such that  $f$  can be extended to an IDE flow up to time  $\theta_k + \varepsilon'$  with all functions  $f_e^+$  constant on the interval  $[\theta_k, \theta_k + \varepsilon')$  and all functions  $f_e^-$  right-constant on the intervals  $[\theta_k + \tau_e, \theta_k + \tau_e + \varepsilon')$ .*

*Proof.* First, it is possible to determine the queue lengths at time  $\theta_k$  using Constraint (1) and from those the labels  $\ell_v(\theta_k)$  can be obtained. Applying Lemma 3.1 on the nodes in order of increasing  $\ell_v(\theta_k)$  values, we obtain the outflow rates and, therefore, the slope  $a_v$  of label  $\ell_v$  for some interval right after  $\theta_k$ . More precisely, we start with  $t$  (since

$\ell_t(\theta_k) = 0$ ) for which we can define  $f_e^+(\theta) = f_e^-(\theta + \tau_e) = 0$  for all outgoing edges  $e \in \delta_t^+$  and all times  $\theta \in [\theta_k, \theta_k + \varepsilon')$ , where  $\varepsilon' := \varepsilon$ . Now we take some node  $v$  such that there exists an  $\varepsilon' > 0$  and for all nodes  $w$  with strictly smaller label at time  $\theta_k$  and all edges  $e \in \delta_w^+$ , we have already defined  $f_e^+$  on some interval  $[\theta_k, \theta_k + \varepsilon')$  and  $f_e^-$  on some interval  $[\theta_k + \tau_e, \theta_k + \tau_e + \varepsilon')$  in such a way that on the interval  $[\theta_k, \theta_k + \varepsilon')$

1. the labels  $\ell_w(\theta)$  change linearly with slope  $a_w$ ,
2. no additional edges are added to the sets  $\delta_w^+(\theta)$  of active edges leaving  $w$ ,
3. the functions  $f_e^+$  and  $f_e^-$  for  $e \in \delta_w^+$  are constant and right-constant, respectively, and
4. the functions  $f_e^+$  and  $f_e^-$  for  $e \in \delta_w^+$  satisfy Constraints (2), (4) and (10).

Let  $\delta_v^+(\theta_k) := \{vw_1, vw_2, \dots, vw_{p_k}\}$  be the set of active edges at  $v$  at time  $\theta_k$ . Then, at time  $\theta_k$ , each  $w_i$  must have a strictly smaller label than  $v$ . Hence, they satisfy Properties 1.-4. We can now apply Lemma 3.1 to determine the flows  $f_{vw_i}^+(\theta_k)$ . Additionally, we set  $f_e^+(\theta_k) = 0$  for all non-active edges leaving  $v$ . Assuming that this flow remains constant on the whole interval  $[\theta_k, \theta_k + \varepsilon')$ , we can determine the first time  $\hat{\theta} \geq \theta_k$ , where an additional edge  $vw \in \delta_v^+$  or  $wv \in \delta_w^+$  becomes newly active. This can only happen after some positive amount of time has passed, i.e., for some  $\hat{\theta} > \theta_k$ , because

- at time  $\theta_k$  the edge was non-active, and therefore  $\ell_v(\theta_k) > c_{vw}(\theta_k) + \ell_w(\theta_k)$  or  $\ell_w(\theta_k) > c_{wv}(\theta_k) + \ell_v(\theta_k)$ , respectively,
- all labels change linearly (and thus continuously) and
- $c_{vw}$  or  $c_{wv}$  is changing piecewise linearly, since the length of its queue does so as well (as both  $f_{vw}^+$  and  $f_{wv}^-$  are piecewise constant).

If the difference  $\hat{\theta} - \theta_k$  is smaller than the current  $\varepsilon'$ , we take it as our new  $\varepsilon'$ , otherwise we keep it as it is. In both cases, we extend  $f_e^+$  onto the interval  $[\theta_k, \theta_k + \varepsilon')$  for all  $e \in \delta_v^+$  by setting  $f_e^+(\theta) = f_e^+(\theta_k)$  for all  $\theta \in [\theta_k, \theta_k + \varepsilon')$ . This guarantees that the label of  $v$  changes linearly on this interval, no additional edges become active and the functions  $f_e^+$  are constant. Also,  $f_e^+$  satisfies Constraints (2) and (10) by definition. Finally, we define  $f_e^-$  as follows:

$$f_e^-(\theta + \tau_e) := \begin{cases} \nu_e, & \text{if } q_e(\theta_k) + (\theta - \theta_k)(f_e^+(\theta_k) - \nu_e) > 0, \\ f_e^+(\theta), & \text{else.} \end{cases}$$

Then,  $f_e^-$  is right-constant and together with  $f_e^+$  satisfies Constraint (4). In summary, using this procedure we can extend  $f$  node by node to an IDE flow up to  $\theta_k + \varepsilon'$  for some  $\varepsilon' > 0$ .  $\square$

**Theorem 3.3.** *For any multi-source single-sink network with right-constant network inflow rate functions, there exists an IDE flow  $f$  with right-constant functions  $f_e^+$  and  $f_e^-$ ,  $e \in E$ .*

*Proof.* Let  $\mathfrak{F}_0$  be the set of tuples  $(f, \theta)$ , with  $\theta \in \mathbb{R}_{\geq 0} \cup \{\infty\}$  and  $f$  an IDE flow up to time  $\theta$  with right-constant functions  $f_e^+$  and  $f_e^-$ . Define  $\hat{\theta}_0 := \sup \{ \theta \mid \exists f \text{ s.t. } (\theta, f) \in \mathfrak{F}_0 \}$ . If  $\hat{\theta}_0 = \infty$  we are done, so suppose  $\hat{\theta}_0 < \infty$ . There exists an IDE flow  $f_1$  with  $\theta_1 := \hat{\theta}_0/2$  such that  $(\theta_1, f_1) \in \mathfrak{F}_0$ . Now we define

$$\mathfrak{F}_1 := \{ (f, \theta) \in \mathfrak{F}_0 \mid f|_{[0, \theta_1)} = f_1 \}.$$

This set is not empty so we set  $\hat{\theta}_1 := \sup \{ \theta \mid \exists f \text{ s.t. } (\theta, f) \in \mathfrak{F}_1 \}$ . By Lemma 3.2 we know that  $\hat{\theta}_1 > \theta_0$ , and therefore  $\hat{\theta}_1 \in (\theta_0, \hat{\theta}_0]$ . Let  $\theta_2 := (\hat{\theta}_1 - \theta_1)/2$ . Going on we get a strict monotone increasing sequence  $(\theta_i)_{i \in \mathbb{N}}$  and a non-increasing sequence  $(\hat{\theta}_i)_{i \in \mathbb{N}}$  with  $\theta_i < \hat{\theta}_i$  for all  $i \in \mathbb{N}$  and  $\hat{\theta}_i - \theta_i \leq \hat{\theta}_0/2^i \rightarrow 0$  for  $i \rightarrow \infty$ . Let  $\theta^*$  be the limit of these two sequences. By taking pointwise limits of the sequence  $(f_i)_{i \in \mathbb{N}}$  we can construct a flow  $f^*$  such that  $(f^*, \theta^*) \in \mathfrak{F}_0$ . By Lemma 3.2 we can extend  $f^*$  by some  $\varepsilon$  but this is a contradiction to the definition of  $\hat{\theta}_i$  for all  $i$  with  $\hat{\theta}_i \in [\theta^*, \theta^* + \varepsilon)$ . Hence,  $\hat{\theta}_0 = \infty$ , which finishes the proof.  $\square$

*Remark 3.4.* While there always exists an IDE flow, this flow does not have to be unique. In fact, neither the flow  $f$  itself nor the label functions  $\ell_v$  and the time of termination need to be unique. This is in contrast to dynamic equilibria, where at least the label functions are uniquely determined (see Cominetti et al. [4, Theorem 6]). An example for non-uniqueness is illustrated by the instance in Figure 3.

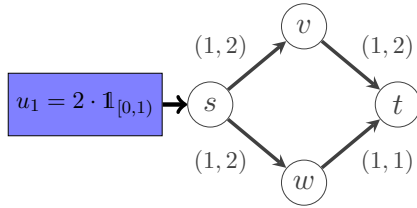

Figure 3: *An example of a graph with infinitely many distinct flows in IDE (all with different label functions and termination times). Two such flows are: All flow uses the above path or all flow uses the bottom path. Since the first edge on both paths has rate capacity 2, no queues will form on those edges. So both edges will lie on a shortest path as long as the flow has not arrived at node  $w$ .*

*Remark 3.5.* The task to find suitable inflow rates  $x_e$  at a given time  $\theta_k$  can also be formulated globally as follows: Find two vectors  $(x_e)_{e \in E_{\theta_k}}, (a_v)_{v \in V}$  such that:

$$\begin{aligned} \sum_{vw \in E_{\theta_k}} x_e &= b_v^-(\theta_k) && \text{for all } v \in V, \\ x_e &\geq 0 && \text{for all } e \in E_{\theta_k}, \\ a_t &= 0, \\ a_v &= \min_{e=vw \in E_{\theta_k}} \frac{g_e(x_e)}{\nu_e} + a_w && \text{for all } v \in V \setminus \{t\}, \\ a_v &= \frac{g_e(x_e)}{\nu_e} + a_w && \text{for all } e = vw \in E_{\theta_k} \text{ with } x_e > 0, \end{aligned}$$

where

$$g_e(x_e) := \begin{cases} x_e - \nu_e & \text{if } q_e(\theta_k) > 0 \\ \max \{ x_e - \nu_e, 0 \} & \text{if } q_e(\theta_k) = 0. \end{cases}$$

This formulation is very similar to the *thin flow with resetting* formulation of dynamic equilibria (see [12], [4]) and in the same way the existence of a solution can be shown via Kakutani's fixed point theorem. Yet, Kakutani's fixed point theorem is non constructive while our approach allows for direct computation of an IDE extension as shown below.

We have proven now that an IDE flow always exists, but in order to actually compute an IDE flow we need to make Lemma 3.1 constructive, i.e. provide an algorithm to find an optimal solution to (OPT- $b_v^-(\theta_k)$ ) or, equivalently, a distribution of the inflow  $b_v^-(\theta_k)$  satisfying Constraints (15) and (16). This can be accomplished by a simple water filling procedure:

First, note that we have

$$c'_{vw_i}(\theta_k) + \ell'_{w_i}(\theta_k) = \begin{cases} \frac{f_{vw_i}^+(\theta_k) - \nu_{vw_i}}{\nu_{vw_i}} + a_{w_i}, & \text{if } q_{vw_i}(\theta_k) > 0 \\ \frac{\max\{f_{vw_i}^+(\theta_k) - \nu_{vw_i}, 0\}}{\nu_{vw_i}} + a_{w_i}, & \text{if } q_{vw_i}(\theta_k) = 0 \end{cases}$$

and thus, setting

$$\beta_i := \begin{cases} a_{w_i} - 1, & q_{vw_i}(\theta_k) > 0 \\ a_{w_i}, & q_{vw_i}(\theta_k) = 0, \end{cases} \quad \gamma_i := \begin{cases} 0, & q_{vw_i}(\theta_k) > 0 \\ \nu_{vw_i}, & q_{vw_i}(\theta_k) = 0, \end{cases} \quad \alpha_i := \nu_{vw_i} \text{ and}$$

$$h_{vw_i}(z) := \begin{cases} \beta_i, & z \leq \gamma_i \\ \beta_i + \frac{1}{\alpha_i}(z - \gamma_i), & z \geq \gamma_i, \end{cases} \quad (21)$$

we obtain  $h_{vw_i}(f_{vw_i}^+(\theta_k)) = c'_{vw_i}(\theta_k) + \ell'_{w_i}(\theta_k)$ . Without loss of generality we assume that the nodes  $w_i$  are sorted such that  $\beta_1 \leq \beta_2 \leq \dots \leq \beta_{p_k}$ . Then, Algorithm 1 computes a distribution  $b_v^-(\theta_k) = \sum_{i=1}^{p_k} f_{vw_i}(\theta_k)$  satisfying Constraints (15) and (16).

---

**Algorithm 1:** Water filling procedure for flow distribution

---

**Input :** A number  $b_v^-(\theta_k) \geq 0$  and functions  $h_i : \mathbb{R}_{\geq 0} \rightarrow \mathbb{R}_{\geq 0}$  of the form (21) with  $\alpha_i > 0$  for  $i = 1, \dots, p_k$  and  $\beta_1 \leq \beta_2 \leq \dots \leq \beta_{p_k}$ .

**Output:** Values  $z_i \geq 0$  such that  $\sum_{i=1}^{p_k} z_i = b_v^-(\theta_k)$  and for some  $r' \leq p_k$  satisfying  $h_0(z_0) = \dots = h_{r'}(z_{r'}) \leq \beta_{r'+1}$ ,  $z_i > 0$  for  $i \leq r'$  and  $z_i = 0$  for  $i > r'$ .

---

- 1 Find the maximal  $r \in \{0, 1, \dots, p_k\}$  with  $\sum_{i=1}^r \max \{z \mid h_i(z) \leq \beta_r\} \leq b_v^-(\theta_k)$
  - 2 **if**  $r < p_k$  and  $\sum_{i=1}^r \max \{z \mid h_i(z) \leq \beta_{r+1}\} \leq b_v^-(\theta_k)$  **then**
    - 3 Set  $z_i \leftarrow \begin{cases} \max \{z \mid h_i(z) \leq \beta_{r+1}\}, & i \leq r \\ b_v^-(\theta_k) - \sum_{i < r} z_i, & i = r+1 \\ 0 & i > r+1 \end{cases}$
  - 4 **else**
    - 5 Set  $z_i \leftarrow \begin{cases} \max \{z \mid h_i(z) \leq \beta_r\}, & i \leq r \\ 0 & i > r \end{cases}$  and  $b' \leftarrow b_v^-(\theta_k) - \sum_{i=1}^k z_i$
    - 6 Set  $z_i \leftarrow z_i + \frac{\alpha_i}{\sum_{j=1}^{r-1} \alpha_j} b'$  for all  $i \leq r$ .
  - 7 **return**  $z_1, \dots, z_{p_k}$
- 

**Lemma 3.6.** Algorithm 1 computes in  $\mathcal{O}(|E|^2)$  edge inflow rates  $z_i$  such that by setting  $f_{vw_i}^+(\theta_k) := z_i$  we get a flow distribution satisfying  $\sum_{i \in [p_k]} f_{vw_i}^+(\theta_k) = b_v^-(\theta_k)$  as well as Constraints (15) and (16).

*Proof.* First, note that the functions  $h_i$  are non-decreasing, continuous and unbounded on  $\mathbb{R}_{\geq 0}$ . Thus, all maxima in Algorithm 1 are well defined. Since the functions are even piecewise linear, all these maxima can actually be determined in constant time.

It remains to show that the returned  $z_i$  do indeed satisfy  $\sum_{i=1}^{p_k} z_i = b_v^-(\theta_k)$  and for some  $r' \leq p_k$ , we have  $h_0(z_0) = h_1(z_1) = \dots = h_{r'}(z_{r'}) \leq \beta_{r'+1}$  and  $z_i = 0$  for all  $i > r'$ , which is a straight forward calculation:

**Case 1:  $z_i$  are defined in line 3:** It is clear that the solution satisfies  $\sum_{i \in [p_k]} z_i(\theta_k) = b_v^-(\theta_k)$  as well as  $h_i(z_i) = \beta_{r+1}$  for all  $i \leq r$  and  $z_i = 0$  for all  $i > r+1 =: r'$ . From  $\sum_{i=1}^r \max \{z \mid h_i(z) \leq \beta_{r+1}\} \leq b_v^-(\theta_k)$  we get  $b_v^-(\theta_k) - \sum_{i < r} z_i \geq 0$ . Since we also have  $r < p_k$  the maximality of  $r$  ensures  $\sum_{i=1}^{r+1} \max \{z \mid h_i(z) \leq \beta_{r+1}\} > b_v^-(\theta_k)$  and therefore  $z_{r+1} < \max \{z \mid h_{r+1}(z) \leq \beta_{r+1}\} = \gamma_{r+1}$ , which gives us  $h_{r+1}(z_{r+1}) = \beta_{r+1}$ .

**Case 2:  $z_i$  are defined in lines 5 and 6:** After line 5 we have  $z_i \geq \gamma_i$  and  $h_i(z_i) = \beta_r$  for all  $i \leq r =: r'$  and  $b' \geq 0$  (since  $\sum_{i=1}^r \max \{z \mid h_i(z) \leq \beta_r\} \leq b_v^-(\theta_k)$ ). So, after line 6 we have  $h_i(z_i) = \beta_r + \frac{1}{\alpha_i} \cdot \frac{\alpha_i}{\sum_{j=1}^{r-1} \alpha_j} b' = \beta_r + \frac{b'}{\sum_{j=1}^{r-1} \alpha_j}$  for all those  $i$  and  $z_i = 0$  for all others. Finally  $\sum_{i=1}^r z_i = b_v^-(\theta_k)$  and  $\sum_{i=1}^r \max \{z \mid h_i(z) > \beta_{r+1}\} \leq b_v^-(\theta_k)$  ensure  $h_i(z_i) \leq \beta_{r+1}$ .

Now setting  $f_{vw_i(\theta_k)} := z_i$  we have  $\sum_{i=1}^{p_k} f_{vw_i(\theta_k)} = \sum_{i=1}^{p_k} z_i = b_v^i(\theta_k)$  as well as

$$\begin{aligned} f_{vw_i(\theta_k)} > 0 &\implies i \leq r' \implies c'_{vw_i}(\theta_k) + \ell'_{w_i}(\theta_k) = h_i(z_i) = h_0(z_0) = c'_{vw_0}(\theta_k) + \ell'_{w_0}(\theta_k) \\ f_{vw_i(\theta_k)} = 0 &\implies i > r' \implies c'_{vw_i}(\theta_k) + \ell'_{w_i}(\theta_k) = \beta_i \geq \beta_{r'+1} \geq c'_{vw_0}(\theta_k) + \ell'_{w_0}(\theta_k). \end{aligned}$$

Thus, Constraints (15) and (16) are indeed satisfied (with  $\ell'_v(\theta_k) = c'_{vw_0}(\theta_k) + \ell'_{w_0}(\theta_k)$ ).  $\square$

Thus, we can indeed compute an IDE flow for single-sink networks with right constant network inflow rates, provided that

1. the IDE flow eventually terminates and
2. the  $\varepsilon$  in Lemma 3.2 does not become arbitrarily small (and therefore no limit process is needed in Theorem 3.3).

While the general validity of the second assumption currently remains an open question, we will show in the following Section that the first assumption holds for all IDE flows in single-sink networks. We now give an example for the computation of an IDE:

**Example 3.7.** We use the same graph as in the example in Section 1.1, but with different rate capacities and only a single commodity with source node  $s$ , sink node  $t$  and a constant network inflow rate of 16 over the interval  $[0, 1]$  (see the top left picture in Figure 5).

At time  $\theta_0 = 0$ , we have  $b_v^-(0) = b_w^-(0) = b_t^-(0) = 0$  and  $b_s^-(0) = 16$ , so we only need to distribute outflow at node  $s$ . Both edges  $st$  and  $sv$  are active at time  $\theta_0$  and we have  $a_t = a_v = 0$ , thus, the functions  $h_{st}$  and  $h_{sv}$  are of the form displayed in Figure 4. Algorithm 1 then gives us the edge inflow rates  $f_{st}^+(0) = 1 + \frac{1}{1+7} \cdot 8 = 1 + 1$  and

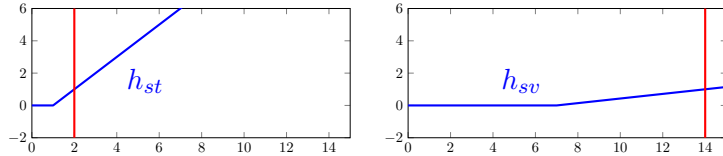

Figure 4: The functions  $h_{st}$  and  $h_{sv}$  at time  $\theta_0 = 0$ . The vertical red line indicates the  $z_i$  values determined by Algorithm 1.

$f_{sv}^+(0) = 7 + 7$ . This ensures that both edges remain active up to time  $\theta_1 = 1$ , where the inflow into node  $s$  stops and the first flow particles arrive at node  $v$ . Then, the only node with positive  $b_v^-$  is  $v$ , but since  $v$  has only one edge leaving this node, no flow distribution is necessary. At time  $\theta_2 = 2$ , the flow arriving at node  $w$  only has one active edge, and therefore enters the edge towards  $t$  at a rate of 7. At time  $\theta_3 = 2.5$ , the edge  $ws$  becomes active and the outflow from node  $w$  (at rate 7) needs to be redistributed. Algorithm 1 gives us the inflow rates  $f_{wt}^+(2.5) = 1$  and  $f_{ws}^+(2.5) = 6$ . From time  $\theta_4 = 3.5$  onward, flow arrives at node  $s$  at rate 6 and at node  $w$  at rate 7. Since  $s$  is currently closer to  $t$  than  $w$  ( $\ell_s(3.5) = 3 < 4 = \ell_w(3.5)$ ), we start by distributing the outflow of  $s$ . From  $s$  only the

edge towards  $t$  is active, so all flow enters this edge. This means that a queue will start to build up on the edge  $st$  at a rate of 5, and therefore  $a_s = 5$ . Thus, Algorithm 1 gives us the inflow rates  $f_{wt}^+(3.5) = 6$  and  $f_{ws}^+(3.5) = 1$ . At time  $\theta_5 = 4$ , the only active edge for the flow arriving at node  $s$  is  $st$ . At time  $\theta_6 = 4.5$ , the edge  $sv$  becomes active, too. Thus, we need to compute a new distribution for the flow arriving at node  $s$  (at rate 1). Since we have no outflow from node  $w$ , the queue on edge  $wt$  decreases at a rate of 1 leading to  $a_w = -1$ , and therefore  $a_v = -1$ . Algorithm 1 then gives us the inflow rates  $f_{st}^+(4.5) = 0$  and  $f_{sv}^+(4.5) = 1$ . From time  $\theta_7 = 5$  on only the physically shortest paths are active, so all flow particles will stay on their currently chosen path towards  $t$ . The IDE flow computed by this procedure is displayed in Figure 5.

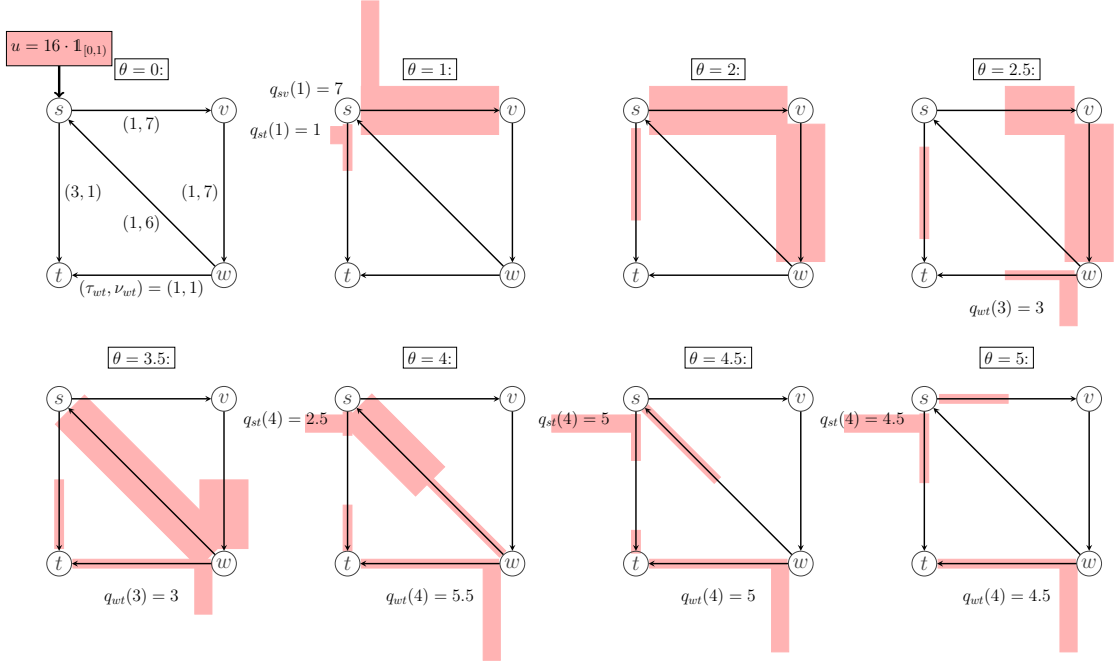

Figure 5: The evolution of the computed IDE over the time horizon  $[0, 5]$ .

*Remark 3.8.* Note that at time  $\theta_4 = 3.5$  it is vital to consider  $s$  before  $w$ . Otherwise we would continue the flow split at node  $w$  from time  $\theta_3 = 3$  leading to the edge  $vs$  becoming inactive immediately after  $\theta = 3.5$  (i.e. we could not extend our IDE flow for any  $\varepsilon > 0$  in that way). At time  $\theta_6 = 4.5$ , before distributing the flow arriving at  $s$ , both  $s$ - $t$  paths (the direct one and the one over  $v$  and  $w$ ) might seem to be completely equivalent as both have a physical path length of 3 and one queue of current length 5 decreasing at a rate of 1. However, we may, in fact, not send any flow into the edge  $st$  as this would slow down the decrease of its queues length, making this edge immediately inactive, while sending flow towards  $v$  does not change the decrease rate of the queue on edge  $wt$ . Our algorithm does indeed send all flow into the edge  $sv$ . After time  $\theta_6 = 4.5$ , the flow particles on edge  $sv$  are traversing this edge for the second time, i.e., they have completed a cycle.



## 4 Termination of IDE Flows in Single-Sink Networks

In this section, we investigate the question, whether an IDE flow vanishes within finite time given finitely lasting network inflow rates. More precisely, given a time  $\theta_0$ , such that  $\text{supp}(u_i) \subseteq [0, \theta_0]$  for every  $i \in I$ , we want to find a time  $\hat{\theta} \geq \theta_0$ , such that all injected flow actually reaches the sink within time  $\hat{\theta}$ . To answer this question, we first need to introduce some additional notation. For every edge  $e \in E$ , we define a function  $F_e^\Delta$  denoting the total amount of flow currently on edge  $e$  (either waiting in its queue or traveling along the edge) for any time  $\theta$ . As in [19], we call these the *edge load functions*:

$$F_e^\Delta : \mathbb{R}_{\geq 0} \rightarrow \mathbb{R}_{\geq 0}, \quad \theta \mapsto F_e^+(\theta) - F_e^-(\theta).$$

The function  $F^\Delta(\theta) := \sum_{e \in E} F_e^\Delta(\theta)$  specifies the *total amount of flow in the network at time  $\theta$* . Furthermore, we define a function  $Z$  indicating the amount of flow that already reached the sink  $t$  by time  $\theta$ :

$$Z : \mathbb{R}_{\geq 0} \rightarrow \mathbb{R}_{\geq 0}, \quad \theta \mapsto \sum_{e \in \delta_t^-} F_e^-(\theta) - \sum_{e \in \delta_t^+} F_e^+(\theta).$$

Note that for IDE flows the subtrahend is always 0 since edges leaving  $t$  are never active.

For every subset  $W \subseteq V$  and any time  $\theta$  a direct computation shows that we have

$$\sum_{e \in E(W)} F_e^\Delta(\theta) = \sum_{e \in \delta_W^-} F_e^-(\theta) + \sum_{i \in I: s_i \in W} U_i(\theta) - \sum_{e \in \delta_W^+} F_e^+(\theta) - \begin{cases} Z(\theta), & t \in W \\ 0, & \text{else} \end{cases}, \quad (22)$$

with  $\delta_W^+ := \{vw \in E \mid w \in W, v \notin W\}$  and  $\delta_W^- := \{vw \in E \mid v \notin W, w \in W\}$ . In particular taking  $W = V$  we get

$$F^\Delta(\theta) = \sum_{i \in I} U_i(\theta) - Z(\theta). \quad (23)$$

Since  $Z'(\theta) = \sum_{e \in \delta_t^-} f_e^-(\theta) - \sum_{e \in \delta_t^+} f_e^+(\theta)$  is always non-negative by Constraint (3), it follows immediately that the total amount of flow in the network is non-increasing after time  $\theta_0$ . More general, since all  $F_e^+$  are non-decreasing, for all  $W \subseteq V$  with  $\delta_W^- = \emptyset$  we have

$$\sum_{e \in E(W)} F_e^\Delta(\theta_2) \leq \sum_{e \in E(W)} F_e^\Delta(\theta_1) \quad \text{for all } \theta_2 \geq \theta_1 \geq \theta_0. \quad (24)$$

In particular, for  $\hat{\theta} \geq \theta_0$  with  $F^\Delta(\hat{\theta}) = 0$ , we have  $F^\Delta(\theta) = 0$  for all  $\theta \geq \hat{\theta}$ .

**Definition 4.1.** We say a flow over time  $f$  *terminates*, if there exists a time  $\hat{\theta} \geq \theta_0$  with  $F^\Delta(\hat{\theta}) = 0$ , i.e., the network is empty at time  $\hat{\theta}$  (and remains empty for all later times).

Before we turn to the main termination result, we need a technical lemma showing that all flow on an edge eventually leaves the edge (ignoring the identities of the flow particles).

**Lemma 4.2.** *Let  $f$  be a feasible flow over time,  $\theta_1 \in \mathbb{R}_{\geq 0}$ ,  $e \in E$  and any  $\lambda \in [0, F_e^\Delta(\theta_1)]$ . Then there exists a time  $\theta_2 \geq \theta_1$  such that a flow volume of at least  $\lambda$  leaves  $e$  during the interval  $[\theta_1, \theta_2]$ , i.e.,  $F_e^-(\theta_2) - F_e^-(\theta_1) \geq \lambda$ .*

*Proof.* Suppose for contradiction that  $F_e^-(\theta) - F_e^-(\theta_1) < \lambda \leq F_e^\Delta(\theta_1)$  for all  $\theta \geq \theta_1$ . As  $F_e^+$  is non-decreasing this implies  $F_e^-(\theta + \tau_e) < F_e^+(\theta_1) \leq F_e^+(\theta)$ , from which, by Constraint (1), we get  $q_e(\theta) = F_e^+(\theta) - F_e^-(\theta + \tau_e) > 0$  for all  $\theta \geq \theta_1$ . Hence, Constraint (4) gives us  $f_e^-(\theta + \tau_e) = \nu_e$  for all  $\theta \geq \theta_0$  implying that  $F_e^-$  grows unboundedly, which is a contradiction.  $\square$

We show next that for acyclic networks every feasible flow over time terminates. This intuitive result will serve as a building block for the more general result that in a single-sink network all IDE flows terminate.

**Lemma 4.3.** *Let  $G$  be an acyclic graph and assume finitely lasting bounded inflow functions. Then, every feasible flow over time terminates.*

*Proof.* Since the graph is acyclic, we can consider a topological order  $>$  on  $V$ , i.e.,  $u > v \Leftrightarrow uv \in E$ . Without loss of generality, let  $t$  be reachable from every node, since the part of the graph that cannot reach  $t$  will never be used by any feasible flow over time and can therefore be removed. Thus,  $t$  must be the last (smallest) element in this order. We will also use the notation  $e \geq w$  to indicate that an edge  $e = uv$  lies before  $w$ , i.e.,  $u, v \geq w$ . Now, given a feasible flow over time  $f$  we can define a function  $F_{\geq w}^\Delta$  for every node  $w$  that gives us the total edge load above  $w$  at any time  $\theta$ , i.e.,  $F_{\geq w}^\Delta(\theta) = \sum_{e \geq w} F_e^\Delta(\theta)$ .

As a first step, we show that after  $\theta_0$ , if there is no flow before some node  $w$  (i.e., on edges  $e \geq w$ ), there will be no flow on any edge leaving  $w$  some time later, or, more formally:

**Claim 1.** *Let  $e = vw \in E$  and  $\theta_w \geq \theta_0$  such that we have  $F_{\geq w}^\Delta(\theta_w) = 0$ . Then, there exists a time  $\theta_{wv} \geq \theta_w$  such that for all  $\theta \geq \theta_{wv}$ , we have  $F_e^\Delta(\theta) = 0$ .*

*Proof of Claim 1.* We first show that  $F_e^+(\theta) = F_e^+(\theta_w)$  for all  $\theta \geq \theta_w$ . We define the set  $W := \{w \in V \mid w \geq w\}$ , so that we have  $vw \in \delta_W^+$ , as well as  $\delta_W^- = \emptyset$  and

$$0 \leq F_{\geq w}^\Delta(\theta) = \sum_{e \in E(W)} F_e^\Delta(\theta) \stackrel{(24)}{\leq} \sum_{e \in E(W)} F_e^\Delta(\theta_w) = F_{\geq w}^\Delta(\theta_w) = 0$$

for every  $\theta \geq \theta_w$ . For all  $\theta \geq \theta_w$  we obtain

$$\begin{aligned} 0 \leq F_e^+(\theta) - F_e^+(\theta_w) &\leq \sum_{e' \in \delta_W^+} (F_{e'}^+(\theta) - F_{e'}^+(\theta_w)) \\ &\stackrel{(22)}{=} \sum_{i \in I: s_i \in W} U_i(\theta) - F_{\geq w}^\Delta(\theta) - \sum_{i \in I: s_i \in W} U_i(\theta_w) + F_{\geq w}^\Delta(\theta_w) = 0 \end{aligned}$$

since  $F_{e'}^+$  is non-decreasing,  $t \notin W$  and  $U_i(\theta) = U_i(\theta_w)$  for all  $i \in I$ . Hence, we have  $F_e^+(\theta) = F_e^+(\theta_w)$ .

By Lemma 4.2 there exists a time  $\theta_{wv} \geq \theta_w$  with  $F_e^-(\theta_{wv}) - F_e^-(\theta_w) \geq F_e^\Delta(\theta_w)$ . Since  $F_e^-$  is non-decreasing, we also get  $F_e^-(\theta) - F_e^-(\theta_w) \geq F_e^\Delta(\theta_w)$  for any  $\theta \geq \theta_{wv}$ , and hence

$$0 \leq F_e^\Delta(\theta) = F_e^+(\theta) - F_e^-(\theta) = F_e^+(\theta_w) - F_e^-(\theta) = F_e^\Delta(\theta_w) + F_e^-(\theta_w) - F_e^-(\theta) \leq 0. \quad \blacksquare$$

**Claim 2.** For every  $v \in V$ , there exists a time  $\theta_v \geq \theta_0$  such that  $F_{\geq v}^\Delta(\theta) = 0$  for all  $\theta \geq \theta_v$ .

*Proof of Claim 2.* We show this by induction on the number of nodes greater than  $v$  in the given topological order on  $V$ . Our base case is, that there are no nodes  $w > v$ . Then there are also no edges  $e > v$ , and therefore  $F_{\geq v}^\Delta(\theta) = 0$  holds for all  $\theta \geq \theta_0$ . So, we can assume that for all  $w > v$  there are already times  $\theta_w \geq \theta_0$  with  $F_{\geq w}^\Delta(\theta) = 0$  for all  $\theta \geq \theta_w$ . Then for every edge  $wv \in E$ , Claim 1 gives us a time  $\theta_{wv} \geq \theta_w$  with  $F_e^\Delta(\theta) = 0$  for all  $\theta \geq \theta_{wv}$ . Setting  $\theta_v := \max \{ \theta_{wv} \mid wv \in \delta_v^- \}$  then guarantees for all  $\theta \geq \theta_v$  that

$$F_{\geq v}^\Delta(\theta) = \sum_{e \geq v} F_e^\Delta(\theta) \leq \sum_{wv \in E} (F_{wv}^\Delta(\theta) + F_{\geq w}^\Delta(\theta)) = 0. \quad \blacksquare$$

Finally, the lemma follows directly from Claim 2 by setting  $v = t$ , as then we have  $F^\Delta(\theta_t) = F_{\geq t}^\Delta(\theta_t) = 0$  for some  $\theta_t \geq \theta_0$ .  $\square$

In the next step we show that if the sum of all edge loads between a node  $v$  and the sink  $t$  are small enough (and, thus, in particular all queues on edges between  $v$  and  $t$  are small), then an IDE flow can not be diverted away from the physically shortest paths towards  $t$ . Since those physically shortest paths form a time independent acyclic subgraph, we will be able to apply Lemma 4.3 to the flow inside this subgraph. For the next lemma, we need the minimal non-zero difference between two path lengths  $\tau_\Delta := \min \{ \tau(P) - \tau(P') > 0 \mid u \in V, P, P' \text{ two } u\text{-}t \text{ paths} \}$  and the minimal rate capacity  $\nu_{\min} := \min \{ \nu_e \mid e \in E \}$ .

**Lemma 4.4.** If, for some node  $v \in V$  and some time  $\theta \in \mathbb{R}_{\geq 0}$ , every physical shortest  $v$ - $t$  path (i.e., w.r.t.  $\tau$ ) has total flow volume of less than  $\tau_\Delta \cdot \nu_{\min}$ , then all active  $v$ - $t$  paths at time  $\theta$  are also physical shortest  $v$ - $t$  paths, i.e., if  $\sum_{e \in P} F_e^\Delta(\theta) < \tau_\Delta \cdot \nu_{\min}$  for all physical shortest  $v$ - $t$  paths  $P$ , then the following holds:

$$P' \text{ is an active } v\text{-}t \text{ path at time } \theta \implies P' \text{ is a physical shortest } v\text{-}t \text{ path.}$$

*Proof.* Let  $P$  be a physically shortest  $v$ - $t$  path and  $P'$  an active  $v$ - $t$  path. Then we have

$$\sum_{e \in P'} \tau_e \leq \sum_{e \in P'} c_e(\theta) \leq \sum_{e \in P} c_e(\theta) = \sum_{e \in P} \tau_e + \sum_{e \in P} \frac{q_e(\theta)}{\nu_e} \leq \sum_{e \in P} \tau_e + \sum_{e \in P} \frac{F_e^\Delta(\theta)}{\nu_{\min}} < \sum_{e \in P} \tau_e + \tau_\Delta.$$

This implies  $0 \leq \sum_{e \in P'} \tau_e - \sum_{e \in P} \tau_e < \tau_\Delta$ , and therefore  $\sum_{e \in P'} \tau_e = \sum_{e \in P} \tau_e$  as  $\tau_\Delta$  is the smallest nonzero distance between two physical path lengths. Thus,  $P'$  is also a shortest path w.r.t. the physical transit times  $\tau$ .  $\square$

**Corollary 4.5.** *Let  $f$  be an IDE flow with  $F^\Delta(\hat{\theta}) < \tau_\Delta \cdot \nu_{\min}$  for some  $\hat{\theta} \geq \theta_0$ . Then,  $f$  terminates.*

*Proof.* By (24) we also have  $F^\Delta(\theta) \leq F^\Delta(\hat{\theta}) < \tau_\Delta \cdot \nu_{\min}$  for all  $\theta \geq \hat{\theta}$ . So from Lemma 4.4 we know that after  $\hat{\theta}$  only shortest paths can be active, and therefore the flow only uses a time independent acyclic subgraph of  $G$ . Thus, by Lemma 4.3 the flow terminates.  $\square$

**Theorem 4.6.** *For multi-source single-sink networks, any IDE flow  $f$  with finitely lasting bounded network inflow rates  $u_i$  terminates.*

*Proof.* Let  $W \subseteq V$  be a subset of nodes with the following properties:

1. For every  $w \in W$ , all physical shortest  $w$ - $t$  paths only use edges in  $E(W)$ .
2. There is a  $\theta_W$  such that for all  $\theta \geq \theta_W$  and  $e \in E(W)$ , we have  $F_e^\Delta(\theta) < \frac{\tau_\Delta \cdot \nu_{\min}}{|E|}$ .

We show that for every such  $W \neq V$ , there exists a node  $v \in V \setminus W$  such that  $W \cup \{v\}$  also has the two properties. Since  $W = \{t\}$  satisfies the two properties this shows that  $W = V$  exhibits those as well and, in particular, there exists some time  $\theta_V$  with  $F_e^\Delta(\theta_V) < \frac{\tau_\Delta \cdot \nu_{\min}}{|E|}$  for all edges  $e \in E$ , and therefore  $\sum_{e \in E} F_e^\Delta(\theta_V) < \tau_\Delta \cdot \nu_{\min}$ . Hence, by Corollary 4.5,  $f$  terminates.

Let  $W \subsetneq V$  be a set of nodes fulfilling both properties and  $v \in V \setminus W$  be the node with the shortest distance to  $t$  with respect to  $\tau$  of all nodes in  $V \setminus W$ . Then, all physically shortest  $v$ - $t$  paths only use edges from  $E(W \cup \{v\})$ , so the first property holds for  $W \cup \{v\}$ . Since the second property holds for  $W$  we know that for all  $\theta \geq \theta_W$ , we have

$$\sum_{e \in E(W)} q_e(\theta) \leq \sum_{e \in E(W)} F_e^\Delta(\theta) < \frac{|E(W)| \cdot \tau_\Delta \cdot \nu_{\min}}{|E|} \leq \tau_\Delta \cdot \nu_{\min}.$$

Lemma 4.4 implies that for every node  $w \in W$ , all active edges leaving  $w$  have to be in  $E(W)$ , i.e.,  $\delta_w^+ \cap E_\theta \subseteq E(W)$ . Since  $f$  is an IDE flow this implies  $f_e^+(\theta) = 0$  for all  $e \in \delta_w^+$ , and thus  $F_e^+(\theta) = F_e^+(\theta_W)$  for all those edges. We now assume by contradiction that the second property does not hold for  $W \cup \{v\}$ , so there is an edge  $e \in \delta_v^+ \cap \delta_W^-$  and a sequence of times  $\theta_1 < \theta_2 < \dots$  with  $F_e^\Delta(\theta_k) \geq \frac{\tau_\Delta \cdot \nu_{\min}}{|E|}$  for all  $k \in \mathbb{N}$  and  $\theta_k \rightarrow \infty$  for  $k \rightarrow \infty$ . From Lemma 4.2, we get times  $\theta'_k \geq \theta_k$  with  $F_e^-(\theta'_k) - F_e^-(\theta_k) \geq F_e^\Delta(\theta_k) \geq \frac{\tau_\Delta \cdot \nu_{\min}}{|E|}$ . By possibly taking a subsequence, we can assume  $\theta'_{k-1} \leq \theta_k$  for all  $k$ , and thus,

$$F_e^-(\theta'_k) \geq F_e^\Delta(\theta_k) + F_e^-(\theta_k) \geq F_e^\Delta(\theta_k) + F_e^-(\theta'_{k-1}) \geq \dots \geq \sum_{j=1}^k F_e^\Delta(\theta_j) \geq k \cdot \frac{\tau_\Delta \cdot \nu_{\min}}{|E|}.$$

Hence  $F_e^-(\theta_k)$  tends to infinity as  $k$  grows larger. On the other hand (22) states that

$$F_e^-(\theta_k) = \sum_{e' \in E(W)} F_{e'}^\Delta(\theta_k) + \sum_{e' \in \delta_W^+(\theta_k)} F_{e'}^+(\theta_k) + Z(\theta_k) - \sum_{i \in I: s_i \in W} U_i(\theta_k) - \sum_{e' \in \delta_W^-(\theta_k) \setminus \{e\}} F_{e'}^-(\theta_k)$$

which in turn is bounded from above as all positive summands are bounded as well:

- $\sum_{e' \in E(W)} F_{e'}^\Delta(\theta_k) \leq \frac{|E(W)|}{|E|}$  since  $\theta_k \geq \hat{\theta}$  and  $W$  has the second property.
- $\sum_{e' \in \delta_W^+(\theta_k)} F_{e'}^+(\theta_k) = \sum_{e' \in \delta_W^+(\hat{\theta})} F_{e'}^+(\hat{\theta})$  as shown above.
- $Z(\theta_k) \stackrel{(23)}{\leq} \sum_{i \in I} U_i(\theta_k) = \sum_{i \in I} U_i(\theta_0) < \infty$ .

This is a contradiction. So the second property must also hold for  $W \cup \{v\}$ , which concludes the proof.  $\square$

## 5 Existence of IDE Flow in Multi-Sink Networks

Next, we want to show that IDE flows exist even in multi-sink networks and with very general network inflow functions. Recall that the  $L^2$ -space is defined by

$$L^2([a, b]) := \left\{ x : [a, b] \rightarrow \mathbb{R} \mid \int_a^b x(\xi)^2 \, d\xi < \infty \right\}$$

for every time interval  $[a, b] \subseteq \mathbb{R}_{\geq 0}$ , where two function are equal if they are equal almost everywhere. Together with the scalar product  $\langle x, y \rangle = \int_a^b x(\xi) \cdot y(\xi) \, d\xi$ , it forms a Hilbert space. If we have vectors of functions  $f, g \in L^2([a, b])^d$ , for  $d \in \mathbb{N}$ , the scalar product is defined as  $\langle f, g \rangle = \sum_{i=1}^d \int_a^b f_i(\xi) \cdot g_i(\xi) \, d\xi$ . A sequence  $f^k \in L^2([a, b])^d$  converges weakly to  $f \in L^2([a, b])^d$ , if  $\langle f^k, g \rangle \rightarrow \langle f, g \rangle$  for all  $g \in L^2([a, b])^d$ . We call a mapping  $\mathcal{A}: K \subseteq L^2([a, b])^d \rightarrow L^2([a, b])^d$  weak-strong-continuous at  $f \in K$ , if for every  $f^k \in L^2([a, b])^d$  that converges weakly to  $f$ , we have that  $\mathcal{A}(f^k)$  converges to  $\mathcal{A}(f)$  with respect to the  $L^2$ -norm.

**Lemma 5.1.** *Given a network with a finite set of commodities  $I$  with arbitrary sources and sinks and bounded network inflow functions  $u_i$  such that  $u_i|_{[a, b]} \in L^2([a, b])$  for all  $a < b$  and  $i \in I$ . Let  $f$  be an IDE flow with FIFO up to time  $\phi \geq 0$ . Then, for any  $0 < \varepsilon < \min\{\tau_e \mid e \in E\}$ , we can extend  $f$  to an IDE flow with FIFO up to time  $\phi + \varepsilon$ .*

In order to prove this, we utilize the following variational inequality:

**Variational Inequality.** Given an interval  $[a, b] \subseteq \mathbb{R}_{\geq 0}$ , a number  $d \in \mathbb{N}$ , a subset  $K \subseteq L^2([a, b])^d$  and a mapping  $\mathcal{A}: K \rightarrow L^2([a, b])^d$ , then the variational inequality  $\text{VI}(K, \mathcal{A})$  is the following:

$$\text{Find } g \in K \text{ such that } \langle \mathcal{A}(g), g' - g \rangle \geq 0 \text{ for all } g' \in K. \quad (\text{VI})$$

Conditions to guarantee the existence of such an element  $g$  are given by Brézis [3, Theorem 24] (see also [21]):

**Theorem 5.2.** *Let  $K$  be a nonempty, closed, convex and bounded subset of  $L^2([a, b])^d$ . Let  $\mathcal{A} : K \rightarrow L^2([a, b])^d$  be a weak-strong-continuous mapping. Then, the variational inequality  $VI(K, \mathcal{A})$  has a solution  $g^* \in K$ .*

*Proof of Lemma 5.1.* For  $\theta \in [\phi, \phi + \varepsilon)$ , we define

$$b_{i,v}^-(\theta) := \begin{cases} u_i(\theta) + \sum_{e \in \delta_v^-} f_{i,e}^-(\theta), & \text{if } v = s_i \\ \sum_{e \in \delta_v^-} f_{i,e}^-(\theta) & \text{else,} \end{cases}$$

where  $f_{i,e}^-(\theta)$  is uniquely defined according to Constraints (4) and (7). Note that by the choice of  $\varepsilon$  these functions  $f_{i,e}^-$ , and hence  $b_{i,v}^-$ , do not depend on any inflow function during  $[\phi, \phi + \varepsilon)$ . We set  $d = |I| \cdot |E|$  and define  $K$  to be the set of all feasible flows over time with FIFO, described by the edge inflow functions only, on the given network during the interval  $[\phi, \phi + \varepsilon)$  that satisfies the inflow functions, i.e.,

$$K := \left\{ (g_{i,e})_{i \in I, e \in E} \in L^2([\phi, \phi + \varepsilon))^d \mid \begin{array}{l} g_{i,e}(\theta) \geq 0, \sum_{e \in \delta^+(v)} g_{i,e}(\theta) = b_{i,v}^-(\theta) \\ \text{for all } v \neq t_i \text{ and almost all } \theta \in \mathbb{R}_{\geq 0} \end{array} \right\}.$$

Note that  $K$  is indeed a nonempty, closed, convex and bounded subset of  $L^2([\phi, \phi + \varepsilon))^d$ . We define the following mapping  $\mathcal{A} : K \rightarrow L^2([\phi, \phi + \varepsilon))^d$  that maps

$$g = (g_{i,e})_{i \in I, e \in E} \mapsto (h_{i,e})_{i \in I, e \in E} \quad \text{with} \quad h_{i,e}(\theta) := \tau_e + \frac{q_e(\theta)}{\nu_e} + \ell_{i,v}(\theta) - \ell_{i,u}(\theta).$$

Here  $e = uv$ ,  $\ell_{i,v}(\theta)$  and  $\ell_{i,u}(\theta)$  are the current shortest paths distances from  $v$  ( $u$ , respectively) to  $t_i$  at time  $\theta$  and  $q_e(\theta)$  is the queue length at edge  $e$  at time  $\theta$  all considering the feasible flow over time  $f$  extended by  $g$ .

This mapping  $\mathcal{A}$  is indeed weak-strong-continuous. As shown by Cominetti et al. [4, Lemma 4] the mapping  $(g_{i,e})_{i \in I, e \in E} \mapsto (q_e)_{e \in E}$  is weak-strong-continuous and, since  $(q_e)_{e \in E} \mapsto (\ell_{i,v})_{i \in I, v \in V}$  is (strong-strong)-continuous, it follows immediately that  $\mathcal{A}$  is weak-strong-continuous. Applying Theorem 5.2 provides a solution  $g^*$  for  $VI(K, \mathcal{A})$ .

We have to show that  $f$  extended by  $g^*$  is a feasible multi-commodity IDE flow. By the definition of  $b_{i,v}^-$  the flow conservation is satisfied. Suppose that constraint (10) does not hold for almost all  $\theta \in [\phi, \phi + \varepsilon)$ . Then there is an edge  $e$ , a commodity  $i$ , and a set of times  $\Theta \subseteq [\phi, \phi + \varepsilon)$  of positive measure, such that  $g_{e,i}^*(\theta) > 0$  and  $e \notin E_\theta^i$  for all  $\theta \in \Theta$ . It follows that  $h_{e,i}^*(\theta) > 0$  for all  $\theta \in \Theta$ . Since all functions of  $g^*$  and  $h^*$  are non-negative we have:

$$\langle \mathcal{A}(g^*), g^* \rangle \geq \int_{\Theta} h_{e,i}^*(\theta) \cdot g_{e,i}^*(\theta) \, d\theta > 0.$$

We define a new flow  $g'$  that fulfills  $\langle \mathcal{A}(g^*), g' \rangle = 0$ . Note that for any flow, and especially for  $g^*$  we have the following property: For every node  $v$ , every commodity  $i$  and every

time  $\theta$  there exists an outgoing edge  $e \in \delta_v^+$  that is active, i.e.,  $e \in E_\theta^i$ . This follows immediately from the fact, that  $E_\theta^i$  connects every node  $v$  with  $t_i$ . Furthermore, the sets  $\Theta_{i,e} := \{\theta \in [\phi, \phi + \varepsilon) \mid e \in E_\theta^i\}$  are, by their definition and the continuity of the label functions  $\ell_{i,v}$ , a union of closed intervals, and therefore measurable.

We now define  $g' \in K$  as follows. At every node  $v$ , for every commodity  $i$  and at every point in time  $\theta$ , we send all arriving flow at  $v$  of commodity  $i$  into an edge  $e \in E_\theta^i$ , where  $E_\theta^i$  are the active edges according to  $g^*$ . It is easy to check that we have  $\langle \mathcal{A}(g^*), g' \rangle = 0$ . Combining these we get

$$\langle h^*, g' - g^* \rangle = \langle h^*, g' \rangle - \langle h^*, g^* \rangle < 0,$$

which is a contradiction to (VI). To show that constraint (10) is fulfilled for every  $\theta$ , recall that set  $\Theta_0$  of the points in time where this is not satisfied has measure zero. It is possible to modify the edge inflow rates at every  $\theta \in \Theta_0$ , such that flow conservation and (10) is fulfilled by sending all flow into edges in  $E_\theta^i$ . This has no impact on the queues or the shortest path distances.  $\square$

**Theorem 5.3.** *Consider a multi-source multi-sink network with a finite set of commodities  $I$  and bounded network inflow functions  $u_i$  with  $u_i|_{[a,b)} \in L^2([a,b))$  for all  $a < b$  and  $i \in I$ . Then there exists an IDE flow with FIFO  $f$  with bounded inflow rate functions  $f_{i,e}^+$ .*

*Proof.* Starting with the empty flow which is a feasible IDE flow for the empty set  $[0, 0)$ , we can repeatedly extend it for  $\varepsilon := \frac{1}{2} \min \{\tau_e \mid e \in E\}$  with Lemma 5.1 to obtain a sequence  $(f_k)_{k \in \mathbb{N}}$ , where  $f_k$  is an IDE flow for  $[0, k \cdot \varepsilon)$ . Taking the pointwise limit for every inflow rate function gives us an IDE flow for all times. Note that  $u_i(\theta)$  and  $f_{i,e}^-(\theta) \leq \nu_e$  are bounded at every point in time. Hence, the flow conservation constraint implies that the inflow rate functions  $f_{i,e}^+$  are bounded as well.  $\square$

## 6 Termination of IDE Flows in Multi-Sink Networks

We show that there are instances in which all IDE flows do not terminate. We first observe that while the proofs of Lemma 4.3 and Corollary 4.5 can easily be adapted to the multi-sink case (so it is still true that all flows in an acyclic network and all IDE flows with total volume less than  $\tau_\Delta \nu_{\min}$  eventually terminate), this is not true for the proof of Theorem 4.6.

**Theorem 6.1.** *There is a multi-source multi-sink network with two sinks and all edge transit times and rate capacities equal to 1, where any IDE flow does not terminate.*

To construct such an instance we make use of several gadgets. The first one, gadget  $A$ , will serve as the main building block and is depicted in Figure 7. It consists of two cycles with one common edge  $v_1 v_2$  and one player  $i$  with sink node  $t$  (outside the gadget and reachable from the nodes  $v_2, v_5$  and  $v_7$  via some paths  $P_2, P_5$  and  $P_7$ , respectively) and a constant network inflow rate of 2 on the interval  $[0, 1)$  at node  $v_1$ . Our goal will

be to embed this gadget into a larger instance in such a way, that for any IDE flow, the flow associated with player  $i$  will exhibit the following flow pattern for all  $h \in \mathbb{N}$  (see Figure 6):

1. **On the interval  $[5h, 5h + 1)$ :** All flow generated at  $v_1$  (for  $h = 0$ ) or arriving at  $v_1$  (for  $h > 0$ ) enters the edge to  $v_2$  at a rate of 2, half of it directly starting to travel along the edge, half of it building up a queue of length 1 at time  $5h + 1$ .
2. **On the interval  $[5h + 1, 5h + 2)$ :** The flow arriving at node  $v_2$  enters the edge to  $v_3$  because  $v_2, v_3, v_4, v_5, P_5$  is currently the shortest path to  $t$ . The length of the queue of edge  $v_1v_2$  decreases until it reaches 0 at time  $5h + 2$ .
3. **On the interval  $[5h + 2, 5h + 3)$ :** The flow arriving at node  $v_2$  enters the edge to  $v_6$  because  $v_2, v_6, v_7, P_7$  is currently the shortest path to  $t$ .
4. **On the interval  $[5h + 4, 5h + 5)$ :** The flows arriving at nodes  $v_5$  and  $v_7$  enter the respective edges towards node  $v_1$  because  $v_5, v_1, v_2, P_2$  as well as  $v_7, v_1, v_2, P_2$  are currently the shortest paths to get to  $t$ .
5. **On the interval  $[5h + 5, 5h + 6)$ :** There is a total inflow of 2 at node  $v_1$ , which enters the edge to  $v_2$ . Thus, the pattern repeats.

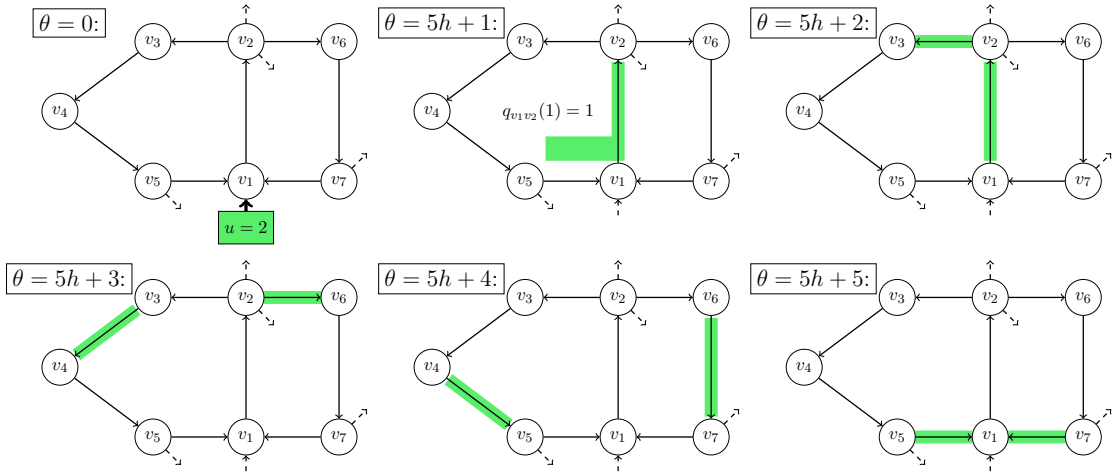

Figure 6: The desired flow pattern in gadget  $A$  at times  $\theta = 0, 1, 2, 3, 4, 5, \dots$

The effect of this behavior is, that other particles outside the gadget, who want to travel through this gadget along the central vertical path, will estimate an additional waiting time as indicated by the diagram displayed inside gadget  $A$  in Figure 7 (next to the vertical red path). Now, in order to actually guarantee the described behavior, we need to embed gadget  $A$  into a larger instance in such a way, that for any IDE flow the following assumptions hold:



1. The only edges leaving  $A$  are the start edges of the four dashed paths indicated in Figure 7.
2. The three (blue) paths  $P_2, P_5$  and  $P_7$  are of the same length  $L$  (w.r.t.  $\tau_e$ ).
3. For all  $h \in \mathbb{N}$ 
  - the unique shortest  $v_2$ - $t$  path for all  $\theta \in [5h + 1, 5h + 2)$  is  $v_2, v_3, v_4, v_5, P_5$ ,
  - the unique shortest  $v_2$ - $t$  path for all  $\theta \in [5h + 2, 5h + 3)$  is  $v_2, v_6, v_7, P_7$ ,
  - the unique shortest  $v_5$ - $t$  path for all  $\theta \in [5h + 4, 5h + 5)$  is  $v_5, v_1, v_2, P_2$  and
  - the unique shortest  $v_7$ - $t$  path for all  $\theta \in [5h + 4, 5h + 5)$  is  $v_7, v_1, v_2, P_2$ .

Note that at time  $\theta = 5h + 2$  we do not require that there is only one unique  $v_2$ - $t$  path. This is due to the fact that waiting times always change continuously and therefore when the shortest  $v_2$ - $t$  path changes from one path to another, there needs to be a time where both paths are equally long. Thus, there cannot always be a unique shortest path. However, this does not influence the overall flow pattern, since those discrete points in time form a set of measure zero and thus only allow for flow of volume zero to escape the overall flow pattern.

In order to satisfy the assumptions 1.-3., we will now construct three types of gadgets  $B_2, B_5$  and  $B_7$  for the three paths  $P_2, P_5$  and  $P_7$ , each provides of equal length and on which any IDE flow induces waiting times as shown by the respective diagrams on the right side in Figure 7.

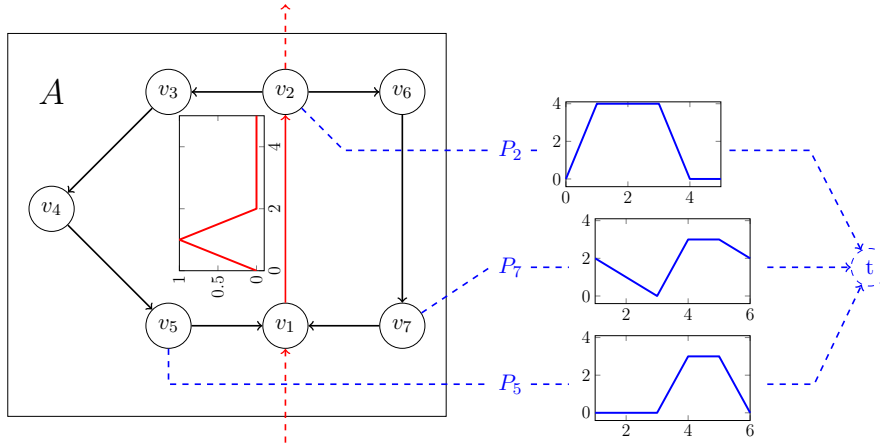

Figure 7: Gadget  $A$  (the dashed paths and nodes are not part of the gadget). The (red) diagram inside the box  $A$  indicates the waiting time on edge  $v_1v_2$  (and therefore on the (red) vertical path through the gadget), provided that the flow originating inside this gadget follows the flow pattern indicated in Figure 6. The (blue) diagrams on the right indicate the desired waiting times on the paths  $P_2, P_5$  and  $P_7$ , respectively, which in turn ensure that the flow inside the gadget does indeed follow the desired flow pattern.

To build these gadgets we need time shifted versions of gadget  $A$ , which we denote by  $A^{+k}$ . Such a gadget is constructed the same way as gadget  $A$  above, with the only

difference that the support of the network inflow rate function  $u_i$  is shifted to the interval  $[k \bmod 5, k \bmod 5 + 1)$ . Gadget  $B_2$  now consists of the concatenation of four gadgets of type  $A^{+0}$ , four gadgets of type  $A^{+1}$  and four gadgets of type  $A^{+2}$  in series along their vertical paths through them with three edges between each two gadgets (see Figure 8).

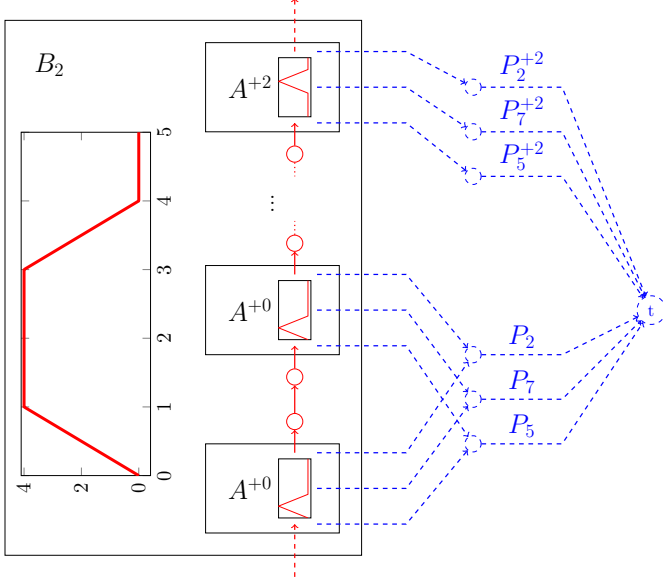

Figure 8: Gadget  $B_2$  consisting of four copies of each of the types  $A^{+0}, A^{+1}, A^{+2}$ . The diagram inside the box of gadget  $B_2$  indicates the waiting time on the vertical path through gadget  $B_2$ , provided that within all of the used gadgets  $A$ , the flow follows the flow pattern from Figure 6. The dashed parts are not part of the gadgets and only sketch how this gadget needs to be embedded in a larger instance.

Similarly, gadget  $B_5$  consists of three copies of  $A^{+3}$ -type gadgets, three copies of  $A^{+4}$ -type gadgets and additional  $6 \cdot 4$  edges to ensure that the vertical path has the same length as the one of gadget  $B_2$ . Finally, gadget  $B_7$  consists of three copies of  $A^{+3}$ -type gadgets, three copies of  $A^{+4}$ -type gadgets, two copies of  $A^{+5}$ -type gadgets, one copy of  $A^{+6}$ -type gadgets and additional  $3 \cdot 4$  edges to ensure that the vertical path has the same length as the one of gadget  $B_2$ .

We again use the notation  $B_j^{+k}$  to refer to a time shifted version of gadget  $B_j$  – i.e. with all used gadgets  $A$  shifted by additional  $k$  time steps. Next, we build a gadget  $C$  by just taking one copy of each  $B_j^{+k}$  for all  $j \in \{2, 5, 7\}$  and  $k = 0, 1, 2, 3, 4$  (see Figure 9).

Finally, taking two copies of this gadget,  $C$  and  $C'$ , and two additional nodes,  $t$  and  $t'$ , where  $t$  will be the sink node for all players in  $C$  and  $t'$  the sink node for all players in  $C'$ , we can build our entire graph as indicated by Figure 10. We connect the top edges of the gadgets  $B_j^{+k}$  in gadget  $C'$  with the sink  $t$  and use those gadgets' respective vertical paths as the  $P_j^{+k}$  paths for gadget  $C$  and vice versa.

In order to prove the correctness of our construction (i.e. that any IDE flow on this instance does not terminate) we need the following important observation:

*Observation 6.2.* If a flow in some  $A^{+k}$ -type gadget (with  $k \in \{0, 1, 2, 3, 4\}$ ) follows the desired flow pattern for all unit time intervals between  $k$  and some  $\theta \in \mathbb{N}_0, \theta \geq k$ , the induced waiting time on edge  $v_1 v_2$  of this gadget (and therefore on the vertical path through this gadget) will follow the waiting time function indicated by the diagram in

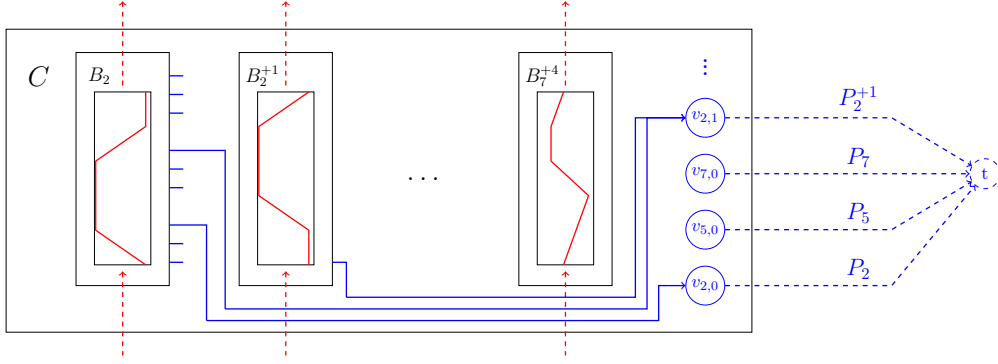

Figure 9: Gadget  $C$

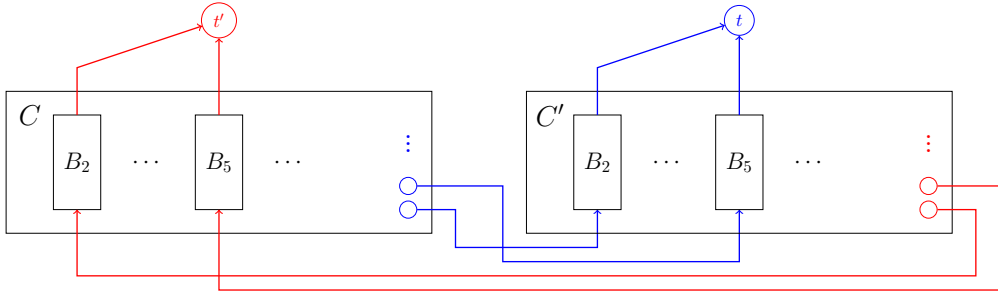

Figure 10: The whole graph

Figure 7 (shifted by  $k$ ) for the next unit time interval  $[\theta, \theta + 1)$ , independent of the evolution of the flow in this interval.

*Proof of Observation 6.2.* If  $(\theta - k) \equiv 0 \pmod{5}$ , then over the following interval  $[\theta, \theta + 1)$  we will have an inflow of 2 at node  $v_1$ . Either because it originates here (if  $\theta = k$ ) or because (by assumption) the flow pattern already holds for the previous unit time interval and, thus, flow has entered edges  $v_5v_1$  and  $v_7v_1$ , both at rate 1, in this interval. Since the edge  $v_1v_2$  is the only one leaving  $v_1$ , all flow will enter this edge and thereby starting to build up a queue of length 1 at time  $\theta + 1$ .

If  $(\theta - k) \equiv 1 \pmod{5}$ , we start with a queue of length 1 at edge  $v_1v_2$ , which linearly decreases to 0 over the course of the interval as no new flow arrives at  $v_1$  and flow leaves the edge at  $v_2$  at rate 1. As all edges leaving  $v_2$  are currently empty, no new queues can form, regardless of which edge the flow actually uses.

In all other cases, we start with empty queues at all edges. As no flow arrives at node  $v_1$  and at all other nodes flow arrives with at most rate 1 (since all other nodes only have one incoming edge with rate capacity 1), no new queues can form.  $\square$

**Corollary 6.3.** *If a flow in some  $B_j^{+k}$ -type gadget follows the desired flow pattern for all unit time intervals up to some  $\theta \in \mathbb{N}_0$ , the induced waiting time on the vertical path through this gadget will follow the waiting time function indicated by the respective*

diagram on the right in Figure 7 (shifted by  $k$ ) for the next unit time interval  $[\theta, \theta + 1)$ , independent of the evolution of the flow in this interval.

We now want to prove that any IDE flow in the constructed instance does not terminate. To do that we will take a generic  $A^{+k}$ -type gadget from this instance and show by induction that the flow originating in  $v_1$  of this gadget will follow the flow pattern described at the beginning of the construction and indicated in Figure 6.

*Proof of Theorem 6.1.* Let  $\tilde{A}$  be a copy of gadget  $A$ , time shifted by some  $k \in \{0, 1, 2, 3, 4\}$  and w.l.o.g. in  $C$ . We then need to show that all flow in this gadget will obey the pattern described above (time shifted by  $k$ ) for all unit time intervals between  $k$  and  $\theta$  for all  $\theta \in \mathbb{N}_0, \theta \geq k$ . As our induction basis we take  $\theta = k$ , for which the claim trivially holds.

For our induction step we assume that the flow in this gadget (and therefore all other gadgets  $A$  in the instance) follows the desired pattern for all unit time intervals up to some  $\theta \in \mathbb{N}_0, \theta \geq k$  and want to show that it also does so for the next unit time interval  $[\theta, \theta + 1)$ .

**Case 1:  $(\theta - k) \equiv 0 \pmod{5}$**  See the respective case in the proof of Observation 6.2.

**Case 2:  $(\theta - k) \equiv 1 \pmod{5}$**  Over the following unit time interval, flow will arrive at node  $v_2$  at a rate of 1 while the queue on edge  $v_1v_2$  decreases. We need to show that all arriving flow will enter edge  $v_2v_3$ , as  $v_2, v_3, v_4, v_5, P_5$  is currently the shortest  $v_2$ - $t$  path (w.r.t. instantaneous travel time). By induction and Corollary 6.3, we already know that all paths  $P_j^{+k'}$  will exhibit the waiting time pattern indicated by the respective diagram on the right in Figure 7 (shifted by  $k$ ). As, by construction, all those paths have a common length  $L$  (w.r.t.  $\tau_e$ ), we can calculate the length of all possible  $v_2$ - $t$  paths:

- The path  $v_2, v_3, v_4, v_5, P_5$  has length  $3 + L$  and an additional waiting time of 0.
- The path  $v_2, P_2$  has length  $L$  and an additional waiting time of 4.
- The path  $v_2, v_6, v_7, P_7$  has length  $2 + L$  and an additional waiting time between 2 and 1.
- All paths leaving gadget  $\tilde{A}$  have a length of at least  $3 + 1 + L$  (three edges between the current gadget and the next one, one edge through this gadget and  $L$  edges for whatever gadget  $B_j^{+k'}$  is finally used to get to  $t$ ) and possibly additional waiting times.

So the path beginning with edge  $v_2v_3$  has the shortest total instantaneous travel time and even uniquely so for all times except  $\theta + 1$ . Therefore all flow arriving at  $v_2$  must enter edge  $v_2v_3$  for the whole interval  $[\theta, \theta + 1)$ .

**Case 3:  $(\theta - k) \equiv 2 \pmod{5}$**  Over the following unit time interval, flow will arrive at rate 1 at node  $v_3$ , which has to enter edge  $v_3v_4$  as this is the only one leaving  $v_3$ , and at node  $v_2$ . We now need to show that all this flow enters edge  $v_2v_6$  (except possibly at time  $\theta$ ). We will do this in the same way as in case 2, i.e. by calculating the instantaneous travel times for all relevant paths with the help of Corollary 6.3:

- The path  $v_2, v_3, v_4, v_5, P_5$  has length  $3 + L$  and an additional waiting time of 0.
- The path  $v_2, P_2$  has length  $L$  and an additional waiting time of 4.
- The path  $v_2, v_6, v_7, P_7$  has length  $2 + L$  and an additional waiting time between 1 and 0.
- All paths leaving gadget  $\tilde{A}$  again have a length of at least  $4 + L$ .

So all flow must enter edge  $v_2v_6$  as the path beginning with this edge is the unique shortest  $v_2 - t$  path.

**Case 4:  $(\theta - k) \equiv 3 \pmod{5}$**  Over the following unit time interval, flow arrives at rate 1 at the nodes  $v_4$  and  $v_6$ . Since those only have one edge leaving them, the flow will just follow the only possible path.

**Case 5:  $(\theta - k) \equiv 4 \pmod{5}$**  Over the following unit time interval, flow arrives at rate 1 at the nodes  $v_5$  and  $v_7$ . We need to show that all this flow enters the edges  $v_5v_1$  and  $v_7v_1$ , respectively. So as in case 2 and 3 we need to calculate the instantaneous travel times on all relevant  $v_5-t$  and  $v_7-t$  paths - again using Corollary 6.3:

- The path  $v_5, v_2, P_2$  has length  $2 + L$  and an additional waiting time of 0.
- The path  $v_5, P_5$  has length  $L$  and an additional waiting time of 3.
- The path  $v_7, v_2, P_2$  has length  $2 + L$  and an additional waiting time of 0.
- The path  $v_7, P_7$  has length  $L$  and an additional waiting time of 3.

With the induction completed we have shown that for any IDE flow and any copy of gadget  $A$  within the given instance all flow generated at  $v_1$  will arrive back at its start node after five unit time steps at which point the whole network is in exactly the same state as before. Thus, every IDE flow cycles and does not terminate.  $\square$

Although we made use of several distinct source nodes, this is in fact not necessary in order to get a network with non-terminating IDEs. I.e. Theorem 6.1 can be strengthened as follows.

**Theorem 6.4.** *There exists a single-source multi-sink network with two sinks, where any IDE flow does not terminate.*

*Proof.* To prove this theorem we extend the network from Theorem 6.1 in such a way that after some initial warm-up time any IDE flow behaves exactly as in the initial network. First, we make sure that all network inflow rate functions  $u_i$  have the interval  $[0, 1)$  as their support. This can be accomplished by introducing a new source node  $\tilde{s}_i$  for every commodity  $i$  and connecting that new source node with an edge of length  $r_i$  and rate capacity 2 to the original source node  $s_i$  (see Figure 11). Also note that the two sink nodes  $t$  and  $t'$  have no outgoing edges.

Next, we add one node  $\hat{s}$ , which will be our super source. Then for every commodity  $i$  we add two distinct nodes  $v_i, w_i$  and edges as indicated in Figure 12 (where  $w_i$  is always

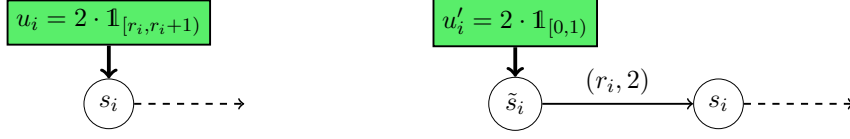

Figure 11: Changing the graph from the proof of Theorem 6.1 (left) in such a way that all release times are within the interval  $[0, 1)$  (right).

connected to  $t_i$ , the sink node of commodity  $i$ ). Finally, we replace the commodities  $I$  by two new commodities 0 and  $0'$  with common source node  $\hat{s}$ . Commodity 0 has  $t$  as its sink node and the following network inflow rate function

$$\hat{u}_0(\theta) = \begin{cases} \sum_{t_i=t} \tau(P_i) + 6, & \theta \in [0, 1) \\ 0, & \text{else} \end{cases},$$

where for every commodity  $i \in I$  with sink node  $t$ ,  $P_i$  is a shortest  $\tilde{s}_i$ - $t$  path in  $G$ . Commodity  $0'$  has  $t'$  as its sink node and an analogous inflow rate function  $\hat{u}_{0'}$ .

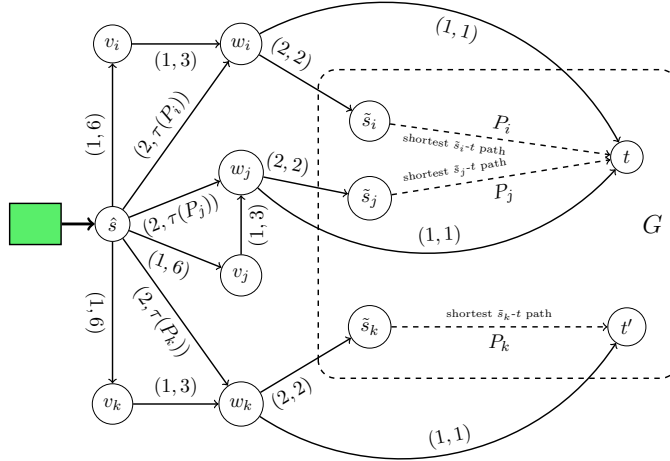

Figure 12: The modified network with only one single source and two sinks. After an initial warm-up phase (see Figure 13) the flow inside  $G$  behaves just as in the original network from the proof of Theorem 6.1.

Now at time  $\theta = 0$ , the shortest  $\hat{s}$ - $t$  paths are  $\hat{s}, w_i, t$  and  $\hat{s}, v_i, w_i, t$  (for  $i$  with  $t_i = t$ ) with length 3 since every other path has to go through  $G$  and therefore has a length of at least 4. As the inflow rate of commodity 0 exactly matches the total rate capacity of the first edges of all those paths, the flow of commodity splits between these edges  $\hat{s}, w_i$  and  $\hat{s}, v_i$  using all of them with full capacity.

At time  $\theta = 1$ , the flow arriving at node  $v_i$  with rate 6 enters the edge  $v_i w_i$  and starts forming a queue on that edge. At time  $\theta = 2$ , flow arrives with rate  $\tau(P_i) + 3$  at node  $w_i$  and starts entering the edge  $w_i, \hat{t}_i$ , building up a queue there. At time  $\theta = 3$ , this queue has reached a length of  $\tau(P_i) + 2$ , at which point the paths  $w_i, t$  and  $w_i, \tilde{s}_i, P_i, t$  have the same instantaneous travel time (note that by this time no flow has yet entered  $G$  and, thus, no waiting times occur within  $G$ ). Thus, from now on the flow arriving at node  $w_i$  at rate 3 splits between the edges  $w_i, t$  and  $w_i, \tilde{s}_i$  proportional to the respective rate capacities. Thus, between time  $\theta = 5$  and  $\theta = 6$ , flow arrives at node  $\tilde{s}_i$  at a rate of 2.

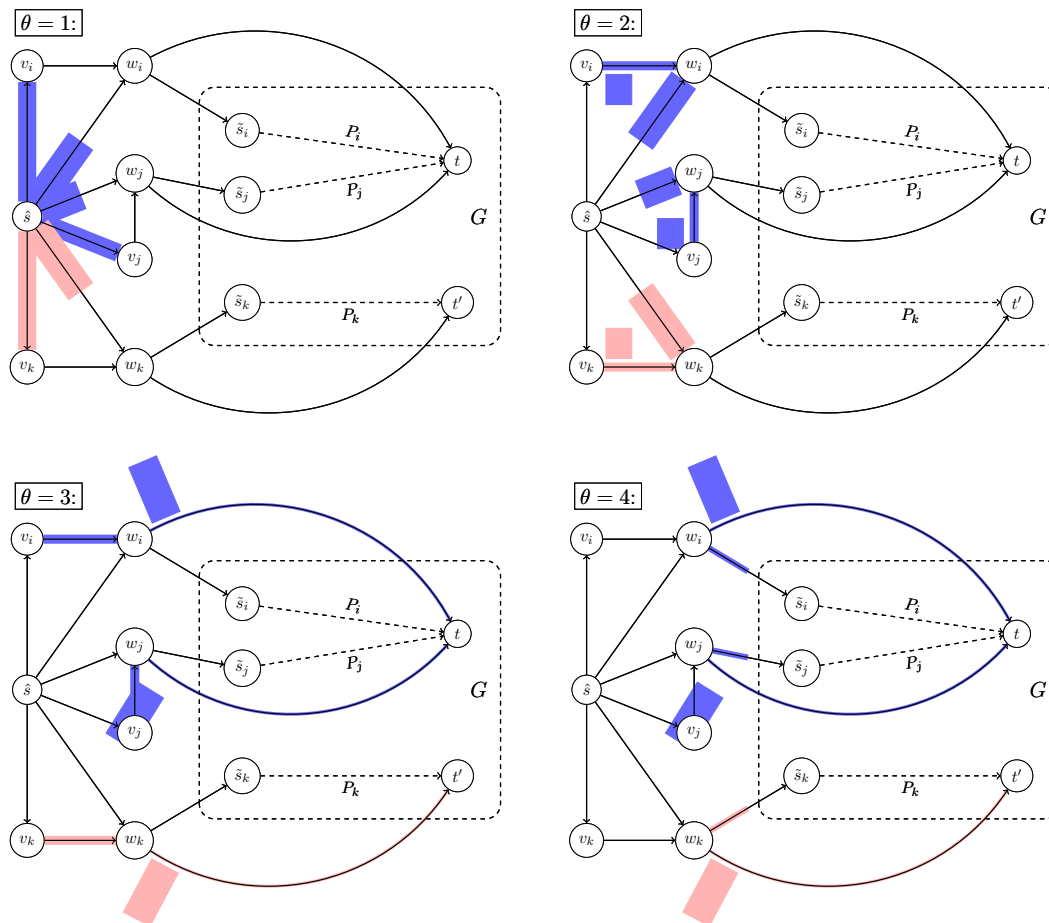

Figure 13: *The evolution of any IDE flow in the modified network. Between times 5 and 6, flow will arrive at a rate of 2 at all nodes  $\tilde{s}_i$ , while the flow on the edges  $w_i t$  or  $w_i t'$  does not interfere with the flow inside  $G$  from now on.*

As the same flow evolution happens for commodity  $0'$ , at time  $\theta = 5$ , the new network is in the same state as the original network at time  $\theta = 0$ . In particular, all the flow entering  $G$  at one of the nodes  $\tilde{s}_i$  will stay inside the network forever and so the flow will never terminate.  $\square$

## 7 Summary and Open Problems

We introduced in this paper the concept of IDE flows and investigated two key questions: existence and termination of IDE flows. Regarding the former, we gave in Section 3 an extension-algorithm leading to the existence of IDE flows for single-sink instances. While the extension-algorithm is constructive, it is not clear if finitely many calls of the algorithm suffice to compute an IDE – at the moment existence relies on a limit argument. Especially for restricted graph classes (series-parallel graphs or acyclic graphs) we expect finiteness. For multi-source multi-sink instances, we gave in Section 5 a general existence theorem – also based on an extension property. The extension property, however, relies in this case on a solution to a variational inequality rendering it non-constructive. Making this step constructive remains an open problem.

Regarding termination of IDE flows, we showed in Theorem 4.6 that for single-sink networks, all IDE flows terminate. In a forthcoming paper [9], we give quantitative upper bounds of  $\mathcal{O}(U\tau(G))$  for the time such an IDE flow needs to terminate, where  $U := \sum_{i \in I} \int_0^\infty u_i(\theta) d\theta$  is the total network inflow and  $\tau(G) := \sum_{e \in E} \tau_e$  the sum of all edge transit times. On the other hand, we can give lower bounds of order  $\Theta(U \log \tau(G))$ , see [9] for details. In Section 6, we gave an example for a multi-sink network, where no IDE flow terminates. By Theorem 6.4, we know that only a single-source and two sinks are needed for this effect to appear (and by Theorem 4.6 we also know that this is the minimal number of sinks necessary). However, the underlying graph is quite complex and it would be interesting to see, whether there are certain graph classes beside acyclic ones, where termination is guaranteed even in the multi-sink case (i.e., planar graphs, series parallel graphs, ...).



## References

- [1] Umang Bhaskar, Lisa Fleischer, and Elliot Anshelevich. A Stackelberg strategy for routing flow over time. *Games Econom. Behav.*, 92:232–247, 2015.
- [2] David E. Boyce, Bin Ran, and Larry J. LeBlanc. Solving an instantaneous dynamic user-optimal route choice model. *Transp. Sci.*, 29(2):128–142, 1995.
- [3] Haïm Brézis. Équations et inéquations non linéaires dans les espaces vectoriels en dualité. *Ann. Inst. Fourier*, 18(1):115–175, 1968.
- [4] Roberto Cominetti, José R. Correa, and Omar Larré. Dynamic equilibria in fluid queueing networks. *Oper. Res.*, 63(1):21–34, 2015.
- [5] Roberto Cominetti, José R. Correa, and Neil Olver. Long term behavior of dynamic equilibria in fluid queueing networks. In *Integer Programming and Combinatorial Optimization - 19th International Conference, IPCO 2017, Waterloo, ON, Canada, June 26-28, 2017, Proceedings*, pages 161–172, 2017.
- [6] Lester R. Ford and Delbert R. Fulkerson. *Flows in Networks*. Princeton University Press, 1962.
- [7] Terry L. Friesz, David Bernstein, Tony E. Smith, Roger L. Tobin, and Byung-Wook Wie. A variational inequality formulation of the dynamic network user equilibrium problem. *Oper. Res.*, 41(1):179–191, Jan 1993.
- [8] Terry L. Friesz, Javier Luque, Roger L. Tobin, and Byung-Wook Wie. Dynamic network traffic assignment considered as a continuous time optimal control problem. *Oper. Res.*, 37(6):893–901, 1989.
- [9] Lukas Graf and Tobias Harks. Termination bounds for instantaneous dynamic equilibrium flows. Working paper, 2019.
- [10] Younes Hamdouch, Patrice Marcotte, and Sang Nguyen. A strategic model for dynamic traffic assignment. *Netw. Spat. Econ.*, 4(3):291–315, Sep 2004.
- [11] Anisse Ismaili. Routing games over time with fifo policy. In Nikhil R. Devanur and Pinyan Lu, editors, *Web and Internet Economics*, pages 266–280. Springer International Publishing, 2017. There is also a version available on arXiv: <http://arxiv.org/abs/1709.09484>.
- [12] Ronald Koch and Martin Skutella. Nash equilibria and the price of anarchy for flows over time. *Theory Comput. Syst.*, 49(1):71–97, 2011.
- [13] Patrice Marcotte, Sang Nguyen, and Alexandre Schoeb. A strategic flow model of traffic assignment in static capacitated networks. *Oper. Res.*, 52(2):191–212, 2004.
- [14] Frédéric Meunier and Nicolas Wagner. Equilibrium results for dynamic congestion games. *Transp. Sci.*, 44(4):524–536, 2010.

- [15] Srinivas Peeta and Athanasios Ziliaskopoulos. Foundations of dynamic traffic assignment: The past, the present and the future. *Netw. Spat. Econ.*, 1(3):233–265, 2001.
- [16] Bin Ran and David E. Boyce. *Dynamic urban transportation network models: theory and implications for intelligent vehicle-highway systems*. Lect. Notes Econ. Math. Syst. Springer, Berlin, New York, Paris, 1996.
- [17] Bin Ran, David E. Boyce, and Larry J. LeBlanc. A new class of instantaneous dynamic user-optimal traffic assignment models. *Oper. Res.*, 41(1):192–202, 1993.
- [18] Leon Sering and Martin Skutella. Multi-Source Multi-Sink Nash Flows over Time. In Ralf Borndörfer and Sabine Storandt, editors, *18th Workshop on Algorithmic Approaches for Transportation Modelling, Optimization, and Systems (ATMOS 2018)*, volume 65 of *OASICS – OpenAccess Ser. Inform.*, pages 12:1–12:20, Dagstuhl, Germany, 2018. Schloss Dagstuhl–Leibniz-Zentrum fuer Informatik.
- [19] Leon Sering and Laura Vargas-Koch. Nash flows over time with spillback. In *Proc. 30th Annual ACM-SIAM Sympos. on Discrete Algorithms*, ACM, 2019.
- [20] Martin Skutella. An introduction to network flows over time. In *Research Trends in Combinatorial Optimization, Bonn Workshop on Combinatorial Optimization, November 3-7, 2008, Bonn, Germany*, pages 451–482, 2008.
- [21] Yanxia Tang, Jinyu Guan, Yongchun Xu, and Yongfu Su. A kind of system of multivariate variational inequalities and the existence theorem of solutions. *J. Inequal. Appl.*, 2017(1):208, Sep 2017.
- [22] Avinash Unnikrishnan and Steven Waller. User equilibrium with recourse. *Netw. Spat. Econ.*, 9(4):575–593, 2009.
- [23] William S. Vickrey. Congestion theory and transport investment. *Am. Econ. Rev.*, 59(2):251–60, May 1969.
- [24] Daoli Zhu and Patrice Marcotte. On the existence of solutions to the dynamic user equilibrium problem. *Transp. Sci.*, 34(4):402–414, 2000.