

Lattice paths and submonoids of \mathbb{Z}^2

James East and Nicholas Ham

Abstract

We study a number of combinatorial and algebraic structures arising from walks on the two-dimensional integer lattice. To a given step set $X \subseteq \mathbb{Z}^2$, there are two naturally associated monoids: \mathcal{F}_X , the monoid of all X -walks/paths; and \mathcal{A}_X , the monoid of all endpoints of X -walks starting from the origin O . For each $A \in \mathcal{A}_X$, write $\pi_X(A)$ for the number of X -walks from O to A . Calculating the numbers $\pi_X(A)$ is a classical problem, leading to Fibonacci, Catalan, Motzkin, Delannoy and Schröder numbers, among many other famous sequences and arrays. Our main results give the precise relationships between finiteness properties of the numbers $\pi_X(A)$, geometrical properties of the step set X , algebraic properties of the monoid \mathcal{A}_X , and combinatorial properties of a certain bi-labelled digraph naturally associated to X . There is an intriguing divergence between the cases of finite and infinite step sets, and some constructions rely on highly non-trivial properties of real numbers. We also consider the case of walks constrained to stay within a given region of the plane, and present a number of algorithms for computing the combinatorial data associated to finite step sets. Several examples are considered throughout to highlight the sometimes-subtle nature of the theoretical results.

Keywords: lattice paths; enumeration; commutative monoids.

MSC: 05A15; 05C38; 05C12; 20M14; 05C20; 05C30; 20M13; 05A10.

Contents

1	Introduction	1
2	Unconstrained walks	4
2.1	Definitions and basic examples	4
2.2	Finiteness properties: FPP, IPP and BPP	7
2.3	Geometric conditions: CC, SLC and LC	8
2.4	Recursion and further examples	11
2.5	Small step sets	16
2.6	Geometric, algebraic and combinatorial characterisations of the IPP	17
2.7	An implicational hierarchy	19
2.8	Groups	21
2.9	Possible combinations of finiteness properties and geometric conditions	25
2.10	Appendix (with a contribution from Stewart Wilcox): Combination (V)	28
3	Constrained walks	34
3.1	Definitions and basic examples	34
3.2	Recursion and further examples	36
3.3	Geometric conditions and finiteness properties for constrained walks	41
3.4	Admissible steps, and constraint sets containing lattice cones	44
4	Algorithms	46
4.1	Computing the points	46
4.2	Checking the Line Condition	49
4.3	Computing the numbers	51
4.4	Further examples	58

1 Introduction

The study of lattice paths is a cornerstone of enumerative combinatorics, and important applications exist in almost all areas of mathematics. The subject arguably goes back at least to the likes of Fermat and Pascal in the 1600s, and it would be impossible to adequately recount here its fascinating development over the subsequent centuries. Fortunately, we may direct the reader to the survey of Humphreys [29] for an

excellent historical treatment, and the recent thesis of Bostan [7], which contains 397 references. The current authors came to the topic through our interest in diagram semigroups and algebras, where an important role is played by Catalan and Motzkin paths, Riordan arrays, and so on; see for example [12–14, 16, 25].

Many kinds of lattice path problems have been considered in the literature, but the main ones we are interested in are related to the following questions (formal definitions will be given below):

- Suppose we have a subset X of the two-dimensional integer lattice \mathbb{Z}^2 . Starting from some designated origin, which points from \mathbb{Z}^2 can we get to by taking a “walk” using “steps” from X ?
- Further, given a point from \mathbb{Z}^2 , how many such “ X -walks” will take us to this point?

Sometimes constraints are also imposed, so that the X -walks must stay within a specified region of the plane (e.g., the first quadrant). In what follows, the set of all endpoints of (unconstrained) X -walks beginning at the origin $O = (0, 0)$ will be denoted \mathcal{A}_X ; this set is always an additive submonoid of \mathbb{Z}^2 . For any point $A \in \mathbb{Z}^2$, we write $\pi_X(A)$ for the number of X -walks from O to A ; this number could be anything from 0 to ∞ .

Answers to the above questions are well known in many special cases, and lead to famous number sequences, triangles and arrays, including Fibonacci, Catalan, Motzkin, Delannoy and Schröder numbers, as well as binomial and multinomial coefficients. Many of these will be discussed in examples below, and many more can be found in the above-mentioned surveys and references therein, as well as the Online Encyclopedia of Integer Sequences [1], which was as ever a valuable tool while conducting the research reported here. Even for (apparently) simple step sets, solving these problems can be very difficult. As noted in [29], infinite step sets are rarely studied, as are boundaries with irrational slope; both feature strongly in the present work.

The current article takes a kind of meta-level approach to lattice path problems, and addresses broad questions of the following type: Given a certain property, which step sets X possess that property? The kinds of properties we study include the following:

- the monoid \mathcal{A}_X is a group, or
- $\pi_X(A)$ is finite for all $A \in \mathcal{A}_X$, in which case we say X has the Finite Paths Property (FPP), or
- $\pi_X(A)$ is infinite for all $A \in \mathcal{A}_X$, in which case we say X has the Infinite Paths Property (IPP).

One of our main results, Theorem 2.44, states (among other things) that every finite step set has either the FPP or the IPP, and gives a number of equivalent geometric characterisations of both properties. The situation for infinite step sets is far more complicated, and there is a whole spectrum of interesting behaviours that can occur; the geometric conditions alluded to just above are no longer equivalent, and there are step sets with neither the FPP nor the IPP. Rather, the geometric conditions and finiteness properties fit together into a kind of “implicational hierarchy” that limits the (ostensibly) possible combinations of these conditions/properties. Characterising the combinations that actually do occur is a major part of the paper, and to achieve this we will need to construct some fairly strange step sets; some of these constructions rely on highly non-trivial properties of real numbers. The paper is organised as follows.

Section 2 concerns unconstrained walks. We begin with the basic definitions in Section 2.1, and then introduce the above-mentioned finiteness properties and geometric conditions in Sections 2.2 and 2.3. A method for recursively enumerating lattice paths in certain circumstances is given in Section 2.4, and then applied to classify the algebraic structure of the monoids arising from step sets of size at most 2 in Section 2.5. The first main result of the paper (Theorem 2.36) is given in Section 2.6; it provides geometric, algebraic and combinatorial characterisations of the IPP, showing among other things that X has the IPP if and only if the origin belongs to $\text{Conv}(X)$, the convex hull of X . Section 2.7 contains the above-mentioned implicational hierarchy (Theorem 2.44); this hierarchy simplifies dramatically in the case of finite step sets, leading in particular to the FPP/IPP dichotomy alluded to above (Corollary 2.46). The main result of Section 2.8 (Theorem 2.51) states that the monoid \mathcal{A}_X is a non-trivial group if and only if the origin belongs to the relative interior of $\text{Conv}(X)$; a number of other equivalent geometric characterisations are also given. Finally, Sections 2.9 and 2.10 classify the combinations of finiteness properties and geometric conditions that can be attained by step sets. The above-mentioned Theorem 2.44 (proved in Section 2.7) limits the set of ostensibly possible combinations to ten, and these are enumerated in Table 1. Curiously, we will see that exactly one of these combinations can never occur (Proposition 2.60), but that the nine remaining combinations can; this is shown by constructing step sets with the relevant properties. One of

these constructions utilises an ingenious argument from Stewart Wilcox, which demonstrates the existence of certain sequences of real numbers; this is given in Section 2.10, which serves as an appendix to Section 2 and is written jointly with Wilcox.

Section 3 gives a somewhat parallel treatment of walks that are constrained to stay within a specified region of the plane. As well as reducing the number of walks, these constraints also somewhat limit the extent to which general results can be proved. However, in certain natural cases (such as when the bounding region of the plane happens to be a monoid), it is possible to give constrained analogues of many of the results from Section 2. Section 3.1 gives the basic definitions, and then Section 3.2 extends the recursive enumeration method from Section 2.4 to constrained walks (Proposition 3.7). Section 3.3 gives a constrained version of the implicational hierarchy (Theorem 3.19); even in the finite case, the situation is more complicated than for unconstrained walks, as for one thing, the FPP/IPD dichotomy no longer holds. Propositions 3.23 and 3.24 are analogues of the above-mentioned Theorems 2.36 and 2.51, respectively. Finally, Section 3.4 explores the natural idea of admissible steps, and shows how these allow for some stronger general results on constrained walks, especially in the case that the bounding region of the plane contains a lattice cone (Theorems 3.26 and 3.31).

Section 4 presents a number of computer algorithms that may be used to calculate the combinatorial data corresponding to a finite step set, in both the constrained and unconstrained cases. These algorithms have been implemented in C++, and are available at [26].

Numerous examples are given throughout the exposition. Some of these are used to illustrate the underlying ideas, while some are crucial in establishing theoretical results. The properties of these step sets, and the combinatorial data associated to them, are displayed conveniently in certain edge- and vertex-labelled digraphs; these are defined in Sections 2.1 and 3.1, and can be seen in many of the figures throughout the document. The above-mentioned algorithms [26] were used to generate the L^AT_EX/TikZ code for producing many of these diagrams.

Among the questions not considered in the current paper, we believe that one of the most interesting is the following: When are step sets X and Y “equivalent” in various senses? One sense might be for the monoids \mathcal{A}_X and \mathcal{A}_Y to be isomorphic, although it is easy for this to occur; just take $Y = X \cup \{A\}$ for any $A \in \mathcal{A}_X \setminus X$. (Gubeladze has considered the isomorphism problem for submonoids of \mathbb{Z}^2 in [23], and more generally for \mathbb{Z}^n in [24], where he showed that monoid isomorphism is equivalent to isomorphism of monoid rings.) It can often be the case that the monoids \mathcal{A}_X and \mathcal{A}_Y are isomorphic (or even equal), but the associated numbers $\pi_X(A)$ and $\pi_Y(A)$ are very different; thus, if one mostly cares about the number sequences, one might prefer a different notion of equivalence. Another such notion might be to require the existence of a bijection $\phi : X \rightarrow Y$ that lifts to a monoid isomorphism $\Phi : \mathcal{A}_X \rightarrow \mathcal{A}_Y$, and such that $\pi_X(A) = \pi_Y(\Phi(A))$ for all $A \in \mathcal{A}_X$: i.e., such that that following diagram commutes:

$$\begin{array}{ccc} \mathcal{A}_X & \xrightarrow{\Phi} & \mathcal{A}_Y \\ \pi_X \searrow & & \swarrow \pi_Y \\ & \mathbb{N} \cup \{\infty\} & \end{array}$$

This occurs in several places in the current paper; for instance, see Examples 2.1, 2.22 and 2.23 (cf. Figures 2 and 10). Alternatively, one might simply require the existence of such an isomorphism $\Phi : \mathcal{A}_X \rightarrow \mathcal{A}_Y$ that does not necessarily restrict to a bijection $X \rightarrow Y$. For a striking instance of this latter phenomenon in the constrained case, see Examples 3.3 and 3.17 (cf. Figures 19 and 25); one of these step sets has size 2, while the other is infinite (with no redundant steps), yet exactly the same numbers are produced.

There is also of course scope to extend the current program into higher dimensions, or to non-rectangular lattices. Most of our results on finite step sets work with \mathbb{Z}^2 replaced by \mathbb{Q}^2 , since we may multiply throughout by a common denominator, but infinite step sets with rational coordinates (or arbitrary step sets with real coordinates) behave very differently.

Throughout, we assume familiarity with basic linear algebra, number theory, and plane (convex) geometry and topology. We denote by \mathbb{R} , \mathbb{Q} and \mathbb{Z} the sets of reals, rationals and integers; we also write $\mathbb{N} = \{0, 1, 2, \dots\}$ and $\mathbb{P} = \{1, 2, 3, \dots\}$ for the sets of natural numbers and positive integers. We use $\lfloor x \rfloor$ to denote the floor of the real number x : i.e., the greatest integer not exceeding x . We interpret a binomial coefficient $\binom{n}{k}$ to be zero if n is not a non-negative integer, or if k is not an integer satisfying $0 \leq k \leq n$. For three distinct points $A, B, C \in \mathbb{R}^2$, we write $\angle ABC$ for the angle between the line segments AB and BC ; if not otherwise specified, this will always be the non-reflex angle; we write \overrightarrow{AB} for the displacement vector from A to B .

2 Unconstrained walks

2.1 Definitions and basic examples

We write $\mathbb{Z}_\times^2 = \mathbb{Z}^2 \setminus \{O\}$, where $O = (0, 0)$, and we define a *step set* to be any subset of \mathbb{Z}_\times^2 ; we allow step sets to be finite or (countably) infinite. If $X \subseteq \mathbb{Z}_\times^2$ is such a step set, then we may consider two natural monoids associated to X . The first is the *free monoid* on X , which we denote by \mathcal{F}_X , and which consists of all words over X under the operation of word concatenation. So elements of \mathcal{F}_X are words of the form $u = A_1 \cdots A_k$, where $k \in \mathbb{N}$ and $A_1, \dots, A_k \in X$. The *length* of the word $u = A_1 \cdots A_k$ is defined to be k , and is denoted $\ell(u)$; when $k = 0$, we interpret u to be the *empty word*, which we denote by ε , and which is the identity element of \mathcal{F}_X . For reasons that will become clear shortly, we will also refer to the elements of \mathcal{F}_X as *X-walks*.

The second kind of monoid associated to a step set $X \subseteq \mathbb{Z}_\times^2$ is the additive submonoid of \mathbb{Z}^2 generated by X , which we will denote by \mathcal{A}_X . So \mathcal{A}_X consists of all points of the form $A = A_1 + \cdots + A_k$, where $k \in \mathbb{N}$ and $A_1, \dots, A_k \in X$; when $k = 0$, we interpret $A = O = (0, 0)$, which is the identity element of \mathcal{A}_X .

There is a natural monoid surmorphism (surjective homomorphism)

$$\alpha_X : \mathcal{F}_X \rightarrow \mathcal{A}_X \quad \text{defined by} \quad \alpha_X(A_1 \cdots A_k) = A_1 + \cdots + A_k.$$

In particular, note that $\alpha_X(A) = A$ for all $A \in X$. Consider a word $u = A_1 \cdots A_k \in \mathcal{F}_X$, and let $B \in \mathbb{Z}^2$ be an arbitrary lattice point. Then u determines a *walk* beginning at B , and ending at $B + \alpha_X(u)$. The letters A_1, \dots, A_k determine the *steps* taken in the walk, and the points visited are:

$$B \rightarrow B + A_1 \rightarrow B + A_1 + A_2 \rightarrow \cdots \rightarrow B + A_1 + A_2 + \cdots + A_k = B + \alpha_X(u).$$

We say that u is an *X-walk from B to $B + \alpha_X(u)$* . In particular, if $B = O = (0, 0)$, then u corresponds to a walk from O to $\alpha_X(u)$; we say that u is an *X-walk to $\alpha_X(u)$* .

We illustrate these ideas with (arguably) the most well-studied step set:

Example 2.1. Consider the step set $X = \{E, N\}$, where $E = (1, 0)$ and $N = (0, 1)$ represent steps of one unit East and North, respectively. So $\mathcal{A}_X = \{aE + bN : a, b \in \mathbb{N}\} = \{(a, b) : a, b \in \mathbb{N}\} = \mathbb{N}^2$. Consider the two words $u = EENEN$ and $v = NNEEE$ from \mathcal{F}_X . Although $u \neq v$, we note that $\alpha_X(u) = \alpha_X(v) = 3E + 2N = (3, 2)$. We may picture the walks from O to $(3, 2)$ determined by u and v as in Figure 1. It is easy to see that there are $\binom{5}{3} = \binom{5}{2} = 10$ words w from \mathcal{F}_X such that $\alpha_X(w) = (3, 2)$; such a word w must have three E 's and two N 's. We say that there are ten *X-walks to $(3, 2)$* . More generally, for any $(a, b) \in \mathcal{A}_X = \mathbb{N}^2$, there are $\binom{a+b}{a} = \binom{a+b}{b}$ X -walks to (a, b) . In fact, this formula is valid for any $(a, b) \in \mathbb{Z}^2$ since, by convention, we interpret a binomial coefficient $\binom{m}{k} = 0$ if $m < k$ or if $k < 0$.

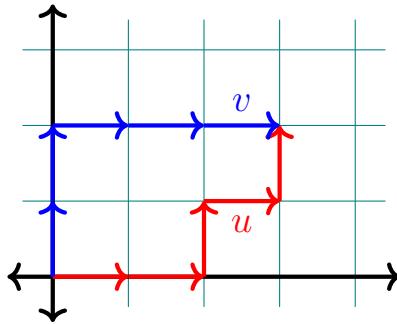

Figure 1: Two X -walks from O to $(3, 2)$, where $X = \{(1, 0), (0, 1)\}$; cf. Example 2.1.

Consider an arbitrary step set $X \subseteq \mathbb{Z}_\times^2$. For arbitrary lattice points $A, B \in \mathbb{Z}^2$, we define

$$\Pi_X(A, B) = \{u \in \mathcal{F}_X : A + \alpha_X(u) = B\} \quad \text{and} \quad \pi_X(A, B) = |\Pi_X(A, B)|.$$

So $\Pi_X(A, B)$ is the (possibly empty) set of all X -walks from A to B , and $\pi_X(A, B)$ is the number of such walks. Note that it is possible to have $\pi_X(A, B) = 0$ or ∞ . Also note that we always have $\pi_X(A, A) \geq 1$ for any $A \in \mathbb{Z}^2$, since the empty word ε always belongs to $\Pi_X(A, A)$. It is clear that

$$\Pi_X(A + C, B + C) = \Pi_X(A, B) \quad \text{and} \quad \pi_X(A + C, B + C) = \pi_X(A, B) \quad \text{for any } A, B, C \in \mathbb{Z}^2. \quad (2.2)$$

Consequently, the numbers $\pi_X(A, B)$, $A, B \in \mathbb{Z}^2$, may all be recovered from the values $\pi_X(O, A)$, $A \in \mathbb{Z}^2$. Accordingly, for any $A \in \mathbb{Z}^2$, we define

$$\Pi_X(A) = \Pi_X(O, A) \quad \text{and} \quad \pi_X(A) = \pi_X(O, A)$$

to be the set and number of X -walks from O to A , respectively; note that $\Pi_X(A) = \alpha_X^{-1}(A)$ for any $A \in \mathbb{Z}^2$. If $A = (a, b) \in \mathbb{Z}^2$, we will write $\pi_X(A) = \pi_X(a, b)$, rather than $\pi_X((a, b))$. For example, if $X = \{E, N\}$ is the step set from Example 2.1, then for any $a, b \in \mathbb{Z}$, we have $\pi_X(a, b) = \binom{a+b}{a} = \binom{a+b}{b}$.

Given a step set X , the values of $\pi_X(A)$ may be conveniently displayed on an edge- and vertex-labelled digraph, which we denote by Γ_X , and define as follows:

- The vertices of Γ_X are the elements of \mathcal{A}_X , and each vertex $A \in \mathcal{A}_X$ is labelled by $\pi_X(A)$.
- For each vertex $A \in \mathcal{A}_X$, and for each $B \in X$, Γ_X has the labelled edge $A \xrightarrow{B} A + B$.

Since the vertices of the graph Γ_X are actually elements of \mathbb{Z}^2 , we generally draw Γ_X in the plane \mathbb{R}^2 , with the vertices in the specified position. So Γ_X is the *Cayley graph* of \mathcal{A}_X with respect to the generating set X , embedded in the plane, and with each vertex labelled by the number of factorisations in the generators. As an example, Figure 2 pictures the graph Γ_X , where $X = \{E, N\}$ is the step set from Example 2.1. One may easily see that this is a rotation of Pascal's triangle [31].

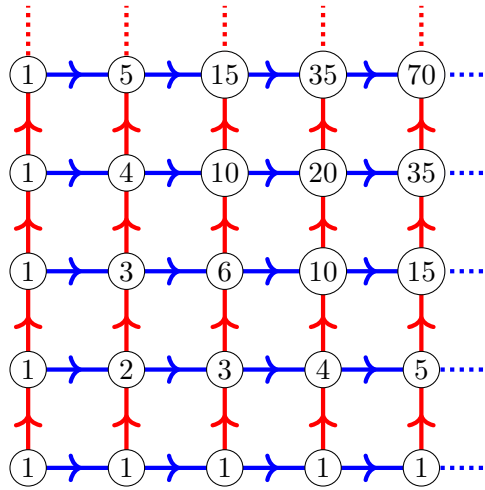

Figure 2: The graph Γ_X , where $X = \{(1, 0), (0, 1)\}$; cf. Example 2.1.

The next example is an obvious sequel to Example 2.1.

Example 2.3. Let $X = \{N, E, S, W\}$, where $N = (0, 1)$, $E = (1, 0)$, $S = (0, -1)$ and $W = (-1, 0)$. Then of course $\mathcal{A}_X = \mathbb{Z}^2$, and $\pi_X(A) = \infty$ for all $A \in \mathbb{Z}^2$. See Figure 3 (left) for an illustration of Γ_X .

The next example involves a step set strictly between those of Examples 2.1 and 2.3.

Example 2.4. Let $X = \{N, E, S\}$, where $N = (0, 1)$, $E = (1, 0)$ and $S = (0, -1)$. Then $\mathcal{A}_X = \mathbb{N} \times \mathbb{Z}$, and $\pi_X(A) = \infty$ for all $A \in \mathcal{A}_X$. The graph Γ_X is pictured in Figure 3 (right).

We conclude this section by considering a collection of infinite step sets.

Example 2.5. Let $X = \{1\} \times \mathbb{Z} = \{(1, a) : a \in \mathbb{Z}\}$. Then one may easily check that

$$\mathcal{A}_X = \{O\} \cup (\mathbb{P} \times \mathbb{Z}) = \{O\} \cup \{(a, b) \in \mathbb{Z}^2 : a \geq 1\},$$

and that for any $a, b \in \mathbb{Z}$,

$$\pi_X(a, b) = \begin{cases} 1 & \text{if } (a, b) = O \text{ or } a = 1 \\ \infty & \text{if } a \geq 2 \\ 0 & \text{otherwise.} \end{cases}$$

The graph Γ_X is pictured in Figure 4 (left). Note that while there are infinitely many X -walks to any $(a, b) \in \mathcal{A}_X$ with $a \geq 2$, any such walk is of length a . Figure 4 (right) also pictures the graph associated to a different step set, whose steps point in the same direction as the steps from the current one; more details will be given in Example 2.25.

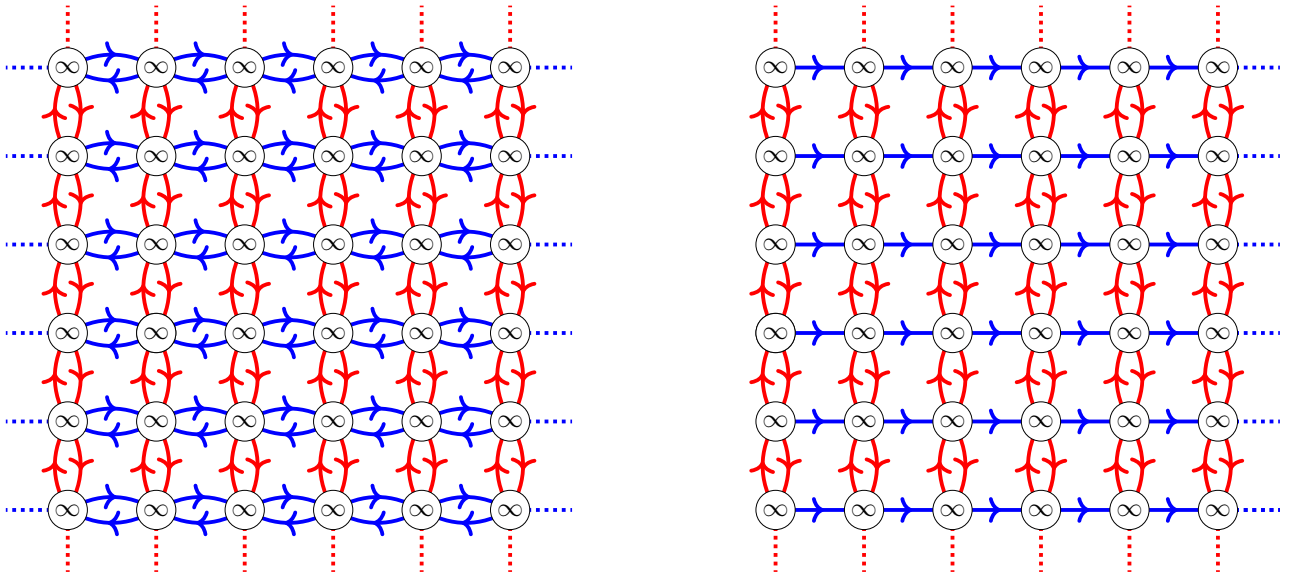

Figure 3: The graph Γ_X , where $X = \{(\pm 1, 0), (0, \pm 1)\}$ (left) and $X = \{(1, 0), (0, \pm 1)\}$ (right); cf. Examples 2.3 and 2.4.

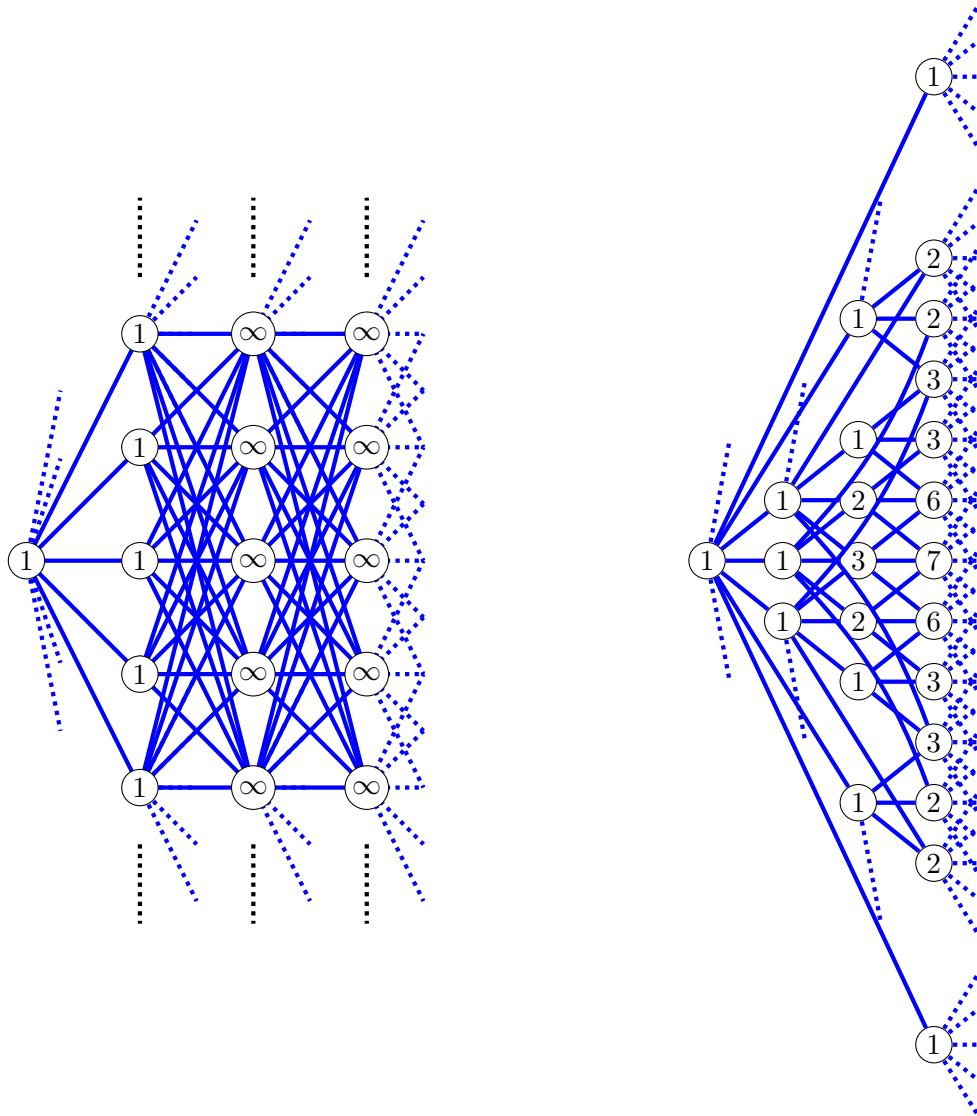

Figure 4: The graph Γ_X , where $X = \{1\} \times \mathbb{Z}$ (left) and $X = \{(1, 0)\} \cup \{(a, \pm a^2) : a \in \mathbb{P}\}$ (right); cf. Examples 2.5 and 2.25. All edges are directed to the right.

The next two examples are natural companions to the previous one.

Example 2.6. Let $X = \{1\} \times \mathbb{N}$. Then $\mathcal{A}_X = \{O\} \cup (\mathbb{P} \times \mathbb{N})$. The graph Γ_X is pictured in Figure 5 (left). The vertex labels $\pi_X(A)$, $A \in \mathcal{A}_X$, were calculated by simply counting paths in the graph, but it appears that these are binomial coefficients: specifically, that

$$\pi_X(a, b) = \binom{a+b-1}{b} \quad \text{for } (a, b) \in \mathbb{P} \times \mathbb{N}.$$

We will see later that this formula is indeed correct; cf. Remark 2.20.

It is curious that (apart from the extra “1”, and modulo a small translation), the infinite step set from Example 2.6 produces the same numbers as the finite step set from Example 2.1.

Example 2.7. Let $X = \{1\} \times \mathbb{P}$. Then $\mathcal{A}_X = \{O\} \cup \{(a, b) \in \mathbb{P}^2 : a \leq b\}$. The graph Γ_X is pictured in Figure 5 (right). Again, the labels appear to be binomial coefficients (cf. Remark 2.20): this time,

$$\pi_X(a, b) = \binom{a-1}{b-1} \quad \text{for } (a, b) \in \mathcal{A}_X \setminus \{O\}.$$

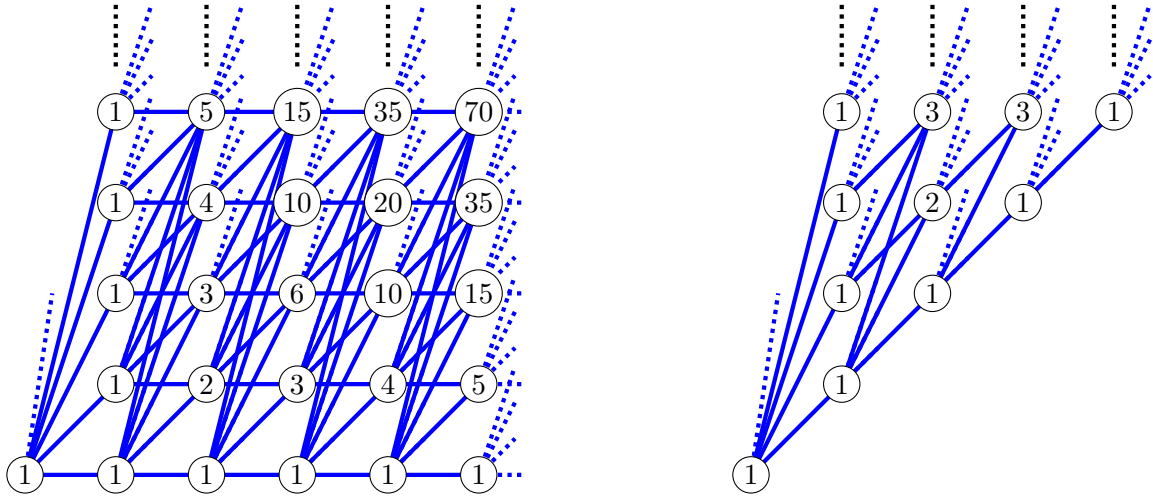

Figure 5: The graph Γ_X , where $X = \{1\} \times \mathbb{N}$ (left) and $X = \{1\} \times \mathbb{P}$ (right); cf. Examples 2.6 and 2.7. All edges are directed to the right.

The next example is a minor variation of the previous one.

Example 2.8. Let $X = \{(0, 1)\} \cup (\{1\} \times \mathbb{P})$. Then $\mathcal{A}_X = \{(a, b) \in \mathbb{N}^2 : a \leq b\}$. The graph Γ_X is pictured in Figure 6. The labels again appear to be binomial coefficients, though not all of them, and the exact formula is not completely obvious. Entering the first few values on the OEIS [1] yields Sequence A085478, which (if the match is perfect) suggests the formula

$$\pi_X(a, b) = \binom{a+b}{b-a} \quad \text{for } (a, b) \in \mathcal{A}_X.$$

Again this turns out to be correct; cf. Remark 2.20.

We leave the reader to investigate the step set $X = \mathbb{P}^2$.

2.2 Finiteness properties: FPP, IPP and BPP

Inspired by Examples 2.1 and 2.3 above, we introduce the following two properties that might be satisfied by a step set $X \subseteq \mathbb{Z}_\times^2$.

- We say X has the *Finite Paths Property* (FPP) if $\pi_X(A) < \infty$ for all $A \in \mathcal{A}_X$.
- We say X has the *Infinite Paths Property* (IPP) if $\pi_X(A) = \infty$ for all $A \in \mathcal{A}_X$.

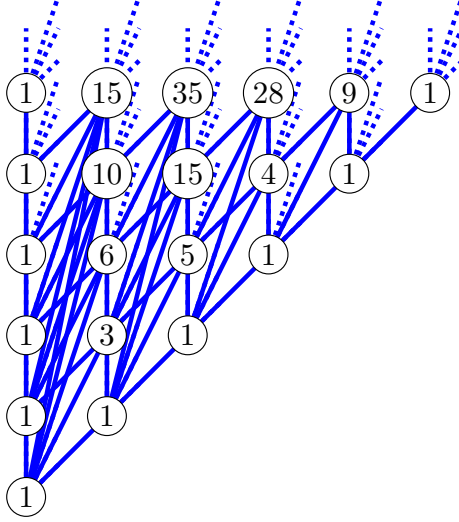

Figure 6: The graph Γ_X , where $X = \{(0, 1)\} \cup (\{1\} \times \mathbb{P})$; cf. Example 2.8. All edges are directed upwards.

Example 2.5 shows that some step sets satisfy neither the FPP nor the IPP; cf. Figure 4 (left). By contrast, we will see later that *finite* step sets must satisfy one or the other. Example 2.5 does suggest a third property worthy of attention:

- We say a step set $X \subseteq \mathbb{Z}_x^2$ has the *Bounded Paths Property* (BPP) if, for all $A \in \mathcal{A}_X$, the set $\{\ell(w) : w \in \Pi_X(A)\}$ has a maximum element (equivalently, this set is finite).

We begin with a simple result concerning the IPP. Recall that the empty word ε belongs to $\Pi_X(O)$ for any step set X , so that $\pi_X(O) \geq 1$.

Lemma 2.9. *Let $X \subseteq \mathbb{Z}_x^2$ be an arbitrary step set. Then the following are equivalent:*

- (i) X has the IPP,
- (ii) $\pi_X(O) = \infty$,
- (iii) $\pi_X(O) \geq 2$.

Proof. Clearly (i) \Rightarrow (ii) \Rightarrow (iii). Now assume (iii) holds, and let $A \in \mathcal{A}_X$ be arbitrary. Let $u \in \Pi_X(O) \setminus \{\varepsilon\}$ and $v \in \Pi_X(A)$. Then $u^k v \in \Pi_X(A)$ for all $k \geq 0$, from which it follows that $\pi_X(A) = \infty$. \square

The next result demonstrates a basic relationship between the three properties, in particular showing that the BPP is an intermediate between the FPP and \neg IPP (the symbol \neg denotes negation). Specifically, we have $\text{FPP} \Rightarrow \text{BPP} \Rightarrow \neg\text{IPP}$.

Lemma 2.10. *Let $X \subseteq \mathbb{Z}_x^2$ be an arbitrary step set.*

- (i) *If X has the FPP, then X has the BPP.*
- (ii) *If X has the BPP, then X does not have the IPP.*

Proof. (i). If $\Pi_X(A)$ is finite, then so too is $\{\ell(w) : w \in \Pi_X(A)\}$.

(ii). If the set $\{\ell(w) : w \in \Pi_X(O)\}$ is finite, then $\pi_X(O) = 1$; cf. Lemma 2.9 and its proof. \square

We will see later that the three conditions FPP, BPP and \neg IPP are equivalent for *finite* step sets.

2.3 Geometric conditions: CC, SLC and LC

A line splits the plane \mathbb{R}^2 into two open subsets, one on each side of the line; we will call these open sets *half-planes*, and we will say that they are *opposites* of each other. By a *cone* we mean an intersection of two half-planes whose bounding lines are not parallel; the intersection of these bounding lines is called the *vertex* of the cone; by the *opposite* of such a cone, we mean the intersection of the opposite half-planes. See Figure 7. Note that half-planes and cones are always open sets. Note also that half-planes are not cones.

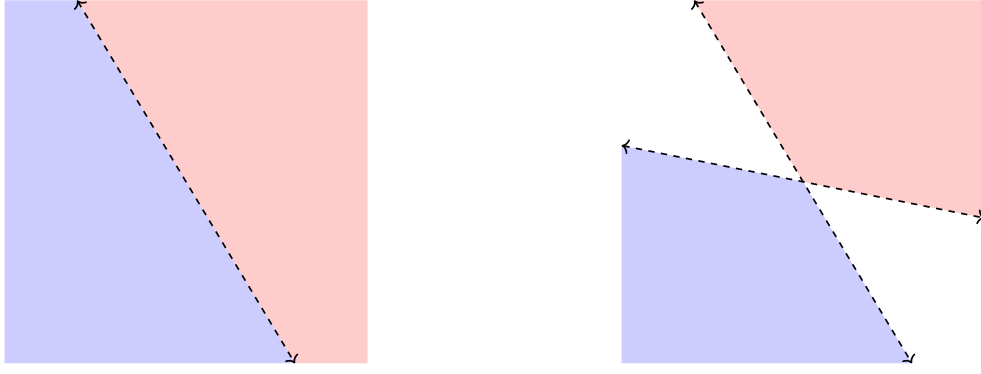

Figure 7: A pair of opposite half-planes (left) and a pair of opposite cones (right).

Now let $X \subseteq \mathbb{Z}_\times^2$ be an arbitrary step set.

- We say X satisfies the *Line Condition* (LC) if it is contained in a half-plane bounded by a line through the origin.
- We say X satisfies the *Strong Line Condition* (SLC) if it is contained in a half-plane whose opposite half-plane contains the origin.
- We say X satisfies the *Cone Condition* (CC) if it is contained in a cone with the origin as its vertex.

We say that a line \mathcal{L} through the origin *witnesses* the LC (for X) if X is contained in one of the half-planes determined by \mathcal{L} . Similarly, we may speak of a line (not through the origin) witnessing the SLC, or of a pair of lines (through the origin) witnessing the CC, or of a cone (with vertex O) witnessing the CC.

At this point, the reader may wonder why we have not defined a Strong Cone Condition. For completeness, we do so here (in the obvious way) but show immediately that it is equivalent to the ordinary Cone Condition.

- We say a step set $X \subseteq \mathbb{Z}_\times^2$ satisfies the *Strong Cone Condition* (SCC) if it is contained in a cone whose opposite cone contains the origin.

Lemma 2.11. *A step set $X \subseteq \mathbb{Z}_\times^2$ satisfies the CC if and only if it satisfies the SCC.*

Proof. (SCC \Rightarrow CC). Any cone whose opposite cone contains the origin is contained in a cone with O as its vertex.

(CC \Rightarrow SCC). Suppose X satisfies the CC, as witnessed by the cone \mathcal{C} bounded by lines \mathcal{L}_1 and \mathcal{L}_2 . Choose any points $A \in \mathcal{L}_1$ and $B \in \mathcal{L}_2$, both on the boundary of \mathcal{C} . As the triangle $\triangle AOB$ has finite area, it contains only finitely many elements of X (perhaps none). So we may slide the points A and B towards the origin, along \mathcal{L}_1 and \mathcal{L}_2 , until we reach points $C \in \mathcal{L}_1$ and $D \in \mathcal{L}_2$, both on the boundary of \mathcal{C} , and such that the triangle $\triangle COD$ contains no elements of X . Now let E be an arbitrary point in the interior of this triangle. Then the SCC is witnessed by the line through C and E and the line through D and E . All of this is pictured in Figure 8. \square

We will also have occasion to speak of a *Weak Line Condition* (WLC), but since we will not need it until Section 2.8 we will not give the definition here.

Lemma 2.12. *Let $X \subseteq \mathbb{Z}_\times^2$ be an arbitrary step set.*

- If X satisfies the CC, then X satisfies the SLC.*
- If X satisfies the SLC, then X satisfies the LC.*
- If X is finite and satisfies the LC, then X satisfies the CC.*

Proof. (i). If X satisfies the CC, then by Lemma 2.11 it satisfies the SCC. If a cone \mathcal{C} witnesses the SCC, then the bounding lines of \mathcal{C} both witness the SLC.

(ii). If the SLC condition is witnessed by \mathcal{L} , then clearly the LC is witnessed by the line through O parallel to \mathcal{L} .

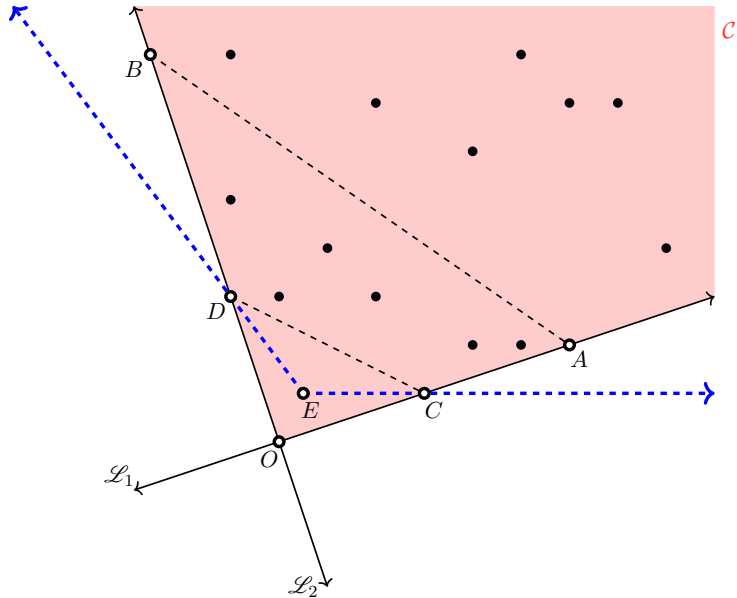

Figure 8: Schematic diagram of the proof of Lemma 2.11. The elements of X are drawn as black dots.

(iii). Suppose the LC is witnessed by \mathcal{L} , where X is finite. Let A be an arbitrary point on \mathcal{L} other than O (note that $A \notin X$). Let $B \in X$ be such that the non-reflex angle $\angle AOB$ is minimal among all points from X ; this is well defined because X is finite, and we have $0 < \angle AOB < \pi$ because no point from X lies on \mathcal{L} . Let \mathcal{L}' be the line that bisects the angle $\angle AOB$. Then \mathcal{L} and \mathcal{L}' witness the CC. This is all shown in Figure 9. \square

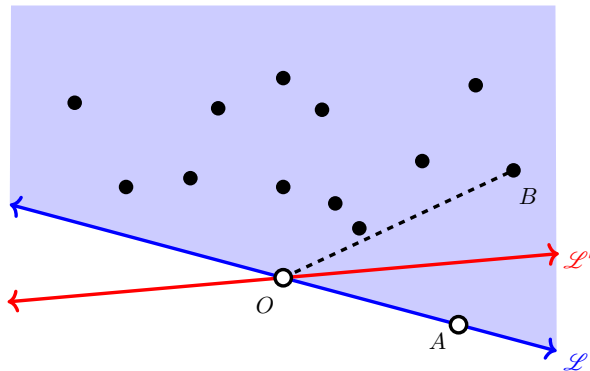

Figure 9: The points A, B and line \mathcal{L}' constructed during the proof of Lemma 2.12(iii).

It follows from Lemma 2.12 that the three conditions CC, SLC and LC are equivalent for finite step sets. The step sets from Examples 2.1, 2.6, 2.7 and 2.8 satisfy all three conditions, and that from Example 2.3 satisfies none of them. The step set from Example 2.5 satisfies the SLC (and hence also the LC) but not the CC. Example 2.29 below shows it is possible to satisfy the LC but not the SLC (and hence also not the CC).

It will also be convenient to prove the following technical result, which will be used on many occasions.

Lemma 2.13. *Let $X \subseteq \mathbb{Z}_{\times}^2$ be a step set with the LC witnessed by a unique line \mathcal{L} . Then*

- (i) X does not satisfy the CC,
- (ii) if X satisfies the SLC, then this can only be witnessed by lines parallel to \mathcal{L} .

Proof. (i). If some cone witnessed the CC, then the two bounding lines would both witness the LC.

(ii). If a line \mathcal{L}' witnesses the SLC, then (as in the proof of Lemma 2.12(ii)) the LC is witnessed by the line through the origin parallel to \mathcal{L}' . By assumption, this must be \mathcal{L} . \square

2.4 Recursion and further examples

Our next goal is to prove a simple result (Proposition 2.15) that enables us to recursively enumerate the values of $\pi_X(A)$ in some cases. The basic motivation for this result is the fact that well-known number arrays that arise from lattice paths are generated by simple recursions: for example, the binomial coefficients, which satisfy $\binom{n}{k} = \binom{n-1}{k} + \binom{n-1}{k-1}$. It turns out that it is the BPP (defined in Section 2.2) that allows such recursive generation of the numbers $\pi_X(A)$.

We begin with a lemma. For the statement and proof, if $U \subseteq \mathcal{F}_X$ is a set of words, and if $w \in \mathcal{F}_X$ is a fixed word, we write $Uw = \{uw : u \in U\}$. In particular, if $A \in X$, then $UA = \{uA : u \in U\}$. We use \sqcup to denote disjoint union.

Lemma 2.14. *Let $X \subseteq \mathbb{Z}_X^2$ be an arbitrary step set.*

- (i) *For any $A \in \mathbb{Z}^2$ and $B \in X$, we have $\Pi_X(A)B \subseteq \Pi_X(A+B)$.*
- (ii) *For any $A \in \mathbb{Z}_X^2$,*

$$\Pi_X(A) = \bigsqcup_{B \in X} \Pi_X(A-B)B \quad \text{and} \quad \pi_X(A) = \sum_{B \in X} \pi_X(A-B).$$

Proof. (i). If $w \in \Pi_X(A)$, then wB is clearly an X -walk from O to $A+B$, so that $wB \in \Pi_X(A+B)$.

(ii). First let $w \in \Pi_X(A)$. Since $A \neq O$, we have $w = B_1 \cdots B_k$ for some $k \geq 1$ and $B_1, \dots, B_k \in X$. Put $w' = B_1 \cdots B_{k-1}$. Then $A = \alpha_X(w) = B_1 + \cdots + B_{k-1} + B_k = \alpha_X(w') + B_k$, so that $\alpha_X(w') = A - B_k$ and $w' \in \Pi_X(A - B_k)$, giving

$$w = w'B_k \in \Pi_X(A - B_k)B_k \subseteq \bigcup_{B \in X} \Pi_X(A - B)B.$$

Conversely, part (i) gives $\Pi_X(A - B)B \subseteq \Pi_X(A - B + B) = \Pi_X(A)$ for all $B \in X$. This completes the proof that $\Pi_X(A) = \bigcup_{B \in X} \Pi_X(A - B)B$, and this union is clearly disjoint. We then deduce

$$\pi_X(A) = \left| \bigsqcup_{B \in X} \Pi_X(A - B)B \right| = \sum_{B \in X} |\Pi_X(A - B)B| = \sum_{B \in X} |\Pi_X(A - B)| = \sum_{B \in X} \pi_X(A - B). \quad \square$$

Lemma 2.14(ii) says nothing about $\pi_X(O)$. However, Lemma 2.9 says that $\pi_X(O)$ can only ever be equal to 1 or ∞ , and that in the latter case we also have $\pi_X(A) = \infty$ for all $A \in \mathcal{A}_X$ (i.e., X has the IPP, as defined in Section 2.2). Thus, if one was primarily interested in enumeration, one would focus on step sets with $\pi_X(O) = 1$. Having $\pi_X(O) = 1$ still does not guarantee “interesting” enumeration, however. For instance, Example 2.5 gives a step set for which the only values of $\pi_X(A)$ are 1 and ∞ (cf. Figure 4); for an even more extreme situation, Example 2.29 below shows that it is possible to have $\pi_X(O) = 1$ but $\pi_X(A) = \infty$ for all $A \in \mathcal{A}_X \setminus \{O\}$.

The next result concerns the BPP (also defined in Section 2.2), and shows how to enumerate the values of $\pi_X(A)$ for any step set X with this property.

Proposition 2.15. *Let $X \subseteq \mathbb{Z}_X^2$ be an arbitrary step set with the BPP. Then the values $\pi_X(A)$, $A \in \mathbb{Z}^2$, are generated by the recurrence*

$$\pi_X(O) = 1 \tag{2.16}$$

$$\pi_X(A) = 0 \quad \text{if } A \in \mathbb{Z}^2 \setminus \mathcal{A}_X \tag{2.17}$$

$$\pi_X(A) = \sum_{B \in X} \pi_X(A - B) \quad \text{if } A \in \mathcal{A}_X \setminus \{O\}. \tag{2.18}$$

Proof. Certainly (2.16)–(2.18) hold, using Lemmas 2.9 and 2.10(ii) for (2.16), and Lemma 2.14(ii) for (2.18). For $A \in \mathcal{A}_X$, let $L(A) = \max\{\ell(w) : w \in \Pi_X(A)\}$; so $L(A)$ is well defined by the BPP. We prove the result by induction on $L(A)$. If $L(A) = 0$, then $A = O$, so (2.16) gives $\pi_X(A) = 1$. Suppose now that $L(A) \geq 1$. By (2.18), it suffices to show that we can calculate $\pi_X(A - B)$ for all $B \in X$. Now, (2.17) gives $\pi_X(A - B) = 0$ if $A - B \notin \mathcal{A}_X$. Next, suppose $B \in X$ and $A - B \in \mathcal{A}_X$, and write $A - B = A_1 + \cdots + A_k$, where $A_1, \dots, A_k \in X$ and $k = L(A - B)$. Then $A = A_1 + \cdots + A_k + B$, so that $L(A) \geq k + 1 > k = L(A - B)$; thus, by induction, we may calculate $\pi_X(A - B)$ using (2.16)–(2.18). \square

Remark 2.19. Often when specifying recurrence relations for number sequences, several non-trivial boundary values are given; for example, with binomial coefficients, we usually specify $\binom{n}{0} = \binom{n}{n} = 1$ for all $n \in \mathbb{N}$, and $\binom{n}{k} = \binom{n-1}{k-1} + \binom{n-1}{k}$ for $n \geq 2$ and $1 \leq k \leq n-1$. But Proposition 2.15 gives $\pi_X(O) = 1$ as the only non-zero boundary value; the other boundary values are $\pi_X(A) = 0$ for $A \notin \mathcal{A}_X$. Thus, we could define the binomial coefficients in this way by specifying $\binom{0}{0} = 1$, $\binom{n}{k} = 0$ if $k < 0$ or $k > n$, and $\binom{n}{k} = \binom{n-1}{k-1} + \binom{n-1}{k}$ if $n \geq 1$ and $0 \leq k \leq n$. Of course this is a minor difference, but it means that instead of creating Pascal's Triangle by starting with "walls of 1's", we instead start with a "sky of 0's" and a single 1 at the top.

Remark 2.20. We will say more in Section 4 about the practical implementation of the recurrence from Proposition 2.15; it turns out that calculating the numbers $L(A)$ defined in the above proof is the key step. But we note here that if one has a proposed formula for $\pi_X(A)$, then one might use Proposition 2.15 to prove this, even if X is infinite. For instance, if $X = \{1\} \times \mathbb{N}$, as in Example 2.6, then we have

$$\pi_X(a, b) = \binom{a+b-1}{b} \quad \text{for all } (a, b) \in \mathbb{P} \times \mathbb{N}. \quad (2.21)$$

Indeed, we can prove this by induction on $a+b$. Now (2.21) is clear if $a=1$ or $b=0$ (cf. Figure 5), so suppose $a \geq 2$ and $b \geq 1$. Then using (2.18) twice, the induction hypothesis, and the standard binomial recurrence, we have

$$\begin{aligned} \pi_X(a, b) &= \sum_{r=0}^b \pi_X(a-1, r) = \pi_X(a-1, b) + \sum_{r=0}^{b-1} \pi_X(a-1, r) = \pi_X(a-1, b) + \pi_X(a, b-1) \\ &= \binom{a+b-2}{b} + \binom{a+b-2}{b-1} = \binom{a+b-1}{b}. \end{aligned}$$

A similar calculation establishes the formula for $\pi_X(A)$ for the step set in Example 2.7.

We may also prove the formula $\pi_X(a, b) = \binom{a+b}{b-a} = \binom{a+b}{2a}$, $0 \leq a \leq b$, for the step set from Example 2.8. This is of course true if $a=0$ or if $a=b$ (cf. Figure 6), and (2.18) gives the recurrence (suppressing terms obviously equal to zero):

$$\pi_X(a, b) = \pi_X(a, b-1) + \sum_{r=a-1}^{b-1} \pi_X(a-1, r).$$

Inductively assuming that $\pi_X(c, d) = \binom{c+d}{2c}$ for $c+d < a+b$, and using the identity $\sum_{k=n}^m \binom{k}{n} = \binom{m+1}{n+1}$, we have

$$\begin{aligned} \pi_X(a, b) &= \binom{a+b-1}{2a} + \sum_{r=a-1}^{b-1} \binom{a-1+r}{2a-2} = \binom{a+b-1}{2a} + \sum_{s=2a-2}^{a+b-2} \binom{s}{2a-2} \\ &= \binom{a+b-1}{2a} + \binom{a+b-1}{2a-1} = \binom{a+b}{2a}. \end{aligned}$$

This verifies that the numbers $\pi_X(A)$ do indeed match [1, Sequence A085478], which at the time of writing had no reference to lattice walks.

We now consider several further examples. The next three well-studied examples are closely related, and involve step sets that are used to define the well-known *Catalan* and *Motzkin numbers*, which we will examine in more detail in Section 3.2. The first two produce the same numbers (binomial coefficients) as Example 2.1.

Example 2.22. Let $X = \{U, F\}$, where $U = (1, 1)$ and $F = (1, 0)$. It is easy to see that

$$\mathcal{A}_X = \{(a, b) \in \mathbb{N}^2 : b \leq a\}.$$

Also, for any $(a, b) \in \mathcal{A}_X$, and any word $u \in \mathcal{F}_X$, we have $(a, b) = \alpha_X(u)$ if and only if $\ell(u) = a$ and u has b U 's (and $a-b$ F 's). It follows that for any $a, b \in \mathbb{Z}$,

$$\pi_X(a, b) = \binom{a}{b}.$$

(Note that $\binom{a}{b} = 0$ if $(a, b) \in \mathbb{Z}^2 \setminus \mathcal{A}_X$.) The graph Γ_X is pictured in Figure 10 (left). Note that Proposition 2.15 yields the usual recurrence

$$\pi_X(a, b) = \pi_X(a-1, b-1) + \pi_X(a-1, b).$$

Example 2.23. Let $X = \{U, D\}$, where $U = (1, 1)$ and $D = (1, -1)$. This time we have

$$\mathcal{A}_X = \{(a, b) \in \mathbb{N} \times \mathbb{Z} : |b| \leq a, a \equiv b \pmod{2}\},$$

and for any $a, b \in \mathbb{Z}$,

$$\pi_X(a, b) = \binom{a}{\frac{a+b}{2}}.$$

The graph Γ_X is pictured in Figure 10 (middle). Proposition 2.15 yields the recurrence

$$\pi_X(a, b) = \pi_X(a-1, b-1) + \pi_X(a-1, b+1).$$

One can see that Examples 2.22 and 2.23 produce the same numbers, but that these are just placed in different locations. However, for any $x, y \in \mathbb{N}$, one has

$$\pi_{\{U, F\}}(xU + yF) = \pi_{\{U, D\}}(xU + yD) = \binom{x+y}{x} = \binom{x+y}{y}.$$

See also Remark 2.33(iv) below.

Example 2.24. Let $X = \{U, D, F\}$, where $U = (1, 1)$, $D = (1, -1)$ and $F = (1, 0)$. Then

$$\mathcal{A}_X = \{(a, b) \in \mathbb{N} \times \mathbb{Z} : |b| \leq a\}.$$

The numbers $\pi_X(a, b)$ are not as easy to determine as those in the previous examples. Figure 10 (right) gives the graph Γ_X , using Proposition 2.15 to compute the values of $\pi_X(a, b)$; note that (2.18) yields the recurrence

$$\pi_X(a, b) = \pi_X(a-1, b-1) + \pi_X(a-1, b) + \pi_X(a-1, b+1).$$

The numbers $\pi_X(A)$ may be found in [1, A027907 or A111808]; note that [1, A027907] lists two step sets different from ours that yield the same numbers, while [1, A111808] implicitly uses our step set in speaking of king paths of length n from $(0, 0)$ to (n, k) on an infinite chess board. The central terms $\pi_X(n, 0)$, $n \in \mathbb{N}$, appear in [1, A002426], which mentions this step set and several equivalent ones including $\{1\} \times \{0, 1, 2\}$ (note that the step set in the current example is $\{1\} \times \{-1, 0, 1\}$). The numbers arising from the step sets $\{1\} \times \{0, 1, 2, 3\}$ and $\{1\} \times \{0, 1, 2, 3, 4\}$ appear in [1, A008287 and A035343].

Examining Figure 2, one may notice that the column sums give powers of 3: i.e., $\sum_{r=-a}^a \pi_X(a, r) = 3^a$. The reason for this is simple: the sum gives the number of X -walks from O to any point in the a th column, which is equal to the number of words of length a over X : i.e., $|X|^a = 3^a$. This is similar to the well-known identity $\sum_{k=0}^n \binom{n}{k} = 2^n$, and of course generalises to step sets of the form $\{1\} \times S$ where $S \subseteq \mathbb{Z}$ is arbitrary (finite or infinite). By a simple inductive argument, one may also show that $\pi_X(a, b)$ is the coefficient of x^{a+b} in $(1+x+x^2)^a$, for each $-a \leq b \leq a$. For example,

$$(1+x+x^2)^4 = 1 + 4x + 10x^2 + 16x^3 + 19x^4 + 16x^5 + 10x^6 + 4x^7 + x^8.$$

This yields another simple proof that the column sums produce powers of 3. We may also use the Binomial Theorem (multiple times) to expand

$$(1+x+x^2)^a = [(1+x)+x^2]^a = [(1+x^2)+x]^a = [(x+x^2)+1]^a,$$

yielding formulae such as

$$\pi_X(a, b) = \sum_{r=0}^a \binom{a}{r} \binom{r}{a-b-r} = \sum_{r=0}^a \binom{a}{r} \binom{r}{a+b-r} = \sum_{r=0}^a \binom{a}{r} \binom{a-r}{r-b} = \sum_{r=0}^a \binom{a}{r} \binom{a-r}{r+b} = \sum_{r=0}^a \binom{a}{r} \binom{r}{\frac{b+r}{2}}.$$

Note that the above sums involve binomial coefficients $\binom{m}{k}$ that evaluate to 0 because $k \notin \{0, 1, \dots, m\}$. A similar formula may be obtained directly. Indeed, if $w \in \Pi_X(a, b)$ has r occurrences of the letter F , then deleting all F 's from w yields a word w' from $\Pi_{\{U, D\}}(a-r, b)$. There are $\binom{a}{r}$ ways to choose the positions for these F 's, and $\pi_{\{U, D\}}(a-r, b) = \binom{a-r}{\frac{a+b-r}{2}}$ choices for w' . Summing over r gives

$$\pi_X(a, b) = \sum_{r=0}^a \binom{a}{r} \binom{a-r}{\frac{a+b-r}{2}}.$$

Instead fixing the number r of D 's in $w \in \Pi_X(a, b)$, one obtains

$$\pi_X(a, b) = \sum_{r=0}^a \binom{a}{r} \pi_{\{U, F\}}(a-r, b+r) = \sum_{r=0}^a \binom{a}{r} \binom{a-r}{b+r}.$$

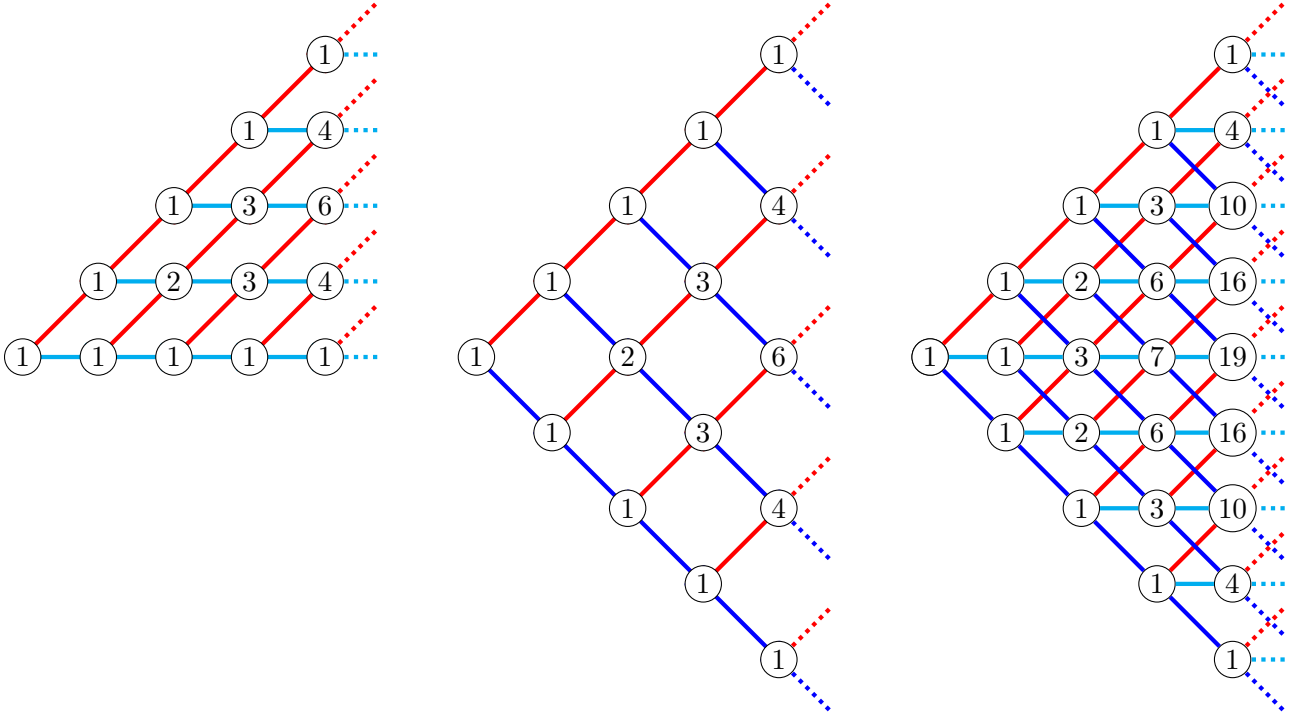

Figure 10: The graph Γ_X , where $X = \{(1, 1), (1, 0)\}$ (left), $X = \{(1, 1), (1, -1)\}$ (middle) and $X = \{(1, 1), (1, 0), (1, -1)\}$ (right); cf. Examples 2.22, 2.23 and 2.24. All edges are directed to the right.

The next three examples each involve infinite step sets; these will be crucial in establishing theoretical results in Section 2.7.

Example 2.25. Let $X = \{(1, 0)\} \cup \{(a, \pm a^2) : a \in \mathbb{P}\}$. Note that the steps in X point in the same directions as those from the step set of Example 2.5. Here it is not so easy to give a uniform description of the elements of the monoid \mathcal{A}_X , or to draw the graph Γ_X , but see Figure 4 (right) for the first few columns. Clearly X satisfies the SLC.

Less trivially, we claim that X does not satisfy the CC. To see this, consider some line \mathcal{L} given by $y = mx$. Let n be an arbitrary integer with $n > |m|$. Then the points (n, n^2) and $(n, -n^2)$ from X lie on opposite sides of \mathcal{L} , meaning that \mathcal{L} does not witness the LC. Thus, $x = 0$ is the unique line witnessing the LC, so the claim follows from Lemma 2.13(i).

It is also the case that X has the FPP. Indeed, one may easily prove this directly, but it also follows from Lemma 2.43(i) below, so we will not provide any further details.

Example 2.26. Let $X = \{(0, -1)\} \cup \{(a, a^2) : a \in \mathbb{P}\}$. We claim that

$$\mathcal{A}_X = \{(x, y) \in \mathbb{Z}^2 : x \geq 0, y \leq x^2\}.$$

To prove this, let Σ denote the set on the right-hand side. Since X is contained in Σ , and since Σ is a submonoid of \mathbb{Z}^2 (as follows from the identity $x_1^2 + x_2^2 \leq (x_1 + x_2)^2$ for $x_1, x_2 \geq 0$), we have $\mathcal{A}_X \subseteq \Sigma$. Conversely, if $(x, y) \in \Sigma$, then $(x, y) = (x, x^2) + (x^2 - y)(0, -1) \in \mathcal{A}_X$.

Next note that X does not satisfy the LC: indeed, the line $x = 0$ contains $(0, -1)$, and any other line through the origin has $(0, -1)$ below it and infinitely many points from X above it. As in the previous example, X has the FPP, as also follows from Lemma 2.43 below.

For use in the next example, we prove the following lemma, which is a slight strengthening of a classical result of Kempner [30, Theorem 2]. The additional strength is not needed immediately, but will be useful later.

Lemma 2.27. *Let R be an arbitrary positive real number. Between any two parallel lines of irrational slope, there exists a lattice point with x -coordinate at least R , and a lattice point with x -coordinate at most $-R$.*

Proof. By symmetry, we just show the existence of a lattice point with x -coordinate at least R . Let the lines have equations $y = \alpha x + \gamma$ and $y = \alpha x + \delta$, where α is irrational, and $\gamma < \delta$. We must show that there exists $(u, v) \in \mathbb{Z}^2$ such that $u > R$ and $\alpha u + \gamma < v < \alpha u + \delta$: i.e., $\gamma < v - \alpha u < \delta$.

Consider the set $M = \{q - \alpha p : p \in \mathbb{P}, q \in \mathbb{Z}\}$. First we make the following claim:

- For any $\varepsilon > 0$ there exists $s, t \in M$ such that $-\varepsilon < s < 0 < t < \varepsilon$.

To prove the claim, let $\varepsilon > 0$ be arbitrary. By Dirichlet's Theorem (see for example [33, Theorem 1A]), there exist $p \in \mathbb{P}$ and $q \in \mathbb{Z}$ such that $|q - \alpha p| < \varepsilon$. Since α is irrational and $p \neq 0$, we have $q - \alpha p \neq 0$. We assume $q - \alpha p > 0$, the other case being symmetrical. Put $t = q - \alpha p$, noting that $t \in M$ and $0 < t < \varepsilon$. Now consider the numbers $t, 2t, 3t, \dots$; since $0 < t < \varepsilon$, at least one of these belongs to the interval $1 - \varepsilon < x < 1$, say $1 - \varepsilon < kt < 1$ where $k \in \mathbb{P}$. Then put $s = kt - 1 = (kq - 1) - \alpha(kp)$.

Returning to the main proof now, we consider three cases.

Case 1. If $\gamma < 0 < \delta$, then by the claim (with $\varepsilon = \frac{\delta}{R}$) there exists $p \in \mathbb{P}$ and $q \in \mathbb{Z}$ such that $0 < q - \alpha p < \frac{\delta}{R}$. Since $\gamma < 0$ it follows that $\frac{\gamma}{R} < q - \alpha p < \frac{\delta}{R}$. We then take $(u, v) = (Rp, Rq)$.

Case 2. If $0 \leq \gamma < \delta$, then we put $\varepsilon = \frac{\delta - \gamma}{R}$. By the claim there exists $p \in \mathbb{P}$ and $q \in \mathbb{Z}$ such that $t = q - \alpha p$ satisfies $0 < t < \varepsilon$. Again one of the numbers $t, 2t, 3t, \dots$ must lie in the interval $\frac{\gamma}{R} < x < \frac{\delta}{R}$, say $\frac{\gamma}{R} < kt < \frac{\delta}{R}$ where $k \in \mathbb{P}$. We then take $(u, v) = (Rkp, Rkq)$.

Case 3. The case in which $\gamma < \delta \leq 0$ is symmetrical. □

Remark 2.28. Consider two parallel lines of irrational slope, say \mathcal{L} and \mathcal{L}_0 . By Lemma 2.27 there is a lattice point $A_1 = (x_1, y_1)$ between \mathcal{L} and \mathcal{L}_0 with $x_1 \geq 1$. Now let \mathcal{L}_1 be the line parallel to \mathcal{L} through A_1 . By Lemma 2.27 again, there is a lattice point $A_2 = (x_2, y_2)$ between \mathcal{L} and \mathcal{L}_1 with $x_2 \geq x_1 + 1$. Continuing in this way, we obtain a sequence of lattice points $A_i = (x_i, y_i)$, $i \in \mathbb{P}$, satisfying $1 \leq x_1 < x_2 < x_3 < \dots$. Moreover, if we write δ_i ($i \in \mathbb{P}$) for the distance from \mathcal{L} to A_i , then we have $\delta_i > 0$ for all i , $\delta_1 > \delta_2 > \delta_3 > \dots$, and $\lim_{i \rightarrow \infty} \delta_i = 0$.

Example 2.29. Let \mathcal{L} be any line through the origin of irrational slope, let H be one of the (open) half-planes bounded by \mathcal{L} , and let $X = H \cap \mathbb{Z}^2$ be the set of all lattice points contained in H . Since H , and hence X , is closed under addition, we have $\mathcal{A}_X = \{O\} \cup X$, and also $\pi_X(O) = 1$. We claim that for any $A \in X = \mathcal{A}_X \setminus \{O\}$, there are arbitrarily long X -walks from O to A .

To prove the claim, let $A \in X$, and let $k \geq 2$ be arbitrary. We will show that there is an X -walk from O to A of length k (this is obviously true for $k = 1$ as well). Let $\mathcal{L}_0 = \mathcal{L}$, let \mathcal{L}_k be the line parallel to \mathcal{L} through A , and let $\mathcal{L}_1, \dots, \mathcal{L}_{k-1}$ be a sequence of distinct lines each parallel to \mathcal{L} such that \mathcal{L}_i is between \mathcal{L}_{i-1} and \mathcal{L}_{i+1} for each $1 \leq i \leq k-1$. All of this (and more information to follow) is pictured in Figure 11. By Lemma 2.27, we may choose lattice points $A_1, \dots, A_{k-1} \in \mathbb{Z}^2$ such that A_i is between \mathcal{L}_{i-1} and \mathcal{L}_i for each $1 \leq i \leq k-1$. Also define $A_0 = O$ and $A_k = A$. Let $B_i = A_i - A_{i-1}$ for each $1 \leq i \leq k$. The claim will be established if we can show that $B_1 \cdots B_k$ is an X -walk from O to A . Indeed, we certainly have $B_1 + \dots + B_k = A$, so it just remains to check that $B_i \in X$ for each i . But if \mathbf{u} is a vector perpendicular to \mathcal{L} pointing into H , we have $\mathbf{u} \cdot \overrightarrow{OA_{i-1}} < \mathbf{u} \cdot \overrightarrow{OA_i}$ for each $1 \leq i \leq k$ (by construction), from which it follows that $\mathbf{u} \cdot \overrightarrow{OB_i} = \mathbf{u} \cdot (\overrightarrow{OA_i} - \overrightarrow{OA_{i-1}}) > 0$ for each such i , giving $B_i \in H$, and so $B_i \in X$.

With the claim now established, there are two immediate consequences:

- $\pi_X(A) = \infty$ for all $A \in \mathcal{A}_X \setminus \{O\}$, and
- X does not have the BPP.

Since $\pi_X(O) = 1$, as mentioned above, it follows also that:

- X has neither the IPP nor the FPP.

In terms of the geometric conditions, first note that X satisfies the LC, as witnessed by \mathcal{L} itself. But, since there are points from X arbitrarily close to \mathcal{L} (by Lemma 2.27), it follows that no line parallel to \mathcal{L} witnesses the SLC. Since it is also clear that no other line (through the origin) witnesses the LC, it follows from Lemma 2.13(ii) that X does not satisfy the SLC. Combining this with Lemma 2.12(i), X does not satisfy the CC either.

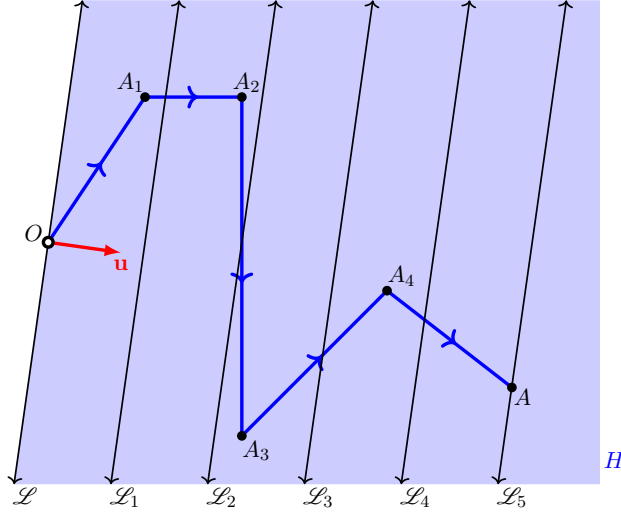

Figure 11: Schematic diagram of the proof of the claim in Example 2.29 (with $k = 5$).

2.5 Small step sets

In this section, we give a complete description of the additive monoids \mathcal{A}_X , and the numbers $\pi_X(A)$, when $X \subseteq \mathbb{Z}_\times^2$ is a step set of size at most 2. We begin with a lemma describing certain 2-generated submonoids of the additive group $(\mathbb{Z}, +)$; it follows from [22, Corollary II.4.2], but we include a direct proof for convenience. For $a_1, \dots, a_k \in \mathbb{Z}$, we will write $\text{Mon}\langle a_1, \dots, a_k \rangle$ for the submonoid of \mathbb{Z} generated by a_1, \dots, a_k . If $a, b \in \mathbb{Z}$, we write $a \mid b$ to indicate that a divides b (i.e., $b = ax$ for some $x \in \mathbb{Z}$); if a and b are not both zero, we write $\text{gcd}(a, b)$ for their greatest common divisor. Throughout this section, we use elementary number theoretic facts, as found for example in [28].

Lemma 2.30. *Let $a, b \in \mathbb{P}$, and put $d = \text{gcd}(a, b)$. Then $\text{Mon}\langle a, -b \rangle = \text{Mon}\langle \pm d \rangle$. In particular, $\text{Mon}\langle a, -b \rangle$ is a non-trivial subgroup of \mathbb{Z} , and is therefore isomorphic to $(\mathbb{Z}, +)$.*

Proof. Write $M = \text{Mon}\langle a, -b \rangle$. Now, $a = xd$ and $b = yd$ (so $-b = y(-d)$) for some $x, y \in \mathbb{P}$, so it follows immediately that $M \subseteq \text{Mon}\langle \pm d \rangle$. It therefore remains to show that $d, -d \in M$. In fact, it is enough to show that *either* of $d, -d$ belongs to M . Indeed, if $d \in M$, then we would also have $-d = -yd + (y-1)d = (-b) + (y-1)d \in \text{Mon}\langle -b, d \rangle \subseteq M$. The implication $-d \in M \Rightarrow d \in M$ is proved in similar fashion. Now,

$$d = ua + v(-b) \tag{2.31}$$

for some $u, v \in \mathbb{Z}$. If $u, v \geq 0$ or $u, v \leq 0$, then (2.31) would give $d \in M$ or $-d \in M$ (respectively), and in either case the proof would then be complete, by the above observation. We note that it is impossible to have $u \leq 0$ and $v \geq 0$ or else then (2.31) would give $d \leq 0$. Finally, suppose $u \geq 0$ and $v \leq 0$. We cannot have $u = v = 0$, since $d > 0$. Suppose first that $u \geq 1$. Together with $v \leq 0$, this gives $d = ua + v(-b) \geq 1a + 0(-b) = a$. Since also $d = \text{gcd}(a, b) \leq a$, it follows that $d = a \in M$. Similarly, if $v \leq -1$, then we would deduce that $d = b$, so that $-d = -b \in M$. \square

Recall that Euclid's Lemma states that if $a, b, c \in \mathbb{Z}$ are such that $\text{gcd}(a, b) = 1$, then $a \mid bc \Rightarrow a \mid c$.

Proposition 2.32. *Consider a step set $X \subseteq \mathbb{Z}_\times^2$.*

- (i) *If $X = \{A\}$, then $\mathcal{A}_X \cong (\mathbb{N}, +)$.*
- (ii) *If $X = \{A, B\}$ where $A \neq B$ and $\angle AOB = 0$, then \mathcal{A}_X is isomorphic to a 2-generated submonoid of $(\mathbb{N}, +)$.*
- (iii) *If $X = \{A, B\}$ where $\angle AOB = \pi$, then $\mathcal{A}_X \cong (\mathbb{Z}, +)$.*
- (iv) *If $X = \{A, B\}$ where $0 < \angle AOB < \pi$, then $\mathcal{A}_X \cong (\mathbb{N} \times \mathbb{N}, +)$.*

Proof. The first part being clear, for the duration of the proof, let $A = (a, b)$ and $B = (c, d)$ be distinct points from \mathbb{Z}_\times^2 .

(ii). Suppose $\angle AOB = 0$. So A and B both lie on the same side of the origin on a straight line, \mathcal{L} . If the line \mathcal{L} is $y = 0$, then clearly $\mathcal{A}_X = \text{Mon}\langle(a, 0), (c, 0)\rangle$ is isomorphic to the submonoid $\text{Mon}\langle a, c\rangle$ of \mathbb{N} if $a, c > 0$, or to $\text{Mon}\langle -a, -c\rangle$ if $a, c < 0$. A similar argument covers the case in which \mathcal{L} is $x = 0$. So suppose instead that \mathcal{L} has finite and non-zero gradient. Since the lattice points A, B lie on \mathcal{L} , its gradient must be rational, so we may assume \mathcal{L} has equation $y = \frac{m}{n}x$, where $m, n \in \mathbb{Z}$, $n \neq 0$ and $\frac{m}{n}$ is in reduced form (i.e., $\gcd(m, n) = 1$). Since $\angle AOB = 0$, we may further assume that n has the same sign as a and c . Since $A = (a, b)$ is on \mathcal{L} , we see (using Euclid's Lemma) that

$$b = \frac{m}{n}a \Rightarrow n \mid ma \Rightarrow n \mid a \Rightarrow a = kn \quad \text{for some } k \in \mathbb{P}.$$

So $A = (a, b) = k(n, m)$. Similarly, $B = l(n, m)$ for some $l \in \mathbb{P}$. But then clearly $\mathcal{A}_X = \text{Mon}\langle A, B\rangle$ is isomorphic to the submonoid $\text{Mon}\langle k, l\rangle$ of $(\mathbb{N}, +)$ generated by k, l .

(iii). Suppose $\angle AOB = \pi$. As in the previous case, the result is trivial if A, B both lie on $x = 0$ or $y = 0$. Otherwise, we may similarly show that $A = k(n, m)$ and $B = l(n, m)$ for some $m, n \in \mathbb{Z}$ with $\gcd(m, n) = 1$ and some non-zero $k, l \in \mathbb{Z}$, but this time k, l have opposite sign. It follows that $\mathcal{A}_X = \text{Mon}\langle A, B\rangle$ is isomorphic to $M = \text{Mon}\langle k, l\rangle$, the submonoid of $(\mathbb{Z}, +)$ generated by k, l , and the proof in this case concludes after applying Lemma 2.30.

(iv). Finally, suppose $0 < \angle AOB < \pi$. Now, $\mathcal{A}_X = \text{Mon}\langle A, B\rangle = \{kA + lB : k, l \in \mathbb{N}\}$, so it follows that the map

$$\phi : \mathbb{N} \times \mathbb{N} \rightarrow \mathcal{A}_X \quad \text{defined by} \quad \phi(k, l) = kA + lB$$

is a surmorphism. Injectivity of ϕ follows quickly from the linear independence of A and B . \square

Remark 2.33. We can say something about the values of $\pi_X(a, b)$ in the case that the step set X has one of the forms enumerated in Proposition 2.32:

(i) If $X = \{A\}$, then $\mathcal{A}_X \cong (\mathbb{N}, +)$, and $\pi_X(C) = 1$ for all $C \in \mathcal{A}_X$.

(ii) If $X = \{A, B\}$ where $A \neq B$ and $\angle AOB = 0$, then as in the above proof, we may assume that $A = kC$ and $B = lC$, where $k, l \in \mathbb{P}$, and $C \in \mathbb{Z}_X^2$ is some fixed point. Using Proposition 2.15, the numbers $a_n = \pi_X(nC)$, $n \in \mathbb{Z}$, satisfy

$$a_n = 0 \quad (n < 0), \quad a_0 = 1, \quad a_n = a_{n-k} + a_{n-l} \quad (n > 0).$$

Thus, for example, we obtain the Fibonacci sequence when $(k, l) = (1, 2)$, the Narayana's Cows sequence when $(k, l) = (1, 3)$, the Padovan sequence when $(k, l) = (2, 3)$, and so on; see [1, A000045, A000930 and A000931]. The study of submonoids of \mathbb{N} is a considerable topic, known as *numerical semigroup theory*; see for example [2, 32]. Submonoids of \mathbb{N}^2 (and more generally \mathbb{N}^k , $k \geq 2$) have been studied for example in [10], where the situation is rather more complicated. For example, every submonoid of \mathbb{N} is finitely generated, so there are only countably many of them (even up to isomorphism); but even \mathbb{N}^2 contains uncountably many pairwise non-isomorphic subdirect products [10, Theorem C].

(iii) If $X = \{A, B\}$ where $\angle AOB = \pi$, then $\mathcal{A}_X \cong (\mathbb{Z}, +)$, and clearly $\pi_X(C) = \infty$ for all $C \in \mathcal{A}_X$.

(iv) Finally, if $X = \{A, B\}$ where $0 < \angle AOB < \pi$, then $\mathcal{A}_X = \{xA + yB : x, y \in \mathbb{N}\} \cong (\mathbb{N} \times \mathbb{N}, +)$, and $\pi_X(xA + yB) = \binom{x+y}{x} = \binom{x+y}{y}$. This can be seen directly, or by applying Proposition 2.15: cf. Examples 2.1, 2.22 and 2.23.

Remark 2.34. One could readily classify step sets $X = \{A, B, C\} \subseteq \mathbb{Z}_X^2$ of size 3, although there are several more cases to consider. Some general results from the coming sections are useful to complete the classification.

2.6 Geometric, algebraic and combinatorial characterisations of the IPP

Recall that a *convex combination* of a finite collection of points $A_1, \dots, A_k \in \mathbb{R}^2$ is a point of the form $\lambda_1 A_1 + \dots + \lambda_k A_k$ where $\lambda_1, \dots, \lambda_k \geq 0$ and $\lambda_1 + \dots + \lambda_k = 1$. The *convex hull* of a (finite or infinite) subset $X \subseteq \mathbb{R}^2$, denoted $\text{Conv}(X)$, is the set of all convex combinations of (finite collections of) points from X . For background on basic convex geometry, see for example [8, Section 2].

The main result of this section shows that a step set X has the IPP if and only if the origin O is in the convex hull of X ; see Theorem 2.36 below, which also gives algebraic and combinatorial characterisations of the IPP in terms of the monoid \mathcal{A}_X and the graph Γ_X . First we need a lemma.

Lemma 2.35. *Suppose $A, B, C \in \mathbb{R}^2 \setminus \{O\}$ are such that A, B, C and O are not all collinear. If there exists scalars $\alpha, \beta, \gamma \in \mathbb{R}$ such that $\alpha + \beta + \gamma = 1$ and $\alpha A + \beta B + \gamma C = O$, then there exist unique such scalars.*

Proof. Write $\mathbf{a}, \mathbf{b}, \mathbf{c}, \mathbf{0}$ for the position vectors of A, B, C, O , respectively, noting that $\alpha \mathbf{a} + \beta \mathbf{b} + \gamma \mathbf{c} = \mathbf{0}$. By the non-collinear assumption, and renaming the points A, B, C if necessary, we may assume that \mathbf{a} and \mathbf{b} are linearly independent. First note that we must have $\gamma \neq 0$; otherwise, we would have $\alpha \mathbf{a} + \beta \mathbf{b} = \mathbf{0}$, giving $\alpha = \beta = 0$ (by linear independence), contradicting $\alpha + \beta + \gamma = 1$. It then follows that $\mathbf{c} = -\frac{\alpha}{\gamma} \mathbf{a} - \frac{\beta}{\gamma} \mathbf{b}$. Suppose now that $\alpha' A + \beta' B + \gamma' C = O$ where $\alpha' + \beta' + \gamma' = 1$. Then

$$\alpha' \mathbf{a} + \beta' \mathbf{b} = -\gamma' \mathbf{c} = -\gamma' \left(-\frac{\alpha}{\gamma} \mathbf{a} - \frac{\beta}{\gamma} \mathbf{b} \right) = \frac{\alpha \gamma'}{\gamma} \mathbf{a} + \frac{\beta \gamma'}{\gamma} \mathbf{b}.$$

It then follows (by linear independence) that $\alpha' = \frac{\alpha \gamma'}{\gamma}$ and $\beta' = \frac{\beta \gamma'}{\gamma}$. But then

$$1 = \alpha' + \beta' + \gamma' = \frac{\alpha \gamma'}{\gamma} + \frac{\beta \gamma'}{\gamma} + \gamma' = \frac{\gamma'}{\gamma} (\alpha + \beta + \gamma) = \frac{\gamma'}{\gamma},$$

so that $\gamma' = \gamma$. We deduce also that $\alpha' = \frac{\alpha \gamma'}{\gamma} = \alpha$ and $\beta' = \frac{\beta \gamma'}{\gamma} = \beta$. \square

Recall that an element of a monoid is a *unit* if it is invertible with respect to the identity of the monoid; the set of all units is a subgroup. Here are the promised characterisations of the IPP.

Theorem 2.36. *Let $X \subseteq \mathbb{Z}_X^2$ be an arbitrary step set. Then the following are equivalent:*

- (i) X has the IPP,
- (ii) $O \in \text{Conv}(X)$,
- (iii) \mathcal{A}_X has non-trivial units,
- (iv) Γ_X has non-trivial directed cycles.

Proof. (i) \Rightarrow (ii). If X has the IPP, then $O = A_1 + \dots + A_k$ for some $k \geq 1$ and some $A_1, \dots, A_k \in X$, in which case $O = \frac{1}{k} A_1 + \dots + \frac{1}{k} A_k \in \text{Conv}(X)$.

(ii) \Rightarrow (iii). Suppose $O \in \text{Conv}(X)$. So O is a convex combination of some non-empty collection of points A_1, \dots, A_k from X , and we assume that k is minimal, noting that $k \geq 2$. If $k = 2$, then $\angle A_1 O A_2 = \pi$, so $\pi_X(O) \geq \pi_{\{A_1, A_2\}}(O) = \infty$; cf. Remark 2.33(iii). So suppose now that $k \geq 3$. Then by minimality of k , $\text{Conv}(A_1, \dots, A_k)$ is a non-degenerate convex k -gon in \mathbb{R}^2 ; relabelling if necessary, we may assume the vertices of this polygon taken clockwise are A_1, \dots, A_k . Since the triangles $\triangle A_1 A_2 A_3, \triangle A_1 A_3 A_4, \dots, \triangle A_1 A_{k-1} A_k$ make up the whole polygon, we see that O lies in one of these triangles, say $\triangle A_1 A_{m-1} A_m$. (Incidentally, this shows that $k = 3$; cf. Carathéodory's Theorem [8, Corollary 2.4].) Write $A = A_1, B = A_{m-1}$ and $C = A_m$. Since $O \in \text{Conv}(A, B, C)$, we have

$$O = \alpha A + \beta B + \gamma C \quad \text{for some } \alpha, \beta, \gamma \in \mathbb{R} \text{ with } \alpha, \beta, \gamma \geq 0 \text{ and } \alpha + \beta + \gamma = 1. \quad (2.37)$$

By the minimality of $k \geq 3$, it follows that α, β, γ are all non-zero. Write $A = (a, b), B = (c, d), C = (e, f)$. So (2.37) gives

$$\alpha a + c\beta + e\gamma = 0, \quad b\alpha + d\beta + f\gamma = 0, \quad \alpha + \beta + \gamma = 1.$$

That is, $(x, y, z) = (\alpha, \beta, \gamma)$ is a solution to the system of linear equations

$$\alpha x + c y + e z = 0, \quad b x + d y + f z = 0, \quad x + y + z = 1. \quad (2.38)$$

Since $\triangle ABC$ is a non-degenerate triangle, certainly A, B, C, O are not all collinear, so Lemma 2.35 says that (2.38) has a *unique* solution. Since the solution is unique, it may be found by inverting the coefficient matrix $\begin{bmatrix} a & c & e \\ b & d & f \\ 1 & 1 & 1 \end{bmatrix}$; since this matrix has integer entries, its inverse has rational entries, and so the solution to (2.38) is rational; that is, α, β, γ are rational. Since we already know that $\alpha, \beta, \gamma > 0$, there exists $\delta \in \mathbb{P}$ such that $x = \alpha\delta, y = \beta\delta$ and $z = \gamma\delta$ are all (positive) integers. But then (2.37) gives $O = xA + yB + zC$, and since $x > 0$, it follows that A is a unit (with inverse $(x-1)A + yB + zC$).

(iii) \Rightarrow (iv). Suppose $A \in \mathcal{A}_X$ is a non-trivial unit, and let $B \in \mathcal{A}_X$ be its inverse. Write $A = A_1 + \dots + A_k$ and $B = B_1 + \dots + B_l$ where $k, l \geq 1$ and the A_i, B_i belong to X . Then the edges $A_1, \dots, A_k, B_1, \dots, B_l$ determine a directed cycle from O to O in Γ_X .

(iv) \Rightarrow (i). If $A \xrightarrow{B_1} A+B_1 \xrightarrow{B_2} \dots \xrightarrow{B_k} A$ is a non-trivial directed cycle in Γ_X , then $A = A+B_1+\dots+B_k$, which implies $O = B_1 + \dots + B_k$, and so $B_1 \dots B_k \in \Pi_X(O) \setminus \{\varepsilon\}$; Lemma 2.9 then says that X has the IPP. \square

Remark 2.39. Theorem 2.36 implies that Γ_X is a directed acyclic graph (DAG) if and only if X does not have the IPP.

Remark 2.40. One may compare Theorem 2.36 with the various examples considered in Sections 2.1 and 2.4. Of these, only the step sets from Examples 2.3 and 2.4 had the IPP, and these are of course the only step sets containing O in their convex hulls. But note that O is in the *closure* of the convex hulls of the step sets from Examples 2.26 and 2.29. Despite having this feature in common, the step sets from Examples 2.26 and 2.29 are very different. The step set from Example 2.26 has the FPP (as far away from the IPP as possible), while that from Example 2.29 has $\pi_X(A) = \infty$ for all $A \in \mathcal{A}_X \setminus \{O\}$ (as close to the IPP as possible without actually attaining it).

2.7 An implicational hierarchy

We have considered many examples of step sets so far in this paper, and these satisfy various combinations of the finiteness properties (FPP, IPP, BPP) and geometric conditions (CC, SLC, CC) defined in Sections 2.2 and 2.3. Theorem 2.44 below establishes a kind of “implicational hierarchy” of these properties and conditions, and thus limits the (ostensibly) possible combinations a step set could have; this idea will be explored in more detail in Sections 2.9 and 2.10.

We begin with two lemmas.

Lemma 2.41. *Let $X \subseteq \mathbb{Z}_x^2$ be an arbitrary step set.*

- (i) *If X satisfies the CC, then X has the FPP.*
- (ii) *If X satisfies the SLC, then X has the BPP.*
- (iii) *If X satisfies the LC, then X does not have the IPP.*

Proof. We prove the three items in reverse order.

(iii). Let \mathcal{L} be a line witnessing the LC, and let \mathbf{u} be a vector perpendicular to \mathcal{L} pointing into the half-plane containing X . So $\mathbf{u} \cdot \overrightarrow{OA} > 0$ for all $A \in X$. By linearity, it follows that $\mathbf{u} \cdot \overrightarrow{OA} > 0$ for all $A \in \mathcal{A}_X \setminus \{O\}$, and so there are no non-empty X -walks to O ; thus, $\pi_X(O) = 1$.

(ii). Let \mathcal{L} be a line witnessing the SLC, and let \mathbf{u} be a unit vector perpendicular to \mathcal{L} pointing towards the side of \mathcal{L} containing X . Let δ be the (perpendicular) distance from O to \mathcal{L} , noting that $\mathbf{u} \cdot \overrightarrow{OB} > \delta$ for all $B \in X$. Now let $A \in \mathcal{A}_X$ be arbitrary, and write $\lambda = \mathbf{u} \cdot \overrightarrow{OA}$. Consider an X -walk $w = B_1 \cdots B_k$ to A , where $B_1, \dots, B_k \in X$. Since $A = B_1 + \cdots + B_k$, we have

$$\lambda = \mathbf{u} \cdot \overrightarrow{OB_1} + \cdots + \mathbf{u} \cdot \overrightarrow{OB_k}. \quad (2.42)$$

Since $\mathbf{u} \cdot \overrightarrow{OB_i} > \delta$ for each i , it follows from (2.42) that $\lambda > k\delta$, and so $k < \frac{\lambda}{\delta}$. We have shown that the length of any X -walk to A is bounded by $\frac{\lambda}{\delta}$; since $A \in \mathcal{A}_X$ was arbitrary, it follows that X has the BPP.

(i). Let \mathcal{C} be a cone witnessing the CC, and suppose \mathcal{C} is bounded by the lines \mathcal{L}_1 and \mathcal{L}_2 . Let $C \in \mathcal{L}_1$ and $D \in \mathcal{L}_2$ be the points constructed during the proof of Lemma 2.11; cf. Figure 8. Let \mathcal{L} be the line through C and D , and note that \mathcal{L} witnesses the SLC. Let \mathbf{u} and δ be as in the proof of (ii) above, defined with respect to \mathcal{L} . Further, for $\mu \geq 0$ define the set $X_\mu = \{A \in X : \mathbf{u} \cdot \overrightarrow{OA} \leq \mu\}$. Now let $A \in \mathcal{A}_X$ be arbitrary. We must show that $\pi_X(A) < \infty$. Let $\lambda = \mathbf{u} \cdot \overrightarrow{OA}$, and suppose $w = B_1 \cdots B_k$ is an X -walk to A , where $B_1, \dots, B_k \in X$. It follows from (2.42), and the fact that each $\mathbf{u} \cdot \overrightarrow{OB_i} > 0$, that $\mathbf{u} \cdot \overrightarrow{OB_i} \leq \lambda$ for each i . That is, we must have $B_i \in X_\lambda$ for each i . As in the proof of (ii), we must also have $k < \frac{\lambda}{\delta}$. The proof of this part will therefore be complete if we can show that X_λ is finite. But if we write \mathcal{L}' for the line parallel to \mathcal{L} and λ units from O , then X_λ is contained in the triangle bounded by the lines \mathcal{L}_1 , \mathcal{L}_2 and \mathcal{L}' ; since this triangle has finite area, it follows that X_λ is finite, as required. \square

The next technical lemma concerns a special type of step set, namely one with no steps to the left of the y -axis. It will be used in the proof of the theorem following it, and also in Section 2.9. The first part of the lemma has already been used to establish the FPP in Examples 2.25 and 2.26.

Lemma 2.43. Consider a step set $X \subseteq \mathbb{N} \times \mathbb{Z}$. For $k \in \mathbb{N}$ define the sets $Y_k = \{y \in \mathbb{Z} : (k, y) \in X\}$, $Y_k^+ = Y_k \cap \mathbb{P}$ and $Y_k^- = Y_k \cap (-\mathbb{P})$.

(i) If $Y_0^+ = \emptyset$, and if Y_k^+ is finite for each $k \in \mathbb{P}$, then X has the FPP.

(ii) If $Y_0^- \neq \emptyset$, and if Y_k^+ is infinite for some $k \in \mathbb{P}$, then X does not have the BPP.

Proof. (i). For $k \in \mathbb{N}$, let $X_k = \{k\} \times Y_k$ be the set of all steps from X with x -coordinate k . Let $A = (a, b) \in \mathcal{A}_X$ be arbitrary. Fix some $w \in \Pi_X(A)$, and write $w = A_1 \cdots A_l$, where each $A_i = (x_i, y_i)$ belongs to X . For all i , we have $a = x_1 + \cdots + x_l \geq x_i \geq 0$, so that each A_i belongs to the subset $Z = X_0 \cup X_1 \cup \cdots \cup X_a$ of X . This means that $\Pi_X(A) = \Pi_Z(A)$. Let $m = \max(Y_1^+ \cup \cdots \cup Y_a^+)$; this is well defined by assumption. Then the lines with equations $y = (m+1)x$ and $y = (m+2)x$ both witness the LC for Z (see Figure 12, which only pictures the line $y = (m+1)x$); hence, these lines together witness the CC for Z ; it follows from Lemma 2.41(i) that Z has the FPP. Thus, $\pi_X(A) = \pi_Z(A) < \infty$, as required.

(ii). Let $A = (0, -n)$ where $-n \in Y_0^-$ where $n \in \mathbb{P}$, and fix some $k \in \mathbb{P}$ such that Y_k^+ is infinite. For each $i \in \{0, 1, \dots, n-1\}$, let $Y_{k,i}^+ = \{y \in Y_k^+ : y \equiv i \pmod{n}\}$. Since Y_k^+ is infinite, at least one of these subsets must be infinite, say $Y_{k,i}^+$. Write $Y_{k,i}^+ = \{i + b_1 n, i + b_2 n, \dots\}$, where $b_1 < b_2 < \dots$. For each $p \in \mathbb{N}$, let $B_p = (k, i + b_p n) \in X$. But then for any $p \in \mathbb{N}$ we have $B_p + b_p A = (k, i)$, meaning that $B_p A^{b_p} \in \Pi_X(k, i)$. Since $\ell(B_p A^{b_p}) = 1 + b_p$, this shows that X does not have the BPP. \square

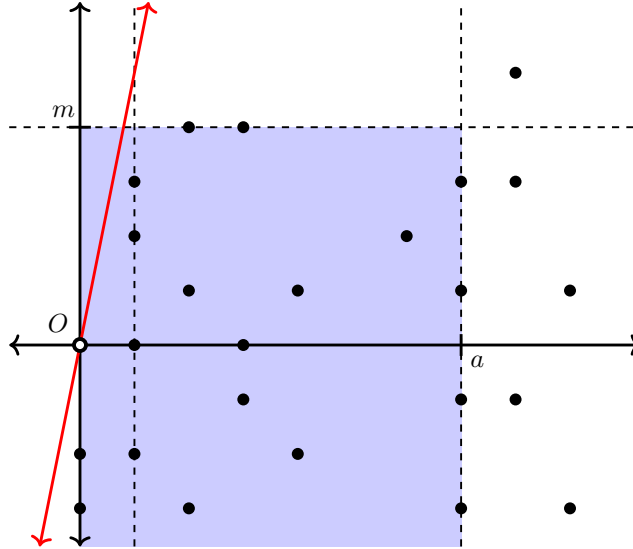

Figure 12: Schematic diagram of the proof of Lemma 2.43(i). The (closed) blue region contains Z , and the line $y = (m+1)x$ is indicated in red.

Theorem 2.44. (i) For an arbitrary step set $X \subseteq \mathbb{Z}_{\times}^2$, we have:

$$\begin{array}{ccccc}
 CC & \Rightarrow & SLC & \Rightarrow & LC \\
 \Downarrow & & \Downarrow & & \Downarrow \\
 FPP & \Rightarrow & BPP & \Rightarrow & \neg IPP
 \end{array} \tag{2.45}$$

(ii) For an arbitrary finite step set $X \subseteq \mathbb{Z}_{\times}^2$, all of the implications in (2.45) are reversible; that is, we have:

$$\begin{array}{ccccc}
 CC & \Leftrightarrow & SLC & \Leftrightarrow & LC \\
 \Updownarrow & & \Updownarrow & & \Updownarrow \\
 FPP & \Leftrightarrow & BPP & \Leftrightarrow & \neg IPP
 \end{array}$$

(iii) In general, none of the implications in (2.45) are reversible.

Proof. (i). These implications were proved in Lemmas 2.10, 2.12 and 2.41.

(ii). Let $X \subseteq \mathbb{Z}_x^2$ be a finite step set. In light of the previous part, it suffices to show that $\neg\text{IPP} \Rightarrow \text{CC}$; in fact, by Lemma 2.12(iii), it is enough to show that $\neg\text{IPP} \Rightarrow \text{LC}$. With this in mind, suppose X does not have the IPP. We must show that X satisfies the LC. This is obvious if X is empty, so suppose otherwise.

Pick an arbitrary point $A \in X$, and let \mathcal{L}_1 be the line through O and A ; note that O splits \mathcal{L}_1 into two open half-lines, \mathcal{L}'_1 and \mathcal{L}''_1 say, where $A \in \mathcal{L}'_1$. Since X does not have the IPP, Theorem 2.36 gives $X \cap \mathcal{L}''_1 = \emptyset$. If X is contained in \mathcal{L}_1 , then X is contained in \mathcal{L}'_1 and so clearly X satisfies the LC. Thus, for the remainder of the proof we assume X is not contained in \mathcal{L}_1 , and we fix some $B \in X \setminus \mathcal{L}_1$. Let \mathcal{L}_2 be the line through O and B , and let \mathcal{L}'_2 and \mathcal{L}''_2 be the half-lines split by O , with $B \in \mathcal{L}'_2$, and note again that $X \cap \mathcal{L}''_2 = \emptyset$. All this is shown in Figure 13 (left).

The lines \mathcal{L}_1 and \mathcal{L}_2 define four (open) cones, which we label \mathcal{C}_i ($i = 1, 2, 3, 4$) as also indicated in Figure 13 (left). If $X \cap \mathcal{C}_3 \neq \emptyset$, say with $C \in X \cap \mathcal{C}_3$, then we would have $O \in \text{Conv}\{A, B, C\} \subseteq \text{Conv}(X)$, contradicting Theorem 2.36, so we have $X \cap \mathcal{C}_3 = \emptyset$.

If $X \cap \mathcal{C}_2$ and $X \cap \mathcal{C}_4$ are both empty, then clearly X satisfies the LC, so suppose this is not the case. By symmetry, we assume that $X \cap \mathcal{C}_2 \neq \emptyset$. Let $C \in X \cap \mathcal{C}_2$ be such that $\angle BOC$ is maximal among all points from $X \cap \mathcal{C}_2$. Let \mathcal{L}_3 be the line through O and C , again split into two half-lines \mathcal{L}'_3 and \mathcal{L}''_3 by O , with $C \in \mathcal{L}'_3$. Again we have $X \cap \mathcal{L}''_3 = \emptyset$. The line \mathcal{L}_3 splits \mathcal{C}_2 and \mathcal{C}_4 into (open) cones $\mathcal{C}'_2, \mathcal{C}''_2$ and $\mathcal{C}'_4, \mathcal{C}''_4$ as shown in Figure 13 (middle).

By the maximality of $\angle BOC$, we have $X \cap \mathcal{C}''_2 = \emptyset$. If $X \cap \mathcal{C}''_4 \neq \emptyset$, say with $D \in X \cap \mathcal{C}''_4$, then we would have $O \in \text{Conv}\{B, C, D\} \subseteq \text{Conv}(X)$, again contradicting Theorem 2.36, so we have $X \cap \mathcal{C}''_4 = \emptyset$. If also $X \cap \mathcal{C}'_4 = \emptyset$, then clearly X satisfies the LC, so suppose this is not the case. Let $D \in X \cap \mathcal{C}'_4$ be such that $\angle AOD$ is maximal among all points from $X \cap \mathcal{C}'_4$. Then the line \mathcal{L} bisecting \mathcal{L}''_3 and \overrightarrow{OD} witnesses the LC; cf. Figure 13 (right).

(iii). The step set considered in Example 2.25 satisfies the SLC but not the CC; this shows that $\text{SLC} \not\Rightarrow \text{CC}$ in general. Similarly, Example 2.29 shows that $\text{LC} \not\Rightarrow \text{SLC}$ and also that $\neg\text{IPP} \not\Rightarrow \text{BPP}$, while Example 2.5 shows that $\text{BPP} \not\Rightarrow \text{FPP}$. This takes care of the ‘‘horizontal’’ implications in (2.45). The ‘‘vertical’’ implications may be treated all at once by noting that the step set from Example 2.26 has the FPP (as follows from Lemma 2.43(i)) but does not satisfy the LC. \square

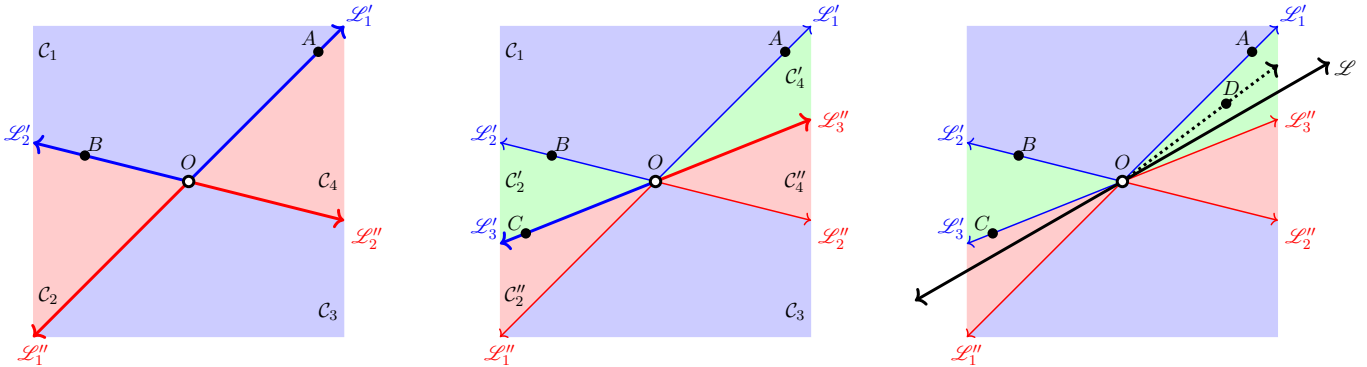

Figure 13: The points A, B, C, D and lines $\mathcal{L}_1, \mathcal{L}_2, \mathcal{L}_3, \mathcal{L}$ constructed during the proof of Theorem 2.44(ii).

The following simple consequence of Theorem 2.44(ii) seems worth singling out; it gives a natural dichotomy for finite step sets.

Corollary 2.46. *If $X \subseteq \mathbb{Z}_x^2$ is an arbitrary finite step set, then X has either the FPP or the IPP.* \square

2.8 Groups

Theorem 2.36 shows (among other things) that for a step set $X \subseteq \mathbb{Z}_x^2$, the monoid \mathcal{A}_X contains non-trivial units if and only if the origin O is contained in $\text{Conv}(X)$, the convex hull of X . In this section, we show that a stronger condition than $O \in \text{Conv}(X)$ characterises the step sets for which \mathcal{A}_X is a group (i.e., all elements of \mathcal{A}_X are units). Note that \mathcal{A}_X can contain non-trivial units without being a group; for instance, if X is the step set from Example 2.4, then $\mathcal{A}_X = \mathbb{N} \times \mathbb{Z}$ has group of units $\{0\} \times \mathbb{Z}$ (cf. Figure 3 (right)), but note that O is on the boundary of $\text{Conv}(X)$ in this example.

In what follows, for an arbitrary subset U of \mathbb{R}^2 , we write \bar{U} and $\text{Rel-Int}(U)$ for the *closure* and *relative interior* of U , respectively. (We use the *relative interior*, because we wish to speak of sets such as $\text{Rel-Int}(\text{Conv}(A, B))$ for distinct points $A, B \in \mathbb{R}^2$, which consists of all points on the line segment strictly between A and B , whereas the interior of $\text{Conv}(A, B)$ is empty.)

Lemma 2.47. *Let $X \subseteq \mathbb{Z}_\times^2$ be an arbitrary step set, and let $A \in X$. If there exist (not necessarily distinct) points $B, C \in X$ such that $O \in \text{Rel-Int}(\text{Conv}(A, B, C))$, then A is a unit of \mathcal{A}_X .*

Proof. First we consider the case that $B = C$. Since $O \in \text{Rel-Int}(\text{Conv}(A, B))$, we have $\angle AOB = \pi$. By Proposition 2.32(iii), the submonoid of \mathcal{A}_X generated by $\{A, B\}$ is a group; in particular, A is invertible in this submonoid, and hence in \mathcal{A}_X itself.

From now on, we assume that $B \neq C$. Following the proof of Theorem 2.36, we have $O = xA + yB + zC$ where $x, y, z \in \mathbb{N}$ are not all zero. If $x \neq 0$, then it immediately follows that A is invertible (with inverse $(x-1)A + yB + zC$). If $x = 0$, then $O \in \text{Rel-Int}(\text{Conv}(B, C))$, and so B and C must be on a line \mathcal{L} through O , with O in between; in this case, since $O \in \text{Rel-Int}(\text{Conv}(A, B, C))$, A must also lie on \mathcal{L} (or else O would be on the boundary of $\text{Conv}(A, B, C)$). But then O belongs either to $\text{Rel-Int}(\text{Conv}(A, B))$ or to $\text{Rel-Int}(\text{Conv}(A, C))$. As in the first paragraph it follows that A is a unit. \square

For the next statement, we say a step set $X \subseteq \mathbb{Z}_\times^2$ satisfies the *Weak Line Condition* (WLC) if it is contained in the closure of a half-plane determined by a line through the origin. Clearly the LC implies the WLC. The converse does not hold in general, as shown by the step set in Example 2.4.

Theorem 2.48. *Let $X \subseteq \mathbb{Z}_\times^2$ be an arbitrary step set.*

- (i) *If X is empty, then \mathcal{A}_X is a trivial group.*
- (ii) *If X is non-empty, and is contained in a line \mathcal{L} through the origin, then \mathcal{A}_X is a group if and only if X contains points from \mathcal{L} on both sides of the origin; in this case, \mathcal{A}_X is isomorphic to $(\mathbb{Z}, +)$.*
- (iii) *If X is not contained in any line through the origin, then \mathcal{A}_X is a group if and only if X does not satisfy the WLC; in this case, \mathcal{A}_X is isomorphic to $(\mathbb{Z}^2, +)$.*

Proof. By standard algebraic facts, any subgroup G of $(\mathbb{Z}^d, +)$ is isomorphic to $(\mathbb{Z}^d, +)$, where d is the dimension of the vector space spanned by G . Thus, with (i) being clear, it suffices to prove the “if and only if” statements in (ii) and (iii).

(ii). Suppose $X \neq \emptyset$ is contained in a line \mathcal{L} through O , which splits \mathcal{L} into two open half-lines \mathcal{L}' and \mathcal{L}'' .

If X is contained in \mathcal{L}' say, then X clearly satisfies the LC, and hence does not have the IPP, by Theorem 2.44(i); but then Theorem 2.36 says that \mathcal{A}_X has no non-trivial units; since $X \neq \emptyset$, it follows that \mathcal{A}_X is not a group.

To prove the other implication, suppose X contains points from both \mathcal{L}' and \mathcal{L}'' . To prove \mathcal{A}_X is a group, it suffices to show that all elements of X are invertible. So let $A \in X$ be arbitrary. Renaming if necessary, we may assume that $A \in \mathcal{L}'$. By assumption, there exists $B \in X \cap \mathcal{L}''$. But then $O \in \text{Rel-Int}(\text{Conv}(A, B))$, and hence A is a unit by Lemma 2.47.

(iii). Suppose X is not contained in any line through the origin.

First suppose X satisfies the WLC, as witnessed by a line \mathcal{L} through the origin. Let \mathbf{u} be a vector perpendicular to \mathcal{L} , pointing towards the half-plane containing points from X (exactly one such half-plane does contain points from X , as X is not contained in \mathcal{L}). The WLC says that $\mathbf{u} \cdot \overrightarrow{OA} \geq 0$ for all $A \in X$; by linearity, it follows that $\mathbf{u} \cdot \overrightarrow{OA} \geq 0$ for all $A \in \mathcal{A}_X$. Since X is not contained in \mathcal{L} , there exists $B \in X$ such that $\mathbf{u} \cdot \overrightarrow{OB} > 0$. But then for any $A \in \mathcal{A}_X$, we have $\mathbf{u} \cdot (\overrightarrow{OA} + \overrightarrow{OB}) \geq \mathbf{u} \cdot \overrightarrow{OB} > 0$, so that $A + B \neq O$; this shows that B is not invertible, and hence \mathcal{A}_X is not a group.

Conversely, suppose X does not satisfy the WLC. We must show that \mathcal{A}_X is a group. To do so, it suffices to show that each element of X is a unit. With this in mind, fix some $A \in X$. Let \mathcal{L} be the line through O and A , split by O into two open half-lines \mathcal{L}' and \mathcal{L}'' with $A \in \mathcal{L}'$. If $X \cap \mathcal{L}'' \neq \emptyset$, then again $O \in \text{Rel-Int}(\text{Conv}(A, B))$ for any $B \in X \cap \mathcal{L}''$, and Lemma 2.47 says that A is invertible. From now on we assume that $X \cap \mathcal{L}'' = \emptyset$.

Let the two (open) half-planes bounded by \mathcal{L} be H_1 and H_2 , as shown in Figure 14 (left). Since X does not satisfy the WLC, $X \cap H_1$ and $X \cap H_2$ are both non-empty. Let

$$\beta = \sup\{\angle AOB : B \in X \cap H_1\} \quad \text{and} \quad \gamma = \sup\{\angle AOC : C \in X \cap H_2\}.$$

Here $\angle AOB$ and $\angle AOC$ denote non-reflex angles, and we note that β, γ are well defined since the relevant sets are bounded above by π ; this also guarantees that $0 < \beta, \gamma \leq \pi$. Either there exists $B \in X \cap H_1$ such that $\angle AOB = \beta$ or else there is a sequence of points $B_1, B_2, \dots \in X \cap H_1$ such that $\lim_{n \rightarrow \infty} \angle AOB_n = \beta$; if $\beta = \pi$, then the latter must be the case. A similar statement holds for γ .

Fix arbitrary points $P \in H_1 \cup \mathcal{L}''$ and $Q \in H_2 \cup \mathcal{L}''$ such that $\angle AOP = \beta$ and $\angle AOQ = \gamma$. (Note that P and Q need not belong to X , or even to \mathbb{Z}^2 . Note also that we would need $P \in \mathcal{L}''$ if $\beta = \pi$, with a similar statement for Q .) Let \mathcal{L}_1 be the line through O and P , split by O into open half-lines \mathcal{L}'_1 and \mathcal{L}''_1 with $P \in \mathcal{L}'_1$. Let \mathcal{L}_2 be the line through O and Q , split by O into open half-lines \mathcal{L}'_2 and \mathcal{L}''_2 with $Q \in \mathcal{L}'_2$. This is all shown in Figure 14 (middle). The half-lines $\mathcal{L}'_1, \mathcal{L}'_2$ bound three open regions, which we denote by R_1, R_2, R_3 as also indicated in Figure 14 (middle). (These regions are either cones or half-planes, depending on whether β and/or γ equals π ; note that $R_3 = \emptyset$ if $\beta = \gamma = \pi$.)

By construction, X is contained in $\mathbb{R}^2 \setminus R_3$. Thus, since X does not satisfy the WLC, we must have $\beta + \gamma > \pi$. For convenience, let $\delta = (\beta + \gamma) - \pi$, so $\delta > 0$. As noted above, there exist points $B \in X \cap (R_1 \cup \mathcal{L}'_1)$ and $C \in X \cap (R_2 \cup \mathcal{L}'_2)$ such that $\angle AOB > \beta - \frac{\delta}{2}$ and $\angle AOC > \gamma - \frac{\delta}{2}$; write $\beta' = \angle AOB$ and $\gamma' = \angle AOC$. This is all pictured in Figure 14 (right). Then $\beta' + \gamma' > \beta + \gamma - \delta = \pi$. Together with $\beta' < \pi$ and $\gamma' < \pi$ (which follow from $B \in H_1$ and $C \in H_2$), it follows that $O \in \text{Rel-Int}(\text{Conv}(A, B, C))$, and so A is a unit by Lemma 2.47. \square

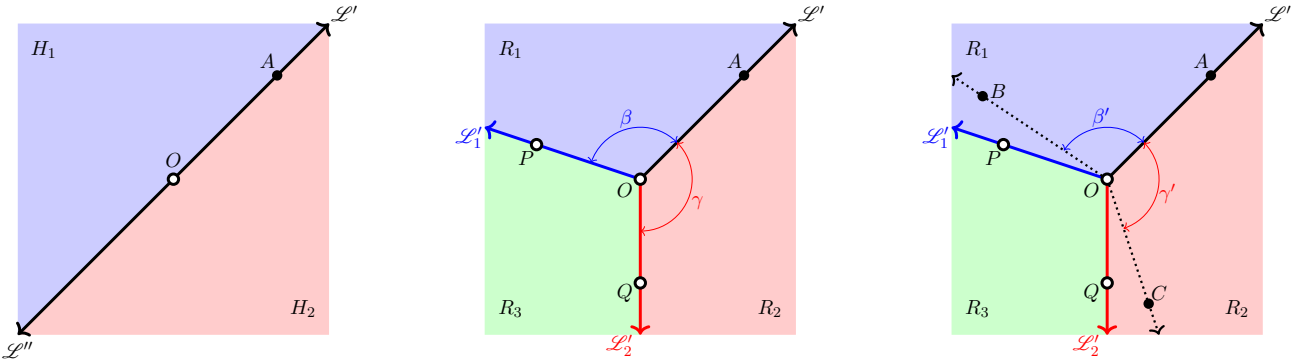

Figure 14: The points A, B, C, P, Q and lines $\mathcal{L}, \mathcal{L}_1, \mathcal{L}_2$ constructed during the proof of Theorem 2.48(iii).

Remark 2.49. For an arbitrary step set X , the implications from Theorem 2.44(i) may be extended as follows:

$$\begin{array}{ccccccc}
 \text{CC} & \Rightarrow & \text{SLC} & \Rightarrow & \text{LC} & \Rightarrow & \text{WLC} \\
 \downarrow & & \downarrow & & \downarrow & & \updownarrow \\
 \text{FPP} & \Rightarrow & \text{BPP} & \Rightarrow & \neg\text{IPP} & \Rightarrow & \mathcal{A}_X \cong (\mathbb{Z}^2, +)
 \end{array}$$

Indeed:

- (i) $\text{LC} \Rightarrow \text{WLC}$ has already been mentioned and is obvious.
- (ii) $\neg\text{IPP} \Rightarrow \mathcal{A}_X \cong (\mathbb{Z}^2, +)$ follows from Theorem 2.36.
- (iii) $\text{WLC} \Rightarrow \mathcal{A}_X \cong (\mathbb{Z}^2, +)$ follows from all three parts of Theorem 2.48: if X satisfies the WLC, then either X is empty, or is non-empty but contained in a line through O , or is not contained in any such line; in all three cases, \mathcal{A}_X is either not a group, a trivial group, or else a group isomorphic to $(\mathbb{Z}, +)$.
- (iv) $\neg\text{WLC} \Rightarrow \mathcal{A}_X \cong (\mathbb{Z}^2, +)$ holds, since if X does not satisfy the WLC, then certainly X is not contained in any line through O , in which case Theorem 2.48(iii) says that $\mathcal{A}_X \cong (\mathbb{Z}^2, +)$.

The implications (i) and (ii) are not reversible in general, even for finite X ; consider Example 2.4 and Proposition 2.32(iii), respectively.

Remark 2.50. If a step set X satisfies the WLC but not the LC, and is not contained in a line through O , then the structure of \mathcal{A}_X could be simple or complicated. For example, if $X = \{N, E, S\}$ as in Example 2.4, then $\mathcal{A}_X = \mathbb{N} \times \mathbb{Z}$. But if $U \subseteq \mathbb{P}$ is arbitrary, then with $X = \{N, S\} \cup \{(u, 0) : u \in U\}$ we have $\mathcal{A}_X = M \times \mathbb{Z}$

where $M = \text{Mon}\langle U \rangle$ is the submonoid of \mathbb{N} generated by U ; we have already noted that the study of such monoids is a considerable topic [2, 32]. It is not hard to devise more complicated examples.

Here is an alternative characterisation of step sets X for which \mathcal{A}_X is a group. In the proof, we write $\text{Int}(U)$ for the (ordinary) interior of a subset U of \mathbb{R}^2 . It is a basic fact that $U_1 \subseteq U_2$ implies $\text{Int}(U_1) \subseteq \text{Int}(U_2)$, although this does not hold for *relative* interiors.

Theorem 2.51. *Let $X \subseteq \mathbb{Z}_X^2$ be an arbitrary non-empty step set. Then \mathcal{A}_X is a group if and only if $O \in \text{Rel-Int}(\text{Conv}(X))$.*

Proof. We split the proof up into three cases.

Case 1. Suppose first that X is contained in some line \mathcal{L} through O . Then by Theorem 2.48(ii), \mathcal{A}_X is a group if and only if X contains points from \mathcal{L} on both sides of O ; since $X \subseteq \mathcal{L}$, this latter condition is clearly equivalent to $O \in \text{Rel-Int}(\text{Conv}(X))$.

Case 2. Next suppose X is contained in some line \mathcal{L} not through O . Then the line through O parallel to \mathcal{L} witnesses the LC. It follows from Theorem 2.44(i) that X does not have the IPP, and then from Theorem 2.36 that \mathcal{A}_X contains no non-trivial units; since X is non-empty we deduce that \mathcal{A}_X is not a group. Since X does not have the IPP, Theorem 2.36 also tells us that $O \notin \text{Conv}(X)$, so certainly $O \notin \text{Rel-Int}(\text{Conv}(X))$.

Case 3. Finally, suppose X is not contained in any line. This means that X is two-dimensional, and so too therefore is $\text{Conv}(X)$; consequently, we have $\text{Rel-Int}(\text{Conv}(X)) = \text{Int}(\text{Conv}(X))$.

Suppose first that \mathcal{A}_X is not a group. Then by Theorem 2.48(iii), X satisfies the WLC, so that $X \subseteq \overline{H}$ for some (open) half-plane H bounded by a line through O . But then

$$\text{Rel-Int}(\text{Conv}(X)) = \text{Int}(\text{Conv}(X)) \subseteq \text{Int}(\text{Conv}(\overline{H})) = \text{Int}(\overline{H}) = H.$$

Since $O \notin H$, it follows that $O \notin \text{Rel-Int}(\text{Conv}(X))$.

Conversely, suppose \mathcal{A}_X is a group. Then by Theorem 2.48(iii), X does not satisfy the WLC. Let $A \in X$ be arbitrary, and let \mathcal{L} be the line through O and A , split into \mathcal{L}' and \mathcal{L}'' by O , with $A \in \mathcal{L}'$. If $X \cap \mathcal{L}'' = \emptyset$, then as in the proof of Theorem 2.48(iii), O is in the interior of the (non-degenerate) triangle $\triangle ABC = \text{Conv}(A, B, C)$ for some $B, C \in X$, and so

$$O \in \text{Int}(\text{Conv}(A, B, C)) \subseteq \text{Int}(\text{Conv}(X)) = \text{Rel-Int}(\text{Conv}(X)).$$

Suppose now that $X \cap \mathcal{L}'' \neq \emptyset$, say with $D \in X \cap \mathcal{L}''$; see Figure 15. Let the half-planes bounded by \mathcal{L} be H_1 and H_2 . Since X does not satisfy the WLC, there exist $E \in X \cap H_1$ and $F \in X \cap H_2$. But then the (non-degenerate) triangles $\triangle ADE = \text{Conv}(A, D, E)$ and $\triangle ADF = \text{Conv}(A, D, F)$ are both contained in $\text{Conv}(A, D, E, F)$. Since O is on the common side of these two triangles, we have

$$O \in \text{Int}(\text{Conv}(A, D, E, F)) \subseteq \text{Int}(\text{Conv}(X)) = \text{Rel-Int}(\text{Conv}(X)). \quad \square$$

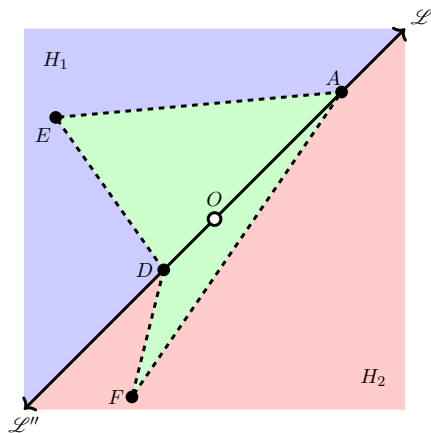

Figure 15: The points A, D, E, F and line \mathcal{L} constructed during the proof of Theorem 2.51.

Remark 2.52. One may compare Theorems 2.48 and 2.51 with the various examples considered in Sections 2.1 and 2.4. In particular, for the step set X from Example 2.4, O belongs to $\text{Conv}(X)$ but not to $\text{Rel-Int}(\text{Conv}(X))$; the monoid \mathcal{A}_X has non-trivial units but is not a group, and X satisfies the WLC.

2.9 Possible combinations of finiteness properties and geometric conditions

Theorem 2.44(i) describes a kind of hierarchy among the various geometric conditions (CC, SLC, LC) and finiteness properties (FPP, BPP, \neg IPP) associated to step sets. Specifically, the implications in (2.45) restrict the possible combinations of these conditions/properties that a given step set could have. For a step set $X \subseteq \mathbb{Z}_x^2$, consider the 2×3 matrix of Y's and N's indicating whether X has each of these conditions/properties:

$$\begin{bmatrix} \text{CC?} & \text{SLC?} & \text{LC?} \\ \text{FPP?} & \text{BPP?} & \neg\text{IPP?} \end{bmatrix} \quad (2.53)$$

Ostensibly, by Theorem 2.44(i), there are ten possibilities, and these are all enumerated in Table 1. Of course (I) and (X) are the only combinations that can actually occur for finite step sets, by Theorem 2.44(ii). Intriguingly, it turns out that for infinite X , *all but one* of combinations (II)–(IX) can occur as well. We show in Proposition 2.60 below that combination (VIII) can never occur. Some of the remaining combinations have already been seen in various examples considered so far; the others will be covered by further examples in this section and the next; see the final column of Table 1 for the locations of such examples. Combination (V) is the most involved of all, and will be treated separately in Section 2.10, using a clever construction communicated to us by Stewart Wilcox.

Label	Combination	Occurs?	Reference
(I)	$\begin{bmatrix} \text{Y} & \text{Y} & \text{Y} \\ \text{Y} & \text{Y} & \text{Y} \end{bmatrix}$	Yes	Example 2.1
(II)	$\begin{bmatrix} \text{N} & \text{Y} & \text{Y} \\ \text{Y} & \text{Y} & \text{Y} \end{bmatrix}$	Yes	Example 2.25
(III)	$\begin{bmatrix} \text{N} & \text{Y} & \text{Y} \\ \text{N} & \text{Y} & \text{Y} \end{bmatrix}$	Yes	Example 2.5
(IV)	$\begin{bmatrix} \text{N} & \text{N} & \text{Y} \\ \text{Y} & \text{Y} & \text{Y} \end{bmatrix}$	Yes	Example 2.55
(V)	$\begin{bmatrix} \text{N} & \text{N} & \text{Y} \\ \text{N} & \text{Y} & \text{Y} \end{bmatrix}$	Yes	Example 2.70
(VI)	$\begin{bmatrix} \text{N} & \text{N} & \text{Y} \\ \text{N} & \text{N} & \text{Y} \end{bmatrix}$	Yes	Example 2.29
(VII)	$\begin{bmatrix} \text{N} & \text{N} & \text{N} \\ \text{Y} & \text{Y} & \text{Y} \end{bmatrix}$	Yes	Example 2.26
(VIII)	$\begin{bmatrix} \text{N} & \text{N} & \text{N} \\ \text{N} & \text{Y} & \text{Y} \end{bmatrix}$	No	Proposition 2.60
(IX)	$\begin{bmatrix} \text{N} & \text{N} & \text{N} \\ \text{N} & \text{N} & \text{Y} \end{bmatrix}$	Yes	Example 2.54
(X)	$\begin{bmatrix} \text{N} & \text{N} & \text{N} \\ \text{N} & \text{N} & \text{N} \end{bmatrix}$	Yes	Example 2.3

Table 1: The combinations of finiteness properties and geometric conditions on step sets that are ostensibly possible after taking Theorem 2.44(i) into account; cf. (2.53).

Here is a step set with combination (IX):

Example 2.54. It is easy to check that the step set $X = \{(0, -1)\} \cup (\{1\} \times \mathbb{N})$ does not satisfy the LC. By Lemma 2.43(ii) X does not have the BPP, and by Theorem 2.36 it does not have the IPP.

Here is a step set with combination (IV):

Example 2.55. For $p \in \mathbb{N}$, let \mathcal{L}_p and \mathcal{L}'_p be the lines with equations $y = \sqrt{2}(x - \sqrt{2}p)$ and $y = -\sqrt{2}p$, respectively. (Any irrational number greater than 1 could be used in place of $\sqrt{2}$.) For $p \in \mathbb{N}$, let R_p be the

open region bounded by the lines \mathcal{L}_p and \mathcal{L}_{p+1} . For $p, q \in \mathbb{N}$, let $R_{p,q}$ be the open region bounded by the lines $\mathcal{L}_p, \mathcal{L}_{p+1}, \mathcal{L}'_q$ and \mathcal{L}'_{q+1} . So the sets $R_{p,q}, p, q \in \mathbb{N}$, are congruent (open) rhombuses, and they each contain at least one lattice point (as their height and base-length are both greater than 1); for each $p, q \in \mathbb{N}$ we fix one such point $A_{p,q} \in \mathbb{Z}^2 \cap R_{p,q}$. We now define the step set

$$X = X_1 \cup X_2 \quad \text{where} \quad X_1 = R_0 \cap \mathbb{P}^2 \quad \text{and} \quad X_2 = \{A_{p,p^2} : p \in \mathbb{N}\}.$$

This is all shown in Figure 16. We claim that:

- (i) X satisfies the LC,
- (ii) X does not satisfy the SLC,
- (iii) X has the FPP.

Clearly \mathcal{L}_0 witnesses the LC, so (i) is true. For (ii), first note that the line $x = 0$ obviously does not witness the LC (note that $A_{2,4} = (-1, -6)$ is to the left of $x = 0$; cf. Figure 16). Now consider the line \mathcal{L} with equation $y = \alpha x$, where α is any real number other than $\sqrt{2}$. If $\alpha > \sqrt{2}$, then all of X_1 is to the right of \mathcal{L} , and infinitely many points from X_2 are to the left (as the points from X_2 approximately trace a kind of “skew parabola”). If $0 \leq \alpha < \sqrt{2}$, then all of X_2 is below \mathcal{L} , and infinitely many points from X_1 are above (cf. Lemma 2.27 and Remark 2.28). If $\alpha < 0$, then all of X_1 is above \mathcal{L} , and infinitely many points from X_2 are below. It follows that \mathcal{L}_0 is the only line witnessing the LC. Since X_1 contains points arbitrarily close to \mathcal{L}_0 (again, cf. Lemma 2.27 and Remark 2.28) no line parallel to \mathcal{L}_0 witnesses the SLC. Together with Lemma 2.13(ii), it therefore follows that X does not satisfy the SLC, completing the proof of (ii).

To prove (iii), we first introduce some more notation. Let \mathbf{u} be a vector perpendicular to \mathcal{L}_0 , pointing into the half-plane containing X (see Figure 16). Since $\mathbf{u} \cdot \overrightarrow{OA} > 0$ for all $A \in X$, this is also true of all $A \in \mathcal{A}_X \setminus \{O\}$. For $p \in \mathbb{N}$, let $\lambda_p = \mathbf{u} \cdot \overrightarrow{OA_{p,p^2}}$. By construction (cf. Figure 16) we have

$$0 < \lambda_0 < \lambda_1 < \lambda_2 < \dots \quad \text{and} \quad \lim_{p \rightarrow \infty} \lambda_p = \infty. \quad (2.56)$$

Now let $A \in \mathcal{A}_X$ be arbitrary, and write $\lambda = \mathbf{u} \cdot \overrightarrow{OA}$. Let $q = \max\{p \in \mathbb{N} : \lambda_p \leq \lambda\}$; this is well defined because of (2.56). Fix some $w \in \Pi_X(A)$, and write $w = B_1 \cdots B_k$, where $B_1, \dots, B_k \in X$. Also write $B_i = (x_i, y_i)$ for each i . Let $I = \{i \in \{1, \dots, k\} : B_i \in X_1\}$ and $J = \{j \in \{1, \dots, k\} : B_j \in X_2\}$, and write $I = \{i_1, \dots, i_l\}$ and $J = \{j_1, \dots, j_m\}$ where $i_1 < \dots < i_l$ and $j_1 < \dots < j_m$. Define the words

$$u = B_{i_1} \cdots B_{i_l} \quad \text{and} \quad v = B_{j_1} \cdots B_{j_m}.$$

We will show that:

- (iv) there are only finitely many possibilities for v , and
- (v) given some such v , there are only finitely many possibilities for u .

Since w is obtained by “shuffling” u and v together in some order, and since there are only finitely many ways to do this, it will follow that there are only finitely many possibilities for w : i.e., that $\pi_X(A)$ is finite. That is, the proof of (iii) above will be complete if we can prove (iv) and (v).

We begin with (iv). For each $j \in J$, let $p_j \in \mathbb{N}$ be such that $B_j = A_{p_j, p_j^2}$. Now,

$$\lambda = \mathbf{u} \cdot \overrightarrow{OA} = \mathbf{u} \cdot (\overrightarrow{OB}_1 + \cdots + \overrightarrow{OB}_k) \geq \mathbf{u} \cdot (\overrightarrow{OB}_{j_1} + \cdots + \overrightarrow{OB}_{j_m}) = \lambda_{p_{j_1}} + \cdots + \lambda_{p_{j_m}} \geq m\lambda_0,$$

so that $m \leq \frac{\lambda}{\lambda_0}$; since m is an integer, it follows that $m \leq \lfloor \frac{\lambda}{\lambda_0} \rfloor$. But also for any $j \in J$, we have

$$\lambda \geq \lambda_{p_{j_1}} + \cdots + \lambda_{p_{j_m}} \geq \lambda_{p_j},$$

so that $p_j \leq q$ for all $j \in J$ (q was defined just after (2.56)). The previous two conclusions show that v has length at most $\lfloor \frac{\lambda}{\lambda_0} \rfloor$, and is a word over $\{A_{0,0}, A_{1,1}, \dots, A_{q,q^2}\}$. Since λ, λ_0 and q depend only on A (and X), this completes the proof of item (iv).

To prove (v), first define the points

$$U = \alpha_X(u) = B_{i_1} + \cdots + B_{i_l} \quad \text{and} \quad V = \alpha_X(v) = B_{j_1} + \cdots + B_{j_m},$$

noting that $A = U + V$. Write $A = (a, b)$, $U = (c, d)$ and $V = (e, f)$. Now, $d = y_{i_1} + \dots + y_{i_l} \geq l$, as the y -coordinate of each element from X_1 is at least 1. Let r be the minimum y -coordinate of all the points from $\{A_{0,0}, A_{1,1}, \dots, A_{q,q^2}\}$, where q is as defined in the previous paragraph (note that q depends on u). Then since each B_j ($j \in J$) belongs to $\{A_{0,0}, A_{1,1}, \dots, A_{q,q^2}\}$, we have $f = y_{j_1} + \dots + y_{j_m} \geq mr$. Together with $d \geq l$ and $b = d + f$, it follows that

$$l \leq d = b - f \leq b - mr.$$

Since b depends only on the point A , and m and r only on the word v , it follows that the length of u is bounded above by a constant depending only on A and v . Also, since $(a - e, b - f) = A - V = U = B_{i_1} + \dots + B_{i_l}$, and since $y_i \geq 1$ for each $i \in I$ (as $B_i \in X_1$), it follows that $b - f = y_{i_1} + \dots + y_{i_m} \geq y_i$ for each $i \in I$. Since there are only finitely many elements of X_1 with y -coordinate at most $b - f$, it follows that v is a word over the finite subset $\{B \in X_1 : \text{the } y\text{-coordinate of } B \text{ is at most } b - f\}$. Since we have already shown that the length of v is bounded above by $b - mr$, this completes the proof of (v), and indeed (as noted above) of (iii).

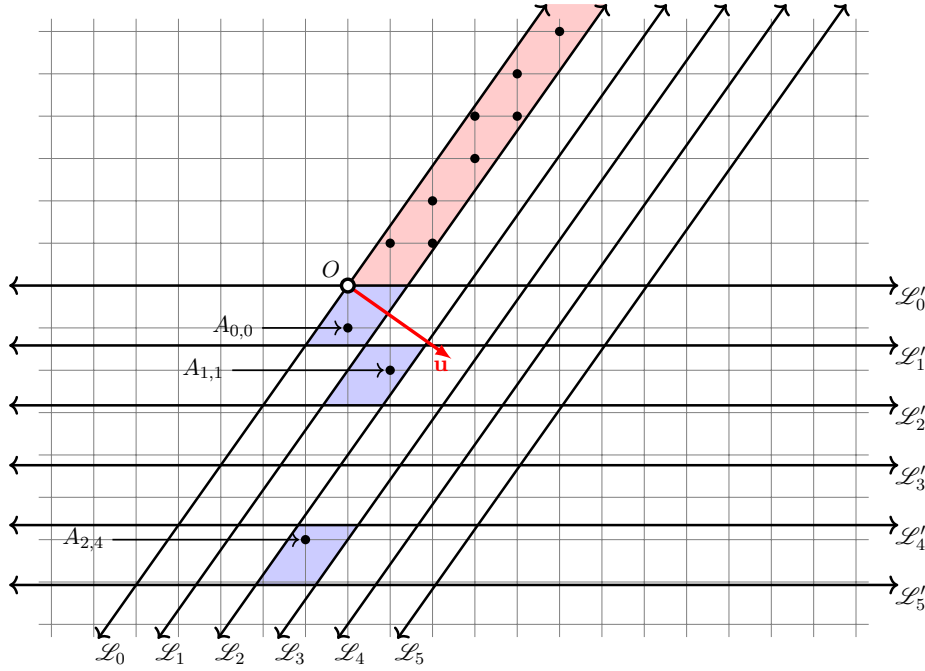

Figure 16: The step set $X = X_1 \cup X_2$ from Example 2.55 (drawn to scale). Points from X_1 and X_2 are in the regions shaded red and blue, respectively.

Next we wish to show that combination (VIII) is impossible. This will be achieved in Proposition 2.60 below, where we show that any step set $X \subseteq \mathbb{Z}_x^2$ with the BPP but not the LC must also have the FPP; we first demonstrate this in the special case that X contains no steps to the left of the y -axis.

Lemma 2.57. *If a step set $X \subseteq \mathbb{N} \times \mathbb{Z}$ does not satisfy the LC but does have the BPP, then X has the FPP.*

Proof. Suppose $X \subseteq \mathbb{N} \times \mathbb{Z}$ does not satisfy the LC but does have the BPP. Define the sets Y_k, Y_k^+ and Y_k^- , for each $k \in \mathbb{N}$, as in Lemma 2.43. Since X does not satisfy the LC, X must contain at least one point from the y -axis; by symmetry, we assume this point is on the negative part of the y -axis. If X also contained a point from the positive part of the y -axis, then X would have the IPP by Theorem 2.36, so this must not be the case (as $\text{BPP} \Rightarrow \neg \text{IPP}$, by Theorem 2.44(i)). So far we have shown that $Y_0^- \neq \emptyset$ and $Y_0^+ = \emptyset$. If Y_k^+ was infinite for some $k \in \mathbb{P}$, then X would not have the BPP, by Lemma 2.43(ii), a contradiction; so it follows that Y_k^+ is finite for all $k \in \mathbb{P}$. But then Lemma 2.43(i) now tells us that X has the FPP. \square

To extend Lemma 2.57 to arbitrary step sets (in Proposition 2.60), we need the next lemma. In the proof, and later, we use the well-known fact that the (perpendicular) distance of a point (u, v) to the line with equation $ax + by + c = 0$ is equal to

$$\frac{|au + bv + c|}{\sqrt{a^2 + b^2}}. \tag{2.58}$$

Lemma 2.59. *Let \mathcal{L} be the line with equation $ax+by = 0$, where $a, b \in \mathbb{Z}$ are not both zero and $\gcd(a, b) = 1$. Then the lines parallel to \mathcal{L} containing lattice points are precisely the lines parallel to \mathcal{L} whose (perpendicular) distance from \mathcal{L} is an integer multiple of $\frac{1}{\sqrt{a^2+b^2}}$.*

Proof. Throughout the proof, we write $\delta = \frac{1}{\sqrt{a^2+b^2}}$. First suppose \mathcal{L}' is parallel to \mathcal{L} and contains some lattice point $(u, v) \in \mathbb{Z}^2$. By (2.58), the distance from (u, v) to \mathcal{L} (and hence the distance from \mathcal{L}' to \mathcal{L}) is equal to $\frac{|au+bv|}{\sqrt{a^2+b^2}}$, which is an integer multiple of δ .

Conversely, let $k \in \mathbb{P}$ be arbitrary; there are two lines parallel to \mathcal{L} a distance of $k\delta$ from \mathcal{L} ; to show these both contain lattice points, it suffices to show that there are lattice points on both sides of \mathcal{L} a distance of $k\delta$ from \mathcal{L} . Since $\gcd(a, b) = 1$, there exist integers $u, v \in \mathbb{Z}$ such that $au + bv = 1$. Using (2.58) again, we see that the points $\pm(ku, kv)$ are both a distance of $k\delta$ from \mathcal{L} , as required. \square

Here is the promised result showing that combination (VIII) is impossible; cf. Table 1.

Proposition 2.60. *If a step set $X \subseteq \mathbb{Z}_\times^2$ does not satisfy the LC but does have the BPP, then X has the FPP.*

Proof. Suppose $X \subseteq \mathbb{Z}_\times^2$ does not satisfy the LC but does have the BPP. Because of the BPP, Theorem 2.44(i) says that X does not have the IPP.

First note that X satisfies the WLC, as defined in Section 2.8; indeed, if it did not, then as in Remark 2.49, \mathcal{A}_X would be a group isomorphic to $(\mathbb{Z}^2, +)$, in which case \mathcal{A}_X would contain non-trivial units, and so X would satisfy the IPP by Theorem 2.36, a contradiction. So let \mathcal{L}_0 be a line witnessing the WLC, and let H be the half-plane bounded by \mathcal{L}_0 such that $X \subseteq \overline{H}$. Since X does not satisfy the LC, we must have $X \cap \mathcal{L}_0 \neq \emptyset$. See Figure 17, which displays this, and all the coming information about X .

Since \mathcal{L}_0 also contains the origin, it has rational (or vertical) slope, so we may assume its equation is $ax+by = 0$, where $a, b \in \mathbb{Z}$ are not both zero and $\gcd(a, b) = 1$. Put $\delta = \frac{1}{\sqrt{a^2+b^2}}$. Let \mathbf{u} be a vector of length δ perpendicular to \mathcal{L}_0 and pointing into H . For $p \in \mathbb{P}$, let \mathcal{L}_p be the line defined by $\mathcal{L}_p = p\mathbf{u} + \mathcal{L}_0$; so \mathcal{L}_p is parallel to \mathcal{L} , is contained in H , and is a distance of $p\delta$ from \mathcal{L}_0 . By Lemma 2.59, and since $X \subseteq \overline{H} \cap \mathbb{Z}^2$, every element of X is contained in one of the lines \mathcal{L}_p ($p \in \mathbb{N}$).

Let \mathcal{L}'_0 be the line through O perpendicular to \mathcal{L}_0 ; so \mathcal{L}'_0 has equation $bx - ay = 0$. Let \mathbf{v} be a vector of length δ and perpendicular to \mathcal{L}'_0 (pointing in either of the two possible directions). For $q \in \mathbb{Z}$, let \mathcal{L}'_q be the line defined by $\mathcal{L}'_q = \mathcal{L}'_0 + q\mathbf{v}$. Again, by Lemma 2.59, each element of X lies on one of the lines \mathcal{L}'_q ($q \in \mathbb{Z}$).

So far we have seen that every step from X is on the intersection of \mathcal{L}_p and \mathcal{L}'_q for some $p \in \mathbb{N}$ and $q \in \mathbb{Z}$; this point is $pU + qV$, where $U, V \in \mathbb{Z}^2$ are such that $\mathbf{u} = \overrightarrow{OU}$ and $\mathbf{v} = \overrightarrow{OV}$. (The points U and V do not necessarily belong to X .) Write

$$Y = \{(p, q) \in \mathbb{N} \times \mathbb{Z} : pU + qV \in X\},$$

and define the linear transformation $\phi : \mathbb{R}^2 \rightarrow \mathbb{R}^2$ by $\phi(U) = (1, 0)$ and $\phi(V) = (0, 1)$. Note that ϕ acts geometrically on \mathbb{R}^2 by first rotating \mathcal{L}_0 and \mathcal{L}'_0 onto the y - and x -axes, respectively, and then scaling down by a factor of δ (and then possibly reflecting in the x -axis, depending on the direction chosen for \mathbf{v}). Also, ϕ maps X bijectively onto Y , and \mathcal{A}_X isomorphically onto \mathcal{A}_Y ; further, it is clear that the induced isomorphism $\mathcal{F}_X \rightarrow \mathcal{F}_Y$ maps $\Pi_X(A)$ bijectively onto $\Pi_Y(\phi(A))$ for all $A \in \mathcal{A}_X$; it follows that Y has the BPP (since X does), and that X has the FPP if and only if Y does. Moreover, given the above geometric interpretation of ϕ , it is clear that if a line \mathcal{L} witnessed the LC for Y , then the line $\phi^{-1}(\mathcal{L})$ would witness the LC for X ; since X does not satisfy the LC, it follows that Y does not either. Thus, since $Y \subseteq \mathbb{N} \times \mathbb{Z}$, it follows from Lemma 2.57 that Y has the FPP; as noted above, it follows that X too has the FPP. \square

2.10 Appendix (with a contribution from Stewart Wilcox): Combination (V)

For a long time, the authors (East and Ham) were unable to determine whether or not a step set could actually have combination (V); cf. Table 1. We were able to show that the existence of such step sets was equivalent to the existence of certain sequences of real numbers (defined below), but were unable to determine whether such sequences could exist either. In this section, we present (with kind permission) an ingenious construction due to Stewart Wilcox showing that such sequences, and hence such step sets, do indeed exist; see Proposition 2.64 and Example 2.70.

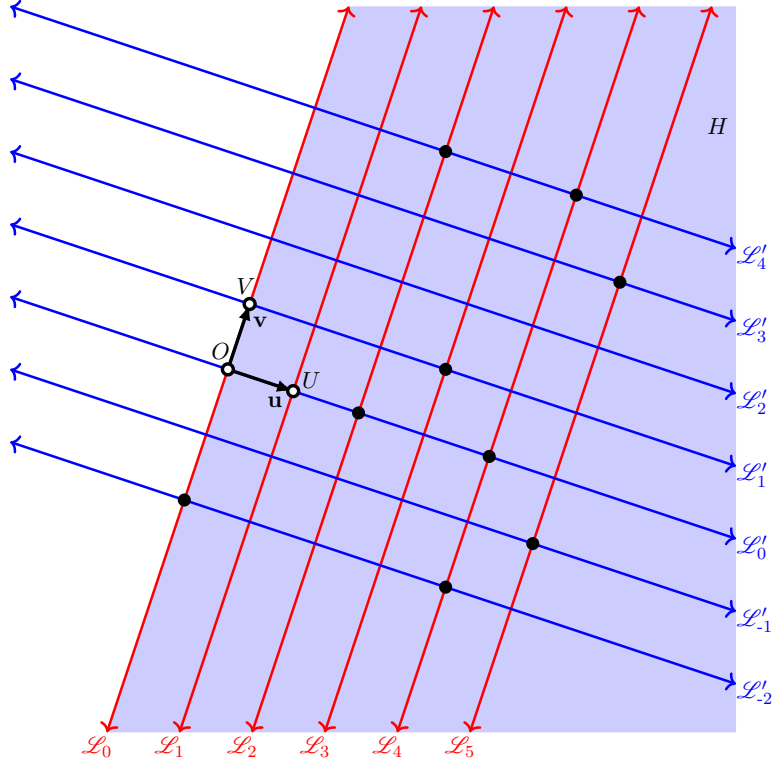

Figure 17: Schematic diagram of the proof of Proposition 2.60.

For the duration of this section, we fix a positive irrational number ξ , and we denote by

$$M = \{a + b\xi : a, b \in \mathbb{Z}, a + b\xi \geq 0\}$$

the additive monoid consisting of all non-negative \mathbb{Z} -linear combinations of 1 and ξ . Note that a or b might be negative in $a + b\xi \in M$, but we require $a + b\xi$ itself to be non-negative. So M is a submonoid of $\mathbb{R}_{\geq 0}$, and is dense in $\mathbb{R}_{> 0}$; cf. the claim in the proof of Lemma 2.27. Since 1 and ξ are linearly independent over \mathbb{Q} , there is a well defined (and surjective) monoid homomorphism

$$\phi : M \rightarrow \mathbb{Z} \quad \text{given by} \quad \phi(a + b\xi) = b.$$

During this section, if $a, b \in \mathbb{R}$, we will write $[a, b]$ and (a, b) for the closed and open intervals of all $x \in \mathbb{R}$ satisfying $a \leq x \leq b$ or $a < x < b$, respectively; we also write $[a, b)$ and $(a, b]$ for the half-open intervals, with the obvious meanings. If $\Sigma \subseteq \mathbb{R}$, we will also write $[a, b]_{\Sigma} = [a, b] \cap \Sigma$, with similar notation for other kinds of intervals; for example, if $a, b \in \mathbb{Z}$ and $a \leq b$, then $[a, b]_{\mathbb{Z}} = \{a, a + 1, \dots, b\}$. If x is a real number, we will write $((x)) = x - [x]$ for the fractional part of x .

Lemma 2.61. *There is a mapping $\mathbb{P} \rightarrow \mathbb{P} : k \mapsto p_k$ such that*

$$\phi^{-1}([p, p + p_k]_{\mathbb{Z}}) \cap (\alpha, \alpha + \frac{1}{k}) \neq \emptyset \quad \text{for all } p \in \mathbb{Z} \text{ and } \alpha \in \mathbb{R}_{\geq 0}.$$

Proof. Fix some $k \in \mathbb{P}$. By the claim in the proof of Lemma 2.27, there exists $l \in \mathbb{P}$ and $a \in \mathbb{Z}$ such that $0 < l\xi - a < \frac{1}{k}$. Let $p_k \in \mathbb{P}$ be arbitrary so that

$$p_k > l(1 + \frac{1}{l\xi - a}).$$

Now suppose we are given $p \in \mathbb{Z}$ and $\alpha \in \mathbb{R}_{\geq 0}$. Define

$$t = 1 + \left\lfloor \frac{((\alpha - p\xi))}{l\xi - a} \right\rfloor.$$

Then

$$1 \leq t \leq 1 + \frac{((\alpha - p\xi))}{l\xi - a} < 1 + \frac{1}{l\xi - a} < \frac{p_k}{l}. \quad (2.62)$$

We also claim that

$$0 < t(l\xi - a) - ((\alpha - p\xi)) < \frac{1}{k}. \quad (2.63)$$

Indeed, for the inequality $0 < t(l\xi - a) - ((\alpha - p\xi))$, note that if we write $\beta = l\xi - a$ and $\gamma = ((\alpha - p\xi))$, then we have

$$t\beta - \gamma = (1 + \lfloor \frac{\gamma}{\beta} \rfloor)\beta - \gamma = \beta(1 - (\frac{\gamma}{\beta} - \lfloor \frac{\gamma}{\beta} \rfloor)) = \beta(1 - ((\frac{\gamma}{\beta}))) > \beta(1 - 1) = 0,$$

while for the inequality $t(l\xi - a) - ((\alpha - p\xi)) \leq l\xi - a$, we continue from above to obtain

$$t\beta - \gamma = \beta(1 - ((\frac{\gamma}{\beta}))) \leq \beta = l\xi - a < \frac{1}{k}.$$

Now that we have established (2.63), adding α throughout gives

$$\alpha < t(l\xi - a) + \alpha - ((\alpha - p\xi)) < \alpha + \frac{1}{k}.$$

Since $\alpha - ((\alpha - p\xi)) = \alpha - (\alpha - p\xi) + \lfloor \alpha - p\xi \rfloor = p\xi + \lfloor \alpha - p\xi \rfloor$, it follows that

$$\alpha < t(l\xi - a) + p\xi + \lfloor \alpha - p\xi \rfloor < \alpha + \frac{1}{k}.$$

That is,

$$\alpha < b + c\xi < \alpha + \frac{1}{k} \quad \text{where} \quad b = \lfloor \alpha - p\xi \rfloor - ta \quad \text{and} \quad c = tl + p.$$

So $b + c\xi \in (\alpha, \alpha + \frac{1}{k})$, and also $b + c\xi \in \phi^{-1}([p, p + p_k]_{\mathbb{Z}})$ since $\phi(b + c\xi) = c = tl + p$ clearly satisfies $p \leq c$, while $c \leq p + p_k$ follows from $t < \frac{p_k}{l}$ which is itself part of (2.62). \square

For the rest of this section, we fix the mapping $\mathbb{P} \rightarrow \mathbb{P} : k \mapsto p_k$ from Lemma 2.61. In fact, by suitably increasing each p_k if necessary, we may assume that $p_1 < p_2 < \dots$.

In what follows, for any subset Σ of \mathbb{R} , we write $S_n(\Sigma) = \{\sigma_1 + \dots + \sigma_n : \sigma_1, \dots, \sigma_n \in \Sigma\}$ for the set of all sums of n elements of Σ . Clearly if Σ is finite, then $|S_n(\Sigma)| \leq |\Sigma|^n$.

For each $l \in \mathbb{P}$, we define

$$B(l) = \phi^{-1}((-l, l]_{\mathbb{Z}}) \cap [0, l] \subseteq M \quad \text{and} \quad n_l = l + l^3 \in \mathbb{P}.$$

Note that the “[0, l)” in the definition of $B(l)$ is not “[0, l] $_{\mathbb{Z}}$ ”; in particular, $B(l)$ contains non-integers. We clearly have $B(1) \subseteq B(2) \subseteq \dots$, and we also have $M = \bigcup_{l \in \mathbb{P}} B(l)$. Indeed, for the latter, if $\alpha \in M$, then $\alpha \in B(l)$ for any l greater than both α and $|\phi(\alpha)|$. We aim to prove the following:

Proposition 2.64. *There exist sequences $\alpha_i, \beta_i, \gamma_i$ ($i \in \mathbb{P}$) of elements of M satisfying:*

- (i) $\lim_{i \rightarrow \infty} \alpha_i = 0$,
- (ii) $\lim_{i \rightarrow \infty} \gamma_i = 1$,
- (iii) $\gamma_i > 1$ for all $i \in \mathbb{P}$,
- (iv) $\beta_i + \gamma_i = 4$ for all $i \in \mathbb{P}$, and
- (v) $S_n(\Sigma) \cap B(l) = \emptyset$ for all $l \in \mathbb{P}$ and $n > n_l$, where $\Sigma = \{\alpha_i, \beta_i, \gamma_i : i \in \mathbb{P}\}$.

To prove the proposition, we will construct the α_i series shortly, and after that the β_i, γ_i series inductively. We will write $\mathbf{A} = \{\alpha_i : i \in \mathbb{P}\}$ and $\mathbf{A}_k = \{\alpha_i : i \in \{1, \dots, k\}\}$ for each $k \in \mathbb{P}$, and similarly define the sets $\mathbf{B}, \mathbf{C}, \mathbf{B}_k$ and \mathbf{C}_k . (Of course these sets are only well-defined once their elements have been specified.)

For $k \in \mathbb{P}$, define

$$R_k = (2k + p_k + 1) \left(1 + \sum_{n=0}^{n_k} n_k (3k)^n \right) \in \mathbb{P},$$

noting that $R_1 < R_2 < \dots$. For each $k \in \mathbb{P}$, let $\alpha_k \in M \cap (\frac{1}{k}, \frac{2}{k})$ be such that $\phi(\alpha_k) > k(1 + R_k)$; such an element α_k exists by Lemma 2.61.

We will now inductively construct β_k, γ_k ($k \in \mathbb{P}$) satisfying $\beta_k + \gamma_k = 4$, $\gamma_k \in (1, 1 + \frac{1}{k}]$ and

$$S_n(\mathbf{A} \cup \mathbf{B}_k \cup \mathbf{C}_k) \cap B(l) = \emptyset \quad \text{for all } l \in \mathbb{P} \text{ and } n > n_l.$$

For the base of the induction, we set $\beta_1 = \gamma_1 = 2$. We must show the following:

Lemma 2.65. *With the above notation, we have $S_n(\mathbf{A} \cup \{2\}) \cap B(l) = \emptyset$ for all $l \in \mathbb{P}$ and $n > n_l$.*

Proof. Suppose to the contrary that there exists $\varepsilon \in S_n(\mathbf{A} \cup \{2\}) \cap B(l)$ for some $l \in \mathbb{P}$ and $n > n_l$. Then there exist integers $c_i, d \in \mathbb{N}$ ($i \in \mathbb{P}$) such that

$$\varepsilon = \sum_{i \in \mathbb{P}} c_i \alpha_i + 2d \quad \text{and} \quad \sum_{i \in \mathbb{P}} c_i + d = n.$$

In particular, recalling the definition of $B(l)$, we have $l > \varepsilon > c_i \alpha_i > \frac{c_i}{i}$ for each $i \in \mathbb{P}$, so that $c_i < il$ for each i . Similarly $l > 2d \geq d$. Again recalling the definition of $B(l)$, we also have

$$\sum_{i \in \mathbb{P}} c_i \phi(\alpha_i) = \phi(\varepsilon) < l.$$

But $\phi(\alpha_i) > i(1 + R_i)$ for all i , so it follows that $\phi(\alpha_i) \geq 0$ for all $i \in \mathbb{P}$, and that $\phi(\alpha_i) > l$ for $i > l$. This gives $c_i = 0$ for all $i > l$. Putting all of the above together, we have

$$l + l^3 = n_l < n = \sum_{i \leq l} c_i + d < (l + 2l + \cdots + l^2) + l = \frac{l^2(l+1)}{2} + l \leq \frac{l^2(l+l)}{2} + l = l^3 + l,$$

a contradiction. \square

Now suppose $k > 1$, and that we have defined the sequences β_i, γ_i as desired for all $i < k$. Let $K > k$ be such that

$$R_K > |\phi(\beta_i)|, |\phi(\gamma_i)| \quad \text{for all } i < k.$$

Define the sets

$$\Omega = \bigcup_{n=0}^{n_K} \bigcup_{t=1}^{n_K} \frac{\phi(S_n(\mathbf{A}_K \cup \mathbf{B}_{k-1} \cup \mathbf{C}_{k-1}))}{t} \quad \text{and} \quad \Gamma = \Omega \cup (-\Omega).$$

Note that

$$|\Gamma| \leq 2|\Omega| \leq 2 \sum_{n=0}^{n_K} \sum_{t=1}^{n_K} |S_n(\mathbf{A}_K \cup \mathbf{B}_{k-1} \cup \mathbf{C}_{k-1})| \leq 2 \sum_{n=0}^{n_K} n_K (3K)^n.$$

It quickly follows that $(|\Gamma| + 1)(2K + p_k + 1) < 2R_K$, and so there exists an integer $p \in \mathbb{Z}$ such that

$$[p, p + 2K + p_k]_{\mathbb{Z}} \subseteq (-R_K, R_K)_{\mathbb{Z}} \setminus \Gamma. \quad (2.66)$$

By Lemma 2.61, we may fix some

$$\gamma_k \in \phi^{-1}([p + K, p + K + p_k]_{\mathbb{Z}}) \cap (1, 1 + \frac{1}{k}) \quad \text{and we also put} \quad \beta_k = 4 - \gamma_k.$$

Since $\phi(\gamma_k) \in [p + K, p + K + p_k]_{\mathbb{Z}} \subseteq [p, p + 2K + p_k]_{\mathbb{Z}} \subseteq (-R_K, R_K)_{\mathbb{Z}}$, we have $|\phi(\gamma_k)| < R_K$; since $\phi(\beta_k) = -\phi(\gamma_k)$, it follows that $|\phi(\beta_k)| < R_K$ as well. We also claim that

$$|\phi(\gamma_k) \pm \omega| > K \quad \text{for all } \omega \in \Omega. \quad (2.67)$$

Indeed, we have $\phi(\gamma_k) \in [p + K, p + K + p_k]_{\mathbb{Z}}$, so the set of all integers of distance at most K from $\phi(\gamma_k)$ is contained in $[p, p + 2K + p_k]_{\mathbb{Z}}$, and by (2.66) the latter interval is disjoint from Γ . Thus, for any $\omega \in \Omega$, since $\mp \omega \in \Gamma$, it follows that the distance from $\phi(\gamma_k)$ to $\mp \omega$ is greater than K : i.e., $|\phi(\gamma_k) - (\mp \omega)| > K$, completing the proof of (2.67).

To make sure that β_k, γ_k have all the desired properties, it remains to prove the following.

Lemma 2.68. *With the above notation, we have $S_n(\mathbf{A} \cup \mathbf{B}_k \cup \mathbf{C}_k) \cap B(l) = \emptyset$ for all $l \in \mathbb{P}$ and $n > n_l$.*

Proof. Suppose to the contrary that there exists $\varepsilon \in S_n(\mathbf{A} \cup \mathbf{B}_k \cup \mathbf{C}_k) \cap B(l)$ for some $l \in \mathbb{P}$ and $n > n_l$. Then there exist integers $c_i, d_i, e_i \in \mathbb{N}$ such that

$$\varepsilon = \sum_{i \in \mathbb{P}} c_i \alpha_i + \sum_{i=1}^k (d_i \beta_i + e_i \gamma_i) \in B(l) \quad \text{and} \quad \sum_{i \in \mathbb{P}} c_i + \sum_{i=1}^k (d_i + e_i) = n.$$

Since $\beta_k + \gamma_k = \beta_1 + \gamma_1$, we may assume without loss of generality that $d_k = 0$ or $e_k = 0$. But we note that d_k and e_k cannot both be zero, or else then $\varepsilon \in S_n(\mathbf{A} \cup \mathbf{B}_{k-1} \cup \mathbf{C}_{k-1}) \cap B(l)$, contradicting the assumption that β_i, γ_i ($i = 1, \dots, k-1$) have the desired properties. As in the proof of Lemma 2.65, we have $c_i < il$ for all $i \in \mathbb{P}$.

Case 1. Suppose first that $d_k = 0$, so that $e_k > 0$ as just noted. Also, since each $\beta_i, \gamma_i > 1$ and each $\alpha_i > 0$, and since $\varepsilon \in B(l)$, we have $\sum_{i=1}^k (d_i + e_i) < \sum_{i=1}^k (d_i \beta_i + e_i \gamma_i) \leq \varepsilon < l$. Next note that

$$l > \phi(\varepsilon) = \sum_{i \in \mathbb{P}} c_i \phi(\alpha_i) + \sum_{i=1}^k (d_i \phi(\beta_i) + e_i \phi(\gamma_i)) \geq \sum_{i \in \mathbb{P}} c_i \phi(\alpha_i) - \sum_{i=1}^k (d_i |\phi(\beta_i)| + e_i |\phi(\gamma_i)|),$$

from which it follows that

$$\sum_{i \in \mathbb{P}} c_i \phi(\alpha_i) < l + \sum_{i=1}^k (d_i |\phi(\beta_i)| + e_i |\phi(\gamma_i)|) < l + \sum_{i=1}^k (d_i R_K + e_i R_K) = l + R_K \sum_{i=1}^k (d_i + e_i) < l(1 + R_K). \quad (2.69)$$

We now consider two subcases.

Case 1.1. Suppose $l \geq K$. Then (2.69) gives

$$l(1 + R_K) > \sum_{i \geq K} c_i \phi(\alpha_i) \geq \sum_{i \geq K} c_i i (1 + R_i) \geq \sum_{i \geq K} c_i (1 + R_K) \Rightarrow \sum_{i \geq K} c_i < l.$$

From this it follows that

$$l + l^3 = n_l < n = \sum_{i < K} c_i + \sum_{i \geq K} c_i + \sum_{i=1}^k (d_i + e_i) < (l + 2l + \dots + (K-1)l) + l + l = l \frac{K(K-1)}{2} + 2l \leq \frac{l^3}{2} + 2l.$$

But $l + l^3 < \frac{l^3}{2} + 2l$ implies $l^2 < 2$, a contradiction since $l \geq K > 1$.

Case 1.2. Now suppose $l < K$. For $i \geq K$ we have $\phi(\alpha_i) > i(1 + R_i) \geq K(1 + R_K)$. Together with (2.69), it follows that for any such i ,

$$c_i K(1 + R_K) \leq c_i \phi(\alpha_i) < l(1 + R_K) < K(1 + R_K) \quad \text{so that} \quad c_i = 0 \text{ for all } i \geq K.$$

Setting $t = e_k \geq 1$, we have

$$\varepsilon - t\gamma_k = \sum_{i < K} c_i \alpha_i + \sum_{i < k} (d_i \beta_i + e_i \gamma_i) \in S_{n-t}(\mathbf{A}_K \cup \mathbf{B}_{k-1} \cup \mathbf{C}_{k-1}).$$

But also

$$n - t < n = \sum_{i < K} c_i + \sum_{i=1}^k (d_i + e_i) < (l + 2l + \dots + (K-1)l) + l = l \frac{K(K-1)}{2} + l < \frac{K^3}{2} + K < n_K,$$

and $t = e_k \leq \sum_{i \in \mathbb{P}} c_i + \sum_{i=1}^k (d_i + e_i) = n < n_K$. So it follows that $\phi(\varepsilon) - t\phi(\gamma_k) \in t\Omega$, say $\phi(\varepsilon) - t\phi(\gamma_k) = t\omega$. Then by (2.67),

$$|\phi(\varepsilon)| = t|\phi(\gamma_k) + \omega| > tK \geq K.$$

But also from $\varepsilon \in B(l)$, we have $|\phi(\varepsilon)| < l < K$, so we have arrived at a contradiction again.

Case 2. The case in which $e_k = 0$ and $d_k > 0$ is almost identical, since $\phi(\beta_k) = -\phi(\gamma_k)$. \square

We are now ready to tie together the loose ends.

Proof of Proposition 2.64. With respect to the sequences $\alpha_i, \beta_i, \gamma_i$ ($i \in \mathbb{P}$) constructed above, conditions (i)–(iv) are immediate, while (v) follows from the fact that

$$S_n(\Sigma) \cap B(l) = S_n(\mathbf{A} \cup \mathbf{B} \cup \mathbf{C}) \cap B(l) = \bigcup_{k \in \mathbb{P}} (S_n(\mathbf{A} \cup \mathbf{B}_k \cup \mathbf{C}_k) \cap B(l)) \quad \text{for all } n, l \in \mathbb{P}. \quad \square$$

We now show how to use Proposition 2.64 to provide an example of a step set $X \subseteq \mathbb{Z}_{\times}^2$ with combination (V):

Example 2.70. Let ξ be a positive irrational number, and keep the notation above: in particular, the monoid $M = \{a + b\xi : a, b \in \mathbb{Z}, a + b\xi \geq 0\}$ and the sequences $\alpha_i, \beta_i, \gamma_i$ ($i \in \mathbb{P}$). Also let

$$N = \{(a, b) \in \mathbb{Z}^2 : a + b\xi \geq 0\}$$

be the additive submonoid of \mathbb{Z}^2 consisting of all lattice points on or above the line \mathcal{L} with equation $x + \xi y = 0$. The map

$$\psi : N \rightarrow M : (a, b) \mapsto a + b\xi$$

is clearly a surjective monoid homomorphism. In fact, ψ is an isomorphism, as injectivity follows quickly from the irrationality of ξ . For each $i \in \mathbb{P}$, let

$$A_i = \psi^{-1}(\alpha_i), \quad B_i = \psi^{-1}(\beta_i), \quad C_i = \psi^{-1}(\gamma_i),$$

and put $X = \{A_i, B_i, C_i : i \in \mathbb{P}\}$. Also let $E = (1, 0) = \psi^{-1}(1)$. We claim that:

- (i) X does not satisfy the SLC,
- (ii) X satisfies the LC,
- (iii) X does not have the FPP,
- (iv) X has the BPP.

First note that (ii) is clear, as \mathcal{L} itself witnesses the LC (as ξ is irrational, the only lattice point on \mathcal{L} is O). Item (iii) follows quickly from the fact that $\beta_i + \gamma_i = 4$ for all $i \in \mathbb{P}$; indeed, since ψ is an isomorphism, this implies that $B_i + C_i = \psi^{-1}(4) = (4, 0) = 4E$ for all i , and hence $\pi_X(4E) = \infty$.

To establish the remaining items, first define $\eta = \sqrt{1 + \xi^2}$. For $A = (u, v) \in N$ write $\delta(A)$ for the (perpendicular) distance from A to \mathcal{L} . Then by (2.58), and since $u + v\xi \geq 0$ as $A \in N$, we have

$$\delta(A) = \frac{u + v\xi}{\sqrt{1 + \xi^2}} = \frac{\psi(A)}{\eta}.$$

Next, let \mathcal{L}' and \mathcal{L}'' be the lines obtained, respectively, by sliding \mathcal{L} a distance of $\frac{1}{\eta}$ or $\frac{3}{\eta}$ units into the half-plane on the side of \mathcal{L} containing X (or, equivalently, by sliding \mathcal{L} by 1 or 3 units to the right, since $\delta(E) = \frac{1}{\eta}$). This is all shown in Figure 18. Now,

$$\lim_{i \rightarrow \infty} \delta(A_i) = \lim_{i \rightarrow \infty} \frac{\alpha_i}{\eta} = 0.$$

This shows that X contains points arbitrarily close to \mathcal{L} ; and consequently that:

- (v) no line parallel to \mathcal{L} witnesses the SLC.

We also have

$$\lim_{i \rightarrow \infty} \delta(C_i) = \lim_{i \rightarrow \infty} \frac{\gamma_i}{\eta} = \frac{1}{\eta} \quad \text{and} \quad \lim_{i \rightarrow \infty} \delta(B_i) = \lim_{i \rightarrow \infty} \frac{\beta_i}{\eta} = \lim_{i \rightarrow \infty} \frac{4 - \gamma_i}{\eta} = \frac{3}{\eta}.$$

This means that the points C_1, C_2, \dots approach \mathcal{L}' from the right, while B_1, B_2, \dots approach \mathcal{L}'' from the left. Since the points C_1, C_2, \dots are between the lines \mathcal{L}' and \mathcal{L}'' , and since a bounded region of \mathbb{R}^2 contains only finitely many lattice points, the y -coordinates of C_1, C_2, \dots are unbounded, either above or below or both; it follows (since $B_i = 4E - C_i$ for all i) that the y -coordinates of B_1, B_2, \dots are unbounded below or above or both, respectively. Thus, X contains points between \mathcal{L}' and \mathcal{L}'' with arbitrarily large positive and negative y -coordinates, and it quickly follows that:

- (vi) \mathcal{L} is the only line through O that witnesses the LC.

Items (v) and (vi), together with Lemma 2.13(ii), show that X does not satisfy the SLC. Figure 18 depicts all the above, but only showing subsequences A_i ($i \in I$), and B_j, C_j ($j \in J$) with monotone y -coordinates (with the y -coordinates of A_i, C_j increasing, and those of B_j decreasing).

Finally, the BPP follows quickly from the properties of the $\alpha_i, \beta_i, \gamma_i$ sequences. Indeed, let $D \in \mathcal{A}_X$ be arbitrary, and fix some $w \in \Pi_X(D)$. Write $w = F_1 \cdots F_k$, where $F_1, \dots, F_k \in X$, so that $D = F_1 + \cdots + F_k$. Now consider the real number $\psi(D) \in M$, and let $l \in \mathbb{P}$ be such that $\psi(D) \in B(l)$; the set $B(l) \subseteq M$ was defined just before Proposition 2.64. Now, $\psi(D) = \psi(F_1) + \cdots + \psi(F_k)$, and $\psi(F_1), \dots, \psi(F_k)$ all belong to $\Sigma = \{\alpha_i, \beta_i, \gamma_i : i \in \mathbb{P}\}$. This means that $\psi(D) \in S_k(\Sigma) \cap B(l)$, and so Proposition 2.64 gives $\ell(w) = k \leq n_l = l + l^3$. This shows that the set $\{\ell(w) : w \in \Pi_X(D)\}$ is contained in $\{1, \dots, n_l\}$, and hence is finite. Since $D \in \mathcal{A}_X$ was arbitrary, the BPP has been established.

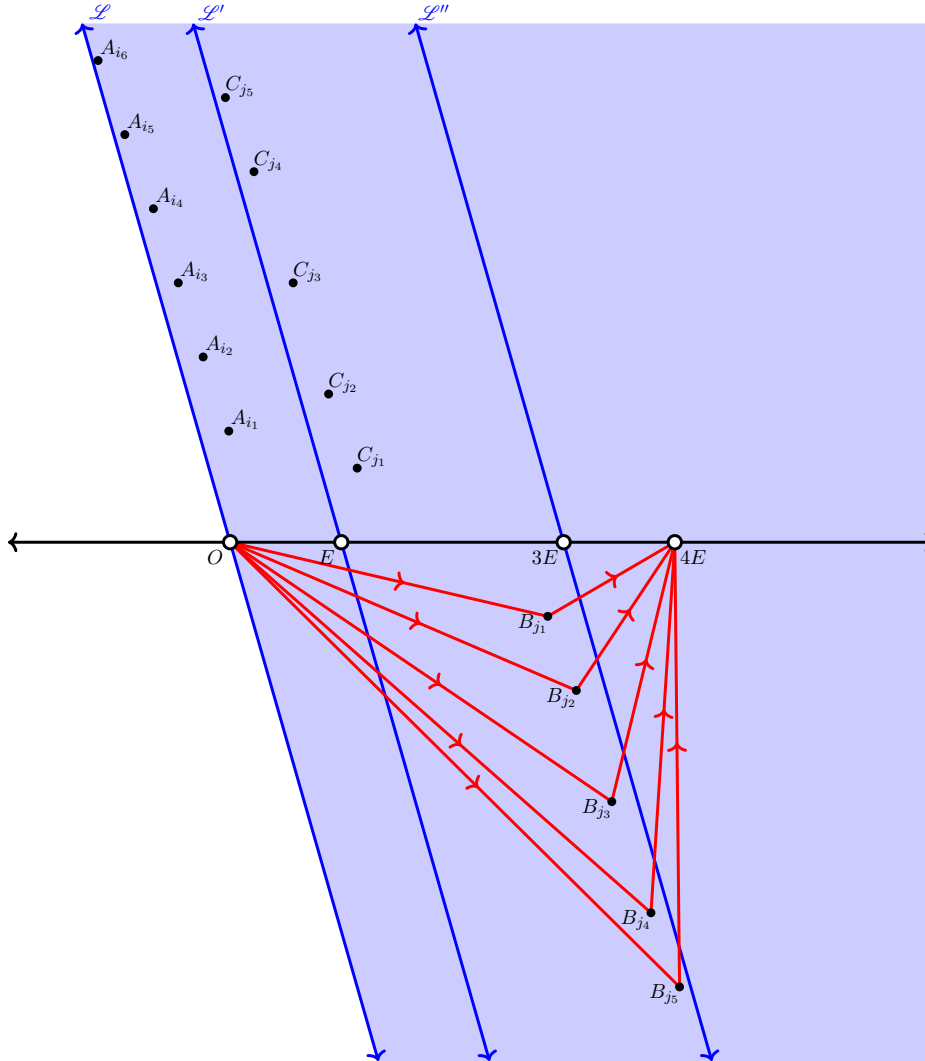

Figure 18: A subset of the step set from Example 2.70 (not to scale). Some X -walks of the form $B_j C_j$ from $\Pi_X(4E)$ are shown in red.

3 Constrained walks

3.1 Definitions and basic examples

Suppose now that we have a step set $X \subseteq \mathbb{Z}_X^2$, and that we wish to enumerate X -walks that stay within a certain region of the plane. For any word $w = A_1 \cdots A_k \in \mathcal{F}_X$, and for any $0 \leq m \leq k$, we write $\sigma_m(w) = A_1 \cdots A_m$ for the *initial subword* consisting of the first m letters of w . Note that $\sigma_0(w) = \varepsilon$ and $\sigma_{\ell(w)}(w) = w$ for any word w . Considering the letters A_1, \dots, A_k as steps in a walk from O to $\alpha_X(w) = A_1 + \cdots + A_k$, we see that the points visited during the walk are

$$O = \alpha_X(\sigma_0(w)) \rightarrow \alpha_X(\sigma_1(w)) \rightarrow \alpha_X(\sigma_2(w)) \rightarrow \cdots \rightarrow \alpha_X(\sigma_k(w)) = \alpha_X(w). \quad (3.1)$$

(The surmorphism $\alpha_X : \mathcal{F}_X \rightarrow \mathcal{A}_X$ was defined in Section 2.1.)

Now fix a subset \mathcal{C} of \mathbb{Z}^2 with $O \in \mathcal{C}$. Consider a word $w = A_1 \cdots A_k \in \mathcal{F}_X$; so w is an X -walk from O to $\alpha_X(w)$, visiting the points listed in (3.1). We are interested in the walks that are constrained in such a way that all of these points belong to \mathcal{C} ; we call such a walk an (X, \mathcal{C}) -walk. Accordingly, we define

$$\mathcal{F}_X^\mathcal{C} = \{w \in \mathcal{F}_X : \alpha_X(\sigma_m(w)) \in \mathcal{C} \text{ for all } 0 \leq m \leq \ell(w)\} \quad \text{and} \quad \mathcal{A}_X^\mathcal{C} = \alpha_X(\mathcal{F}_X^\mathcal{C}) = \{\alpha_X(w) : w \in \mathcal{F}_X^\mathcal{C}\}.$$

So $\mathcal{F}_X^\mathcal{C}$ is the set of all (X, \mathcal{C}) -walks, and $\mathcal{A}_X^\mathcal{C}$ is the set of all endpoints of such walks. Note that $\mathcal{A}_X^\mathcal{C} \subseteq \mathcal{A}_X \cap \mathcal{C}$, but that this inclusion may be strict; consider $X = \{(1, 0)\}$ and $\mathcal{C} = 2\mathbb{N} \times \{0\}$. Note also that $\varepsilon \in \mathcal{F}_X^\mathcal{C}$ and $O \in \mathcal{A}_X^\mathcal{C}$ for any X and \mathcal{C} , but that neither $\mathcal{F}_X^\mathcal{C}$ nor $\mathcal{A}_X^\mathcal{C}$ need be monoids in general; consider $X = \{(1, 0)\}$ and $\mathcal{C} = \{(0, 0), (1, 0)\}$. However, we do have the following general result.

Lemma 3.2. *If $X \subseteq \mathbb{Z}_\times^2$ is a step set, and if \mathcal{C} is a submonoid of \mathbb{Z}^2 , then $\mathcal{F}_X^\mathcal{C}$ and $\mathcal{A}_X^\mathcal{C}$ are submonoids of \mathcal{F}_X and \mathcal{A}_X , respectively.*

Proof. Since $\mathcal{A}_X^\mathcal{C} = \alpha_X(\mathcal{F}_X^\mathcal{C})$, and since α_X is a homomorphism, it suffices to prove the statement concerning $\mathcal{F}_X^\mathcal{C}$. With this in mind, let $u, v \in \mathcal{F}_X^\mathcal{C}$, and write $k = \ell(u)$ and $l = \ell(v)$. We must show that $\alpha_X(\sigma_m(uv)) \in \mathcal{C}$ for all $0 \leq m \leq \ell(uv) = k + l$. Now, if $0 \leq m \leq k$, then $\alpha_X(\sigma_m(uv)) = \alpha_X(\sigma_m(u)) \in \mathcal{C}$ since $u \in \mathcal{F}_X^\mathcal{C}$. If $k \leq m \leq k + l$, then

$$\alpha_X(\sigma_m(uv)) = \alpha_X(u\sigma_{m-k}(v)) = \alpha_X(u) + \alpha_X(\sigma_{m-k}(v)) \in \mathcal{C}$$

since $u, v \in \mathcal{F}_X^\mathcal{C}$ and since \mathcal{C} is a submonoid. \square

In what follows, it is often necessary to assume that the constraint set \mathcal{C} is a submonoid of \mathbb{Z}^2 in order to prove a general result, although there are some notable exceptions (e.g., Proposition 3.7).

Consider a step set $X \subseteq \mathbb{Z}_\times^2$ and a submonoid \mathcal{C} of \mathbb{Z}^2 . Recall that for any $A \in \mathbb{Z}^2$,

$$\Pi_X(A) = \alpha_X^{-1}(A) = \{w \in \mathcal{F}_X : \alpha_X(w) = A\} \quad \text{and} \quad \pi_X(A) = |\Pi_X(A)|$$

are the set and number of X -walks from O to A , respectively. Analogously, for $A \in \mathbb{Z}^2$, we define

$$\Pi_X^\mathcal{C}(A) = \alpha_X^{-1}(A) \cap \mathcal{F}_X^\mathcal{C} = \{w \in \mathcal{F}_X^\mathcal{C} : \alpha_X(w) = A\} \quad \text{and} \quad \pi_X^\mathcal{C}(A) = |\Pi_X^\mathcal{C}(A)|.$$

So $\Pi_X^\mathcal{C}(A)$ is the set of all (X, \mathcal{C}) -walks from O to A , and $\pi_X^\mathcal{C}(A)$ is the number of such walks. Clearly $\pi_X^\mathcal{C}(A) \leq \pi_X(A)$ for all A . If $\mathcal{A}_X \subseteq \mathcal{C}$, then $\Pi_X^\mathcal{C}(A) = \Pi_X(A)$ and $\pi_X^\mathcal{C}(A) = \pi_X(A)$ for all A ; in particular, this occurs when $\mathcal{C} = \mathbb{Z}^2$, in which case we are dealing with unconstrained walks as in Section 2.

Consider a step set $X \subseteq \mathbb{Z}_\times^2$ and a subset $\mathcal{C} \subseteq \mathbb{Z}^2$ with $O \in \mathcal{C}$. As in Section 2, the combinatorial data corresponding to the pair (X, \mathcal{C}) may be conveniently displayed in a graph, $\Gamma_X^\mathcal{C}$, defined as follows:

- The vertex set of $\Gamma_X^\mathcal{C}$ is $\mathcal{A}_X^\mathcal{C}$; a vertex $A \in \mathcal{A}_X^\mathcal{C}$ is drawn in the appropriate position in the plane, and is labelled $\pi_X^\mathcal{C}(A)$.
- If $A \in \mathcal{A}_X^\mathcal{C}$ and $B \in X$ are such that $A + B \in \mathcal{A}_X^\mathcal{C}$, then $\Gamma_X^\mathcal{C}$ has the labelled edge $A \xrightarrow{B} A + B$.

We noted in Section 2.1 that Γ_X is the Cayley graph of the monoid \mathcal{A}_X with respect to the generating set X (with additional vertex labels showing the numbers $\pi_X(A)$). It is important to note, however, that $\Gamma_X^\mathcal{C}$ is generally not a Cayley graph of the monoid $\mathcal{A}_X^\mathcal{C}$; in fact, X is not even a subset of $\mathcal{A}_X^\mathcal{C}$ in general, let alone a generating set.

At this point it is worth considering some basic examples.

Example 3.3 (cf. Examples 2.1 and 2.3). Let $X = \{N, E\}$ and $Y = \{N, E, S, W\}$, where $N = (0, 1)$, $E = (1, 0)$, $S = (0, -1)$ and $W = (-1, 0)$. Also let $\mathcal{C} = \{(a, b) \in \mathbb{N}^2 : b \leq a\}$. Then $\mathcal{A}_X^\mathcal{C} = \mathcal{A}_Y^\mathcal{C} = \mathcal{C}$. The graphs $\Gamma_X^\mathcal{C}$ and $\Gamma_Y^\mathcal{C}$ are pictured in Figure 19; we will say more about the numbers $\pi_X^\mathcal{C}(A)$ in Example 3.11; see also Example 3.17.

Example 3.4. Let $X = \{N, E, S, W, U\}$, where $N = (0, 1)$, $E = (1, 0)$, $S = (0, -1)$, $W = (-1, 0)$ and $U = (1, 1)$. The graphs $\Gamma_X^{\mathcal{C}_1}$, $\Gamma_X^{\mathcal{C}_2}$ and $\Gamma_X^{\mathcal{C}_3}$ are pictured in Figure 20, for the three submonoids

$$\mathcal{C}_1 = \{(a, a) : a \in \mathbb{Z}\}, \quad \mathcal{C}_2 = \mathbb{N}^2, \quad \mathcal{C}_3 = \{O\} \cup \mathbb{P}^2.$$

In particular, we see from the pair (X, \mathcal{C}_1) that it is possible for \mathcal{A}_X and \mathcal{C} both to be groups, but $\mathcal{A}_X^\mathcal{C}$ not to be.

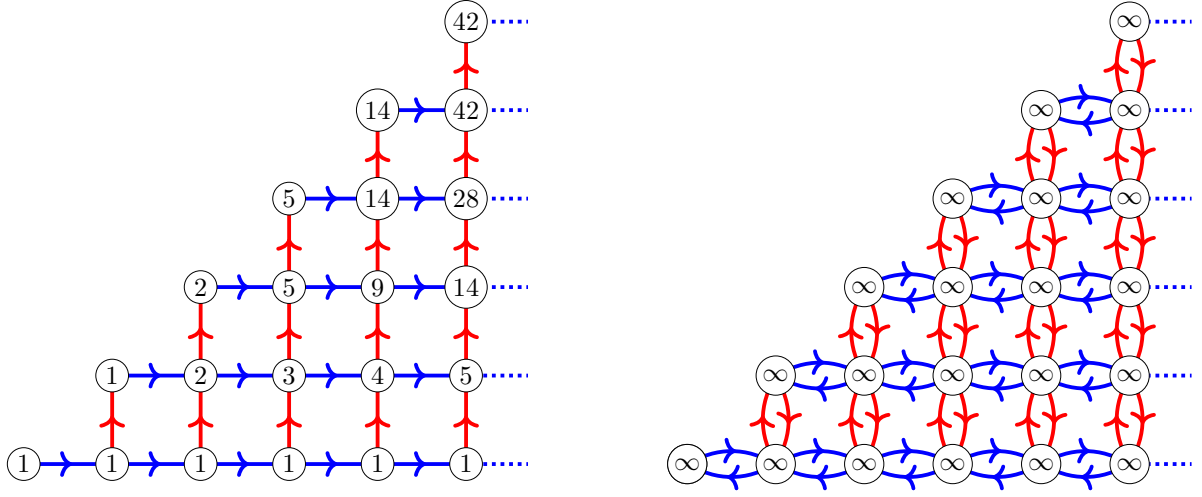

Figure 19: The graphs $\Gamma_X^{\mathcal{C}}$ (left) and $\Gamma_Y^{\mathcal{C}}$, where $X = \{(1,0), (0,1)\}$, $Y = \{(\pm 1,0), (0, \pm 1)\}$ and $\mathcal{C} = \{(a,b) \in \mathbb{N}^2 : b \leq a\}$; cf. Example 3.3.

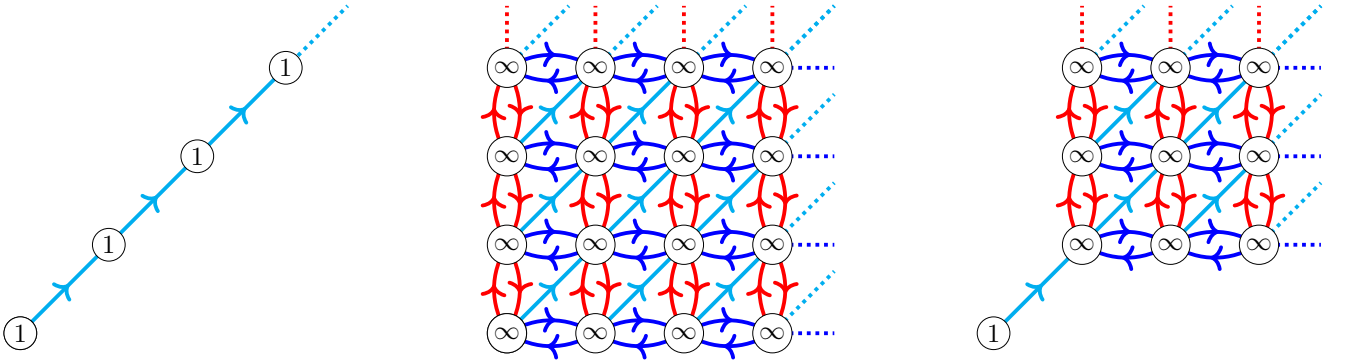

Figure 20: The graphs $\Gamma_X^{\mathcal{C}_1}$ (left), $\Gamma_X^{\mathcal{C}_2}$ (middle) and $\Gamma_X^{\mathcal{C}_3}$ (right), where $X = \{(\pm 1,0), (0, \pm 1), (1,1)\}$, $\mathcal{C}_1 = \{(a,a) : a \in \mathbb{Z}\}$, $\mathcal{C}_2 = \mathbb{N}^2$ and $\mathcal{C}_3 = \{O\} \cup \mathbb{P}^2$; cf. Example 3.4.

Remark 3.5. Consider a step set $X \subseteq \mathbb{Z}_X^2$ and a submonoid \mathcal{C} of \mathbb{Z}^2 . Above, we have only spoken of (X, \mathcal{C}) -walks from the origin O to a point A , but it is possible to speak of (X, \mathcal{C}) -walks from A to B for arbitrary $A, B \in \mathbb{Z}^2$. These would be X -walks $w \in \Pi_X(A, B)$ such that $A + \alpha_X(\sigma_m(w)) \in \mathcal{C}$ for all $0 \leq m \leq \ell(w)$; for such a walk to exist, it must of course be the case that $A, B \in \mathcal{C}$. Let $\Pi_X^{\mathcal{C}}(A, B)$ and $\pi_X^{\mathcal{C}}(A, B)$ denote the set and number of (X, \mathcal{C}) -walks from A to B . Then one may easily show that

$$\Pi_X^{\mathcal{C}}(A, B) \subseteq \Pi_X^{\mathcal{C}}(A + C, B + C) \quad \text{and} \quad \pi_X^{\mathcal{C}}(A, B) \leq \pi_X^{\mathcal{C}}(A + C, B + C) \quad \text{for any } C \in \mathcal{C},$$

though these can be strict. (For instance, if X and \mathcal{C} are as in Example 3.3, then with $A = (0,0)$, $B = (1,1)$ and $C = (1,0)$, we have $NE \in \Pi_X^{\mathcal{C}}(A+C, B+C) \setminus \Pi_X^{\mathcal{C}}(A, B)$; cf. Figure 19.) Thus, the (X, \mathcal{C}) -walks from the origin alone do not generally capture all information about (X, \mathcal{C}) -walks between arbitrary points, in contrast to the situation with unconstrained walks; cf. (2.2). It is possible to define a structure that incorporates all such (X, \mathcal{C}) -walks; namely, the *category* with object set \mathcal{C} , and morphism sets $\text{Hom}(A, B) = \Pi_X^{\mathcal{C}}(A, B)$ for each $A, B \in \mathcal{C}$. We believe it would be interesting to study such categories, but it is beyond the scope of the current work.

3.2 Recursion and further examples

The next result is a constrained version of Lemma 2.14; note that in the statement we do not assume \mathcal{C} is a monoid. The proof is a simple adaptation of that of Lemma 2.14; one must just check at various stages that certain points belong to \mathcal{C} . Again, we use \sqcup to denote disjoint union.

Lemma 3.6. Let $X \subseteq \mathbb{Z}_\times^2$ be an arbitrary step set, and let \mathcal{C} be a subset of \mathbb{Z}^2 containing O .

- (i) For any $A \in \mathbb{Z}^2$ and $B \in X$ with $A + B \in \mathcal{C}$, we have $\Pi_X^\mathcal{C}(A)B \subseteq \Pi_X^\mathcal{C}(A + B)$.
- (ii) For any $A \in \mathcal{A}_X^\mathcal{C} \setminus \{O\}$,

$$\Pi_X^\mathcal{C}(A) = \bigsqcup_{B \in X} \Pi_X^\mathcal{C}(A - B)B \quad \text{and} \quad \pi_X^\mathcal{C}(A) = \sum_{B \in X} \pi_X^\mathcal{C}(A - B). \quad \square$$

As in Proposition 2.15, we may use Lemma 3.6(ii) as the basis for a recurrence relation that may be used to calculate the values of $\pi_X^\mathcal{C}(A)$ in certain circumstances. For the statement of the next result, and for future use, we make the following definition:

- We say that the pair (X, \mathcal{C}) has the *Bounded Paths Property* (BPP) if for all $A \in \mathcal{A}_X^\mathcal{C}$, the set $\{\ell(w) : w \in \Pi_X^\mathcal{C}(A)\}$ has a maximum element (equivalently, this set is finite).

There are also analogous notions of the FPP and IPP:

- We say that the pair (X, \mathcal{C}) has the *Finite Paths Property* (FPP) if $\pi_X^\mathcal{C}(A) < \infty$ for all $A \in \mathcal{A}_X^\mathcal{C}$.
- We say that the pair (X, \mathcal{C}) has the *Infinite Paths Property* (IPP) if $\pi_X^\mathcal{C}(A) = \infty$ for all $A \in \mathcal{A}_X^\mathcal{C}$.

Proposition 3.7. Let $X \subseteq \mathbb{Z}_\times^2$ be a step set, and \mathcal{C} a subset of \mathbb{Z}^2 containing O , such that (X, \mathcal{C}) has the BPP. Then the values $\pi_X^\mathcal{C}(A)$, $A \in \mathbb{Z}^2$, are generated by the recurrence

$$\pi_X^\mathcal{C}(O) = 1 \tag{3.8}$$

$$\pi_X^\mathcal{C}(A) = 0 \quad \text{if } A \in \mathbb{Z}^2 \setminus \mathcal{A}_X^\mathcal{C} \tag{3.9}$$

$$\pi_X^\mathcal{C}(A) = \sum_{B \in X} \pi_X^\mathcal{C}(A - B) \quad \text{if } A \in \mathcal{A}_X^\mathcal{C} \setminus \{O\}. \tag{3.10}$$

Proof. The proof is essentially the same as that of Proposition 2.15, this time utilising the parameter defined by $L(A) = \max\{\ell(w) : w \in \Pi_X^\mathcal{C}(A)\}$ for $A \in \mathcal{A}_X^\mathcal{C}$. \square

We will say more in Section 4 about the practical implementation of the recurrence from Proposition 3.7. We now consider several related families of examples. The first two use the (well-studied) step sets from Examples 2.23 and 2.24.

Example 3.11 (Catalan triangle, cf. Example 2.23). Let $X = \{U, D\}$, where $U = (1, 1)$ and $D = (1, -1)$, and let $\mathcal{C} = \mathbb{N}^2$. Then $\mathcal{A}_X^\mathcal{C} = \{(a, b) \in \mathbb{N} \times \mathbb{N} : b \leq a, a \equiv b \pmod{2}\}$. The graph $\Gamma_X^\mathcal{C}$ is pictured in Figure 21 (left), with the values of $\pi_X^\mathcal{C}(A)$ computed using Proposition 3.7; note that (3.10) yields the recurrence

$$\pi_X^\mathcal{C}(a, b) = \pi_X^\mathcal{C}(a - 1, b - 1) + \pi_X^\mathcal{C}(a - 1, b + 1).$$

Together with (3.8) and (3.9), it is easy to give an inductive proof of the well-known formula

$$\pi_X^\mathcal{C}(a, b) = \frac{b + 1}{a + 1} \binom{a + 1}{\frac{a - b}{2}}.$$

The numbers $\pi_X^\mathcal{C}(A)$ form the *Catalan Triangle*; see [1, A009766, A033184 or A053121]. The numbers $C_n = \pi_X^\mathcal{C}(2n, 0)$ are the *Catalan numbers*, given by $C_n = \frac{1}{2n+1} \binom{2n+1}{n} = \frac{1}{n+1} \binom{2n}{n}$; see [1, A000108], and also [34] for a recent account of the many places Catalan numbers appear; ‘‘Catalan mania’’ is also discussed in [29, Section 3.5.2]. Note that the numbers arising in this example are the same as those in Example 3.3; see also Example 3.17.

Example 3.12 (Motzkin triangle, cf. Example 2.24). Let $X = \{U, D, F\}$, where $U = (1, 1)$, $D = (1, -1)$ and $F = (1, 0)$, and let $\mathcal{C} = \mathbb{N}^2$. Then $\mathcal{A}_X^\mathcal{C} = \{(a, b) \in \mathbb{N} \times \mathbb{N} : b \leq a\}$. The graph $\Gamma_X^\mathcal{C}$ is pictured in Figure 21 (right), with the values of $\pi_X^\mathcal{C}(A)$ computed using Proposition 3.7; note that (3.10) yields the usual recurrence

$$\pi_X^\mathcal{C}(a, b) = \pi_X^\mathcal{C}(a - 1, b - 1) + \pi_X^\mathcal{C}(a - 1, b) + \pi_X^\mathcal{C}(a - 1, b + 1).$$

The numbers $\pi_X^{\mathcal{C}}(A)$ form the *Motzkin Triangle*; see [1, A026300]. The numbers $M_n = \pi_X^{\mathcal{C}}(n, 0)$ are the *Motzkin numbers*; see [1, A001006]. To the authors' knowledge, no closed formula is known for the numbers $\pi_X^{\mathcal{C}}(a, b)$ or even for M_n . However, as in Example 2.24, by considering the effect of deleting all F 's from a word from $\Pi_X^{\mathcal{C}}(a, b)$, and using the formula for $\pi_{\{U, D\}}^{\mathcal{C}}(A)$ from Example 3.11, we may obtain the (certainly well-known) formula

$$\pi_X^{\mathcal{C}}(a, b) = \sum_{r=0}^a \binom{a}{r} \pi_{\{U, D\}}^{\mathcal{C}}(a-r, b) = \sum_{r=0}^a \frac{b+1}{a-r+1} \binom{a}{r} \binom{a-r+1}{\frac{a-b-r}{2}}.$$

The sum " $\sum_{r=0}^a$ " in the last expression may be replaced by " $\sum_{r=0}^{a-b}$ " in light of the second binomial coefficient. In particular, when $(a, b) = (n, 0)$, we obtain the (well-known) formula for the n th Motzkin number:

$$M_n = \pi_X^{\mathcal{C}}(n, 0) = \sum_{r=0}^n \binom{n}{r} \frac{1}{n-r+1} \binom{n-r+1}{\frac{n-r}{2}} = \sum_{r=0}^n \binom{n}{r} C_{(n-r)/2},$$

where $C_k = \frac{1}{2k+1} \binom{2k+1}{k}$ is the k th Catalan number if $k \in \mathbb{N}$, and $C_k = 0$ if $k \notin \mathbb{N}$.

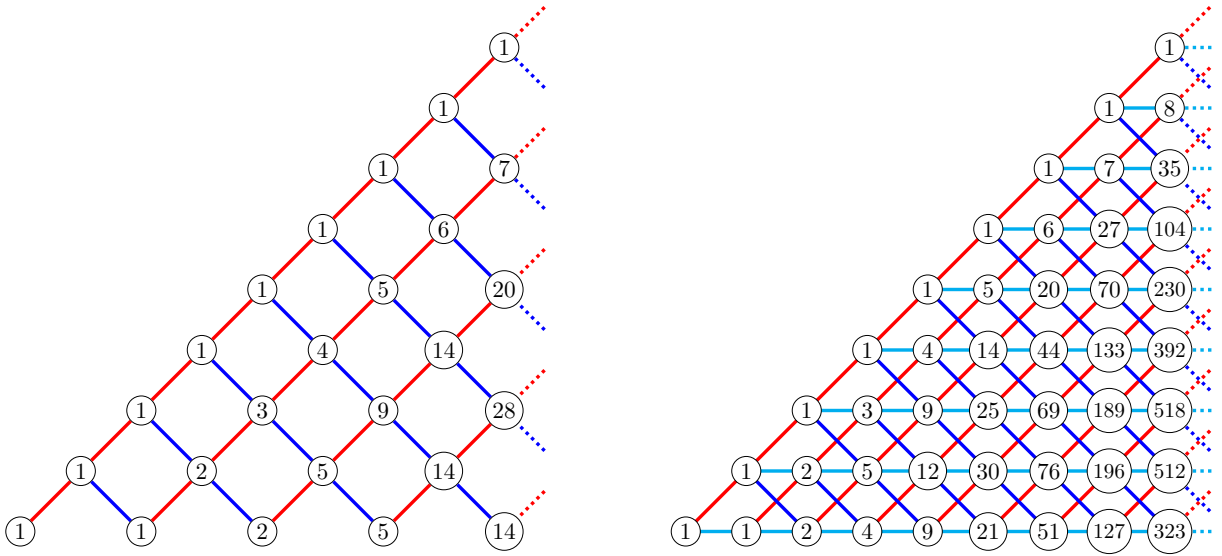

Figure 21: The graph $\Gamma_X^{\mathcal{C}}$, where $X = \{(1, 1), (1, -1)\}$ (left) and $X = \{(1, 1), (1, 0), (1, -1)\}$ (right), and $\mathcal{C} = \mathbb{N}^2$; cf. Examples 3.11 and 3.12. All edges are directed to the right.

The next example involves step sets that are natural generalisations of those in Examples 3.11 and 3.12. Other generalisations lead to extensions of the classical ballot problem [4, 15, 20, 35] and connections with Young tableaux [17], among others; see also [18, 19] on applications to representation theory, [5, 6] on matroid theory, and [25, Chapter 4] on planar diagram monoids.

Example 3.13 (Generalised Catalan and Motzkin triangles). For $m \in \mathbb{P}$, define the steps $U_m = (1, m)$ and $D_m = (1, -m)$. Also write $F = (1, 0)$, and define the step sets

$$Y_m = \{U_i, D_i : 1 \leq i \leq m\} \quad \text{and} \quad X_m = Y_m \cup \{F\}.$$

So Y_1 and X_1 are the step sets considered in Examples 3.11 and 3.12, respectively. From now on, we assume that $m \geq 2$. Let $\mathcal{C} = \mathbb{N}^2$. One may check that (for $m \geq 2$)

$$\begin{aligned} \mathcal{A}_{X_m} &= \{(a, b) \in \mathbb{N} \times \mathbb{Z} : |b| \leq ma\}, & \mathcal{A}_{Y_m} &= \mathcal{A}_{X_m} \setminus \{(1, 0)\}, \\ \mathcal{A}_{X_m}^{\mathcal{C}} &= \{(a, b) \in \mathbb{N}^2 : b \leq ma\}, & \mathcal{A}_{Y_m}^{\mathcal{C}} &= \mathcal{A}_{X_m}^{\mathcal{C}} \setminus \{(1, 0)\}. \end{aligned}$$

Formulae for the numbers $\pi_{X_m}(A)$, $\pi_{X_m}^{\mathcal{C}}(A)$, $\pi_{Y_m}(A)$ and $\pi_{Y_m}^{\mathcal{C}}(A)$ are given in [3] in terms of so-called m -nomial and mock m -nomial coefficients. If we write $\binom{n}{k}_m$ and $\binom{n}{k}_{2m}^*$ for the coefficients of x^k in the expansions of $(1 + x + x^2 + \dots + x^{m-1})^n$ and $(1 + x + \dots + x^{m-1} + x^{m+1} + x^{m+2} + \dots + x^{2m})^n$, respectively, then [3, Theorems 4.3 and 4.8] give

$$\pi_{X_m}(a, b) = \binom{a}{b+ma}_{2m+1} \quad \text{and} \quad \pi_{Y_m}(a, b) = \binom{a}{b+ma}_{2m}^*.$$

Expressions for $\pi_{X_m}^{\mathcal{C}}$ and $\pi_{Y_m}^{\mathcal{C}}$ are given in [3, Theorems 4.6 and 4.10] as sums of (mock) m -nomial coefficients. The graphs Γ_{Y_2} and Γ_{X_2} are given in Figure 22, and $\Gamma_{Y_2}^{\mathcal{C}}$ and $\Gamma_{X_2}^{\mathcal{C}}$ in Figure 23. One may see, for example, the numbers in the third column of Γ_{Y_2} in the expansion

$$(1 + x + x^3 + x^4)^3 = x^{12} + 3x^{11} + 3x^{10} + 4x^9 + 9x^8 + 9x^7 + 6x^6 + 9x^5 + 9x^4 + 4x^3 + 3x^2 + 3x + 1.$$

The article [3] contains numerous lists of relevant entries on the OEIS [1]. The step set Y_3 is used to model the change in score-differences in basketball games (where scores of 1, 2 or 3 are possible); given the nationality of the authors, we believe it would be interesting to study the step set $\{U_1, U_6, D_1, D_6\}$.

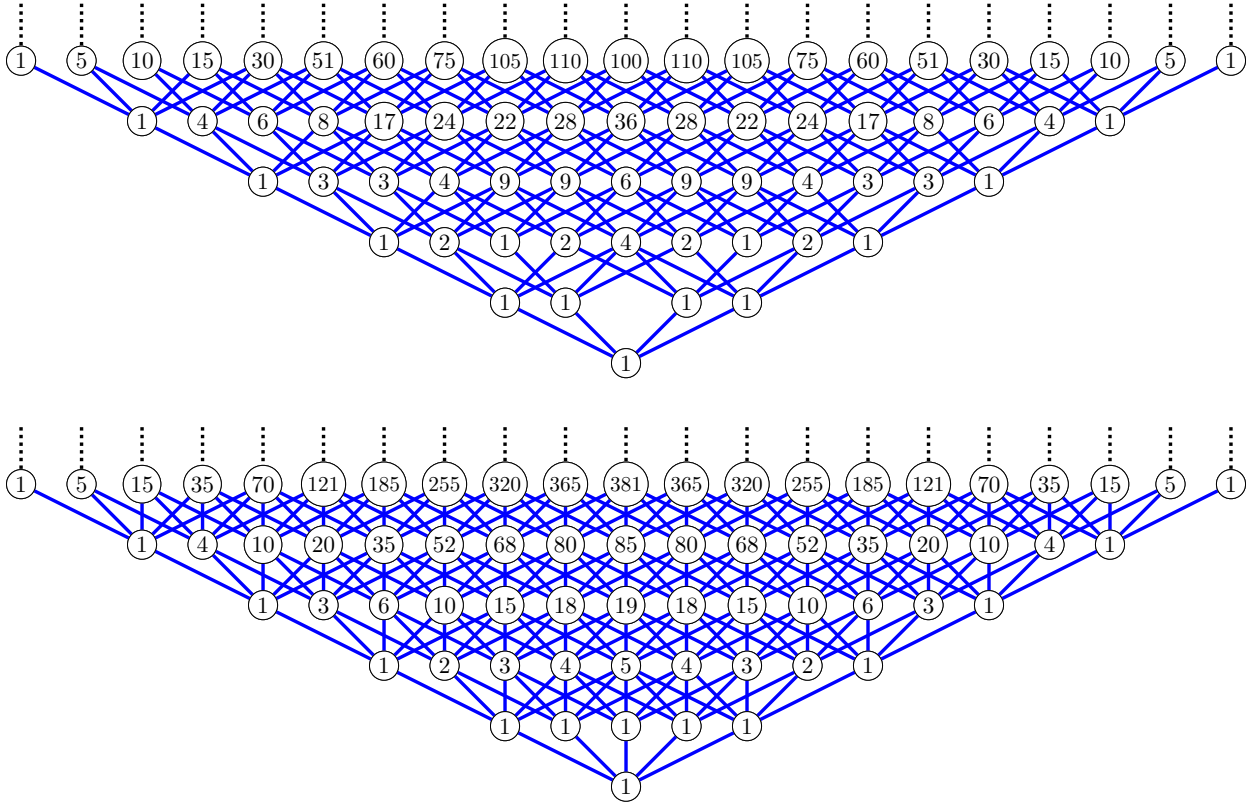

Figure 22: The graphs Γ_{Y_2} (top) and Γ_{X_2} (bottom), where $Y_2 = \{(1, \pm 1), (1, \pm 2)\}$ and $X_2 = \{(1, 0), (1, \pm 1), (1, \pm 2)\}$; cf. Example 3.13. For reasons of space, the graphs have been rotated 90° . All edges are directed towards the positive x -axis.

The next examples are infinite versions of the previous two families.

Example 3.14. We use the notation U_m, D_m and F from Example 3.13. This time we define the step sets

$$Y = Y_\infty = \{U_i, D_i : i \in \mathbb{P}\} \quad \text{and} \quad X = X_\infty = Y \cup \{F\}.$$

Note that $X = \{1\} \times \mathbb{Z}$ has already been considered (in the unconstrained setting) in Example 2.5. Neither X nor Y has the FPP (or the IPP), though they both have the BPP by virtue of the SLC (cf. Theorem 2.44). Thus, to obtain any interesting sequences to enumerate, we must consider X - and Y -walks restricted to some region \mathcal{C} . The most natural region is perhaps $\mathcal{C} = \{(a, b) \in \mathbb{N}^2 : b \leq a\}$. Then one may check that

$$\mathcal{A}_X^{\mathcal{C}} = \mathcal{C} \quad \text{and} \quad \mathcal{A}_Y^{\mathcal{C}} = \mathcal{C} \setminus \{(1, 0), (2, 1)\}.$$

The graphs $\Gamma_X^{\mathcal{C}}$ and $\Gamma_Y^{\mathcal{C}}$ are given in Figure 24, using Proposition 3.7 to compute the values of $\pi_X^{\mathcal{C}}(A)$ and $\pi_Y^{\mathcal{C}}(A)$. As suggested by Figure 24, we have $\pi_X^{\mathcal{C}}(a, b) = a!$ for all $(a, b) \in \mathcal{A}_X^{\mathcal{C}}$. Indeed, this is easy to understand. Any X -walk from O to (a, b) must have length a , as all steps from X have x -coordinate equal to 1; for any such walk $A_1 \cdots A_a \in \Pi_X^{\mathcal{C}}(a, b)$, we may choose the steps A_1, \dots, A_{a-1} in $2, 3, \dots, a$ ways (respectively), to ensure that we remain in \mathcal{C} at each step, but then the step A_a is fixed. The formula $\pi_X^{\mathcal{C}}(a, b) = a!$ may also be deduced from the recurrence in Proposition 3.7.

To obtain a formula for $\pi_Y^{\mathcal{C}}(a, b)$, we begin with two claims. For convenience in what follows, we define $(-1)! = 1$.

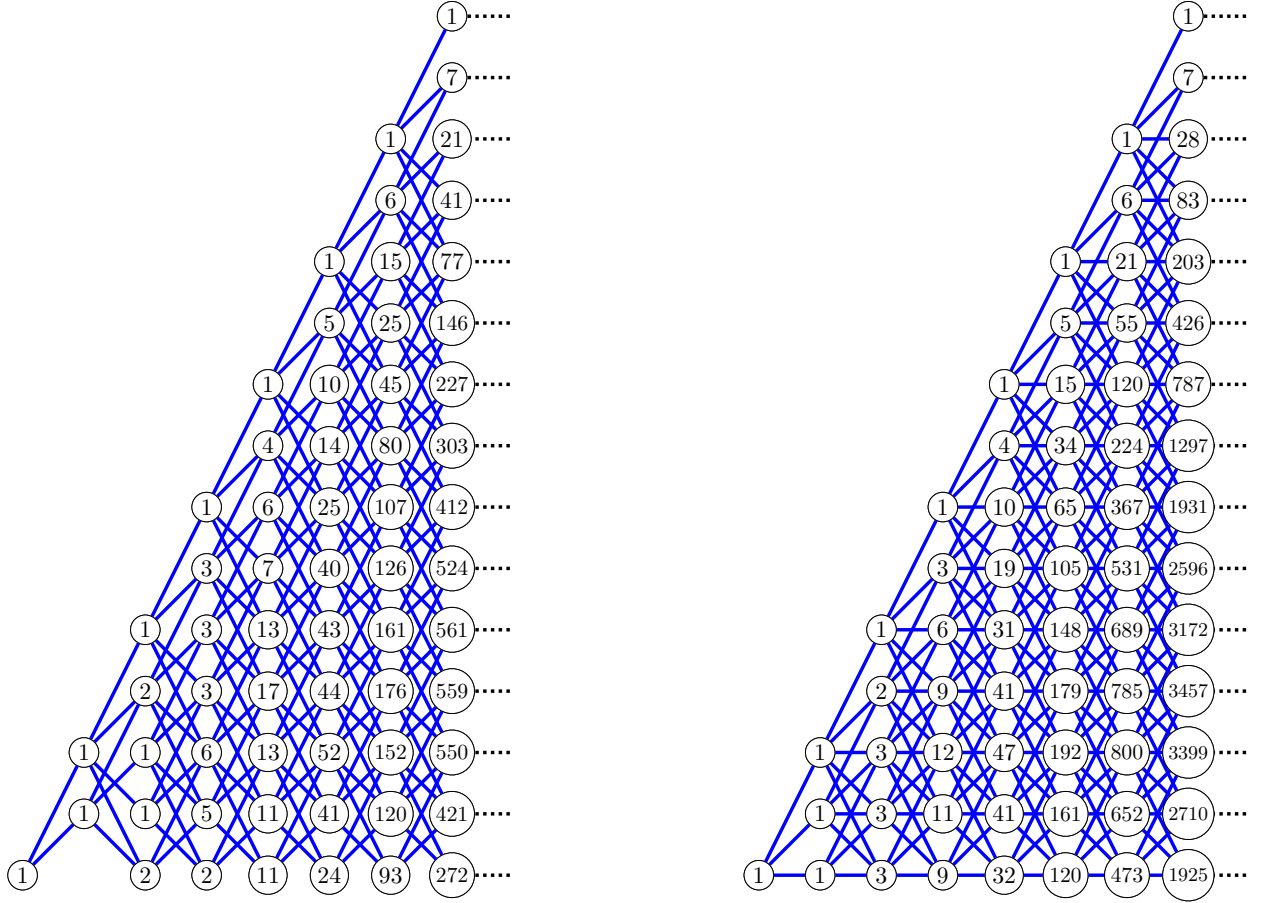

Figure 23: The graphs $\Gamma_{Y_2}^{\mathcal{C}}$ (left) and $\Gamma_{X_2}^{\mathcal{C}}$ (right), where $Y_2 = \{(1, \pm 1), (1, \pm 2)\}$ and $X_2 = \{(1, 0), (1, \pm 1), (1, \pm 2)\}$, and $\mathcal{C} = \mathbb{N}^2$; cf. Example 3.13. All edges are directed to the right.

- **Claim 1.** For any $a \in \mathbb{N}$, we have $\pi_Y^{\mathcal{C}}(a, a) = (a - 1)!$.

Indeed, this follows from essentially the same argument as used above to show that $\pi_X^{\mathcal{C}}(a, b) = a!$: a Y -walk from O to (a, a) involves an arbitrary Y -walk into the $(a - 1)$ th column (of which there are $(a - 1)!$), and then the appropriate (and uniquely determined) final step to end at (a, a) . The same kind of argument also shows the following:

- **Claim 2.** For any $a \in \mathbb{N}$, we have $\sum_{r=0}^a \pi_Y^{\mathcal{C}}(a, r) = a!$.

Now suppose $(a, b) \in \mathcal{A}_Y^{\mathcal{C}}$ is such that $b < a$ (so also $a \geq 1$). Proposition 3.7(iii) and Claim 2 give

$$\pi_Y^{\mathcal{C}}(a, b) = \sum_{\substack{r=0 \\ r \neq b}}^a \pi_Y^{\mathcal{C}}(a - 1, r) = \sum_{r=0}^a \pi_Y^{\mathcal{C}}(a - 1, r) - \pi_Y^{\mathcal{C}}(a - 1, b) = (a - 1)! - \pi_Y^{\mathcal{C}}(a - 1, b). \quad (3.15)$$

If $b < a - 1$, we may apply (3.15) again to obtain

$$\pi_Y^{\mathcal{C}}(a, b) = (a - 1)! - \pi_Y^{\mathcal{C}}(a - 1, b) = (a - 1)! - (a - 2)! + \pi_Y^{\mathcal{C}}(a - 2, b).$$

Applying this repeatedly, until we reach a term involving $\pi_Y^{\mathcal{C}}(b, b) = (b - 1)!$, we obtain

$$\pi_Y^{\mathcal{C}}(a, b) = (a - 1)! - (a - 2)! + \cdots + (-1)^{a-b}(b - 1)! = \sum_{r=b-1}^{a-1} (-1)^{a-r+1} r! = \sum_{r=1}^{a-b+1} (-1)^{r+1} (a - r)!, \quad (3.16)$$

an alternating sum of factorials. In light of Claim 1, we see that (3.16) is also valid when $b = a \geq 0$, keeping in mind the convention $(-1)! = 1$. Note that the sum in (3.16) gives 0 if $(a, b) = (1, 0)$ or $(2, 1)$.

At the time of writing, the numbers $\pi_Y^{\mathcal{C}}(a, b)$ did not appear on [1]. However, the numbers

$$\pi_Y^{\mathcal{C}}(n + 1, 0) = n! - (n - 1)! + (n - 2)! - \cdots + (-1)^{n+1} 1!$$

appear on [1, A005165]. (Note that the terms $\pm 0!$ and $\mp(-1)!$ at the end of the sum for $\pi_Y^{\mathcal{C}}(n+1, 0)$ in (3.16) cancel out.) This last number sequence appears on the x -axis in Figure 24 (right).

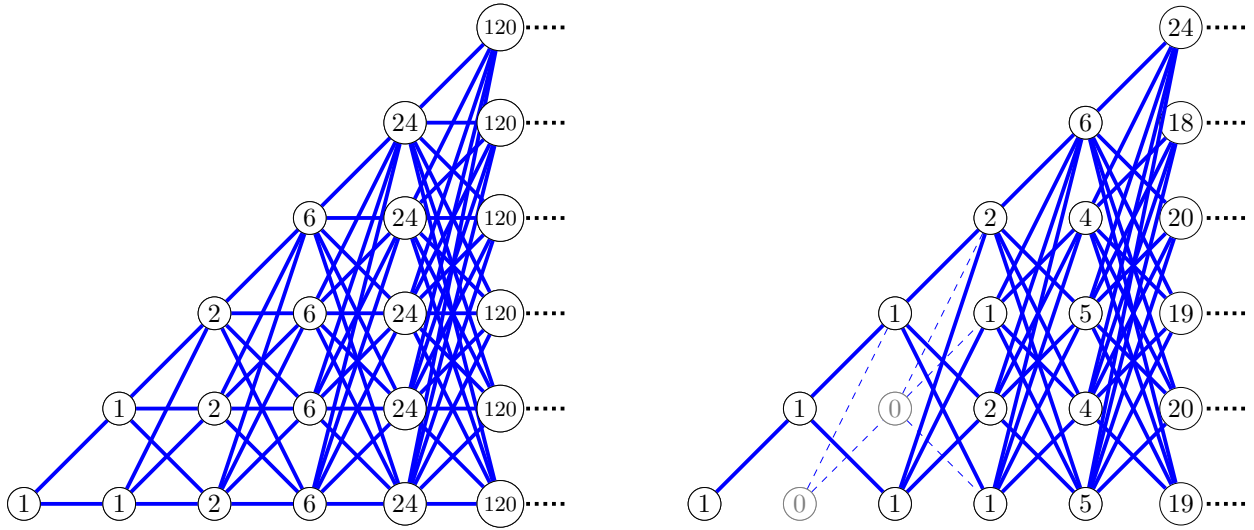

Figure 24: The graphs $\Gamma_X^{\mathcal{C}}$ (left) and $\Gamma_Y^{\mathcal{C}}$ (right), where $X = \{1\} \times \mathbb{Z}$, $Y = \{1\} \times (\mathbb{Z} \setminus \{0\})$ and $\mathcal{C} = \{(a, b) \in \mathbb{N}^2 : b \leq a\}$; cf. Example 3.14. All edges are directed to the right. In $\Gamma_Y^{\mathcal{C}}$, the two vertices from $\mathcal{A}_X^{\mathcal{C}} \setminus \mathcal{A}_Y^{\mathcal{C}}$ have been included in faint print for convenience.

We conclude this section with another infinite step set; it may be thought of as a “positive version” of the step set X from Example 3.14.

Example 3.17 (cf. Example 2.6). Let $X = \{1\} \times \mathbb{N}$ be the step set from Example 2.6, and let $\mathcal{C} = \{(a, b) \in \mathbb{N}^2 : b \leq a\}$. Here we have $\mathcal{A}_X^{\mathcal{C}} = \mathcal{C}$, and the graph $\Gamma_X^{\mathcal{C}}$ is pictured in Figure 25. Note that the vertex labels $\pi_X^{\mathcal{C}}(A)$ are precisely the same as those from Example 3.3, and are even in the same locations; cf. Figure 19. Indeed, we use the recurrence from Proposition 3.7 twice to see that for $a \geq 1$ and $0 \leq b \leq a$,

$$\pi_X^{\mathcal{C}}(a, b) = \sum_{r=0}^b \pi_X^{\mathcal{C}}(a-1, r) = \pi_X^{\mathcal{C}}(a-1, b) + \sum_{r=0}^{b-1} \pi_X^{\mathcal{C}}(a-1, r) = \pi_X^{\mathcal{C}}(a-1, b) + \pi_X^{\mathcal{C}}(a, b-1),$$

which is the same recurrence as that from Example 3.3. (The sum $\sum_{r=0}^{b-1} \pi_X^{\mathcal{C}}(a-1, r)$ is empty if $b = 0$, in which case also $\pi_X^{\mathcal{C}}(a, b-1) = 0$.) Of course the numbers $\pi_X^{\mathcal{C}}(A)$ are the same as those from Example 3.11 as well, just in different locations of the plane; cf. Figure 21. In [11], Coker considers a different class of (constrained) lattice path problems involving infinite step sets, also leading to natural finite enumeration.

3.3 Geometric conditions and finiteness properties for constrained walks

The proof of Lemma 2.9 works essentially unchanged to show that for any step set X , and for any submonoid \mathcal{C} of \mathbb{Z}^2 ,

$$(X, \mathcal{C}) \text{ has the IPP} \Leftrightarrow \pi_X^{\mathcal{C}}(O) = \infty \Leftrightarrow \pi_X^{\mathcal{C}}(O) \geq 2. \quad (3.18)$$

We also have a constrained version of Theorem 2.44, relating the above finiteness conditions on (X, \mathcal{C}) to the geometric conditions on X introduced in Section 2.3. To make the following statement clearer, we write $P \models Q$ to mean “ P satisfies Q ”.

Theorem 3.19. (i) *For an arbitrary step set $X \subseteq \mathbb{Z}_x^2$, and for an arbitrary submonoid \mathcal{C} of \mathbb{Z}^2 , we have:*

$$\begin{array}{ccccc} X \models CC & \Rightarrow & X \models SLC & \Rightarrow & X \models LC \\ \downarrow & & \downarrow & & \downarrow \\ (X, \mathcal{C}) \models FPP & \Rightarrow & (X, \mathcal{C}) \models BPP & \Rightarrow & (X, \mathcal{C}) \not\models IPP \end{array} \quad (3.20)$$

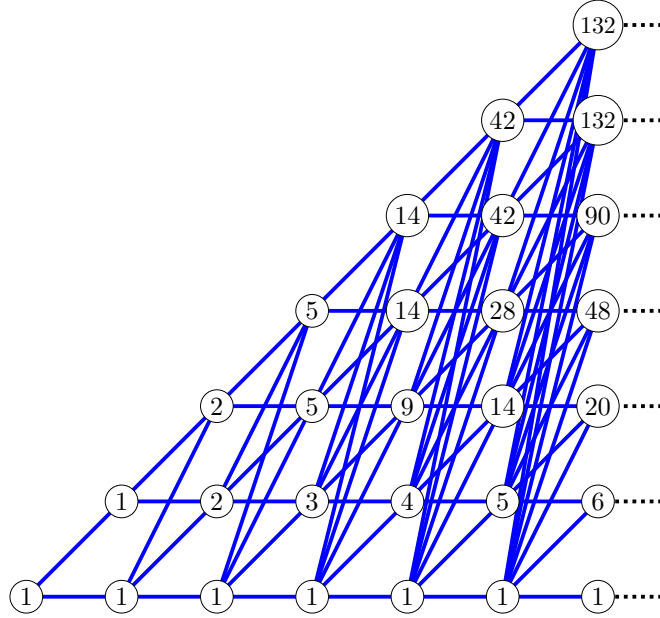

Figure 25: The graph $\Gamma_X^{\mathcal{C}}$, where $X = \{1\} \times \mathbb{N}$ and $\mathcal{C} = \{(a, b) \in \mathbb{N}^2 : b \leq a\}$; cf. Example 3.17. All edges are directed to the right.

(ii) For finite X , some but not all of the implications in (3.20) are reversible; these are indicated as follows:

$$\begin{array}{ccccc}
 X \models CC & \Leftrightarrow & X \models SLC & \Leftrightarrow & X \models LC \\
 \Downarrow & & \Downarrow & & \Downarrow \\
 (X, \mathcal{C}) \models FPP & \Leftrightarrow & (X, \mathcal{C}) \models BPP & \Rightarrow & (X, \mathcal{C}) \not\models IPP
 \end{array}$$

(iii) In general, none of the implications in (3.20) are reversible.

Proof. (i). The top row of “horizontal” implications have already been proven in Lemma 2.12. The “vertical” implications follow from Theorem 2.44(i) and the obvious facts that

$$X \models FPP \Rightarrow (X, \mathcal{C}) \models FPP, \quad X \models BPP \Rightarrow (X, \mathcal{C}) \models BPP, \quad X \not\models IPP \Rightarrow (X, \mathcal{C}) \not\models IPP.$$

The bottom row of “horizontal” implications are proved in analogous fashion to Lemma 2.10.

(ii). Suppose X is finite. We begin with the non-reversible implications. The pair (X, \mathcal{C}_3) from Example 3.4 satisfies neither the IPP nor the BPP; this shows that the implication $(X, \mathcal{C}) \models BPP \Rightarrow (X, \mathcal{C}) \not\models IPP$ is not reversible in general (even for finite X). The pair (X, \mathcal{C}_1) from the same example satisfies the FPP, but X does not satisfy the LC; this takes care of all the “vertical” (non-)implications.

The two “horizontal” implications on the top row are reversible because of Lemma 2.12(iii). The only remaining implication to demonstrate is $(X, \mathcal{C}) \models BPP \Rightarrow (X, \mathcal{C}) \models FPP$. So suppose (X, \mathcal{C}) satisfies the BPP. Let $A \in \mathcal{A}_X^{\mathcal{C}}$ be arbitrary. Writing $L = \max\{\ell(w) : w \in \Pi_X^{\mathcal{C}}(A)\}$, we see that $\Pi_X^{\mathcal{C}}(A)$ is contained in the set $\{w \in \mathcal{F}_X : \ell(w) \leq L\}$; since the latter is finite (as X is finite), so too is $\Pi_X^{\mathcal{C}}(A)$.

(iii). The proof of Theorem 2.44(iii) remains valid here, upon taking $\mathcal{C} = \mathbb{Z}^2$. \square

Remark 3.21. With different formatting, perhaps the implications in Theorem 3.19(ii) appear clearer as:

$$[X \models CC \Leftrightarrow X \models SLC \Leftrightarrow X \models LC] \Rightarrow [(X, \mathcal{C}) \models FPP \Leftrightarrow (X, \mathcal{C}) \models BPP] \Rightarrow (X, \mathcal{C}) \models IPP,$$

for finite X .

There are also analogues of Theorems 2.36 and 2.51 for constrained walks, although these are somewhat more subtle than the unconstrained versions. We begin with a lemma that motivates the discussion to follow; it shows that the conditions $O \in \text{Conv}(X)$ and $O \in \text{Rel-Int}(\text{Conv}(X))$ considered in Theorems 2.36 and 2.51 are equivalent to ostensibly weaker conditions.

Lemma 3.22. *Let $X \subseteq \mathbb{Z}_x^2$ be an arbitrary step set. Then*

- (i) $O \in \text{Conv}(X) \Leftrightarrow O \in \text{Conv}(\mathcal{A}_X \setminus \{O\})$,
- (ii) $O \in \text{Rel-Int}(\text{Conv}(X)) \Leftrightarrow O \in \text{Rel-Int}(\text{Conv}(\mathcal{A}_X \setminus \{O\}))$.

Proof. Write $Y = \mathcal{A}_X \setminus \{O\}$, noting that $\mathcal{A}_Y = \mathcal{A}_X$. For part (i) we have

$$\begin{aligned} O \in \text{Conv}(X) &\Leftrightarrow \mathcal{A}_X \text{ has non-trivial units} && \text{by Theorem 2.36} \\ &\Leftrightarrow \mathcal{A}_Y \text{ has non-trivial units} && \text{as } \mathcal{A}_X = \mathcal{A}_Y \\ &\Leftrightarrow O \in \text{Conv}(Y) && \text{by Theorem 2.36 again.} \end{aligned}$$

Part (ii) is treated in similar fashion, using Theorem 2.51 instead of Theorem 2.36. \square

In light of Theorem 2.36 and Lemma 3.22(i), we see that for any step set $X \subseteq \mathbb{Z}_x^2$,

$$X \models \text{IPP} \Leftrightarrow O \in \text{Conv}(X) \Leftrightarrow O \in \text{Conv}(\mathcal{A}_X \setminus \{O\}) \Leftrightarrow \mathcal{A}_X \text{ has non-trivial units.}$$

The next result considers the analogous conditions for pairs (X, \mathcal{C}) .

Proposition 3.23. *Let $X \subseteq \mathbb{Z}_x^2$ be an arbitrary step set, and let \mathcal{C} be a submonoid of \mathbb{Z}^2 . Consider the following statements:*

- (i) (X, \mathcal{C}) has the IPP,
- (ii) $O \in \text{Conv}(X)$,
- (iii) $O \in \text{Conv}(\mathcal{A}_X^\mathcal{C} \setminus \{O\})$,
- (iv) $\mathcal{A}_X^\mathcal{C}$ has non-trivial units.

Then the implications that hold among (i)–(iv) are precisely those inferrable from the following:

$$(iii) \Leftrightarrow (iv) \Rightarrow (i) \Rightarrow (ii).$$

Proof. We begin with the stated implications.

(iii) \Rightarrow (iv). Suppose $O \in \text{Conv}(\mathcal{A}_X^\mathcal{C} \setminus \{O\})$. Then O is a convex combination of some elements A_1, \dots, A_k of $\mathcal{A}_X^\mathcal{C} \setminus \{O\}$. We then follow the corresponding part of the proof of Theorem 2.36, and deduce that at least one of the A_i is a (non-trivial) unit.

(iv) \Rightarrow (iii). If $O = A + B$ for some $A, B \in \mathcal{A}_X^\mathcal{C} \setminus \{O\}$, then $O = \frac{1}{2}A + \frac{1}{2}B \in \text{Conv}(\mathcal{A}_X^\mathcal{C} \setminus \{O\})$.

(iv) \Rightarrow (i). Suppose $O = A + B$, where $A, B \in \mathcal{A}_X^\mathcal{C} \setminus \{O\}$. Then by definition, we have $A = \alpha_X(u)$ and $B = \alpha_X(v)$ for some $u, v \in \mathcal{F}_X^\mathcal{C} \setminus \{\varepsilon\}$. It quickly follows that $uv \in \Pi_X^\mathcal{C}(O) \setminus \{\varepsilon\}$, and so $\pi_X^\mathcal{C}(O) \geq 2$. But then (X, \mathcal{C}) has the IPP by (3.18).

(i) \Rightarrow (ii). This is exactly the same as the corresponding part of Theorem 2.36.

We now treat the non-implications. It suffices to show that (ii) $\not\Rightarrow$ (i) and (i) $\not\Rightarrow$ (iv).

(ii) $\not\Rightarrow$ (i). The pair (X, \mathcal{C}_1) from Example 3.4 satisfies (ii) but not (i).

(i) $\not\Rightarrow$ (iv). The pair (X, \mathcal{C}_2) from Example 3.4 satisfies (i) but not (iv). \square

In light of Theorem 2.51 and Lemma 3.22(ii), for any step set $X \subseteq \mathbb{Z}_x^2$, the monoid \mathcal{A}_X is a non-trivial group if and only if $O \in \text{Rel-Int}(\text{Conv}(\mathcal{A}_X \setminus \{O\}))$. The next result is a direct analogue of this last statement for constrained walks, and in fact follows quickly from the unconstrained version.

Proposition 3.24. *Let $X \subseteq \mathbb{Z}_x^2$ be an arbitrary step set, and let \mathcal{C} be a submonoid of \mathbb{Z}^2 . Then $\mathcal{A}_X^\mathcal{C}$ is a non-trivial group if and only if $O \in \text{Rel-Int}(\text{Conv}(\mathcal{A}_X^\mathcal{C} \setminus \{O\}))$.*

Proof. Let $Y = \mathcal{A}_X^\mathcal{C} \setminus \{O\}$, noting that $\mathcal{A}_Y = \mathcal{A}_X^\mathcal{C}$. Then by Theorem 2.51,

$$\mathcal{A}_X^\mathcal{C} \text{ is a non-trivial group} \Leftrightarrow \mathcal{A}_Y \text{ is a non-trivial group} \Leftrightarrow O \in \text{Rel-Int}(\text{Conv}(Y)). \quad \square$$

Remark 3.25. The condition $O \in \text{Rel-Int}(\text{Conv}(X))$ neither implies nor is implied by $\mathcal{A}_X^\mathcal{C}$ being a (non-trivial) group. For example:

- If $X = \{(1, 0), (-1, 0), (0, 1)\}$ and $\mathcal{C} = \mathbb{Z} \times \{0\}$, then $\mathcal{A}_X^\mathcal{C} = \mathcal{C}$ is a group, yet $O \notin \text{Rel-Int}(\text{Conv}(X))$.
- If (X, \mathcal{C}_1) is as in Example 3.4, then $O \in \text{Rel-Int}(\text{Conv}(X))$, yet $\mathcal{A}_X^{\mathcal{C}_1}$ is not a group.

But of course $\mathcal{A}_X^\mathcal{C}$ being a non-trivial group implies $O \in \text{Conv}(X)$ because of Proposition 3.23.

3.4 Admissible steps, and constraint sets containing lattice cones

Consider a pair (X, \mathcal{C}) , where $X \subseteq \mathbb{Z}_x^2$ is a step set, and \mathcal{C} a submonoid of \mathbb{Z}^2 . We say a step $A \in X$ is (X, \mathcal{C}) -admissible if there exist words $u, v \in \mathcal{F}_X$ such that $uAv \in \mathcal{F}_X^\mathcal{C}$. So the (X, \mathcal{C}) -admissible steps are those that may actually be used in (X, \mathcal{C}) -walks. Since any initial subword of an (X, \mathcal{C}) -walk is clearly an (X, \mathcal{C}) -walk (i.e., since $\mathcal{F}_X^\mathcal{C}$ is prefix-closed), $A \in X$ is (X, \mathcal{C}) -admissible if and only if there exists a word $u \in \mathcal{F}_X$ such that $uA \in \mathcal{F}_X^\mathcal{C}$, and then we also have $u \in \mathcal{F}_X^\mathcal{C}$ for any such u .

Note that if Y is the set of all (X, \mathcal{C}) -admissible steps, then we have $\mathcal{A}_X^\mathcal{C} = \mathcal{A}_Y^\mathcal{C}$, $\Gamma_X^\mathcal{C} = \Gamma_Y^\mathcal{C}$, and so on. In general, determining Y , given X and \mathcal{C} , is not always easy; however, it is easy in at least one special case we treat below. This section gives a number of strengthenings of results from previous sections based on admissible steps.

Theorem 3.26. *Let $X \subseteq \mathbb{Z}_x^2$ be a step set, let \mathcal{C} be a submonoid of \mathbb{Z}^2 , and let $Y \subseteq X$ be the set of (X, \mathcal{C}) -admissible steps. If Y is finite, then the following are equivalent:*

- (i) (X, \mathcal{C}) has the FPP,
- (ii) $O \notin \text{Conv}(Y)$,
- (iii) Y satisfies the LC.

Proof. (i) \Rightarrow (ii). We prove the contrapositive (and we note that for this implication we do not need to assume Y is finite). Suppose $O \in \text{Conv}(Y)$. As in the proof of Theorem 2.36, we have $O = xA + yB + zC$ for some $A, B, C \in Y$ and $x, y, z \in \mathbb{N}$ with x, y, z not all zero. (At this point it is worth noting that, in contrast to the unconstrained case, we may not simply deduce that $A^x B^y C^z$ belongs to $\Pi_X^\mathcal{C}(O)$.) Since A, B, C are (X, \mathcal{C}) -admissible, there exist $u, v, w \in \mathcal{F}_X$ such that $uA, vB, wC \in \mathcal{F}_X^\mathcal{C}$. As noted above, we also have $u, v, w \in \mathcal{F}_X^\mathcal{C}$. For convenience, we write $U = \alpha_X(u)$, $V = \alpha_X(v)$ and $W = \alpha_X(w)$. For $k \in \mathbb{N}$, define the word

$$g_k = u^x v^y w^z (A^x B^y C^z)^k.$$

Let $D = xU + yV + zW$. The proof will be complete if we can show that $g_k \in \Pi_X^\mathcal{C}(D)$ for all $k \in \mathbb{N}$, as then $\pi_X^\mathcal{C}(D) = \infty$. With this in mind, fix some $k \in \mathbb{N}$. Note that

$$\alpha_X(g_k) = xU + yV + zW + k(xA + yB + zC) = D + kO = D,$$

so that $g_k \in \Pi_X(D)$, so it remains to show that $g_k \in \mathcal{F}_X^\mathcal{C}$. To do so, we must show that $\alpha_X(\sigma_i(g_k)) \in \mathcal{C}$ for all $0 \leq i \leq \ell(g_k)$, so consider some such i . Note that

$$\ell(g_k) = \lambda + k\mu, \quad \text{where } \lambda = x\ell(u) + y\ell(v) + z\ell(w) \text{ and } \mu = x + y + z.$$

If $i \leq \lambda$, then $\sigma_i(g_k) = \sigma_i(u^x v^y w^z)$, and since $u^x v^y w^z \in \mathcal{F}_X^\mathcal{C}$ (as u, v, w belong to the monoid $\mathcal{F}_X^\mathcal{C}$), it follows that $\alpha_X(\sigma_i(g_k)) \in \mathcal{C}$. So now suppose $i > \lambda$. By the division algorithm, we may write $i - \lambda = q\mu + r$, where $q, r \in \mathbb{N}$ and $0 \leq r < \mu$. Then since $xA + yB + zC = O$, we have

$$\begin{aligned} \alpha_X(\sigma_i(g_k)) &= (xU + yV + zW) + q(xA + yB + zC) + \alpha_X(\sigma_r(A^x B^y C^z)) \\ &= (xU + yV + zW) + \alpha_X(\sigma_r(A^x B^y C^z)) \\ &= \begin{cases} (xU + yV + zW) + rA & \text{if } 0 \leq r \leq x \\ (xU + yV + zW) + xA + (r - x)B & \text{if } x \leq r \leq x + y \\ (xU + yV + zW) + xA + yB + (r - x - y)C & \text{if } x + y \leq r < x + y + z \end{cases} \\ &= \begin{cases} r(U + A) + (x - r)U + yV + zW & \text{if } 0 \leq r \leq x \\ x(U + A) + (r - x)(V + B) + (x + y - r)V + zW & \text{if } x \leq r \leq x + y \\ x(U + A) + y(V + B) + (r - x - y)(W + C) + (x + y + z - r)W & \text{if } x + y \leq r < x + y + z. \end{cases} \end{aligned}$$

Since U, V, W and $U + A, V + B, W + C$ all belong to the monoid \mathcal{C} , so too does $\alpha_X(\sigma_i(g_k))$ in all of the above cases.

(ii) \Rightarrow (iii). Since Y is finite, Theorems 2.36 and 2.44(ii) give

$$O \notin \text{Conv}(Y) \Rightarrow Y \not\models \text{IPP} \Rightarrow Y \models \text{LC}.$$

(iii) \Rightarrow (i). Here we have

$$Y \models \text{LC} \Rightarrow Y \models \text{FPP} \Rightarrow (Y, \mathcal{C}) \models \text{FPP} \Rightarrow (X, \mathcal{C}) \models \text{FPP}.$$

Indeed, the first implication follows from Theorem 2.44(ii), the second is obvious, and the third from the fact that the (X, \mathcal{C}) -walks are precisely the (Y, \mathcal{C}) -walks. \square

Remark 3.27. In light of the finiteness assumption on Y in Theorem 3.26, several more equivalent conditions could be listed; cf. Theorems 2.36 and 2.44(ii).

Remark 3.28. In the notation of Theorem 3.26, we have $(X, \mathcal{C}) \models \text{FPP} \Leftrightarrow O \notin \text{Conv}(Y)$. While this certainly entails that $(X, \mathcal{C}) \models \text{IPP} \Rightarrow O \in \text{Conv}(Y)$, the converse does not hold in general (even for finite X), as shown by the pair (X, \mathcal{C}_3) from Example 3.4 (cf. Figure 20). Consequently, we could not have listed “ (X, \mathcal{C}) does not have the IPP” as one of the equivalent conditions in Theorem 3.26.

Many examples of constrained walks considered in the literature (and throughout the current paper) involve a special kind of constraint set \mathcal{C} that is suitably “thick”, in the sense that \mathcal{C} contains $C \cap \mathbb{Z}^2$ where C is some (open) cone with vertex O . It turns out that Theorem 3.26 may be strengthened in certain such cases, as shown in Theorem 3.31 below. First we need the following lemma.

Lemma 3.29. *Let $X \subseteq \mathbb{Z}_\times^2$ be an arbitrary step set, and let \mathcal{C} be a submonoid of \mathbb{Z}^2 . Suppose also that there is an (open) cone C with vertex O such that $C \cap \mathbb{Z}^2 \subseteq \mathcal{C}$ and $C \cap \mathcal{A}_X^\mathcal{C} \neq \emptyset$. Then every step from X is (X, \mathcal{C}) -admissible.*

Proof. Let $A \in X$ be arbitrary. By assumption, there exists some point $B \in C \cap \mathcal{A}_X^\mathcal{C}$. We note also that B is an interior point of C (as the latter is an open set). It follows that there exists $n \in \mathbb{N}$ such that the circle of radius $|OA|$ centred at nB (including the boundary and interior) is contained in C . But then we have $nB + A \in C \cap \mathbb{Z}^2 \subseteq \mathcal{C}$. Thus, for any word $w \in \Pi_X^\mathcal{C}(B)$, we have $w^n A \in \mathcal{F}_X^\mathcal{C}$, showing that A is indeed (X, \mathcal{C}) -admissible. All of this is shown in Figure 26. \square

Remark 3.30. The assumption that $C \cap \mathcal{A}_X^\mathcal{C} \neq \emptyset$ is crucial in proving Lemma 3.29. For example, consider $X = \{(1, 0), (0, -1)\}$ and $\mathcal{C} = \mathbb{N}^2$, noting that $\mathcal{A}_X^\mathcal{C} = \mathbb{N} \times \{0\}$. Then \mathcal{C} contains $C \cap \mathbb{Z}^2$, where C is the cone $\{(x, y) \in \mathbb{R}^2 : \frac{x}{3} < y < \frac{x}{2}\}$, yet $(0, -1)$ is not (X, \mathcal{C}) -admissible. In fact, every (open) cone C with vertex O satisfying $C \cap \mathbb{Z}^2 \subseteq \mathcal{C}$ is contained in the first quadrant, so for any such cone we have $C \cap \mathcal{A}_X^\mathcal{C} = \emptyset$.

Theorem 3.31. *Let $X \subseteq \mathbb{Z}_\times^2$ be an arbitrary finite step set, and let \mathcal{C} be a submonoid of \mathbb{Z}^2 . Suppose also that there is an (open) cone C with vertex O such that $C \cap \mathbb{Z}^2 \subseteq \mathcal{C}$ and $C \cap \mathcal{A}_X^\mathcal{C} \neq \emptyset$. Then the following are equivalent:*

- (i) (X, \mathcal{C}) has the FPP,
- (ii) $O \notin \text{Conv}(X)$,
- (iii) X satisfies the LC.

Proof. This follows immediately from Theorem 3.26 and Lemma 3.29. \square

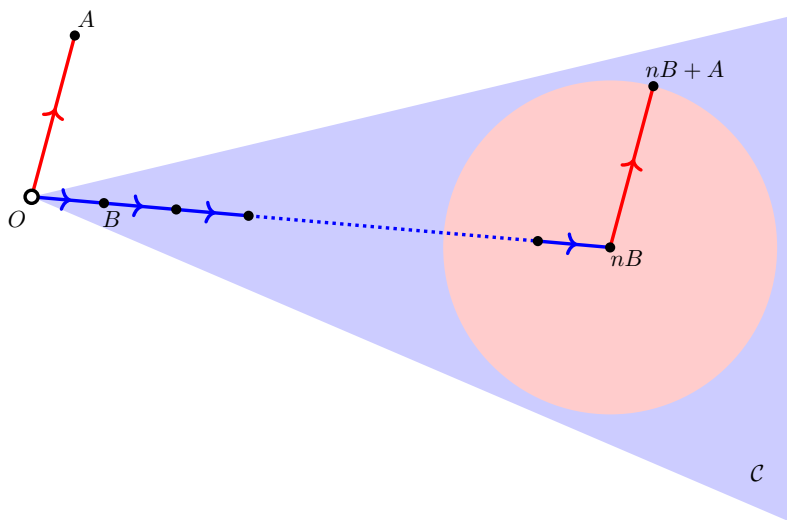

Figure 26: Verification that $nB + A \in \mathcal{C}$, from the proof of Theorem 3.31. Edges are coloured red (A) and blue (B). Note that $A \in X$ and $B \in \mathcal{A}_X^\mathcal{C}$, so that a blue edge represents an (X, \mathcal{C}) -walk from O to B ; such a walk might step outside of C (but not outside of \mathcal{C}).

Remark 3.32. As in Remark 3.28, we could not include “ (X, \mathcal{C}) does not have the IPP” among the listed conditions in Theorem 3.31. On the other hand, any of the equivalent conditions from Theorem 2.44(ii) could have been added. In particular, it seems noteworthy that $(X, \mathcal{C}) \models \text{FPP} \Leftrightarrow X \models \text{FPP}$ for such pairs (X, \mathcal{C}) . The corresponding statement for the IPP is false, as shown by (X, \mathcal{C}_3) from Example 3.4.

Remark 3.33. While the (X, \mathcal{C}) -admissible steps have been useful in this section for characterising the FPP in certain situations (Theorems 3.26 and 3.31), we cannot use them to improve Propositions 3.23 or 3.24. For example, with $X \subseteq \mathbb{Z}_x^2$ a step set, \mathcal{C} a submonoid of \mathbb{Z}^2 , and Y the set of (X, \mathcal{C}) -admissible steps, one might hope to prove that

- (X, \mathcal{C}) has the IPP if and only if $O \in \text{Conv}(Y)$, or
- $\mathcal{A}_X^\mathcal{C}$ is a non-trivial group if and only if $O \in \text{Rel-Int}(\text{Conv}(Y))$.

But neither of these are true, as again evidenced by the pair (X, \mathcal{C}_3) from Example 3.4.

4 Algorithms

Although this paper is mostly theoretical, certain results proven in Sections 2 and 3 lead to practical applications in terms of computing combinatorial data such as the elements of the sets \mathcal{A}_X and $\mathcal{A}_X^\mathcal{C}$, the numbers $\pi_X(A)$ and $\pi_X^\mathcal{C}(A)$, and so on. This data can sometimes be calculated by hand, and sometimes explicit formulae can be obtained, as in many of the examples considered in Sections 2 and 3, and across the literature. However, this is often impossible or impractical, especially if X is large and/or “random”, but sometimes even for seemingly-simple step sets (cf. Example 3.12), hence the need for computer algorithms.

The purpose of this section is to present such algorithms (in pseudocode); these algorithms are all implemented in C++, and available at [26]. The discussion here concentrates on constrained walks, and we give algorithms for calculating the elements of $\mathcal{A}_X^\mathcal{C}$ in Section 4.1 (Algorithm 1), checking the Line Condition in Section 4.2 (Algorithm 2), and calculating the numbers $\pi_X^\mathcal{C}(A)$ in Section 4.3 (Algorithm 3). All of these algorithms apply to unconstrained walks by taking $\mathcal{C} = \mathbb{Z}^2$, or by deleting any part of an algorithm that involves checking whether a point belongs to \mathcal{C} .

For the duration of Section 4, we fix a non-empty finite step set $X \subseteq \mathbb{Z}_x^2$, and an arbitrary subset \mathcal{C} of \mathbb{Z}^2 containing O . In order to avoid trivialities, we assume that $X \cap \mathcal{C} \neq \emptyset$ (cf. [27]). We also assume it is possible to check computationally whether an arbitrary element of \mathbb{Z}^2 belongs to \mathcal{C} . This is the case for example when \mathcal{C} is the set of all lattice points whose coordinates satisfy some collection of equations or inequalities, such as $\mathcal{C} = \mathbb{N}^2$ or $\mathcal{C} = \{(a, b) \in \mathbb{N}^2 : b \leq a\}$, as considered in a number of examples in Section 3. In most of the examples we consider, \mathcal{C} will be a monoid (which implies $\mathcal{A}_X^\mathcal{C}$ is a monoid, by Lemma 3.2), but the algorithms do not assume \mathcal{C} is a submonoid.

4.1 Computing the points

Certainly we cannot give an algorithm to compute *all* the elements of $\mathcal{A}_X^\mathcal{C}$, since this set is infinite, but it is relatively straightforward to generate more and more elements of $\mathcal{A}_X^\mathcal{C}$ in a way we make precise below. For $q \in \mathbb{N}$ we define the set

$$\mathcal{A}_X^\mathcal{C}(q) = \{\alpha_X(w) : w \in \mathcal{F}_X^\mathcal{C}, \ell(w) = q\}$$

for the set of all elements of $\mathcal{A}_X^\mathcal{C}$ that are endpoints of (X, \mathcal{C}) -walks of length q . Note that these sets might not be pairwise disjoint, as there can be (X, \mathcal{C}) -walks of unequal length with the same endpoint, but we do of course have $\mathcal{A}_X^\mathcal{C} = \bigcup_{q \in \mathbb{N}} \mathcal{A}_X^\mathcal{C}(q)$. We also write

$$\mathcal{A}_X^\mathcal{C}(\leq q) = \mathcal{A}_X^\mathcal{C}(0) \cup \dots \cup \mathcal{A}_X^\mathcal{C}(q) = \{\alpha_X(w) : w \in \mathcal{F}_X^\mathcal{C}, \ell(w) \leq q\}.$$

In the unconstrained case, in which $\mathcal{C} = \mathbb{Z}^2$, we write $\mathcal{A}_X(q)$ and $\mathcal{A}_X(\leq q)$ instead of $\mathcal{A}_X^{\mathbb{Z}^2}(q)$ and $\mathcal{A}_X^{\mathbb{Z}^2}(\leq q)$. Note that we have an ascending chain of subsets

$$\{O\} = \mathcal{A}_X^\mathcal{C}(\leq 0) \subseteq \mathcal{A}_X^\mathcal{C}(\leq 1) \subseteq \mathcal{A}_X^\mathcal{C}(\leq 2) \subseteq \dots, \quad (4.1)$$

whose union is all of $\mathcal{A}_X^\mathcal{C}$. Thus, our aim is to compute the sets $\mathcal{A}_X^\mathcal{C}(\leq q)$ for arbitrary q .

As noted above, it is fairly straightforward to achieve this aim. We begin with $\mathcal{A}_X^\mathcal{C}(0) = \{O\}$, and to obtain $\mathcal{A}_X^\mathcal{C}(q)$ from $\mathcal{A}_X^\mathcal{C}(q-1)$, we simply add each element of X to each element of $\mathcal{A}_X^\mathcal{C}(q-1)$ and keep

those that belong to \mathcal{C} . This is essentially what Algorithm 1 below does. However, while doing this, it will be convenient to construct a sequence of graphs $\Lambda_X^{\mathcal{C}}(q)$ with vertex set $\mathcal{A}_X^{\mathcal{C}}(\leq q)$, and with vertex labels that also play a role in calculating the numbers $\pi_X^{\mathcal{C}}(A)$ later. For each $q \in \mathbb{N}$, we define the graph $\Lambda_X^{\mathcal{C}}(q)$ as follows:

- As we have already mentioned, the vertex set of $\Lambda_X^{\mathcal{C}}(q)$ is $\mathcal{A}_X^{\mathcal{C}}(\leq q)$.
- Each vertex A of $\Lambda_X^{\mathcal{C}}(q)$ is labelled by the natural number $\lambda_q(A) = \max\{p \in \{1, \dots, q\} : A \in \mathcal{A}_X^{\mathcal{C}}(p)\}$.
- For each $A \in \mathcal{A}_X^{\mathcal{C}}(\leq q-1)$ and each $B \in X$ such that $A+B \in \mathcal{C}$, $\Lambda_X^{\mathcal{C}}(q)$ has the edge $A \xrightarrow{B} A+B$.

As usual, when depicting such graphs, we generally draw the vertices at the appropriate points in the plane. For $A \in \mathcal{A}_X^{\mathcal{C}}(\leq q)$, the meaning of the label $\lambda_q(A)$ is slightly subtle. There is a path from O to A in $\Lambda_X^{\mathcal{C}}(q)$ of length $\lambda_q(A)$; there may be longer paths from O to A in $\Lambda_X^{\mathcal{C}}(q)$, but the length of any such path will be greater than q (see Examples 4.3–4.5 below). Again, in the unconstrained case, we will write $\Lambda_X(q)$ instead of $\Lambda_X^{\mathbb{Z}^2}(q)$.

We will explain the deeper significance of the graphs $\Lambda_X^{\mathcal{C}}(q)$ in more detail in Section 4.3, but first we show in Algorithm 1 how to construct them. Note that Algorithm 1 allows us to calculate the elements of $\mathcal{A}_X^{\mathcal{C}}(\leq q)$ for any $q \in \mathbb{N}$, as these are simply the vertices of $\Lambda_X^{\mathcal{C}}(q)$. Note also that if the time complexity for checking membership of \mathcal{C} is assumed to be constant, then the time complexity of Algorithm 1 is clearly $O(|X|^q)$ in general, but this seems unavoidable since any algorithm for generating the elements of $\mathcal{A}_X^{\mathcal{C}}$ generally has to inspect words over X . In practice, the run-time of Algorithm 1 could be better; this depends on how interrelated the steps from X are, which influences how small the sets $\mathcal{A}_X^{\mathcal{C}}(q)$ are, as compared to $|X|^q$.

Algorithm 1 Calculate the graph $\Lambda_X^{\mathcal{C}}(q)$.

Input: a finite step set $X \subseteq \mathbb{Z}_x^2$, a subset \mathcal{C} of \mathbb{Z}^2 containing O , and a natural number $q \in \mathbb{N}$

Output: the graph $\Lambda_X^{\mathcal{C}}(q)$

```

1:  $V := \{O\}$ ,  $E := \emptyset$ ,  $\lambda_0(O) := 0$ ,  $\mathcal{A}_X^{\mathcal{C}}(0) := \{O\}$ 
2:  $i := 1$ 
3: while  $i \leq q$  do
4:    $\mathcal{A}_X^{\mathcal{C}}(i) := \emptyset$ 
5:   for  $A \in \mathcal{A}_X^{\mathcal{C}}(i-1)$  do
6:     for  $B \in X$  do
7:       if  $A+B \in \mathcal{C}$  then
8:          $\mathcal{A}_X^{\mathcal{C}}(i) \leftarrow \mathcal{A}_X^{\mathcal{C}}(i) \cup \{A+B\}$ 
9:          $V \leftarrow V \cup \{A+B\}$ 
10:         $E \leftarrow E \cup \{A \xrightarrow{B} A+B\}$ 
11:   for  $A \in \mathcal{A}_X^{\mathcal{C}}(i)$  do
12:      $\lambda_i(A) := i$ 
13:   for  $A \in V \setminus \mathcal{A}_X^{\mathcal{C}}(i)$  do
14:      $\lambda_i(A) := \lambda_{i-1}(A)$ 
15:    $i \leftarrow i+1$ 
16: return the graph  $\Lambda_X^{\mathcal{C}}(q)$  with vertex set  $V$ , vertex labelling function  $\lambda_q$ , and edge set  $E$ 

```

Before moving on to additional algorithms, we first pause to give several examples of Algorithm 1 in action, partly in order to display the subtlety of the labelling. The first uses the step set from Example 2.1.

Example 4.2. Consider the step set $X = \{N, E\}$, where $N = (0, 1)$ and $E = (1, 0)$. Algorithm 1 produces the graphs $\Lambda_X(0), \dots, \Lambda_X(4)$, as shown in Figure 27. In fact, the implementation of Algorithm 1 at [26] produced the $\text{\LaTeX}/\text{Ti\kern-0.1ex}\kern-0.1ex\text{X}/\text{tikz}$ code for drawing the diagrams in Figure 27, and in many other figures in this section. Note that for any $i \leq j$, and any $A \in \mathcal{A}_X(\leq i)$, we have $\lambda_i(A) = \lambda_j(A)$; this is because all X -walks to A have the same length (equal to the sum of the x - and y -coordinates of A); cf. Figure 2.

Figure 27 also shows the graphs $\Lambda_X^{\mathcal{C}}(0), \dots, \Lambda_X^{\mathcal{C}}(4)$, where $\mathcal{C} = \{(a, b) \in \mathbb{N}^2 : b \leq a\}$; again these were produced by applying Algorithm 1. A similar comment may be made for the labels of these graphs.

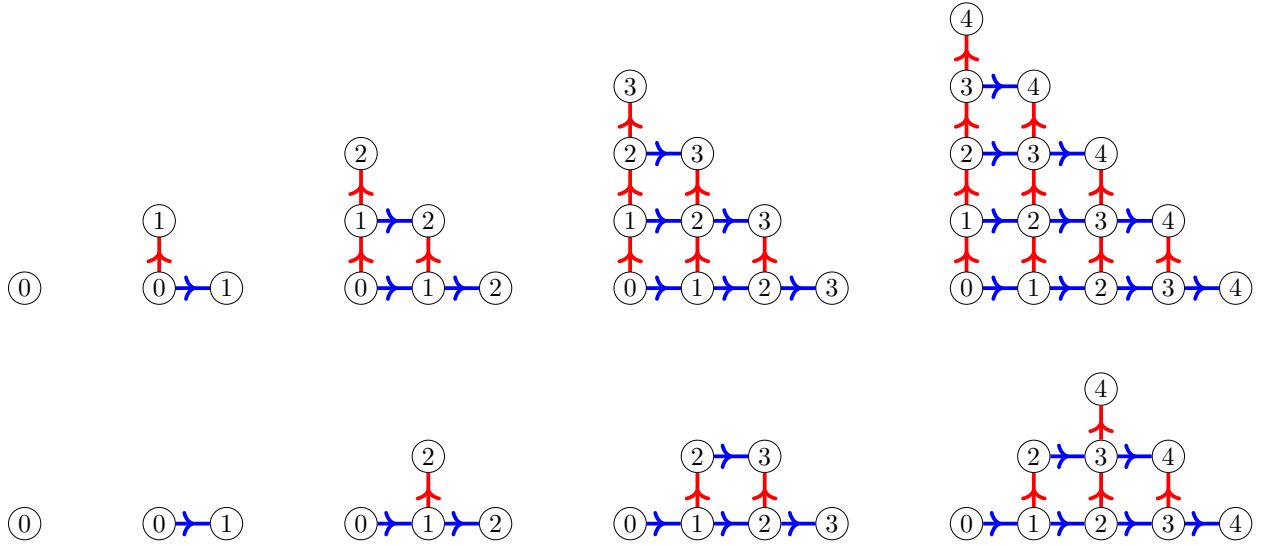

Figure 27: The graphs $\Lambda_X(q)$, $q = 0, \dots, 4$ (top, left to right), and $\Lambda_X^{\mathcal{C}}(q)$, $q = 0, \dots, 4$ (bottom, left to right), where $X = \{(1,0), (0,1)\}$ and $\mathcal{C} = \{(a,b) \in \mathbb{N}^2 : b \leq a\}$; cf. Example 4.2.

Example 4.3. Consider the step set $X = \{N, E, U\}$, where $N = (0,1)$, $E = (1,0)$ and $U = (1,1)$. Algorithm 1 produces the graphs $\Lambda_X(0), \dots, \Lambda_X(4)$, as shown in Figure 28. In contrast to the situation in Example 4.2, here we have (for example) $\lambda_1(U) = 1 < 2 = \lambda_2(U)$; this happens because there are X -walks of differing lengths to U . We also have $\lambda_2(2U) < \lambda_3(2U) < \lambda_4(2U)$. Figure 28 also shows the graphs $\Lambda_X^{\mathcal{C}}(0), \dots, \Lambda_X^{\mathcal{C}}(4)$, where $\mathcal{C} = \{(a,b) \in \mathbb{N}^2 : b \leq a\}$.

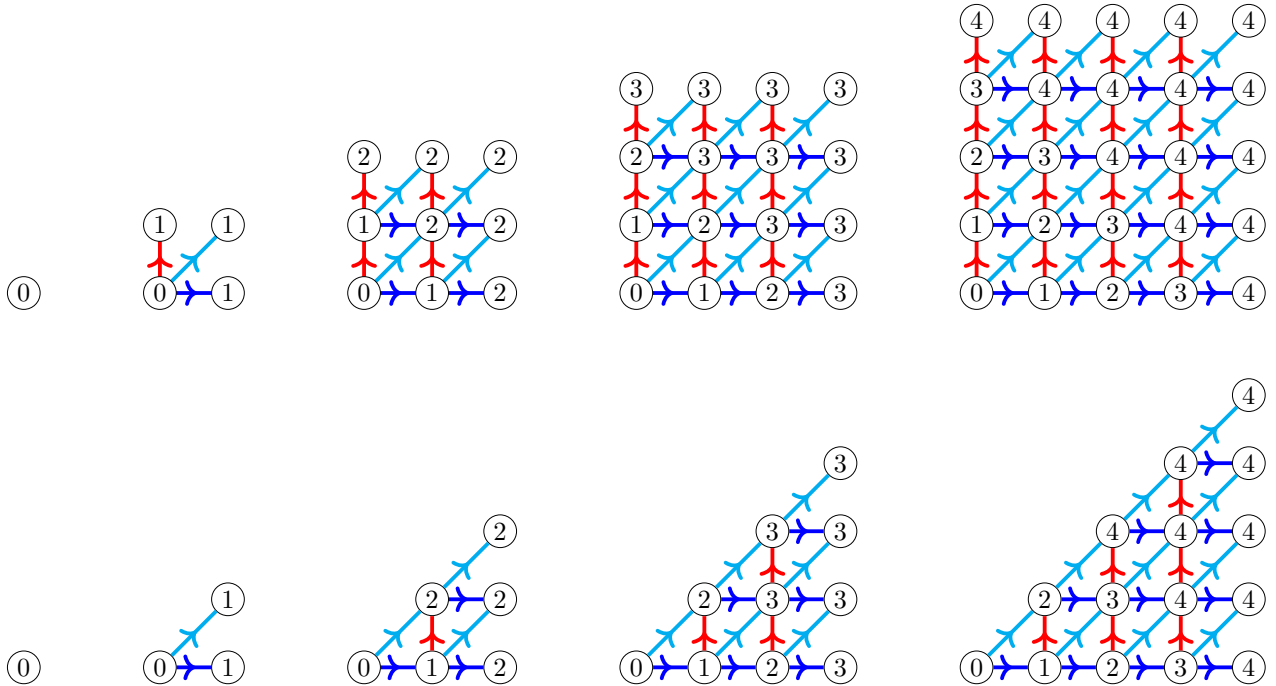

Figure 28: The graphs $\Lambda_X(q)$, $q = 0, \dots, 4$ (top, left to right), and $\Lambda_X^{\mathcal{C}}(q)$, $q = 0, \dots, 4$ (bottom, left to right), where $X = \{(1,0), (0,1), (1,1)\}$ and $\mathcal{C} = \{(a,b) \in \mathbb{N}^2 : b \leq a\}$; cf. Example 4.3.

Example 4.4. Consider the step set $X = \{E, 3E\}$, where $E = (1,0)$ and $3E = (3,0)$. Algorithm 1 produces the graphs $\Lambda_X(0), \dots, \Lambda_X(4)$, as shown in Figure 29. This time, $\lambda_1(3E) = \lambda_2(3E) < \lambda_3(3E)$.

Example 4.5. Consider the step set $X = \{N, E, A\}$, where $N = (0,1)$, $E = (1,0)$ and $A = (1,2)$, and let $\mathcal{C} = \{(a,b) \in \mathbb{N}^2 : b \leq a\}$. Figure 30 shows the graphs $\Lambda_X(q)$ and $\Lambda_X^{\mathcal{C}}(q)$ for $q = 0, \dots, 4$, produced using Algorithm 1.

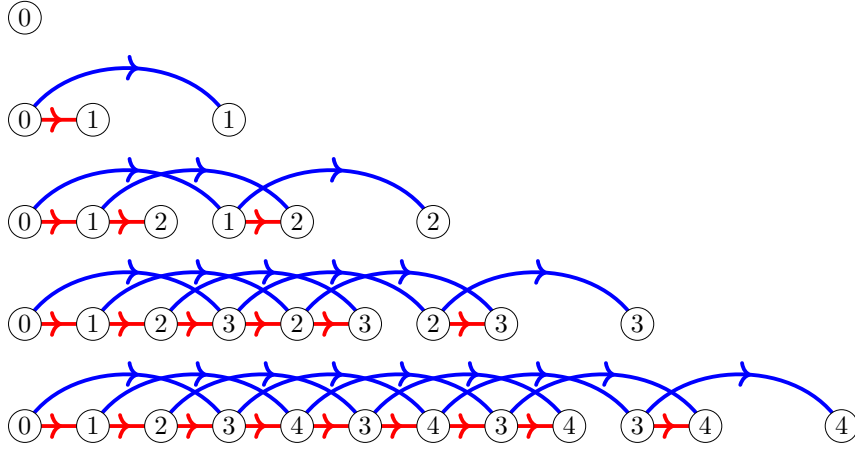

Figure 29: The graphs $\Lambda_X(q)$, $q = 0, \dots, 4$ (top to bottom), where $X = \{(1, 0), (3, 0)\}$; cf. Example 4.4.

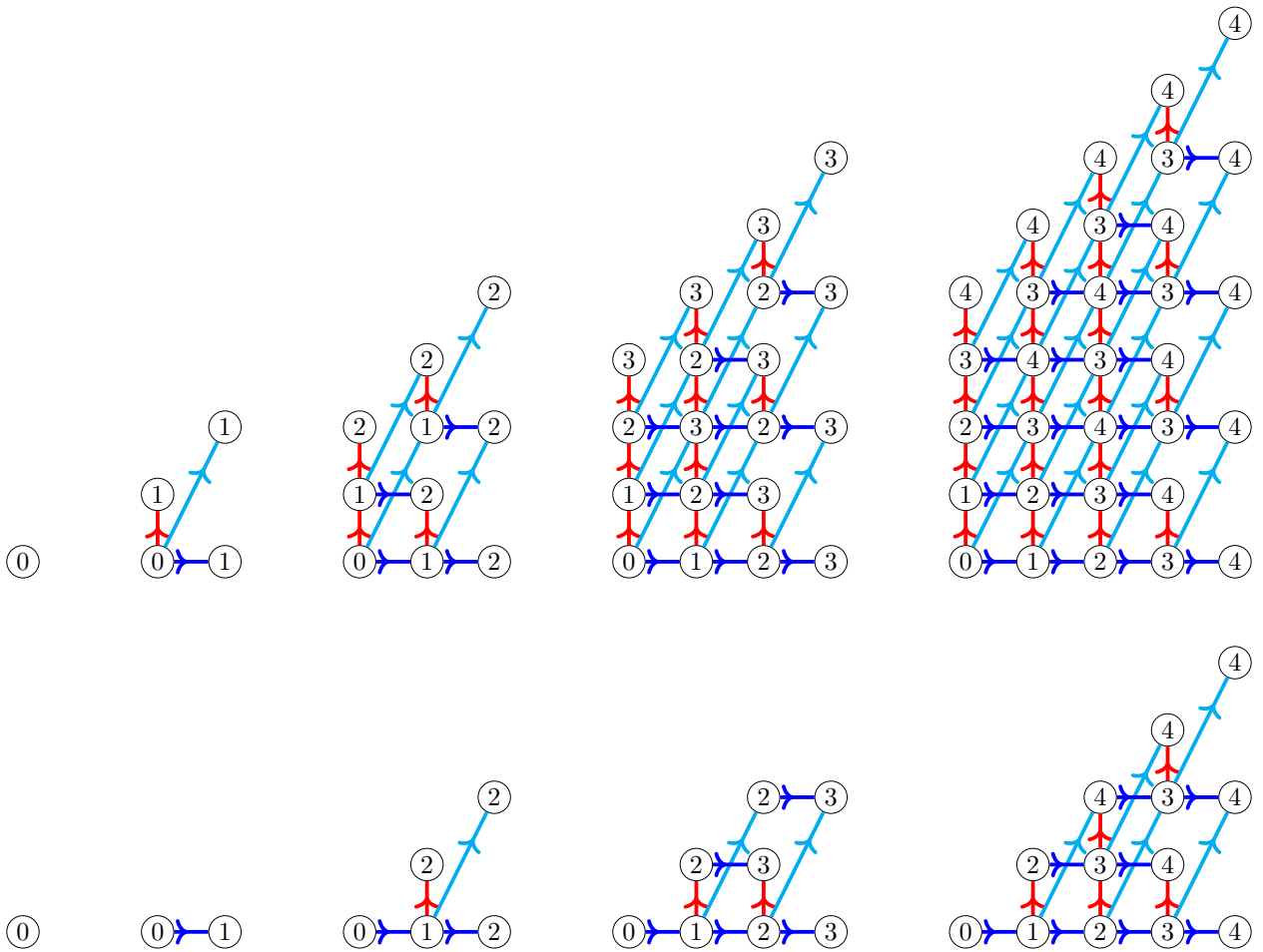

Figure 30: The graphs $\Lambda_X(q)$, $q = 0, \dots, 4$ (top, left to right), and $\Lambda_X^{\mathcal{C}}(q)$, $q = 0, \dots, 4$ (bottom, left to right), where $X = \{(1, 0), (0, 1), (1, 2)\}$ and $\mathcal{C} = \{(a, b) \in \mathbb{N}^2 : b \leq a\}$; cf. Example 4.5.

Example 4.6. Consider the step set $X = \{N, E, A\}$, where $N = (0, 1)$, $E = (1, 0)$ and $A = (2, 2)$, and let $\mathcal{C} = \{(a, b) \in \mathbb{N}^2 : b \leq a\}$. Figure 31 shows the graphs $\Lambda_X(q)$ and $\Lambda_X^{\mathcal{C}}(q)$ for $q = 0, \dots, 3$, produced using Algorithm 1.

4.2 Checking the Line Condition

Now that we can calculate the elements of \mathcal{A}_X and $\mathcal{A}_X^{\mathcal{C}}$ (or at least of $\mathcal{A}_X(\leq q)$ and $\mathcal{A}_X^{\mathcal{C}}(\leq q)$ for suitably large $q \in \mathbb{N}$), we would like to calculate the values of $\pi_X(A)$ and $\pi_X^{\mathcal{C}}(A)$.

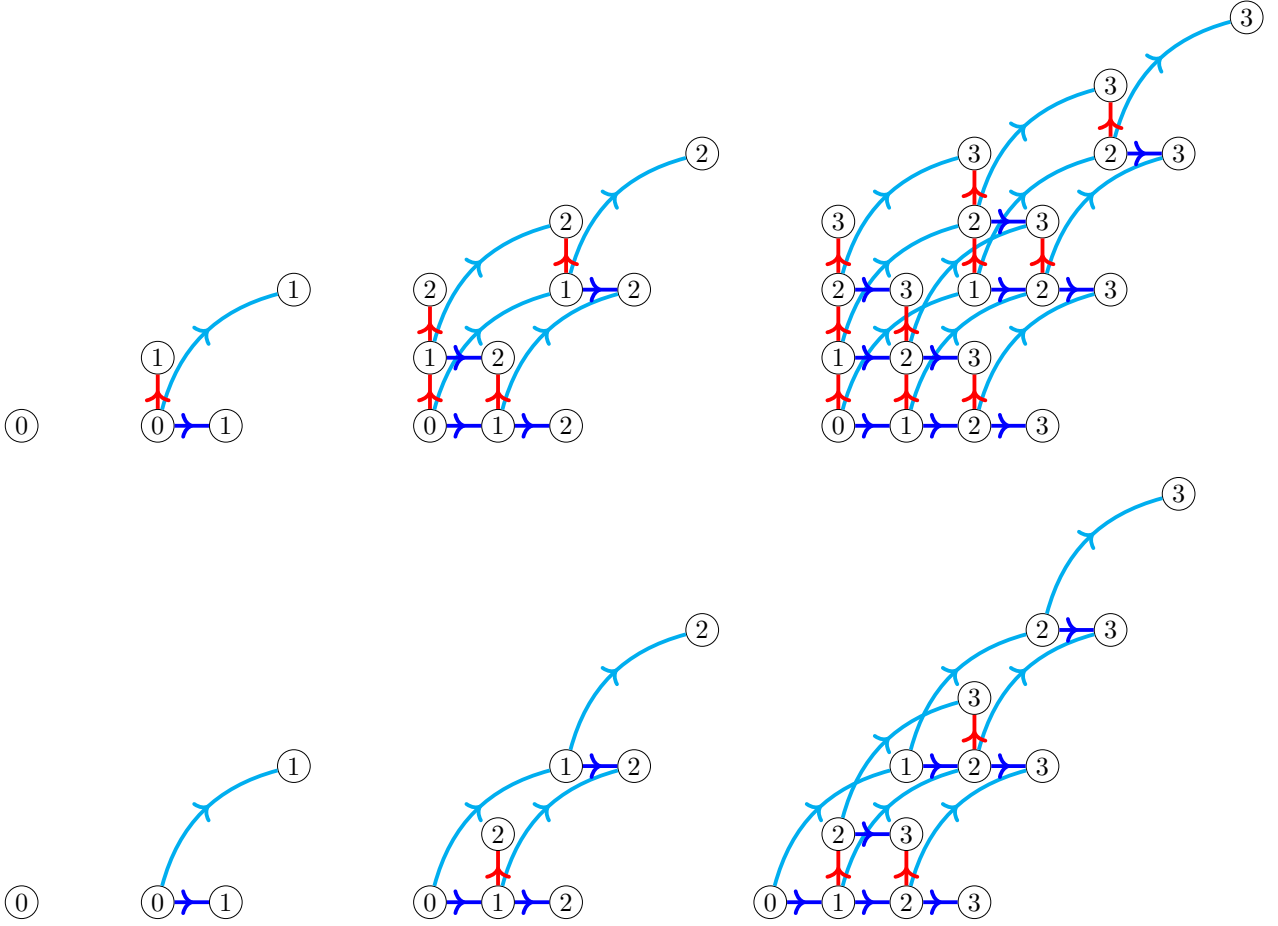

Figure 31: The graphs $\Lambda_X(q)$, $q = 0, \dots, 3$ (top, left to right), and $\Lambda_X^{\mathcal{C}}(q)$, $q = 0, \dots, 3$ (bottom, left to right), where $X = \{(1, 0), (0, 1), (2, 2)\}$ and $\mathcal{C} = \{(a, b) \in \mathbb{N}^2 : b \leq a\}$; cf. Example 4.6.

Since X is finite, it has either the IPP or the FPP (cf. Corollary 2.46). Thus, to compute the numbers $\pi_X(A)$, we should first determine which of these two cases we are in. There are at least two natural ways to go about this, as

$$X \models \text{FPP} \Leftrightarrow O \notin \text{Conv}(X) \Leftrightarrow X \models \text{LC},$$

by Theorems 2.36 and 2.44(ii).

For constrained walks, the situation is more complicated. Indeed, even though X is finite, there is no FPP/IPP dichotomy (cf. Example 3.4 and Figure 20). Nevertheless, if we write Y for the set of all (X, \mathcal{C}) -admissible steps (cf. Section 3.4), then we have

$$(X, \mathcal{C}) \models \text{FPP} \Leftrightarrow O \notin \text{Conv}(Y) \Leftrightarrow Y \models \text{LC},$$

by Theorem 3.26. Moreover, if X satisfies the assumptions of Theorem 3.31, then by that theorem, we have

$$(X, \mathcal{C}) \models \text{FPP} \Leftrightarrow O \notin \text{Conv}(X) \Leftrightarrow X \models \text{LC}.$$

Thus, whether we are dealing with unconstrained or constrained walks, it is clearly important to be able to test whether or not a finite subset of \mathbb{Z}^2 has O in its convex hull, or satisfies the LC.

The time complexity of computing (the vertices of) the convex hull of a set of n points in the plane is well known [9, 21] to be $O(n \log n)$. Thus, if $|X| = n$, we can determine whether $O \in \text{Conv}(X)$ in $O(n \log n)$ time by determining whether $\text{Conv}(X) = \text{Conv}(X \cup \{O\})$. However, it will transpire that checking X for the LC instead of checking $O \in \text{Conv}(X)$ will be more convenient for our purposes.

A simple method for checking whether $X = \{A_1, \dots, A_n\}$ satisfies the LC is as follows. For each $i \in \{1, \dots, n\}$, let α_i be the polar angle of A_i : i.e., the angle from the positive x -axis to OA_i , measured anti-clockwise. We first order the points of X as A_{j_1}, \dots, A_{j_n} , where $\alpha_{j_1} \leq \dots \leq \alpha_{j_n}$. If $\alpha_{j_1} = \dots = \alpha_{j_n}$, then X clearly satisfies the LC. Otherwise, we continue by calculating the angles $\beta_i = \angle A_{j_i}OA_{j_{i+1}} = \alpha_{j_{i+1}} - \alpha_{j_i}$ (interpreting $j_{n+1} = j_1$ and $\beta_n = 2\pi + \alpha_{j_1} - \alpha_{j_n}$). Then X satisfies the LC if and only if one of these

angles β_i is bigger than π . See Figure 32 for two examples. Algorithm 2 implements the above procedure (and more), albeit in a slightly modified way; we explain the modification, and the reasons for its necessity in the next paragraph. Additionally, as it will be important for later use, in the case that X satisfies the LC, Algorithm 2 finds a vector \mathbf{u} such that the line \mathcal{L} through O and perpendicular to \mathbf{u} witnesses the LC, with \mathbf{u} pointing into the half-plane containing X . Since sorting lists of length n also has $O(n \log n)$ time complexity, this algorithm has essentially the same complexity as one based on testing $O \in \text{Conv}(X)$.

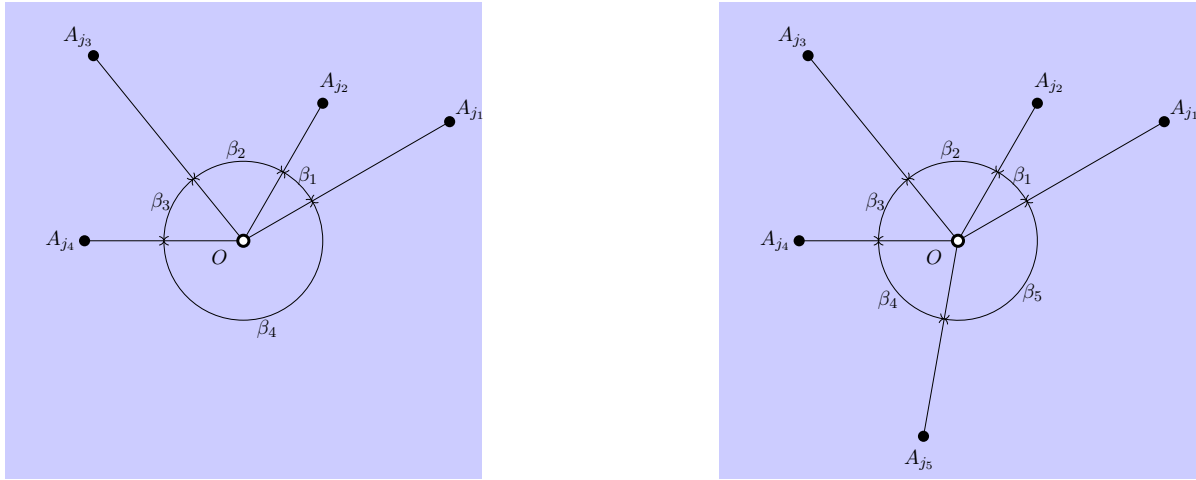

Figure 32: The points A_{j_1}, \dots, A_{j_n} and angles β_1, \dots, β_n from Algorithm 2. Left: the LC holds since $\beta_4 > \pi$. Right: the LC does not hold since $\beta_i \leq \pi$ for all i .

Note that calculating the angles α_i, β_i has the potential to run into rounding errors, as these angles are generally irrational, hence the need to slightly modify the details of the above procedure. Now, one could obtain the required ordering A_{j_1}, \dots, A_{j_n} on the elements of X by considering only the coordinates of the points $A_i = (x_i, y_i)$, and in particular the ratio $\tan \alpha_i = \frac{y_i}{x_i}$ (which we interpret to be $-\infty$ if $x_i = 0$); to determine whether $\alpha_i \leq \alpha_j$, we first consider the quadrants containing A_i and A_j , and if these quadrants are the same we have $\alpha_i \leq \alpha_j \Leftrightarrow \frac{y_i}{x_i} \leq \frac{y_j}{x_j}$ (we consider points on the y -axis to belong to the second or fourth quadrants). Once the ordering A_{j_1}, \dots, A_{j_n} is established, we have $\beta_i > \pi$ if and only if the vector cross product $\overrightarrow{OA_{j_i}} \times \overrightarrow{OA_{j_{i+1}}}$ points towards the negative z -axis (in a right-handed coordinate system), which occurs if and only if $x_{j_i}y_{j_{i+1}} - x_{j_{i+1}}y_{j_i} < 0$. These considerations are all implemented in the code available at [26], although the pseudocode in Algorithm 2 is written in terms of the angles α_i, β_i , as we believe this is conceptually simpler. It is also worth noting that we could shorten the While Loop in Lines 12–17 of Algorithm 2 by keeping track of $\beta_1 + \dots + \beta_i$; if this sum ever reaches or exceeds π (with all of $\beta_1, \dots, \beta_i \leq \pi$), then $\beta_{i+1}, \dots, \beta_n$ will all be at most π ; at this point, we can leave the loop and immediately declare that the LC is not satisfied. Note again that we can check if $\beta_1 + \dots + \beta_i \geq \pi$ by checking the cross product $\overrightarrow{OA_{j_1}} \times \overrightarrow{OA_{j_i}}$.

We now explain how to find the line \mathcal{L} and vector \mathbf{u} discussed above, in the case that X satisfies the LC. Here (with the above notation) we will find that $\beta_i > \pi$ for some i . For simplicity in what follows, we write $A = A_{j_i} = (u, v)$ and $B = A_{j_{i+1}} = (x, y)$, and also $\mathbf{a} = \overrightarrow{OA} = \langle u, v \rangle$ and $\mathbf{b} = \overrightarrow{OB} = \langle x, y \rangle$. It is easy to see that the line \mathcal{L} through O in the direction of $\mathbf{b} - \mathbf{a}$ witnesses the LC; see Figure 33. Now, $\mathbf{b} - \mathbf{a} = \langle x - u, y - v \rangle$, so (up to scaling) the desired vector \mathbf{u} is either $\langle v - y, x - u \rangle$ or the negative of this vector. To see which of these to take as \mathbf{u} , first note that since $\angle AOB > \pi$, the vector cross product $\mathbf{a} \times \mathbf{b}$ points in the direction of the negative z -axis; since $\mathbf{a} \times \mathbf{b} = \langle 0, 0, uy - vx \rangle$, it follows that $vx - uy > 0$. Thus, if we take $\mathbf{u} = \langle v - y, x - u \rangle$, then we have $\mathbf{a} \cdot \mathbf{u} = \mathbf{b} \cdot \mathbf{u} = vx - uy > 0$, meaning that this choice of \mathbf{u} points towards the desired half-plane. This is all shown in Figure 33, and implemented in Algorithm 2.

4.3 Computing the numbers

We now turn to the task of computing the values $\pi_X^{\mathcal{C}}(A)$, $A \in \mathcal{A}_X^{\mathcal{C}}$. First note that if we knew (X, \mathcal{C}) had the IPP, then we could simply calculate as many points $A \in \mathcal{A}_X^{\mathcal{C}}$ as we wish (cf. Algorithm 1) and declare $\pi_X^{\mathcal{C}}(A) = \infty$ for all such A . In the case of unconstrained walks (when $\mathcal{C} = \mathbb{Z}^2$), this happens if and only if X does not satisfy the LC, and the only other option is that X has the FPP; cf. Theorem 2.44(ii), Corollary 2.46 and Algorithm 2.

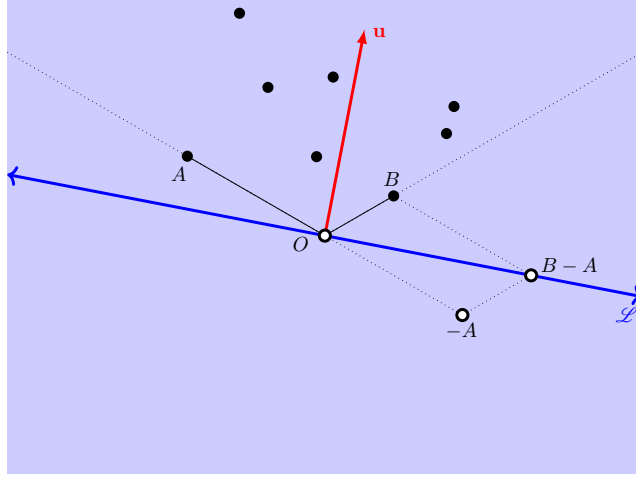

Figure 33: The points $A = A_{j_i}$ and $B = A_{j_{i+1}}$, and the vector \mathbf{u} from Algorithm 2.

As noted near the beginning of Section 4.2, the situation for constrained walks is more complicated since there is no FPP/IPD dichotomy in general. Here, however, if \mathcal{C} is a *submonoid* of \mathbb{Z}^2 , and if we write Y for the set of all (X, \mathcal{C}) -admissible steps (cf. Section 3.4), then we have

$$\mathcal{A}_X^\mathcal{C} = \mathcal{A}_Y^\mathcal{C} \quad \text{and} \quad \pi_X^\mathcal{C}(A) = \pi_Y^\mathcal{C}(A) \quad \text{for all } A \in \mathbb{Z}^2, \quad (4.7)$$

and moreover, (X, \mathcal{C}) has the FPP if and only if Y satisfies the LC (cf. Theorem 3.26); of course if we know the set Y , then we can check whether it satisfies the LC using Algorithm 2. The authors are currently unaware of an algorithm for determining the (X, \mathcal{C}) -admissible steps; we leave it as an open problem to devise such an algorithm. On the other hand, if \mathcal{C} satisfies the assumptions of Theorem 3.31, then (X, \mathcal{C}) has the FPP if and only if X itself satisfies the LC. In any case, for any pair (X, \mathcal{C}) with the FPP, and with \mathcal{C} being a monoid, (4.7) holds for some $Y \subseteq X$ satisfying the LC.

The situation in which \mathcal{C} is not a monoid can be even more complicated still. Indeed, it is easy to construct examples of pairs (X, \mathcal{C}) with the FPP, where \mathcal{C} is not a monoid, where every step from X is (X, \mathcal{C}) -admissible, but where X does not satisfy the LC. For example, consider

$$X = \{(1, 0), (0, 1), (-2, 0)\} \quad \text{and} \quad \mathcal{C} = \{(0, 0), (1, 0), (1, 1), (-1, 1)\}.$$

Thus, in order to give a uniform treatment, we will assume for the duration of this section that X itself satisfies the LC; we continue to assume also that \mathcal{C} is a subset of \mathbb{Z}^2 containing O (but we do not assume \mathcal{C} is a monoid). Because of the LC, Theorem 2.44(ii) tells us that X has the FPP (and BPP); so too therefore does the pair (X, \mathcal{C}) .

The key idea that will allow us to calculate the numbers $\pi_X^\mathcal{C}(A)$ is to define a sequence of graphs $\Gamma_X^\mathcal{C}[q]$, $q \in \mathbb{N}$, such that the vertex sets of these graphs form an ascending chain whose union is all of $\mathcal{A}_X^\mathcal{C}$, and such that each vertex A of $\Gamma_X^\mathcal{C}[q]$ is labelled by $\pi_X^\mathcal{C}(A)$.

As indicated by the proofs of Propositions 2.15 and 3.7, a crucial role in calculating the numbers $\pi_X^\mathcal{C}(A)$ is played by the values

$$L(A) = \max\{\ell(w) : w \in \Pi_X^\mathcal{C}(A)\} \quad \text{for } A \in \mathcal{A}_X^\mathcal{C}.$$

Devising a method to calculate these values forms the bulk of this section. Note that $L(A)$ is the maximum length of a path from O to A in the graph $\Gamma_X^\mathcal{C}$. It is also easy to see that $L(A) = \max\{q \in \mathbb{N} : A \in \mathcal{A}_X^\mathcal{C}(q)\}$ in the notation of Section 4.1. For $q \in \mathbb{N}$ we define the sets

$$\mathcal{A}_X^\mathcal{C}[q] = \{A \in \mathcal{A}_X^\mathcal{C} : L(A) = q\} \quad \text{and} \quad \mathcal{A}_X^\mathcal{C}[\leq q] = \mathcal{A}_X^\mathcal{C}[0] \cup \dots \cup \mathcal{A}_X^\mathcal{C}[q] = \{A \in \mathcal{A}_X^\mathcal{C} : L(A) \leq q\}.$$

Again, we have an ascending chain of subsets

$$\{O\} = \mathcal{A}_X^\mathcal{C}[\leq 0] \subseteq \mathcal{A}_X^\mathcal{C}[\leq 1] \subseteq \mathcal{A}_X^\mathcal{C}[\leq 2] \subseteq \dots,$$

though this is generally different to that given in (4.1).

For $q \in \mathbb{N}$, we define $\Gamma_X^\mathcal{C}[q]$ to be the induced subgraph of $\Gamma_X^\mathcal{C}$ on the vertex set $\mathcal{A}_X^\mathcal{C}[\leq q]$. In other words, the graph $\Gamma_X^\mathcal{C}[q]$ is defined as follows:

Algorithm 2 Check the Line Condition.

Input: a finite step set $X = \{A_1, \dots, A_n\} \subseteq \mathbb{Z}_X^2$, with each $A_i = (x_i, y_i)$

Output: “Yes” if X satisfies the LC, or “No” otherwise; in the former case, also give a vector \mathbf{u} such that the line through O and perpendicular to \mathbf{u} witnesses the LC, with \mathbf{u} pointing towards the half-plane containing X

```
1: for  $i \in \{1, \dots, n\}$  do
2:   Calculate the polar angle  $\alpha_i$  of  $A_i$ 
3: Sort the  $\alpha_i$  in non-decreasing order: say,  $\alpha_{j_1} \leq \dots \leq \alpha_{j_n}$ 
4: if  $\alpha_{j_1} = \dots = \alpha_{j_n}$  then
5:   return “Yes”
6:   return the vector  $\mathbf{u} = \langle x_1, y_1 \rangle$ 
7: else
8:    $\beta_n := 2\pi + \alpha_{j_1} - \alpha_{j_n}$ 
9:   for  $i \in \{1, \dots, n-1\}$  do
10:     $\beta_i := \alpha_{j_{i+1}} - \alpha_{j_i}$ 
11:    $i := 1$ 
12:   while  $i \leq n$  do
13:     if  $\beta_i > \pi$  then
14:       return “Yes”
15:       return the vector  $\mathbf{u} = \langle y_{j_i} - y_{j_{i+1}}, x_{j_{i+1}} - x_{j_i} \rangle$ 
16:     else
17:        $i \leftarrow i + 1$ 
18:   return “No”
```

- The vertex set of $\Gamma_X^{\mathcal{C}}[q]$ is $\mathcal{A}_X^{\mathcal{C}}[\leq q]$.
- Each vertex A of $\Gamma_X^{\mathcal{C}}[q]$ is labelled by $\pi_X^{\mathcal{C}}(A)$.
- For each $A \in \mathcal{A}_X^{\mathcal{C}}[\leq q-1]$ and each $B \in X$ such that $A+B \in \mathcal{A}_X^{\mathcal{C}}[\leq q]$, $\Gamma_X^{\mathcal{C}}[q]$ has the edge $A \xrightarrow{B} A+B$.

(On the last point, note that it is possible to have $A \in \mathcal{A}_X^{\mathcal{C}}[\leq q-1]$ and $B \in X$ such that $A+B \in \mathcal{C}$ but $L(A+B) > q$, meaning that $A+B \notin \mathcal{A}_X^{\mathcal{C}}[\leq q]$.)

To construct the graphs $\Gamma_X^{\mathcal{C}}[q]$, we must clearly be able to construct the sets $\mathcal{A}_X^{\mathcal{C}}[q]$. In fact, the graphs $\Lambda_X^{\mathcal{C}}(q)$ defined in Section 4.1 were designed specifically to allow us to do this; this is all made precise in Lemma 4.11 below.

In what follows, it will also be convenient to define

$$\ell(A) = \min\{\ell(w) : w \in \Pi_X^{\mathcal{C}}(A)\} \quad \text{for } A \in \mathcal{A}_X^{\mathcal{C}}.$$

So $\ell(A)$ is the minimum length of a path from O to A in the graph $\Gamma_X^{\mathcal{C}}$. Note that we have the alternative characterisation $\mathcal{A}_X^{\mathcal{C}}(\leq q) = \{A \in \mathcal{A}_X^{\mathcal{C}} : \ell(A) \leq q\}$ for any $q \in \mathbb{N}$.

Lemma 4.8. *For any $q \in \mathbb{N}$,*

- (i) $\mathcal{A}_X^{\mathcal{C}}[\leq q]$ is contained in the vertex set of $\Lambda_X^{\mathcal{C}}(q)$; i.e., we have $\mathcal{A}_X^{\mathcal{C}}[\leq q] \subseteq \mathcal{A}_X^{\mathcal{C}}(\leq q)$,
- (ii) $\lambda_q(A) = L(A)$ for any $A \in \mathcal{A}_X^{\mathcal{C}}[\leq q]$.

Proof. Fix some $A \in \mathcal{A}_X^{\mathcal{C}}[\leq q]$. First note that $\ell(A) \leq L(A) \leq q$, so that A belongs to $\mathcal{A}_X^{\mathcal{C}}(\leq q)$; this gives part (i). Part (ii) follows from three obvious facts:

- any path from O to A in $\Gamma_X^{\mathcal{C}}$ has length at most $L(A) \leq q$,
- $\Lambda_X^{\mathcal{C}}(q)$ contains all paths in $\Gamma_X^{\mathcal{C}}$ beginning at O and of length at most q , and
- $\Gamma_X^{\mathcal{C}}$ has a path from O to A of length $L(A)$. □

Thus, the graph $\Lambda_X^{\mathcal{C}}(q)$ contains each $A \in \mathcal{A}_X^{\mathcal{C}}[\leq q]$ as a vertex, and each such vertex is labelled $L(A)$ in $\Lambda_X^{\mathcal{C}}(q)$. However, any other vertex of $\Lambda_X^{\mathcal{C}}(q)$, say $B \in \mathcal{A}_X^{\mathcal{C}}(\leq q) \setminus \mathcal{A}_X^{\mathcal{C}}[\leq q]$, satisfies $L(B) > q \geq \lambda_q(B)$. Moreover, we cannot simply look at $\Lambda_X^{\mathcal{C}}(q)$ and tell which vertices belong to $\mathcal{A}_X^{\mathcal{C}}[\leq q]$ and which belong to $\mathcal{A}_X^{\mathcal{C}}(\leq q) \setminus \mathcal{A}_X^{\mathcal{C}}[\leq q]$. The next lemma will help us overcome this problem.

For the statement, and for extensive later use, we first introduce some additional parameters. First, since X satisfies the LC, we let \mathbf{u} be a vector such that the line through O and perpendicular to \mathbf{u} witnesses the LC, with \mathbf{u} pointing to the half-plane containing X . Such a vector \mathbf{u} can be found using Algorithm 2. We also set

$$\mu_1 = \min\{\mathbf{u} \cdot \overrightarrow{OA} : A \in X\} \quad \text{and} \quad \mu_2 = \max\{\mathbf{u} \cdot \overrightarrow{OA} : A \in X\}. \quad (4.9)$$

Lemma 4.10. *For any $A \in \mathcal{A}_X^{\mathcal{C}}$, we have $L(A) \leq \left\lfloor \frac{\mu_2}{\mu_1} \cdot \ell(A) \right\rfloor$, where μ_1 and μ_2 are as in (4.9).*

Proof. Consider an (X, \mathcal{C}) -walk $A_1 \cdots A_k \in \Pi_X^{\mathcal{C}}(A)$, where $A_1, \dots, A_k \in X$. From $A = A_1 + \cdots + A_k$, it quickly follows that $\mu_1 \cdot k \leq \mathbf{u} \cdot \overrightarrow{OA} \leq \mu_2 \cdot k$. Since such walks exist for $k = \ell(A)$ and for $k = L(A)$, we have $\mu_1 \cdot L(A) \leq \mathbf{u} \cdot \overrightarrow{OA} \leq \mu_2 \cdot \ell(A)$, and so $L(A) \leq \frac{\mu_2}{\mu_1} \cdot \ell(A)$; the result follows since $L(A)$ is an integer. \square

Lemmas 4.8 and 4.10 allow us to prove the next result, which provides the basis for calculating the sets $\mathcal{A}_X^{\mathcal{C}}[0], \dots, \mathcal{A}_X^{\mathcal{C}}[q]$.

Lemma 4.11. *Let $q \in \mathbb{N}$, and put $Q = \left\lfloor \frac{\mu_2}{\mu_1} \cdot q \right\rfloor$, where μ_1 and μ_2 are as in (4.9). Then for any $0 \leq i \leq q$, we have $\mathcal{A}_X^{\mathcal{C}}[i] = \{A \in \mathcal{A}_X^{\mathcal{C}}(\leq q) : \lambda_Q(A) = i\}$.*

Proof. Since $\mathcal{A}_X^{\mathcal{C}}[i] \subseteq \mathcal{A}_X^{\mathcal{C}}[\leq q] \subseteq \mathcal{A}_X^{\mathcal{C}}(\leq q)$, by Lemma 4.8(i), we have $\mathcal{A}_X^{\mathcal{C}}[i] = \{A \in \mathcal{A}_X^{\mathcal{C}}(\leq q) : L(A) = i\}$. Thus, we can prove the lemma by showing that $\lambda_Q(A) = L(A)$ for all $A \in \mathcal{A}_X^{\mathcal{C}}(\leq q)$. But for any such A , Lemma 4.10 gives $L(A) \leq \left\lfloor \frac{\mu_2}{\mu_1} \cdot \ell(A) \right\rfloor \leq \left\lfloor \frac{\mu_2}{\mu_1} \cdot q \right\rfloor = Q$, and so $A \in \mathcal{A}_X^{\mathcal{C}}[\leq Q]$; it then follows from Lemma 4.8(ii) that $\lambda_Q(A) = L(A)$. \square

Thus, by Lemma 4.11, we may compute the sets $\mathcal{A}_X^{\mathcal{C}}[0], \dots, \mathcal{A}_X^{\mathcal{C}}[q]$ by calculating the graphs $\Lambda_X^{\mathcal{C}}(q)$ and $\Lambda_X^{\mathcal{C}}(Q)$; for $0 \leq i \leq q$, the set $\mathcal{A}_X^{\mathcal{C}}[i]$ is precisely the set of vertices of $\Lambda_X^{\mathcal{C}}(q)$ whose label in $\Lambda_X^{\mathcal{C}}(Q)$ is i .

Once we have computed the sets $\mathcal{A}_X^{\mathcal{C}}[0], \dots, \mathcal{A}_X^{\mathcal{C}}[q]$, it is easy to calculate the values $\pi_X^{\mathcal{C}}(A)$, $A \in \mathcal{A}_X^{\mathcal{C}}[\leq q]$. Indeed, as in the proofs of Propositions 2.15 and 3.7, if $A \in \mathcal{A}_X^{\mathcal{C}}[i]$ for some $1 \leq i \leq q$, then we have $\pi_X^{\mathcal{C}}(A) = \sum_{B \in X} \pi_X^{\mathcal{C}}(A - B)$. The key point here is that for any $B \in X$, either $A - B \in \mathcal{A}_X^{\mathcal{C}}[\leq i - 1]$ or else $A - B \notin \mathcal{A}_X^{\mathcal{C}}$. Algorithm 3 implements all of the above.

Example 4.12 (cf. Example 4.3). Figure 34 shows the graphs $\Gamma_X[7]$ and $\Gamma_X^{\mathcal{C}}[9]$ for the step set $X = \{(1, 0), (0, 1), (1, 1)\}$ and the submonoid $\mathcal{C} = \{(a, b) \in \mathbb{N}^2 : b \leq a\}$; these graphs were computed (and drawn) using Algorithm 3. The numbers $\pi_X(A)$ are the so-called *Delannoy numbers* [1, Sequence A008288]; the diagonal entries $\pi_X(n, n)$ are [1, Sequence A001850]. The numbers $\pi_X^{\mathcal{C}}(A)$ are [1, Sequences A033877 and A080247]; the diagonal entries are the *large Schröder numbers* [1, Sequence A006318].

Example 4.13 (cf. Example 4.5). Figure 35 shows the graphs $\Gamma_X[7]$ and $\Gamma_X^{\mathcal{C}}[9]$ for the step set $X = \{(1, 0), (0, 1), (1, 2)\}$ and the submonoid $\mathcal{C} = \{(a, b) \in \mathbb{N}^2 : b \leq a\}$. The numbers $\pi_X(A)$ and $\pi_X^{\mathcal{C}}(A)$ are [1, Sequences A257365 and A071943], respectively. The diagonal entries $\pi_X(n, n)$ and $\pi_X^{\mathcal{C}}(n, n)$ are [1, Sequences A006139 and A052709], respectively.

Example 4.14 (cf. Example 4.6). Figure 36 shows the graphs $\Gamma_X[7]$ and $\Gamma_X^{\mathcal{C}}[9]$ for the step set $X = \{(1, 0), (0, 1), (2, 2)\}$ and the submonoid $\mathcal{C} = \{(a, b) \in \mathbb{N}^2 : b \leq a\}$. At the time of writing, the numbers $\pi_X(A)$, $\pi_X^{\mathcal{C}}(A)$, $\pi_X(n, n)$ did not appear on the OEIS [1]. The sequence $\pi_X^{\mathcal{C}}(n, n)$, $n \in \mathbb{N}$, which begins 1, 1, 3, 8, 25, 83, 289, 1041, \dots , appears to match [1, Sequence A143330].

Example 4.15 (cf. Example 4.4). Figure 37 shows the graph $\Gamma_X[15]$ for the step set $X = \{(1, 0), (3, 0)\}$. The numbers $\pi_X(A)$ are the so-called *Narayana's cows sequence* [1, Sequence A000930]; cf. Remark 2.33.

We conclude this section with a short discussion of one other computational issue. In Algorithm 3, to calculate the sets $\mathcal{A}_X^{\mathcal{C}}[i]$, $i = 0, \dots, q$, and hence the numbers $\pi_X^{\mathcal{C}}(A)$, $A \in \mathcal{A}_X^{\mathcal{C}}[\leq q]$, we had to calculate the graphs $\Lambda_X^{\mathcal{C}}(q)$ and $\Lambda_X^{\mathcal{C}}(Q)$, where $Q = \left\lfloor \frac{\mu_2}{\mu_1} \cdot q \right\rfloor$ with μ_1, μ_2 as in (4.9). In general, Q could be rather bigger

Algorithm 3 Calculate the graph $\Gamma_X^{\mathcal{C}}[q]$.

Input: a finite step set $X \subseteq \mathbb{Z}_\times^2$ satisfying the Line Condition, a subset \mathcal{C} of \mathbb{Z}^2 containing O , and a natural number $q \in \mathbb{N}$

Output: the graph $\Gamma_X^{\mathcal{C}}[q]$

- 1: Calculate the vector \mathbf{u} using Algorithm 2
 - 2: Calculate the values μ_1 and μ_2 as in (4.9)
 - 3: $Q := \left\lfloor \frac{\mu_2}{\mu_1} \cdot q \right\rfloor$
 - 4: Calculate the set $\mathcal{A}_X^{\mathcal{C}}(\leq q)$, and the graph $\Lambda_X^{\mathcal{C}}(Q)$, using Algorithm 1
 - 5: **for** $i \in \{0, \dots, q\}$ **do**
 - 6: $\mathcal{A}_X^{\mathcal{C}}[i] := \{A \in \mathcal{A}_X^{\mathcal{C}}(\leq q) : \lambda_Q(A) = i\}$
 - 7: $V := \mathcal{A}_X^{\mathcal{C}}[0] \cup \dots \cup \mathcal{A}_X^{\mathcal{C}}[q]$, $E := \emptyset$
 - 8: $\pi_X^{\mathcal{C}}(O) := 1$
 - 9: $i := 1$
 - 10: **while** $i \leq q$ **do**
 - 11: **for** $A \in \mathcal{A}_X^{\mathcal{C}}[i]$ **do**
 - 12: $\pi_X^{\mathcal{C}}(A) := 0$
 - 13: **for** $B \in X$ **do**
 - 14: **if** $A - B \in \mathcal{A}_X^{\mathcal{C}}[0] \cup \dots \cup \mathcal{A}_X^{\mathcal{C}}[i - 1]$ **then**
 - 15: $\pi_X^{\mathcal{C}}(A) \leftarrow \pi_X^{\mathcal{C}}(A) + \pi_X^{\mathcal{C}}(A - B)$
 - 16: $E \leftarrow E \cup \{A - B \xrightarrow{B} A\}$
 - 17: **return** the graph $\Gamma_X^{\mathcal{C}}[q]$ with vertex set V , vertex labelling function π_X , and edge set E
-

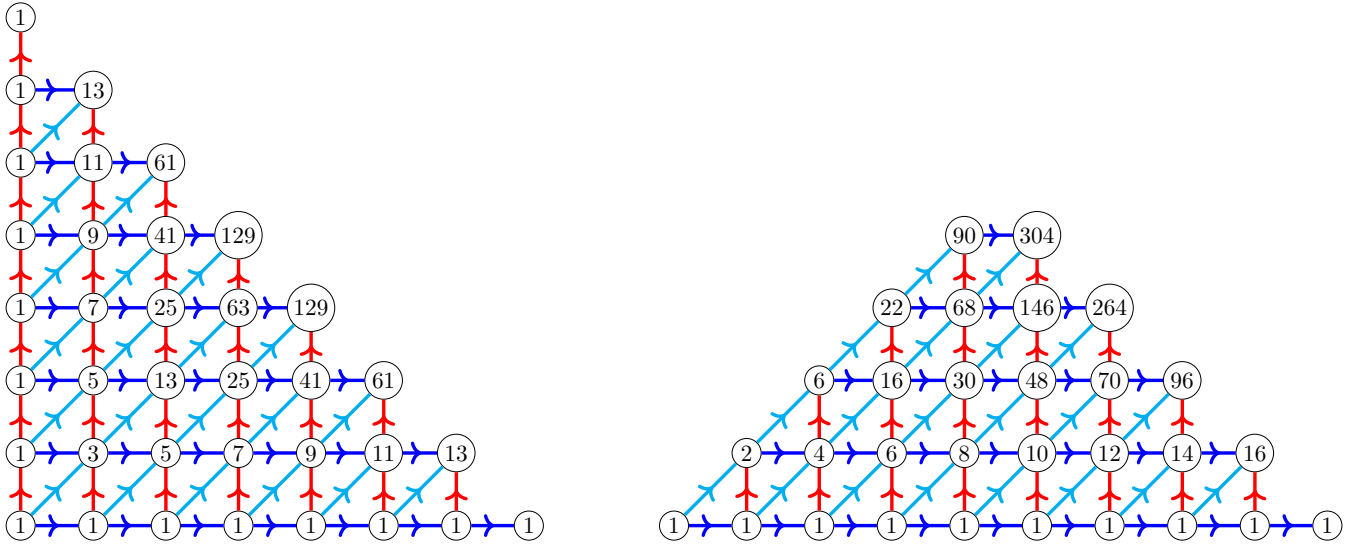

Figure 34: The graph $\Gamma_X[7]$ (left) and $\Gamma_X^{\mathcal{C}}[9]$ (right), where $X = \{(1,0), (0,1), (1,1)\}$ and $\mathcal{C} = \{(a,b) \in \mathbb{N}^2 : b \leq a\}$; cf. Example 4.12.

than q , and this obviously depends on the ratio μ_2/μ_1 . Since the parameters μ_i ($i = 1, 2$) were defined in terms of the vector \mathbf{u} , we write them as $\mu_i(\mathbf{u})$; since \mathbf{u} is not uniquely determined by X , it may be possible to increase the efficiency of Algorithm 3 by varying \mathbf{u} to find a lower value of $\mu_2(\mathbf{u})/\mu_1(\mathbf{u})$, and hence of Q itself.

For convenience in what follows, we assume that:

- $X = \{A_1, \dots, A_n\} \subseteq \mathbb{Z}_\times^2$ has the FPP, with $n \geq 2$,
- starting from A_1 and moving anti-clockwise, we see the points in the order A_1, \dots, A_n (but possibly with some points having the same polar angles, which are thus “seen” at the same time),
- the angle $\angle A_1 O A_2$ (measured anti-clockwise) is greater than π .

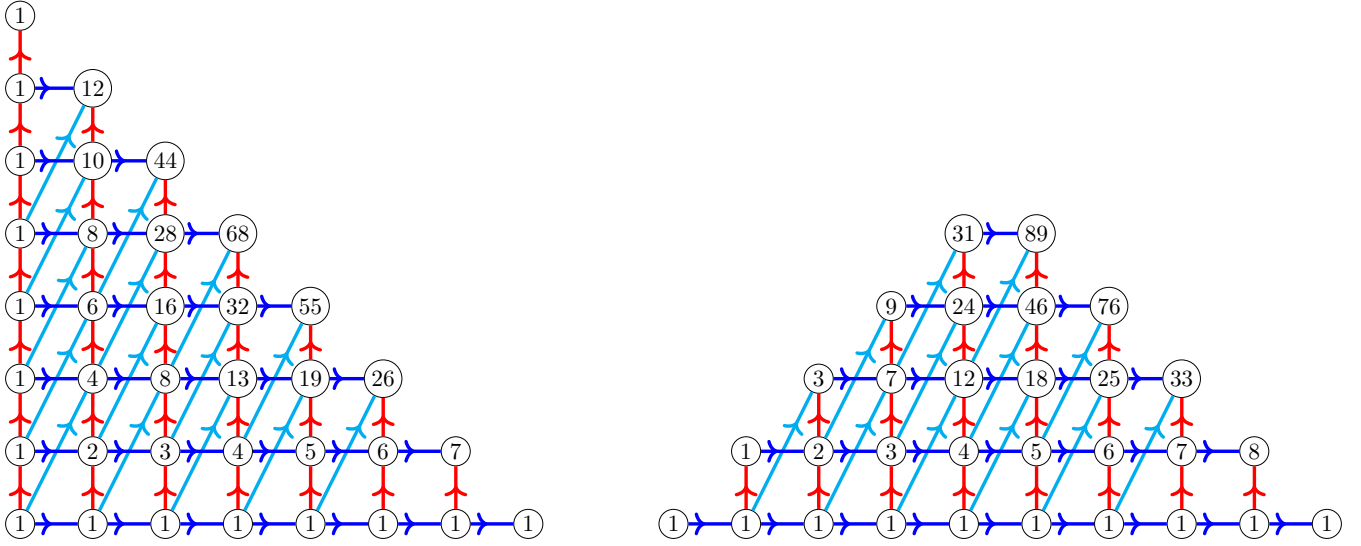

Figure 35: The graph $\Gamma_X[7]$ (left) and $\Gamma_X^{\mathcal{C}}[9]$ (right), where $X = \{(1, 0), (0, 1), (1, 2)\}$ and $\mathcal{C} = \{(a, b) \in \mathbb{N}^2 : b \leq a\}$; cf. Example 4.13.

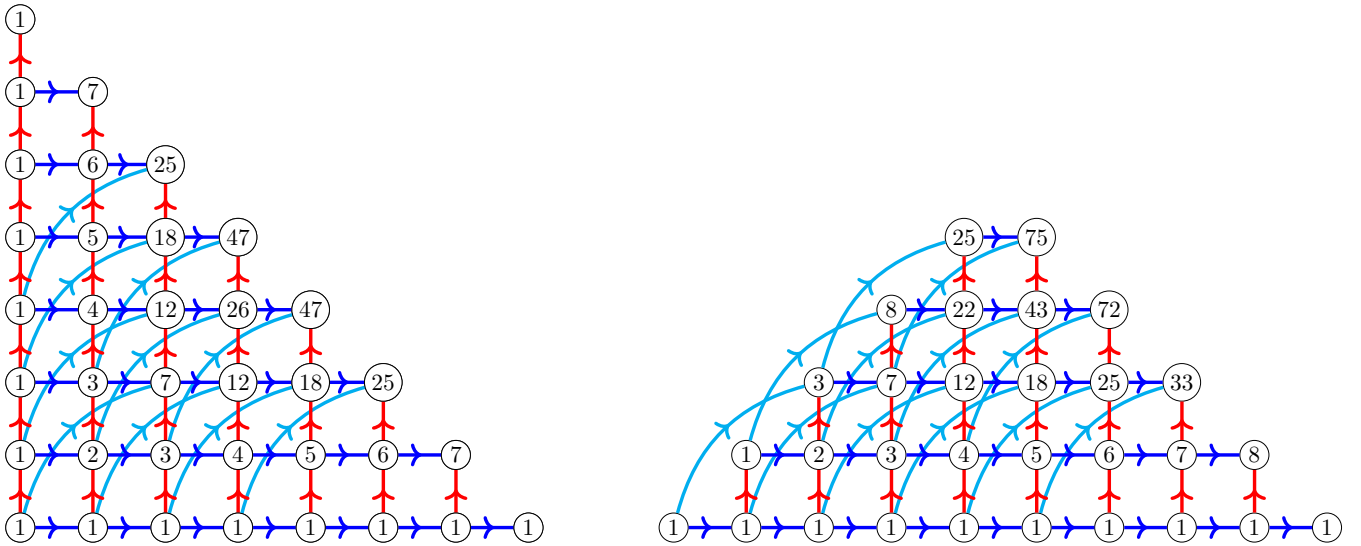

Figure 36: The graph $\Gamma_X[7]$ (left) and $\Gamma_X^{\mathcal{C}}[9]$ (right), where $X = \{(1, 0), (0, 1), (2, 2)\}$ and $\mathcal{C} = \{(a, b) \in \mathbb{N}^2 : b \leq a\}$; cf. Example 4.13.

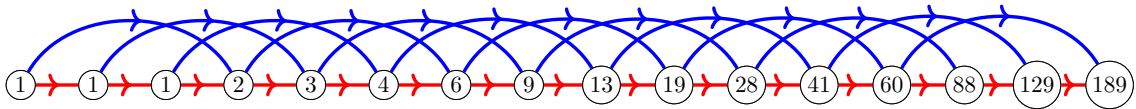

Figure 37: The graph $\Gamma_X[15]$, where $X = \{(1, 0), (3, 0)\}$; cf. Example 4.15.

This (and additional data yet to be defined) is all pictured in Figure 38. For each $i \in \{1, \dots, n\}$ we write $A_i = (x_i, y_i)$, and also $\mathbf{a}_i = \overrightarrow{OA_i} = \langle x_i, y_i \rangle$. If $\mathbf{a}_1, \dots, \mathbf{a}_n$ all point in the same direction, then by considering similar triangles, one may see that $\mu_2(\mathbf{u})/\mu_1(\mathbf{u})$ does not depend on \mathbf{u} . Thus, in what follows, we assume the \mathbf{a}_i do not all point in the same direction.

For $i = 1, 2$, let \mathcal{L}_i be the line through O and A_i , and let \mathbf{v}_i be a vector perpendicular to \mathcal{L}_i pointing into the half-plane containing $X \setminus \mathcal{L}_i$. With similar reasoning to above (considering that $\angle A_1OA_2 > \pi$), we will take $\mathbf{v}_1 = \langle y_1, -x_1 \rangle$ and $\mathbf{v}_2 = \langle -y_2, x_2 \rangle$. Then \mathbf{u} can be any vector pointing strictly between \mathbf{v}_1 and \mathbf{v}_2 . Up to scaling, any such vector has the form $\mathbf{u}_t = t\mathbf{v}_1 + (1-t)\mathbf{v}_2$ for some $0 < t < 1$; cf. Figure 38. We

therefore wish to find the value of $0 < t < 1$ minimising the ratio

$$f(t) = \frac{\mu_2(\mathbf{u}_t)}{\mu_1(\mathbf{u}_t)} = \frac{\max_i \mathbf{u}_t \cdot \mathbf{a}_i}{\min_i \mathbf{u}_t \cdot \mathbf{a}_i} = \max_{i,j} \frac{\mathbf{u}_t \cdot \mathbf{a}_i}{\mathbf{u}_t \cdot \mathbf{a}_j}.$$

Note that $\mathbf{u}_t \cdot \mathbf{a}_i = t\mathbf{v}_1 \cdot \mathbf{a}_i + (1-t)\mathbf{v}_2 \cdot \mathbf{a}_i = x_i(ty_1 + ty_2 - y_2) + y_i(x_2 - tx_1 - tx_2)$. Some numerical method could now be employed to minimise $f(t)$; we could even simply calculate $f(t)$ for several values of $0 < t < 1$, and use the vector \mathbf{u}_t corresponding to the minimal calculated value of $f(t)$.

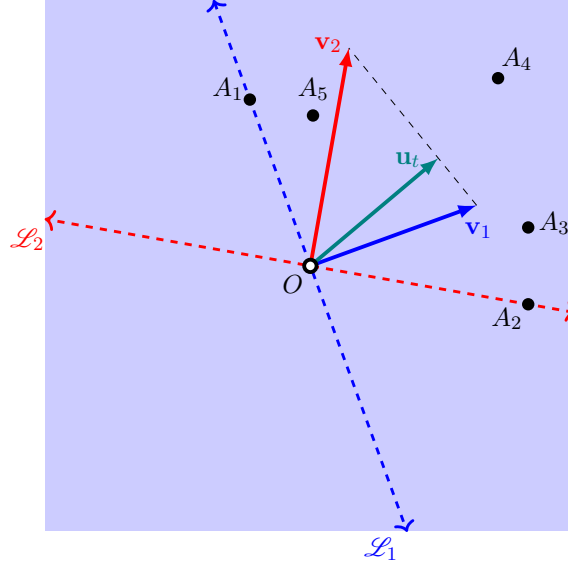

Figure 38: The lines $\mathcal{L}_1, \mathcal{L}_2$ and vectors $\mathbf{v}_1, \mathbf{v}_2, \mathbf{u}_t$ constructed while discussing the minimisation of μ_2/μ_1 .

Example 4.16. The case in which $|X| = 2$ is particularly simple. Indeed, consider the step set $X = \{A_1, A_2\}$, and for simplicity write $A_1 = (a, b)$ and $A_2 = (c, d)$, with $\angle A_1 O A_2 > \pi$ (measured anti-clockwise). Then one calculates

$$\mathbf{v}_1 = \langle b, -a \rangle, \quad \mathbf{v}_2 = \langle -d, c \rangle, \quad \mathbf{v}_1 \cdot \mathbf{a}_1 = \mathbf{v}_2 \cdot \mathbf{a}_2 = 0, \quad \mathbf{v}_1 \cdot \mathbf{a}_2 = \mathbf{v}_2 \cdot \mathbf{a}_1 = bc - ad,$$

from which it quickly follows that

$$f(t) = \frac{\max(\mathbf{u}_t \cdot \mathbf{a}_1, \mathbf{u}_t \cdot \mathbf{a}_2)}{\min(\mathbf{u}_t \cdot \mathbf{a}_1, \mathbf{u}_t \cdot \mathbf{a}_2)} = \frac{\max((1-t)(bc-ad), t(bc-ad))}{\min((1-t)(bc-ad), t(bc-ad))} = \frac{\max((1-t), t)}{\min((1-t), t)} = \begin{cases} \frac{1-t}{t} & \text{if } 0 < t \leq \frac{1}{2} \\ \frac{t}{1-t} & \text{if } \frac{1}{2} \leq t < 1. \end{cases}$$

This function is maximised when $t = \frac{1}{2}$, in which case $\mathbf{u}_{1/2} = \frac{1}{2}(\mathbf{v}_1 + \mathbf{v}_2) = \frac{1}{2}\langle b-d, c-a \rangle$. Note that Algorithm 2 returns the vector $\mathbf{u} = \langle b-d, c-a \rangle$, which points in the same direction as $\mathbf{u}_{1/2}$.

When $|X| \geq 3$, the situation is already a little more complicated, as the next two special cases show.

Example 4.17. Consider the step set $X = \{N, E, A\}$, where $N = (0, 1)$, $E = (1, 0)$ and $A = (a, b)$ with $a, b \in \mathbb{P}$ (we consider the case that one of $a, b = 0$ in the next example). Algorithm 2 returns the vector $\mathbf{u} = \langle 1, 1 \rangle$. In the notation of the above discussion, we have $A_1 = N$, $A_2 = E$ and $A_3 = A$. Further, $\mathbf{v}_1 = \langle 1, 0 \rangle$ and $\mathbf{v}_2 = \langle 0, 1 \rangle$, and so $\mathbf{u}_t = \langle t, 1-t \rangle$ for all $0 < t < 1$. We also calculate $\mathbf{u}_t \cdot \mathbf{a}_1 = 1-t$, $\mathbf{u}_t \cdot \mathbf{a}_2 = t$ and $\mathbf{u}_t \cdot \mathbf{a}_3 = ta + (1-t)b$. Since $a, b \geq 1$, we have $\mathbf{u}_t \cdot \mathbf{a}_3 \geq 1 \geq t, 1-t$, and so

$$f(t) = \frac{ta + (1-t)b}{\min(t, 1-t)} = \begin{cases} \frac{ta+(1-t)b}{t} = a - b + \frac{b}{t} & \text{if } 0 < t \leq \frac{1}{2} \\ \frac{ta+(1-t)b}{1-t} = b - a + \frac{a}{1-t} & \text{if } \frac{1}{2} \leq t < 1. \end{cases}$$

Now, $a - b + \frac{b}{t}$ is decreasing for $t > 0$, and $b - a + \frac{a}{1-t}$ is increasing for $t < 1$. It follows that $f(t)$ has its minimum for $0 < t < 1$ at $t = \frac{1}{2}$. Here we have $\mathbf{u}_{1/2} = \langle \frac{1}{2}, \frac{1}{2} \rangle$, which points in the same direction as $\mathbf{u} = \langle 1, 1 \rangle$ from above, and the minimum value of the ratio μ_2/μ_1 is $f(\frac{1}{2}) = a + b$.

Example 4.18. Consider the step set $X = \{N, E, aE\}$, where $N = (0, 1)$, $E = (1, 0)$ and $aE = (a, 0)$, for some integer $a \geq 2$ (the case with aE replaced by $aN = (0, a)$ is symmetrical). Algorithm 2 will order the points of X as either E, aE, N or aE, E, N . In these cases, the vector \mathbf{u} will be given as $\langle 1, 1 \rangle$ or $\langle 1, a \rangle$, respectively, but both of these vectors yield a ratio of $\mu_2/\mu_1 = a$, and again this turns out to be the best possible ratio. Indeed, \mathbf{u} can be any vector pointing into the first quadrant (not including the axes); scaling, we may assume that $\mathbf{u} = \langle 1, v \rangle$ where $v > 0$. Then

$$\frac{\mu_2(\mathbf{u})}{\mu_1(\mathbf{u})} = \frac{\max(1, a, v)}{\min(1, a, v)} = \frac{\max(a, v)}{\min(1, v)} = \begin{cases} \frac{a}{v} > a & \text{if } v < 1 \\ \frac{a}{1} = a & \text{if } 1 \leq v \leq a \\ \frac{v}{1} > a & \text{if } a < v. \end{cases}$$

Thus, $\mu_2/\mu_1 = \mu_2(\mathbf{u})/\mu_1(\mathbf{u})$ is minimised when $\mathbf{u} = \langle 1, v \rangle$ for arbitrary $1 \leq v \leq a$, and the minimum value is $\mu_2/\mu_1 = a$; this includes as extreme cases the vectors $\langle 1, 1 \rangle$ and $\langle 1, a \rangle$ above.

It is interesting to note that in Example 4.17 there is a unique direction for \mathbf{u} minimising μ_2/μ_1 , but that in Example 4.18 there is a whole interval of such directions. In both cases, Algorithm 2 produces a vector minimising μ_2/μ_1 .

4.4 Further examples

Figures 39–45 show the graphs $\Gamma_X[q]$ and $\Gamma_X^{\mathcal{C}}[q]$ for various step sets $X \subseteq \mathbb{Z}_x^2$, submonoids \mathcal{C} of \mathbb{Z}^2 , and values of q (all defined in the relevant captions); again, these were all produced using Algorithm 3, as implemented at [26]. Figures 42–44 feature the family of step sets $\{(k, 0), (0, k), (1, 1)\}$, for $k = 2, 3, 4$; the case of $k = 1$ was already treated in Figure 34; when $k = 2$ (Figure 42), we obtain a rotation of the Motzkin triangle (cf. Figures 10 and 21); so we may think of the resulting family of numbers as being generalisations of the Motzkin triangles. The bottom example in Figure 45 features a constraint set \mathcal{C}_4 that is not a monoid.

The reader may notice further patterns/relationships. For example, if we define $X = \{A, B, C\}$ and $Y = \{D, E, F\}$, where

$$A = (1, 2), B = (2, 1), C = (1, 1) \quad \text{and} \quad D = (3, 0), E = (0, 3), F = (1, 1),$$

then we have graph isomorphisms $\Gamma_X \cong \Gamma_Y$ and $\Gamma_X^{\mathcal{C}} \cong \Gamma_Y^{\mathcal{C}}$, where $\mathcal{C} = \{(a, b) \in \mathbb{N}^2 : b \leq a\}$; cf. Figures 39 and 43. Indeed, this is easy to understand; the subsets $\{A, B\} \subseteq X$ and $\{D, E\} \subseteq Y$ generate monoids isomorphic to \mathbb{N}^2 (cf. Proposition 2.32 and Remark 2.33), and we also have $A + B = 3C$ and $D + E = 3F$.

In order to avoid clutter, the directions on edges are mostly suppressed.

Acknowledgements

We thank Igor Dolinka, Rupert McCallum, Laurence Park and Stewart Wilcox for a number of helpful conversations during the preparation of the article; we are especially indebted to Wilcox for his construction of the sequences used in Section 2.10.

References

- [1] The Online Encyclopedia of Integer Sequences. Published electronically at oeis.org, 2018.
- [2] Abdallah Assi and Pedro A. García-Sánchez. *Numerical semigroups and applications*, volume 1 of *RSME Springer Series*. Springer, [Cham], 2016.
- [3] Cyril Banderier, Christian Krattenthaler, Alan Krinik, Dmitry Kruchinin, Vladimir Kruchinin, David Nguyen, and Michael Wallner. Explicit formulas for enumeration of lattice paths: basketball and the kernel method. *Preprint*, 2016, [arXiv:1609.06473](https://arxiv.org/abs/1609.06473).
- [4] J. Bertrand. Calcul des probabilités. solution d’un problème. *Co. Re. Acad. Sci. Paris*, 105:369, 1887.
- [5] Joseph Bonin, Anna de Mier, and Marc Noy. Lattice path matroids: enumerative aspects and Tutte polynomials. *J. Combin. Theory Ser. A*, 104(1):63–94, 2003.
- [6] Joseph E. Bonin and Anna de Mier. Lattice path matroids: structural properties. *European J. Combin.*, 27(5):701–738, 2006.
- [7] Alin Bostan. *Computer algebra for lattice path combinatorics*. PhD thesis, Université Paris 13, 2017.
- [8] Arne Brøndsted. *An introduction to convex polytopes*, volume 90 of *Graduate Texts in Mathematics*. Springer-Verlag, New York-Berlin, 1983.
- [9] T. M. Chan. Optimal output-sensitive convex hull algorithms in two and three dimensions. *Discrete Comput. Geom.*, 16(4):361–368, 1996. Eleventh Annual Symposium on Computational Geometry (Vancouver, BC, 1995).

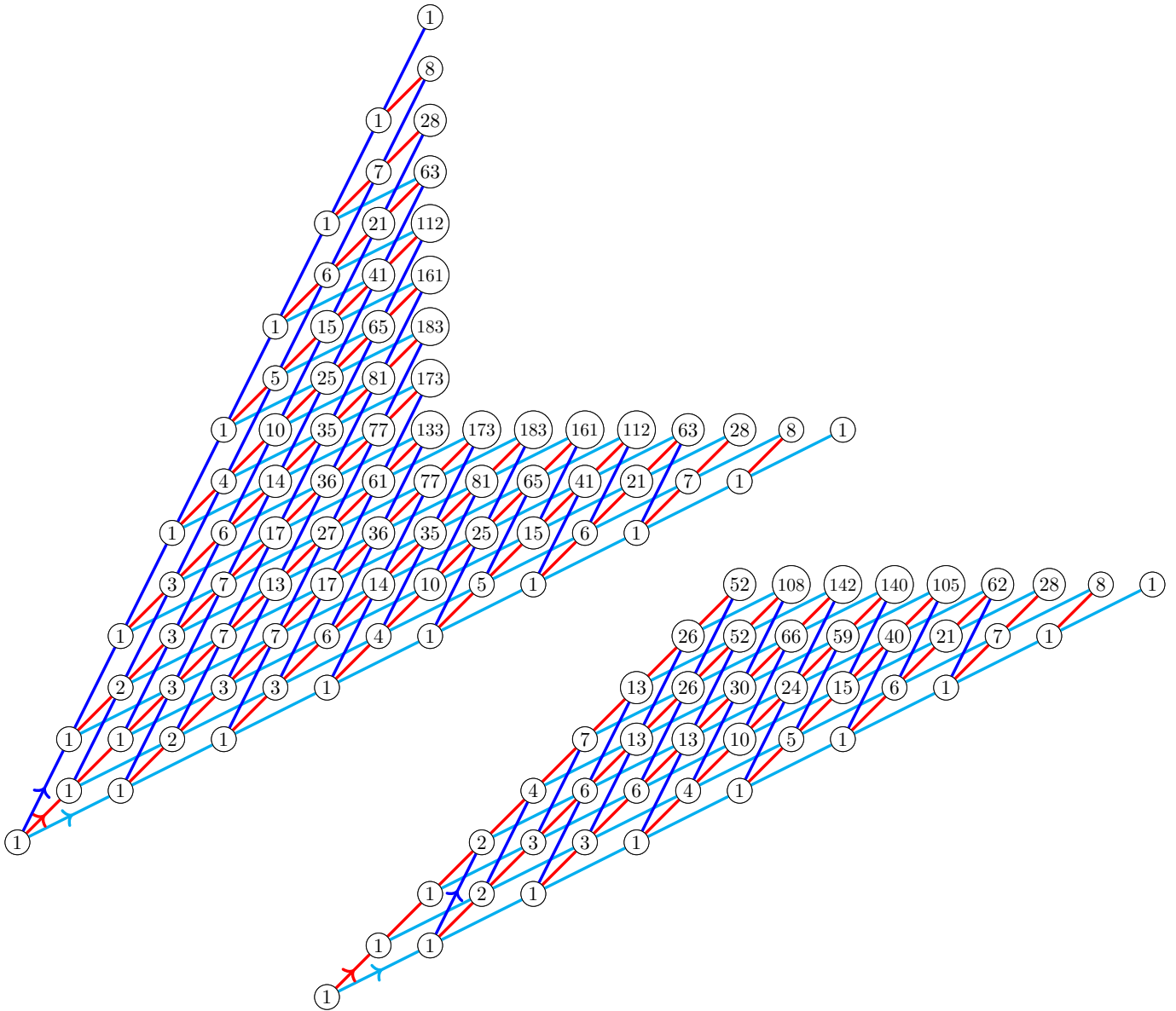

Figure 39: The graph $\Gamma_X[8]$ (left) and $\Gamma_X^{\mathcal{C}}[8]$ (right), where $X = \{(1, 2), (2, 1), (1, 1)\}$ and $\mathcal{C} = \{(a, b) \in \mathbb{N}^2 : b \leq a\}$.

- [10] Ashley Clayton and Nik Ruškuc. On the number of subsemigroups of direct products involving the free monogenic semigroup. *Preprint*, 2018, [arXiv:1803.08091](https://arxiv.org/abs/1803.08091).
- [11] Curtis Coker. Enumerating a class of lattice paths. *Discrete Math.*, 271(1-3):13–28, 2003.
- [12] Igor Dolinka, James East, Athanasios Evangelou, Des FitzGerald, Nicholas Ham, James Hyde, and Nicholas Loughlin. Enumeration of idempotents in diagram semigroups and algebras. *J. Combin. Theory Ser. A*, 131:119–152, 2015.
- [13] Igor Dolinka, James East, Athanasios Evangelou, Des FitzGerald, Nicholas Ham, James Hyde, Nicholas Loughlin, and James D. Mitchell. Enumeration of idempotents in planar diagram monoids. *Preprint*, 2015, [arXiv:1507.04838](https://arxiv.org/abs/1507.04838).
- [14] Igor Dolinka, James East, and Robert D. Gray. Motzkin monoids and partial Brauer monoids. *J. Algebra*, 471:251–298, 2017.
- [15] A. Dvoretzky and Th. Motzkin. A problem of arrangements. *Duke Math. J.*, 14:305–313, 1947.
- [16] James East and Robert D. Gray. Diagram monoids and Graham–Houghton graphs: Idempotents and generating sets of ideals. *J. Combin. Theory Ser. A*, 146:63–128, 2017.
- [17] Sen-Peng Eu, Tung-Shan Fu, Justin T. Hou, and Te-Wei Hsu. Standard Young tableaux and colored Motzkin paths. *J. Combin. Theory Ser. A*, 120(7):1786–1803, 2013.
- [18] Jianqiang Feng, Wenli Liu, Ximei Bai, and Zhenheng Li. Lattice path enumeration and its applications in representation theory. *Preprint*, 2017, [arXiv:1708.07003](https://arxiv.org/abs/1708.07003).
- [19] Daniel Flath, Tom Halverson, and Kathryn Herbig. The planar rook algebra and Pascal’s triangle. *Enseign. Math. (2)*, 55(1-2):77–92, 2009.
- [20] I. P. Goulden and Luis G. Serrano. Maintaining the spirit of the reflection principle when the boundary has arbitrary integer slope. *J. Combin. Theory Ser. A*, 104(2):317–326, 2003.
- [21] R.L. Graham. An efficient algorithm for determining the convex hull of a finite planar set. *Information Processing Letters*, 1(4):132 – 133, 1972.

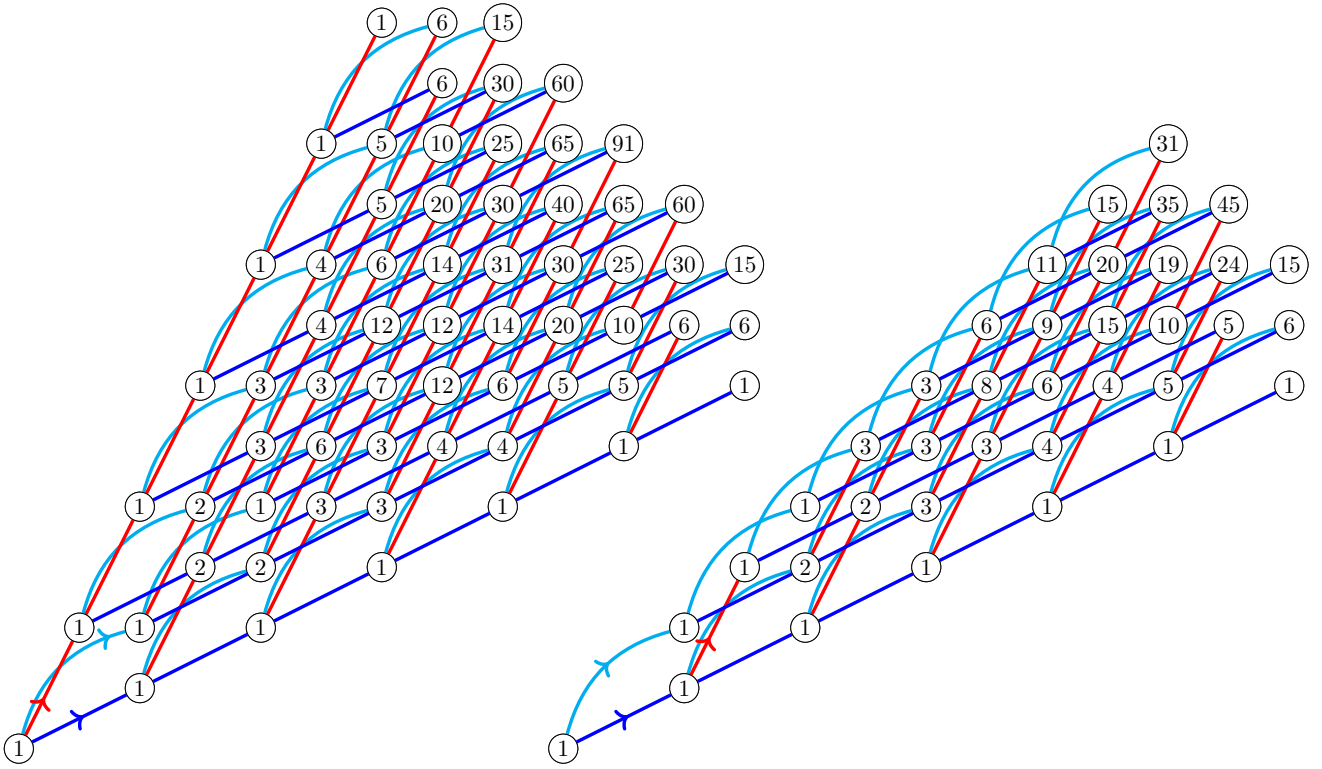

Figure 40: The graphs $\Gamma_X[6]$ (left) and $\Gamma_{\mathcal{C}}[6]$ (right), where $X = \{(1, 2), (2, 1), (2, 2)\}$ and $\mathcal{C} = \{(a, b) \in \mathbb{N}^2 : b \leq a\}$.

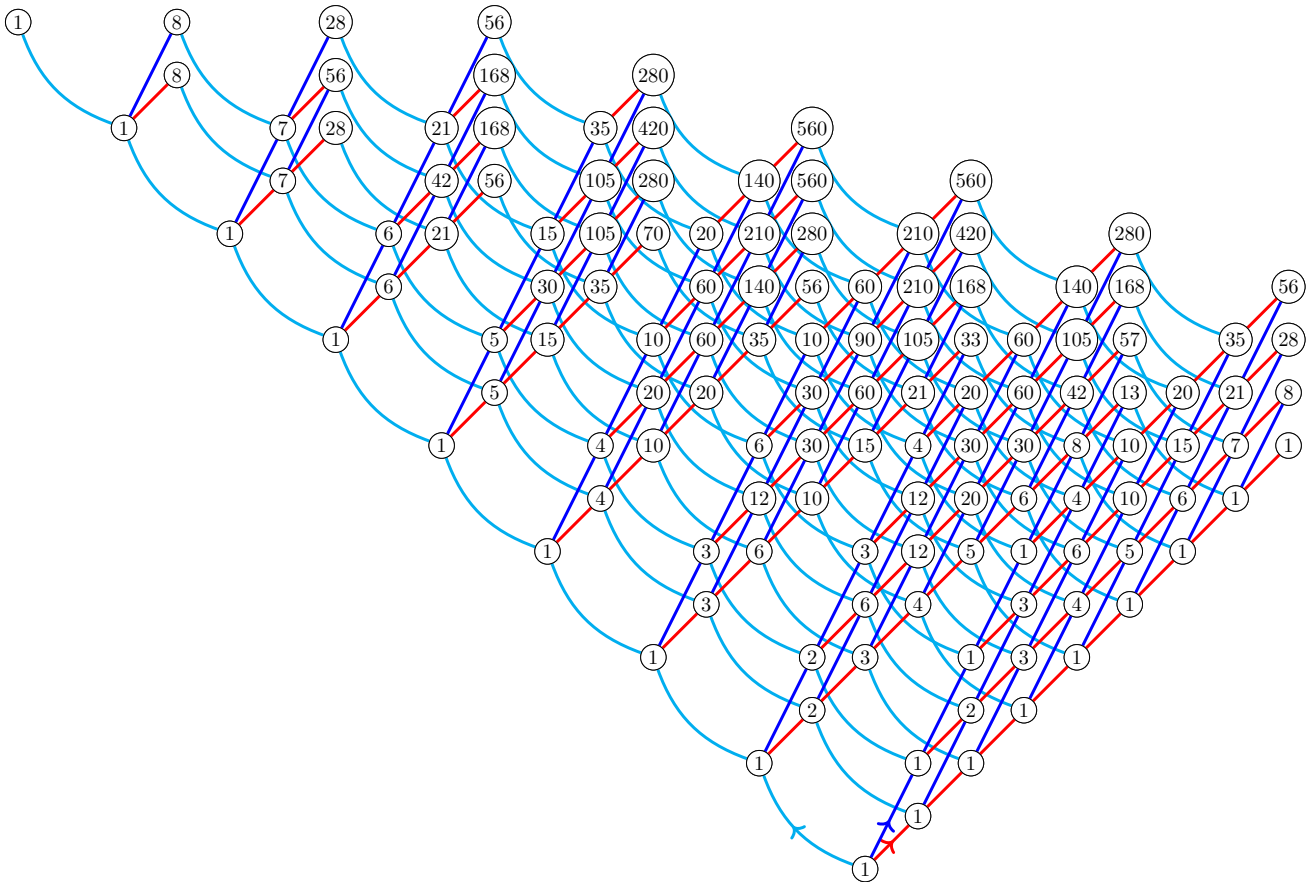

Figure 41: The graph $\Gamma_X[8]$, where $X = \{(1, 1), (1, 2), (-2, 2)\}$.

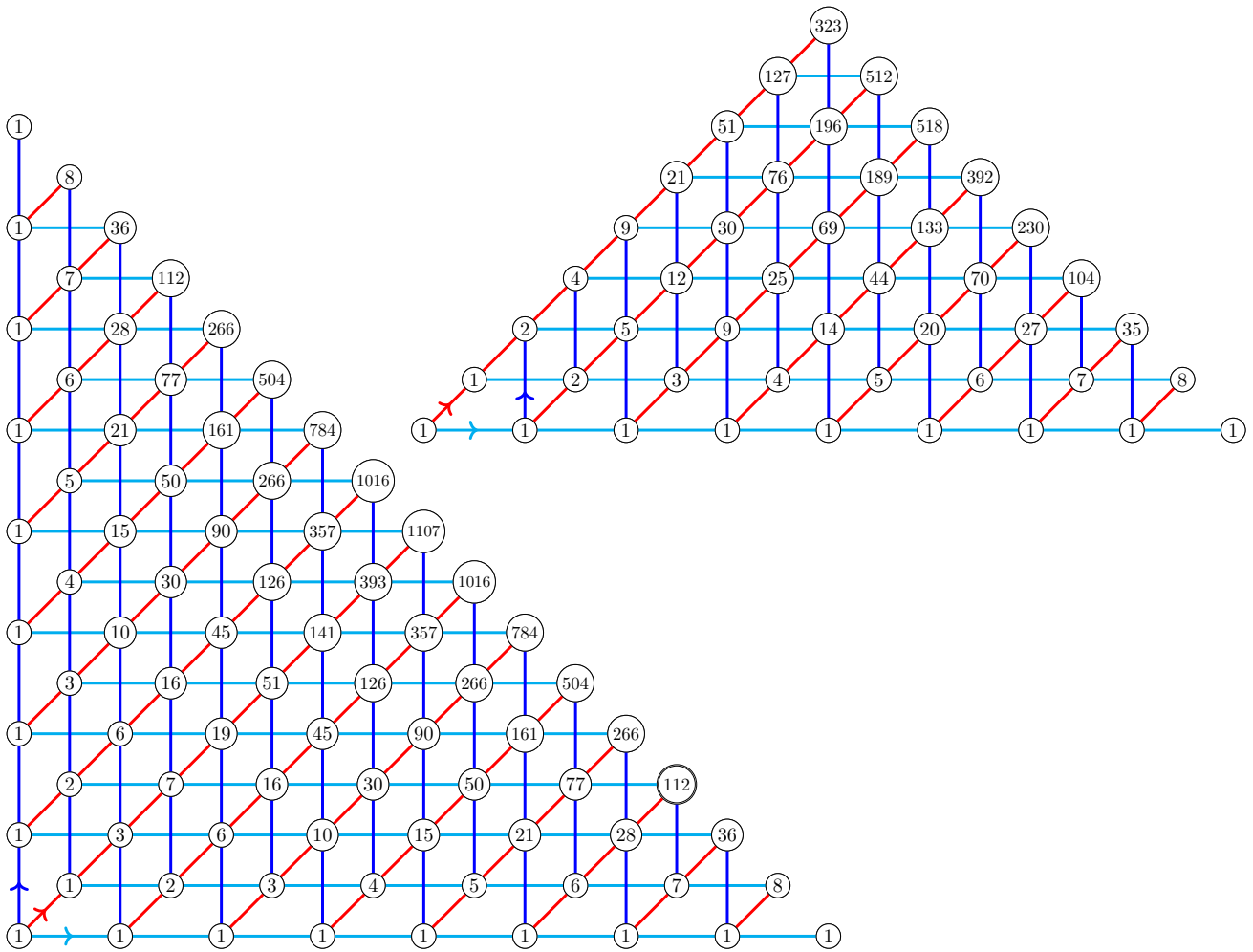

Figure 42: The graphs $\Gamma_X[8]$ (left) and $\Gamma_X^{\mathcal{C}}[8]$ (right), where $X = \{(2, 0), (0, 2), (1, 1)\}$ and $\mathcal{C} = \{(a, b) \in \mathbb{N}^2 : b \leq a\}$.

- [22] P. A. Grillet. *Commutative semigroups*, volume 2 of *Advances in Mathematics (Dordrecht)*. Kluwer Academic Publishers, Dordrecht, 2001.
- [23] Joseph Gubeladze. The isomorphism problem for monoid rings of rank 2 monoids. *J. Pure Appl. Algebra*, 105(1):17–51, 1995.
- [24] Joseph Gubeladze. The isomorphism problem for commutative monoid rings. *J. Pure Appl. Algebra*, 129(1):35–65, 1998.
- [25] Nicholas Ham. *The planar modular partition monoid*. PhD thesis, University of Tasmania, 2015.
- [26] Nicholas Ham. *Lattice path enumeration algorithms*, September 2018, <https://gitlab.com/n-ham-paper-files/lattice-path-algorithms>.
- [27] Frank Harary and Ronald C. Read. Is the null-graph a pointless concept? In *Graphs and combinatorics (Proc. Capital Conf., George Washington Univ., Washington, D.C., 1973)*, pages 37–44. Lecture Notes in Math., Vol. 406. Springer, Berlin, 1974.
- [28] G. H. Hardy and E. M. Wright. *An introduction to the theory of numbers*. The Clarendon Press, Oxford University Press, New York, fifth edition, 1979.
- [29] Katherine Humphreys. A history and a survey of lattice path enumeration. *J. Statist. Plann. Inference*, 140(8):2237–2254, 2010.
- [30] Aubrey J. Kempner. A theorem on lattice-points. *Ann. of Math. (2)*, 19(2):127–136, 1917.
- [31] B. Pascal. *Traité du triangle Arithmétique, avec quelques autres petits traités sur la mesme matiere*. Paris, G. Desprez, 1665.
- [32] J. L. Ramírez Alfonsín. *The Diophantine Frobenius problem*, volume 30 of *Oxford Lecture Series in Mathematics and its Applications*. Oxford University Press, Oxford, 2005.
- [33] Wolfgang M. Schmidt. *Diophantine approximation*, volume 785 of *Lecture Notes in Mathematics*. Springer, Berlin, 1980.
- [34] Richard P. Stanley. *Catalan numbers*. Cambridge University Press, New York, 2015.
- [35] Marc A. A. van Leeuwen. Some simple bijections involving lattice walks and ballot sequences. *Preprint*, 2010, [arXiv:1010.4847](https://arxiv.org/abs/1010.4847).

JE: Centre for Research in Mathematics, Western Sydney University, Sydney, Australia; J.East@WesternSydney.edu.au

NH: contact@n-ham.com

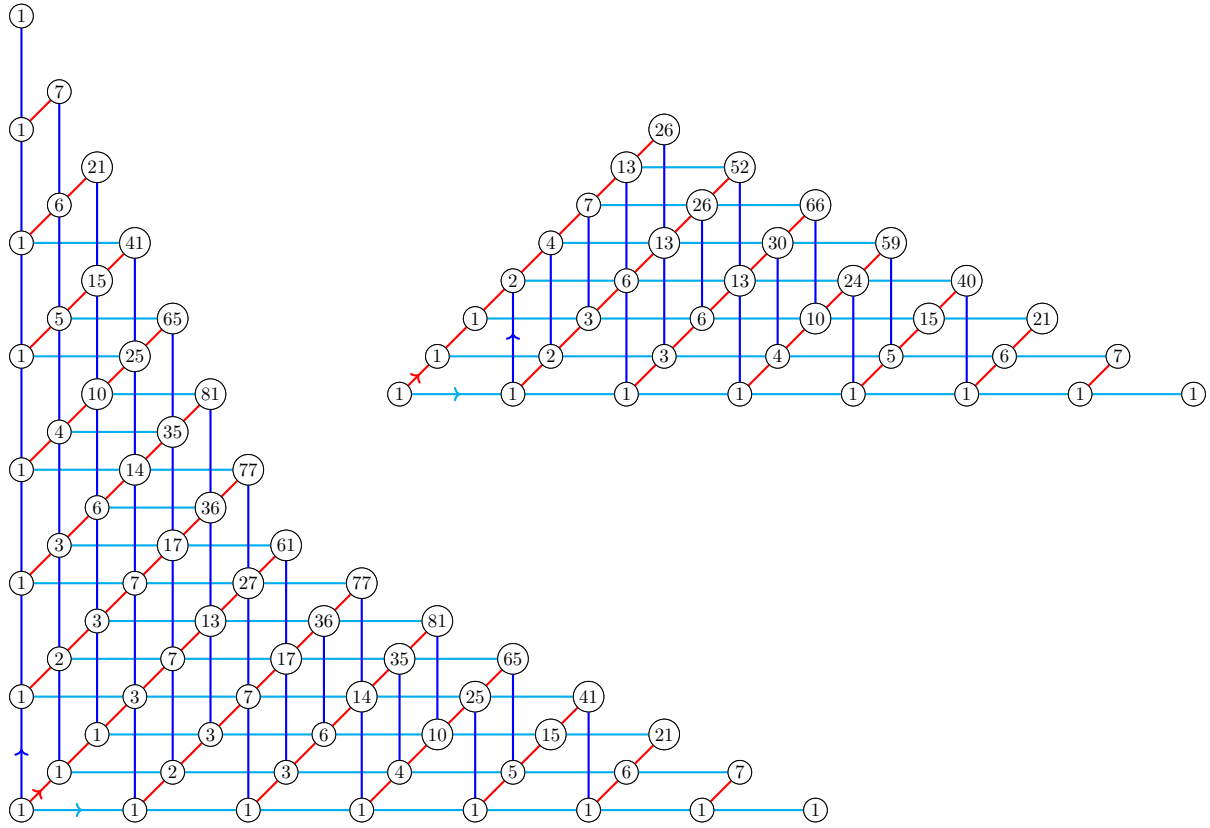

Figure 43: The graphs $\Gamma_X[7]$ (left) and $\Gamma_X^{\mathcal{C}}[7]$, where $X = \{(3, 0), (0, 3), (1, 1)\}$ and $\mathcal{C} = \{(a, b) \in \mathbb{N}^2 : b \leq a\}$.

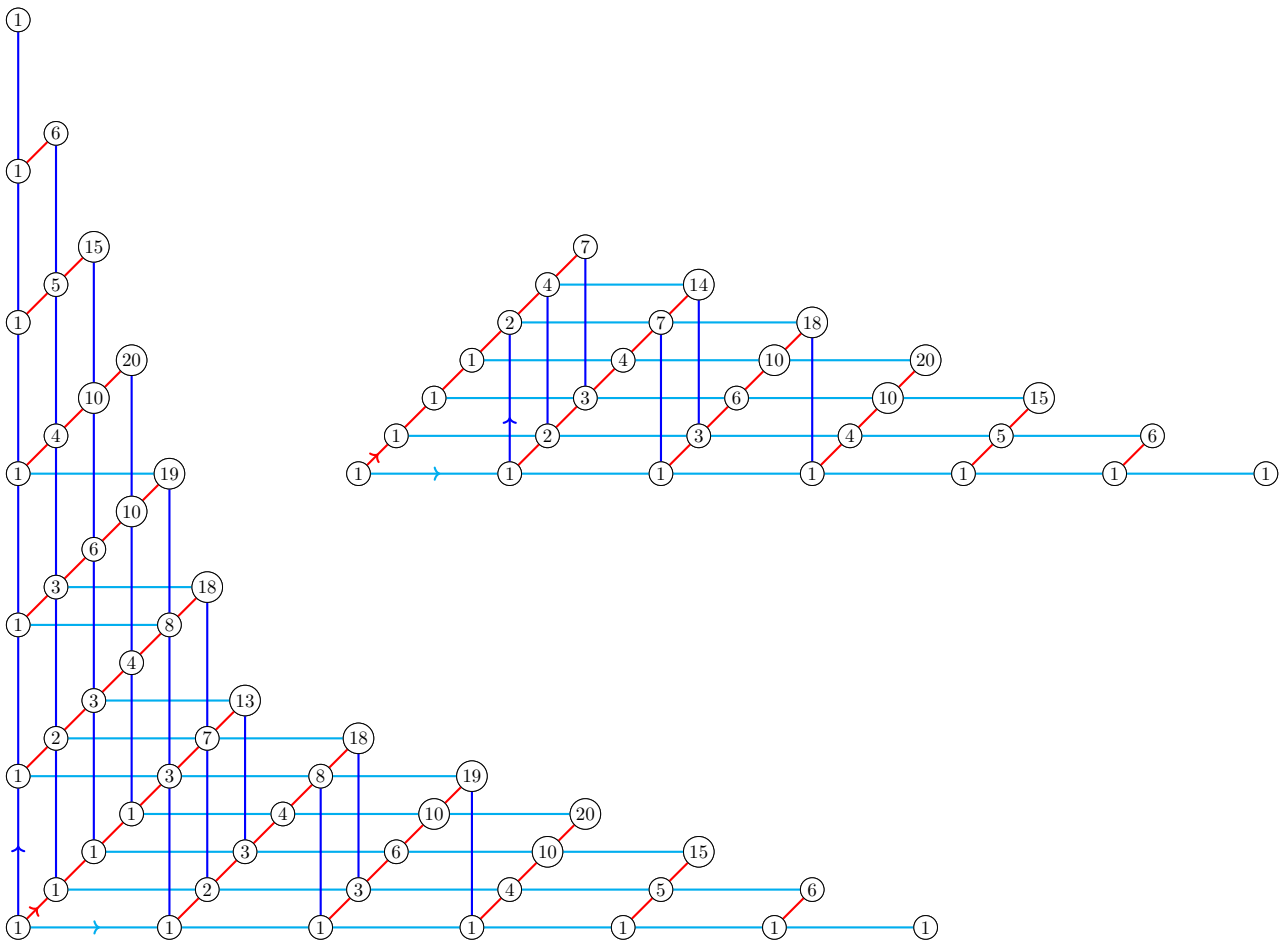

Figure 44: The graphs $\Gamma_X[6]$ (left) and $\Gamma_X^{\mathcal{C}}[6]$, where $X = \{(4, 0), (0, 4), (1, 1)\}$ and $\mathcal{C} = \{(a, b) \in \mathbb{N}^2 : b \leq a\}$.

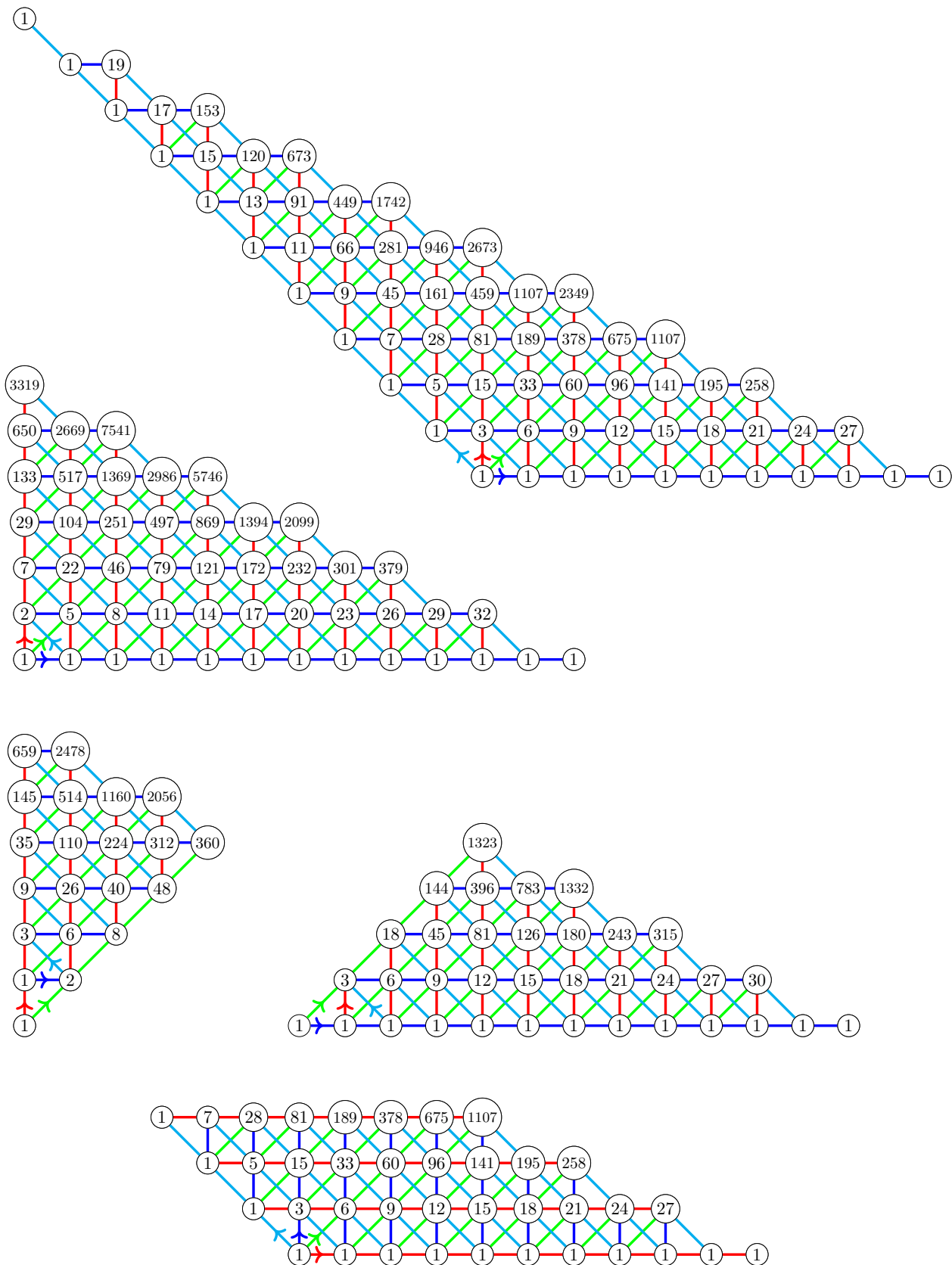

Figure 45: The graphs $\Gamma_X[10]$ (top), $\Gamma_X^{\mathcal{C}_1}[12]$ (second row), $\Gamma_X^{\mathcal{C}_2}[12]$ (third row, left), $\Gamma_X^{\mathcal{C}_3}[12]$ (third row, right) and $\Gamma_X^{\mathcal{C}_4}[10]$ (bottom), where $X = \{(1, 0), (1, 1), (0, 1), (-1, 1)\}$, $\mathcal{C}_1 = \mathbb{N}^2$, $\mathcal{C}_2 = \{(a, b) \in \mathbb{N}^2 : a \leq b\}$, $\mathcal{C}_3 = \{(a, b) \in \mathbb{N}^2 : b \leq a\}$ and $\mathcal{C}_4 = \{(a, b) \in \mathbb{Z}^2 : b \leq 3\}$.