

SCALE-Sim: Systolic CNN Accelerator Simulator

Ananda Samajdar^g

Yuhao Zhu^r
^gGeorgia Tech

Paul Whatmough^a
^rUniversity of Rochester
anandsamajdar@gatech.edu

Matthew Mattina^a
^aARM Research, Boston

Tushar Krishna^g

Abstract—Systolic Arrays are one of the most popular compute substrates within Deep Learning accelerators today, as they provide extremely high efficiency for running dense matrix multiplications. However, the research community lacks tools to provide principled insights on both the design trade-offs and efficient mapping strategies for systolic-array based accelerators.

We introduce Systolic Array Simulator (SCALE-SIM), which is a configurable systolic array based cycle accurate DNN accelerator simulator. SCALE-SIM exposes various micro-architectural features as well as system integration parameters to the designer to enable comprehensive design space exploration. This is the first systolic array simulator tuned for running DNNs to the best of our knowledge.

Using SCALE-SIM, we conduct a suite of case studies and demonstrate the effect of bandwidth, dataflow and aspect ratio on the overall runtime and energy of Deep Learning kernels across vision, speech, text, and games. We believe that these insights will be highly beneficial to both computer architects and ML practitioners.

I. INTRODUCTION

Deep Neural Networks (DNNs) have become prevalent for tackling many performance-critical and energy-constrained tasks over the last few years, such as real-time object detection [1], keyword spotting [2], and robot motion planning [3]. Amongst the various DNN topologies in use today, convolutional neural networks (CNNs) are arguably the most common. The end of performance scaling for CPUs, and the high power budgets of GPUs have led to a deluge of custom DNN accelerators from academia and industry [4], [5], [6], [7], [8].

Among previously proposed DNN accelerator architectures, 2D array architectures are a prominent choice, as they allow for operand reuse in two dimensions [6], [5], [8]. Of the various 2D array options, systolic array architectures are a natural match to CNNs because the local shifting data movement naturally echos the inherent dataflow of a native 2D convolution. Systolic arrays can also efficiently handle matrix-matrix and matrix-vector operations that arise during DNN training and running LSTMs respectively. The efficiency of systolic arrays comes from operand movement being purely local (neighbor to neighbor) which in turn provides high compute density (i.e., low area), low-energy, and simplified control. Coupled with a carefully-designed memory hierarchy, systolic array architectures can leverage the abundant data reuse in DNNs while keeping the processing elements (PE) busy to provide high throughput. Due to these properties, systolic arrays have been widely deployed - including the Google TPU ASIC [8], the Xilinx FPGA overlays xDNN [9], and academic proposals [6].

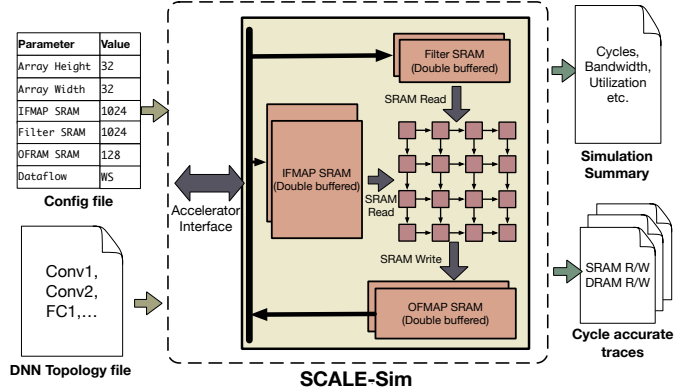

Fig. 1: Schematic depicting SCALE-SIM, with inputs and outputs. The tool takes in architecture parameters as a config file, and the workload hyper-parameters as a csv file; and generates cycle accurate traffic traces and simulation summary csv files

It is natural to assume that we will see many more accelerators being proposed as new DNN architectures and use cases are identified in the near future, which poses a large spectrum of efficiency and performance demands on the underlying accelerator design. This makes it imperative to quickly prototype architectural ideas and iterate over different designs. However, the various architecture design parameters have non-trivial interactions and thus lead to complex design decisions. In addition, different DNN topologies also cast significant implications on the optimal hardware architecture, requiring us to often co-design the accelerator architecture with the class of DNN kernels of interest (e.g., edge vs cloud/inference vs training).

In this work, we identify the key design parameters of systolic arrays, and reveal first-order insights about their interplay and respective contributions towards end-to-end performance and energy-efficiency. Also, we focus our attention on the fact that accelerators need to work as a part of a larger system; thus focusing on the integration aspects of the design with the rest of the system is necessary to understand limits on real-world performance and scalability.

With these goals in mind, we developed SCALE-SIM (Systolic CNN Accelerator Simulator), cycle-accurate, systolic-array based CNN accelerator simulator. SCALE-SIM exposes various micro-architectural features such as array size, array aspect ratio, scratchpad memory size, dataflow mapping strategy, as well as system integration parameters such as memory bandwidth. Taking the microarchitectural parameters and the dimensions of each DNN layer as input, SCALE-SIM

reports the latency, array utilization, SRAM accesses, DRAM accesses, and DRAM bandwidth requirement. Figure 1 shows the schematic representation of the tool along with an example of its inputs and outputs.

Leveraging SCALE-SIM, we perform a thorough analysis of the design space of the systolic-array architecture, using the MLPerf benchmark [10]. In the course of our study we identify several intricate trade-offs which were previously not thoroughly studied. We report our findings in four categories. First, we study the affect of various dataflows over a fixed systolic array micro-architecture and report the trends we observe in performance and energy efficiency. Second, we use SCALE-SIM to identify the factors needed to be considered for properly sizing the on-chip scratchpad memories to extract most performance and energy efficiency from a design. Third, we study the affect of the array (*aspect-ratio*) on performance for inference and report the trends. Finally, we perform a study to explore the trade-offs between two alternatives to increase performance, *Scaling-Up* vs *Scaling-out*. Our experiments indicate that the micro-architectural parameters and workload hyper-parameters are closely intertwined and thus lead to interesting trends. For example, for non-square arrays certain networks perform better in taller array than wider given a particular dataflow. However, if the dataflow is changed, the same network starts performing well of wider arrays and runtime increases exponentially as the array is made taller. Also, while scaling compute, the performance improvements in Scaling-out vs Scaling-up solely depends on network hyperparameters, regardless of dataflow.

In summary, we make the following contributions:

- We provide the first open-source, cycle-accurate DNN accelerator simulator based on the systolic-array architecture. It allows us to comprehensively understand the interplay among key design parameters - array size, aspect ratio, dataflow, and memory-bandwidth.
- Through a suite of case-studies, we demonstrate the impact of these parameters on performance, energy, and scalability across a diverse set of DNNs from MLPerf.

The rest of the paper is organized as follows. Section II introduces the background and motivation for this work. Section III describes the simulation methodology. Section IV uses SCALE-SIM to highlight design insights. Section V puts our work in the context of related work, and Section VI concludes.

II. MOTIVATION AND BACKGROUND

Given the large variety of applications for which deep learning based solutions apply, there is naturally a broad spectrum of design points, from tiny low-power embedded IoT devices through to large datacenter ASICs. Regardless of where in the spectrum a design lies, it has to be practical. An embedded design should produce a result in seconds-not in hours; on the other hand, a data center could not have a power plant of its own, so energy consumption should be optimized even if the accelerator is designed for delivering high performance. Naturally these constraints pose several challenges when it comes to making design choices.

Let’s consider Convolution Neural Networks (CNNs), which due to its relevance to a large gamut of problems, are one of the most widely used DNN layer types. A convolution layer is a multi-dimensional kernel, and can therefore be mapped onto the hardware in more than one way, depending upon loop unrolling order. The hardware itself, on the other hand, can schedule a given high level computational mapping in several possible ways. On top of this, there are system design choices like memory organization, interface design, workloads scheduling etc which have profound implications on power and performance. Given the large number of factors at play, designing an efficient accelerator is a complex optimization problem of tuning multiple inter-related constraints. The following sections describe these challenges in details.

A. Mapping dataflows to the architecture

A typical DNN accelerator comprises of multiple compute units which can perform multiplication and addition (MAC). As mentioned earlier there any many possible ways of mapping the compute onto the array. Each such mapping is called a data-flow. The data flows differ among themselves in terms of latency, throughput and data reuse [5]. In the present most of the DNN accelerators implement one data flow and optimizes around it. [4], [11], [12], [5]

However, not all data flows work efficiently for all types of layers in a given CNN. In the past few years we have seen that CNN topology design trends have changed a lot e.g., shallow networks with variable filter sizes (Alexnet), deep networks with fixed filter sizes (VGG), depth wise separable networks with variable filter size (Inception v4), and so on. An ideal case would be an accelerator which supports variable data-flows. But such a design would incur some overhead and might not be feasible. In such cases, it is important to keep the target application topologies in mind at design time and optimize for the common case.

B. Hardware optimizations

Assuming that an optimal data flow is determined and agreed upon, there are still multiple first and second order trade-off choices pertaining to final design decision. One of the first order choice is the layout of the compute units. For maximum performance the compute units need to be kept fed and running at all times. Although this seems trivial, the problem compounds itself when the number of compute elements become larger and the bandwidth of the communication channels cannot keep up. Moving to second order choices, the size of the on chip memory plays an major role in power-performance trade-off. If there is significant reuse, increasing the chip memory can prove beneficial for performance. However increasing memory size also increases power consumption. A small memory however will result in spilling, increasing DRAM interface bandwidth requirement hurting both power and performance goals. Thus proper sizing of the memory is critical.

Optimizing hardware by exploiting these trade-offs are at the heart of DNN accelerator research. For instance, prior works based on dot-product datapath [4], [7], [12], [11] utilize reuse

in only one dimension. While 2D arrays [5], [8] utilize reuse in higher dimensions.

C. Simulators for DNN acceleration

There is no denying the fact that efficient design of DNN accelerator is a key requirement to enable deployment of AI algorithms; be it in the embedded setting or within a data center space. Despite this importance, there has been an surprising dearth of knowledge base and simulation-emulation infrastructure in the public domain. A cycle-accurate simulation infrastructure for systolic arrays is lacking in the community today, which this work provides. Related efforts for alternate accelerator architectures are discussed in Section V.

III. SCALE-SIM: CNN ACCELERATOR SIMULATOR

SCALE-SIM is a simulator that provides a publicly available modeling infrastructure for systolic array CNN accelerators. SCALE-SIM enables designers to quickly iterate over and validate their upcoming designs with respect to the various optimization goals for their respective implementation points. In this section, we first describe the detailed modeling methodology, including how we model the compute (Section III-A), memory (Section III-C), and the accelerator’s interface with the whole system (Section III-D), respectively.

A. Modeling Compute

SCALE-SIM can simulate convolutions [13], [14] and matrix-matrix(MM) multiplications. Matrix-Vector(MV) and Vector-Vector(VV) multiplications are supported as special cases of MM with one or both dimensions as one. This lets us map fully-connected and recurrent layers in RNNs, which can be posed as MV problems. We chose to support only these operations since, among the various compute operations performed for CNN inference, convolutions and fully connected layers comprise more than 90% [5] of the total. Being the common case, it is therefore quite logical for accelerator designers to optimize for the said operations. Optimizing for any other step in general leads to diminished returns.

SCALE-SIM models the DNN accelerator’s compute unit as a systolic array. Systolic Arrays are effective, energy-efficient yet very simple designs to implement matrix multiplication and similar operations on hardware. As a result it is not surprising that many DNN accelerator designs [8], [9], [5] are based on systolic arrays. The systolic array in DNN accelerators comprise of several Multiply-and-Accumulate (MAC) units (also known as Processing Elements, or PEs), bounded together in a two dimensional mesh. The data is fed from the edges, which then propagate to the elements within the same row and columns via unidirectional links. Each MAC unit stores the incoming data in the current cycle in an internal register and then forwards the same data to the outgoing link in the next cycle. This store and forward behavior results in significant savings in SRAM read bandwidth and could very effectively exploit the reuse opportunities provided by convolution operation, making this a popular choice for accelerator design.

Among the recent accelerator designs, the shape of the systolic array has been almost invariably a square. Although

depending upon the workload and mapping strategy this might not be the best shape for performance and energy efficiency. Acknowledging this possibility, SCALE-SIM has the capability to take the length and breadth of the array as user input.

B. Modelling Dataflow

We define the term dataflow the same way as authors in Eyeriss do [5], and keep the same nomenclature. A given mapping scheme determines the order in which inputs are fetched, outputs are generated, and intermediate results are stored and reused. A particular dataflow determines the reuse within the array and the bandwidth requirements from the system.

Eyeriss describes *Output Stationary* (OS), *WeightStationary* (WS), *Input Stationary* (IS), *Row Stationary* (RS), and *No local reuse* (NLR). Out of these, SCALE-SIM models first three, which is provided by the user as input. NLR is not explicitly modelled since it is a special case for any of the dataflows with small buffer memories. RS on the other hand is fundamentally tied to the PE design chosen in Eyeriss. In the next few sections we will briefly describe these dataflows in the context of systolic arrays.

Output Stationary (OS)

The stationary term in the name of the dataflow indicates the matrix which is ”pinned” to a given PE. Output stationary therefore refers to the mapping where each pixel of the output feature map is assigned to a given PE. Given infinite resources, we would only need as many PEs as the number of output pixels. To achieve this, all the compute necessary for generating the given output is done on the said PE and the required operands are streamed in every cycle. Reduction operation is done in place and no further communication is needed between the MAC units as far as generating the given pixel is concerned. In a realistic case where the number of compute elements is limited, the resources are time multiplexed. Once one output pixel is generated by a given PE, the result is transferred to the memory and the PE is assigned another pixel to compute.

Figure 2(a) depicts the schematic of the dataflow in SCALE-SIM. The data is fed from left and top edges of the array, where the left edges stream in input pixels while the top edge streams in pixels from the filter or weight matrices. In a given column PEs in each row are responsible for generating adjacent output pixels in a single channel. Each column however generates pixels corresponding to different output channels.

The dataflow model implemented in SCALE-SIM assumes that the generated outputs can be transferred out of the array without incurring a stall in compute. In actual implementations this may not be true, hence the runtime might be higher than the calculated value. The rationale behind this decision is that SCALE-SIM depicts the opportunities and limitations arising from the dataflow itself, without any dependence on a specific implementation choice.

Weight Stationary (WS)

Following in the convention of nomenclature mentioned above, *Weight Stationary* dataflow refers to the mapping where each element of the weight matrix is uniquely mapped to a given

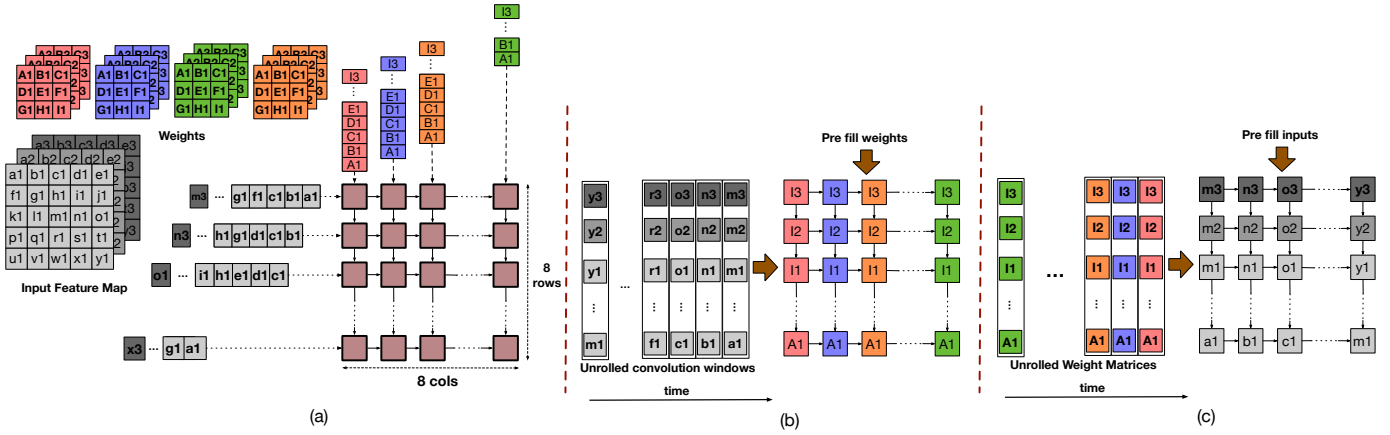

Fig. 2: Schematic showing the mapping in various dataflows (a) Output stationary; (b) Weight stationary; (c) Input stationary

MAC unit. Once a set of weights is mapped onto the array, they are not replaced until all the computations involving the given set of weights is finished. Every cycle the input elements required to be multiplied with the currently mapped weights are streamed and partial sums are stored within the array. Reduction takes place by communicating the partial sums across the MAC units present in the array and often takes multiple cycles. Figure 2(b) shows the mapping in WS dataflow. The mapping takes place in two steps. First each column is assigned to a given filter. For a given column, the elements of the assigned filter matrix are fed in from the top edge, till all the PEs in the given column has one element each. After the filter elements are placed, the pixels of input feature map are then fed in from the left edge. During this phase, the partial sums for a given output pixel is generated every cycle. For a given output pixel, the corresponding partial sums are distributed over a column. These partial sums are then reduced over the given column in next n cycles, where n is the number of partial sums generated for a given pixel. The weight pixels are kept in the array until all the computations which require these values as operands are not over. Once the computations corresponding to the mapped weight are done, the mapping is repeated with new set of weights.

Due to the sequential nature of the mapping; first the weights are mapped and then the inputs are streamed. The number of SRAM banks needed to support this implementation is lower than output stationary implementation for a given array. However, partial sums corresponding multiple output pixels are now required to be kept in the array, until they are reduced, which leads to increase in implementation cost.

Input Stationary (IS)

Input Stationary dataflow is a similar mapping as WS, where, as the name implies, pixels of the input feature map (IFMAP) are "pinned" with the PEs and elements of the weight matrices are streamed in.

Figure 2(c) depicts the schematic of the mapping. Similar to WS, this mapping also takes place in two stages. However, in this case, each column is assigned to a *convolution window*. The *Convolution window* is defined as the set of all the pixels

in the IFMAP which are required to generate a single OFMAP pixel. As in the case of WS, for a given column the pixels corresponding to a given convolution window are streamed in from the top edge. Once the input pixels are fed in, the elements of the weight matrices are streamed in from the left edge. Again similar to WS, reduction is performed over a given column, and the convolutions windows are kept around until all the computations requiring these elements are done, before remapping the array with elements belonging to new convolution windows.

This dataflow also enjoys the benefits of lower SRAM bank requirements, as compared to OS. However the cost and runtime compared to WS varies by workload.

C. Modeling Memory

CNNs are memory-intensive. Therefore, the memory hierarchy design is critical to the overall performance and energy consumption of a CNN accelerator. However, determining the optimal memory system design is non-trivial as the memory system must be co-designed with the compute array. SCALE-SIM models a parameterizable memory hierarchy for CNN accelerators and allows for co-optimizations between the computer units and the memory hierarchy.

The key to the on-chip memory hierarchy design for CNN accelerators is to exploit the ample data reuse provided by the convolution operations. A typical convolution can be viewed as a small filter kernel being slid over a given input matrix, with each overlap generating one output pixel. When the convolution operation is formulated as successive dot-product operations, three reuse patterns are immediately evident.

- Each convolution window uses the same filter matrix, to generate pixels corresponding to a given output channel
- The adjacent convolution windows share portions of the input matrix if the stride is smaller than window dimension
- To generate a output pixel in different output channels, different filter matrices use the same convolution window.

In short there are spatial, temporal and spatio-temporal reuse patterns in CNN inference.

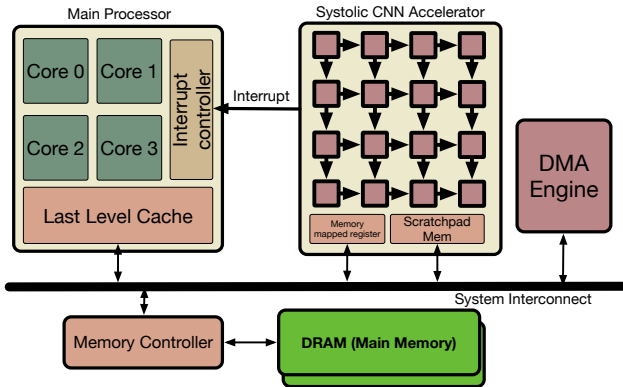

Fig. 3: Schematic showing the integration model of accelerator in a systems context

The memory system design would ideally keep the working set operands near the compute elements in any DNN accelerator. Naturally almost all accelerator designs provision for some scratchpad memory. However, determining the size of the scratchpad memory is non-trivial. Section II-B provides an insight on how memory size affects power and performance. Further complexity arises as the reuse behavior heavily depends upon the dataflow and the DNN layer hyper-parameters. Hence, determining optimal size of the memory is empirical and requires simulating the accelerator behavior when target workloads are used.

In SCALE-SIM we model the memory in three logical partitions that store IFMAP, filter matrices and the generated OFMAP, respectively. The size of each partition is user-specified. The utility for input and weight partitions are obvious, but at the first glance the output partition seems to be redundant. The output partition, however, serves two purposes. First, it stores the outputs till there are enough elements to allow for bursty transfers. Second, in case of WS an IS implementations it stores the partial sums.

All the memories in SCALE-SIM are modeled as double buffers to hide the SRAM access latency which a standard practice. For the uninitiated in the double buffered implementation there are two sets of memories, a working set and an idleset. At any given time the working set is used to feed the array and the idle set is populated by fetching data from the off-chip memory. For outputs, the working set is populated by the compute while the idle set is used by the DMA or equivalent memory controller for transferring its contents back to the off-chip memory.

D. Modeling System Interface

An accelerator by definition is a co-processing element augmented with a main processing system to improve overall performance. However, contemporary pieces of work in this space tend to overlook the system integration aspect assuming that the given accelerator design will integrate as is. However, aggressive design points leading to optimal accelerator performance might result in suboptimal system performance. For example, an accelerator design might have multiple processing elements to exploit parallelism, but in reality system memory

Parameter	Description
ArrayHeight	Number of rows of the MAC systolic array
ArrayWidth	Number of columns of the MAC systolic array
IfmapSRAMsz	Size of the working set SRAM for IFMAP in KBytes
FilterSRAMsz	Size of the working set SRAM for filters in KBytes
OfmapSRAMsz	Size of the working set SRAM for OFMAP in KBytes
IfmapOffset	Offset to the generated addresses for IFMAP px
FilterOffset	Offset to the generated addresses for filter px
OfmapOffset	Offset to the generated addresses for OFMAP px
DataFlow	Dataflow for this run. Legal values are 'os', 'ws', and 'is'
Topology	Path to the topology file

TABLE I: SCALE-SIM config description

is unable to supply enough operands to keep all the units busy [15]. It is therefore important to understand the implication of integrating an DNN accelerator into the overall system.

We consider the typical model of accelerator integration in SCALE-SIM. That is to attach the DNN accelerator to the system interconnect on a slave interface as Figure 3 shows. The master is a processor which interacts with the accelerator by writing task descriptors to memory mapped registers. When a task is offloaded to the accelerator, the master context switches to work on other jobs, while the accelerator wakes up and starts computing, independently generating its memory requests and side channel signals. When finished, the accelerator then copies the result to the memory and notifies the master.

With this interaction model in mind, it could be seen that the interface with the system bus serves as a reasonable proxy for the overall behavior when it is integrated with the system. SCALE-SIM allows for modeling the main memory behavior by generating accurate read and write bandwidths of the interface, which can then be fed into a DRAM simulator eg. DRAM-Sim2[16]. In general, as described in Section III-C the memories inside a DNN accelerator are scratchpad memories and not caches. Therefore, coherence is not managed in hardware. Thus, we do not model it in SCALE-SIM.

E. Implementation

SCALE-SIM internally takes an inside out implementation approach. Specifically, the simulator assumes that the compute units are always used to the maximum possible utilization - as dictated by dataflow mapping, and never stall waiting for data. As mentioned before, the rationale behind this choice is that SCALE-SIM highlights the opportunities and limitations by virtue of the modelling parameters (eg. dataflow, memory sizing) and not any specific implementation choice. With this implementation model, the simulation in SCALE-SIM takes place in following steps.

- SCALE-SIM generates cycle accurate read addresses for elements required to be fed on the top and left edges of the array *such that the PE array never stalls*. These address are effectively the SRAM read traffic for filter and input matrices, as dictated by the dataflow. Given the reduction takes predictable cycles after data has been fed in, SCALE-SIM generates output trace for the output matrix, which essentially constitutes the SRAM write traffic.
- SCALE-SIM parses the generated traffic traces, to determine total runtime for compute and data transfer to

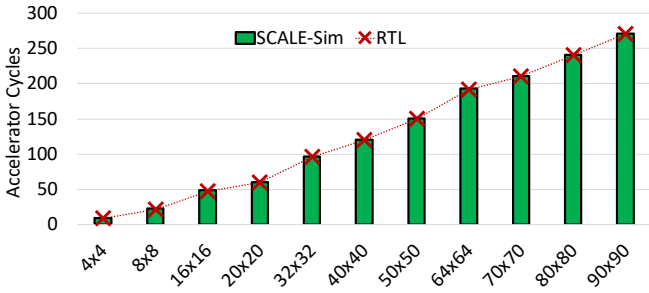

Fig. 4: Cycles reported by SCALE-SIM runs and RTL simulation for Mat-Mat multiplication workloads

Parameter	Description
Layer Name	User defined tag
IFMAP Height	Dimension of IFMAP matrix
IFMAP Width	Dimension of IFMAP matrix
Filter Height	Dimension of one Filter matrix
Filter Width	Dimension of one Filter matrix
Channels	Number of Input channels
Num Filter	Number of Filter matrices. This is also the number of OFMAP channels
Strides	Strides in convolution

TABLE II: SCALE-SIM Topology file description

and from SRAM. The data transfer time is essentially the cycle count of last output trace entry. Parsing the SRAM traffic also provides utilization information of the array.

- Given the SRAM traffic and the SRAM configurations, SCALE-SIM then generates DRAM traffic trace, for both input and output data transfer.
- Finally the DRAM traces are parsed to estimate the memory bandwidth requirement as well as memory power consumption.

Validation We validate SCALE-SIM against an in-house RTL model for a systolic array implementing OS dataflow. The workload we chose is a Mat-Mat multiplication of matrices with same size as the array. Figure 4 depicts how the run times tally for the two platforms.

F. User Interface

The tool takes two files as inputs from the user, a config file and other is a topology file. This file contains the user specification for architectural parameters, like the array size, the memory size etc and the path to the topology file. Table I depicts the complete list of parameters.

The topology file contains the information of the hyper-parameters for the various layers in a given DNN. This is a csv file, with each row listing all the required hyper-parameters for a given layer, Table II gives the complete list of all the entries in a given row. SCALE-SIM parses the topology file one line at a time and simulates the execution of the layer. This is a natural model for traditional DNNs. However, in modern DNNs there are cells with multiple conv layers in parallel [17]. SCALE-SIM serializes the execution for such layers in the same order in which the layers are listed in the topology csv file.

SCALE-SIM generates, two types of outputs. First is the cycle accurate traces for SRAM and DRAM reads and writes.

Tag	Description
W1	AlphaGoZero [18]
W2	DeepSpeech2 [19]
W3	FasterRCNN [20]
W4	Neural Collaborative Filtering [21]
W5	Resnet50 [17]
W6	Sentimental CNN [22]
W7	Transformer [23]

TABLE III: Workloads used in this work

The traces are also csv files, which list the cycle and the addresses of data transferred in the given cycle. The other type of output file are the metrics files, which summarizes the parsed information from the traces, these include cycle counts, utilization, bandwidth requirements, total data transfers etc.

IV. DESIGN INSIGHTS USING SCALE-SIM

Systolic array is a well known architecture for implementing matrix multiplication and several other linear algebra kernels in hardware. The communication of operands in the array is very efficient as the data is only passed between neighbors and does not require any global communication. Address generation and matching is also not required. Being a natural fit, there have been several systolic-array based CNN accelerators, with some used in commercial applications, like the Google TPU [8] and Xilinx xDNN [9].

However, the design process for 2D arrays is not straightforward due to the large number of free parameters and the variety of DNN workloads in common use. We use SCALE-SIM to observe the effects of various design decisions on the performance and energy of a systolic-array based accelerator.

In the next few sections we will describe and present results from various experiments performed using SCALE-SIM targeted towards efficient accelerator design.

A. Methodology

As mentioned in the previous sections, SCALE-SIM gives the user to choose the micro-architectural parameters. In the following set of experiments we study the affect of each of these parameters by sweeping over a range of values while keeping others constant. Unless stated otherwise, we keep the number of compute units same as that of TPUv3 (128x128 MACs). However unlike TPUv3 we assume a data size of 1 byte, which is standard for DNN inference. The default size of scratchpad memory for operands in our experiments is 1024 KB, with 512 KBs allocated to filter and IFMAP buffers each. To ensure that our workloads represent a wide class of applications in the ML space, we chose MLPERF [10]. MLPERF is an ongoing effort in the machine-learning and systems community to provide a standard benchmark for both software and hardware frameworks. Table III shows the workloads we use. The user might notice that we have replaced Masked-RCNN with FasterRCNN, since both these workloads have similar hyper-parameters but FasterRCNN finishes faster in our simulations.

B. Effect of dataflow

As we have discussed in Section III-B *dataflow* refers to the mapping strategy of compute on the array. It is not

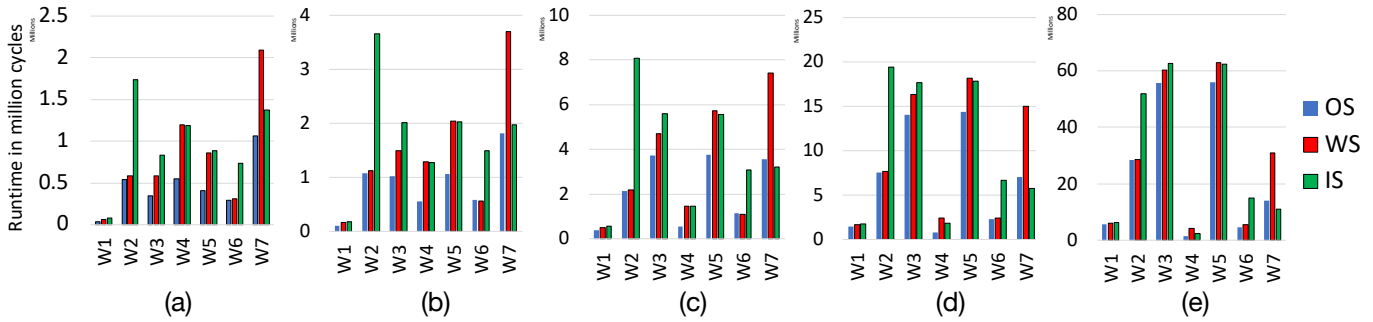

Fig. 5: Chart showing the runtime in cycles to compute all the layers of our workloads while using different dataflows in square arrays with the dimensions (a)128x128, (b)64x64, (c)32x32, (d)16x16, and (e)8x8

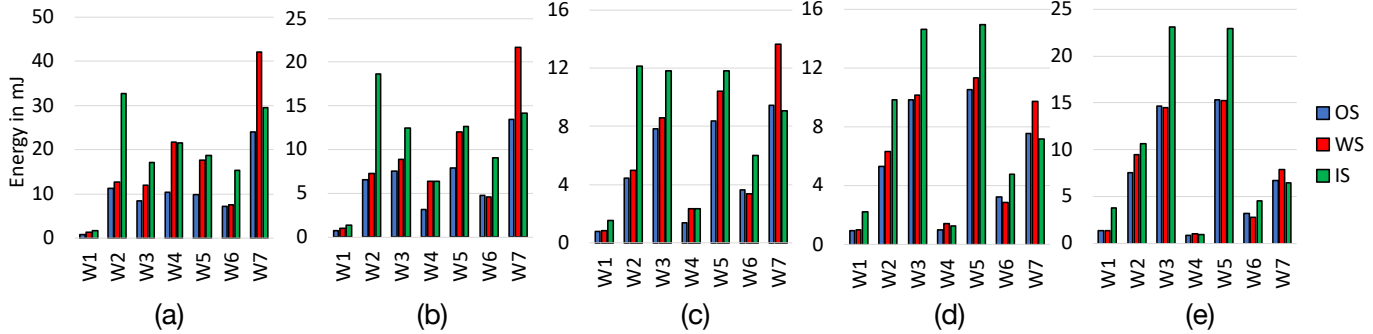

Fig. 6: Chart showing the energy consumed in mJ, in compute and memory transfers for all the layers in our workloads using different dataflows in square arrays with dimensions (a)128x128, (b)64x64, (c)32x32, (d)16x16, and (e)8x8

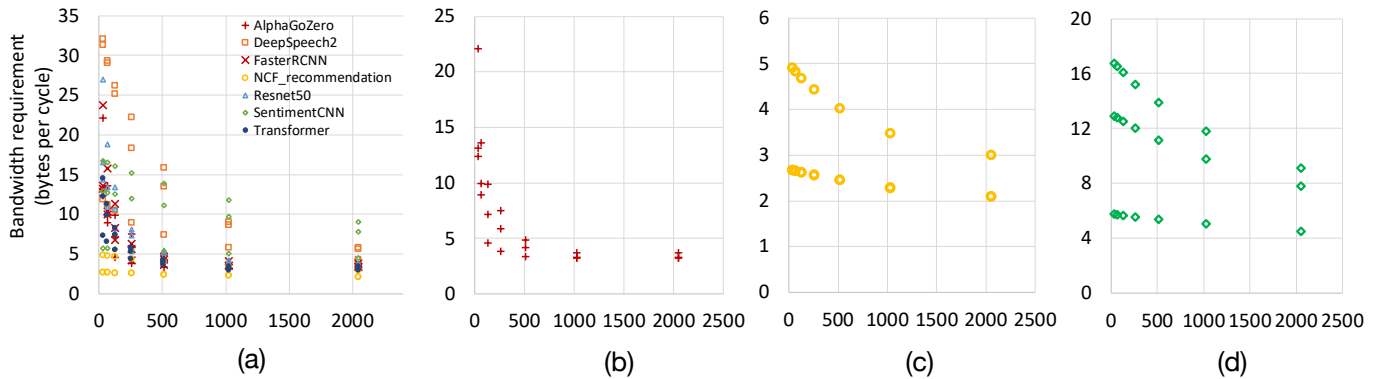

Fig. 7: Figures depicting the required DRAM bandwidth vs scratchpad memory size for stall free operation for (a) all workloads, (b) AlphaGoZero(W1), (c) Neural Collaborative Filtering(W4), (d) Sentimental analysis CNN (W6)

surprising that dataflow will have direct implications on the performance and efficiency of the system. Most of the recent DNN accelerators chose a particular dataflow and stick with it. The microarchitecture is usually optimized around this dataflow thus rendering the mapping scheme immutable. The authors of FlexFlow [24] argue that this practice leads to inefficiencies in terms of energy and performance and hence propose a custom accelerator to combat the same.

In this section we use SCALE-SIM to see if the argument holds in case of systolic arrays. In particular we try to answer the following questions,

- 1) *Does the size of the array dictate the choice of dataflow?*
- 2) *How much does the hyper-parameters of the workload*

dictate choice of dataflow?

- 3) *Are we missing out a lot by employing fixed dataflows? Or is there a dataflow which works in all cases?*

Figure 5 and Figure 6 depict the trends in runtime and energy when arrays of different size run the workloads with various dataflows. In a glance it seems, *Output Stationary*(OS) outperforms the other two dataflow in every aspect. However, it might be worth noting that implementing a stall free OS hardware might not be trivial. Furthermore in the energy calculations, the cost of logic within the accelerator is assumed to be the same for the three dataflows, which might not always hold true. Moreover, for square arrays, WS and IS use half the amount of SRAM banks as compared to OS. SRAM banks are

expensive resources in terms of area footprint.

Among IS and WS we see interesting trends, which help us address the questions we raised before. Looking at the runtime trends for W4, we notice that for larger array sizes, 128×128 and 64×64 the IS and WS performance is comparable. However as the array sizes decrease, IS turns out to be more performant than WS. This helps us answer the first question. If W4 or similar networks are dominant workloads for a given use case, then the choice of dataflow is tied with the size of the array to extract maximum performance.

Transferring our attention to W2 and W7, we notice that WS and IS are clear winners in the respectively in these workloads. This trend is invariant of the size of the array and therefore is clearly dependent on network hyper-parameters. In general for WS and IS dataflows, the less times the 'stationary' matrix is needed to be mapped into the array, the better. This is because mapping of stationary matrices take cycles which cannot be utilized for compute. If in a layer the number of output pixels are larger than the number of weights then WS will outperform IS and vice versa.

Although we observe clear indications that hyper-parameters and array size affects the choice of dataflow, the trends in Figure 5 and Figure 6 do not show dramatic effects, unless designing a highly optimized design tied to any workload. Therefore to answer question 3, although there might not be a dataflow choice to rule them all, fixating to a given dataflow might not lead to significant losses in terms runtime or energy. Therefore while designing systems with flexible dataflows, the cost of implementation should be carefully evaluated.

C. Effect of Memory Sizing

Providing sufficient on-chip memory has a major implication of the performance of the DNN accelerators. Due to the massive reuse opportunity provided by CNNs, providing large enough memory can significantly reduce off-chip accesses and hence improve the energy consumption and overhead on the system. However memory is an expensive resource both in term of area and power consumption. Therefore, sizing the memory appropriately is an important aspect for accelerator design.

Figure 7 shows the off-chip bandwidth requirement for various workloads when the on-chip memory size is increased from 32KB to 2048KB for each Filter and IFMAP buffers. Figure 7(a) shows that the return diminish after hitting 1MB buffer size for the common case. However, for specific workloads the knee of the curve varies significantly. Figure 7(b) shows that W1 hits the knee at 256KB, while Figure 7(c) shows for W4 the knee lies for even smaller sizes. On the other hand W6 shows improvements even after 1024KB as depicted in Figure 7(d)

D. Effect of Shape of the array

Given a fixed number of compute units, a set of hyper-parameters and a given dataflow, it is quite interesting to explore the effect of the shape of the array on performance. We use SCALE-SIM to compute runtime for our workloads by changing the shape of systolic array from, 8×2048 to 2048×8 . Figure 8 shows our findings. It is quite interesting to observe that the combination of dataflow and shape has dramatic trends.

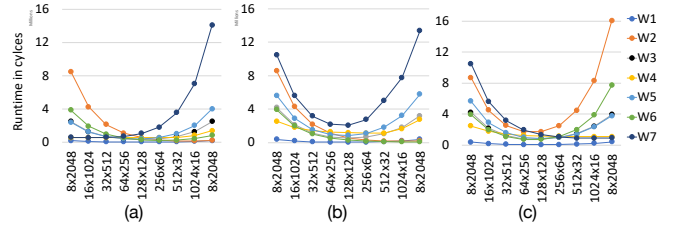

Fig. 8: Chart showing the variation of runtime for our workloads run different shapes of systolic array with fixed number of PEs (=16384) for three dataflows (a) Output Stationary, (b) Weight Stationary, (c) Input Stationary

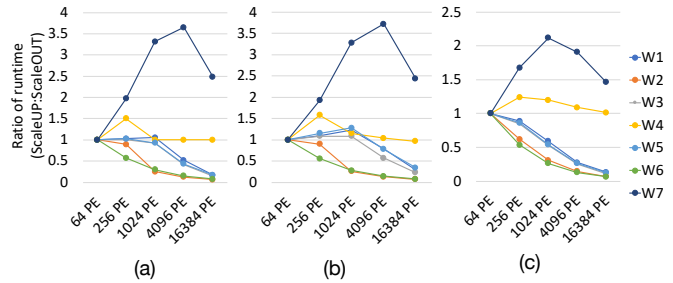

Fig. 9: Figure showing the ratio of runtime between runs on a scaled-up array vs a scaled-out implementation where the total number of compute elements are equal for different dataflows (a) Output stationary, (b) Weight stationary, (c) Input stationary.

For instance OS and WS favor short-wide configurations for W4, while IS favors square aspect-ratios. On the other hand, OS and IS favor completely different configurations for W7. Interestingly square aspect ratios perform well for the common case.

E. Scaling out vs Scaling up

It is a no-brainer that performance can be increased by throwing more compute elements on a highly-parallelizable workload, such as CNN inference. However, scaling can be achieved in two major ways, by adding making the array bigger (*scaling-up*) or by having more arrays and dividing compute among them (*scaling-out*). The TPU is an embodiment of the former approach, while NVIDIA's tensor cores of the latter.

We performed an experiment to explore the tradeoffs between the two approaches. We start from an 8×8 array (64PEs) and increase the number of compute elements to 16384, multiplying by 4 in each step. For scaling-up each step corresponds to doubling the length and breadth of the array, while for scaling-out each step is just quadrupling the number of 8×8 arrays. For the purposes of this case study, we divide the workload for scale-out along the output channels, i.e., the different filters are assigned to different nodes thus different nodes generating different output channels. Alternate partitioning strategies exist, and in fact the best strategy may differ from layer to layer depending on the number of filters vs channels. We do not add any arbitration or bandwidth constraints on the interconnect connecting the arrays in the scale-out mode; instead SCALE-SIM's outputs for SRAM read bandwidth requirement determines the bandwidth requirement for this interconnect.

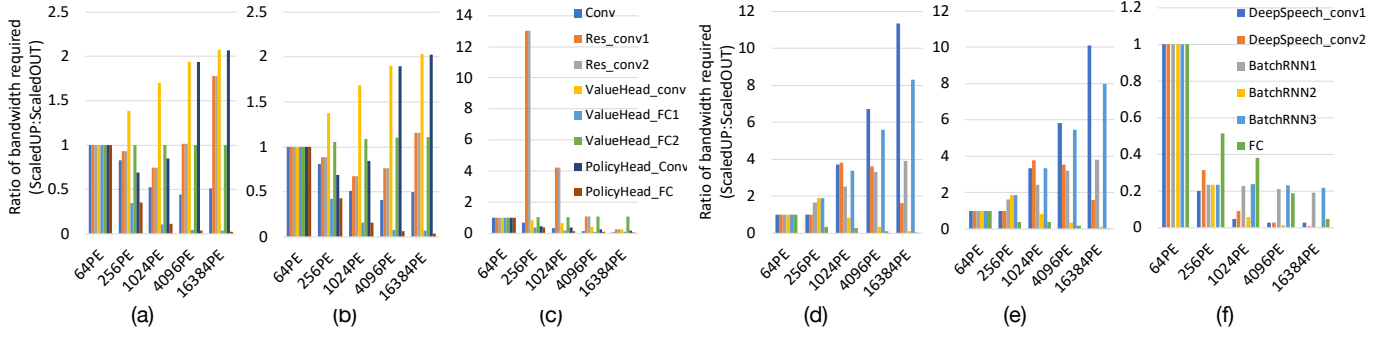

Fig. 10: Chart depicting the ratio of DRAM bandwidth requirement for weight matrices between runs on a scaled-up array vs a scaled-out implementation for the three dataflows for AlphaGoZero(W1)(a-c) and DeepSpeech2(W2)(d-f)

Figure 9 shows the ratio of scaled-up to scaled-out runtime for the three dataflows. For the common case scaled-up implementation turns out to be the best in terms of performance, ie. $\text{runtime}(\text{scale-up}) < \text{runtime}(\text{scale-out})$. However, W1 favors scale-out irrespective of dataflow, indicating that scaling decision to be tied to workloads. This is a very important observation for designing high performance machine targeted for specific workloads.

We also study the system level affect of these two scaling alternatives. Specifically we study the affect on DRAM bandwidth requirements for filter weights. Figure 10 shows the ratio of DRAM requirements for scale-up to scale-out for each layer in AlphaGoZero (W1) and DeepSpeech2 (W2). For OS and WS in W1 (Figure 10(a-b) respectively) we see most of the layers favor scaled-up implementation ($\text{bandwidth}(\text{scaled-up}) < \text{bandwidth}(\text{scaled-out})$). However, as the number of PEs increase the trend shifts towards scaled-out implementation. However, for IS Figure 10(c), the trend is reversed; for smaller PE counts (256PE, 1024PE) certain layers prefer scaled-out, while as PEs increase, scaled-out implementation wins. For DeepSpeech2 (W2) we see similar trends (see Figure 10(d-f)). IS in W2 however, strongly favors scale-up as seen in Figure 10(f).

V. RELATED WORK

Algorithmic Optimizations. CNNs are amenable to a range of optimizations on top of more fundamental architecture decisions. Prior work has explored exploiting optimized datatypes [25], [26], [27], operand sparsity [28], [26], [6], and hardware faults [26]. These optimizations are largely orthogonal to this work.

Simulators. SCALE-SIM is the first public and open source CNN accelerator that we are aware of. However, there are a number of related tools and simulation methodologies that we should be mentioned here. Aladdin [29] is a tool for simulating power, performance and silicon area of arbitrary accelerators. The methodology follows an HLS-inspired approach that starts with a C-code description of the algorithm. This description is parsed into an LLVM graph, which is then scheduled into a hardware pipeline, guided by some simple constraints to describe the degree of parallelism and the memory bandwidth. This approach is ideal for rapid exploration of the hardware cost

of a range of algorithms. However, it is somewhat limited in the sophistication of hardware structures that can be generated. Minerva [26] builds on top of Aladdin and uses a customized neural network training flow to explore hardware-algorithm co-design opportunities. However, Minerva does not provide architectural insights such as resource underutilization or main memory bottleneck as SCALE-SIM does.

Some papers like SCNN [6] and energy-aware pruning [30] have mentioned and introduced some power measurement and simulation infrastructure but either the scope of generalization is highly limited or they are unavailable to the public. Alternately, highly custom designs like MAERI [31] have been released as open-source RTL models, but require a buy-in to a highly configurable design that adds significant area and power overheads over simple systolic arrays. RTL simulation is also much slower than SCALE-SIM’s python-based cycle-accurate model. Tetris [32] provides a tool to partition and schedule NN layers over Eyeriss [5], but unlike like SCALE-SIM it is not a simulator.

Finally, we note that usually in an ML-enabled application, CNN is just one stage of the end-to-end processing pipeline [33], [34]. Therefore, it is important to understand the accelerator in the context of the entire Systems-on-a-chip (SoC). Gem5-Aladdin [15] embeds the Aladdin accelerator simulator inside the Gem5 system simulator environment to allow for system trade-offs to be explored. GemDroid [35] couples Gem5 with the Android Emulator and integrates various hardware IP models to enable SoC-level simulation. However, both pieces of work lack accurate account for DNN-specific accelerators, and therefore are not readily available for studying system-level behavior of ML-enabled applications.

Due to the modular interface design, users could choose to integrate SCALE-SIM with Gem5-Aladdin or GemDroid for full-system simulation. This is particular helpful for researchers who do not wish to perform in-depth investigation of the CNN accelerator microarchitecture, but wish to integrate a decent CNN IP to perform meaningful system-level characterizations.

VI. CONCLUSION

In light of the fact that more and more architects are now designing accelerators for deep neural networks, it is striking that there is a dearth of publicly available knowledge base

or simulation infrastructure to study design insights. In this work we make an attempt to bridge this gap in two ways. First we implement a simulation tool for conducting our study and open source it for the general public. Second we perform detailed experiments to understand the design space and trade-off studies in designing a systolic array based CNN accelerator. We hope that our findings will help speedup development of new accelerator designs and our tool help people conduct their design space explorations faster.

REFERENCES

- [1] J. Redmon, S. Divvala, R. Girshick, and A. Farhadi, "You only look once: Unified, real-time object detection," in *Proceedings of the IEEE conference on computer vision and pattern recognition*, 2016.
- [2] G. Chen, C. Parada, and G. Heigold, "Small-footprint keyword spotting using deep neural networks," in *Acoustics, speech and signal processing (icassp), 2014 IEEE international conference on*. IEEE, 2014.
- [3] L. Tai and M. Liu, "Deep-learning in mobile robotics-from perception to control systems: A survey on why and why not," *arXiv preprint arXiv:1612.07139*, 2016.
- [4] T. Chen, Z. Du, N. Sun, J. Wang, C. Wu, Y. Chen, and O. Temam, "Dianna: A small-footprint high-throughput accelerator for ubiquitous machine-learning," in *Proceedings of the 19th International Conference on Architectural Support for Programming Languages and Operating Systems*, ser. ASPLOS '14. New York, NY, USA: ACM, 2014. [Online]. Available: <http://doi.acm.org.ezp-prod1.hul.harvard.edu/10.1145/2541940.2541967>
- [5] Y.-H. Chen, T. Krishna, J. Emer, and V. Sze, "Eyeriss: An energy-efficient reconfigurable accelerator for deep convolutional neural networks," in *International Solid-State Circuits Conference*, ser. ISSCC, 2016.
- [6] A. Parashar, M. Rhu, A. Mukkara, A. Puglielli, R. Venkatesan, B. Khailany, J. S. Emer, S. W. Keckler, and W. J. Dally, "SCNN: an accelerator for compressed-sparse convolutional neural networks," *CoRR*, vol. abs/1708.04485, 2017. [Online]. Available: <http://arxiv.org/abs/1708.04485>
- [7] Y. Chen, T. Luo, S. Liu, S. Zhang, L. He, J. Wang, L. Li, T. Chen, Z. Xu, N. Sun, and O. Temam, "Dadianna: A machine-learning supercomputer," in *Proceedings of the 47th Annual IEEE/ACM International Symposium on Microarchitecture*, ser. MICRO-47. Washington, DC, USA: IEEE Computer Society, 2014. [Online]. Available: <http://dx.doi.org.ezp-prod1.hul.harvard.edu/10.1109/MICRO.2014.58>
- [8] N. P. Jouppi, C. Young, N. Patil, D. Patterson, G. Agrawal, R. Bajwa, S. Bates, S. Bhatia, N. Boden, A. Borchers, R. Boyle, P. Cantin, C. Chao, C. Clark, J. Coriell, M. Daley, M. Dau, J. Dean, B. Gelb, T. V. Ghaemmaghami, R. Gottipati, W. Gulland, R. Hagmann, R. C. Ho, D. Hogberg, J. Hu, R. Hundt, D. Hurt, J. Ibarz, A. Jaffey, A. Jaworski, A. Kaplan, H. Khaitan, A. Koch, N. Kumar, S. Lacy, J. Laudon, J. Law, D. Le, C. Leary, Z. Liu, K. Lucke, A. Lundin, G. MacKean, A. Maggiore, M. Mahony, K. Miller, R. Nagarajan, R. Narayanaswami, R. Ni, K. Nix, T. Norrie, M. Omernick, N. Penukonda, A. Phelps, J. Ross, A. Salek, E. Samadiani, C. Severn, G. Sizikov, M. Snellman, J. Souter, D. Steinberg, A. Swing, M. Tan, G. Thorson, B. Tian, H. Toma, E. Tuttle, V. Vasudevan, R. Walter, W. Wang, E. Wilcox, and D. H. Yoon, "In-datacenter performance analysis of a tensor processing unit," *CoRR*, vol. abs/1704.04760, 2017. [Online]. Available: <http://arxiv.org/abs/1704.04760>
- [9] "Xilinx ml suite," <https://github.com/Xilinx/ml-suite>, 2018.
- [10] "Mlperf: Mlperf benchmark suite," <https://github.com/mlperf>, 2018.
- [11] D. Liu, T. Chen, S. Liu, J. Zhou, S. Zhou, O. Teman, X. Feng, X. Zhou, and Y. Chen, "Pudianna: A polyvalent machine learning accelerator," *SIGPLAN Not.*, vol. 50, Mar. 2015. [Online]. Available: <http://doi.acm.org.ezp-prod1.hul.harvard.edu/10.1145/2775054.2694358>
- [12] Z. Du, R. Fasthuber, T. Chen, P. Jenne, L. Li, T. Luo, X. Feng, Y. Chen, and O. Temam, "Shidianna: Shifting vision processing closer to the sensor," in *Proceedings of the 42nd Annual International Symposium on Computer Architecture*, ser. ISCA '15. New York, NY, USA: ACM, 2015. [Online]. Available: <http://doi.acm.org.ezp-prod1.hul.harvard.edu/10.1145/2749469.2750389>
- [13] O. Russakovsky, J. Deng, H. Su, J. Krause, S. Satheesh, S. Ma, Z. Huang, A. Karpathy, A. Khosla, M. Bernstein, A. C. Berg, and L. Fei-Fei, "Imagenet large scale visual recognition challenge," *International Journal of Computer Vision*, vol. 115, 2015.
- [14] A. Hannun, C. Case, J. Casper, B. Catanzaro, G. Diamos, E. Elsen, R. Prenger, S. Satheesh, S. Sengupta, A. Coates *et al.*, "Deep speech: Scaling up end-to-end speech recognition," *arXiv preprint arXiv:1412.5567*, 2014.
- [15] Y. S. Shao, S. L. Xi, V. Srinivasan, G.-Y. Wei, and D. Brooks, "Co-designing accelerators and soc interfaces using gem5-aladdin," in *Microarchitecture (MICRO), 2016 49th Annual IEEE/ACM International Symposium on*. IEEE, 2016.
- [16] P. Rosenfeld, E. Cooper-Balis, and B. Jacob, "Dramsim2: A cycle accurate memory system simulator," *IEEE Computer Architecture Letters*, vol. 10, 2011.
- [17] K. He, X. Zhang, S. Ren, and J. Sun, "Deep residual learning for image recognition," in *Proceedings of the IEEE conference on computer vision and pattern recognition*, 2016.
- [18] D. Silver, J. Schrittwieser, K. Simonyan, I. Antonoglou, A. Huang, A. Guez, T. Hubert, L. Baker, M. Lai, A. Bolton *et al.*, "Mastering the game of go without human knowledge," *Nature*, vol. 550, 2017.
- [19] D. Amodei, S. Ananthanarayanan, R. Anubhai, J. Bai, E. Battenberg, C. Case, J. Casper, B. Catanzaro, Q. Cheng, G. Chen *et al.*, "Deep speech 2: End-to-end speech recognition in english and mandarin," in *International Conference on Machine Learning*, 2016.
- [20] S. Ren, K. He, R. Girshick, and J. Sun, "Faster r-cnn: Towards real-time object detection with region proposal networks," in *Advances in neural information processing systems*, 2015.
- [21] X. He, L. Liao, H. Zhang, L. Nie, X. Hu, and T.-S. Chua, "Neural collaborative filtering," in *Proceedings of the 26th International Conference on World Wide Web*. International World Wide Web Conferences Steering Committee, 2017.
- [22] R. Johnson and T. Zhang, "Effective use of word order for text categorization with convolutional neural networks," *arXiv preprint arXiv:1412.1058*, 2014.
- [23] A. Vaswani, N. Shazeer, N. Parmar, J. Uszkoreit, L. Jones, A. N. Gomez, L. Kaiser, and I. Polosukhin, "Attention is all you need," in *Advances in Neural Information Processing Systems*, 2017.
- [24] W. Lu, G. Yan, J. Li, S. Gong, Y. Han, and X. Li, "Flexflow: A flexible dataflow accelerator architecture for convolutional neural networks," in *High Performance Computer Architecture (HPCA), 2017 IEEE International Symposium on*. IEEE, 2017.
- [25] S. Gupta, A. Agrawal, K. Gopalakrishnan, and P. Narayanan, "Deep learning with limited numerical precision," in *Proceedings of The 32nd International Conference on Machine Learning*, 2015.
- [26] B. Reagen, P. Whatmough, R. Adolf, S. Rama, H. Lee, S. K. Lee, J. M. Hernández-Lobato, G.-Y. Wei, and D. Brooks, "Minerva: Enabling low-power, highly-accurate deep neural network accelerators," in *Proceedings of the 43rd International Symposium on Computer Architecture*, ser. ISCA, 2016.
- [27] P. Judd, J. Albericio, T. Hetherington, T. M. Aamodt, and A. Moshovos, "Stripes: Bit-serial deep neural network computing," in *2016 49th Annual IEEE/ACM International Symposium on Microarchitecture (MICRO)*, Oct 2016.
- [28] S. Han, X. Liu, H. Mao, J. Pu, A. Pedram, M. Horowitz, and W. Dally, "EIE: Efficient inference engine on compressed deep neural network," in *Proceedings of the 43rd International Symposium on Computer Architecture*, ser. ISCA, 2016.
- [29] Y. S. Shao, B. Reagen, G.-Y. Wei, and D. Brooks, "Aladdin: A pre-rtl, power-performance accelerator simulator enabling large design space exploration of customized architectures," in *Proceeding of the 41st Annual International Symposium on Computer Architecture*, ser. ISCA '14. Piscataway, NJ, USA: IEEE Press, 2014. [Online]. Available: <http://dl.acm.org/citation.cfm?id=2665671.2665689>
- [30] T.-J. Yang, Y.-H. Chen, and V. Sze, "Designing energy-efficient convolutional neural networks using energy-aware pruning," *arXiv preprint arXiv:1611.05128*, 2016.
- [31] H. Kwon, A. Samajdar, and T. Krishna, "Maeri: Enabling flexible dataflow mapping over dnn accelerators via reconfigurable interconnects," in *Proceedings of the Twenty-Third International Conference on Architectural Support for Programming Languages and Operating Systems*. ACM, 2018.
- [32] M. Gao, J. Pu, X. Yang, M. Horowitz, and C. Kozyrakis, "Tetris: Scalable and efficient neural network acceleration with 3d memory," *ACM SIGOPS Operating Systems Review*, vol. 51, 2017.

- [33] Y. Zhu, A. Samajdar, M. Mattina, and P. Whatmough, "Euphrates: Algorithm-SoC Co-Design for Low-Power Mobile Continuous Vision," in *Proc. of ISCA*, 2018.
- [34] M. Halpern, Y. Zhu, and V. J. Reddi, "Mobile CPU's Rise to Power: Quantifying the Impact of Generational Mobile CPU Design Trends on Performance, Energy, and User Satisfaction," in *Proc. of HPCA*, 2016.
- [35] N. Chidambaram Nachiappan, P. Yedlapalli, N. Soundararajan, M. T. Kandemir, A. Sivasubramaniam, and C. R. Das, "GemDroid: A Framework to Evaluate Mobile Platforms," in *Proc. of SIGMETRICS*, 2014.