

Mode Division Multiplexing (MDM) Weight Bank Design for Use in Photonic Neural Networks

Ethan Gordon '17
egordon@princeton.edu

Advisor: Paul R. Prucnal
prucnal@princeton.edu

Submitted in partial fulfillment
of the requirements for the degree of
Bachelor of Science in Engineering
Department of Electrical Engineering
Princeton University

May 10, 2017

Honor Statement

I hereby declare that this Independent Work report represents my own work in accordance with University regulations.

Ethan Gordon

Ethan K. Gordon '17

Mode Division Multiplexing (MDM) Weight Bank Design for Use in Photonic Neural Networks

Ethan Gordon '17
egordon@princeton.edu

Abstract

Neural networks provide a powerful tool for applications from classification and regression to general purpose alternative computing. Photonics have the potential to provide enormous speed benefits over electronic and software networks, allowing such networks to be used in real-time applications at radio frequencies. Mode division multiplexing (MDM) is one method to increase the total information capacity of a single on-chip waveguide and, by extension, the information density of the photonic neural network (PNN). This Independent Work consists of three experimental designs ready for fabrication, each of which investigates the process of expanding current PNN technology to include MDM. Experiment 1 determines the optimal waveguide geometry to couple optical power into different spacial modes within a single waveguide. Experiment 2 combines MDM and previous wavelength division multiplexing (WDM) technology into a single weight bank for use as the dendrite of a photonic neuron. Finally, Experiment 3 puts two full neurons in a folded bus, or "hairpin," network topology to provide a platform for training calibration schemes that can be applied to larger networks.

Acknowledgements

First and foremost, I would like to acknowledge Alex Tait, the graduate student that guided me through all the stages of this project. I am excited to continue working with Alex next year for my Senior Independent Work. I would also like to extend my thanks to everybody in the Lightwave Communications Laboratory, from graduate students and post-doctoral researchers to Prof. Prucnal, for their continued support and advice. Finally, the fabrication of all experiments would not have been possible without funding from the School of Engineering and Applied Science and the Department of Electrical Engineering. Thank you for making my Independent Work a success.

This work is dedicated to ELE Car Lab 2016 and all the late nights we spent together.

Contents

1	Motivation and Background	5
1.1	The Size-Bandwidth Trade-off	5
1.2	Current Work in MDM	6
2	Experiment 1: Waveguide Geometry	8
2.1	Experimental Design	8
2.2	Simulations and Expected Results	9
3	Experiment 2: Weight Bank	10
3.1	Experimental Design	10
3.2	Intermodal Mixing	10
4	Experiment 3: Multi-Neuron Network	12
4.1	Experimental Design	12
4.2	"Hairpin" Topology and Cascaded Banks	13
5	Future Work and Applications	13
5.1	Application: Digital Demixing	14
5.2	Application: RF Classification	14
6	Code Appendix	16
6.1	Project Definitions	16
6.2	Mach-Zehnder Interferometer	22
6.3	MDM/WDM Weight Bank	24
6.4	Folded Bus Network	28

1 Motivation and Background

Neural networks are a continued staple of machine learning and alternative computing, with applications ranging from classification and regression to general-purpose computation. The general concept is motivated by biological nervous systems. Networks are composed of individual neurons, each of which takes as input a weighted sum of channels from the rest of the network, applies some non-linear function (commonly a threshold or logarithm), and outputs the result on its own channel back into the network. Networks in general can be modeled in software, but can and have been reproduced physically to tackle fast real-time problems. It is in these fast real-time systems that Photonic Neural Networks (PNNs) can have the greatest impact.

1.1 The Size-Bandwidth Trade-off

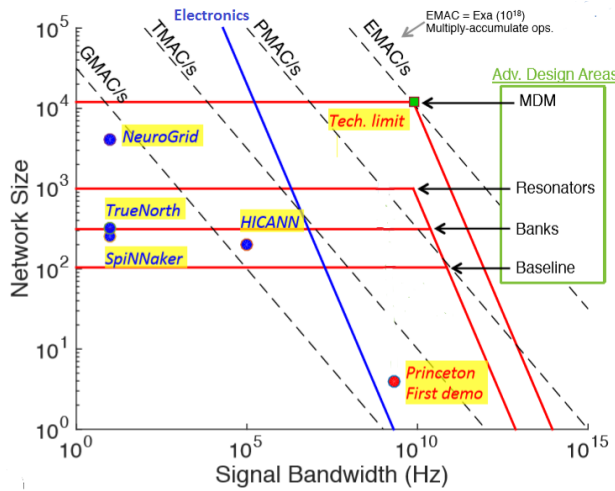

Figure 1: Trade-off between Network Size (in number of channels, determined in photonics by the channel selectivity of the weight banks) and each channel’s Bandwidth, the product of which is the total information capacity of the network. Current electronic networks are shown in blue text, with the electronic bandwidth-size trade-off also in blue. Red lines show trade-offs for existing or proposed technologies in photonic networks. Photonic channel limits from [3].

One fundamental limit on neural networks is the tradeoff between network size and the total signal bandwidth. As more neurons go on the network, it takes longer for information to transverse the network, either due to the speed of the network or some limit on how much information the network can transmit at any given time. Figure 1 demonstrates the current state of this trade-off in electronic and photonic systems. Even one of the faster electronic systems is bandwidth limited to 100kHz, with that limit decreasing as the network grows into multiple wafers due to inter-wafer communication delay [1]. In general, while electronic neural networks can contain tens of thousands of neurons, the slower speeds limit

these networks to trillions of operations per second (TMAC/s) or slower. Photonic networks have the potential to break this barrier, without appreciably increasing network size.

Princeton recently demonstrated its first working physical photonic neural network, as shown in Figure 2, containing four neurons on different wavelengths [2]. The network utilizes a *star topology*, where the outputs of all the neurons enter the network at a single point, splitting off from that point to meet the weight banks. Each weight bank is a collection of Microring Resonators (MRR). Each MRR is tuned to a different wavelength, with an electric heater deforming the ring ever so slightly to adjust the actual percentage of light that couples through the ring, effectively applying a weight to that wavelength channel independent of other channels. This method for weighting each channel of a wavelength division multiplexed (WDM) signal has been the principal passive optical component in all Princeton Neural Network designs [3]. Once weighted, the addition occurs in a pair of balanced photodiodes, allowing for both positive and negative weights. The electric signal immediately goes to a Mach-Zehnder Modulator, whose non-linear properties act as the axon of the neuron itself. Each neuron modulates a different wavelength, and all wavelengths are multiplexed off-chip and fed back into the point of the star network.

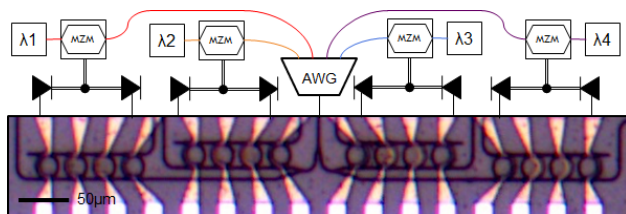

Figure 2: Princeton’s first photonic network demonstration.

While Princeton’s demonstration is the first of its kind, it does suffer from some drawbacks. First of all, it is only four neurons large. The star topology has trouble scaling on-chip, due to the need for every point on the network to have a direct connection to the center of the star. Also, the large amount of off-chip fiber did slow the device into the kilohertz range, though that problem will not exist in a fully integrated system. Finally, in the long term, there are limits to both the channel selectivity of the microring resonators (channels per bandwidth) and the overall bandwidth of the waveguide, the product of which determines the total number of channels available in a network.

This work investigates the use of mode division multiplexing (MDM) to expand the information capacity of photonic neural networks by an order of magnitude.

1.2 Current Work in MDM

Previous work on MDM in silicon has focus solely on the actual multiplexer / demultiplexer. The general strategy is to couple signals on a single-mode waveguide to the highest order mode on a multi-mode waveguide, as shown in Figure 3 and demonstrated in silicon [4]. After each coupling portion for the Nth order mode, the bus waveguide adiabatically tapers

larger to couple the (N+1)th order mode. The adiabatic taper, which occurs gradually, prevents any intermodal mixing between coupling. An exact mirror image of the device provides demultiplexing.

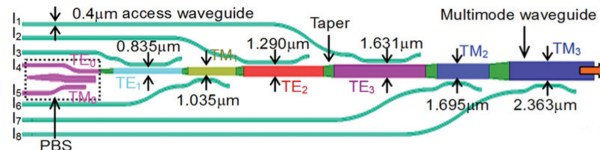

Figure 3: Existing design for an on-chip mode (de)multiplexer [4]. Coupling occurs at asymmetric Y-junctions with varying bus widths.

The principle behind the selectivity of the mode coupling is that the effective index in a waveguide for a given mode is dependent on the width, as shown in example simulation data in Figure 4 and demonstrated in silicon [5]. Optimal coupling occurs between two modes in two different waveguides when the effective indices match, and so if a given width is optimal for coupling to a given mode, it will be far from optimal for other modes. In practice, it is easiest to set the width of a multi-mode waveguide such that its highest order mode will couple to the single-mode MRR, as that mode already determines the minimum width of the waveguide, and then once that mode is coupled out, taper to the width for coupling with the next-highest-order mode.

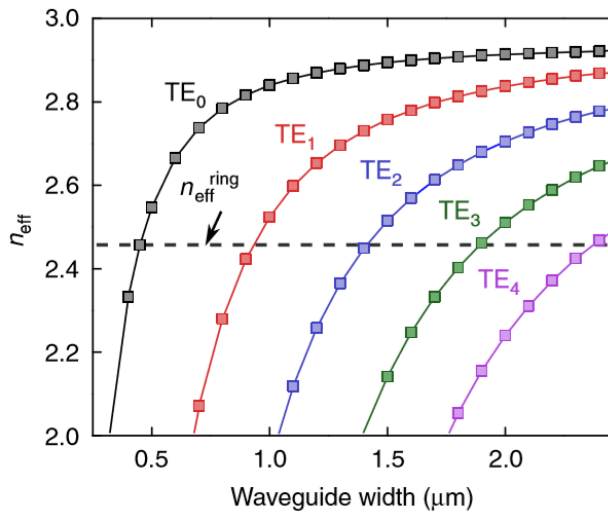

Figure 4: Example of simulated effective index data for waveguides of differing widths [5]. Optimal coupling occurs when the effective index of the multi-mode waveguide matches that of the single-mode MRR (example shown as dotted line).

2 Experiment 1: Waveguide Geometry

The goal of Experiment 1 is to determine the optimal coupling geometry between single- and multi-mode waveguides, since the value of the effective index differs by material and wavelength, and could diverge significantly from simulated data.

2.1 Experimental Design

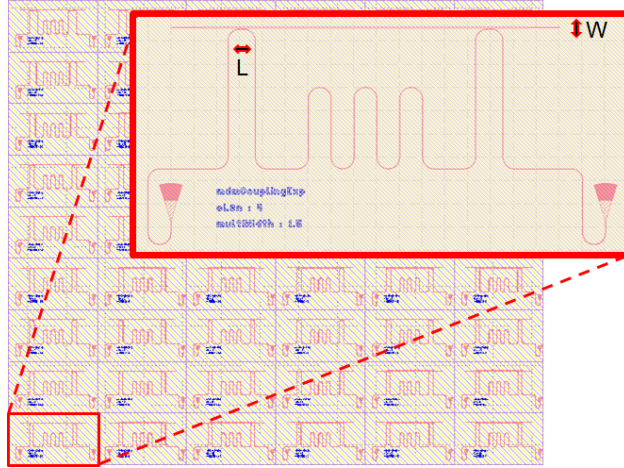

Figure 5: Asymmetric Mach-Zehnder Interferometer. The goal is to determine optimal waveguide width (W) and coupling length (L) for 100% coupling.

The design of this experiment is an asymmetric Mach-Zehnder interferometer. Given an input waveform E_{in} , the transfer function of the device can be written as:

$$\begin{bmatrix} E_{out} \\ E_{taper} \end{bmatrix} = M \begin{bmatrix} E_{in} \\ 0 \end{bmatrix} \quad (1)$$

Where M is a composition of both single-mode to multi-mode couplers and a phase shift $\Delta\phi$ due to the difference in optical length of the two paths through the interferometer.

$$M = M_{coupler} * M_{\Delta\phi} * M_{coupler} \quad (2)$$

$M_{coupler}$ can be determined given a power coupling ratio α , conservation of energy, and a $\frac{\pi}{2}$ phase shift that occurs as power couples from one waveguide to another.

$$M_{coupler} = \begin{bmatrix} \sqrt{1-\alpha} & j\sqrt{\alpha} \\ j\sqrt{\alpha} & \sqrt{1-\alpha} \end{bmatrix} \quad (3)$$

Combined with the phase shift $\Delta\phi = k * \Delta L$, where k is the wavenumber related to the wavelength of the light, we can determine the transfer coefficient between the input waveform and the measured output:

$$M = \begin{bmatrix} \sqrt{1-\alpha} & j\sqrt{\alpha} \\ j\sqrt{\alpha} & \sqrt{1-\alpha} \end{bmatrix} \begin{bmatrix} e^{jk\Delta L} & 0 \\ 0 & 1 \end{bmatrix} \begin{bmatrix} \sqrt{1-\alpha} & j\sqrt{\alpha} \\ j\sqrt{\alpha} & \sqrt{1-\alpha} \end{bmatrix} \quad (4)$$

$$\left| \frac{E_{out}}{E_{in}} \right|^2 = |(1 - \alpha)e^{jk\Delta L} - \alpha|^2 = \alpha^2 + (1 - \alpha)^2 - 2\alpha(1 - \alpha)\cos(k\Delta L) \quad (5)$$

Therefore, a power spectrogram of the device will result in a cosine with a DC-shift. The amplitude of that cosine, called the *Extinction Ratio*, is only dependent on the coupling ratio between the single-mode and multi-mode waveguides.

2.2 Simulations and Expected Results

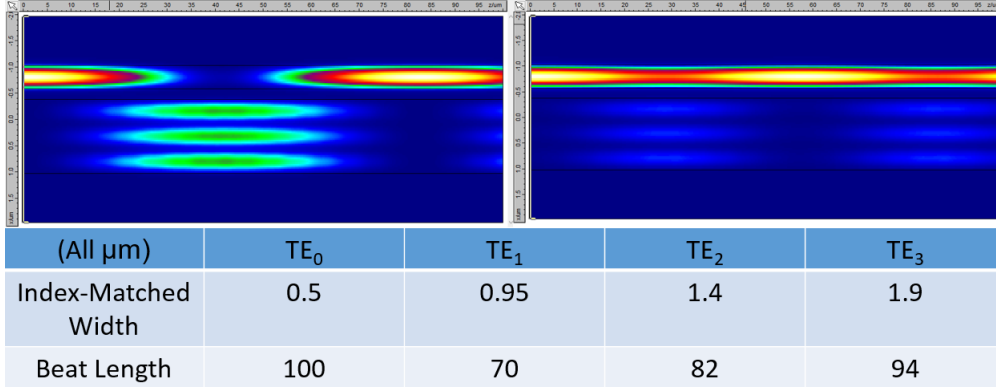

Figure 6: Simulation results for coupling between the fundamental mode (TE_0) and the second order mode (TE_2), for both the index-matched width (left) and a width mismatched by 20nm (right). Note that optical power oscillates back and forth between the waveguides over the course of one *beat length*. Below is a table of simulated index-matched widths and beat lengths for each mode.

We can use simulations of optical coupling between single-mode and multi-mode waveguides to determine the relationship between W , L , and the coupling ratio α . Some of these results are presented in Figure 6. As shown previously, optimal coupling happens when the width of the multi-mode waveguide is such that the indices of refraction in the two waveguides match. Even a slight mismatch can drastically decrease the coupling ratio. Once the indices are matched, optical power oscillates back and forth between the two waveguides. The spacial period of this oscillation is called the *beat length*, and differs by mode. Optimal coupling occurs at half of the beat length, when all power has moved into the multi-mode waveguide.

$$\alpha = f(W) * (1 - \cos(2\pi \frac{L}{(\text{beat length})})) / 2 \quad (6)$$

The first step in the experiment is to maximize the extinction ratio, which corresponds with $\alpha = \frac{1}{2}$. This implies that the width matches effective index and the coupling length is one-quarter or three-quarters of the beat length. The next step is to minimize the extinction ratio *without* changing the width. Since the extinction ratio is minimized with both $\alpha = 1$ and $\alpha = 0$, the simulation data can be used to help distinguish the two cases. It should be clear whether the coupling length is closer to the simulated beat length or the simulated half-beat length.

3 Experiment 2: Weight Bank

3.1 Experimental Design

Using the simulated optimal coupling geometry, we designed a combined MDM / WDM weight bank to perform the weighted addition on the dendrite side of the neuron, as shown in Figure 7. The bank is composed of a series of stages, one per mode. Each stage is similar to the WDM weight bank from Princeton’s network demonstration: a series of MRRs tuned to each wavelength channel in the waveguide. Each MRR transmits a certain percentage of the optical power in its specific wavelength channel from the input bus into the “drop” waveguide. The exact percentage is controlled by electric heaters that can slightly modify the exact perimeter of the MRR. The rest of the light in the channel is coupled completely into the “add” waveguide. Finally, the input waveguide is adiabatically tapered down to the coupling width of the next-highest-order mode for the next stage, until the final stage has only a single-mode waveguide.

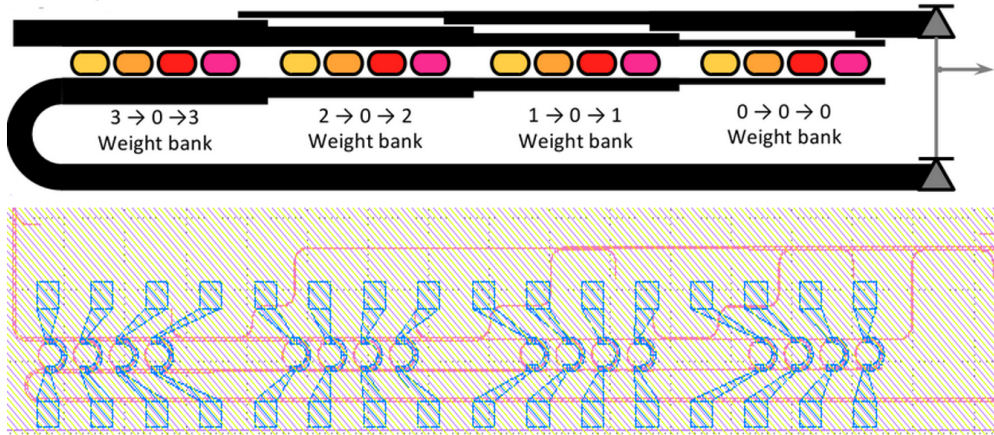

Figure 7: (Top) Schematic for a four-mode four-wavelength MDM/WDM weight bank. (Bottom) Layout of the weight bank on-chip. Electric heaters are shown in blue.

Both the “add” and “drop” waveguides are fed into two balanced photodiodes, which provides summation by converting the optical power into an electric current. The difference in current between the two photodiodes is the current that acts as the input for the neuron itself. The benefit of using the photodiode for summation is that it is mode- and wavelength-agnostic. Based on the mechanics of multi-mode coupling, each mode in the input gets coupled into a different mode of the “add” waveguide. However, since the *total* optical power in that waveguide is still a correct weighted sum of each channel, the correct electrical current is drawn by the photodiode.

3.2 Intermodal Mixing

The summation in the photodiode also solves another issue with the weight bank: intermodal mixing. When there is a bend in a multi-mode waveguide, the mode basis changes throughout

the course of the bend. The result is a shuffling of optical power between modes. Assuming no bending loss, this shuffling can be accurately modeled as a linear transformation with a unitary matrix.

$$\begin{bmatrix} TE'_0 \\ TE'_1 \end{bmatrix} = M \begin{bmatrix} TE_0 \\ TE_1 \end{bmatrix} \quad (7)$$

$$M^\dagger M = 1 \quad (8)$$

Since the transformation is unitary, the total optical power in the waveguide does not change. Therefore, within the wavebank itself, the bend in the "drop" waveguide makes no difference in the summation done by photodiode.

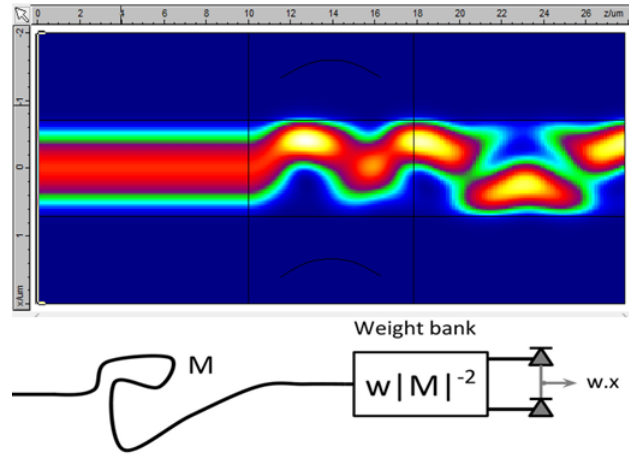

Figure 8: (Top) Simulation of the fundamental mode of a two-mode waveguide going through a bend. The result is a mix of the fundamental and first-order mode. (Bottom) How a weight bank can undo the effects of an intermodal mixing matrix.

Closer inspection of Figure 7 would reveal that intermodal mixing also occurs outside of the weight bank in the form of a bending input waveguide. This could not be done in previous multi-mode experiments, as there is no easy way to undo the mode mixing on chip through waveguide geometry alone. Both [4] and [5] use only straight multi-mode waveguides. Fortunately, a properly calibrated weight bank can be used to undo all intermodal mixing in the network. A weighted summation is mathematically equivalent to an inner product with a weighting vector:

$$y = w \cdot |x|^2 \quad (9)$$

where $|x|^2$ is the vector of optical power in each channel. If x is modified by a mix matrix $|M|^2$, then the same output can be preserved if w is modified by M 's inverse.

$$w|M|^{-2} \cdot |M|^2|x|^2 = w \cdot |x|^2 = y \quad (10)$$

By experimenting with known input vectors x and weights w , the individual components of M can be measured, allowing for the calibration of the weight bank. Calibrating each

weight bank on the network allows for arbitrary bending in any multi-mode waveguide in the network, leading to more flexible network design and the ability to fit more neurons on a smaller surface area.

4 Experiment 3: Multi-Neuron Network

4.1 Experimental Design

The next step is to combine multiple weight banks into a full network, as shown in Figure 9. This design has two neurons on two channels on two different modes and one wavelength. Optical power is pumped into the network to the axons, which are just MRRs tied to electric heaters. Modulation of optical power via the electric heaters follows a Lorentzian function, providing the non-linear element that can act as a continuous (non-spiking) neuron. Each neuron uses the same wavelength of light, but couples onto a different mode in the main bus. The bus wraps around into a series of weight banks. The first bank cuts the power in half, while the subsequent weight banks provide the actual weighting before the light goes off-chip to be summed and fed back into the axons.

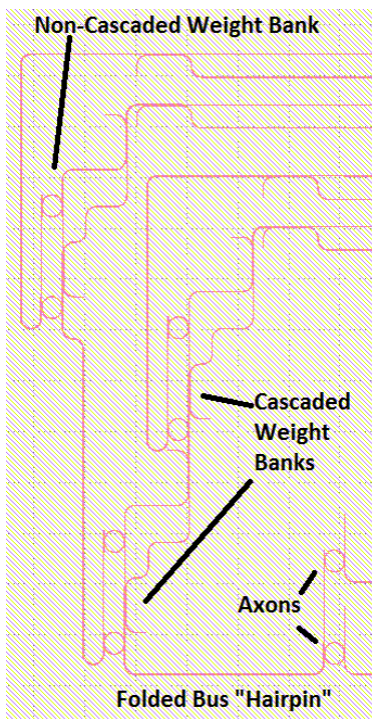

Figure 9: Final CAD of a two-neuron network, including axons, one cascaded weight bank, and one non-cascaded weight bank.

4.2 "Hairpin" Topology and Cascaded Banks

As designed in Experiment 2, a weight bank has a single multi-mode input and two multi-mode outputs. To allow for multiple weight banks to share a single bus, and extra weight bank can be used with the sole purpose of dropping a fixed percentage of power from the shared bus before a second weight bank does the actual weighting. An example of these *cascaded weight banks* is shown in Figure 10. While the extra weight bank does flip the mode channels between the input and the continue waveguides, this can just be factored into the mode mixing matrix at the next cascaded weight bank. In Experiment 3, the first neuron uses a cascaded weight bank, while the second (and last) neuron in the network just uses a single weight bank. The actual layout of the network in Figure 9 is a folded bus, or

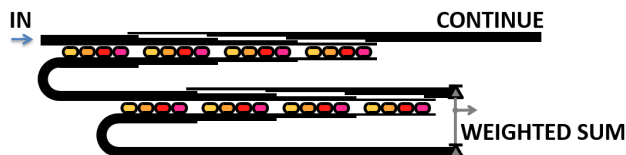

Figure 10: Schematic of a cascaded weight bank. The first bank drops a fixed percentage of power from the bus, while the second performs the actual weighted addition.

"hairpin," topology. One limitation of the Princeton network demonstration is its limited ability to scale. Because every point in the star topology needs a direct connection to the source point, an addition of even one neuron can take up quite a bit of chip surface area. Furthermore, there is no easy way to split a multi-mode signal from one waveguide into multiple multi-mode waveguides. The hairpin topology places all axons on one side of the hairpin, and all dendrites on the other, as shown in Figure 11. Since there can be arbitrary waveguide bending between neurons, the hairpin can snake its way around the chip into an arbitrary configuration, allowing for flexible network and efficient use of chip surface area.

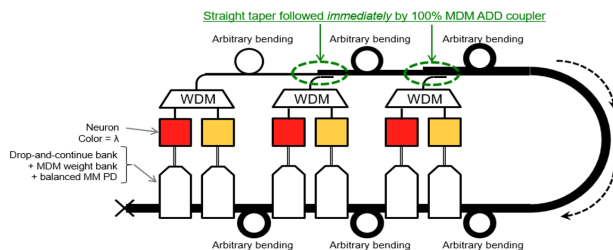

Figure 11: Schematic of a folded bus, or "hairpin," network design. Arbitrary bending between neurons allows for a flexible on-chip network design.

5 Future Work and Applications

The silicon chip with these three experiments will be fabricated during the summer, and the resulting data should be sufficient to design a larger network of neurons for high speed

computations.

5.1 Application: Digital Demixing

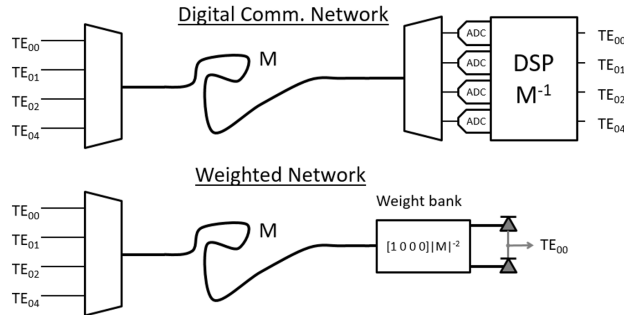

Figure 12: Example of using a weight bank for channel selection. Multiple weight banks can completely demix all channels.

One application of the weight banks themselves is actually in digital applications. Multi-mode waveguides can greatly increase the aggregate bandwidth of digital optical systems on chip. However, intermodal mixing severely limits any bandwidth improvement, since DSP is required to invert the mixing matrix if there is any bending on chip. However, as shown in Figure 12, a single weight bank can be used to invert the mix matrix and select one of the mode channels. For N modes, N weight banks can be used in aggregate to completely invert the mixing matrix in the optical domain, without any DSP.

5.2 Application: RF Classification

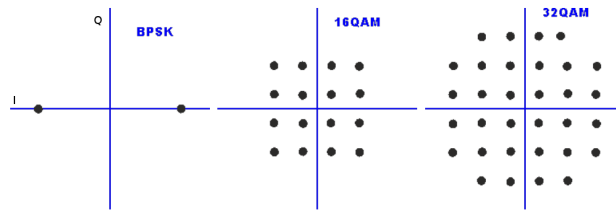

Figure 13: Examples of I-Q digital modulation schemes. With more dots in the diagram, more data can be sent per "bit" interval.

Finally, the full photonic neural network can be deployed for classification problems at Radio Frequencies. One practical example is modulation scheme classification. When broadcasting a signal over radio, one method of modulating digital data is to encode each bit as a combination of the amplitude of a cosine, the in-phase or I component, and the amplitude of a sin, the quadrature or Q component.

$$Y(t) = I(t)\cos(\omega t) + Q(t)\sin(\omega t) \quad (11)$$

Examples of such schemes are shown in Figure 13. A photonic neural network could take as inputs two analog parameters $I(t)$ and $Q(t)$, and output its best guess as to the modulation scheme in real time. Combined with flexible, software-defined radio, such networks could be used to sweep large swaths of the radio spectrum searching for data channels.

Photonic neural networks have the potential to be a driving force in high speed processing and computing. MDM can become a vital component in drastically increasing network size and aggregate bandwidth, allowing for more complex applications in the future.

References

- [1] J. Schemmel, et al., "Wafer-scale integration of analog neural networks," in *IEEE Int. Joint Conf. on Neural Networks*, Hong Kong, 2008, pp. 431-438.
- [2] A. Tait, et al., "Demonstration of a silicon photonic neural network," Submitted, Pending Publication, 2016.
- [3] A. Tait, et al., "Continuous control of microring weight banks," in *IEEE Photonics Conf.*, Reston, VA, 2015, pp. 411-412.
- [4] J. Wang, et al., "On-chip silicon 8-channel hybrid (de)multiplexer enabling simultaneous mode- and polarization-division-multiplexing," *Laser & Photonics Reviews*, rev. 8, no. 2, Wiley-VCH GmbH & Co. KGaA, Weinheim, 2014.
- [5] L. Luo, et al., "WDM-compatible mode-division multiplexing on silicon chip," *Nature Communications*, vol. 5, no. 3069, Macmillian Publishers Limited, 2014.

6 Code Appendix

The on-chip layout of each experiment was procedurally generated using MATLAB.

6.1 Project Definitions

```
1 % MainProject
2 % Author : Ethan
3
4 clear; close all; clc; format long; format compact;
5 % clear classes; % this also clears breakpoints, so no bueno
6
7 % Get to the right directory
8 thisFile = mfilename('fullpath');
9 thisDir = thisFile(1:end-length(mfilename));
10 cd(thisDir);
11
12 % Make sure the right paths are added, and other project paths are
    removed
13 tp = cd; cd('../Functions - AlexUtil');
14 makePaths(tp);
15
16 % Project meta data
17 cad = struct('author', 'Ethan', ...           % project lead author or
    company
18             'fab', 'UBC', ...                % fabrication facility
19             'process', 'Ebeam', ...          % fabrication process
20             'run', '06', ...                 % run name
21             'name', 'MDMCoupling', ...      % project name
22             'layermap', 'UBC_map', ...      % layer map name
23             'uunit', 1e-6, ...               % CAD scale (1e-6 - >
    microns)
24             'dbunit', 1e-9, ...              % CAD database unit (1e
    -9 - > nm)
25             'size', [10000, 10000], ...      % Floorplan dimensions
26             'margin', struct('left', 100, 'right', 100, 'top', 100, '
    bottom', 100), ... % safety margin
27             'v', 'v1');                       % version number
28 save('cadMeta.mat', 'cad');
29
30 %% ----- chip-wide variables -----
31 itPerRow = 4;
32 itStart = 0;
```



```

33 wgBias = 0.0;
34
35 % Default experiment information
36 defaultExp = struct('name', 'defaultName', ...
37     'deviceModel', @device_blank, ...
38     'setBuilder', @buildSet_arrayed, ...
39     'buildInfo', struct('approAli', 'top', 'approSp', 'wg', 'approBend
        ',10), ...
40     'fixedArgs', {0}, ...
41     'pInfo', struct('name', 'null', 'val', 0, 'axis', 'x'), ...
42     'gc', struct('ref', 'TE1550_SubGC_neg31_oxide_hooked', 'flip
        ', -1, 'sp', 127, 'nPer', 2), ... %no longer supports
        parameters, use references
43     'wg', Waveguide(.5+wgBias, [1;0], 10, 10), ...
44     'thermal', Wire(4, [11;0], 10, 20), ...
45     'intercon', Wire(5, [12;0], 10, 20), ...
46     'contactInfo', {0}, ...
47     'rect', [200, 500], ...
48     'offs', [0, 0]);
49 defaultExp.contactInfo = {[]};
50 defaultExp.fixedArgs = {[]};
51
52 contCounter = 0;
53
54 % -----
55 %% Describe cell mdmCouplingExp
56 % -----
57 someRads = [(.5:.5:5), (6:13)]; %[1,2,4,8,15];
58 pInfoModBend(1) = struct('name', 'cLen', ...
59     'val', [0,1,2,3,4,5,10,15,20], ...
60     'axis', 'y');
61 pInfoModBend(2) = struct('name', 'multiWidth', ...
62     'val', someRads(1:1), ...
63     'axis', 'x');
64
65 mdmCouplingExp = ReadOptions(defaultExp, 'name', 'mdmCouplingExp',
        ...
66     'pInfo', pInfoModBend, ...
67     'deviceModel',
68     @device_MultiInterferometer, ...
        'setBuilder

```

```

69                                     ,
70                                     @buildExpSet_mco
71                                     ,
72                                     ...
73                                     ,
74                                     thermal
75                                     ,
76                                     ,[],
77                                     ...
78                                     'rect'
79                                     ,[460,260])
80                                     ;
81
82 % -----
83 %% Describe cell mdmWeightBankExp
84 % -----
85
86 numModes = 4;
87 numWL     = 4;
88
89 mrr = Microring(.2, defaultExp.wg.layer, defaultExp.wg.dtype, 'w', .5,
90               'radius', 10, 'straightLength', 2);
91 fb = FilterBank_v2(defaultExp.wg, defaultExp.thermal, mrr, 'orderN',
92                   numWL, 'dL', 0.1, 'busHold', 8);
93
94 multiDeviceModel = @device_MDMWeightBank;
95
96 dParams = [numModes, numWL];
97
98 mdmWeightBankExp = ReadOptions(defaultExp, 'name', 'mdmWeightBankExp',
99                                , ...
100                               'deviceModel', @device_ModeMUXArr, ...
101                               'contactInfo', {1}, ...
102                               'thermal', ReadOptions(defaultExp.thermal, 'l1pad', 18), ...
103                               'intercon', ReadOptions(defaultExp.intercon, 'l1pad', 18),
104                               ...
105                               'gc', ReadOptions(defaultExp.gc, 'flip', -1, 'nPer', numModes
106                                                  * 3), ...
107                               'fixedArgs', {multiDeviceModel, dParams, fb}, ... % Multi-Mode
108                               Modular Device Model and Parameters
109                               'rect', [400, 1000]);
110

```

```

95  % _____
96  %% Describe cell mdmWeightBankSafeExp
97  % _____
98
99  numModes = 4;
100 numWL     = 4;
101
102 fb2 = fb.copy;
103 fb2.orderN = numWL;
104 fb2.recalculate();
105
106 multiDeviceModel = @device_MDMWeightBankSafe;
107
108 dParams = [numModes, numWL];
109
110 mdmWeightBankSafeExp = ReadOptions(defaultExp, 'name', '
    mdmWeightBankSafeExp', ...
111     'deviceModel', @device_ModeMUXArrSafe, ...
112     'contactInfo', {2}, ...
113     'thermal', ReadOptions(defaultExp.thermal, 'l1pad', 18), ...
114     'intercon', ReadOptions(defaultExp.intercon, 'l1pad', 18),
    ...
115     'gc', ReadOptions(defaultExp.gc, 'flip', -1, 'nPer', numModes
        * 3), ...
116     'fixedArgs', {multiDeviceModel, dParams, fb2}, ... % Multi-Mode
    Modular Device Model and Parameters
    'rect', [400, 1000]);
117
118
119  % _____
120  %% Describe cell busNtwrkExp
121  % _____
122
123 numModesNet = 2;
124 numWLNet     = 1;
125
126 multiDeviceModelNet = @device_MDMWeightBank;
127
128 dParamsNet = [numModesNet, numWLNet];
129
130 busNtwrkExp = ReadOptions(defaultExp, 'name', 'busNtwrkExp', ...
131     'deviceModel', @device_NtwrkArr, ...

```

```

132         'gc',ReadOptions(defaultExp.gc,'flip',-1,'nPer',5*
            numModesNet), ...
133     'fixedArgs',{multiDeviceModelNet,dParamsNet}, ... % Multi-
            Mode Modular Device Model and Parameters
134     'rect',[400,1000]);
135
136 % -----
137 %% Describe cell busNtwrkInvExp
138 % -----
139 numModesNet = 4;
140 numWLNet     = 4;
141
142 multiDeviceModelNet = @device_MDMWeightBank;
143
144 dParamsNet = [numModesNet, numWLNet];
145
146 fb3 = fb2.copy;
147 fb3.orderN = numWLNet;
148 fb3.recalculate();
149
150 busNtwrkInvExp = ReadOptions(busNtwrkExp,'name','busNtwrkInvExp',
    ...
151     'contactInfo',{3}, ...
152     'thermal',ReadOptions(defaultExp.thermal,'l1pad',18), ...
153     'intercon',ReadOptions(defaultExp.intercon,'l1pad',18),
    ...
154     'gc',ReadOptions(defaultExp.gc,'flip',-1,'nPer',5*
            numModesNet), ...
155     'fixedArgs',{multiDeviceModelNet,dParamsNet,fb3,-1},
            ... % Multi-Mode Modular Device Model and Parameters
156     'deviceModel',@device_NtwrkArrInverted, ...
157     'rect',[400,1000]);
158
159 % -----
160 %% Describe cell busNtwrkWDMExp
161 % -----
162 numModesNet = 1;
163 numWLNet     = 4;
164
165 multiDeviceModelNet = @device_MDMWeightBank;
166
167 dParamsNet = [numModesNet, numWLNet];

```

```

168
169 fb4 = fb2.copy;
170 fb4.orderN = numWLNet;
171 fb4.recalculate();
172
173 busNtwrkWDMExp = ReadOptions(busNtwrkInvExp, 'name', 'busNtwrkWDMExp
    ', ...
174     'contactInfo', {4}, ...
175     'gc', ReadOptions(defaultExp.gc, 'flip', -1, 'nPer', 5*
        numModesNet), ...
176     'fixedArgs', {multiDeviceModelNet, dParamsNet, fb4, -1},
        ... % Multi-Mode Modular Device Model and Parameters
177     'rect', [400, 1000]);
178
179
180 %% Put the experiment options in an array (comment them to
    suppress)
181 expArray = mdmCouplingExp;
182 expArray(end+1) = mdmWeightBankExp;
183 expArray(end+1) = mdmWeightBankSafeExp;
184 expArray(end+1) = busNtwrkExp;
185 expArray(end+1) = busNtwrkWDMExp;
186 expArray(end+1) = busNtwrkInvExp;
187
188
189 % Define how they are put together in the topcell
190 % Currently, just a name is needed
191 mirrorNets = ones(1, contCounter);
192 multiInfo = struct('name', 'topcell', ...
193     'putNextTo', {{ 'mdmCouplingExp', 'mdmWeightBankExp' }}, ...
194     'rotate', {{ 'busNtwrkExp' }}, ...
195     'L1netMirror', mirrorNets, ...
196     'centering', false);
197
198 %createMasterHDFfromTypes('mytestfile.h5', expArray);
199 hdfFilename = [cad.name, '.h5'];
200 %hdfFilename = [];
201
202 % call functions to build all GDS files
203 delete('./*.gds'); delete('./Cells/*');
204 buildInfo = BuildCellsFromInfo(expArray, hdfFilename);
205 BuildMultiCell(buildInfo, multiInfo);

```

```

206 addpath( './ Cells ');
207
208 sprintf( 'Merging final files. If it crashes, <a href="matlab:
      opentoline(%s,25)">go here</a>!', which( 'MergeGDS.m'))
209 MergeCells;
210 delete( 'cadMeta.mat');

```

6.2 Mach-Zehnder Interferometer

```

1 %% device_MultiInterferometer
2 % Author : Ethan
3 % param format: [coupling length; multi-mode fiber width]
4 function [topcell, infoOut] = device_MultiInterferometer(topcell,
      infoOut, phW, len, param)
5
6 % Fetch Parameters
7 cLen    = param(1);
8 mmWidth = param(2);
9
10 % Constants (um)
11 taperLen    = 50;
12 arcLen      = 10;
13 vertSep     = 100;
14 interLen    = 120;
15
16 cplSep      = 0.5;
17
18 % Length Check
19 minLen = 2*taperLen + 2*cLen + 8*arcLen + interLen;
20 if len < minLen
21     [topcell, infoOut] = PlaceRect(topcell, infoOut, len, phW.w, phW.
      layer, phW.dtype);
22     return
23 end
24
25 % Calculate Padding
26 padLen = (len - minLen) / 2.0;
27
28 % Approach
29 [topcell, infoOut] = PlaceRect(topcell, infoOut, taperLen, phW.w, phW.
      layer, phW.dtype);
30 [topcell, infoOut] = PlaceArc(topcell, infoOut, 90, arcLen, phW.w,
      phW.layer, phW.dtype);

```

```

31 [topcell,infoOut] = PlaceRect(topcell,infoOut,vertSep,phW.w,phW.
    layer,phW.dtype);
32 [topcell,infoOut] = PlaceArc(topcell,infoOut,-90,arcLen,phW.w
    ,phW.layer,phW.dtype);
33
34 %%% Multi-Mode Fiber %%%
35 infoOutMM = infoOut;
36 if infoOutMM.ori == 0
37     infoOutMM.pos(2) = infoOut.pos(2) + phW.w / 2.0 + cplSep +
        mmWidth / 2.0;
38     infoOutMM.pos(1) = infoOut.pos(1) - arcLen - taperLen;
39 end
40 if infoOutMM.ori == -90
41     infoOutMM.pos(2) = infoOut.pos(2) + arcLen + taperLen;
42     infoOutMM.pos(1) = infoOut.pos(1) + phW.w / 2.0 + cplSep +
        mmWidth / 2.0;
43 end
44
45 [topcell,infoOutMM] = PlaceRect(topcell,infoOutMM,taperLen,0.001,
    phW.layer,phW.dtype,'endwidth',mmWidth);
46 [topcell,infoOutMM] = PlaceRect(topcell,infoOutMM,6*arcLen + 2*
    cLen + 2*padLen + interLen,mmWidth,phW.layer,phW.dtype);
47 [topcell,~] = PlaceRect(topcell,infoOutMM,taperLen,mmWidth
    ,phW.layer,phW.dtype,'endwidth',0.001);
48
49 %%% End Multi-Mode Fiber %%%
50
51 % Coupler
52 [topcell,infoOut] = PlaceRect(topcell,infoOut,cLen,phW.w,phW.layer
    ,phW.dtype);
53
54 % Detatch
55 [topcell,infoOut] = PlaceArc(topcell,infoOut,-90,arcLen,phW.w
    ,phW.layer,phW.dtype);
56 [topcell,infoOut] = PlaceRect(topcell,infoOut,vertSep,phW.w,phW.
    layer,phW.dtype);
57 [topcell,infoOut] = PlaceArc(topcell,infoOut,90,arcLen,phW.w,
    phW.layer,phW.dtype);
58
59 % Padding and Interleaver
60 [topcell,infoOut] = PlaceRect(topcell,infoOut,padLen,phW.w,phW.
    layer,phW.dtype);

```

```

61 for i = 1:3
62     [topcell , infoOut] = PlaceArc(topcell , infoOut , 90, arcLen ,
        phW.w, phW.layer , phW.dtype);
63     [topcell ,infoOut] = PlaceRect(topcell ,infoOut ,vertSep/2,phW.w,
        phW.layer ,phW.dtype);
64     [topcell , infoOut] = PlaceArc(topcell , infoOut , -90, arcLen ,
        phW.w, phW.layer , phW.dtype);
65     [topcell , infoOut] = PlaceArc(topcell , infoOut , -90, arcLen ,
        phW.w, phW.layer , phW.dtype);
66     [topcell ,infoOut] = PlaceRect(topcell ,infoOut ,vertSep/2,phW.w,
        phW.layer ,phW.dtype);
67     [topcell , infoOut] = PlaceArc(topcell , infoOut , 90, arcLen ,
        phW.w, phW.layer , phW.dtype);
68 end
69 [topcell ,infoOut] = PlaceRect(topcell ,infoOut ,padLen ,phW.w,phW.
        layer ,phW.dtype);
70
71 % Second Approach
72 [topcell , infoOut] = PlaceArc(topcell , infoOut , 90, arcLen , phW.w,
        phW.layer , phW.dtype);
73 [topcell ,infoOut] = PlaceRect(topcell ,infoOut ,vertSep ,phW.w,phW.
        layer ,phW.dtype);
74 [topcell , infoOut] = PlaceArc(topcell , infoOut , -90, arcLen , phW.w
        , phW.layer , phW.dtype);
75
76 % Second Coupler
77 [topcell ,infoOut] = PlaceRect(topcell ,infoOut ,cLen ,phW.w,phW.layer
        ,phW.dtype);
78
79 % Second Detatch
80 [topcell , infoOut] = PlaceArc(topcell , infoOut , -90, arcLen , phW.w
        , phW.layer , phW.dtype);
81 [topcell ,infoOut] = PlaceRect(topcell ,infoOut ,vertSep ,phW.w,phW.
        layer ,phW.dtype);
82 [topcell , infoOut] = PlaceArc(topcell , infoOut , 90, arcLen , phW.w,
        phW.layer , phW.dtype);
83 [topcell ,infoOut] = PlaceRect(topcell ,infoOut ,taperLen ,phW.w,phW.
        layer ,phW.dtype);
84
85 end

```

6.3 MDM/WDM Weight Bank

```

1 %% device_MDMWeightBank
2 % Author : Ethan
3 % param format: [coupling length; multi-mode fiber width]
4 function [topcell, infoOut, infoMetalOut] = device_MDMWeightBank(
    topcell, infoIn, phW, MeT, param, varargin)
5 infoMetalOut = {};
6
7 % Fetch Parameters
8 numModes      = param(1);
9
10 mdmFile = matfile(' ../Functions - AlexUtil/MDMparams.mat', '
    Writable', false);
11 mmWids = mdmFile.wuse;
12 taperLen = mdmFile.taper;
13
14 % Get a filter bank, or make one
15 if isempty(varargin)
16     numWL      = param(2);
17     mrr = Microring(.2, phW.layer, phW.dtype, 'w', mmWids(1), '
        radius', phW.r, 'straightLength', 2);
18     fbObj = FilterBank_v2(Waveguide(.5, [1;0], 10, 10), Wire
        (4, [11;0], 10, 20), mrr, 'orderN', numWL, 'dL', .1, 'busHold'
        , 8);
19 else
20     fbObj = varargin{1};
21 end
22
23 % Is it hooked on the drop port
24 if length(varargin) < 2
25     ishooked = 2;
26 else
27     ishooked = varargin{2};
28 end
29
30 if length(varargin) < 3
31     side = 1;
32 else
33     side = varargin{3};
34 end
35
36
37 % Draw Approach

```

```

38 [topcell,infoIn] = PlaceRect(topcell, infoIn, phW.r, mmWids(
    numModes), phW.layer, phW.dtype);
39
40 % Draw Filter Bank
41 n = numModes;
42 infoThru = infoIn;
43 infoOut = 0;
44 mmWids(end+1) = mmWids(end);
45 %radius = 10;
46
47 prevInfoCross = [];
48
49 while n > 0
50
51     % WDM Filter
52     fbObj.busWGwidth = [mmWids(n); mmWids(n)];
53     fbObj.meT = MeT;
54     fbObj.recalculate();
55     [topcell, infoThru, infoCross, infoContra, infoMet] = fbObj.
        place(topcell, infoThru, 'side', side);
56     if n == numModes
57         infoWrap = infoContra;
58     end
59
60     % Draw Drop Demux, or if it's the last one draw a terminator
61     if n > 1
62         demux = ModeMUX(phW, [n, n-1, side]);
63         [topcell, infoThru, ~] = demux.place(topcell, infoThru,
            side);
64     else
65         % Kill taper
66         [topcell, ~] = PlaceRect(topcell, infoCross,
            taperLen, mmWids(1), phW.layer, phW.dtype, '
            endwidth', 0.01);
67     end
68
69     % Draw Add Mux
70     if n == numModes && numModes > 1
71         magic1 = 30;
72         infoMuxOut = SplitInfo(infoThru, 1);
73         [topcell, infoMuxOut] = PlaceArc(topcell, infoMuxOut, -90*
            side, phW.r, phW.w, phW.layer, phW.dtype);

```

```

74     [topcell,infoMuxOut] = PlaceRect(topcell, infoMuxOut,
    magic1, phW.w, phW.layer, phW.dtype);
75     [topcell,infoOut] = PlaceArc(topcell, infoMuxOut, 90*side,
    phW.r, phW.w, phW.layer, phW.dtype);
76     elseif numModes > 1
77     if n > 1
78         infoMuxOut = SplitInfo(infoThru, 1);
79     else
80         infoMuxOut = infoThru;
81     end
82     [topcell,infoOut] = PlaceRect(topcell, infoOut, abs(
    infoOut.pos(2) - infoMuxOut.pos(2)), mmWids(numModes-n)
    , phW.layer, phW.dtype);
83     mux = ModeMUX(phW, [numModes - n, numModes - n + 1, -side
    ]);
84     combInfo = MergeInfo(infoOut, infoMuxOut);
85         if side == -1, combInfo.pos = flipud(combInfo.pos)
    ; end
86     [topcell, infoOut] = mux.place(topcell, combInfo);
87     else
88         infoMuxOut = infoThru;
89         [topcell,infoOut] = PlaceRect(topcell, infoMuxOut,
    taperLen + phW.sp, mmWids(1), phW.layer, phW.
    dtype);
90     end
91
92     if n < numModes
93         % Connect infoContra and PrevInfoCross
94         [topcell, ~] = PlaceSBend(topcell, prevInfoCross, abs(
    prevInfoCross.pos(2) - infoContra.pos(2)), infoContra.
    pos(1) - prevInfoCross.pos(1), phW.r, mmWids(n), phW.
    layer, phW.dtype);
95     end
96
97     % Draw Taper, new previnfocross
98     if n > 1
99         infoThru = SplitInfo(infoThru, 2);
100        [topcell, prevInfoCross] = PlaceRect(topcell, infoCross,
    taperLen, mmWids(n), phW.layer, phW.dtype, 'endwidth',
    mmWids(n-1));
101    end
102

```

```

103     % Accumulate metals
104     if isempty(infoMetalOut)
105         infoMetalOut = infoMet;
106     elseif ~isempty(infoMetalOut{1}) && ~isempty(infoMet{1})
107         infoMetalOut = {MergeInfo(infoMetalOut{1},infoMet
108             {1}), MergeInfo(infoMetalOut{2},infoMet{2})};
109     end
110     n = n - 1;
111 end
112
113 % Draw Drop Wrap-Around
114 if ishooked > 0
115     [topcell,infoWrap] = PlaceArc(topcell, infoWrap, -180*side
116         , phW.r, mmWids(numModes), phW.layer, phW.dtype);
117 end
118 if ishooked > 1
119     [topcell,infoWrap] = PlaceRect(topcell, infoWrap, abs(
120         infoWrap.pos(2) - infoOut.pos(2)), mmWids(numModes),
121         phW.layer, phW.dtype);
122 end
123
124 infoOut = MergeInfo(infoOut, infoWrap);
125
126 end

```

6.4 Folded Bus Network

```

1 %% device_NtwrkArr
2 % Author : Ethan
3
4 % Dummy device for modular type experiments (which require a
5     certain len)
6 % See device_blank for arrayed type experiments
7 function [topcell, infoAll, infoMetalOut, refs] = device_NtwrkArr(
8     topcell, infoAll, phW, MeT, params, varargin)
9 infoMetalOut = [];
10 refs = [];
11 deviceModel = varargin{1};
12 dParams      = varargin{2};
13 numModes    = dParams(1);
14 ioNum       = size(infoAll.pos,1);

```

```

13
14 % Import Params
15 mdmFile = matfile(' ../ Functions - AlexUtil/MDMparams.mat ', '
    Writable', false);
16 mmWids = mdmFile.wuse;
17 taperLen = mdmFile.taper;
18
19 % Get a microring, or make one
20 if isempty(varargin)
21     %numWL = param(2);
22     mrrObj = Microring(.2, phW.layer, phW.dtype, 'w', mmWids(1), '
        radius', phW.r, 'straightLength', 2);
23 else
24     mrrObj = varargin{1};
25 end
26
27 % Construct Demux
28 demux = ModeMUX(phW, [numModes, 1, 1]);
29
30 % Draw Modulator
31 mrr = Microring(.2, 1, 0, 'w', mmWids(1), 'radius', 10, 'straightLength'
    , 2);
32 fb = FilterBank_v2(Waveguide(.5, [1; 0], 10, 10), Wire(4, [11; 0], 10, 20),
    mrr, 'orderN', 1, 'dL', .1, 'busHold', 8);
33 fb.busWGwidth = [mmWids(1); mmWids(1)];
34 fb.meT = MeT;
35 fb.recalculate();
36
37 n = numModes;
38 prevInfoCross = [];
39 while n > 0
40     fbObj = fb.copy();
41
42     infoPwr = SplitInfo(infoAll, ioNum-numModes+n);
43
44     % Approach
45     [topcell, infoPwr] = PlaceRect(topcell, infoPwr, taperLen,
        mmWids(1), phW.layer, phW.dtype);
46     [topcell, infoPwr] = PlaceArc(topcell, infoPwr, -90, phW.r,
        mmWids(1), phW.layer, phW.dtype);
47
48     % Modulator

```

```

49     fbObj.busWGwidth = [mmWids(1); mmWids(n)];
50     fbObj.recalculate();
51
52     [topcell, infoThru, infoCross, infoContra, ~] = fbObj.place(
53         topcell, infoPwr, 'side', 1);
54
55     % Kill Taper
56     [topcell, ~] = PlaceRect(topcell, infoThru, taperLen, mmWids
57         (1), phW.layer, phW.dtype, 'endwidth', 0.01);
58
59     if n > 1
60         % Adiabatic Taper
61         [topcell, prevInfoCross] = PlaceRect(topcell, infoCross,
62             taperLen, mmWids(n), phW.layer, phW.dtype, 'endwidth',
63             mmWids(n-1));
64     end
65
66     if n < numModes
67         % S bend to meet taper
68         [topcell, ~] = PlaceSBend(topcell, infoContra, abs(
69             prevInfoCross.pos(2) - infoContra.pos(2)), infoContra.
70             pos(1) - prevInfoCross.pos(1), phW.r, mmWids(n), phW.
71             layer, phW.dtype);
72     else
73         % Contra is Output!
74         infoOut = infoContra;
75     end
76
77     n = n - 1;
78 end
79
80 % Draw Hairpin to Dendrites
81 [topcell, infoOut] = PlaceArc(topcell, infoOut, -90, phW.r, mmWids
82     (numModes), phW.layer, phW.dtype);
83 [topcell, infoOut] = PlaceRect(topcell, infoOut, taperLen * 5,
84     mmWids(numModes), phW.layer, phW.dtype);
85 [topcell, infoOut] = PlaceArc(topcell, infoOut, -90, phW.r, mmWids
86     (numModes), phW.layer, phW.dtype);
87
88 % Draw Drop / Continue
89 [topcell, infoOut] = deviceModel(topcell, infoOut, phW, MeT,
90     dParams);

```

```

80
81 infoWB = SplitInfo(infoOut, 1);
82
83 infoCont = SplitInfo(infoOut, 2);
84
85 % Draw Weight Bank 1
86 [topcell, infoOut] = deviceModel(topcell, infoWB, phW, MeT,
    dParams);
87 infoMid = SplitInfo(infoOut, 1);
88 infoBot = SplitInfo(infoOut, 2);
89
90 % Place Unapproach
91 [topcell, infoMid] = PlaceArc(topcell, infoMid, -90, phW.r, mmWids
    (numModes), phW.layer, phW.dtype);
92
93 [topcell, infoBot] = PlaceRect(topcell, infoBot, 50, mmWids(
    numModes), phW.layer, phW.dtype);
94 [topcell, infoBot] = PlaceArc(topcell, infoBot, -90, phW.r, mmWids
    (numModes), phW.layer, phW.dtype);
95 [topcell, infoBot] = PlaceRect(topcell, infoBot, infoBot.pos(1) -
    infoMid.pos(1), mmWids(numModes), phW.layer, phW.dtype);
96
97
98 % Place Demux
99 [topcell, infoMid] = demux.place(topcell, infoMid);
100 [topcell, infoBot] = demux.place(topcell, infoBot);
101
102 infoComb = MergeInfo(infoMid, infoBot);
103
104 % Align Outputs
105
106 infoNewComb = 0;
107 for n = 1:2*numModes
108     infoTest = SplitInfo(infoComb, n);
109     [topcell, infoTest] = PlaceRect(topcell, infoTest, infoTest.
        pos(1) - infoAll.pos(1, 1), phW.w, phW.layer, phW.dtype);
110     if isstruct(infoNewComb)
111         infoNewComb = MergeInfo(infoNewComb, infoTest);
112     else
113         infoNewComb = infoTest;
114     end
115 end

```

```

116
117 % Draw Weight Bank 2
118 [topcell, infoCont] = PlaceRect(topcell, infoCont, 100, mmWids(
    numModes), phW.layer, phW.dtype);
119 [topcell, infoCont] = PlaceArc(topcell, infoCont, 90, phW.r,
    mmWids(numModes), phW.layer, phW.dtype);
120 [topcell, infoCont] = PlaceArc(topcell, infoCont, -90, phW.r,
    mmWids(numModes), phW.layer, phW.dtype);
121 [topcell, infoOut] = deviceModel(topcell, infoCont, phW, MeT,
    dParams);
122 infoMid = SplitInfo(infoOut, 1);
123 infoBot = SplitInfo(infoOut, 2);
124
125 % Place Unapproach
126 [topcell, infoMid] = PlaceArc(topcell, infoMid, -90, phW.r, mmWids
    (numModes), phW.layer, phW.dtype);
127
128 [topcell, infoBot] = PlaceRect(topcell, infoBot, 50, mmWids(
    numModes), phW.layer, phW.dtype);
129 [topcell, infoBot] = PlaceArc(topcell, infoBot, -90, phW.r, mmWids
    (numModes), phW.layer, phW.dtype);
130 [topcell, infoBot] = PlaceRect(topcell, infoBot, infoBot.pos(1) -
    infoMid.pos(1), mmWids(numModes), phW.layer, phW.dtype);
131
132
133 % Place Demux
134 [topcell, infoMid] = demux.place(topcell, infoMid);
135 [topcell, infoBot] = demux.place(topcell, infoBot);
136
137 infoComb = MergeInfo(infoMid, infoBot);
138
139 % Align Outputs
140
141 infoNewComb2 = 0;
142 for n = 1:2*numModes
143     infoTest = SplitInfo(infoComb, n);
144     [topcell, infoTest] = PlaceRect(topcell, infoTest, infoTest.
        pos(1) - infoAll.pos(1, 1), phW.w, phW.layer, phW.dtype);
145     if isstruct(infoNewComb2)
146         infoNewComb2 = MergeInfo(infoNewComb2, infoTest);
147     else
148         infoNewComb2 = infoTest;

```



```
149     end
150 end
151
152 % Finalize
153 infoNewComb2 = MergeInfo(infoNewComb, infoNewComb2);
154 infoTop = SplitInfo(infoAll, (ioNum - numModes + 1):ioNum );
155 infoAll = MergeInfo(infoTop, infoNewComb2);
156 end
```