

UPSILON INVARIANTS FROM CYCLIC BRANCHED COVERS

ANTONIO ALFIERI, DANIELE CELORIA, AND ANDRÁS STIPSICZ

ABSTRACT. We extend the construction of Υ -type invariants to null-homologous knots in rational homology three-spheres. By considering m -fold cyclic branched covers with m a prime power, this extension provides new knot concordance invariants $\Upsilon_m^C(K)$ of knots in S^3 . We give computations of some of these invariants for alternating knots and reprove independence results in the smooth concordance group.

1. INTRODUCTION

Knot Floer homology turned out to be an extremely powerful tool in studying properties of knots. For $K \subset S^3$ the theory provides invariants which determine the Seifert genus of the knot [28], whether it is fibered or not [8, 24] (both achieved by the \widehat{HFK} -theory), and further versions of the construction give lower bounds on the slice genus (the τ invariant stemming from the HFK^- -theory). The most general version (the graded, $\mathbb{Z} \oplus \mathbb{Z}$ -filtered $\mathbb{Z}_2[U, U^{-1}]$ -module \mathcal{CFK}^∞) gave rise to additional invariants, like Hom's ϵ -invariant [15], or the Υ -function of [26], or its further variants Υ^C from [1]. More recently, based on work of Hendricks and Manolescu [13] involutive invariants emerged as useful tools in the theory. Most of these constructions worked for knots in S^3 and provided strong results on the structure of the smooth concordance group \mathcal{C} .

In [26] Ozsváth, Szabó and the third author pointed out the possibility of capturing more information about concordance of knots in S^3 by running the routine of the epsilon invariant for their preimages in branched covers. In this paper we pursue that idea and perform some computations of the resulting invariants. Notice that this option was already explored by Grigsby, Ruberman, and Strle [11] for the Ozsváth-Szabó τ invariant.

In the first part of the paper we extend the theory of epsilon type invariants to null-homologous knots in rational homology spheres (compare with [17]) and we apply it to branched covers to obtain invariants of knots in S^3 . For a knot $K \subset S^3$, let $\Sigma^m(K)$ denote the m -fold cyclic branched cover along K for some prime power m . A knot $K \subset S^3$, a cohomology class $\xi \in H^2(\Sigma^m(K); \mathbb{Z})$, and a south-west region C of the plane provides a knot invariant $\Upsilon_\xi^C(K)$ with the following key property.

Theorem 1.1. *If K is a slice knot then there exists a subgroup $G < H^2(\Sigma^m(K); \mathbb{Z})$ of cardinality $\sqrt{|H^2(\Sigma^m(K); \mathbb{Z})|}$ such that $\Upsilon_\xi^C(K) = 0$ for all $\xi \in G$.*

The second part of the paper is devoted to computations. We extend Grigsby's result [9, Thm. 4.3] to encompass all spin^c structures, in the subcase of alternating torus knots. (Using some general principles, similar results can be deduced – here we apply direct computational methods.)

Theorem 1.2. *Let $p = 2n + 1$ be a given positive odd integer. For $h \in \{0, \dots, n\}$ there exist bi-graded quasi-isomorphisms*

$$CFK^\circ(L(p, 1), \tilde{T}_{2,p}, \mathfrak{s}_0 \pm h) \simeq CFK^\circ(T_{2,p-2h}),$$

where $\circ = \wedge, \pm, \infty$.

This result determines $HFK^\circ(L(p, 1), \tilde{T}_{2,p})$ as a graded group, and implies that the lift of an alternating torus knot is *thin* in each spin^c structure (cf. Section 6 of [18]).

Using [31, Lemmas 5 and 7], this result implies that the corresponding graded, $\mathbb{Z} \oplus \mathbb{Z}$ -filtered chain complexes $\mathcal{CFK}^\infty(L(p, 1), \tilde{T}_{2,p}, \mathfrak{s}_0 \pm h)$ and $\mathcal{CFK}^\infty(T_{2,p-2h})$ are graded, $\mathbb{Z} \oplus \mathbb{Z}$ -filtered chain homotopy equivalent. Thus, as a consequence of the previous computation, we can easily obtain the following results. (More general results, encompassing all alternating knots, will be presented in [6].)

Corollary 1.3. *For an alternating torus knot $K = T_{2,2n+1}$ we have that for $t \in [0, 2]$*

$$\Upsilon_{K, \mathfrak{s}_0+h}(t) = (|h| - n) \cdot (1 - |t - 1|) \quad -n \leq h \leq n .$$

Theorem 1.2 can also be applied to compute the τ -invariants studied in [32].

Corollary 1.4. *For $h = 0, \dots, n$ one has*

$$\tau_{\mathfrak{s}_0+h}(\tilde{T}_{2,2n+1}) = \tau(T_{2,2n+1-2h}) = -\frac{1}{2} \cdot \sigma(T_{2,2n+1-2h}) = n - h,$$

We then work out partial calculations in the case of twist knots. Further computations are going to appear in [2], using lattice cohomology techniques.

Acknowledgements: DC acknowledges support from the European Research Council (ERC) under the European Unions Horizon 2020 research and innovation programme (grant agreement No 674978). AA and SA acknowledge support from the NKFIH Grant *Élvonal (Frontier)* KKP 126683 and from K112735. The authors want to thank the anonymous referees for helpful comments and suggestions.

2. AN INVARIANCE PRINCIPLE

An **Alexander filtered, Maslov graded chain complex** is a finitely-generated, \mathbb{Q} -graded, $\mathbb{Z} \oplus \mathbb{Z}$ -filtered chain complex $\mathcal{K}_* = (\bigoplus_{\mathbf{x} \in B} \mathbb{Z}_2[U, U^{-1}], \partial)$ over the ring $\mathbb{Z}_2[U, U^{-1}]$ satisfying the following properties

- ∂ is $\mathbb{Z}_2[U, U^{-1}]$ -linear, and given a basis element $\mathbf{x} \in B$, $\partial \mathbf{x} = \sum_{\mathbf{y}} n_{\mathbf{x}, \mathbf{y}} U^{m_{\mathbf{x}, \mathbf{y}}} \cdot \mathbf{y}$ for suitable coefficients $n_{\mathbf{x}, \mathbf{y}} \in \mathbb{Z}_2$, and non-negative exponents $m_{\mathbf{x}, \mathbf{y}} \geq 0$,
- the multiplication by U drops the homological (Maslov) grading M by two, and the filtration levels (denoted by A and j) by one.

An Alexander filtered, Maslov graded chain complex is said to be of **knot type** if in addition $H_*(\mathcal{K}_*, \partial) = \mathbb{Z}_2[U, U^{-1}]$ graded so that $\text{gr}(1) = d(\mathcal{K}_*)$, for some $d(\mathcal{K}_*) \in \mathbb{Q}$. The number $d(\mathcal{K}_*)$ is the **correction term** of \mathcal{K}_* . An Alexander filtered, Maslov graded chain complex \mathcal{K}_* can be pictorially described as follows:

- represent each \mathbb{Z}_2 -generator $U^m \cdot \mathbf{x}$ of \mathcal{K}_* as a point on the planar lattice $\mathbb{Z} \times \mathbb{Z} \subset \mathbb{R}^2$ in position $(-m, A(\mathbf{x}) - m) \in \mathbb{Z} \times \mathbb{Z}$,
- label each \mathbb{Z}_2 -generator $U^m \cdot \mathbf{x}$ of \mathcal{K}_* with its Maslov grading $M(\mathbf{x}) - 2m \in \mathbb{Z}$,
- connect two \mathbb{Z}_2 -generators $U^n \cdot \mathbf{x}$ and $U^m \cdot \mathbf{y}$ with a directed arrow if in the differential of $U^n \cdot \mathbf{x}$ the coefficient of $U^m \cdot \mathbf{y}$ is non-zero.

Two knot type complexes \mathcal{K}_1 and \mathcal{K}_2 are said to be **stably equivalent**, denoted by $\mathcal{K}_1 \sim \mathcal{K}_2$, if there exist two graded, $\mathbb{Z} \oplus \mathbb{Z}$ -filtered acyclic chain complexes \mathcal{A}_1 and \mathcal{A}_2 such that $\mathcal{K}_1 \oplus \mathcal{A}_1 \simeq \mathcal{K}_2 \oplus \mathcal{A}_2$, where \simeq denotes (graded, $\mathbb{Z} \oplus \mathbb{Z}$ -filtered) chain homotopy equivalence. Denote by \mathcal{CFK} the set of knot type complexes up to chain homotopy equivalence. The quotient set \mathcal{CFK}/\sim has a natural group structure, with operation

given by tensor product, and identity represented by the chain complex $\mathbb{Z}_2[U, U^{-1}]$, equipped with $\partial = 0$ and the trivial filtration; the inverse of the class of a complex \mathcal{K}_* is represented by its dual complex $\text{Hom}(\mathcal{K}_*, \mathbb{Z}_2[U, U^{-1}])$. Let \mathcal{GCFK} denote this Abelian group.

Let K be a null-homologous oriented knot in a rational homology sphere ($\mathbb{Q}HS^3$) Y . Knot Floer homology [29] associates to the pair (Y, K) a finitely generated, \mathbb{Q} -graded, $\mathbb{Z} \oplus \mathbb{Z}$ -filtered chain complex

$$\mathcal{CFK}^\infty(Y, K) = \left(\bigoplus_{\mathbf{x} \in B} \mathbb{Z}_2[U, U^{-1}] \cdot \mathbf{x}, \partial \right)$$

which is an Alexander filtered, Maslov graded chain complex in the above sense.

For each basis element $\mathbf{x} \in B$, there is an associated spin^c structure $\mathfrak{s}(\mathbf{x}) \in \text{Spin}^c(Y)$, and for each spin^c structure \mathfrak{s} of Y

$$\mathcal{CFK}^\infty(Y, K, \mathfrak{s}) = \bigoplus_{\mathfrak{s}(\mathbf{x})=\mathfrak{s}} \mathbb{Z}_2[U, U^{-1}] \cdot \mathbf{x}$$

is a subcomplex of the knot Floer complex $\mathcal{CFK}^\infty(Y, K)$, and

$$\mathcal{CFK}^\infty(Y, K) = \bigoplus_{\mathfrak{s} \in \text{Spin}^c(Y)} \mathcal{CFK}^\infty(Y, K, \mathfrak{s}).$$

The chain complex $\mathcal{CFK}^\infty(Y, K, \mathfrak{s})$ satisfies

$$H_*(\mathcal{CFK}^\infty(Y, K, \mathfrak{s})) = HF^\infty(Y, \mathfrak{s}) = \mathbb{Z}_2[U, U^{-1}]$$

graded so that $\text{gr}(1) = d$, where $d = d(Y, \mathfrak{s})$ denotes the correction term of (Y, \mathfrak{s}) as defined in [30]. In conclusion, $\mathcal{CFK}^\infty(Y, K, \mathfrak{s})$ is a chain complex of knot type.

In [29] Ozsváth and Szabó proved that the \mathbb{Q} -graded, $\mathbb{Z} \oplus \mathbb{Z}$ -filtered chain homotopy type of $\mathcal{CFK}^\infty(Y, K, \mathfrak{s})$ only depends on the diffeomorphism type of the pair (Y, K) , and on the chosen spin^c structure \mathfrak{s} . By forgetting the A -filtration, and taking the homology of the $\mathbb{Z}_2[U]$ -submodule $j \leq 0$ we get the invariant $HF^-(Y, \mathfrak{s})$ of the ambient 3-manifold Y . If (Y, \mathfrak{s}) is a spin^c $\mathbb{Q}HS^3$, then $HF^-(Y, \mathfrak{s}) = \mathbb{Z}_2[U]_{(d)} \oplus HF_{red}(Y, \mathfrak{s})$, where $\mathbb{Z}_2[U]_{(d)}$ is graded so that 1 is in degree $d = d(Y, \mathfrak{s})$; this is commonly referred to as a *tower*. The second summand $HF_{red}(Y, \mathfrak{s})$ is the *reduced* Heegaard Floer homology of (Y, \mathfrak{s}) , and it is a finitely generated \mathbb{Z}_2 -module.

A coarser equivalence relation among the pairs (Y, K) , generalizing usual knot concordance, is defined as follows (see also [7] for a general reference on rational concordance).

Definition 2.1. For $i = 0, 1$ let Y_i be a rational homology sphere, $K_i \subset Y_i$ a null-homologous knot, and $\mathfrak{s}_i \in \text{Spin}^c(Y_i)$. We will say that K_0 and K_1 are ***spin^c rationally concordant***, if there exists a smooth spin^c rational homology cobordism (W, \mathfrak{t}) from (Y_0, \mathfrak{s}_0) to (Y_1, \mathfrak{s}_1) , and a smoothly properly embedded cylinder $C \subset W$ such that $\partial C = C \cap \partial W = K_1 \sqcup -K_0$.

A null-homologous knot K in a spin^c rational homology sphere (Y, \mathfrak{s}) is ***rationally slice*** if there exists a spin^c rational homology ball (W, \mathfrak{t}) bounding (Y, \mathfrak{s}) containing a smoothly properly embedded disk $\Delta \subset W$ such that $\partial \Delta = \Delta \cap \partial W = K$.

Let $\mathcal{C}_\mathbb{Q}$ denote the set of triples (Y, K, \mathfrak{s}) , where Y is a rational homology sphere, $K \subset Y$ is a null-homologous knot, and $\mathfrak{s} \in \text{Spin}^c(Y)$, considered up to rational concordance. $\mathcal{C}_\mathbb{Q}$ has a group structure induced by connected sum

$$(Y_0, K_0, \mathfrak{s}_0) \# (Y_1, K_1, \mathfrak{s}_1) = (Y_0 \# Y_1, K_0 \# K_1, \mathfrak{s}_0 \# \mathfrak{s}_1) .$$

In this group structure rationally slice knots represent the trivial element, and the inverse corresponds to taking the mirror image $-(Y, K, \mathfrak{s}) = (-Y, -K, \bar{\mathfrak{s}})$. Here $-Y$ stands for the three-manifold Y with its reversed orientation, and $-K$ is the knot K with its orientation reversed.

The main goal of this section is to prove the following theorem, generalizing a result of Hom [16, Theorem 1] to rational homology spheres, cf. also [17, Section 4].

Theorem 2.2. *Let $(Y_0, K_0, \mathfrak{s}_0)$ and $(Y_1, K_1, \mathfrak{s}_1)$ be two spin^c rationally concordant knots. Then the chain complexes $\mathcal{CFK}^\infty(Y_0, K_0, \mathfrak{s}_0)$ and $\mathcal{CFK}^\infty(Y_1, K_1, \mathfrak{s}_1)$ are stably equivalent, that is, there exist \mathbb{Q} -graded, $\mathbb{Z} \oplus \mathbb{Z}$ -filtered, acyclic chain complexes \mathcal{A}_0 and \mathcal{A}_1 (that is, $H_*(\mathcal{A}_i) = 0$) such that*

$$\mathcal{CFK}^\infty(Y_0, K_0, \mathfrak{s}_0) \oplus \mathcal{A}_0 \simeq \mathcal{CFK}^\infty(Y_1, K_1, \mathfrak{s}_1) \oplus \mathcal{A}_1,$$

where \simeq denotes graded $\mathbb{Z} \oplus \mathbb{Z}$ -filtered chain homotopy equivalence.

Theorem 2.2 can be deduced from the following lemma.

Lemma 2.3. *Let K be a null-homologous knot in a rational homology sphere Y , and $\mathfrak{s} \in \text{Spin}^c(Y)$. If K is rationally slice, then there exists a \mathbb{Q} -graded, $\mathbb{Z} \oplus \mathbb{Z}$ -filtered, acyclic chain complex \mathcal{A} such that*

$$\mathcal{CFK}^\infty(Y, K, \mathfrak{s}) \simeq \mathcal{CFK}^\infty(S^3, U, \mathfrak{u}) \oplus \mathcal{A},$$

where $U \subset S^3$ denotes the unknot, and \mathfrak{u} denotes the unique spin^c structure of S^3 .

Remark 2.4. *It is not hard to see that $\mathcal{CFK}^\infty(S^3, U, \mathfrak{u}) \simeq \mathbb{Z}_2[U, U^{-1}]$ with $\partial = 0$, $gr(1) = 0$ and both the Alexander and algebraic filtration level of 1 is zero.*

Proof of Theorem 2.2. For $i = 0, 1$ let Y_i be a rational homology sphere, $K_i \subset Y_i$ a null-homologous knot, and $\mathfrak{s}_i \in \text{Spin}^c(Y_i)$. Note that

- if $(Y_0, K_0, \mathfrak{s}_0)$ and $(Y_1, K_1, \mathfrak{s}_1)$ represent rationally concordant null-homologous knots then $(Y_1 \# -Y_0, K_1 \# -K_0, \mathfrak{s}_1 \# \bar{\mathfrak{s}}_0)$ is rationally slice,
- according to [29] for $(Y_0, K_0, \mathfrak{s}_0)$, $(Y_1, K_1, \mathfrak{s}_1)$ null-homologous knots we have $\mathcal{CFK}^\infty(Y_0 \# Y_1, K_0 \# K_1, \mathfrak{s}_0 \# \mathfrak{s}_1) \simeq \mathcal{CFK}^\infty(Y_0, K_0, \mathfrak{s}_0) \otimes_{\mathbb{Z}_2[U, U^{-1}]} \mathcal{CFK}^\infty(Y_1, K_1, \mathfrak{s}_1)$ and the gradings and filtrations add.

Suppose that K_0 and K_1 are rationally concordant, and consider the chain complex

$$\mathcal{K} = \mathcal{CFK}^\infty(Y_0 \# (-Y_1) \# Y_1, K_0 \# (-K_1) \# K_1, \mathfrak{s}_0 \# \bar{\mathfrak{s}}_1 \# \mathfrak{s}_1).$$

As consequence of Lemma 2.3, we have that

$$\begin{aligned} \mathcal{K} &\simeq \mathcal{CFK}^\infty(Y_0, K_0, \mathfrak{s}_0) \otimes \mathcal{CFK}^\infty((-Y_1) \# Y_1, (-K_1) \# K_1, \bar{\mathfrak{s}}_1 \# \mathfrak{s}_1) \\ &\simeq \mathcal{CFK}^\infty(Y_0, K_0, \mathfrak{s}_0) \otimes (\mathcal{CFK}^\infty(S^3, U, \mathfrak{u}) \oplus \mathcal{A}) \\ &\simeq (\mathcal{CFK}^\infty(Y_0, K_0, \mathfrak{s}_0) \otimes \mathcal{CFK}^\infty(S^3, U, \mathfrak{u})) \oplus (\mathcal{CFK}^\infty(Y_0, K_0, \mathfrak{s}_0) \otimes \mathcal{A}) \\ &\simeq \mathcal{CFK}^\infty(Y_0 \# S^3, K \# U, \mathfrak{s}_0 \# \mathfrak{u}) \oplus (\mathcal{CFK}^\infty(Y_0, K_0, \mathfrak{s}_0) \otimes \mathcal{A}) \\ &= \mathcal{CFK}^\infty(Y_0, K_0, \mathfrak{s}_0) \oplus (\mathcal{CFK}^\infty(Y_0, K_0, \mathfrak{s}_0) \otimes \mathcal{A}), \end{aligned}$$

for some acyclic complex \mathcal{A} . On the other hand,

$$\begin{aligned} \mathcal{K} &\simeq \mathcal{CFK}^\infty(Y_0 \# (-Y_1), K_0 \# (-K_1), \mathfrak{s}_0 \# \bar{\mathfrak{s}}_1) \otimes \mathcal{CFK}^\infty(Y_1, K_1, \mathfrak{s}_1) \\ &\simeq (\mathcal{CFK}^\infty(S^3, U, \mathfrak{u}) \oplus \mathcal{B}) \otimes \mathcal{CFK}^\infty(Y_1, K_1, \mathfrak{s}_1) \\ &\simeq (\mathcal{CFK}^\infty(S^3, U, \mathfrak{u}) \otimes \mathcal{CFK}^\infty(Y_1, K_1, \mathfrak{s}_1)) \oplus (\mathcal{B} \otimes \mathcal{CFK}^\infty(Y_1, K_1, \mathfrak{s}_1)) \\ &\simeq (\mathcal{CFK}^\infty(S^3 \# Y_1, U \# K_1, \mathfrak{u} \# \mathfrak{s}_1)) \oplus (\mathcal{B} \otimes \mathcal{CFK}^\infty(Y_1, K_1, \mathfrak{s}_1)) \\ &= \mathcal{CFK}^\infty(Y_1, K_1, \mathfrak{s}_1) \oplus (\mathcal{B} \otimes \mathcal{CFK}^\infty(Y_1, K_1, \mathfrak{s}_1)), \end{aligned}$$

again for some acyclic complex \mathcal{B} . Thus

$$\mathcal{CFK}^\infty(Y_0, K_0, \mathfrak{s}_0) \oplus \mathcal{A}_0 \simeq \mathcal{CFK}^\infty(Y_1, K_1, \mathfrak{s}_1) \oplus \mathcal{A}_1 ,$$

where $\mathcal{A}_0 = \mathcal{CFK}^\infty(Y_0, K_0, \mathfrak{s}_0) \otimes \mathcal{A}$ and $\mathcal{A}_1 = \mathcal{B} \otimes \mathcal{CFK}^\infty(Y_1, K_1, \mathfrak{s}_1)$. Using the Künneth formula one concludes that \mathcal{A}_0 and \mathcal{A}_1 are both acyclic. \square

For the proof of Lemma 2.3 we need a little preparation. Let $K \subseteq Y$ and \mathfrak{s} be as above, and consider the knot Floer complex $\mathcal{CFK}^\infty(Y, K, \mathfrak{s})$. For $m \geq 0$ set

$$V_K(m, \mathfrak{s}) = d(Y, \mathfrak{s}) - 2 \cdot \min_i \max(A(z_i) - m, j(z_i)) , \quad (1)$$

where $z_1, \dots, z_k \in \mathcal{CFK}^\infty(Y, K, \mathfrak{s})$ are the cycles with Maslov grading $d = d(Y, \mathfrak{s})$ representing the non-zero element of $H_d(\mathcal{CFK}^\infty(Y, K, \mathfrak{s})) = \mathbb{Z}_2$. Our first goal is to relate $V_K(m, \mathfrak{s})$ to the correction terms of the surgeries along K .

Given a null-homologous knot $K \subset Y$, define its *four-dimensional genus* $g_*(K)$ as the minimal genus of a smooth, compact surface in $Y \times [0, 1]$ with boundary $K \times \{0\}$. For an integer q , let $W_q(K)$ denote the q -framed two-handle attachment along $K \times \{1\} \subset Y \times [0, 1]$, so that $\partial W_q(K) = Y_q(K) \sqcup -Y$. Furthermore, for any integer $m \in [-q/2, q/2]$, let \mathfrak{t}_m denote the spin^c structure on $W_q(K)$ extending \mathfrak{s} to $Y_q(K)$, and satisfying $\langle c_1(\mathfrak{t}_m), [\widehat{F}] \rangle + q = 2m$, where $\widehat{F} \subset W_q(K)$ denotes a Seifert surface F for K , capped-off with the core of the 2-handle. Finally, let $\mathfrak{s}_m \in \text{Spin}^c(Y_q(K))$ denote the spin^c structure we get by restricting \mathfrak{t}_m to $Y_q(K)$. With these notations and definitions in place, we have the following result.

Proposition 2.5. *Let $K \subseteq Y$ be a null-homologous knot in a rational homology sphere Y , $\mathfrak{s} \in \text{Spin}^c(Y)$, and fix an integer $q \geq 2g_*(K) - 1$. Then*

$$d(Y_q(K), \mathfrak{s}_m) = \frac{(q - 2m)^2 - q}{4q} + V_K(m, \mathfrak{s}) .$$

Proof. Let $\mathcal{CFK}^\infty(Y, K, \mathfrak{s})\{A \leq m, j \leq 0\}$ denote the subcomplex of $\mathcal{CFK}^\infty(Y, K)$ spanned by generators with Alexander filtration level $A \leq m$, and algebraic filtration level $j \leq 0$. According to [29, Section 4] we have that:

- $\mathcal{CFK}^\infty(Y, K, \mathfrak{s})\{A \leq m, j \leq 0\}$ is chain homotopy equivalent to $CF^-(Y_q(K), \mathfrak{s}_m)$;
- $\mathcal{CFK}^\infty(Y, K, \mathfrak{s})\{j \leq 0\}$, the subcomplex of $\mathcal{CFK}^\infty(Y, K)$ spanned by the generators with algebraic filtration level $j \leq 0$, is chain homotopy equivalent to the Heegaard Floer complex $CF^-(Y, \mathfrak{s})$ of the ambient spin^c 3-manifold;
- the inclusion $\mathcal{CFK}^\infty(Y, K, \mathfrak{s})\{A \leq m, j \leq 0\} \hookrightarrow \mathcal{CFK}^\infty(Y, K, \mathfrak{s})\{j \leq 0\}$ descends in homology to the map $F_{X, \mathfrak{t}_m} : HF^-(Y_q(K), \mathfrak{s}_m) \rightarrow HF^-(Y, \mathfrak{s})$ induced by the cobordism $X = -W_q(K)$ endowed with the spin^c structure \mathfrak{t}_m .

By considering the degree-shift formula of [27], we obtain

$$\text{gr}(F_{X, \mathfrak{t}_m}(\xi)) - \text{gr}(\xi) = \frac{c_1(\mathfrak{t}_m)^2 - 2\chi(X) - 3\sigma(X)}{4} ,$$

where ξ denotes the generator of the free summand of $HF^-(Y_q(K), \mathfrak{s}_m)$. Thus

$$d(Y_q(K), \mathfrak{s}_m) = d + \frac{(q - 2m)^2 - q}{4q} ,$$

where d is the grading of the generator of the free summand of $H_*(\mathcal{CFK}^\infty(Y, K, \mathfrak{s})\{A \leq m, j \leq 0\})$. Since the inclusion

$$\mathcal{CFK}^\infty(Y, K, \mathfrak{s})\{A \leq m, j \leq 0\} \hookrightarrow CFK^\infty(Y, K, \mathfrak{s})\{j \leq 0\}$$

maps the generator of the free summand of $HF^-(Y_q(K), \mathfrak{s}_m)$ to a U^n -multiple of the one of $HF^-(Y, \mathfrak{s})$, if $z_1, \dots, z_k \in \mathcal{CFK}^\infty(Y, K, \mathfrak{s})$ denote the cycles with Maslov grading $M = d(Y, \mathfrak{s})$ representing $1 \in \mathbb{Z}_2[U, U^{-1}] = H_*(\mathcal{CFK}^\infty(Y, K, \mathfrak{s}))$ then

$$d = \max_i M(U^{n_i} \cdot z_i) = \max_i (M(z_i) - 2n_i) = d(Y, \mathfrak{s}) - 2 \min_i n_i,$$

where n_i is the minimum $n \geq 0$ such that $U^n \cdot z_i \in \mathcal{CFK}^\infty(Y, K, \mathfrak{s})\{A \leq m, j \leq 0\}$.

Since $n_i = \max(A(z_i) - m, j(z_i))$ this proves that

$$d = d(Y, \mathfrak{s}) - 2 \min_i \max(A(z_i) - m, j(z_i)) = V_K(m, \mathfrak{s}).$$

□

Corollary 2.6. *Let $K \subset Y$ be a knot in a rational homology sphere, $\mathfrak{s} \in \text{Spin}^c(Y)$ and $m \in \mathbb{N}$. Then $V_K(m, \mathfrak{s})$ is a spin^c rational concordance invariant.*

Proof. For $i = 0, 1$ let (Y_i, \mathfrak{s}_i) be a spin^c rational homology spheres, $K_i \subset Y_i$ null-homologous knots, such that $(Y_0, K_0, \mathfrak{s}_0)$ and $(Y_1, K_1, \mathfrak{s}_1)$ are rationally concordant. We want to prove that $V_{K_0}(m, \mathfrak{s}_0) = V_{K_1}(m, \mathfrak{s}_1)$.

Let (W, C, \mathfrak{t}) be a spin^c rational homology cobordism from $(Y_0, K_0, \mathfrak{s}_0)$ to $(Y_1, K_1, \mathfrak{s}_1)$. Pick a suitably large $q \geq 0$, glue to W a q -framed 2-handle along $K_0 \subset -Y_0 \subset \partial W$ and a $(-q)$ -framed 2-handle along $K_1 \subset Y_1 \subset \partial W$. Denote by W' the resulting cobordism from $Y_q(K_0)$ to $Y_q(K_1)$. Note that W' is naturally equipped with a spin^c structure \mathfrak{t}' agreeing with \mathfrak{t} on $W \subset W'$, and restricts to the spin^c structure \mathfrak{s}_m of Proposition 2.5 on its two boundary components.

Clearly W' is not a rational homology cobordism, as $H_2(W'; \mathbb{Z}) = \mathbb{Z}^2$ is generated by the homology classes of the two 2-handles we attached along K_0 and K_1 . For $i = 0, 1$ let $\Delta_i \subset W'$ be the core disk of the 2-handle attached along K_i . Set $S = \Delta_0 \cup C \cup -\Delta_1$; then S is a two-sphere with $S \cdot S = 0$. Surgering out S we get a rational homology cobordism X from $Y_q(K_0)$ to $Y_q(K_1)$ with $H_1(X; \mathbb{Z}) = \mathbb{Z}/q\mathbb{Z}$. Since by construction $\langle c_1(\mathfrak{t}'), [S] \rangle = 0$, the spin^c structure $\mathfrak{t}'|_{W' - \nu S}$ extends to a spin^c structure \mathfrak{t}_X of $X = (W' - \nu S) \cup_{\partial} S^1 \times B^3$. Summarizing, the pair (X, \mathfrak{t}_X) provides a spin^c rational homology cobordism from $(Y_q(K_0), \mathfrak{s}_m)$ to $(Y_q(K_1), \mathfrak{s}_m)$. This implies that $d(Y_q(K_0), \mathfrak{s}_m) = d(Y_q(K_1), \mathfrak{s}_m)$, and the claim now follows from Proposition 2.5. □

Corollary 2.7. $V_K(m, \mathfrak{s}) \equiv 0$ for a rationally slice knot (Y, K, \mathfrak{s}) .

Proof. A rationally slice knot is rationally concordant to the unknot (S^3, U, \mathfrak{u}) . For the unknot one has

$$\mathcal{CFK}^\infty(S^3, U, \mathfrak{u}) = \mathbb{Z}_2[U, U^{-1}] \cdot z, \quad \partial z = 0$$

graded so that $A(z) = j(z) = M(z) = 0$. Thus,

$$V_U(m, \mathfrak{u}) = d(S^3, \mathfrak{u}) - 2 \max(A(z) - m, j(z)) = -2 \max(-m, 0) = 0,$$

for every $m \geq 0$. □

Proof of Lemma 2.3. The proof is a simple adaptation of [16, Proposition 11]. Our first task is to find a cycle ξ with bi-filtration level $(0, 0)$. If (Y, K, \mathfrak{s}) is rationally slice then

$$0 = V_K(0, \mathfrak{s}) = d(Y, \mathfrak{s}) - 2 \cdot \min_{\xi} \max(A(\xi), j(\xi)) = -2 \cdot \min_{\xi} \max(A(\xi), j(\xi))$$

where the minimum is taken over all cycles $\xi \in \mathcal{CFK}^\infty(Y, K, \mathfrak{s})$ having Maslov grading $M(\xi) = d(Y, \mathfrak{s}) = 0$. Here $d(Y, \mathfrak{s}) = 0$, since (Y, \mathfrak{s}) bounds a spin^c rational homology

disk. Thus, we can find a cycle ξ with Maslov grading zero representing the generator of $H_0(\mathcal{CFK}^\infty(Y, K, \mathfrak{s})) \simeq \mathbb{Z}_2$ such that $\max(A(\xi), j(\xi)) = 0$.

We claim that the Alexander and algebraic filtration levels of ξ are both zero. Notice that ξ^+ , the projection of ξ on $\mathcal{CFK}^\infty(Y, K, \mathfrak{s})\{j \geq 0\} \simeq CF^+(Y, \mathfrak{s})$, represents the generator of the tower of $HF^+(Y, \mathfrak{s})$. If we prove that the projection of ξ^+ on $\mathcal{CFK}^\infty(Y, K, \mathfrak{s})\{j \geq 0, A \geq 0\}$ is non-zero we are done. To this end, note that the projection

$$\pi: CF^+(Y, \mathfrak{s}) = \mathcal{CFK}^\infty(Y, K, \mathfrak{s})\{j \geq 0\} \rightarrow \mathcal{CFK}^\infty(Y, K, \mathfrak{s})\{j \geq 0, A \geq 0\}$$

is dual (cf. [29]) to the inclusion

$$\iota: \mathcal{CFK}^\infty(-Y, K, \bar{\mathfrak{s}})\{j \leq 0, A \leq 0\} \rightarrow CF^-(-Y, \bar{\mathfrak{s}}) = \mathcal{CFK}^\infty(-Y, K, \bar{\mathfrak{s}})\{j \leq 0\} .$$

Since the knot $-K$, viewed now in $-Y$, is also rationally slice, we have $V_{-K}(0, \bar{\mathfrak{s}}) = 0$. This implies that ι is surjective on the free summand, hence π is injective on the tower, leading to the conclusion that $\pi(\xi^+) \neq 0$. This proves that the top component of ξ has bi-filtration level $(0, 0)$.

Let $\mathbf{x}_0, \dots, \mathbf{x}_m$ denotes a basis $\widehat{CFK}(Y, K, \mathfrak{s}) = \mathcal{CFK}^\infty(Y, K, \mathfrak{s})\{j = 0\}$, e.g. the one coming from the Heegaard diagram. Since ξ has bi-filtration level $(0, 0)$ there is a basis element, say \mathbf{x}_0 , in bi-filtration level $(0, 0)$ such that

$$\xi = \mathbf{x}_0 + (\text{lower bi-filtration level terms}) .$$

We complete $\xi_0 = \xi$ to a $\mathbb{Z}_2[U, U^{-1}]$ -basis $\{\xi_0, \xi_1, \dots, \xi_m\}$ of $\mathcal{CFK}^\infty(Y, K, \mathfrak{s})$ by simply taking $\xi_i = \mathbf{x}_i$ for $i = 1, \dots, m$. Obviously:

$$\mathcal{CFK}^\infty(Y, K, \mathfrak{s}) = \mathbb{Z}_2[U, U^{-1}] \cdot \xi \oplus \text{Span}_{\mathbb{Z}_2[U, U^{-1}]} \langle \xi_1, \dots, \xi_m \rangle$$

as bi-filtered module, but not necessarily as chain complex (it can happen that $\xi_0 = \xi$ is a component of $\partial\xi_i$ for some basis element ξ_i). This issue can be overcome as follows. Suppose that ξ_0 appears in the differential of a basis element ξ_i . Since $[\xi_0]$ is non zero in $H_*(\mathcal{CFK}^\infty(Y, K, \mathfrak{s})\{A \geq 0, j \geq 0\})$ we can write

$$\partial\xi_i = \xi_0 + U^k \xi_j + \dots ,$$

for some \mathbb{Z}_2 -generator $U^k \xi_j$ with bi-filtration level $\geq (0, 0)$. Then we substitute the basis element ξ_j with $\xi_j + U^{-k} \xi_0$. After repeating this move a few times, we can make sure that ξ_0 does not appear as a component of the differential of any other basis element. This leads to a basis $\{\xi'_0, \dots, \xi'_m\}$ of $\mathcal{CFK}^\infty(Y, K, \mathfrak{s})$ such that

- $\mathcal{CFK}^\infty(Y, K, \mathfrak{s}) = \mathbb{Z}_2[U, U^{-1}] \cdot \xi'_0 \oplus \text{Span}_{\mathbb{Z}_2[U, U^{-1}]} \langle \xi'_1, \dots, \xi'_m \rangle$ as bi-filtered module
- $\xi'_0 = \xi_0 = \xi$, and hence $\partial\xi'_0 = 0$
- $\partial\xi'_i \in \text{Span}_{\mathbb{Z}_2[U, U^{-1}]} \langle \xi'_1, \dots, \xi'_m \rangle$ for $i = 1, \dots, m$.

The desired splitting is given by $\mathcal{CFK}^\infty(Y, K, \mathfrak{s}) = \mathbb{Z}_2[U, U^{-1}] \cdot \xi \oplus \mathcal{A}$, where $\mathcal{A} = \text{Span}_{\mathbb{Z}_2[U, U^{-1}]} \langle \xi'_1, \dots, \xi'_m \rangle$ □

The above result can be summarized as follows:

Lemma 2.8. *The map $\mathcal{CFK}^\infty: \mathcal{C}_\mathbb{Q} \rightarrow \mathcal{GCFK}$ defines a group homomorphism.*

Proof. \mathcal{CFK}^∞ associates to a null-homologous knot K in a spin^c QHS³ (Y, \mathfrak{s}) a knot type complex $\mathcal{CFK}^\infty(Y, K, \mathfrak{s})$ with $d(\mathcal{CFK}^\infty(Y, K, \mathfrak{s})) = d(Y, \mathfrak{s})$, well-defined up to $\mathbb{Z} \oplus \mathbb{Z}$ -filtered chain homotopy equivalence. As a consequence of Theorem 2.2, the map \mathcal{CFK}^∞ descends to a map $\mathcal{C}_\mathbb{Q} \rightarrow \mathcal{GCFK}$. This is a group homomorphism in view of [29, Proposition 4]. □

We conclude this section by recalling yet another (but, as it turns out to be, equivalent) equivalence relation among chain complexes: local equivalence. Although stable equivalence turns out to be very convenient in defining invariants (as it will be clear from our later constructions), local equivalence is phrased more naturally, since it takes maps between the actual chain complexes into account, and these maps are naturally induced by cobordisms and concordances.

Definition 2.9. *Suppose that \mathcal{K}_i for $i = 1, 2$ are knot type chain complexes over $\mathbb{Z}_2[U, U^{-1}]$; then we say that \mathcal{K}_1 and \mathcal{K}_2 are **locally equivalent** if there are graded, $\mathbb{Z} \oplus \mathbb{Z}$ -filtered chain maps $f: \mathcal{K}_1 \rightarrow \mathcal{K}_2$ and $g: \mathcal{K}_2 \rightarrow \mathcal{K}_1$ inducing isomorphisms on the homologies.*

Theorem 2.10 ([36]). *If the knots $(Y_1, K_1, \mathfrak{s}_1)$ and $(Y_2, K_2, \mathfrak{s}_2)$ are rationally concordant (in the sense of Definition 2.1) then the corresponding graded, $\mathbb{Z} \oplus \mathbb{Z}$ -filtered chain complexes $\mathcal{CFK}^\infty(Y_i, K_i, \mathfrak{s}_i)$ are locally equivalent. \square*

Proposition 2.11. *The knot type chain complexes \mathcal{K}_i for $(i = 1, 2)$ are stably equivalent if and only if they are locally equivalent.*

Proof. Stable equivalence clearly implies local equivalence. Indeed, if $f: \mathcal{K}_1 \oplus \mathcal{A}_1 \rightarrow \mathcal{K}_2 \oplus \mathcal{A}_2$ is a chain homotopy equivalence (with \mathcal{A}_i acyclic complexes), then the restriction of f to \mathcal{K}_1 , composed with the projection $pr: \mathcal{K}_2 \oplus \mathcal{A}_2 \rightarrow \mathcal{K}_2$ provided a chain map inducing isomorphism on homology.

The converse is the content of [12, Lemma 3.3] when $\mathcal{K}_2 = \mathbb{Z}_2[U, U^{-1}]$. The general case of this converse direction then follows by applying [12, Lemma 3.3] to $\mathcal{K}_2^* \oplus \mathcal{K}_1$ and $\mathbb{Z}_2[U, U^{-1}]$ (where \mathcal{K}_2^* denotes the dual of \mathcal{K}_2). \square

3. KNOT FLOER INVARIANTS FROM CYCLIC BRANCHED COVERS

In [1] the first author described a general construction producing maps $\mathcal{GCFK}/\sim \rightarrow \mathbb{R}$ that can be used to generate rational concordance invariants $\mathcal{C}_\mathbb{Q} \rightarrow \mathbb{R}$ by precomposing with \mathcal{CFK}^∞ . Recall that a region of the Euclidean plane $C \subset \mathbb{R}^2$ is **south-west** if it is closed, non-empty, not equal to \mathbb{R}^2 and

$$(\bar{x}, \bar{y}) \in C \Rightarrow \{(x, y) \mid x \leq \bar{x}, y \leq \bar{y}\} \subseteq C.$$

Given a knot type complex \mathcal{K}_* , denote by $\mathcal{K}_*(C)$ the $\mathbb{Z}_2[U]$ -submodule of \mathcal{K}_* spanned by the generators with (j, A) -invariants lying in C . For a south-west region C of the plane and a knot type complex \mathcal{K}_* set

$$\Upsilon^C(\mathcal{K}_*) = \inf \{t \mid \mathcal{K}_*(C_t) \hookrightarrow \mathcal{K}_* \text{ induces a surjective map on } H_{d(\mathcal{K}_*)}\},$$

where $C_t = \{(x, y) \mid (x - t, y - t) \in C\}$ denotes the translate of C with the vector $v_t = (t, t)$. Here we are using the Maslov grading as homological grading, so $H_q(\mathcal{K}_*) = \mathbb{Z}_2$ for $q \in d(\mathcal{K}_*) + 2\mathbb{Z}$, and zero otherwise. Since the elements with Maslov grading equal to $d(Y, \mathfrak{s})$ form a finite dimensional subspace, it is easy to see that for $t \ll 0$ the map $\mathcal{K}_*(C_t) \hookrightarrow \mathcal{K}_*$ induces the zero-map on $H_{d(\mathcal{K}_*)}$, while for $t \gg 0$ the induced map is surjective. The same finiteness also implies that the infimum appearing in the definition above is indeed a minimum, hence in what follows we will write min instead of inf. The next result was pointed out in [1].

Proposition 3.1. *Let C be a south-west region. If \mathcal{K}_* and \mathcal{K}'_* are two stably equivalent knot type complexes then $\Upsilon^C(\mathcal{K}_*) = \Upsilon^C(\mathcal{K}'_*)$. Consequently, for every south-west region C we get a map $\Upsilon^C: \mathcal{GCFK}/\sim \rightarrow \mathbb{R}$. \square*

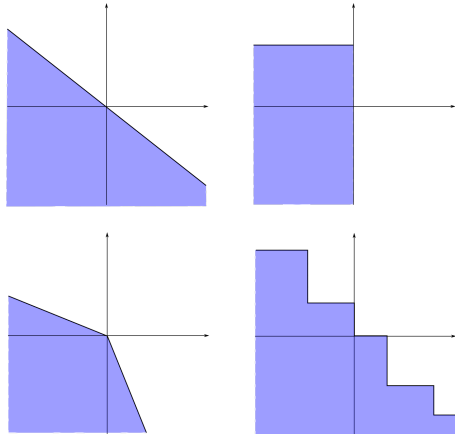

FIGURE 1. Examples of normalized south-west domains.

In Figure 1 some notable families of south-west regions are shown. Thanks to Proposition 3.1 each of these families can be used to produce a one-parameter family of stable equivalence invariants.

In what follows, we will assume that the south-west region C is *normalized*, that is it contains the origin $(0, 0) \in \mathbb{R}^2$ on its boundary ∂C . This condition ensures that $\Upsilon^C(\mathcal{CFK}^\infty(S^3, U, \mathbf{u})) = 0$.

3.1. Some concordance invariants of classical knots. We can now use the results of the previous sections to define some concordance invariants of knots in S^3 . Given $K \subset S^3$ we can form its m -fold cyclic branched cover $\Sigma^m(K)$. This is a 3-manifold equipped with an order m self-diffeomorphism τ . The fixed locus of the $\mathbb{Z}/m\mathbb{Z}$ -action defined by τ describes a knot $\tilde{K} \subset \Sigma^m(K)$. The following result is part of knot theory folklore (see *e.g.* [21, Section 3]).

Lemma 3.2. *If m is a prime power, then $\Sigma^m(K)$ is a rational homology sphere.*

Proof. $\tilde{K} \subset \Sigma^m(K)$ is a null-homologous knot since it bounds any lift $\tilde{F} \subset \Sigma^m(K)$ of a Seifert surface $F \subset S^3$ of K . Using a Seifert matrix $\theta_{\tilde{F}}$ of \tilde{F} one can define the Alexander polynomial of \tilde{K} via the formula $\Delta_{\tilde{K}}(x) = \det(x\theta_{\tilde{F}} - x^{-1}\theta_{\tilde{F}}^t)$.

The first homology $H_1(\Sigma^m(K); \mathbb{Z})$ is of order $|\Delta_{\tilde{K}}(-1)|$ if the latter is non-zero, and infinite otherwise. The Alexander polynomial of \tilde{K} can be computed from the usual Alexander polynomial of K by the formula

$$\Delta_{\tilde{K}}(x) = \prod_{i=0}^{m-1} \Delta_K(\omega^i x^{1/m})$$

where ω denotes a primitive m^{th} root of unity. When $m = p^k$ is a power of a prime,

$$|\Delta_{\tilde{K}}(-1)| = \prod_{i=0}^{m-1} |\Delta_K(\omega^i)| \neq 0,$$

since the Alexander polynomial of a knot does not vanish at any p^k root of unity: if it did then it would be divisible by the cyclotomic polynomial $\phi_{p^r}(x) = \sum_{i=0}^{p-1} x^{ip^{r-1}}$ implying that $\phi_{p^r}(1) = p$ divides $\Delta_K(1) = 1$, a contradiction. \square

Remark 3.3. *The Alexander polynomial $\Delta_{\tilde{K}}(x)$ admits a refinement according to spin^c structures, see [35].*

The m -fold cyclic branched cover $\Sigma^m(K)$ of a knot $K \subset S^3$ admits a distinguished spin structure \mathfrak{s}_0 that can be used to canonically identify $\text{Spin}^c(\Sigma^m(K))$ with its second cohomology group $H^2(\Sigma^m(K); \mathbb{Z}) \simeq H_1(\Sigma^m(K); \mathbb{Z})$ (cf. [11] and [18]).

Lemma 3.4 (Lemma 2.1 [11]). *Let $\Sigma^m(F)$ denote the m -fold cyclic branched cover of a properly embedded surface $F \subset B^4$, with boundary a knot $K \subset S^3$. Denote by $\tilde{F} \subset \Sigma^m(F)$ the fixed locus of the covering action of $\Sigma^m(F)$. Then there is a unique spin structure \mathfrak{t}_0 on $\Sigma^m(F)$ characterized as follows:*

- if m is odd, the restriction of \mathfrak{t}_0 to $\Sigma^m(F) - \nu\tilde{F}$ is the pull-back $\tilde{\mathfrak{k}}$ of the spin structure of $B^4 - \nu F$ extending over B^4 ,
- if m is even, the restriction of \mathfrak{t}_0 to $\Sigma^m(F) - \nu\tilde{F}$ is $\tilde{\mathfrak{k}}$ twisted by the element of $H^1(\Sigma^m(F) - \nu\tilde{F}; \mathbb{Z}_2)$ supported on the linking circle of \tilde{F} .

We define the canonical spin structure \mathfrak{s}_0 of the three-manifold $\Sigma^m(K)$ as the restriction of the spin structure $\mathfrak{t}_0 \in \text{Spin}^c(\Sigma^m(F))$ of Lemma 3.4 to $\Sigma^m(K) = \partial(\Sigma^m(F))$, where $F \subset B^4$ denotes a pushed-in Seifert surface of $K \subset S^3$.

Lemma 3.5. *Let $\mathcal{C}_{\mathbb{Q}}^{\text{Spin}}$ denote the subgroup of $\mathcal{C}_{\mathbb{Q}}$ spanned by the triples (Y, K, \mathfrak{s}) with \mathfrak{s} spin. Let $m = p^r$ be a power of a prime. Then the map $\Sigma^m: K \mapsto (\Sigma^m(K), \tilde{K}, \mathfrak{s}_0)$ descends to a group homomorphism $\Sigma^m: \mathcal{C} \rightarrow \mathcal{C}_{\mathbb{Q}}^{\text{Spin}}$.*

Proof. Since the m -fold cyclic branched cover of the two-sphere branched on two points is the two-sphere, we conclude that the map Σ^m respects connected sums; moreover, the spin structures on the summands glue to the spin structure on the connected sum. Thus, it is enough to prove that if K is a slice knot then $(\Sigma^m(K), \tilde{K}, \mathfrak{s}_0)$ is rationally slice.

Suppose that $K \subset S^3$ bounds a smooth disk $\Delta \subset B^4$. By taking the m -fold cyclic branched cover of Δ we get a rational homology ball $\Sigma^m(\Delta)$. In $\Sigma^m(\Delta)$ the knot $\tilde{K} \subset \partial\Sigma^m(\Delta)$ bounds a smooth disk $\tilde{\Delta}$, namely the fixed locus of the covering action of $\Sigma^m(F)$. Furthermore, the spin structure \mathfrak{t}_0 of Lemma 3.4 provides a spin extension of \mathfrak{s}_0 to $\Sigma^m(F)$. \square

Theorem 3.6. *Let $C \subset \mathbb{R}^2$ be a south-west region, and $m = p^r$ a power of a prime. Given a knot $K \subset S^3$ set $\Upsilon_m^C(K) = \Upsilon^C(\mathcal{CFK}^\infty(\Sigma^m(K), \tilde{K}, \mathfrak{s}_0))$. Then $\Upsilon_m^C(K)$ is a knot concordance invariant.*

Proof. The result follows by combining Lemmas 2.8, 3.5 and Proposition 3.1. \square

Remark 3.7. *Using south-west regions which are symmetric with respect to the $x = y$ axis, one can construct further invariants $\bar{\Upsilon}_m^C(K)$ and $\underline{\Upsilon}_m^C(K)$ by means of the involutive Heegaard Floer homology [13]. For a related definition of involutive epsilon invariants, see [14].*

For a given cohomology class $\xi \in H^2(\Sigma^m(K); \mathbb{Z}) \simeq H_1(\Sigma^m(K); \mathbb{Z})$ we can set

$$\Upsilon_\xi^C(K) = \Upsilon^C(\mathcal{CFK}^\infty(\Sigma^m(K), \tilde{K}, \mathfrak{s}_0 + \xi)) ,$$

where $\mathfrak{s}_0 + \xi$ denotes the spin^c structure we get from \mathfrak{s}_0 by twisting it with ξ . The following result is a straightforward adaptation of [11, Theorem 1.1], and provides a way to obtain some additional concordance information from the construction above.

Theorem 3.8. *Let $K \subset S^3$ be a knot. Suppose that $m = p^r$ is a power of a prime and set*

$$\det_m(K) = \prod_{i=0}^{m-1} |\Delta_K(\omega^i)|$$

where ω is a primitive m -th root of unity. If K is a slice knot then there exists a subgroup $G < H^2(\Sigma^m(K); \mathbb{Z})$ of cardinality $\sqrt{\det_m(K)}$ such that $\Upsilon_\xi^C(K) = 0$ for all $\xi \in G$.

Proof. By the previous discussion, if K is a slice knot, then $\det_m(K)$ is a square. Indeed, $\det_m(K)$ computes the cardinality of $H_1(\Sigma^m(K); \mathbb{Z})$, which is necessarily a square whenever $\Sigma^m(K)$ bounds a rational homology ball.

If K is a slice knot, then $\Sigma^m(K)$ bounds a rational homology ball W to which the spin structure \mathfrak{s}_0 of Lemma 3.4 extends. If $G < H^2(\Sigma^m(K); \mathbb{Z})$ denotes the image of the restriction map $\delta: H^2(W; \mathbb{Z}) \rightarrow H^2(\partial W; \mathbb{Z})$ of the long exact sequence for the pair $(W, \partial W)$, then $\mathfrak{s}_0 + \xi$ extends to a Spin^c structure of W for each $\xi \in G$. More precisely, if \mathfrak{t}_0 denotes the spin^c structure extending \mathfrak{s}_0 then $\partial(W, \mathfrak{t}_0 + \xi') = (\Sigma^m(K), \mathfrak{s}_0 + \xi)$ where $\xi' \in H^2(W; \mathbb{Z})$ is a class such that $\delta(\xi') = \xi$.

Summarizing, whenever K is a slice knot, for each $\xi \in G = \text{Im}(H^2(W; \mathbb{Z}) \rightarrow H^2(\partial W; \mathbb{Z}))$ the triple $(\Sigma^m(K), \tilde{K}, \mathfrak{s}_0 + \xi)$ represents a spin^c rationally slice knot. Thus, as consequence of Proposition 3.1

$$\Upsilon_\xi^C(K) = \Upsilon^C(\mathcal{CFK}^\infty(\Sigma^m(K), \tilde{K}, \mathfrak{s}_0 + \xi)) = \Upsilon^C(\mathcal{CFK}^\infty(S^3, U, \mathfrak{u})) = 0,$$

where the last identity follows from the normalization condition on the south-west regions. A careful check with the long exact sequence of the pair reveals that indeed $|G| = \sqrt{|H_1(\Sigma^m(K); \mathbb{Z})|} = \sqrt{\det_m(K)}$, proving the claim. \square

4. HOMOMORPHISMS FROM THE KNOT CONCORDANCE GROUP

The Upsilon-function Υ_K of [26] can be defined along the same ideas, by using special south-west regions. (This reformulation of the invariants is due to Livingston [22].) Indeed, for $t \in [0, 2]$ let us consider the half-plane

$$H_t = \left\{ (x, y) \in \mathbb{R}^2 \mid y \leq \frac{t}{t-2}x \right\}.$$

Since H_t (for the chosen $t \in [0, 2]$) is a south-west region, we get an invariant $\Upsilon^{H_t}(\mathcal{K}_*)$ for any knot type chain complex \mathcal{K}_* . Define $\Upsilon_t(\mathcal{K}_*) = -2 \cdot \Upsilon^{H_t}(\mathcal{K}_*)$. The proof of [22, Theorem 7.2] readily generalizes to this setting, verifying the following proposition.

Proposition 4.1. $\Upsilon_t: \mathcal{CFK}/\sim \rightarrow \mathbb{R}$ is a group homomorphism for each $t \in [0, 2]$. \square

Lemma 2.8, Theorem 3.5 and Proposition 4.1 then imply:

Theorem 4.2. *Let $m = p^r$ be a prime power. For a knot $K \subset S^3$ set $\Upsilon_{K,m}(t) = \Upsilon_t(\mathcal{CFK}^\infty(\Sigma^m(K), \tilde{K}, \mathfrak{s}_0))$. Then the map $K \mapsto \Upsilon_{K,m}(t)$ descends to a group homomorphism $\mathcal{C} \rightarrow C^0[0, 2]$. \square*

One can also form a spin^c refined versions of these invariants.

Theorem 4.3. *Let $m = p^r$ be a prime power. For a knot $K \subset S^3$, and a cohomology class $\xi \in H^2(\Sigma^m(K); \mathbb{Z})$ set*

$$\Upsilon_{K,\xi}(t) = \Upsilon_t(\mathcal{CFK}^\infty(\Sigma^m(K), \tilde{K}, \mathfrak{s}_0 + \xi)).$$

If K and K' are concordant then there exists a subgroup $G \subset H^2(\Sigma^m(K); \mathbb{Z}) \times H^2(\Sigma^m(K'); \mathbb{Z})$ with $|G| = \sqrt{\det_m(K) \cdot \det_m(K')}$ such that $\Upsilon_{K, \xi}(t) = \Upsilon_{K', \xi'}(t)$ for each $(\xi, \xi') \in G$. \square

The following theorem gives obstructions to finite concordance order.

Theorem 4.4. *Let $K \subset S^3$ be a knot and p a prime. Let \mathcal{H}_p denote the set of subgroups of $H^2(\Sigma^2(K); \mathbb{Z})$ of order p . Set*

$$\mathcal{S}_t(K, p) = \min \left\{ \left| \sum_{H \in \mathcal{H}_p} n_H \sum_{\xi \in H} \Upsilon_{K, \xi}(t) \right| : n_H \in \mathbb{Z}_{\geq 0}, \sum_{H \in \mathcal{H}_p} n_H > 0 \right\},$$

If K has finite order in the smooth concordance group then $\mathcal{S}_t(K, p) \equiv 0$.

Proof. A similar statement already appeared in [11], we just follow their argument. If $K \# \dots \# K = 0$ in the knot concordance group then, for some $n > 0$, there is a subgroup $G \subset H^2(\Sigma^2(K); \mathbb{Z}) \times \dots \times H^2(\Sigma^2(K); \mathbb{Z})$ with $|G| = \det(K)^{\frac{n}{2}}$ such that

$$0 = \Upsilon_{K \# \dots \# K, \xi}(t) = \sum_{i=1}^n \Upsilon_{K, \xi_i}(t)$$

for each $\xi = (\xi_1, \dots, \xi_n) \in G$. We used the identity $\Upsilon_{K \# K', \xi + \xi'}(t) = \Upsilon_{K, \xi}(t) + \Upsilon_{K', \xi'}(t)$, which follows from [29, Section 7] and Proposition 4.1.

Given a prime p , if p does not divide $\det(K) = |H^2(\Sigma^2(K); \mathbb{Z})|$ then by Lagrange's theorem $\mathcal{H}_p = \emptyset$. If p does divide $\det(K)$, then it also divides $|G|$ and Cauchy's theorem guarantees the existence of an order p element $\xi = (\xi_1, \dots, \xi_n)$ in G . Thus

$$0 = \sum_{j=0}^{p-1} \Upsilon_{K \# \dots \# K, j \cdot \xi}(t) = \sum_{j=0}^{p-1} \sum_{i=1}^n \Upsilon_{K, j \cdot \xi_i}(t) = \sum_{i=1}^n \sum_{j=0}^{p-1} \Upsilon_{K, j \cdot \xi_i}(t) = \sum_{i=1}^n \sum_{\xi \in H_i} \Upsilon_{K, \xi}(t),$$

where $H_i \subset H^2(\Sigma^2(K); \mathbb{Z})$ denotes the subgroup generated by ξ_i in $H^2(\Sigma^2(K); \mathbb{Z})$. \square

5. ALTERNATING TORUS KNOTS

Alternating torus knots are those of the form $T_{2,p}$ for some odd integer $p = 2n + 1$. The branched double cover of $T_{2,p}$ is the lens space $L(p, 1)$. In what follows, the lift of $T_{2,p}$ along the branched covering $\pi: L(p, 1) \rightarrow S^3$ will be denoted by $\tilde{T}_{2,p}$.

Let $K_{p,q}$ denotes the 2-bridge knot corresponding to $\frac{p}{q}$ (with $p > q > 0$, p odd). Notice that the alternating torus knot $T_{2,2n+1}$ is isotopic to the 2-bridge knot $K_{p,q}$ with parameters $p = 2n + 1$ and $q = 1$. In [10] Grigsby proved the existence¹ of a graded quasi-isomorphism

$$L: \widehat{CFK}(K_{p,q}) \longrightarrow \widehat{CFK}(L(p, q), \tilde{K}_{p,q}, \mathfrak{s}_0), \quad (2)$$

where \mathfrak{s}_0 denotes the only spin structure of $L(p, q)$.

In this section we present a proof of Theorem 1.2 based on combinatorial knot Floer homology (more precisely, grid homology, extended to lens spaces). As suggested by an anonymous referee, this result can alternatively be obtained as a consequence of the work of J. Rasmussen and S. Rasmussen [34, Lemma 3.2].

¹The actual isomorphism is between the ‘‘hat’’ versions of $HF\hat{K}$; we will address the suitable extension in Section 5.1.

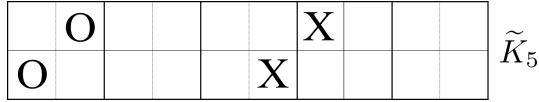

FIGURE 2. The grid G_5 for the lift of $T_{5,2}$ in $L(5, 1)$.

5.1. Combinatorial Knot Floer homology. In [23] Manolescu, Ozsváth and Sarkar gave a combinatorial description of $HF\tilde{K}^\circ$ for knots in the 3-sphere using grid diagrams, cf. also [25]. This construction has been extended by Baker, Grigsby and Hedden to the case of knots in lens spaces. We will recall their definitions in the specific relevant cases, pointing the interested reader to their paper [3].

Given a lens space $L(p, q) = S^3_{-\frac{p}{q}}(\bigcirc)$ with $p > q$ and p odd, there is a distinguished choice for the affine isomorphism between $Spin^c(L(p, q))$ and $H_1(L(p, q); \mathbb{Z})$, when the unique spin structure \mathfrak{s}_0 is identified with the trivial homology class. Therefore in what follows we will adopt the convention of labelling $\mathfrak{s} \in Spin^c(L(p, q))$ by a number $h \in \{-\frac{p-1}{2}, \dots, \frac{p-1}{2}\}$; to such h we associate the $spin^c$ structure corresponding to $h \in H_1(L(p, q); \mathbb{Z}) \cong \mathbb{Z}_p$. Notice that with the conventions above we have that $\overline{\mathfrak{s}_0 + h} = \mathfrak{s}_0 - h$, where the bar denotes the conjugation on $spin^c$ structures.

A *twisted grid diagram* for $L(p, 1)$ is a planar representation of a genus one Heegaard diagram for $L(p, 1)$, produced by the minimally intersecting one by doubling both curves. We choose to draw this diagram as shown in Figure 2, where each little square has edges of length one. This is a $2 \times 2p$ grid, with a specific identification of its boundary: the left and right edges of the grid are identified as $(0, t) \sim (2p, t)$ with $t \in [0, 2]$, while the top part is identified with the bottom after a shift taking $(x, 2)$ to $(x - 2, 0) \pmod{2p}$. The integer n is called the *dimension* of G_p .

By placing in the squares two sets of markings $\mathbb{X} = \{X_0, X_1\}$ and $\mathbb{O} = \{O_0, O_1\}$, we get a twisted grid diagram G_p , which determines a knot K in $L(p, 1)$. It was shown in [9] that if we are considering the lift of a 2-bridge knot to $L(p, q)$, then the resulting knot can be presented as above.

In the case of the lift of $T_{2,2n+1}$ to $L(2n+1, 1)$, we get a $2 \times 2(2n+1)$ grid with $\mathbb{O} = \{0, 1\}$ and $\mathbb{X} = \{2n+1, 2n+2\}$, where the notation means that we are placing the first \mathbb{O} marking in the center of the 0-th square from the left in the bottom-most row of G_p , and the second \mathbb{O} in the first box on the top row, and likewise for the \mathbb{X} s. One example is shown in Figure 2.

Recall that the generators of the knot Floer complex are given by intersections of the α - and β -curves determining the Heegaard splitting. Here the generating set is given by bijections between the horizontal and vertical circles (called α_0, α_1 and β_0, β_1 respectively) in the grid, after the identifications. We require that the two points of a generator lie on different curves.

Since each pair (α_i, β_j) intersect exactly p times, it is easy to show that the generating set $S(G)$ is in bijection with $\mathfrak{S}_2 \times \mathbb{Z}_p^2$. Generators corresponding to $Id_{\mathfrak{S}_2} \times (a_0, a_1)$ will be denoted by x_{a_0, a_1} , while those of the form $(12) \times (a_0, a_1)$ by y_{a_0, a_1} . The two pairs $(a, b) \in \mathbb{Z}_p^2$ will be called the *p-coordinates* of the generator.

Given such a multi-pointed grid G_p , representing the pair $(L(p, 1), \tilde{T}_{2,p})$, the complex $GC^\circ(G_p)$ is the free R° -module generated by $S(G_p)$. The specific choice of the base ring, together with the choice of a differential, will determine the flavour of grid homology we will consider. In what follows we will restrict to $R^\infty = \mathbb{Z}_2[V_0^{\pm 1}, V_1^{\pm 1}]$ or $R^- = \mathbb{Z}_2[V_0, V_1]$, corresponding respectively to the ∞ and minus versions of grid

homology. The variables V_i act on the complex, and can be thus thought of as graded endomorphisms; they correspond to the \mathbb{O} -markings.

Both the Alexander and Maslov degrees $M(x), A(x) \in \mathbb{Q}$ of a generator $x \in S(G_p)$ can be combinatorially defined from the grid as explained in [9]. (Although the A -grading is in general \mathbb{Q} -valued, but $A(x) \in \mathbb{Z}$ for all generators if the knot K is null-homologous, which is always the case for lifts of knots to their cyclic covers.) Finally we can associate to x a spin^c structure $\mathfrak{s}(x) \in \text{Spin}^c(L(p, 1)) \cong \mathbb{Z}_p$ following the recipe of [3, Section 2.2]: if the p -coordinates of x are (a, b) , then $\mathfrak{s}(x) \equiv a + b \pmod{p}$.

Each V_i decreases the Maslov degree by two, the Alexander degree by one, and does not change the spin^c structure. If $V_0^r V_1^s x \in \mathbb{Z}_2[V_0^{\pm 1}, V_1^{\pm 1}]\langle S(G_p) \rangle$, then the number $-r - s$ of V_i variables is called the *algebraic filtration*, and is denoted by $j(V_0^r V_1^s x)$.

The differential for the ∞ flavour is the $\mathbb{Z}_2[V_0^{\pm 1}, V_1^{\pm 1}]$ -chain map defined as follows:

$$\partial^\infty(x) = \sum_{y \in S(G)} \sum_{\substack{r \in \text{Rect}^\circ(x, y) \\ r \cap \mathbb{X} = \emptyset}} V_0^{O_0(r)} V_1^{O_1(r)} \cdot y \quad (3)$$

In Equation (3), $\text{Rect}^\circ(x, y)$ denotes the set of (oriented) empty rectangles r embedded in the grid, such that the edges of r are alternatively on α and β curves, and one component of x is in the lower-left vertex of r ; a rectangle is *empty* if \mathring{r} does not contain any component of x or y . Note that in the expression (3) we are also requiring trivial intersection between rectangles and \mathbb{X} markings.

To obtain the minus flavour, keep the same differential and restrict the base ring to $\mathbb{Z}_2[V_0, V_1]$. If we impose $V_1 = 0$ at the complex level, we obtain a complex computing the hat version of knot Floer homology. These are finitely generated modules, over $\mathbb{Z}_2[U^{\pm 1}]$, $\mathbb{Z}_2[U]$ and \mathbb{Z}_2 respectively. Here U is the map induced in homology by either of the V_i s (and it is not hard to see that multiplication by V_0 and V_1 coincide in homology).

Remark 5.1. *If we fix an intersection point between one α and one β curve, and $i \in \mathbb{Z}_p$, there is only one generator $x \in S(G_p)$ having that intersection as a component, and such that $\mathfrak{s}(x) = i$.*

Remark 5.2. *As alluded in the introduction, the quasi-isomorphisms from [10]*

$$L: \widehat{CFK}(K_{p,q}) \longrightarrow \widehat{CFK}(L(p, q), \tilde{K}_{p,q}, \mathfrak{s}_0)$$

induce quasi-isomorphisms on the other flavours (i.e. the filtered – and ∞ versions) as well. This follows from the fact that L defined at the complex level is a grading preserving isomorphism of bi-graded vector spaces, and in this case both complexes have trivial differential. This implies that there can only be horizontal and vertical differentials, dictated by the spectral sequence to \widehat{HF} of the underlying manifold (which is an L -space in both the domain and codomain of L).

The purpose of the next section will be to use this combinatorial description for a recursive computation of $GC^\infty(L(2n+1, 1), \tilde{T}_{2n+1,2}, \mathfrak{s}_0 + h)$. Recall that thanks to [3, Theorem 1.1], we know that this complex is in fact chain homotopic to its holomorphic counterpart $\mathcal{CFK}^\infty(L(2n+1, 1), \tilde{T}_{2n+1,2}, \mathfrak{s}_0 + h)$.

5.2. Computations. If $p = 2n + 1$ is an odd integer, and $h \in \{0, \dots, n\}$ we want to prove the existence of the following quasi-isomorphisms:

$$CFK^\circ(L(p, 1), \tilde{T}_{2,p}, \mathfrak{s}_0 \pm h) \simeq CFK^\circ(T_{2,p-2h}). \quad (4)$$

Note that there will be a shift in the Maslov grading, given by the difference in the correction terms, which can be computed using the recursive formula in [27, Section 4.1].

We can prove the existence of the isomorphisms in Equation (4) by constructing graded quasi-isomorphisms

$$\tilde{F}_{p,h}: CFK^\circ(L(p, 1), \tilde{T}_{2,p}, \mathfrak{s}_0 + h) \longrightarrow CFK^\circ(L(p - 2h, 1), \tilde{T}_{2,p-2h}, \mathfrak{s}_0),$$

and post composing with the suitable inverse of the isomorphism L . Notice that we can write $\tilde{F}_{p,h}$ as the composition of some more elementary maps

$$F_{p,h}: CFK^\circ(L(p, 1), \tilde{T}_{2,p}, \mathfrak{s}_0 + h) \longrightarrow CFK^\circ(L(p - 2, 1), \tilde{T}_{2,p-2}, \mathfrak{s}_0 + h - 1). \quad (5)$$

shifting the spin^c structure by one and decreasing p by two, as shown in Figure 3. We can define the analogous maps $\bar{F}_{p,h}$ by precomposing $F_{p,h}$ with conjugation on spin^c structures.

The grid complex $GC^\circ(L(p - 2, 1), \tilde{T}_{2,p-2}, \mathfrak{s}_0 + h - 1)$ has four generators less than $GC^\circ(L(p, 1), \tilde{T}_{2,p}, \mathfrak{s}_0 + h)$. We will choose some generators to be removed from the complex associated to $\tilde{T}_{2,p}$ in such a way that we are cancelling precisely the four generators that comprise an acyclic subcomplex, and their cancellation induces the needed quasi-isomorphism.

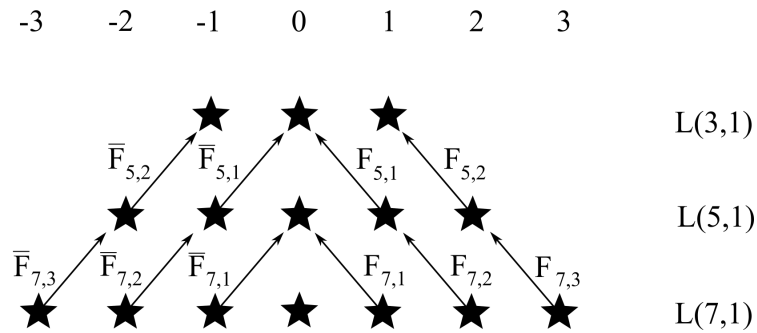

FIGURE 3. How the maps $F_{p,h}$ fit together. The horizontal label denotes the spin^c structures in the lens space written on the right. Stars represent the corresponding knot Floer homology groups.

Let us introduce some objects that will come into play in the proof of Theorem 1.2. These will be some model complexes, quasi-isomorphic to $GC^\circ(L(p, 1), \tilde{T}_{2,p}, \mathfrak{s}_0 + h)$ in a given Alexander degree.

An *electric pole* of length $e \geq 0$ is the graded complex over \mathbb{Z}_2 described in Figure 4. It consists of $2e + 1$ generators and $4e - 2$ differentials, denoted as dots and arrows respectively. If $e = 0$ the pole consists of a single generator. All generators in a pole have the same Alexander degrees.

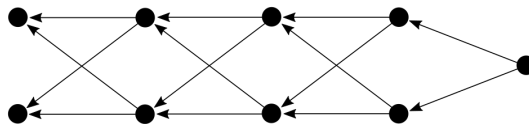

FIGURE 4. An electric pole of length 4. Each dot represents a generator over \mathbb{Z}_2 in the (j, A) -plane, and arrows (from right to left) denote differentials. Edges represent differentials not involving multiplication by any V_i . All generators have the same Alexander degree.

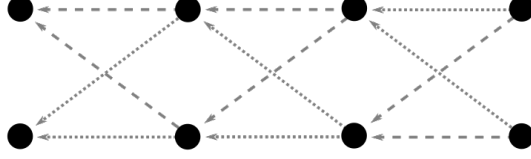

FIGURE 5. A wire of length 3. Dotted arrows are multiplication by V_0 , while dashed by V_1 .

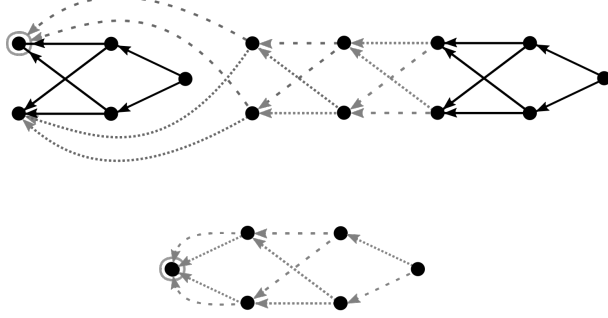

FIGURE 6. In the top part the base complex $C[2,3]$. Black edges denote differentials not involving V_i variables, dotted edges multiplication by V_0 , and dashed by V_1 . The circled generator is the only survivor in homology. In the lower part of the Figure, the case $e = 0$ and $w = 1$ (corresponding to the lift of the trefoil in its spin structure).

A *wire* of length $w > 0$ is a graded complex composed by $2w + 2$ generators and $4w$ differentials, as shown in Figure 5. The differentials in this case carry a label, specifying if they are acting as multiplication by V_0 or V_1 .

We can form a new complex by “fusing” together two electric poles (of the same length) and a wire, obtaining a complex whose homology has rank 1, generated by the circled generator in Figure 6. More formally, consider two electric poles of length e and a wire of length w , and identify the two leftmost generators of one pole with the rightmost of the wire, then identify the two leftmost generators of the other pole with the leftmost of the wire, as depicted in Figure 6. We denote this complex as $C[e, w]$. If $e = 0$, each pole is composed by a single generator, and the two leftmost arrows in the wire converge on the left one, while the rightmost are the differentials of the right one, as shown in the bottom of Figure 6. Note that $C[e, w]$ has $2w + 4e$ generators. We will now prove that the graded complex $GC^\infty(G_p, \mathfrak{s}_0 + h)$ can be built from unions of wires and poles.

Proposition 5.3. *The complex $GC^\infty(L(p, 1), \widetilde{T}_{2,p}, \mathfrak{s}_0 \pm h)$ is quasi-isomorphic to $C[h, p - 2h] \otimes \mathbb{Z}_2[V_0^{\pm 1}, V_1^{\pm 1}]$, which in turn is quasi-isomorphic to $\mathcal{CFK}^\infty(T_{2,p-2h})$.*

This means that the height of the poles is controlled by the “distance” from the spin structure \mathfrak{s}_0 ; in the following proof we are going to show how to shorten each pole without changing the homology, hence proving that the complex is completely determined by the length of its wires.

Proof. As before, let us denote by G_p the grid for the lift of $T_{2,p}$ to $L(p, 1)$. We first need to argue that each generator can have at most 2 differentials emanating from it.

Lemma 5.4. *If x denotes a generator in $S(G_p)$, then there are at most 2 differentials emanating from x .*

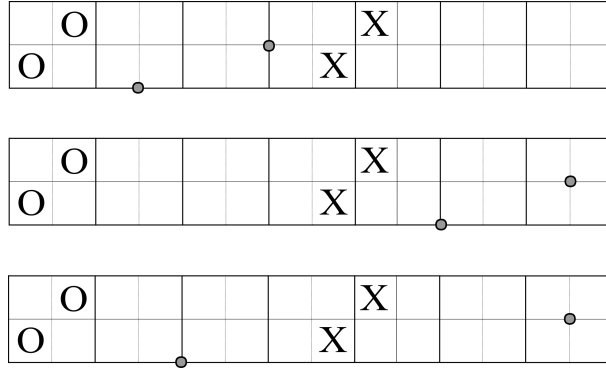

FIGURE 7. In the top, middle and bottom part respectively we have two instances of case A and one of B . The two gray dots indicate the components of the generator.

The proof of the Lemma is deferred to the end of this subsection. We will subdivide the generators of $S(G_p)$ in different families, and give a general formula for the differential on each. First of all note that, since markings of either kind are grouped together, they act as “walls” for rectangles: if the two components of a generator x are intertwined with the \mathbb{X} markings, then every empty rectangle starting from x must intersect an \mathbb{O} marking, resulting in the multiplication by a V_i variable. On the other hand, if the two components are on the same side with respect to some type of marking, the differential of x will be composed by elements with the same property (and there is not going to be any multiplication by V_i). This will not hold for 4 sporadic cases, which will provide the “attachment” between wires and poles.

Let A_p denote the set of generators in $S(G_p)$ whose components do not intertwine with the markings, and B_p the remaining ones. Apart from 4 special cases treated separately, we will prove that each generator $x \in A_p$ has differential of the form $\partial(x) = x' + x''$, for distinct $x', x'' \in A_p$, while if $x \in B_p$, then either $\partial(x) = V_i(x' + x'')$ or $\partial(x) = V_i x' + V_{i+1} x''$ for some i (indices modulo 2). In the remaining sporadic cases, we will also explicitly determine the differential.

Note that we know the number of generators in each spin^c structure, and we will determine explicitly the differential; since we are considering the graded version of GC^∞ , and for a fixed Alexander degree the graph induced by the differential is connected, we only need to determine the degree of one element in order to determine the whole complex $GC^\infty(L(p, 1), \tilde{T}_{2,p}, \mathfrak{s})$.

In all cases it is easy to find two generators connected to x by empty rectangles not intersecting the \mathbb{X} markings. By Lemma 5.4 we know that these are the only ones.

$$\partial(x_{a,b}) = \begin{cases} y_{b,a} + y_{a-1,b+1} & \text{if } x \in A_p, a \leq b \\ y_{a,b} + y_{b-1,a+1} & \text{if } x \in A_p, b \leq a \\ V_0 y_{a,b} + V_1 y_{b-1,a+1} & \text{if } x \in B_p, a \leq b \\ V_0 y_{b,a} + V_1 y_{a-1,b+1} & \text{if } x \in B_p, b \leq a \end{cases}$$

$$\partial(y_{a,b}) = \begin{cases} x_{b,a} + x_{a,b} & \text{if } y \in A_p, a \leq b \\ x_{a+1,b-1} + x_{b-1,a+1} & \text{if } y \in A_p, b \leq a \\ V_1(x_{a-1,b+1} + x_{b-1,a+1}) & \text{if } y \in B_p, a \leq b \\ V_0(x_{a,b} + x_{b,a}) & \text{if } y \in B_p, b \leq a \end{cases}$$

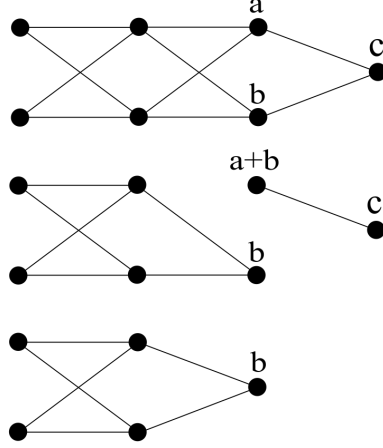

FIGURE 8. A change of basis: $a' = a + b$, $b' = b$. Cancelling the acyclic pair $(c, a + b)$ lowers the height of an electric pole by 1.

For each spin^c structure $\mathfrak{s}_0 \pm h$, with $h \neq 0$, we can find 4 generators with a slightly different behaviour. These are the generators such that one component is positioned on the lower left vertex of a square containing an \mathbb{X} or an \mathbb{O} marking. We can write them as $y_{\frac{p-1}{2},*}, y_{*,\frac{p+1}{2}}$ in the case of \mathbb{X} markings, and $x_{0,*}, x_{*,0}$ for the \mathbb{O} 's. The values of $*$ and $*'$ are uniquely determined by h . Their differentials are:

$$\partial(z) = \begin{cases} 0 & \text{if } z = y_{\frac{p-1}{2},*} \\ 0 & \text{if } z = y_{*,\frac{p-1}{2}+1} \\ V_0 y_{*,0} + V_1 y_{p-1,*+1} & \text{if } z = x_{0,*} \text{ or } z = x_{*,0} \end{cases}$$

Putting all differentials together, we see that, in a fixed Alexander degree the complex $GC^\infty(L(p, 1), \tilde{T}_{2,p}, \mathfrak{s}_0 \pm h)$ is indeed composed by two electric poles of height h , attached to a wire of length $p - 2h$, as shown in Figure 6.

It follows that $\mathcal{CFK}^\infty(L(p, 1), \tilde{T}_{2,p}, \mathfrak{s}_0 \pm h)$ is isomorphic to the free $\mathbb{Z}_2[U, U^{-1}]$ -module generated by $C[h, p - 2h]$.

Now we just need to prove that $C[h, p - 2h]$ has the same homology as that of $\mathcal{CFK}^\infty(T_{2,p-2h})$; this can be done by defining at the grid level the quasi-isomorphisms $F_{p,h}$.

However, it is immediate to note that the change of basis shown in Figure 8 induces a quasi-isomorphism between $C[h, p - 2h]$ and $C[h - 1, p - 2h]$.

In other words, by iterating this process h times, we have proved that

$$C[e, w] \simeq C[0, w]. \quad (6)$$

Similar quasi-isomorphisms were used in [5], dealing with a different family of knots in $L(p, 1)$. The idea now is that by composing h of these maps, we obtain a chain of quasi-isomorphisms from the complex in the spin^c structure $\mathfrak{s}_0 + h$ to the complex in the spin structure \mathfrak{s}_0 in $L(p - 2h, 1)$. Summing all up, we have proved the existence of the following chain of quasi-isomorphisms:

$$GC^\infty(L(p, 1), \tilde{T}_{2,p}, \mathfrak{s}_0 \pm h) \simeq C[h, p - 2h] \otimes \mathbb{Z}_2[V_0, V_1] \simeq C[0, p - 2h] \otimes \mathbb{Z}_2[V_0, V_1] \simeq GC^\infty(L(p - 2h, 1), \tilde{T}_{2,p-2h}, \mathfrak{s}_0) \simeq \mathcal{CFK}^\infty(L(p - 2h, 1), \tilde{T}_{2,p-2h}, \mathfrak{s}_0) \simeq \mathcal{CFK}^\infty(T_{2,p-2h}),$$

where

- the first quasi-isomorphism is given by explicitly determining the differential of the first complex;
- the second one is given by shortening the electric poles with the h applications of the basis change in Figure 8;
- the third is just the inverse of the first one;
- the fourth one is [3, Theorem 1.1];
- the last quasi-isomorphism is Grigsby's L .

□

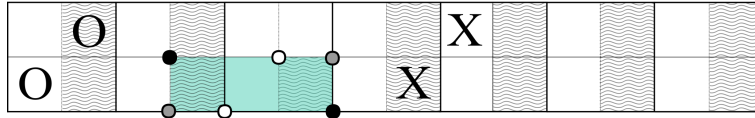

FIGURE 9. The rectangles with wavy and filled patten start from the lower component of the gray generator and connect it to the white and black ones respectively. Only the first one has trivial intersection with the \mathbb{X} markings.

Proof of Lemma 5.4. It is easy to argue that for a rectangle in G_p to be empty, it must necessarily have either height or length equal to 1 (recall that the top/bottom identification is a shift by 2). So there can be at most 4 rectangles starting from a generator $x \in S(G_p)$. We want to show that only two of them are disjoint from the \mathbb{X} markings.

Consider the two rectangles starting from a generator, as in Figure 9. If we assume that the “horizontal” rectangle does not intersect the \mathbb{X} markings, then necessarily the other one will, and vice versa. □

5.3. Consequences. In the case of alternating knots, invariants coming from Knot Floer homology usually do not yield any interesting information. The following result, despite being well-known [20], points out an interesting way of showing that HFK can be used to extract useful information from alternating knots as well.

Theorem 5.5. *The alternating torus knots $T_{2,p}$ with p an odd prime are linearly independent in the concordance group.*

Proof. Let K be of the form $K_+ \# K_-$ with $K_+ = \#_i a_i T_{2,2n_i+1}$ and $K_- = -\#_j b_j T_{2,2m_j+1}$, $a_i, b_j > 0$, $n_i, m_j \geq 1$ prime and all distinct. Set $G = H_1(\Sigma(K), \mathbb{Z})$, $G_+ = H_1(\Sigma(K_+), \mathbb{Z}) = \bigoplus_i (\mathbb{Z}/(2n_i + 1)\mathbb{Z})^{a_i}$, and $G_- = H_1(\Sigma(K_-), \mathbb{Z}) = \bigoplus_j (\mathbb{Z}/(2m_j + 1)\mathbb{Z})^{b_j}$.

Assume that $K \sim \bigcirc$, then $\tau_{\mathfrak{s}_0 + \xi}(K) = 0$ for all $\xi \in M$ for some $M \subset G$ with $|M| = \sqrt{|G|}$. Write $\xi = (\xi_+, \xi_-)$, with $\xi_{\pm} \in G_{\pm}$. Because of the additivity of the τ

invariant, one has

$$\begin{aligned}
\tau_{\mathfrak{s}_0+\xi}(K) &= \tau_{\mathfrak{s}_0+\xi_+}(\#_i a_i T_{2,2n_i+1}) - \tau_{\mathfrak{s}_0+\xi_-}(\#_j b_j T_{2,2m_j+1}) \\
&= \sum_i a_i \tau_{\mathfrak{s}_0+\xi_i^+}(T_{2,2n_i+1}) - \sum_j b_j \tau_{\mathfrak{s}_0+\xi_j^-}(T_{2,2m_j+1}) \\
&= \sum_i a_i \tau(T_{2,2n_i+1-2|\xi_i^+|}) - \sum_j b_j \tau(T_{2,2m_j+1-2|\xi_j^-|}) \\
&= \sum_i a_i (n_i - |\xi_i^+|) - \sum_j b_j (m_j - |\xi_j^-|) \\
&= \left(\sum_i a_i n_i - \sum_j b_j m_j \right) - \left(\sum_i a_i |\xi_i^+| - \sum_j b_j |\xi_j^-| \right)
\end{aligned}$$

Thus, if K is slice, the quantity

$$H(\xi) = \sum_i a_i |\xi_i^+| - \sum_j b_j |\xi_j^-| \quad \xi \in M \quad (7)$$

should be constant. In fact, since by Theorem 1.2 for $\xi = 0$ one has $H(0) = \tau(K) = \sum_i a_i n_i - \sum_j b_j m_j = 0$, for $\xi \in M$ we have $H(\xi) \equiv 0$. On the other hand, because of the assumption on the coefficients of the torus knots being primes, one can find non-zero $\xi \in M$ of the form $\xi = (\xi_+, 0)$. However, for such a ξ one has $H(\xi) > 0$, and we reach a contradiction. \square

Remark 5.6. *The argument given above (and indeed, the statement of Theorem 5.5) is not optimal. The same argument works if in a family $T_{2,2n_i+1}$ all $2n_i+1$ are powers of different primes. The fact that all alternating torus knots are linearly independent, however, requires a more subtle group theoretic result, which we do not pursue here.*

Remark 5.7. *Using a result by Raoux [32], we can determine the slice genus of the lifts $\tilde{T}_{2,p}$. Here by slice genus $g_*(K)$ of a knot $K \subset L(p, 1)$, we mean the minimal genus of a smooth and properly embedded surface Σ in $(W_p, L(p, 1))$, and such that $\partial\Sigma = K$, where W_p is the Euler number p disk bundle over S^2 .*

If $K \subset S^3$ bounds a smooth slice surface S of genus g , then its lift $\tilde{K} \subset \Sigma(K)$ will bound a genus g surface in the double branched cover of D^4 over S , obtained by lifting S . Hence $g_(\tilde{T}_{2,p}) \leq n = \frac{1}{2}(p-1)$. On the other hand, since $\tau^s(K) \leq g_*(K)$ for every spin^c structure that extends to W_p , as does \mathfrak{s}_0 , using [32, Corollary 5.4] we have $g_*(\tilde{T}_{2,p}) = n$.*

Remark 5.8. *By [5, Proposition 25], the knots $\tilde{T}_{2,p}$ are not concordant to local knots. Also, by [5, Theorem 4] the genus of a PL surface cobounding $\tilde{T}_{2,p}$ and \bigcirc in $L(p, 1) \times I$ is at least n . Here, by PL surface, we mean a surface which is smooth everywhere, except for a finite number of singular points, which are cones over knots in S^3 .*

6. FURTHER EXAMPLES WITH (1,1)-KNOTS

In this section we perform some further computations for invariants in double branched covers for knots given by genus one doubly pointed Heegaard diagrams — such knots are known as (1,1)-knots [33]. Based on these computations we give an alternative proof of Theorem 5.5, and prove an independence result about twist knots.

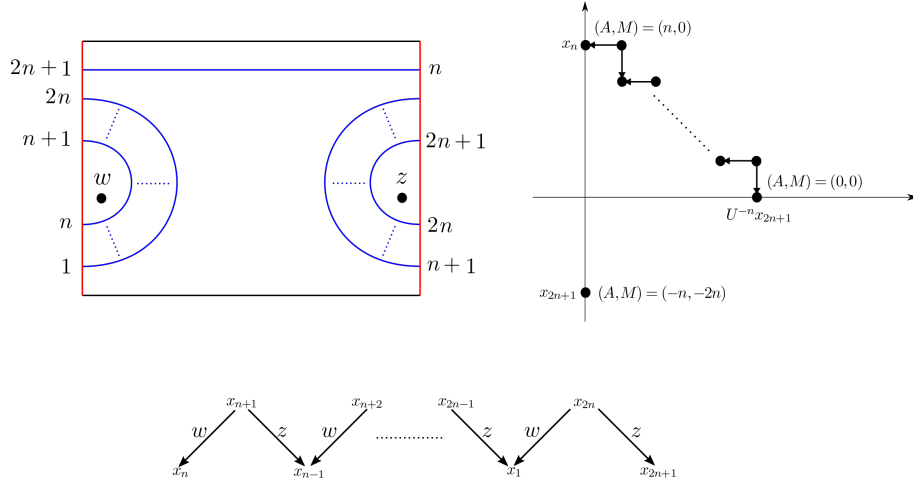

FIGURE 10. On the left, the $(1, 1)$ -diagram of the torus knot $T_{2, 2n+1}$ is given; we get the toroidal diagram after identifying the top and the bottom edges, as well as the right and left edges, in the latter identification we apply a shearing, so that points with equal label match. On the right we show the chain complex (all dots and arrows should be shifted by (k, k) ($k \in \mathbb{Z}$) for the complete picture), and in the lower part the boundary map is shown. As usual, the intersection point i corresponds to the generator x_i . (The letter w or z over an arrow indicates that the corresponding bigon contains the basepoint shown.) Note that in the notation of the picture we have $HFK^-(T_{2, 2n+1}) \simeq \mathbb{Z}_2[U] \oplus \mathbb{Z}_2^n$, where the first summand is generated by x_{2n+1} , and the latter by x_1, \dots, x_n .

6.1. $(1, 1)$ -diagrams of alternating torus knots. Note first that the alternating torus knot $T_{2, 2n+1}$ can be given by the toroidal doubly pointed Heegaard diagram in the top-left of Figure 10. The generators of the chain complex of $\mathcal{CFK}^\infty(K)$ for a $(1, 1)$ -knot are easy to determine: these are the intersection points of the unique α - and the unique β -curve. The boundary map is defined by counting holomorphic maps from the unit disk \mathbb{D} to the Heegaard torus T^2 , with the usual (Floer theoretic) boundary conditions. The map $\mathbb{D} \rightarrow T^2$ is not necessarily injective, but once we pass to the universal cover \mathbb{C} of T^2 (and lift one of the intersection points to one of its preimages), the boundary map can be determined by identifying embedded bigons in the universal cover. As we will see, in some cases it is sufficient to consider one or two fundamental domains, making the computation much simpler.

From Figure 10 one can easily find the chain complex $\mathcal{CFK}^\infty(T_{2, 2n+1})$, shown in the lower part of Figure 10. The generator corresponding to the intersection point $i \in \{1, \dots, 2n+1\}$ is denoted by x_i for $i = 1, \dots, 2n+1$, and the boundary maps are given by the bigons visible on the picture. (There are no more non-trivial components of the boundary map, since the Maslov index one domains connecting any further pairs contain regions of negative multiplicity.)

The double branched cover $\Sigma(T_{2, 2n+1})$ is a 3-manifold diffeomorphic to the lens space $L(2n+1, 1)$. The lift of the branch curve $T_{2, 2n+1} \subset S^3$ provides a null-homologous knot $\tilde{T}_{2, 2n+1} \subset \Sigma(T_{2, 2n+1})$. The pullback of $\alpha, \beta \subset T^2$ to the double branched cover will be denoted by α_1, α_2 and β_1, β_2 . In this way we get a genus-2 Heegaard diagram $\mathcal{H} = (\Sigma_2, \{\alpha_1, \alpha_2\}, \{\beta_1, \beta_2\})$ for $\Sigma(T_{2, 2n+1})$, as Σ_2 is the double branched cover of the torus branched in z and w . The intersection points $\mathbb{T}_\alpha \cap \mathbb{T}_\beta$ can be easily described as follows. Let a_i, b_i denote the two points over x_i , and assume that $a_i \in \alpha_1$ (and so

$b_i \in \alpha_2$). We also assume that $a_1 \in \alpha_1 \cap \beta_1$ (and hence $b_1 \in \alpha_2 \cap \beta_2$). There are two types of points x_i : we say that x_i is *homogeneous* if $a_i \in \beta_1$ (so by our choice x_1 is homogeneous) and *inhomogeneous* if $a_i \in \beta_2$.

Since the bigons in the fundamental domain appearing in the boundary maps all lift to rectangles (all these bigons contain a unique basepoint), they connect homogeneous points with inhomogeneous ones, hence we conclude that x_1, \dots, x_n and x_{2n+1} are homogeneous and x_{n+1}, \dots, x_{2n} are inhomogeneous.

This shows that the pull-back diagram in the double branched cover has $(n+1)^2 + n^2$ generators in the Heegaard Floer chain complex: these are $\{(a_i, b_j)\}$ where either both x_i, x_j are homogeneous or both inhomogeneous. It is easy to see that (a_i, b_i) and (a_j, b_j) are in the same spin^c structure (since the bigons connecting the various x_i 's lift to rectangles connecting the various (a_i, b_i) 's). Indeed

Lemma 6.1. *The generators (a_i, b_i) represent the spin structure \mathfrak{s}_0 of $\Sigma(T_{2,2n+1})$. The pairs (a_i, b_j) and (a_k, b_ℓ) represent the same spin^c structure if and only if $i - j = k - \ell$.*

Proof. The elements (a_i, b_i) all represent the same spin^c structure since they can be connected by domains (the pull-backs of the bigons from downstairs), and since this spin^c structure is conjugation invariant, it must be the unique spin structure \mathfrak{s}_0 . Now we can compare the spin^c structure of (a_i, b_j) to that of (a_i, b_i) : the difference will be represented by the lift of the 1-homology in the torus we get by connecting x_i to x_j on the α -curve and x_j to x_i on the β -curve. This implies that the spin^c structure of (a_i, b_j) is given by twisting \mathfrak{s}_0 with $(j - i)$ -times a generator of H_1 of the double branched cover, which concludes the proof. \square

Recall that the pairs come with Alexander and Maslov gradings, and indeed the Alexander gradings are relatively easy to compute in terms of the Alexander gradings of the x_i 's.

Lemma 6.2 (Levine, [18]). *The Alexander grading $A(a_i, b_j)$ of (a_i, b_j) is equal to $\frac{1}{2}(A(x_i) + A(x_j))$. In particular, $A(a_n, b_n) = n$, $A(a_{2n+1}, b_{2n+1}) = -n$ and for all further generator $|A(a_i, b_j)| < n$. \square*

The knot Floer complex for $(\Sigma(T_{2,2n+1}), \widetilde{T}_{2,2n+1}, \mathfrak{s}_0)$ for the spin structure \mathfrak{s}_0 is actually isomorphic to the knot Floer complex of $T_{2,2n+1} \subset S^3$: all non-trivial components of ∂ in $\mathcal{CFK}^\infty(T_{2,2n+1})$ are defined by bigons in the fundamental domain of the $(1, 1)$ -diagram we are working with, and these bigons lift to rectangles in the double branched cover (since each bigon contains a unique z or w), hence we get the same maps upstairs in $\mathcal{CFK}^\infty(\Sigma(T_{2,2n+1}), \widetilde{T}_{2,2n+1}, \mathfrak{s}_0)$. The same argument as for $T_{2,2n+1} \subset S^3$ then applies and shows that there are no more non-zero components of the boundary map upstairs: any domain with Maslov index 1 connecting further pairs of generators has some negative multiplicity. In this way we get the Υ -invariant of $(\Sigma(T_{2,2n+1}), \widetilde{T}_{2,2n+1}, \mathfrak{s}_0)$.

Proof of Theorem 5.5. The proof is essentially the same as the proof given at the end of Section 5: for a relation we consider the double branched cover along the slice knot, which admits a filling by a rational homology disk, and for all spin^c structures extending from the double branched cover to this 4-manifold, the same linear combination of Υ -functions as in the relation must vanish. The spin structure extends, hence we get one relation, and then we find an element of the form $(h_+, 0)$ in the metabolizer $G_+ \oplus G_- = G$, where h_+ has some non-zero component. By Lemma 6.2 at that component we replace the corresponding value of $\Upsilon(1)$ with some smaller value, which will result in violating Equation (7), concluding the proof. \square

6.2. **Twist knots.** The $(1, 1)$ -diagram of Figure 11 provides a doubly pointed Heegaard diagram for the twist knot TW_n . The parameter $n > 0$ is chosen so, that TW_1 is the (right-handed) trefoil knot and TW_2 is the Figure-8 knot.

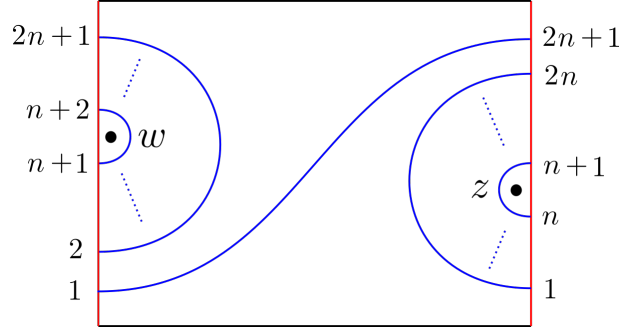

FIGURE 11. $(1, 1)$ -diagram of the twist knot TW_n

In particular, the determinant $\det(TW_n)$ is equal to $2n + 1$, and for n odd we have

$$\Delta_{TW_n}(t) = \frac{n+1}{2}t - n + \frac{n+1}{2}t^{-1},$$

while for n even

$$\Delta_{TW_n}(t) = -\frac{n}{2}t + (n+1) - \frac{n}{2}t^{-1}.$$

Furthermore, the signature $\sigma(TW_n) = -1$ if n is odd, and $\sigma(TW_n) = 0$ if n is even.

From the diagram we can easily determine the chain complex \mathcal{CFK}^∞ . This can be done by analyzing the bigons in the universal cover of the $(1, 1)$ -diagram – in this particular case, in fact, two fundamental domains will suffice to contain all relevant bigons, see Figure 12.

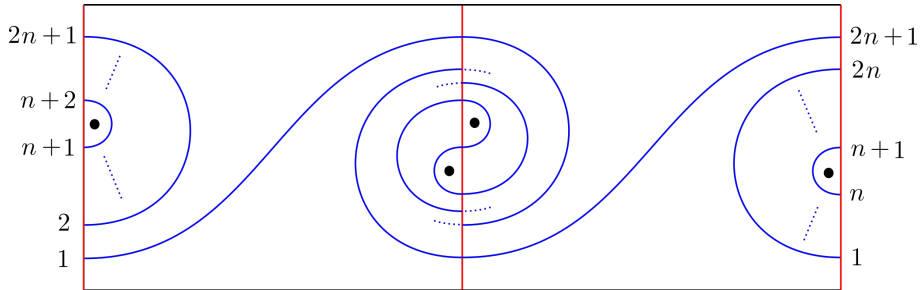

FIGURE 12. Two fundamental domains in the universal cover of the $(1, 1)$ -diagram of TW_n .

For the schematic picture of the chain complex see Figure 13. Denoting the intersection point corresponding to i by x_i again, we get the following:

Lemma 6.3. *The Alexander grading $A(x_i)$ of x_i is*

- 0 if $i \equiv n + 1 \pmod{2}$,
- 1 if $i \equiv n \pmod{2}$ and $i > n + 1$, and
- -1 if $i \equiv n \pmod{2}$ and $i < n + 1$.

Proof. Recall that $A(\mathbf{x}) - A(\mathbf{y}) = n_z(\phi) - n_w(\phi)$ for a domain ϕ connecting \mathbf{x} and \mathbf{y} . If there is an arrow from x_i to x_j , then $A(x_i) - A(x_j) = 1$ if the arrow is decorated by z and is equal to -1 if the decoration of the arrow is w . Since on the vertical paths of Figure 13 the decorations alternate, and (by symmetry) $A(x_{n+1}) = 0$, the claim follows at once. \square

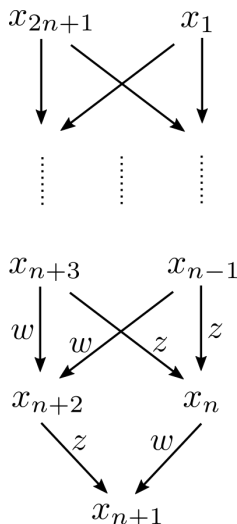

FIGURE 13. The chain complex of the twist knot TW_n . We use the same conventions as in Figure 10. Recall that the decorations z or w over the arrows indicate which basepoint is crossed by the bigon corresponding to the particular component of the boundary.

As before, in the double branched cover the α - and the β -curves lift to α_1, α_2 and β_1, β_2 . Similarly, each intersection point x_i gives rise to two intersections a_i and b_i . We will follow the convention that $a_i \in \alpha_1$, $b_i \in \alpha_2$, and moreover $a_1 \in \beta_1$. Then it is not hard to see that $a_i \in \alpha_1 \cap \beta_1$ if and only if i is odd (and then $b_i \in \alpha_2 \cap \beta_2$) and for even i we have $a_i \in \alpha_1 \cap \beta_2$ and $b_i \in \alpha_2 \cap \beta_1$. Consequently the generators of the Heegaard Floer chain complex of the double branched cover are of the form (a_i, b_j) with the constraint that $i \equiv j \pmod{2}$.

According to the earlier cited result of Levine, we have that $A(a_i, b_j) = \frac{A(x_i) + A(x_j)}{2}$.

Lemma 6.4. *The spin^c structure $\mathfrak{s}(a_i, b_j)$ can be determined as follows:*

- (a_i, b_j) represents the spin structure \mathfrak{s}_0 on $\Sigma(TW_n)$ if and only if $i = j$, and
- (a_i, b_j) and (a_k, b_ℓ) are in the same spin^c structure if and only if $i - j = k - \ell$.

Proof. The proof is the direct adaptation of the proof of Lemma 6.1. \square

A simple corollary of the above provides:

Corollary 6.5. *Suppose that $|i - j| > n + 1$. Then $A(a_i, b_j) = 0$.* \square

According to the last corollary, for $n \geq 1$ there is always a spin^c structure where all generators have $A = 0$, hence the Upsilon-function is constantly zero.

On the other hand, as in the case of torus knots, we immediately see that in the spin structure \mathfrak{s}_0 the chain complex $\mathcal{CFK}^\infty(\Sigma(TW_n), \widehat{TW}_n, \mathfrak{s}_0)$ is isomorphic to $\mathcal{CFK}^\infty(TW_n)$. Indeed, the previous lemma shows a bijection between the generators, and all bigons of the fundamental domain lift to an embedded rectangle, providing non-trivial boundary maps. (The further non-zero components then are forced by the fact that $\partial^2 = 0$.)

Independence of the family $\{TW_n\}_{n>0, n \neq 4}$ was first established in [4], and can be deduced from Lisca's work [19]. The above data suffice to show a weaker result about linear independence in the concordance group:

Proposition 6.6. *The family $\{TW_p \mid p \text{ odd and } 2p + 1 \text{ is prime}\}$ forms a set of linearly independent elements in the smooth concordance group \mathcal{C} .*

Proof. As in the case of torus knots, suppose that there exists a linear dependence $\sum_i k_i TW_{p_i} \sim 0$, and rewrite it as $\sum m_i TW_{p_i} - \sum n_j TW_{q_j} \sim 0$ with $m_i, n_j > 0$.

The double branched cover Y (which is the appropriate connected sum of the double branched covers of the individual knots TW_p), bounds a rational homology ball, hence in $H_1(Y; \mathbb{Z})$ there is a metabolizer M as before. Once again, we write M as $M_+ \oplus M_-$.

Notice that since the spin structure extends, we have that $\sum m_i - \sum n_j = 0$, or equivalently

$$\sum m_i = \sum n_j. \quad (8)$$

(This would also follow from the signature values of the knots since we assumed that all p are odd.)

Now suppose that (h_+, h_-) is a non-zero element in the metabolizer M . By the same argument as in the proof of Theorem 5.5, an appropriate multiple of this element looks like $(0, h'_-)$ (or $(h'_+, 0)$, but the two cases are completely symmetric). By eventually taking a further multiple, we can assume that at least one component of h'_- is in a spin^c structure where all generators have Alexander grading equal to zero, hence the Υ -function in that spin^c structure is identically zero.

This provides the desired contradiction, since in Equation (8) we do not change the left hand side, but delete some (strictly positive) terms from the right hand side, hence the resulting expression does not hold anymore, contradicting the fact that the spin^c structure extends to the rational homology 4-ball. \square

Remark 6.7. *We expect that for n even the knot $\widetilde{TW}_n \subset \Sigma(TW_n)$ has constant zero Υ -function in every spin^c structure.*

REFERENCES

- [1] A. Alfieri. Upsilon type concordance invariants. arXiv:1709.01594.
- [2] A. Alfieri. Deformations of lattice cohomology and the epsilon invariant. *In preparation*, 2018.
- [3] K. Baker, E. Grigsby, and M. Hedden. Grid diagrams for lens spaces and combinatorial knot Floer homology. *International Mathematics Research Notices*, 2008, 2008.
- [4] A. Casson and C. Gordon. On slice knots in dimension three. In *Algebraic and geometric topology (Proc. Sympos. Pure Math., Stanford Univ., Stanford, Calif., 1976), Part 2*, Proc. Sympos. Pure Math., XXXII, pages 39–53. Amer. Math. Soc., Providence, R.I., 1978.
- [5] D. Celoria. On concordances in 3-manifolds. *J. Topol.*, 11(1):180–200, 2018.
- [6] D. Celoria and A. Lecuona. Alternating knots and double branched covers. *In preparation*, 2019.
- [7] Jae Choon Cha. The structure of the rational concordance group of knots. 182, 2007.
- [8] P. Ghiggini. Knot Floer homology detects genus-one fibred knots. *American Journal of Mathematics*, pages 1151–1169, 2008.
- [9] E. Grigsby. Combinatorial description of knot Floer homology of cyclic branched covers. *arXiv preprint math/0610238*, 2006.
- [10] E. Grigsby. Knot Floer homology in cyclic branched covers. *Algebraic & Geometric Topology*, 6(3):1355–1398, 2006.
- [11] E. Grigsby, D. Ruberman, and S. Strle. Knot concordance and Heegaard Floer homology invariants in branched covers. *Geometry & Topology*, 12(4):2249–2275, 2008.
- [12] K. Hendricks and J. Hom. A note on knot concordance and involutive knot Floer homology. arXiv:1708.06389, 2017.
- [13] K. Hendricks and C. Manolescu. Involutive Heegaard Floer homology. *Duke Math. J.*, 7:1211–1299, 2017.
- [14] Matthew Hogancamp and Charles Livingston. An involutive epsilon knot invariant. *arXiv preprint arXiv:1710.08360*, 2017.
- [15] J. Hom. Bordered Heegaard Floer homology and the tau-invariant of cable knots. *Journal of Topology*, 7:287–326, 2014.
- [16] J. Hom. A survey on Heegaard Floer homology and concordance. *Journal of Knot Theory and Its Ramifications*, 26(02):1740015, 2017.

- [17] J. Hom, A. Levine, and T. Lidman. Knot concordance in homology cobordisms. *arXiv preprint arXiv:1801.07770*, 2018.
- [18] A. Levine. Computing knot Floer homology in cyclic branched covers. *Algebraic & Geometric Topology*, 8(2):1163–1190, 2008.
- [19] P. Lisca. Sums of lens spaces bounding rational balls. *Algebraic & Geometric Topology*, 7(4):2141–2164, 2007.
- [20] R. Litherland. Signatures of iterated torus knots. In *Topology of low-dimensional manifolds*, pages 71–84. Springer, 1979.
- [21] C. Livingston. Seifert forms and concordance. *Geometry & Topology*, 6(1):403–408, 2002.
- [22] C. Livingston. Notes on the knot concordance invariant ϵ . *Algebr. Geom. Topol.*, 17(1):111–130, 2017.
- [23] C. Manolescu, P. Ozsváth, and S. Sarkar. A combinatorial description of knot Floer homology. *Annals of Mathematics*, pages 633–660, 2009.
- [24] Y. Ni. Knot Floer homology detects fibred knots. *Inventiones Mathematicae*, 3:577–608, 2007.
- [25] P. Ozsváth, A. Stipsicz, and Z. Szabó. *Grid homology for knots and links*, volume 208 of *Mathematical Surveys and Monographs*. American Mathematical Society, Providence, RI, 2015.
- [26] P. Ozsváth, A. Stipsicz, and Z. Szabó. Concordance homomorphisms from knot Floer homology. *Adv. Math.*, 315:366–426, 2017.
- [27] P. Ozsváth and Z. Szabó. Absolutely graded Floer homologies and intersection forms for four-manifolds with boundary. *Advances in Mathematics*, 173(2):179–261, 2003.
- [28] P. Ozsváth and Z. Szabó. Holomorphic disks and genus bounds. *Geometry and Topology*, 8:311–334, 2004.
- [29] P. Ozsváth and Z. Szabó. Holomorphic disks and knot invariants. *Advances in Mathematics*, 8:58–116, 2004.
- [30] P. Ozsváth and Z. Szabó. Holomorphic triangles and invariants for smooth four-manifolds. *Advances in Mathematics*, 202:326–400, 2006.
- [31] I. Petkova. Cables of thin knots and bordered Heegaard Floer homology. *Quantum Topol.*, 4(4):377–409, 2013.
- [32] K. Raoux. τ -invariants for knots in rational homology spheres. *arXiv preprint arXiv:1611.09415*, 2016.
- [33] J. Rasmussen. Floer homology and knot complements. arXiv: math/0306378, 2003.
- [34] Jacob Rasmussen and Sarah Dean Rasmussen. Floer simple manifolds and l -space intervals. *Advances in Mathematics*, 322:738–805, 2017.
- [35] V. Turaev. Torsion invariants of Spin^c -structures on 3-manifolds. *Math. Res. Lett.*, 4(5):679–695, 1997.
- [36] I. Zemke. Connected sums and involutive knot Floer homology. arXiv:1705.01117, 2017.

UNIVERSITY OF BRITISH COLUMBIA, MATHEMATICS DEPARTMENT, 1984 MATHEMATICS RD, VANCOUVER, BC V6T 1Z2, CANADA

Email address: `alfieriantonio90@gmail.com`

MATHEMATICAL INSTITUTE, UNIVERSITY OF OXFORD, RADCLIFFE OBSERVATORY QUARTER, WOODSTOCK RD, OXFORD OX2 6GG, UK

Email address: `Daniele.Celoria@maths.ox.ac.uk`

RÉNYI INSTITUTE OF MATHEMATICS, 1053. BUDAPEST, REÁLTANODA UTCA 13-15. HUNGARY

Email address: `stipsicz@renyi.hu`