

POLYNOMIAL MIXING TIME OF EDGE FLIPS ON QUADRANGULATIONS

Alessandra Caraceni, Alexandre Stauffer

Abstract

We establish the first polynomial upper bound for the mixing time of random edge flips on rooted quadrangulations: we show that the spectral gap of the edge flip Markov chain on quadrangulations with n faces admits, up to constants, an upper bound of $n^{-5/4}$ and a lower bound of $n^{-11/2}$. In order to obtain the lower bound, we also consider a very natural Markov chain on plane trees – or, equivalently, on Dyck paths – and improve the previous lower bound for its spectral gap by Shor and Movassagh.

1 Introduction

Our work on quadrangulation edge flips places itself in the midst of a developing area of research whose origin can be partly traced back to a question of Aldous about triangulations of the n -gon, a combinatorial structure which he studied in detail [1]. The question concerns a discrete time edge flip Markov chain analogous to the one we will introduce, defined on the state space of triangulations of the regular n -gon (i.e. on the possible sets of diagonals which partition the n -gon into triangular regions); a single step of the Markov chain consists, given a triangulation, in picking a diagonal at random, deleting it and replacing it with the opposite diagonal in the quadrilateral created by its absence. One would wish to analyse the growth of the mixing time of this chain (which is sometimes referred to as the *triangulation walk*) as a function of the size n of the triangulation (or, equivalently, of the size of the state space, which is exponential in n). Aldous conjectures an upper bound of $n^{3/2}$ (up to logarithmic factors in n) for the order of the relaxation time of this chain. In connection to this problem, he conjectures the same upper bound for a chain defined on n -cladograms, a type of binary tree structure with labelled leaves whose relevance also lies its role as a formalisation of *phylogenetic trees* from biological systematic, which model evolutionary relationships between species [2].

An important feature of triangulations of the n -gon is that they are counted by Catalan numbers: the number of triangulations of the n -gon is C_{n-2} , where $C_n = \frac{1}{n+1} \binom{2n}{n}$. In fact, there is an extreme abundance of combinatorial structures which are counted by Catalan numbers, from Dyck paths to strings of matched parentheses to plane trees and beyond, with a thriving net of explicit bijections weaved between them, which often highlight surprising connections between the geometric features of different objects.

It seems therefore natural to attempt a systematic study of Markov chains defined on Catalan structures, but this task has proved very hard. For one thing, the natural notion of adjacency for different Catalan structures does not always translate well via sensible bijections, which gives rise to a rich panorama of different chains one might consider. But even concentrating on a single Markov chain has proved challenging so far, as attested by the relative scarceness of tight bounds

for their mixing times, one notable exception being Wilson’s result [22] for adjacent transpositions on Dyck paths.

Twenty years after a serious effort was started on this kind of problems, we still do not have tight bounds for the mixing of the chains proposed by Aldous. Molloy, Reed and Steiger showed an $\Omega(n^{\frac{2}{3}})$ lower bound for the mixing time of the triangulation walk [17], while the best upper bound to date is McShine and Tetali’s $O(n^4)$ obtained in [14], where they analyse Markov chains on a number of other Catalan structures. As for n -cladograms, Schweinsberg has improved Aldous’s upper bound of $O(n^3)$ for the relaxation time [2] to $O(n^2)$ [20]; also note Löhrr, Mytnik and Winter’s work on the chain in the diffusion limit [13]. Furthermore, recent results for the mixing of a very natural chain on Dyck paths were obtained by Cohen, Tetali and Yeliussizov [8] by rephrasing it as a basis exchange walk on a balanced matroid.

On the other hand, for many natural chains on Catalan structures and related objects not even a polynomial upper bound for the mixing time is known. We feel that one such example which is worthy of investigation is that of edge flip Markov chains on planar maps, which one might see as a generalisation of Aldous’s triangulation walk. Given, for example, a p -angulation of the sphere with n faces, where $p \geq 3$, an edge flip chain can be defined by having each step select an edge at random, erase it and replace it with one of the edges that can be drawn within the face of perimeter $2p - 2$ left behind in order to form two faces of degree p . Whether this chain has polynomial mixing time is, as far as the authors are aware, not known, although edge flips have been considered before on different planar structures such as lattice triangulations [5, 6, 21].

In this paper we show a polynomial upper bound for the mixing time of the chain described above on the set of *rooted quadrangulations with n faces*; we wish this to be a starting point for a possible exploration of edge flip chains on different classes of planar maps.

Quadrangulations in particular occupy a privileged position within the panorama of planar maps, mainly thanks to the famous bijections first developed by Cori, Vanquelin and Schaeffer [9, 7], which encode them with (different classes of) labelled plane trees, thus placing them within the framework of (generalised) Catalan structures.

The relation with trees has been exploited to obtain both scaling and local limit results which have led to the definition and subsequent investigation of objects such as the Brownian map [12, 16] and the UIPQ [15, 10], providing very rich insights into the geometric structure of uniform random large quadrangulations. In fact, it has been shown that a number of classes of uniform random planar maps converge to the Brownian map, whose universality makes quadrangulations of the sphere a very useful model for a random surface.

Our contribution within this paper will consist in estimating the mixing time of the flip Markov chain \mathcal{F}_n on the set of rooted quadrangulation of the sphere with n faces, as described above and much more thoroughly in Section 2. In particular, we shall prove the following:

Theorem 1. *For the spectral gap ν_n of the edge flip Markov chain \mathcal{F}_n on the set \mathcal{Q}_n of rooted quadrangulations with n faces, we have*

$$C_1 n^{-\frac{11}{2}} \leq \nu_n \leq C_2 n^{-\frac{5}{4}}$$

for some positive constants C_1, C_2 independent of n . Consequently, the mixing time for \mathcal{F}_n is $O(n^{13/2})$.

We shall analyse this chain by comparing it – or rather, comparing its spectral gap, with techniques developed by Diaconis and Saloff-Coste [11] – to a chain on labelled trees which arises via the aforementioned Schaeffer bijection. This chain, which has very natural interpretations on a number of Catalan structures, is a coloured generalisation of a chain on plane trees with n edges whose steps are as follows: given a tree, pick an edge at random; unless it is a leaf, do nothing; if it is a leaf, then you may leave it intact, slide it one step to the left or slide it one step to the

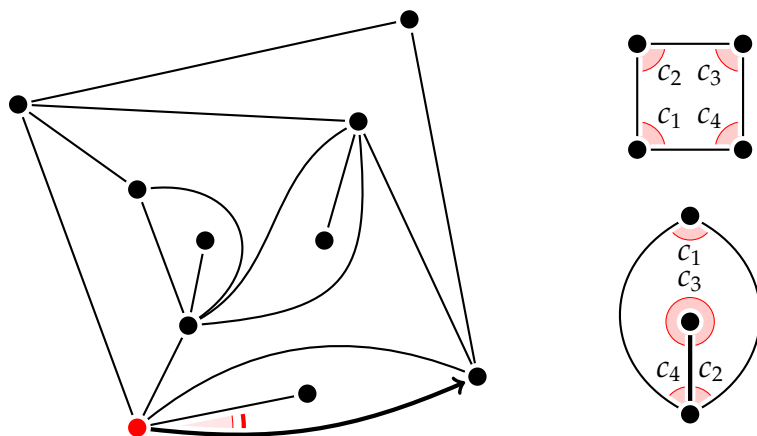

Figure 1: On the left, a quadrangulation q in \mathcal{Q}_8 ; notice that we may choose to embed it in the plane (rather than the sphere) in a canonical way by having the external face be the one lying directly to the right of the root edge. The origin of q is marked in red. To the right, the two kinds of face in a quadrangulation – non-degenerate and degenerate – with marked corners and clockwise contours. The double edge is the one adjacent to c_3 , which is drawn with a thicker line.

right in the contour of the tree, with equal probabilities (see Figure 6). This chain is also natural in the context of Dyck paths: it is essentially equivalent to picking a vertex of the path uniformly at random and, if the vertex is a peak, translating the peak one position to the right or to the left, with equal probabilities (Figure 7).

Though apparently not yet analysed within the scope of existing mathematical research about chains on Catalan structures, this ‘leaf translation’ chain is mentioned in the physics literature under the name of Fredkin spin chain, and a first lower bound of order $n^{-\frac{13}{2}}$ for its spectral gap is given by Movassagh [18], based on work by himself and Shor [19]. We shall partially follow their argument, which is based on the method of building canonical paths to estimate the conductance, to produce an improved lower bound of order $n^{-\frac{11}{2}}$, which will be instrumental to obtain our result for flips on quadrangulation.

The paper is organised as follows. Sections 2 and 3 will provide the reader with all relevant definition and recall some details of the Schaeffer bijection, since they will be relevant to our subsequent constructions. In section 4 we give an upper bound of order $n^{-\frac{5}{4}}$ for the spectral gap of \mathcal{F}_n by considering the Dirichlet form evaluated in the function that gives the radius of a quadrangulation. Section 5 will acquaint the reader with the leaf translation Markov chain on plane trees (and a “leaf replanting” variant) and prove our lower bound for its spectral gap. Finally, a large portion of the paper – namely, Section 6 – will be devoted to showing our lower bound for the spectral gap of \mathcal{F}_n via a comparison with a chain on *pointed* rooted quadrangulations, which bridges the gap between \mathcal{F}_n and the leaf translation Markov chain on labelled plane trees.

2 Edge flips on quadrangulations

Throughout this paper we shall be dealing with with certain Markov chains whose configuration space is the set of quadrangulations with a fixed number of faces; in order to introduce them, let us first discuss some notation.

First and foremost, we shall be adopting some of the language of *planar maps*, with which we

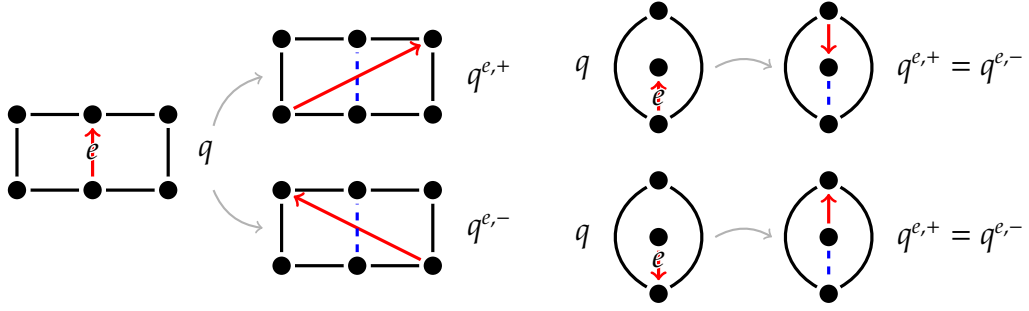

Figure 2: Clockwise and counterclockwise flips for a simple and a double edge in a quadrangulation; if the edge is the root, its orientation is “preserved” as in the figure.

assume some familiarity: we will be referring to maps and their *vertices*, *edges*, *faces*, as well as *corners* and *face contours*; we shall not review any definitions but the basic one, that is:

Definition 2.1. A planar map is a connected, locally finite planar multigraph endowed with a cellular embedding in the sphere S^2 , considered up to orientation-preserving homeomorphisms of the sphere itself. We will call a rooted planar map of size n a planar map with n faces, endowed with one distinguished oriented edge.

One can now define a *quadrangulation of size n* , or *of area n* , as a rooted planar map of size n all of whose faces have four corners (see Figure 1); we shall denote the set of all quadrangulations of size n by \mathcal{Q}_n . It follows from Euler’s polyhedral formula that a quadrangulation $q \in \mathcal{Q}_n$ has $2n$ edges and $n + 2$ vertices; it is also worth noting that a quadrangulation is automatically bipartite, which implies that it has no loops (that is, it has no edges with only one endpoint). It may, however, have multiple edges between the same two endpoints, and edges which are adjacent to a single face; we call the latter *multiple edges* of the face they belong to, and the face which contains them a *degenerate face*. We shall often refer to the vertex that the root edge is issued from as *the origin* of the quadrangulation.

Given a quadrangulation $q \in \mathcal{Q}_n$ and an edge e of q , we will denote by $q^{e,+}$ (resp. $q^{e,-}$), and refer to as *the quadrangulation obtained from q by flipping edge e clockwise* (resp. *counterclockwise*), the quadrangulation given by the following procedure:

- if e is adjacent to two distinct faces of q , erase e from q (thus obtaining a new face with exactly 6 corners) and replace it with the edge obtained by rotating e clockwise (resp. counterclockwise) by one corner (see Figure 2).
- if e is a double edge within a degenerate face, let v be the vertex of that face that is *not* an endpoint of e and let w be the endpoint of e having degree 1; erase e and replace it with an edge within the same face having endpoints v, w . If e is the root edge of q , let the newly drawn edge be the root of $q^{e,+}$ (resp. $q^{e,-}$), oriented in such a way that the origin does not change.

Throughout this paper, we will be considering the Markov chain \mathcal{F}^n of quadrangulation edge flips on the state space \mathcal{Q}_n , whose transition probabilities are of the form

$$p(q, q') = \frac{1}{6n} \sum_{e \in E(q)} (1_{q'=q^{e,+}} + 1_{q'=q^{e,-}} + 1_{q=q'});$$

in other words, conditionally on $\mathcal{F}_k^n = q$, \mathcal{F}_{k+1}^n can be determined by choosing an edge e of q uniformly at random and setting either $\mathcal{F}_{k+1}^n = q$, or $\mathcal{F}_{k+1}^n = q^{e,+}$, or $\mathcal{F}_{k+1}^n = q^{e,-}$, with equal probabilities.

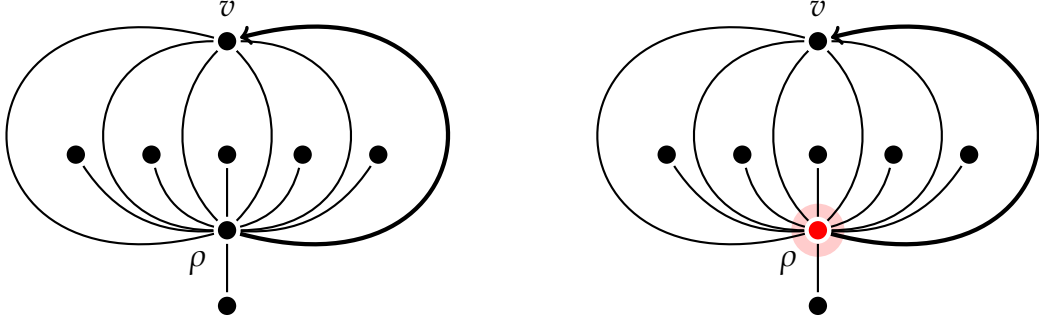

Figure 3: The quadrangulation q_0 in \mathbf{Q}_6 , with 6 degenerate faces arranged so that the degree of the origin is 12; to the right, the pointed version from Lemma 2.2.

Notice that, given a pair (q, q') of distinct quadrangulations in \mathbf{Q}_n , there are at most four distinct pairs (e, s) in $E(q) \times \{+, -\}$ such that $q' = q^{e,s}$; assuming e is not the root edge of q then it is uniquely determined by the pair (q, q') , and either s is determined as well or, in the case where e is a double edge, we have $q' = q^{e,+} = q^{e,-}$; also, we a priori cannot exclude that $q' = q^{\eta,+}$ and/or $q' = q^{\eta,-}$, where η is the root edge of q . Consequently, we have

$$\frac{1}{6n} \leq p(q, q') \leq \frac{2}{3n}$$

for all $q, q' \in \mathbf{Q}_n$ such that $p(q, q') \neq 0$ and $q \neq q'$.

Notice that, given $q \in \mathbf{Q}_n$, $e \in E(q)$, $s \in \{+, -\}$, we can naturally identify vertices of q with vertices of $q^{e,s}$, and edges of q with edges of $q^{e,s}$ (where the edge e corresponds to the edge redrawn by the flip procedure in $q^{e,s}$); we will therefore often refer to vertices or edges using the same notation in q and $q^{e,s}$, when we wish to implicitly exploit such a correspondence. This, of course, will need to be done with some care, since the correspondence is not necessarily unique if only the quadrangulations q and $q^{e,s}$ are given, but e and s are not known.

Remark 2.1. *The Markov chain \mathcal{F}^n is reversible and aperiodic: indeed, we have $q' = q^{e,+}$ if and only if $q = (q')^{e,-}$, so $p(q, q') = p(q', q)$; furthermore, we have trivially that $p(q, q) \geq \frac{1}{3}$.*

Lemma 2.1. *The Markov chain \mathcal{F}^n is irreducible.*

Proof. Let q_0 be the quadrangulation with n degenerate faces and such that the origin has the maximum possible degree (that is $2n$, all edges being incident to it) – see Figure 3. Given any quadrangulation $q \in \mathbf{Q}_n$, one can obtain q_0 from q with a sequence of edge flips.

Indeed, given any quadrangulation q , unless the degree of the origin ρ is $2n$, one can increase it via an edge flip; suppose not all edges have ρ as an endpoint and let v be a neighbour of ρ that has at least one neighbour different from ρ ; then, if you consider edges issued from v in clockwise order around v , there must be an edge e with second endpoint $w \neq \rho$, followed by one with endpoints v and ρ . Remark that $q^{e,-}$ has an origin with degree increased by one with respect to q .

We may therefore suppose that q is a quadrangulation in \mathbf{Q}_n whose origin ρ has degree $2n$. Let v be the second endpoint of the root edge in q ; we will show that, unless $\deg v = n$, there is an edge flip of q increasing the degree of v and not decreasing the degree of ρ . Indeed, notice that flipping any edge which is not a double edge inside a degenerate face does not change the

degree of ρ ; this is because every quadrangulation is bipartite, and in particular the bipartition of q 's vertices has one class consisting of ρ only, and one consisting of $V(q) \setminus \{\rho\}$. The bipartition can be changed only by flips of degenerate edges, so any other flip will transform an edge having ρ as an endpoint to another edge having ρ as an endpoint. Consider now all neighbours of v ; if v has strictly fewer than n neighbours, then it must be part of a face that is not degenerate (if it is only adjacent to degenerate faces, then the fact that all edges have ρ as an endpoint implies $q = q_0$). Consider any edge e of such a face not having v as an endpoint: then either $q^{e,-}$ or $q^{e,+}$ has the degree of v increased by one, and the degree of ρ unchanged.

Now, if $q \in \mathcal{Q}_n$ has root edge (ρ, v) with $\deg \rho = 2n$ and $\deg v = n$, then $q = q_0$, as desired. Remark 2.1 implies that \mathcal{F}^n is irreducible. \square

As a consequence of the above, \mathcal{F}^n admits the uniform measure on \mathcal{Q}_n as its (unique) stationary distribution.

We will see later how, rather than the set \mathcal{Q}_n , it will be convenient to consider the set \mathcal{Q}_n^\bullet of all *pointed* quadrangulations with n faces, that is the set $\{(q, v) \mid q \in \mathcal{Q}_n, v \in V(q)\}$. The Markov chain \mathcal{F}^n can be easily extended to a Markov chain $\mathcal{F}^{\bullet, n}$ with state space \mathcal{Q}_n^\bullet , by redefining the (clockwise and counterclockwise) flips so that the distinguished vertex is preserved, thanks to the natural identification between $V(q^{e,s})$ and $V(q)$. Notice that, if $F : \mathcal{Q}_n^\bullet \rightarrow \mathcal{Q}_n$ is the forgetful map that rids quadrangulations of the pointing, for a quadrangulation q_\bullet in \mathcal{Q}_n^\bullet we have $F(q_\bullet^{e,s}) = F(q_\bullet)^{e,s}$, where we are treating e both as an edge of q_\bullet and as an edge of $F(q_\bullet)$, since F does induce a natural identification for both vertices and edges.

Reversibility is of course still true, but one has to go a little further to prove irreducibility of $\mathcal{F}^{\bullet, n}$:

Lemma 2.2. *Let $q_0 \in \mathcal{Q}_n^\bullet$ be the quadrangulation with n degenerate faces, rooted in an oriented edge (ρ, v) such that ρ has degree $2n$ and v has degree n , pointed in ρ (see Figure 3). Then any quadrangulation $q \in \mathcal{Q}_n^\bullet$ can be turned into q_0 with a sequence of flips. In particular, $\mathcal{F}^{\bullet, n}$ is irreducible.*

Proof. Turning q into q_0 can be done with a very similar procedure to Lemma 2.1; if δ is the one distinguished vertex of q , one can apply flips until they obtain a quadrangulation q' where δ has degree $2n$; if δ is not the origin of q' and the root edge e of q' is not a double edge within a degenerate face, all we need to do is reverse its orientation by taking $((q')^{e,+})^{e,+}$: this will make δ the origin and preserve its degree $\deg \delta = 2n$. Similarly, if e is a double edge of q' and δ is not the origin, one only needs to flip clockwise the edge e' that comes before e in the clockwise contour of the degenerate face containing e . Then one can flip e clockwise three times, then e' counterclockwise, to have δ as the origin and preserve its degree. Note that, at this point, the root edge is a double edge. We can then proceed as in Lemma 2.1 to increase the degree of the second endpoint $v \neq \delta$ of the root edge until it is n . Notice that this only entails flipping edges that do not already have v as an endpoint, so the root edge will not be flipped and the final quadrangulation will be correctly rooted in an edge issued from δ . \square

As a consequence of the lemma above, the stationary distribution for $\mathcal{F}^{\bullet, n}$ is the uniform measure on \mathcal{Q}_n^\bullet .

Our aim in this paper will be to prove upper and lower bounds for the spectral gap ν_n of the Markov chain \mathcal{F}^n ; we will rely on the Markov chain $\mathcal{F}^{\bullet, n}$ for the known bijections available between the set \mathcal{Q}_n^\bullet and certain sets of labelled trees, which we will briefly discuss in the next section. Dealing with $\mathcal{F}^{\bullet, n}$ will still provide information about \mathcal{F}^n : any lower bound for ν_n^\bullet will serve as a lower bound for ν_n , as per the following lemma:

Lemma 2.3. *For the spectral gap ν_n^\bullet of $\mathcal{F}^{\bullet, n}$ and the spectral gap ν_n of \mathcal{F}^n , we have $\nu_n^\bullet \leq \nu_n$.*

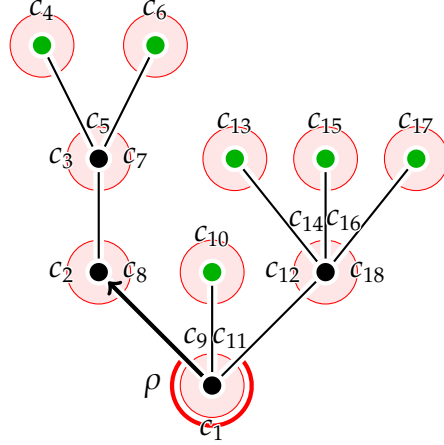

Figure 4: A *plane tree* with 9 edges, whose 18 corners are labelled according to their order in the clockwise contour; the tree is rooted in the marked oriented edge, or equivalently has the corner labelled 1 as a distinguished corner. Leaves are marked in green and are defined as vertices other than the origin having degree 1, i.e. only one corner.

Proof. The proof is quite immediate, since we can write

$$v_n = \mathcal{E}_{\mathcal{F}^n}(f, f) = \frac{1}{2} \sum_{\substack{q \in \mathbb{Q}_n \\ e \in E(q) \\ s \in \{+, -\}}} (f(q) - f(q^{e,s}))^2 \frac{1}{|\mathbb{Q}_n| 6n}$$

for some function $f : \mathbb{Q}_n \rightarrow \mathbb{R}$ such that $\mathbb{E}_\pi(f) = 0$ and $\mathbb{V}_\pi(f) = 1$ (where π is the uniform measure on \mathbb{Q}_n).

Now, setting $F : \mathbb{Q}_n^\bullet \rightarrow \mathbb{Q}_n$ to be the forgetful function which rids a quadrangulation of its distinguished vertex, consider the function $f \circ F : \mathbb{Q}_n^\bullet \rightarrow \mathbb{R}$. We have $\mathbb{E}_{\pi^\bullet}(f \circ F) = 0$ and $\mathbb{V}_{\pi^\bullet}(f \circ F) = 1$, where π^\bullet is the uniform measure on \mathbb{Q}_n^\bullet . For the spectral gap v_n^\bullet of $\mathcal{F}^{n,\bullet}$, we have

$$\begin{aligned} v_n^\bullet &\leq \mathcal{E}_{\mathcal{F}^{n,\bullet}}(f \circ F, f \circ F) = \frac{1}{2} \sum_{\substack{q \in \mathbb{Q}_n^\bullet \\ e \in E(q) \\ s \in \{+, -\}}} (f(F(q)) - f(F(q^{e,s})))^2 \cdot \frac{1}{(n+2)|\mathbb{Q}_n|} \cdot \frac{1}{6n} = \\ &= \frac{1}{2} \sum_{\substack{q \in \mathbb{Q}_n^\bullet \\ e \in E(F(q)) \\ s \in \{+, -\}}} (f(F(q)) - f(F(q)^{e,s}))^2 \cdot \frac{1}{(n+2)|\mathbb{Q}_n|} \cdot \frac{1}{6n} = \mathcal{E}_{\mathcal{F}^n}(f, f) = v_n, \end{aligned}$$

as claimed. □

3 The Schaeffer bijection

In order to obtain lower bounds for the spectral gap of \mathcal{F}^n , we will find it convenient to compare it to the spectral gap of a certain Markov chain on the state space of (labelled) trees. A key ingredient to set up this comparison will be a well-known bijection often referred to as the Schaeffer correspondence [7, 9].

Although this bijection and its variants have been described in a number of papers, we shall still give a very brief presentation of the construction of labelled trees from rooted, pointed quadrangulations and vice-versa, since part of it will be heavily relied upon in the rest of the paper.

Definition 3.1. *A plane tree is a rooted planar map with a single face.*

We will often find it convenient to see the root of a plane tree as a distinguished corner rather than a distinguished oriented edge; in what follows, we shall refer to the *clockwise contour* of a tree (see Figure 4) as the cyclic sequence $(c_i)_{i=1}^{2n}$ of its corners (where n is the number of its edges); we number the corner in such a way that c_1 is the root corner, that is the corner of the origin lying immediately to the left of the root edge. Given a vertex v of a plane tree other than the origin, we shall write $p(v)$ for its parent; notice that each edge of a tree may be univocally written in the form $(v, p(v))$, where v is a vertex of the tree other than the origin. Vertices of degree 1, with the exception of the origin, will be called *leaves*.

We shall call \mathbb{T}_n the set of all plane trees with n edges; trees with zero edges do not conform to the definition above, but we will still find it convenient to define \mathbb{T}_0 to be $\{\bullet\}$ by convention, where “ \bullet ” is the graph with one vertex and no edges.

Definition 3.2. *A labelled tree is a plane tree t endowed with a labelling $l : V(t) \rightarrow \mathbb{Z}$ such that*

- if ρ is the origin of t , $l(\rho) = 0$;
- for any vertex $v \in V(t) \setminus \{\rho\}$, $|l(v) - l(p(v))| \in \{1, -1, 0\}$.

We shall call \mathbb{LT}_n the set of all labelled trees with n edges, and set $\mathbb{LT}_0 = \{\bullet\}$.

Notice that, equivalently, a labelled tree could simply be presented as a plane tree whose edges are three-coloured (the colours being $\{1, -1, 0\}$); if $c(e)$ is the colour of the edge e , labels of vertices could be recovered by setting $l(v) = \sum_{e \in P(v)} c(e)$, where $P(v)$ is the one simple path leading from v to the origin (or the empty path if v is the origin itself). Throughout the paper, we will use both points of view; it will therefore be useful to introduce a more general notation for plane trees whose edges are r -coloured (r being some fixed positive integer); we will write $\mathbb{T}_n^{(r)}$ for the set

$$\{(t, C) \mid t \in \mathbb{T}_n, C \in \{1, \dots, r\}^{E(t)}\}.$$

For convenience, we will often refer to a labelled or r -coloured tree with a single symbol such as t , and consider the labelling or colouring to be implicit; in the case of labelled trees, we will usually call the labelling l without further comment, and sometimes naturally extend it to corners, thus writing $l(c)$ when we mean $l(v)$, where v is the vertex of t that c is adjacent to.

The reason for our definition of \mathbb{LT}_n is the fact that the sets \mathbb{Q}_n^\bullet and $\mathbb{LT}_n \times \{-1, 1\}$ have the same cardinality; moreover, pointed quadrangulations can be interpreted as pairs (t, ε) , where t is a labelled tree and $\varepsilon \in \{-1, 1\}$, in a rather natural way. As promised, we give here a description of how to construct an element of \mathbb{Q}_n^\bullet from an element of \mathbb{LT}_n and a sign $\varepsilon \in \{-1, 1\}$ via the (unconstrained) Schaeffer correspondence; we include a brief description of the inverse construction for completeness and clarity, but this will not be explicitly used in the proofs to come.

Construction of a mapping ϕ from \mathbb{LT}_n to \mathbb{Q}_n ($\phi : (\tau, \varepsilon) \mapsto q$)

- consider the clockwise (cyclic) contour $(c_i)_{i=1}^{2n}$ of τ , started at the distinguished corner, and let ℓ be the minimal label appearing on vertices of τ ;
- for each corner c_i labelled at least $\ell + 1$, set $k = \min\{j > 0 \mid l(c_{i+j}) = l(c_i) - 1\}$; join c_i to c_{i+k} with an edge (so that edges being drawn do not cross, see Figure 5);

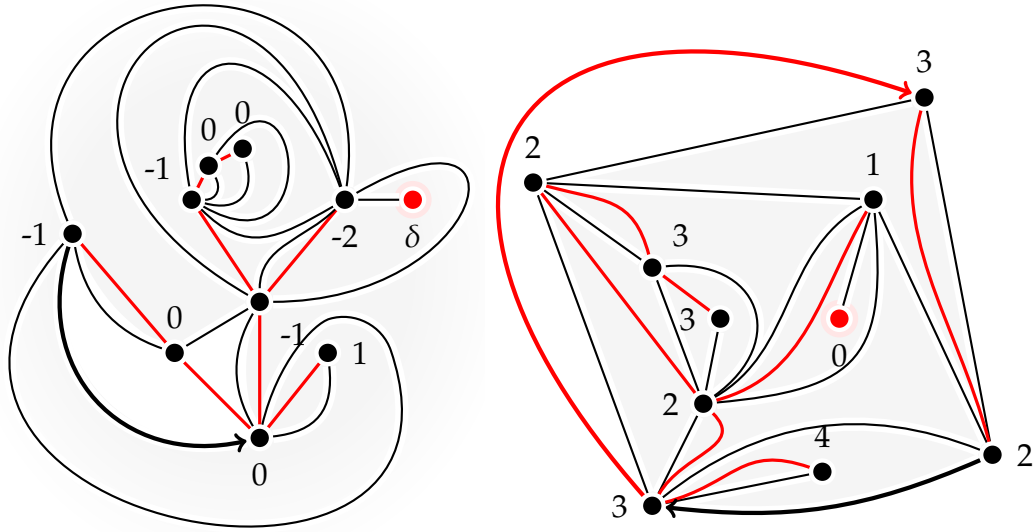

Figure 5: The (unconstrained) Schaeffer bijection. The two quadrangulations are the same, although the unbounded face in the embedding on the right corresponds to the white inner face on the left.

- draw a new vertex δ within the unbounded face of the tree and join each corner labelled ℓ to δ with a new edge (again, so as not to cross any previously drawn edges);
- root the map thus obtained in the newly drawn edge issued from the distinguished corner of τ , oriented away from the origin of τ if $\varepsilon = -1$, towards it if $\varepsilon = 1$; make δ the distinguished vertex;
- erase all edges of τ and forget all labels.

Construction of a mapping ϕ^{-1} from \mathbf{Q}_n to \mathbf{LT}_n ($\phi : q \mapsto (\tau, \varepsilon)$)

- label all vertices in q with their graph distance to the distinguished vertex δ , thus defining a labelling $l : V(q) \rightarrow \mathbb{N}$; for each face of q , read the labels of the vertices adjacent to its four corners cyclically according to a *clockwise* contour. Given two successive corners c_i and c_{i+1} in a clockwise contour of a face f , we say c_i is a down-step corner of f if the label of c_{i+1} is strictly smaller than that of c_i (notice that, since the map is bipartite, the label of c_{i+1} is either one more or one less than that of c_i , hence each face has exactly 2 down-step corners);
- draw a new edge within each face of q , joining its two down-step corners;
- consider the root edge (e_-, e_+) of q , and let f_l and f_r be the faces lying *left* and *right* of (e_-, e_+) respectively (of course, the two may coincide); if $l(e_-) < l(e_+)$, set $\varepsilon = 1$ and choose as new root the edge being drawn between a corner adjacent to e_+ and the other down-step corner of f_l , oriented away from e_+ ; if $l(e_-) > l(e_+)$, set $\varepsilon = -1$ and root in the edge drawn between a corner of e_- and a down-step corner of f_r , oriented away from e_- ;
- subtract $l(e_-)$ (if $\varepsilon = -1$) or $l(e_+)$ (if $\varepsilon = 1$) to all labels: this way the label of the new origin is 0;
- erase all original edges and the distinguished vertex δ .

Theorem 2 (Schaeffer correspondence). *The construction $\phi : \mathbf{LT}_n \times \{-1, 1\} \rightarrow \mathbf{Q}_n$ described above is a bijection and ϕ^{-1} is its inverse; given $t \in \mathbf{LT}_n$ and $\varepsilon \in \{-1, 1\}$, the mapping ϕ naturally induces an identification between vertices of t and vertices of $\phi(t, \varepsilon)$ such that, if l is the labelling of t , we have*

$l(v) = d_{\text{gr}}(v, \delta) - d_{\text{gr}}(\delta, \rho)$, where v is interpreted as a vertex of t in the left hand side of the equation and as a vertex of $\phi(t, \varepsilon)$ in the right hand side, ρ is the origin of $\phi(t, \varepsilon)$ and δ its distinguished vertex.

4 An upper bound for the spectral gap of \mathcal{F}^n

We will first show our upper bound for the spectral gap of \mathcal{F}_n , which will be achieved by evaluating the Dirichlet form for \mathcal{F}_n in a function related to the radius of a quadrangulation. The same lower bound arises by considering many other natural functions relating to the metric structure of quadrangulations, constructed from graph distances, volumes of balls, length of separating cycles, etc.

Note that our proof will essentially rely on the fact that edge flips change distances by at most a constant and that the scaling limit of the radius of random quadrangulations is a known random variable (i.e. the radius of the Brownian map). The same upper bound would thus extend to analogous edge flip chains for other classes of random planar maps which converge to the Brownian Map when rescaled by $n^{1/4}$; in particular, it implies the lower bound given by Budzinski in [4] for the mixing time of random triangulations.

Proposition 4.1. *For the spectral gap ν_n of the Markov chain \mathcal{F}^n of flips on quadrangulations of size n we have*

$$\nu_n \leq Cn^{-\frac{5}{4}},$$

where C is some positive constant independent of n .

Proof. Let $r : \mathcal{Q}_n \rightarrow \mathbb{N}$ be the mapping sending a quadrangulation q to its radius, that is the maximum possible distance of a vertex of q to the origin. Consider the function $f_n : \mathcal{Q}_n \rightarrow \mathbb{R}$ defined as

$$f_n(q) = \frac{r(q)}{n^{\frac{1}{4}}}.$$

Notice that, given $q \in \mathcal{Q}_n$, $e \in E(q)$, $v \in V(q)$ and $s \in \{+, -\}$, we have $\left| d_{\text{gr}}^q(v, \rho_q) - d_{\text{gr}}^{q^{e,s}}(v, \rho_{q^{e,s}}) \right| \leq 3$, where $d_{\text{gr}}^q(v, \rho)$ is the distance of v to the origin of q and $d_{\text{gr}}^{q^{e,s}}(v, \rho_{q^{e,s}})$ is the distance to the origin of $q^{e,s}$ of the vertex that corresponds to v via the natural identification induced by flipping the edge e . Indeed, removing e can only increase the distance of v to ρ by at most 2, while reintroducing a rotated edge can only decrease it by at most 2; if e is not the root edge of q , then ρ is still the origin in $q^{e,s}$; otherwise, $\rho_{q^{e,s}}$ is a vertex adjacent to the previous origin ρ . As a consequence, we have $|r(q) - r(q^{e,s})| \leq 3$.

Let us now evaluate the Dirichlet form $\mathcal{E}_{\mathcal{F}^n}(f_n, f_n)$; we have

$$\mathcal{E}_{\mathcal{F}^n}(f_n, f_n) = \frac{1}{2} \sum_{\substack{q \in \mathcal{Q}_n \\ e \in E(q) \\ s \in \{+, -\}}} (f_n(q) - f_n(q^{e,s}))^2 \frac{1}{6n|\mathcal{Q}_n|} = \sum_{\substack{q \in \mathcal{Q}_n \\ e \in E(q), s \in \{+, -\} \\ f_n(q) < f_n(q^{e,s})}} (f_n(q) - f_n(q^{e,s}))^2 \frac{1}{6n|\mathcal{Q}_n|},$$

and therefore

$$\mathcal{E}_{\mathcal{F}^n}(f_n, f_n) \leq \frac{3}{2n^{\frac{1}{2}+1}} \sum_{\substack{q \in \mathcal{Q}_n \\ e \in E(q), s \in \{+, -\} \\ f_n(q) < f_n(q^{e,s})}} \frac{1}{|\mathcal{Q}_n|} = \frac{3}{2n^{\frac{5}{4}}} \mathbb{E}_\pi(n^{-\frac{1}{4}} 2X),$$

where $X : \mathcal{Q}_n \rightarrow \mathbb{N}$ maps q to the number of edges e in $E(q)$ such that $r(q) < r(q^{e,s})$ for some $s \in \{+, -\}$, and π is the uniform probability measure on \mathcal{Q}_n .

We intend to show that $\mathbb{E}_\pi(n^{-\frac{1}{4}}X)$ is bounded above by a constant independent of n .

Given $q \in \mathbf{Q}_n$, consider the set $S(q) = (B_{r(q)-2})^c$ of all vertices v of q such that $d_{\text{gr}}(v, \rho) \geq r(q) - 1$, where ρ is the origin of q . Also, for each v in $S(q)$, consider a simple path P_v in q with endpoints ρ and v and length $d_{\text{gr}}(\rho, v)$.

Flipping an edge e that is not the root of q and does not belong to $\bigcup_{v \in S(q)} P_v$ cannot increase the radius of the quadrangulation; in fact, since all paths P_v and the origin are preserved, the distance to the root of vertices in $S(q)$ cannot increase, and the distance to the root of any vertex outside of $S(q)$ becomes at most $r(q) - 2 + 2 = r(q)$. We thus have, for all $q \in \mathbf{Q}_n$, $X(q) \leq |S(q)|r(q) + 1$.

We shall now show that the law of $|S(q)|$ under π is the same as the law of $|B_2(q)| - 1$ under π , where $|B_2(q)|$ is the number of vertices having distance at most 2 from the origin in q .

This can be shown by a rerooting argument on the labelled tree $\phi^{-1}(P(q))$, where $P(q)$ is the quadrangulation q , pointed in its origin ρ . The mapping $\phi^{-1} \circ P$ is a well known variant of the Schaeffer construction, and is a bijection between the set \mathbf{Q}_n and the set $\text{LT}_n^+ \times \{1\}$, where LT_n^+ is the set of all labelled trees with n edges such that no negative labels appear on them. The quantity $|S(q)|$ represents the number of vertices labelled $r(q) - 1$ or $r(q) - 2$ ($r(q) - 1$ being the maximum label appearing on vertices of $\phi^{-1}(P(q))$).

Consider the following bijection of the set LT_n^+ to itself: given a tree $t \in \text{LT}_n^+$ and, among the corners of vertices bearing the maximum appearing label (say, $M = \max_v l(v)$), consider the leftmost one according to the clockwise contour; reroot t in that corner and relabel each vertex v of t with the label $M - l(v)$. This correspondence is clearly a bijection, since its inverse consists in rerooting a tree from LT_n^+ in its *rightmost* corner labelled with its maximum label and performing the same relabelling as the one described.

Looking at vertices labelled M or $M - 1$, the above correspondence relabels them with 0 or 1; since π corresponds to the uniform measure on LT_n^+ , the law of $|S(q)|$ under π is the same as the law of the number of vertices at distance 1 or 2 from the origin in a uniform random quadrangulation from \mathbf{Q}_n , that is the law of $|B_2(q)| - 1$ under π , which has exponential tails.

Thanks to the Cauchy-Schwarz inequality, we can write

$$\mathcal{E}(f_n, f_n) \leq \frac{3}{n^{\frac{5}{4}}} \left(E_\pi(|S(q)|^2) \mathbb{E}_\pi(f_n(q)^2) \right)^{1/2} + \frac{3}{n^{\frac{3}{2}}} \leq \frac{C'}{n^{\frac{5}{4}}} \left(E_\pi(|B_2(q)|^2) \mathbb{E}_\pi(f_n(q)^2) \right)^{1/2}.$$

But now $E_\pi[|B_2(q)|^2]$ has a finite limit as $n \rightarrow \infty$. Furthermore, the random variable $f_n(q)$ (considered under π) converges weakly to the range of a Brownian snake driven by a Brownian excursion, whose variance is positive, and all of its moments converge (see [7, Corollary 3]); thus the right hand side of

$$n^{\frac{5}{4}} v_n \leq C' \frac{\left(E_\pi[|B_2(q)|^2] \mathbb{E}_\pi[f_n(q)^2] \right)^{1/2}}{\mathbb{V}_\pi[f_n(q)]}$$

is bounded by a constant independent of n , which proves the proposition. \square

5 A Markov chain on labelled trees

Our main results about the Markov chain \mathcal{F}^n will be achieved via a comparison to a certain very natural Markov chain on labelled plane trees, which we will introduce presently.

Given a plane tree $t \in \mathbf{T}_n$ with contour c_1, \dots, c_{2n} and a leaf $v \in V(t)$ adjacent to a corner c_l , where $l < 2n$, build a new tree $t^{v \rightarrow} \in \mathbf{T}_n$ as follows: draw a new leaf v' attached to the tree via the corner c_{l+2} (the corner c_1 if $l = 2n - 1$); then erase v ; if $(p(v), v)$ is the root edge of t (i.e. if $l = 2$), then root $t^{v \rightarrow}$ in $(p(p(v')), p(v'))$. Notice that, given a pair of trees $t, t' \in \mathbf{T}_n$, there is at most one leaf

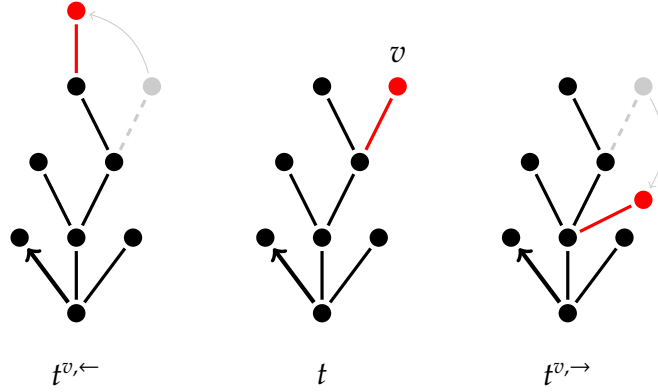

Figure 6: Left and right leaf translation.

v of t such that $t' = t^{v, \rightarrow}$; this induces (when there is such a leaf) a natural identification between vertices of t and vertices of t' which sends v to the “shifted” leaf v' in t' and is a tree isomorphism between the trees τ and τ' obtained from t and t' by erasing v and v' . This is why, given two trees of the form $t, t^{v, x}$, we will automatically identify their vertices and denote them in the same way, including vertices v and v' , thus taking “vertex v in $t^{v, x}$ ” to mean the newly drawn leaf v' .

Given $t \in \mathbb{T}_n$, we can define analogously a tree $t^{v, \leftarrow} \in \mathbb{T}_n$ as the one tree such that $(t^{v, \leftarrow})^{v, \rightarrow} = t$, if it exists. Additionally, we set $t^{v, \leftarrow} = t$ if $(v, p(v))$ is the root edge of t (that is, in the one case where t is not of the form $t^{v, \rightarrow}$) and $t^{v, \rightarrow} = t$ if v is adjacent to corner $2n$ in the contour (so that now $t^{v, \rightarrow}$ is defined for all leaves v of t).

When $t^{v, \rightarrow} \neq t$, we say that the tree $t^{v, \rightarrow}$ has been constructed from t by *translating the leaf v to the right* (and $t^{v, \leftarrow}$ differs from t by a *leaf translation to the left*); notice that, given two trees t, t' which differ by a leaf translation, there is a unique leaf v of t and a unique direction d , either \rightarrow or \leftarrow , such that t' can be expressed as $t^{v, d}$.

One could define a Markov chain X on the set of plane trees with n edges so that, given $X_k = t$, X_{k+1} is determined by selecting an edge $(v, p(v))$ of t uniformly at random and, if v is a leaf of t , setting $X_{k+1} = t$ or $X_{k+1} = t^{v, \rightarrow}$ or $X_{k+1} = t^{v, \leftarrow}$ with equal probability, while $X_{k+1} = t$ if v is not a leaf. We shall need a coloured variant of this chain, which can easily be defined on the set of plane trees with coloured edges $\mathbb{T}_n^{(r)}$, where $C = \{1, \dots, r\}$ is the set of possible edge colours. The trees $t^{v, \rightarrow}$ and $t^{v, \leftarrow}$ are defined from $t \in \mathbb{T}_n^{(r)}$ exactly as before, by additionally ensuring that all edge colours are preserved. We can also introduce appropriate “recolouring” moves: given $x \in C$ and a leaf v in $V(t)$, we set $t^{v, x}$ to be the tree t , where the edge $(v, p(v))$ is recoloured with colour x . One can now define X_{k+1} , given $X_k = t$, by selecting an edge $(v, p(v))$ of t uniformly at random: if v is a leaf, we set X_{k+1} to be one of $t^{v, \rightarrow}, t^{v, \leftarrow}, t^{v, 1}, t^{v, 2}, \dots, t^{v, r}$, each with probability $\frac{1}{r+2}$; if v is not a leaf, $X_{k+1} = t$. In other words, given $t \neq t^{v, x}$, where v is a leaf of t and $x \in \{1, \dots, r, \rightarrow, \leftarrow\}$, the Markov chain X on $\mathbb{T}_n^{(r)}$ has transition probability

$$p_X(t, t^{v, x}) = \frac{1}{n(r+2)};$$

if t, t' do not differ by a leaf translation or recolouring we have $p_X(t, t') = 0$, and $p_X(t, t) > 0$ is determined by consequence (and, of course, depends on t).

Notice that the case $r = 3$ corresponds to a Markov chain on the state space LT_n of labelled trees with n vertices. We shall call this the *leaf translation Markov chain* and will be estimating its spectral gap as well as comparing it to the spectral gap of $\mathcal{F}^{\bullet, n}$.

The leaf translation Markov chain on $\mathbb{T}_n^{(r)}$ (including the simpler variant introduced at the

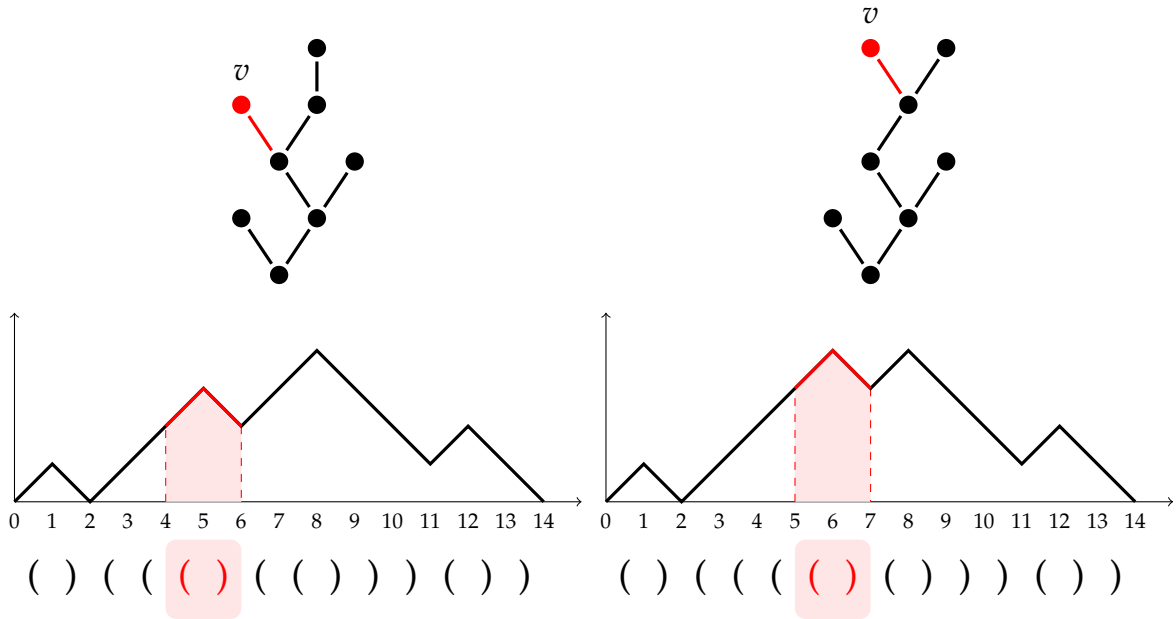

Figure 7: Some of the natural correspondences between the set \mathcal{T}_n of plane trees with n edges and other Catalan structures result in interesting alternative interpretations of the leaf translation Markov chain. For example, if read on the set of Dyck path of length $2n$ via the standard identification with plane trees, what the leaf translation chain does given a Dyck path $D : \{0, \dots, 2n\} \rightarrow \mathbb{N}$ is select an element of $\{1, \dots, 2n\}$ uniformly at random; if i or $i - 1$ is a *peak*, i.e. a point of local maximum for D , it is either left untouched or shifted to the right (if possible) or shifted to the left (if possible), each with probability $1/3$. Shifting a peak i of D to the right, for example, can be done if $i \leq 2n - 2$ and consists in constructing a Dyck path D' such that $D'(i) = D'(i + 2) = D(i + 2)$, $D'(i + 1) = D(i + 2) + 1$ and $D'(j) = D(j)$ for all $j \in \{1, \dots, 2n\} \setminus \{i, i + 1, i + 2\}$. An analogous interpretation for the leaf translations can be given on string of balanced parentheses, where one selects an open parenthesis at random and, if it is immediately followed by a closed parenthesis, then the pair “()” may remain untouched or move one place to the right or to the left.

beginning of this section for $r = 1$) is a very natural chain, worthy in fact of study independently of our efforts with regards to \mathcal{F}^n . We have chosen to present it as a chain on $\mathcal{T}_n^{(r)}$, but its transitions appear very natural for a number of different interpretations of the state space via classical bijections between Catalan structures (see Figure 7). Indeed, variants of this chain have been discussed in the physics literature under the name of *Fredkin spin models*, and have been investigated by Movassagh and Shor [19, 18], relying on work by Bravyi et al. [3].

In particular, Movassagh and Shor prove a lower bound of $Cn^{-\frac{11}{2}}$ for the spectral gap of a chain on $\mathcal{T}_n^{(r)}$ closely related to X , from which a bound for the spectral gap of X can be gleaned; we shall partially follow their argument for estimating the spectral gap, but will improve their results and will therefore provide a complete proof of our lower bounds in the next section. In order to do this, we will now introduce a variant of the leaf translation Markov chain which is closer to the one originally considered by Movassagh and Shor in their proofs; even though bounding its spectral gap is not strictly speaking necessary for achieving our results for X and therefore \mathcal{F}^n , we believe our improved bound to be of independent interest, and the proof – which is somewhat simpler

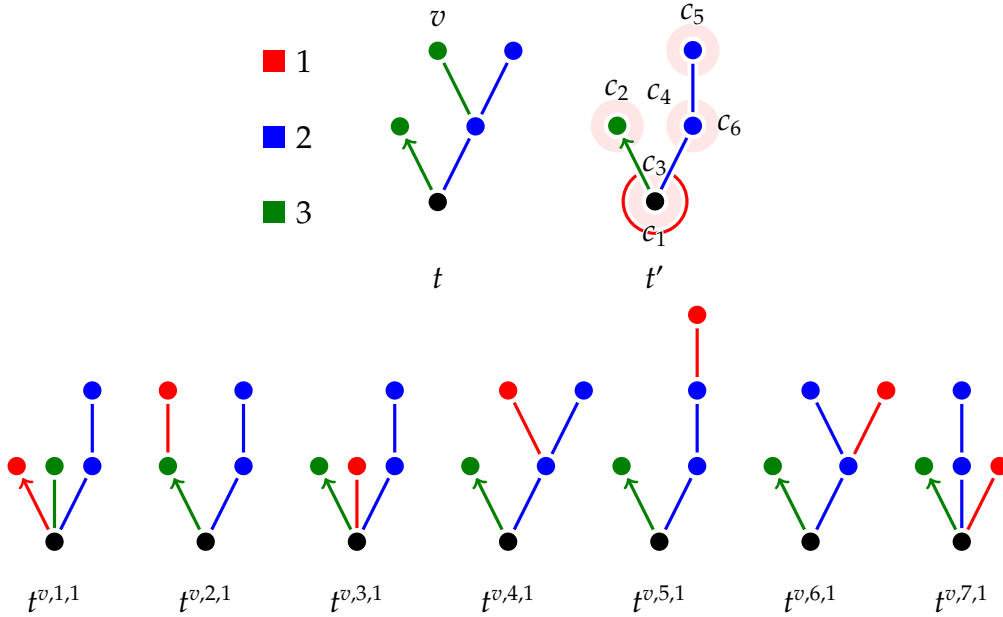

Figure 8: The leaf replanting move of a leaf v performed on a tree $t \in \mathbb{T}_4^{(3)}$: above, the tree $t' \in \mathbb{T}_3^{(3)}$ and its contour; below, the trees $t^{v,k,1}$ for $k = 1, \dots, 7$.

than the one for X – to provide a handy way to more naturally introduce some of the necessary notation and showcase the basic argument.

We shall introduce this chain on the set $\mathbb{T}_n^{(r)}$ and refer to [18] for a presentation as a chain on the set of (coloured) Dyck paths. Given $t \in \mathbb{T}_n^{(r)}$, a leaf $v \in V(t)$, an integer $k \in \{1, \dots, 2n - 1\}$ and a colour $c \in \{1, \dots, r\}$, we define $t^{v,k,c} \in \mathbb{T}_n^{(r)}$ by the following procedure (Figure 8):

- erase $(v, p(v))$ from t , thus obtaining $t' \in \mathbb{T}_{n-1}^{(r)}$;
- consider the clockwise contour c_1, \dots, c_{2n-2} of t' . If $1 < k < 2n - 1$, add a leaf v' to t' via its corner c_k ; if $k = 1$ or $k = 2n - 1$, add a leaf v' to t' via the root corner c_1 : if $k = 1$, let the new root corner be the one right before the added leaf, i.e. reroot t' so that the corner of v' becomes the second corner of the contour; if $k = 2n - 1$, let the root corner be the one right after v' , so that the corner of v' is the last one in the clockwise contour of the new tree;
- colour the edge $(v', p(v'))$ with the colour c .

Notice that, if the corner of v is the k -th corner in the clockwise contour of t with $1 < k < 2n - 1$ and c is the colour of $(v, p(v))$ in t , $t^{v,\rightarrow} = t^{v,k,c}$ and, if $k > 2$, $t^{v,k-2,c} = t^{v,\leftarrow}$.

We define the *leaf replanting* Markov chain Y on the state space $\mathbb{T}_n^{(r)}$ by choosing, if $Y_k = t$, a uniformly random edge $(v, p(v))$ of t ; if v is not a leaf, then we set $Y_{k+1} = t$; if v is a leaf, we set Y_{k+1} to be $t^{v,k,c}$, where k and c are chosen independently and uniformly at random in $\{1, \dots, 2n - 1\}$ and $\{1, \dots, r\}$ respectively.

While we were able to identify the leaf being moved between two trees that differ by a leaf translation, notice that this is not the case when we're dealing with a leaf replanting. In general, we have

$$p_Y(t, t') = \sum_{v,k,c} \frac{1}{n(2n-1)r} 1_{t'=t^{v,k,c}}$$

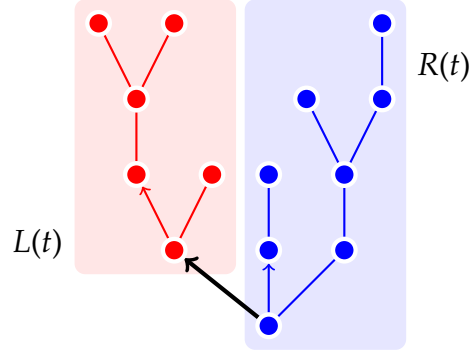

Figure 9: The decomposition of a tree $t \in \mathbb{T}_{13}$ into its left and right components $L(t) \in \mathbb{T}_5$ and $R(t) \in \mathbb{T}_7$.

Remark 5.1. Notice that both X and Y are reversible, irreducible and aperiodic. Reversibility and aperiodicity are clear from the definition; irreducibility is also clear: given any tree in $\mathbb{T}_n^{(r)}$, one can turn it into the tree of height 1 whose edges are all coloured 1 with at most n transitions from Y (indeed, it suffices to apply the replanting $\cdot \mapsto \cdot^{v,1,1}$ on the rightmost leaf v of the tree several times). Since each leaf replanting can actually be obtained by concatenating at most $2n - 1$ transitions from X ($2n - 2$ translations and one recolouring), the same height one tree can be obtained with at most $n(2n - 1)$ transitions from X . The two Markov chains X and Y therefore both admit the uniform measure on $\mathbb{T}_n^{(r)}$ as their unique stationary distribution.

5.1 A lower bound for the spectral gaps of leaf replanting and leaf translation Markov chains

In order to prove the desired lower bounds, we first need to set up some machinery; the first part of this section will be devoted to constructing a family of probability measures on sequences of transitions for the Markov chain Y . This will be done via a family of functions $f_n : \mathbb{T}_n^{(r)} \times \mathbb{T}_{n-1}^{(r)} \rightarrow \mathbb{R}$ and a function $F : (\mathbb{T}_n^{(r)})^2 \rightarrow \mathbb{T}_{n-1}^{(r)}$ with some specific properties, which we now state.

Proposition 5.1. For $n \geq 1$, there exists a mapping $f_n : \mathbb{T}_n^{(r)} \times \mathbb{T}_{n-1}^{(r)} \rightarrow \mathbb{R}$ such that

- (i) $f_n(t, t') = 0$ if t' cannot be obtained from t by deleting a leaf;
- (ii) $\sum_{t' \in \mathbb{T}_{n-1}^{(r)}} f_n(t, t') = 1$ for all t in $\mathbb{T}_n^{(r)}$;
- (iii) $\sum_{t \in \mathbb{T}_n^{(r)}} f_n(t, t') = \frac{|\mathbb{T}_n^{(r)}|}{|\mathbb{T}_{n-1}^{(r)}|}$ for all t' in $\mathbb{T}_{n-1}^{(r)}$.

Proof. We can recursively construct a mapping f_n with the required properties.

Indeed, $\mathbb{T}_1^{(r)} \times \mathbb{T}_0^{(r)} = \{P_1^{(1)}, \dots, P_1^{(r)}\} \times \{\bullet\}$, where $P_1^{(i)}$ is the tree with one edge which is coloured i and \bullet is the single vertex, and we can set $f_1(P_1^{(i)}, \bullet) = 1$.

Notice that, for $n > 1$, we can define two functions $L, R : \mathbb{T}_n^{(r)} \rightarrow \bigcup_{k=0}^{n-1} \mathbb{T}_k^{(r)}$ (see Figure 9) by setting $L(t)$ to be the tree of descendants of u in t , where (ρ, u) is the root edge of t (including u and with the natural rooting induced by that of t , unless u is a leaf, in which case $L(t) = \bullet$) and $R(t)$ to be the tree obtained from t by erasing $L(t)$ (and the edge (ρ, u)), rooted in the corner that

contains the original root corner of t (unless ρ has degree 1, in which case $R(t) = \bullet$). We have $0 \leq |L(t)| \leq n-1$ and $|L(t)| + |R(t)| = n-1$, and $t \mapsto (L(t), R(t), c)$, where $c \in \{1, \dots, r\}$ is the colour of the root edge in t , is a bijection between $\mathbb{T}_n^{(r)}$ and $\bigcup_{k=0}^{n-1} (\mathbb{T}_k^{(r)} \times \mathbb{T}_{n-1-k}^{(r)}) \times \{1, \dots, r\}$.

We will now construct $f_n : \mathbb{T}_n^{(r)} \times \mathbb{T}_{n-1}^{(r)}$, for $n > 1$, from the mappings f_1, \dots, f_{n-1} , by using the projections L, R and n constants $C_0^{(n)}, \dots, C_{n-1}^{(n)}$ which will be explicitly worked out below. Consider $(t, t') \in \mathbb{T}_n^{(r)} \times \mathbb{T}_{n-1}^{(r)}$. If $|L(t)| > 0$ and t' can be obtained from t by deleting a leaf contained in $L(t)$, set $f_n(t, t') = C_{|L(t)|}^{(n)} f_{|L(t)|}^{(n)}(L(t), L(t'))$; if t' can be obtained from t by deleting a leaf contained in $R(t)$, set $f_n(t, t') = C_{|R(t)|}^{(n)} f_{|R(t)|}^{(n)}(R(t), R(t'))$. Notice that the two conditions are mutually exclusive; if neither is satisfied, set $f_n(t, t') = 0$.

We now have, for all t in $\mathbb{T}_n^{(r)}$ such that $|L(t)| = k$ (where $1 \leq k \leq n-2$),

$$\sum_{t' \in \mathbb{T}_{n-1}^{(r)}} f_n(t, t') = C_k^{(n)} \sum_{t_l \in \mathbb{T}_{k-1}^{(r)}} f_k(L(t), t_l) + C_{n-k-1}^{(n)} \sum_{t_r \in \mathbb{T}_{n-k-2}^{(r)}} f_{n-k-1}(R(t), t_r) = C_k^{(n)} + C_{n-k-1}^{(n)}$$

as well as $\sum_{t' \in \mathbb{T}_{n-1}^{(r)}} f_n(t, t') = C_{n-1}^{(n)}$ if $|L(t)| = 0$ or $|L(t)| = n-1$.

Furthermore, for all $t' \in \mathbb{T}_{n-1}^{(r)}$ such that $|L(t')| = k$ (where $0 \leq k \leq n-2$),

$$\sum_{t \in \mathbb{T}_n^{(r)}} f_n(t, t') = C_{k+1}^{(n)} \sum_{t_l \in \mathbb{T}_{k+1}^{(r)}} f_{k+1}(t_l, L(t')) + C_{n-k-1}^{(n)} \sum_{t_r \in \mathbb{T}_{n-k-1}^{(r)}} f_{n-k-1}(t_r, R(t')) = C_{k+1}^{(n)} \frac{|\mathbb{T}_{k+1}^{(r)}|}{|\mathbb{T}_k^{(r)}|} + C_{n-k-1}^{(n)} \frac{|\mathbb{T}_{n-k-1}^{(r)}|}{|\mathbb{T}_{n-k-2}^{(r)}|}.$$

Notice that f_n has property (i) by construction; to enforce properties (ii) and (iii), it is sufficient to choose

$$C_i^{(n)} = \frac{i(i+1)(3n-2i-1)}{(n-1)n(n+1)}$$

for $i = 0, \dots, n-1$, since one then has $C_0^{(n)} = 0$ and $C_i^{(n)} + C_{n-i-1}^{(n)} = 1$ for $0 \leq i \leq n-1$, as well as

$$C_i^{(n)} \frac{|\mathbb{T}_i^{(r)}|}{|\mathbb{T}_{i-1}^{(r)}|} + C_{n-i}^{(n)} \frac{|\mathbb{T}_{n-i}^{(r)}|}{|\mathbb{T}_{n-i-1}^{(r)}|} = C_i^{(n)} r \frac{2(2i-1)}{i+1} + C_{n-i}^{(n)} \frac{2r(2n-2i-1)}{n-i+1} = \frac{2r(2n-1)}{n+1} = \frac{|\mathbb{T}_n^{(r)}|}{|\mathbb{T}_{n-1}^{(r)}|}$$

for all $1 \leq i \leq n-1$, as wanted. \square

Lemma 5.2. *There is a mapping $F : (\mathbb{T}_n^{(r)})^2 \rightarrow \mathbb{T}_{n-1}^{(r)}$ such that for all $t \in \mathbb{T}_n^{(r)}$ and $\tau \in \mathbb{T}_{n-1}^{(r)}$ we have $\{t' | F(t, t') = \tau\} \leq 8r$ and $\{t' | F(t', t) = \tau\} \leq 8r$.*

Proof. Enumerate the elements of $\mathbb{T}_n^{(r)}$ as $t_1, \dots, t_{|\mathbb{T}_n^{(r)}|}$ and the elements of $\mathbb{T}_{n-1}^{(r)}$ as $\tau_1, \dots, \tau_{|\mathbb{T}_{n-1}^{(r)}|}$ in some order. The function that sends (t_a, t_b) to τ_S , where $S = (a+b) \bmod |\mathbb{T}_{n-1}^{(r)}|$, satisfies the requirements. Indeed, we have $|\mathbb{T}_n^{(r)}| = 2r \frac{2n-1}{n+1} |\mathbb{T}_{n-1}^{(r)}| < 4r |\mathbb{T}_{n-1}^{(r)}|$ and therefore $a+b \leq 2|\mathbb{T}_n^{(r)}| < 8r |\mathbb{T}_{n-1}^{(r)}|$. Given $\tau = \tau_S$ and $t = t_a$, there are then at most $8r$ possibilities for $a+b$ and therefore at most $8r$ possibilities for b . \square

We intend to prove lower bounds for the spectral gap of the leaf replanting Markov chain Y by assigning each pair of trees $x, y \in \mathbb{T}_n^{(r)}$ a canonical path of leaf replanting moves turning x into y – or rather a probability measure on the set of possible paths from x to y . Such a probability measure will be constructed by using a set of functions $f_i : \mathbb{T}_i^{(r)} \times \mathbb{T}_{i-1}^{(r)} \rightarrow \mathbb{R}$ with the requirements of Proposition 5.1 and a function $F : (\mathbb{T}_n^{(r)})^2 \rightarrow \mathbb{T}_{n-1}^{(r)}$ as in Lemma 5.2.

Let $L, R : \mathbb{T}_n^{(r)} \rightarrow \bigcup_{i=0}^{n-1} \mathbb{T}_i^{(r)}$ be the mappings defined within the proof of Proposition 5.1 and depicted in Figure 9.

First, given a tree $x \in \mathbb{T}_n^{(r)}$ and a tree $x' \in \mathbb{T}_n^{(r)}$ such that $|L(x')| = n - 1$, we wish to define a probability measure on paths from x to x' . Then, given generic trees $x, y \in \mathbb{T}_n^{(r)}$, we will construct random paths from x to y by concatenating paths from x to z , where $L(z) = F(x, y)$, and from z to y .

Given $t \in \mathbb{T}_n^{(r)}$, consider the set Γ^t of sequences t_0, \dots, t_n such that $t_i \in \mathbb{T}_{n-i}^{(r)}$ and t_{i+1} is obtained from t_i by erasing a leaf; define the probability measure Q^t on Γ^t as

$$Q^t(t_0, \dots, t_n) = \prod_{i=0}^{n-1} f_{n-i}(t_i, t_{i+1}),$$

that is the law of a sequence of random trees $\theta_0, \dots, \theta_n$ such that $\theta_0 = t$ and that, given $\theta_i = t_i \in \mathbb{T}_{n-i}^{(r)}$, the tree θ_{i+1} is chosen in $\mathbb{T}_{n-i-1}^{(r)}$ according to the probability measure $f_{n-i}(t_i, \cdot)$.

Given $x, y \in \mathbb{T}_n^{(r)}$, consider now the set $\Gamma_{x \rightarrow y}$ of all paths $(t_i, t_{i+1})_{i=0}^{2n-1}$ such that

- for all i between 0 and $2n$, the tree t_i belongs to $\mathbb{T}_n^{(r)}$;
- $t_0 = x$, $t_{2n} = y$ and $L(t_n) = F(x, y)$ (which, since $|F(x, y)| = n - 1$, determines t_n);
- the tree t_1 is obtained by replanting a leaf of t_0 onto corner 1; for $0 < i < n$, the tree t_{i+1} is obtained by removing a leaf from $R(t_i)$ and replanting it onto a corner of $L(t_i)$;
- similarly, the tree t_{2n-1} can be obtained by replanting a leaf of t_{2n} onto corner 1; for $n < i < 2n$, the tree t_{i-1} can be obtained by removing a leaf from $R(t_i)$ and replanting it onto a corner of $L(t_i)$.

In other words, for $\gamma = (t_i, t_{i+1})_{i=0}^{2n-1} \in \Gamma_{x \rightarrow y}$, we have that the two sequences $L_1(\gamma) = (L(t_n), \dots, L(t_1))$ and $L_2(\gamma) = (L(t_n), \dots, L(t_{2n-1}))$ belong to $\Gamma^{F(x,y)}$, while $R_1(\gamma) = (t_0, R(t_1), \dots, R(t_n)) \in \Gamma^x$ and $R_2(\gamma) = (t_{2n}, R(t_{2n-1}), \dots, R(t_n)) \in \Gamma^y$. Vice-versa, any quadruple of sequences $L_1, L_2 \in \Gamma^{F(x,y)}$, $R_1 \in \Gamma^x$, $R_2 \in \Gamma^y$ can be assembled into a path $\gamma \in \Gamma_{x \rightarrow y}$.

We can thus construct a probability measure $P_{x \rightarrow y}$ on $\Gamma_{x \rightarrow y}$ by setting

$$P_{x \rightarrow y}(\gamma) = Q^x(R_1(\gamma))Q^y(R_2(\gamma))Q^{F(x,y)}(L_1(\gamma))Q^{F(x,y)}(L_2(\gamma)).$$

Before we prove a lower bound for the spectral gap of the leaf replanting Markov chain, it is useful to establish the following estimate:

Lemma 5.3. *For all $t \in \mathbb{T}_n^{(r)}$ and $i \in \{0, \dots, 2n\}$ we have*

$$\sum_{x, y \in \mathbb{T}_n^{(r)}} P_{x \rightarrow y}(\{\gamma \in \Gamma_{x \rightarrow y} \mid \gamma(i) = t\}) \leq 2(4r)^{n+1},$$

where, if $\gamma = (t_i, t_{i+1})_{i=0}^{2n}$, we write $\gamma(i)$ to indicate t_i .

Proof. As above, given $\gamma \in \Gamma_{x \rightarrow y}$, let us define sequences $R_i(\gamma) = (R_i^0, \dots, R_i^n)$ and $L_i(\gamma) = (L_i^1, \dots, L_i^n)$, for $i = 1, 2$.

If $0 < i \leq n$, we have $\gamma(i) = t$ if and only if $R_1^i = R(t)$ and $L_1^{n+1-i} = L(t)$; therefore, we have

$$\sum_{x, y \in \mathbb{T}_n^{(r)}} P_{x \rightarrow y}(\{\gamma \in \Gamma_{x \rightarrow y} \mid \gamma(i) = t\}) =$$

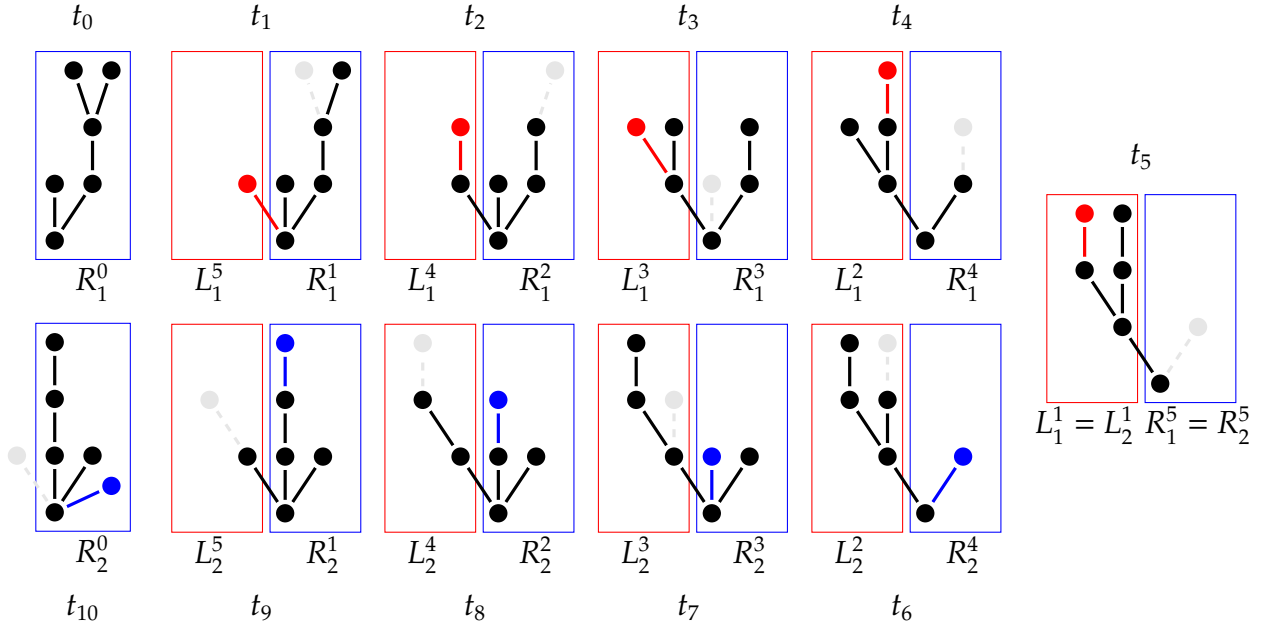

Figure 10: The form of a path in $\Gamma_{t_0 \rightarrow t_{10}}$, where $t_0, t_{10} \in \mathbb{T}_5$; notice how $|L(t_5)| = 4$.

$$= \sum_{x \in \mathbb{T}_n^{(r)}} Q^x(\{(R_j)_{j=0}^n \in \Gamma^x \mid R_i = R(t)\}) \sum_{z \in \mathbb{T}_{n-1}^{(r)}} Q^z(\{(L_j)_{j=1}^n \in \Gamma^z \mid L_{n+1-i} = L(t)\}) \sum_{\substack{y \in \mathbb{T}_n^{(r)} \\ F(x,y)=z}} 1$$

Since we have chosen F as in Lemma 5.2, the internal sum (having fixed x and z) is at most $8r$; as for the other sums, we wish to show that, for any given $t \in \mathbb{T}_k^{(r)}$ and $i \in \{0, \dots, n\}$, we have

$$\sum_{x \in \mathbb{T}_n^{(r)}} Q^x(\{(S_j)_{j=0}^n \in \Gamma^x : S_i = t\}) \leq (4r)^i; \quad (1)$$

but, indeed,

$$\sum_{x \in \mathbb{T}_n^{(r)}} Q^x(\{(S_j)_{j=0}^n \in \Gamma^x : S_i = t\}) = \sum_{\substack{S_0 \in \mathbb{T}_n^{(r)}, \dots, S_{i-1} \in \mathbb{T}_{n-i+1}^{(r)} \\ S_i = t}} \prod_{j=0}^{i-1} f_{n-j}(S_j, S_{j+1}) = \prod_{j=0}^{i-1} \frac{|\mathbb{T}_{n-j}^{(r)}|}{|\mathbb{T}_{n-j-1}^{(r)}|} \leq (4r)^i,$$

which we obtain by separating $S_{i-1}, S_{i-2}, \dots, S_0$ from the sum, one after the other, and using the fact that f_{n-i+1}, \dots, f_n satisfy the requirements of Proposition 5.1.

Using (1) (where one needs to be weary of the fact that – in order to keep notation consistent with previous definitions – R_1 is indexed from 0 and L_1 is indexed from 1) we get

$$\sum_{x, y \in \mathbb{T}_n^{(r)}} P_{x \rightarrow y}(\{\gamma \in \Gamma_{x \rightarrow y} \mid \gamma(i) = t\}) \leq 8r \cdot (4r)^i \cdot (4r)^{n-i} \leq 2(4r)^{n+1}$$

for $0 < i \leq n$; the same estimate is true for $i = 0$, since we have

$$\sum_{y \in \mathbb{T}_n^{(r)}} P_{t \rightarrow y}(\{\gamma \in \Gamma_{t \rightarrow y}\}) = \sum_{z \in \mathbb{T}_{n-1}^{(r)}} \sum_{\substack{y \in \mathbb{T}_n^{(r)} \\ F(x,y)=z}} 1 \leq 8r \cdot |\mathbb{T}_{n-1}^{(r)}| \leq 8r \cdot (4r)^n.$$

The case of $n < i \leq 2n$ is perfectly symmetric. \square

All necessary notation is now in place to prove lower bounds for the spectral gap of both the leaf replanting and leaf translation Markov chains:

Theorem 3. *If γ_Y is the spectral gap of the leaf replanting Markov chain Y on $\mathbb{T}_n^{(r)}$, we have $\gamma_Y \geq C_r n^{-\frac{9}{2}}$ for an appropriate constant C_r independent of n .*

Proof. By the canonical paths method, we have

$$\frac{1}{\gamma_Y} \leq \max_{t, t' \in \mathbb{T}_n^{(r)} : p_Y(t, t') > 0} \frac{1}{\pi(t) p_Y(t, t')} \sum_{x, y \in \mathbb{T}_n^{(r)}} \sum_{\substack{\gamma \in \Gamma_{x \rightarrow y}: \\ (t, t') \in \gamma}} |\gamma| P_{x \rightarrow y}(\gamma) \pi(x) \pi(y),$$

where, if $\gamma = (t_i, t_{i+1})_{i=0}^{N-1}$, we are writing $|\gamma|$ to mean the length N of the sequence, and we say that $(t, t') \in \gamma$ if $t = t_i$ and $t' = t_{i+1}$ for some $i \in \{0, \dots, N-1\}$.

By the description of the leaf replanting Markov chain, we know that (assuming t, t' differ by the replanting of a leaf) $p_Y(t, t') \geq \frac{1}{2rn^2}$; furthermore, every path $\gamma \in \Gamma_{x \rightarrow y}$ (for $x, y \in \mathbb{T}_n^{(r)}$) has length exactly $2n$. Using the fact that π is the uniform measure on $\mathbb{T}_n^{(r)}$ and setting (t, t') to be a pair of trees achieving the maximum above, one obtains

$$\frac{1}{\gamma_Y} \leq \frac{2n \cdot 2rn^2}{|\mathbb{T}_n^{(r)}|} \sum_{x, y \in \mathbb{T}_n^{(r)}} \sum_{(t, t') \in \Gamma_{x \rightarrow y}} P_{x \rightarrow y}(\gamma).$$

All that is left to do is to estimate the sum of all probabilities $P_{x \rightarrow y}(\gamma)$, where γ is a path in some $\Gamma_{x \rightarrow y}$ involving the transition (t, t') . Notice that, if (t, t') appears in γ , then the fact that for $0 < i \leq n$ we have $|L(\gamma(i))| = i - 1$ and for $n \leq i < 2n$ we have $|L(\gamma(i))| = 2n - 1 - i$ implies that either $t = \gamma(0)$, or $t = \gamma(|L(t)| + 1)$, or $t = \gamma(2n - 1 - |L(t)|)$; we therefore have, if we set $S = \{0, |L(t)| + 1, 2n - 1 - |L(t)|\}$,

$$\frac{1}{\gamma_Y} \leq \frac{2n \cdot 2rn^2}{|\mathbb{T}_n^{(r)}|} \sum_{i \in S} \sum_{x, y \in \mathbb{T}_n^{(r)}} P_{x \rightarrow y}(\{\gamma \in \Gamma_{x \rightarrow y} \mid \gamma(i) = t\});$$

by Lemma 5.3, this yields

$$\frac{1}{\gamma_Y} \leq \frac{2n \cdot 2rn^2}{|\mathbb{T}_n^{(r)}|} 3 \cdot 2(4r)^{n+1} \leq C_r \cdot n^{3+\frac{3}{2}} \leq C_r \cdot n^{\frac{9}{2}},$$

as wanted. □

The proof of a lower bound for the spectral gap of the leaf translation Markov chain is analogous, if a little more fiddly:

Theorem 4. *If X is the leaf translation Markov chain on the state space of edge- r -coloured plane trees with n edges $\mathbb{T}_n^{(r)}$ and γ_X is its spectral gap, we have*

$$\gamma_X \geq C_r n^{-\frac{9}{2}}$$

for some constant C_r independent of n .

Proof. Suppose $t, t' \in \mathbb{T}_n^{(r)}$ differ by the replanting and recolouring of a leaf (i.e. are such that $p_X(t, t') > 0$); the leaf being replanted and recoloured may not be uniquely determined, but let v be the leftmost leaf and k be the minimum integer, given v , such that $t' = t^{v, k, c}$. If k is greater than or

equal to the number of the corner of v in t , we construct a “leaf translation path” $\gamma(t, t') = (t_i, t_{i+1})_{i=0}^{N-1}$ from t to t' by setting $t_0 = t, t_{i+1} = t_i^{v, \rightarrow}$ and choosing N to be as small as possible and such that t_{N-1} is t' up to the recolouring of the replanted leaf; finally, we set $t_N = t_{N-1}^{v, c}$. Similarly, if the corner of v in t is indexed by a number strictly greater than k , we construct $\gamma(t, t')$ as a (minimal) sequence of leftward translations of v , followed by a recolouring.

Given $t_0, t_{2n} \in \mathbb{T}_n^{(r)}$ and $\gamma = (t_i, t_{i+1})_{i=0}^{2n-1} \in \Gamma_{t_0 \rightarrow t_{2n}}$, we can now define a “leaf translation” path γ^X by concatenating $\gamma_0, \dots, \gamma_{2n-1}$, where $\gamma_i = \gamma(t_i, t_{i+1})$. We call $\Gamma_{t_0 \rightarrow t_{2n}}^X$ the set $\{\gamma^X \mid \gamma \in \Gamma_{t_0 \rightarrow t_{2n}}\}$. Notice that $\gamma \mapsto \gamma^X$ is a bijection between $\Gamma_{t_0 \rightarrow t_{2n}}$ and $\Gamma_{t_0 \rightarrow t_{2n}}^X$, since the sequence γ can be reconstructed from γ^X by setting $\gamma(0) = \gamma^X(0)$ and $\gamma(i+1) = \gamma^X(x)$, where

$$x = \min\{j > i \mid \gamma^X(j) \text{ is of the form } \gamma^X(j-1)^{v, c} \text{ with } c \notin \{\leftarrow, \rightarrow\}\}.$$

We can therefore define a probability measure on $\Gamma_{t_0 \rightarrow t_{2n}}^X$, which we still call $P_{t_0 \rightarrow t_{2n}}$, by simply setting $P_{t_0 \rightarrow t_{2n}}(\gamma^X) = P_{t_0 \rightarrow t_{2n}}(\gamma)$.

By the canonical paths method, we have

$$\frac{1}{\gamma_X} \leq \max_{t, t' \in \mathbb{T}_n^{(r)}: p_X(t, t') > 0} \frac{1}{\pi(t)p_X(t, t')} \sum_{x, y \in \mathbb{T}_n^{(r)}} \sum_{\substack{\gamma \in \Gamma_{x \rightarrow y}: \\ (t, t') \in \gamma^X}} |\gamma^X| P_{x \rightarrow y}(\gamma) \pi(x) \pi(y).$$

Notice that for all γ we have $|\gamma^X| \leq 4n^2$ (by Remark 5.1) and, for all $t, t' \in \mathbb{T}_n^{(r)}$ such that $p_X(t, t') > 0$, we have $p_X(t, t') \geq \frac{1}{n(r+2)}$. We therefore have, if we also replace occurrences of $\pi(\cdot)$ with $|\mathbb{T}_n^{(r)}|^{-1}$,

$$\frac{1}{\gamma_X} \leq \frac{4n^3(r+2)}{|\mathbb{T}_n^{(r)}|} \max_{(t, t^{v, c})} \sum_{x, y \in \mathbb{T}_n^{(r)}} \sum_{\substack{\gamma \in \Gamma_{x \rightarrow y}: \\ (t, t^{v, c}) \in \gamma^X}} P_{x \rightarrow y}(\gamma).$$

Given a leaf translation or recolouring $(t, t^{v, c})$, we now wish to determine which paths $\gamma = (t_i, t_{i+1})_{i=0}^{2n-1} \in \Gamma_{t_0 \rightarrow t_{2n}}$ are such that $(t, t^{v, c})$ appears in γ^X .

If $c \notin \{\rightarrow, \leftarrow\}$, then $t^{v, c} = t_i$ for some i which is almost univocally determined by $|L(t^{v, c})|$: we necessarily have $i = 2n$ or $i = |L(t^{v, c})| + 1$ or $i = 2n - |L(t^{v, c})| - 1$. We therefore find that

$$\sum_{x, y \in \mathbb{T}_n^{(r)}} \sum_{\substack{\gamma \in \Gamma_{x \rightarrow y}: \\ (t, t^{v, c}) \in \gamma^X}} P_{x \rightarrow y}(\gamma) \leq \sum_{x, y \in \mathbb{T}_n^{(r)}} \sum_{\substack{i \in \{2n, |L(t)|+1, \\ 2n-1-|L(t)\}}} P_{x \rightarrow y}(\{\gamma \in \Gamma_{x \rightarrow y} \mid \gamma(i) = t\}) \leq 6 \cdot (4r)^{n+1}$$

If $x = \leftarrow$, consider the tree τ obtained by removing v from t' . We must have either $\tau = R(t_1)$, or $\tau = R(t_{2n-1})$, or $R(\tau) = R(t_i)$ and $L(\tau) = L(t_{i-1})$, with $i = |L(\tau)| + 1$. Similarly for $x = \rightarrow$: either $\tau = R(t_1)$, or $\tau = R(t_{2n-1})$, or $R(\tau) = R(t_{i-1})$ and $L(\tau) = L(t_i)$, with $i = 2n - 1 - |L(\tau)|$. The proof of Lemma 5.3 can be modified slightly to yield that, for any fixed $i \in \{1, \dots, n\}$ and $a, b \in \bigcup_{j=0}^n \mathbb{T}_j^{(r)}$, we have

$$\sum_{x, y \in \mathbb{T}_n^{(r)}} P_{x \rightarrow y}(\{\gamma \in \Gamma_{x \rightarrow y} \mid R(\gamma(i)) = a, L(\gamma(i-1)) = b\}) \leq 2(4r)^{n+1}.$$

Applying both the original inequality from Lemma 5.3 and this variant yields that, when $c \in \{\rightarrow, \leftarrow\}$,

$$\sum_{x, y \in \mathbb{T}_n^{(r)}} \sum_{\substack{\gamma \in \Gamma_{x \rightarrow y}: \\ (t, t^{v, c}) \in \gamma^X}} P_{x \rightarrow y}(\gamma) \leq 6 \cdot (4r)^{n+1}.$$

Finally, this entails

$$\frac{1}{\gamma_X} \leq \frac{24n^3(r+2)}{|\Gamma_n^{(r)}|} (4r)^{n+1} \leq C_r \cdot n^{\frac{9}{2}}$$

for some constant C_r independent of n . □

6 A lower bound for the spectral gap of \mathcal{F}^n

6.1 Comparing $\mathcal{F}^{n,\bullet}$ to the leaf translation Markov chain

We will now set up a comparison à la Diaconis–Saloff-Coste between the Markov chain $\mathcal{F}^{n,\bullet}$ and a variant of the leaf translation Markov chain X on LT_n ; as per Theorem 2, we have an explicit bijection ϕ between the state space \mathbf{Q}_n^\bullet of $\mathcal{F}^{n,\bullet}$ and the set $\text{LT}_n \times \{-1, 1\}$.

A (reversible, irreducible and aperiodic) variant \widetilde{X} of the leaf translation Markov chain can be defined on $\text{LT}_n \times \{-1, 1\} = \Gamma_n^{(3)} \times \{-1, 1\}$, where we consider the set of edge colours to be $\{+, -, =\}$ rather than $\{1, 2, 3\}$, as follows: conditionally on $\widetilde{X}_k = (t, \varepsilon)$, where $t \in \text{LT}_n$ and $\varepsilon \in \{-1, 1\}$, we set

- $\widetilde{X}_{k+1} = (t, -\varepsilon)$ with probability $\frac{1}{n+1}$
- with probability $\frac{n}{n+1}$, we select a random edge $(v, p(v))$ of t ; if v is not a leaf, we set $\widetilde{X}_{k+1} = (t, \varepsilon)$; if v is a leaf, we set \widetilde{X}_{k+1} to be one of $(t^{v,\rightarrow}, \varepsilon)$, $(t^{v,\leftarrow}, \varepsilon)$, $(t^{v,+}, \varepsilon)$, $(t^{v,-}, \varepsilon)$, $(t^{v,=}, \varepsilon)$, each with probability $\frac{1}{5}$ given the choice of v .

From Proposition 4 we can deduce the following analogous estimate for the spectral gap of this chain:

Corollary 6.1. *If $\widetilde{\gamma}$ is the spectral gap of the Markov chain \widetilde{X} on the state space $\text{LT}_n \times \{-1, 1\}$ as defined above, we have $\widetilde{\gamma} \geq Cn^{-\frac{9}{2}}$ for some constant C .*

Proof. Let $f : \text{LT}_n \times \{-1, 1\} \rightarrow \mathbb{R}$ be a function such that $\mathbb{E}_\pi(f) = 0$, $\mathbb{V}_\pi(f) = 1$ and $\widetilde{\gamma} = \mathcal{E}_{\widetilde{X}}(f, f)$, where π is the uniform measure on $\text{LT}_n \times \{-1, 1\}$ and $\mathcal{E}_{\widetilde{X}}$ is the Dirichlet form for the Markov chain \widetilde{X} . Then

$$\widetilde{\gamma} = \frac{1}{2} \sum_{\substack{t \in \text{LT}_n \\ v \text{ leaf of } t \\ x \in \{\rightarrow, \leftarrow, +, -, =\} \\ \varepsilon \in \{-1, 1\}}} (f(t, \varepsilon) - f(t^{v,x}, \varepsilon))^2 \frac{1}{2|\text{LT}_n|} \frac{1}{5(n+1)} + \frac{1}{2} \sum_{\substack{t \in \text{LT}_n \\ \varepsilon \in \{-1, 1\}}} (f(t, \varepsilon) - f(t, -\varepsilon))^2 \frac{1}{2|\text{LT}_n|} \frac{1}{n+1}.$$

Consider now the maps $f_1, f_{-1} : \text{LT}_n \rightarrow \mathbb{R}$ defined so that $f_\varepsilon(t) = f(t, \varepsilon)$ and the leaf translation Markov chain X on LT_n . We can immediately identify the first of the two sums above as

$$\frac{n}{2(n+1)} (\mathcal{E}_X(f_1, f_1) + \mathcal{E}_X(f_{-1}, f_{-1})).$$

On the other hand, a lower bound for the second sum is given by $\frac{1}{2(n+1)} \mathbb{V}(\mathbb{E}(f|\varepsilon))$, where $\varepsilon : \text{LT} \times \{-1, 1\} \rightarrow \{-1, 1\}$ is the projection on the second component, since a simple application of the Cauchy-Schwarz inequality gives

$$\sum_{\substack{t \in \text{LT}_n \\ \varepsilon \in \{-1, 1\}}} (f(t, \varepsilon) - f(t, -\varepsilon))^2 \frac{1}{2|\text{LT}_n|} \frac{1}{n+1} = \frac{1}{(n+1)4|\text{LT}_n|^2} \left(\sum_{\substack{t \in \text{LT}_n \\ \varepsilon \in \{-1, 1\}}} (f(t, \varepsilon) - f(t, -\varepsilon))^2 \right) \left(\sum_{\substack{t \in \text{LT}_n \\ \varepsilon \in \{-1, 1\}}} 1^2 \right) \geq$$

$$\geq \frac{1}{n+1} \frac{1}{4} \left(\frac{1}{|\text{LT}_n|} \sum_{t \in \text{LT}_n} f_1(t) - \frac{1}{|\text{LT}_n|} \sum_{t \in \text{LT}_n} f_{-1}(t) \right)^2 = \frac{1}{n+1} \mathbb{V}(\mathbb{E}(f|\varepsilon)).$$

We thus have

$$\begin{aligned} \tilde{\gamma} &\geq \frac{n}{2(n+1)} (\mathcal{E}_X(f_1, f_1) + \mathcal{E}_X(f_{-1}, f_{-1})) + \frac{1}{2(n+1)} \mathbb{V}(\mathbb{E}(f|\varepsilon)) \geq \\ &\geq \frac{n\gamma}{2(n+1)} (\mathbb{V}(f|\varepsilon = 1) + \mathbb{V}(f|\varepsilon = -1)) + \frac{1}{2(n+1)} \mathbb{V}(\mathbb{E}(f|\varepsilon)) = \frac{n\gamma}{n+1} \mathbb{E}(\mathbb{V}(f|\varepsilon)) + \frac{1}{2(n+1)} \mathbb{V}(\mathbb{E}(f|\varepsilon)), \end{aligned}$$

where γ is the spectral gap of the leaf translation Markov chain X on LT_n . Finally, using Proposition 4, the variance decomposition formula and the fact that $\mathbb{V}_\pi(f) = 1$, we obtain that, for some constants C' and C

$$\tilde{\gamma} \geq \frac{n}{(n+1)n^{\frac{9}{2}}} C' (\mathbb{E}(\mathbb{V}_\pi(f|\varepsilon)) + \mathbb{V}_\pi(\mathbb{E}_\pi(f|\varepsilon))) \geq \frac{C}{n^{\frac{9}{2}}}.$$

□

We are now ready to set up a comparison between the chains \tilde{X} and $\mathcal{F}^{n,\bullet}$. In order to do this, we will devote the next section to explicitly building sequences of quadrangulation edge flips that turn $\phi(t, \varepsilon)$ into $\phi(t', \varepsilon')$, where (t, ε) and (t', ε') are elements of $\text{LT}_n \times \{-1, 1\}$ that are adjacent according to the graph of the Markov chain \tilde{X} .

In particular, for each t, v, x, ε such that $t \in \text{LT}_n$, v is a leaf of t , $x \in \{\rightarrow, \leftarrow, +, =, -\}$ and $\varepsilon = \pm 1$, we shall build a sequence of quadrangulation edge flips $P_\varepsilon(t, t^{v,x}) = (q_i, e_i, s_i)_{i=1}^N$, such that

- $q_i \in \mathbf{Q}_n, e_i \in E(q_i), s_i \in \{+, -\};$
- $q_1 = \phi(t, \varepsilon);$
- $q_{N+1} = \phi(t^{v,x}, \varepsilon);$
- $q_{i+1} = q_i^{e_i, s_i}.$

Notice that (as we remarked in Section 2) we can naturally identify vertices of q_i with vertices of q_{i+1} and edges of q_i with edges of q_{i+1} by building q_{i+1} via the procedure described for flipping e_i . We will therefore often define edges e_1, \dots, e_N as edges of q_1 , since edges in $E(q_1)$ have a natural interpretation in $E(q_2), \dots, E(q_N)$.

Similarly, we will also build sequences $P(t) = (q_i, e_i, s_i)_{i=1}^N$ such that $q_1 = \phi(t, 1)$, $q_{N+1} = \phi(t, -1)$ and $q_{i+1} = q_i^{e_i, s_i}$.

Having constructed these in an appropriate way, a comparison of the Markov chains $\mathcal{F}^{n,\bullet}$ and \tilde{X} will yield Theorem 1. Indeed, let $f : \mathbf{Q}_n^\bullet \rightarrow \mathbb{R}$ be a function such that $\mathbb{V}_\pi^\bullet(f) = 1$ (where π^\bullet is the uniform measure on \mathbf{Q}_n^\bullet) and $\mathcal{E}_{\mathcal{F}^{n,\bullet}}(f, f) = \nu_n^\bullet$. Then thanks to Corollary 6.1 we have

$$\begin{aligned} Cn^{-\frac{9}{2}} \leq \tilde{\gamma} &\leq \mathcal{E}_{\tilde{X}}(f \circ \phi, f \circ \phi) = \frac{1}{2} \sum_{\substack{t, t' \in \text{LT}_n \\ \varepsilon, \varepsilon' \in \{-1, 1\}}} (f(\phi(t, \varepsilon)) - f(\phi(t', \varepsilon')))^2 \frac{1}{2|\text{LT}_n|} p_{\tilde{X}}(t, t') = \\ &= \frac{1}{2} \sum_{\substack{t \in \text{LT}_n \\ v \text{ leaf of } t \\ x \in \{\rightarrow, \leftarrow, +, -, =\} \\ \varepsilon \in \{1, -1\}}} (f(\phi(t, \varepsilon)) - f(\phi(t^{v,x}, \varepsilon)))^2 \frac{1}{2|\text{LT}_n|} \frac{1}{5(n+1)} + \sum_{t \in \text{LT}_n} (f(\phi(t, 1)) - f(\phi(t, -1)))^2 \frac{1}{2|\text{LT}_n|} \frac{1}{n+1}. \end{aligned}$$

Now we may rewrite each difference within the sums above in terms of the images of subsequent quadrangulations appearing in the paths $P_\varepsilon(t, t^{v,x})$ and $P(t)$, apply the Cauchy-Schwarz inequality and tweak the constants in order to recover factors of the form $p_{\mathcal{F}^n \bullet}(q, q')$. We obtain that the expression above is at most

$$\begin{aligned} & \frac{1}{2|\mathbb{L}\mathbb{T}_n|} \frac{1}{n} \left(\sum_{\substack{t \in \mathbb{L}\mathbb{T}_n \\ v \text{ leaf of } t \\ x \in \{\rightarrow, \leftarrow, +, -, =\} \\ \varepsilon \in \{1, -1\}}} \left(\sum_{\substack{i=0, \dots, |P_\varepsilon(t, t^{v,x})| \\ P_\varepsilon(t, t^{v,x}) = (q_i, e_i, s_i)_{i=1}^N}} f(q_i) - f(q_i^{e_i, s_i}) \right)^2 + \sum_{t \in \mathbb{L}\mathbb{T}_n} \left(\sum_{\substack{i=0, \dots, |P(t)| \\ P(t) = (q_i, e_i, s_i)_{i=1}^N}} f(q_i) - f(q_i^{e_i, s_i}) \right)^2 \right) \leq \\ & \leq 6 \sum_{\substack{t \in \mathbb{L}\mathbb{T}_n \\ v \text{ leaf of } t \\ x \in \{\rightarrow, \leftarrow, +, -, =\} \\ \varepsilon \in \{1, -1\}}} |P_\varepsilon(t, t^{v,x})| \sum_{\substack{i=0, \dots, |P_\varepsilon(t, t^{v,x})| \\ P_\varepsilon(t, t^{v,x}) = (q_i, e_i, s_i)_{i=1}^N}} (f(q_i) - f(q_i^{e_i, s_i}))^2 \frac{1}{|\mathbb{Q}_n^\bullet|} \frac{1}{6n} + \\ & + 6 \sum_{t \in \mathbb{L}\mathbb{T}_n} |P(t)| \sum_{\substack{i=0, \dots, |P(t)| \\ P(t) = (q_i, e_i, s_i)_{i=1}^N}} (f(q_i) - f(q_i^{e_i, s_i}))^2 \frac{1}{|\mathbb{Q}_n^\bullet|} \frac{1}{6n}. \end{aligned}$$

Given $q \in \mathbb{Q}_n$, $e \in E(q)$, $s \in \{+, -\}$ write $C(q, e, s)$ for

$$|\{t, v, x, \varepsilon \mid (q, e, s) \text{ appears in } P_\varepsilon(t, t^{v,x})\}| + |\{t \mid (q, e, s) \text{ appears in } P(t)\}|$$

and set $M_n = \max_{q, e, s} C(q, e, s)$; a double counting argument combined with linear estimates in n we will establish for $|P_\varepsilon(t, t^{v,x})|$ and $|P(t)|$ (see Corollary 6.11) leads to

$$Cn^{-\frac{9}{2}} \leq C'n \sum_{\substack{q \in \mathbb{Q}_n^\bullet \\ e \in E(q) \\ s \in \{+, -\}}} C(q, e, s) (f(q) - f(q^{e,s}))^2 \frac{1}{|\mathbb{Q}_n^\bullet|} \frac{1}{6n} \leq C'n \cdot M_n \cdot \mathcal{E}_{\mathcal{F}^n \bullet}(f, f) = C'n \cdot M_n \cdot \nu_n^\bullet.$$

Our aim at the end of this section will be to show that M_n – given our choice for the paths $P(t, t^{v,x})$ and $P(t)$ – is bounded above by a constant independent of n , thus immediately establishing a constant lower bound for $\nu_n^\bullet/n^{-11/2}$ and, as a consequence, Theorem 1.

6.2 The sequence $P(t)$

As a matter of fact, we have already discussed the sequence $P(t)$ in Lemma 2.2.

From the Schaeffer construction within Section 3 one can immediately see that $\phi(t, -1)$ can be obtained from $\phi(t, 1)$ by simply giving the root edge the opposite orientation. If the root edge is not a double edge, this can be achieved via flips by just flipping it three times in the same direction, so we can set $P(t) = (q_i, e_i, s_i)_{i=1}^3$, with $q_1 = \phi(t, 1)$, $s_1 = s_2 = s_3 = +$ and e_i being the root edge of q_i , for $i = 1, 2, 3$.

If the root edge of $\phi(t, 1)$ is a double edge within a degenerate face, one need only perform an extra flip on one of the boundary edges of the degenerate face before and after flipping the root edge three times. Setting $q_1 = \phi(t, 1)$ and assuming e' is the edge before the root edge in the clockwise contour of its degenerate face, we set $P(t) = (q_i, e_i, s_i)_{i=1}^5$, with $e_1 = e'$, $s_1 = s_2 = s_3 = s_4 = +$, e_i is the root edge of q_i for $i = 2, 3, 4$, and $e_5 = e'$, $s_5 = -$ (see Figure 11).

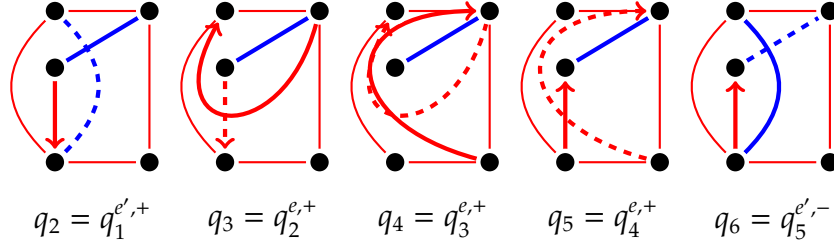

Figure 11: A sequence of flips $P(t) = (q_i, e_i, s_i)_{i=1}^5$, where the root edge of $q_1 = \phi(t, 1)$ is a double edge within a degenerate face. Notice that either the sequence $(q_2, e_2, s_2), (q_3, e_3, s_3), (q_4, e_4, s_4)$ or the sequence $(q_5, e_4, -s_4), (q_4, e_3, -s_3), (q_3, e_2, -s_2)$ is an example of $P(t')$, for some t' such that the root of $\phi(t', 1)$ is not a double edge within a degenerate face.

Lemma 6.2. For all $t \in \text{LT}_n$, we have $|P(t)| \leq 5$. Moreover, given a triple (q, e, s) where $q \in \mathbf{Q}_n$, $e \in E(q)$, $s \in \{+, -\}$, we have

$$|\{t \mid (q, e, s) \text{ appears in } P(t)\}| \leq 9$$

Proof. The first part of the statement is clear by definition.

As for the second part, if t is a tree such that (q, e, s) appears in $P(t)$ and the root of $\phi(t, 1)$ is not a double edge, then $\phi(t, -1)$ is obtained by flipping the root edge of q one, two or three times, so there are at most three possibilities for t .

If (q, e, s) appears in $\phi(t)$, where e is the root edge of q and the root edge of $\phi(t, 1)$ is *not* a double edge, then one or more among $q, q^{e,-}$ and $(q^{e,-})^{e,-}$ have one or both endpoints of the root edge of degree 2; setting e' to be such that e, e' share an endpoint of degree 2 in $q' \in \{q, q^{e,-}, (q^{e,-})^{e,-}\}$, $\phi(t, 1)$ must be of the form $q^{e',-}$, and therefore t be one of at most 6 possible labelled trees.

If e is *not* the root edge of q and $s = -$, then $\phi(t, -1) = q^{e,s}$; if $s = +$, $\phi(t, 1) = q$. \square

6.3 The colour change sequences $P_\varepsilon(t, t^{v,-}), P_\varepsilon(t, t^{v,=}), P_\varepsilon(t, t^{v,+})$

This section will be devoted to constructing the sequences $P_\varepsilon(t, t^{v,c})$, where $t \in \text{LT}_n$, $\varepsilon \in \{-1, 1\}$, v is a leaf of t and $c \in \{-, =, +\}$, i.e. sequences of quadrangulation edge flips whose aim is to achieve a “colour change”, or equivalently a “label change”, from the leaf translation Markov chain \tilde{X} on $\text{LT}_n \times \{-1, 1\}$.

Given a leaf label change $(t, t^{v,c})$, where $c \in \{=, +, -\}$, we need construct a sequence $P_\varepsilon(t, t^{v,c}) = (q_i, e_i, s_i)_{i=1, \dots, N}$ such that $q_1 = \phi(t, \varepsilon)$, $q_{i+1} = q_i^{e_i, s_i}$ and $q_{N+1} = \phi(t^{v,c}, \varepsilon)$. Our aim will then consist in estimating the maximum length N of such sequences in terms of n , as well as the number of quadruples (t, v, c, ε) , where $t \in \text{LT}_n$, v is a leaf in t , $c \in \{=, +, -\}$ and $\varepsilon \in \{-1, 1\}$, such that a fixed triple (q, e, s) appears in the sequence $P_\varepsilon(t, t^{v,c})$.

We shall describe explicitly all sequences of the form $P_\varepsilon(t, t^{v,+})$, where $l(v) = l(p(v))$ in t , and $P_\varepsilon(t, t^{v,-})$, where $l(v) - l(p(v)) = 1$ in t , that “is colour changes” from $=$ to $+$ and from $+$ to $-$. All other sequences will be built from these in the natural way, by concatenating them and/or running them backwards. If $t^{v,x} = t$, we set $P_\varepsilon(t, t^{v,x})$ to be empty.

Let us first consider the case of a colour change from $=$ to $+$, which is easily dealt with, since we have:

Lemma 6.3. Given $(t, \varepsilon) \in \text{LT}_n \times \{-1, 1\}$ and a leaf v of t such that $l(v) = l(p(v))$, the quadrangulations $q = \phi(t, \varepsilon)$ and $q' = \phi(t^{v,+}, \varepsilon)$ differ by a quadrangulation edge flip.

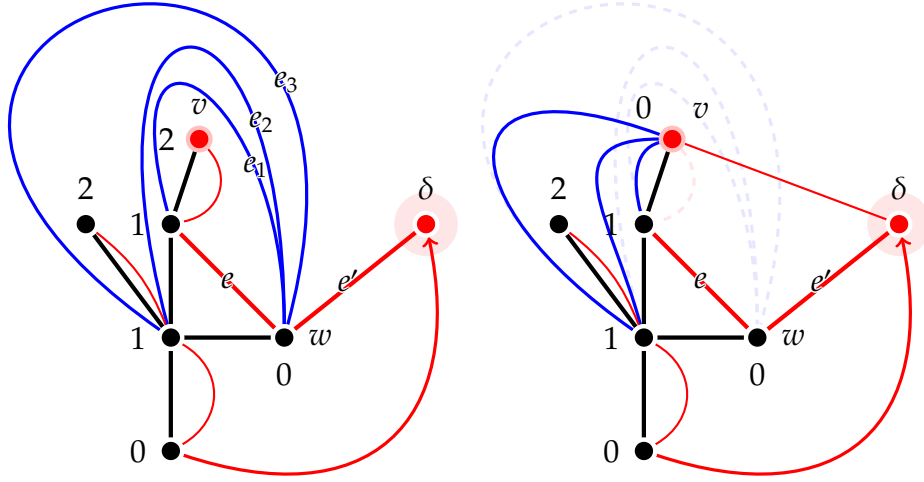

Figure 12: The quadrangulations $\phi(t, 1)$ and $\phi(t^{v^-}, 1)$ for a tree $t \in \text{LT}_5$ such that $l(v) = l(p(v)) + 1$.

Proof. Consider all corners of t but the one corner around the leaf v ; their target corners as determined by the Schaeffer bijection are unaffected by increasing the label of v , by definition. In particular, the two corners immediately before and after the corner of v in the contour, which are corners of $p(v)$, share the same target corner before and after the label change, making the quadrangulation face which corresponds to the tree edge $(v, p(v))$ a degenerate face. The only effect of the label increase is that of changing the target of the v corner to the appropriate corner of $p(v)$, i.e. flipping the double edge e within the aforementioned degenerate face of $\phi(t, \varepsilon)$. Also notice that the edge issued from the root corner of t (which cannot be the corner of the leaf v) is unaffected both by the label change and by the flip, so we do have $\phi(t^{v,+}, \varepsilon) = \phi(t, \varepsilon)^{e,+}$. \square

It is therefore natural, when $l(v) = l(p(v))$, to set $P_\varepsilon(t, t^{v,+})$ to $(q, e, +)$, where e is the double edge of $\phi(t, \varepsilon)$ incident to the vertex v . Similarly, we will set $P_\varepsilon(t^{v,+}, (t^{v,+})^{v,-}) = P_\varepsilon(t^{v,+}, t) = (q^{e,+}, e, -)$, thus covering all the cases of a colour change from $+$ to $-$ and vice-versa with flip sequences of length 1.

The construction of sequences of the type $P_\varepsilon(t, t^{v,-})$ is less immediate. First, let us give a “static” description of how the label change affects the corresponding quadrangulation.

Lemma 6.4. Consider a pair $(t, \varepsilon) \in \text{LT}_n \times \{-1, 1\}$ and a leaf v of t such that $l(v) = l(p(v)) + 1$; let c be the corner of $p(v)$ right after the corner of v in the clockwise contour of t . Suppose the target corner of c is adjacent to a vertex $w \in V(t)$ and consider the quadrangulation edges e and e' drawn by the Schaeffer correspondence between c and $t(c)$, and between $t(c)$ and $t(t(c))$, respectively. Let e_1, \dots, e_k be the edges incident to w lying strictly between e and e' , in clockwise order around w . If the target of corner c is the corner around the vertex δ , let e_1, \dots, e_k be all quadrangulation edges incident to δ .

The quadrangulation $q' = \phi(t^{v,-}, \varepsilon)$ can be obtained from $q = \phi(t, \varepsilon)$ by erasing the part of the edges e_1, \dots, e_k that intersects a suitably small neighbourhood of w (or δ) and “rerouting” such edges to v (in the natural planar way), then replacing the quadrangulation edge issued from v with one joining v to $t(t(c))$ (or to δ , if $t(c)$ is the corner around δ): see Figure 12. Notice that, if the root edge of $q = \phi(t, \varepsilon)$ is one of e_1, \dots, e_k , then it is “rerouted” to v and maintains the same orientation in q' (and, if it is not, then it is “preserved”).

Proof. Let c_1, \dots, c_{2n} be the corners in the clockwise contour of t , and suppose c_l is the corner around the leaf v . Let us first suppose that $l(c_{l+1})$ is not the minimal label in the tree (i.e. that its

target is not the corner around δ). Notice that decreasing the label of v (by 2) does not affect any edges drawn by the Schaeffer correspondence other than

- the edge drawn from c_l to c_{l+1} , which is replaced by an edge between c_l and $t(c_{l+1})$, that is the first corner labelled $l(p(v)) - 2$ in the clockwise contour after c_l ;
- all edges drawn from c_i to $t(c_i)$, where $t(c_i) = t(c_{l+1})$ and c_i does not lie between c_l and $t(c_{l+1})$, since the target of c_i becomes c_l if the label of c_l is decreased by 2; indeed, those are replaced by edges joining c_i to c_l .

The fact that all other targets remain the same should be clear: if only the label of c_l is changed, the target of a corner $c \neq c_l$ may change only by becoming c_l or by no longer being c_l . Since c_l is not the target of any other corner in t , the edges affected are those for which c_l lies between their origin corner and their target corner, labelled $l(c_{l+1}) - 1$, in the clockwise contour, as described above.

All that is left to show is that those edges are e_1, \dots, e_k ; indeed they are edges whose target is a corner of w and whose origin corner comes after $t(c_{l+1})$ and before c_l (or, equivalently, strictly before c_{l+1}), in the (cyclic) clockwise contour; that is, they lie strictly between $e = (c_{l+1}, t(c_{l+1}))$ and $e' = (t(c_{l+1}), t(c_{l+1}))$.

If $t(c_{l+1})$ is the corner around δ in t , then what happens when the label of v is changed is even simpler, since v becomes the unique vertex with minimal label: all corners whose target in t is the corner around δ change their target to c_l in $t^{v,-}$, including c_{l-1} and c_{l+1} , while the edge (c_l, c_{l+1}) is replaced by one joining v to δ , which will have degree 1 in $\phi(t^{v,-}, \varepsilon)$. \square

Before we give an actual description of a sequence of quadrangulation flips that achieves exactly the changes described by Lemma 6.4, we shall construct a sequence of flips that will be useful in what follows and whose only aim is to change the root edge of a quadrangulation by “exchanging” two edges.

Lemma 6.5. *Consider a quadrangulation $q \in \mathbf{Q}_n^\bullet$; let $e = (v, w)$ be its root edge (with either v or w being the origin) and let η be the edge after e in clockwise order around v , which we suppose distinct from e . Let q' be the same quadrangulation (with the same distinguished vertex), rerooted in η and with v as the origin if and only if v was the origin in q . Define the sequence of quadrangulation flips $P(q, q') = (q_i, e_i, s_i)_{i=1}^5$ so that $q_{i+1} = q_i^{e_i, s_i}$, $q_1 = q$, $e_1 = e_3 = e_5 = \eta$, $e_2 = e_4 = e$, $s_1 = s_2 = s_3 = +$, $s_4 = s_5 = -$ (see Figure 13). Then $q_6 := q_5^{e_5, s_5} = q'$.*

Proof. Consider the union of the faces of q that are adjacent to e or to η ; unless either e or η is a double edge within a degenerate face, this is a (generalised) octagon, in the sense that its boundary has an inner contour with exactly 8 corners, which we can cyclically number as c_0, \dots, c_7 . We can suppose η joins c_0 to c_5 and e joins c_0 to c_3 ; it is then immediate to verify, as in Figure 13, that the given sequence of flips ultimately results in η joining c_0 to c_3 and e joining c_0 to c_5 .

An analogous check can be performed for the case where e or η is a double edge, where one deals with a hexagon rather than an octagon (lower part of Figure 13). \square

We can now present the construction of the flip path corresponding to a colour change from $+$ to $-$ on an edge $(v, p(v))$, where v is a leaf of a labelled tree t :

Lemma 6.6 (Construction of the path, $+$ to $-$). *With the same notation as in Lemma 6.4, consider t, v, ε and the edges e_1, \dots, e_k of $\phi(t, \varepsilon)$, all incident to a vertex w (possibly δ). If the root edge of $\phi(t, \varepsilon)$ does not belong to $\{e_1, \dots, e_k\}$, then set $P_\varepsilon(t, t^{v,-}) = (q_i, e_i, -)_{i=1}^k$, where $q_1 = \phi(t, \varepsilon)$ and $q_{i+1} = q_i^{e_i, -}$. If some e_j is the root of $\phi(t, \varepsilon)$, then set $P_\varepsilon(t, t^{v,-})$ to be the path described above, with the sequence of flips described in Lemma 6.5 for the rotation of the root edge e_j around its endpoint that is not w , injected right before the flip*

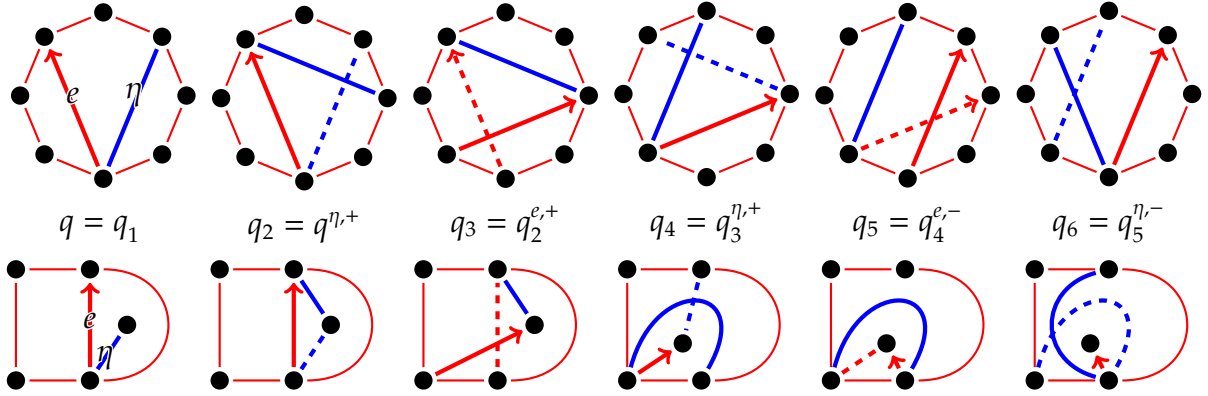

Figure 13: The flip path $P(q, q') = (q_i, e_i, s_i)_{i=1}^5$ reroots q , rooted in e , in the edge η ; above, the case where the union of faces adjacent to e and η has 8 corners. Below, the case where η is a double edge within a degenerate face; the case where e is a double edge is analogous.

$(q_j, e_j, -)$. For simplicity, we shall not renumber the quadrangulations q_1, \dots, q_k in this case, but q_j and q_{j+1} will be 6 flips rather than one flip apart.

$$\text{Then } q_k^{e_k,-} = \phi(t^{v,-}, \varepsilon).$$

Proof. Consider the edges adjacent to v in the quadrangulation $\phi(t^{v,-}, \varepsilon)$ and number them as η_0, \dots, η_k , in clockwise order around v , so that η_0 is the (unique) edge of $\phi(t^{v,-}, \varepsilon)$ joining v to $p(v)$.

We can show by induction that the quadrangulation q_i is the quadrangulation q_1 , where edges e_1, \dots, e_{i-1} have been replaced by edges $\eta_1, \dots, \eta_{i-1}$ (and the natural edge identification after the flip sequence pairs e_1 with η_1 , e_2 with η_2 , and so on) – see Figure 14. Indeed, if this is true for q_i , then the edge e_i as seen in q_i is adjacent to two faces, one in whose clockwise contour it's preceded by η_{i-1} , one in whose clockwise contour it's preceded by e_{i+1} (where we set e_{k+1} to be the edge between $t(c)$ and $t(t(c))$). It follows that flipping e_i counterclockwise results in an edge joining the appropriate endpoint of e_{i+1} to v , which does correspond to creating η_i . Since η_0 can already be identified with an edge of q_1 , the final quadrangulation $q_k^{e_k,-}$ is $\phi(t^{v,-}, \varepsilon)$, up to rerooting.

If some e_j is the root edge of $q_1 = \phi(t, \varepsilon)$, then – as described in Lemma 6.4 – η_{j-1} is the root edge of $\phi(t^{v,-}, \varepsilon)$, oriented towards v if and only if the root of q_1 is oriented towards w . We have shown that in q_j edges e_j and η_{j-1} do belong to the same face, e_j coming right after η_{j-1} in its clockwise contour; performing the appropriate root rotation sequence of flips on q_j has exactly the effect of rerooting q_j in η_{j-1} (with the desired orientation); after that is done, one can proceed with the “normal” flip sequence to obtain $q_k^{e_k,-}$, which is now rooted correctly. \square

This concludes the description of our canonical flip paths corresponding to label changes of leaves: we simply set $P_\varepsilon(t, t^{v,-})$, when $l(v) = l(p(v))$ in t , to be the concatenation of $P_\varepsilon(t, t^{v,+})$ and $P_\varepsilon(t^{v,+}, (t^{v,+})^{v,-})$, while in general $P_\varepsilon(t^{v,x}, t)$ is the reverse path of $P_\varepsilon(t, t^{v,x})$ (for $x \in \{+, -, =\}$).

In order to compare spectral gaps as we did in Section 6.1, we need to estimate the maximum length of a flip path of the form $P_\varepsilon(t, t^{v,x})$ and the number of paths involving any fixed quadrangulation edge flip; we do this via the following remark and lemma:

Remark 6.1. Given $t \in \text{LT}_n$, a leaf v of t and $x \in \{+, -, =\}$, the length of the flip path $P_\varepsilon(t, t^{v,x})$, for $\varepsilon \in \{-1, 1\}$, is at most $2n + 6$.

Indeed, the flip sequence $P_\varepsilon(t, t^{v,-})$, if we ignore the possible root rotating subsequence, does not flip “the same edge” twice, so it has length at most $2n$ (in fact, it has length at most the maximum degree of a vertex

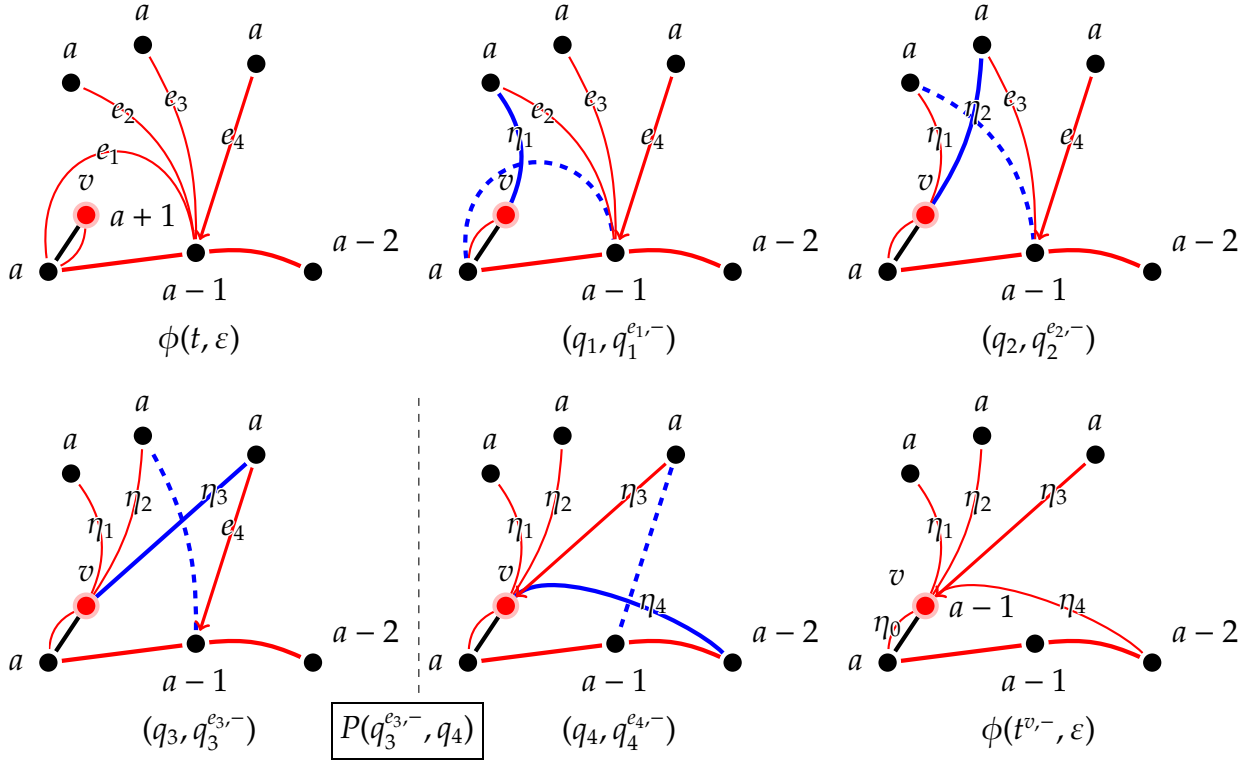

Figure 14: The flip path $P_\varepsilon(t, t^{v,-})$. Since q_1 is rooted in e_4 , a root rotating sequence is inserted right before flipping e_4 , thus correctly rooting the final quadrangulation in η_3 , i.e. the flipped image of e_3 .

in $\phi(t, \varepsilon)$, since all flipped edges are adjacent to the same vertex). The root rotating subsequence has length 5 and the path $P_\varepsilon(t, t^{v,+})$ has length 1, hence the above estimate.

Lemma 6.7. Let (q, e, s) be a triple with $q \in \mathcal{Q}_n$, $e \in E(q)$, $s \in \{+, -\}$; then there is a constant C such that there are at most C quadruples (t, v, x, ε) , where $t \in \text{LT}_n$, v is a leaf in t , $x \in \{+, -, =\}$ and $\varepsilon = \pm 1$, for which (q, e, s) appears in the flip path $P_\varepsilon(t, t^{v,x})$.

Proof. Let us first consider quadruples of the form $(t, v, -, \varepsilon)$.

Suppose t, v are such that $l(v) - l(p(v)) = 1$ and (q, e, s) appears in $P_\varepsilon(t, t^{v,-}) = (q_i, e_i, s_i)_{i=1}^k$ (that is, $q = q_l$, $e = e_l$ and $s = s_l$ for some $l \in \{1, \dots, k\}$); we first consider the case where no root rotation sequence appears in $P_\varepsilon(t, t^{v,-})$. Let v_1 and v_2 be the endpoints of e in $q^{e,s}$; then v corresponds to one of these two vertices in $q_1 = \phi(t, \varepsilon)$, since every edge e_i is adjacent to v in $q_i^{e_i,-}$ and subsequent quadrangulations in the flip path. In particular, since the degree of v in q_1 is 1 and it increases by 1 with each flip in $P_\varepsilon(t, t^{v,-})$, if d_1 and d_2 are the respective degrees of v_1 and v_2 in q , then $l = d_1$ or $l = d_2$, according to whether v is v_1 or v_2 . Suppose v is v_1 ; let $\eta_0, \dots, \eta_{d_1-1}$ be the edges incident to v_1 in q , in clockwise order around v_1 , numbered so that e will end up in between η_{d_1-1} and η_0 in $q^{e,s}$. Then $q_1 = \phi(t, \varepsilon) = ((q^{\eta_{d_1-1,+}} \eta_{2,+}) \dots)^{\eta_{1,+}}$, since e_i corresponds to the edge η_{d_i-1} in q . We therefore have only 2 possibilities for (t, v) .

Now suppose a root rotation sequence does appear in $P_\varepsilon(t, t^{v,-})$; if it appears strictly after (q, e, s) , then the reasoning above is still valid. If it appears strictly before, then the root of q is some η_j , and – reasoning as before – the quadrangulation q_1 is recovered by inserting the reverse of a root rotation sequence right before applying the clockwise flip of η_j (or right at the end if $j = 0$).

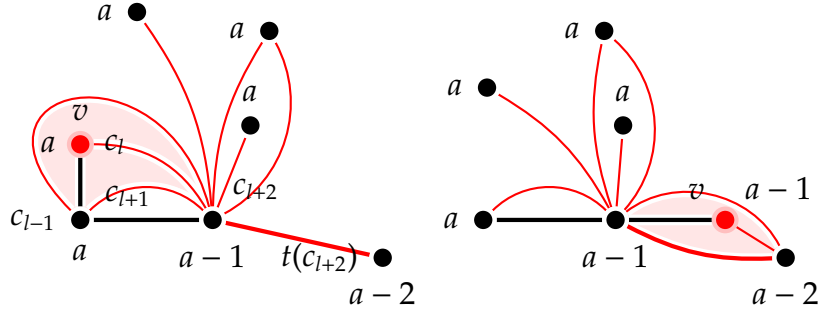

Figure 15: The quadrangulations $\phi(t, \varepsilon)$ and $\phi(t^{v, \rightarrow}, \varepsilon)$.

We are left to deal with the case where (q, e, s) actually belongs to a root rotation sequence. Notice that there is a finite number of possibilities for the quadrangulation q' obtained at the end of the root rotation sequence, since the sequence only acts within (at most) three adjacent faces, two of which are adjacent to e . Having established some q' to be the quadrangulation in question, the vertex v must be one of the endpoints of the root edge e' of q' . As before, we can now reconstruct q_1 by labelling $\eta_0, \dots, \eta_{d_{i-1}}$ the edges incident to this endpoint and performing the appropriate reverse root rotation sequence, followed by clockwise flips on $\eta_{d_{i-1}}, \dots, \eta_1$.

Similarly, suppose t, v are such that $l(v) = l(p(v))$ and (q, e, s) appears in $P_\varepsilon(t, t^{v, -})$; if (q, e, s) appears in $P_\varepsilon(t^{v, +}, t^{v, -})$, then $\phi(t^{v, +}, \varepsilon)$ can be reconstructed as above, hence $t = (t^{v, +})^{v, =}$. Otherwise we have $(q, e, s) = P_\varepsilon(t, t^{v, +})$, hence $q = \phi(t, \varepsilon)$.

Now, since $(q, e, -)$ appears in $P_\varepsilon(t, t^{v, -})$ if and only if $(q^{e, -}, e, +)$ appears in $P_\varepsilon(t^{v, -}, t)$, we have thus also covered the cases where (t, v, x) is such that $l(v) = l(p(v)) - 1$, which correspond to another 4 possibilities.

Finally, the missing cases ($x \in \{+, =\}$ and $l(v) - l(p(v)) \in \{1, 0\}$) are completely straightforward, since they correspond to a flip path of length 1, and therefore imply that $(t, \varepsilon) = \phi^{-1}(q)$ and v is the one vertex whose label is changed by the flip.

This results, indeed, in a finite number of possibilities for the quadruple (t, v, x, ε) . \square

6.4 The leaf translation sequences $P_\varepsilon(t, t^{v, \rightarrow})$, $P_\varepsilon(t, t^{v, \leftarrow})$

The other type of “move” we wish to emulate via quadrangulation flips is the translation of a leaf left or right in the contour of the tree. In doing this, we may suppose the leaf has the same label as its parent, and deal with all other cases by concatenating flip paths of the type $P_\varepsilon(t, t^{v, -})$ and $P_\varepsilon(t^{v, =}, t')$, which we have constructed in the previous section.

The description of $\phi(t^{v, \rightarrow}, \varepsilon)$ in terms of $\phi(t, \varepsilon)$ is rather simple and depicted in Figure 15:

Lemma 6.8. *Consider $(t, \varepsilon) \in \text{LT}_n \times \{-1, 1\}$ and let v be a leaf of t such that $l(v) = l(p(v))$. Let c_1, \dots, c_{2n} be the clockwise contour of t and suppose c_l , with $2 \leq l \leq 2n - 1$, is the corner of v (notice that, if we had $l = 2n$, we would have $t^{v, \rightarrow} = t$). Then $\phi(t^{v, \rightarrow}, \varepsilon)$ can be obtained from $\phi(t, \varepsilon)$ by*

- identifying the two edges $(c_{l-1}, t(c_{l-1}))$ and $(c_{l+1}, t(c_{l+1}))$ and erasing the double edge (c_l, c_{l+1}) (that is eliminating the one degenerate face of $\phi(t, \varepsilon)$ which corresponds to the tree edge $(p(v), v)$);
- replacing the edge $(c_{l+2}, t(c_{l+2}))$ by a degenerate face whose internal vertex is adjacent to the vertex of $t(c_{l+2})$.

Notice that it is possible that either the edge (c_{l-1}, c_l) (if $l = 2$) or the edge $(c_{l+2}, t(c_{l+2}))$ (if $l = 2l - 1$) is the root edge of $\phi(t, \varepsilon)$. In the former case, the root of $\phi(t^{v, \rightarrow}, \varepsilon)$ is the edge obtained from identifying

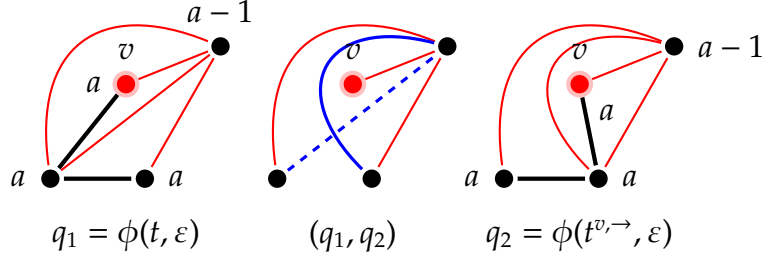

Figure 16: The flip path $P_\varepsilon(t, t^{v, \rightarrow})$ has length 1 when the edge $(v, p(v))$ is replanted onto a vertex which has the same label as v and $p(v)$. Notice that the edge that needs to be flipped in order to change $\phi(t, \varepsilon)$ into $\phi(t^{v, \rightarrow}, \varepsilon)$ cannot be the root edge of $\phi(t, \varepsilon)$, since it is not issued from the first corner of t .

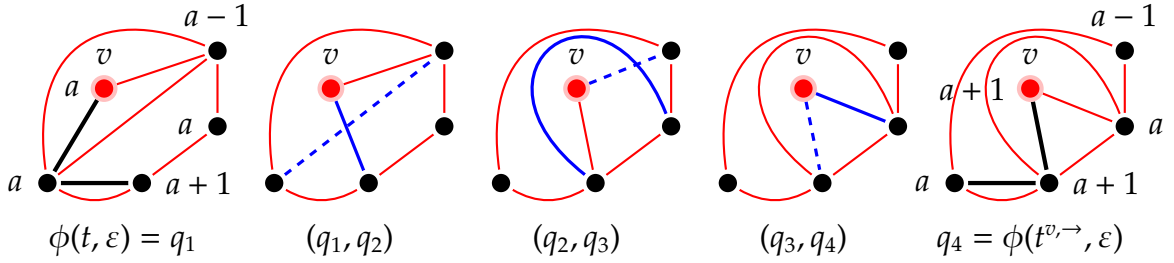

Figure 17: The flip path $P_\varepsilon(t, t^{v, \rightarrow})$ when $l(w) = l(v) + 1$, where w is the vertex that becomes the new parent of v in $t^{v, \rightarrow}$.

$(c_{l-1}, t(c_{l-1}))$ and $(c_{l+1}, t(c_{l+1}))$, oriented as before; in the latter, it is the second edge of the new degenerate face in clockwise order around the vertex of c_{l+2} , oriented as $(c_{l+2}, t(c_{l+2}))$ was.

Proof. Given $t \in \text{LT}_n$ and $\varepsilon \in \{-1, 1\}$, a leaf v such that $l(v) = l(p(v))$ is the internal vertex of a degenerate face in $\phi(t, \varepsilon)$; removing the leaf (and the tree edge joining it to its parent) results in a tree $t' \in \text{LT}_{n-1}$ and a quadrangulation $\phi(t', \varepsilon)$ in which the face is eliminated by identifying the two edges of its boundary (into a root edge with the same orientation as before in the case where one of them was root edge in $\phi(t, \varepsilon)$).

The quadrangulation $\phi(t^{v, \rightarrow}, \varepsilon)$ is obtained by performing the above operation and then its reverse in the appropriate way. \square

The quadrangulation flip path $P_\varepsilon(t, t^{v, \rightarrow})$ will depend on the label of the vertex w of corner c_{l+2} in t ; since the cases where $l(w) = l(v)$ and $l(w) = l(v) + 1$ are simpler (we can construct a path of length 1 in the first case and 3 in the second!), we refer to Figure 16 and Figure 17 for its construction, which only involves flips within two adjacent faces of $\phi(t, \varepsilon)$. Notice that, furthermore, the construction preserves the edges issued from c_{l-1} and c_{l+2} , so that the root edge is automatically the correct one in the quadrangulations q_2 from Figure 16 and q_4 from Figure 17.

The case where $l(w) = l(v) - 1$ is more complex, and will be treated in the following lemma.

Lemma 6.9 (Flip path construction, leaf translation onto smaller label). *Consider a tree $t \in \text{LT}_n$ with contour c_1, \dots, c_{2n} and let v be a leaf of t such that $l(v) = l(p(v))$, adjacent to a corner c_l with $2 \leq l \leq 2n - 1$. Let w be the vertex of the corner c_{l+2} and further suppose that $l(w) = l(v) - 1$.*

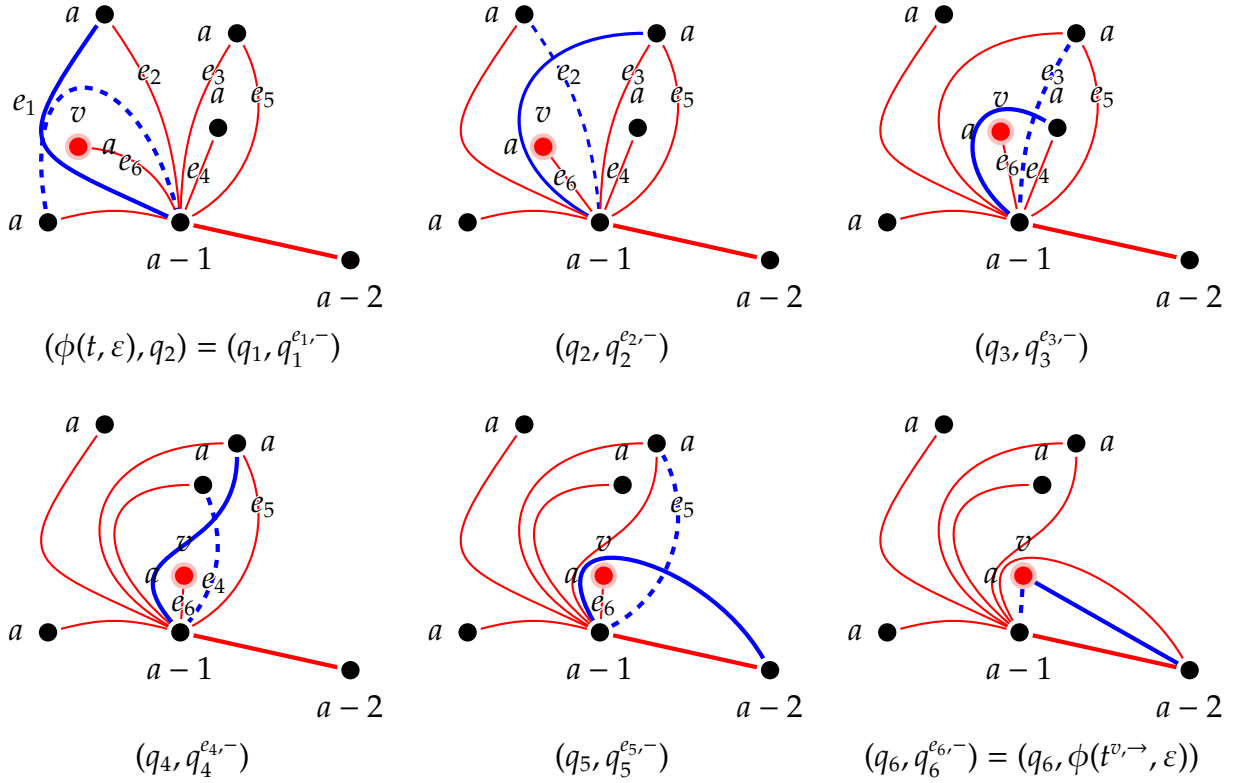

Figure 18: The flip path $P_\varepsilon(t, t^{v, \rightarrow})$ in the case where the edge $(v, p(v))$ is followed by a corner labelled $p(v) - 1$ in the clockwise contour of t .

For $\varepsilon \in \{-1, 1\}$, let e_1, \dots, e_{k-1} be the edges of $\phi(t, \varepsilon)$ that are adjacent to w and lie strictly between the edge $e_k = (c_l, c_{l+2})$ and the edge $(c_{l+2}, t(c_{l+2}))$, in clockwise order around w . If none of them is the root of edge of $\phi(t, \varepsilon)$, then we can set $P_\varepsilon(t, t^{v, \rightarrow}) = (q_i, e_i, -)_{i=1}^k$, and we have $q_{k+1} := q_k^{e_k, -} = \phi(t^{v, \rightarrow}, \varepsilon)$.

If some e_j is the root edge of $\phi(t, \varepsilon)$, then we can set $P_\varepsilon(t, t^{v, \rightarrow})$ to be the same flip path as above, with the root rotation flip sequence from Lemma 6.5, performed around the endpoint of the root edge that is not w , inserted right before the flip $(q_j, e_j, -)$.

See Figure 18 for the construction.

Proof. One can show inductively that, for $i = 2, \dots, k$, the quadrangulation q_i is obtained from q_1 by collapsing the face that contains the edge e_k in q_1 and replacing the edge e_i with a degenerate face whose internal vertex is adjacent to w ; furthermore, the natural edge identification between q_1 and q_i has e_k correspond to the internal edge of the latter face, while e_i corresponds to the ‘rightmost’ boundary edge of the latter face in clockwise order around w . By Lemma 6.8, the only difference between q_k and $\phi(t^{v, \rightarrow}, \varepsilon)$ is the fact that the internal edge of the new degenerate face is incident to w in q_k and, potentially, the choice of the root edge (in the case where the root edge of q_1 is among the flipped edges e_1, \dots, e_{k-1}). Flipping e_k in q_k – thus obtaining q_{k+1} – is enough to fix the first issue, and yields $\phi(t^{v, \rightarrow}, \varepsilon)$ up to rerooting. Suppose now that the root edge of q_1 is some e_j (with $1 \leq j \leq k-1$); the edge issued from the same corner in q_{k+1} is actually the flipped version of edge e_{j-1} (or the edge out of c_{l+1} , which never gets flipped, in the case where $l = 2$: for ease of notation we will call it e_0). In the quadrangulation q_j , e_j (not yet flipped and still the root edge) and e_{j-1} (already flipped, unless $j = 1$) are consecutive in clockwise order around their endpoint that is not

w. Performing the root rotation sequence before $(q_j, e_j, -)$ thus simply results in rerooting q_j in its edge e_{j-1} (with the correct orientation), which will not be flipped again and will end up being the correct root edge in q_{k+1} once the rest of the flips are performed. \square

As mentioned before, we construct $P_\varepsilon(t, t^{v,\rightarrow})$ in general as the concatenation of $P_\varepsilon(t, t^{v,=})$, $P_\varepsilon(t^{v,=}, (t^{v,=})^{v,\rightarrow})$ and $P_\varepsilon((t^{v,=})^{v,\rightarrow}, ((t^{v,=})^{v,\rightarrow})^{v,c})$, where c is chosen so as to “restore” the colour of $(v, p(v))$ to the original one from t . We can further set $P_\varepsilon(t^{v,\rightarrow}, (t^{v,\rightarrow})^{v,\leftarrow})$ to be the reverse sequence of $P_\varepsilon(t, t^{v,\rightarrow})$ (keeping in mind that $P_\varepsilon(t, t)$ is already set to be empty). Notice that, using Remark 6.1 and the fact that the construction from Lemma 6.9, excluding root rotation sequences, does not flip the same edge twice, we immediately have $|P_\varepsilon(t^{v,d}, t)| \leq 6n + 17$ for all $t \in \text{LT}_n$, v leaf of t , $d \in \{\rightarrow, \leftarrow\}$, $\varepsilon \in \{-1, 1\}$.

Additionally, we have the following:

Lemma 6.10. *Let (q, e, s) be a triple with $q \in \mathbf{Q}_n$, $e \in E(q)$, $s \in \{+, -\}$; then there is a constant C such that there are at most C quadruples (t, v, d, ε) , where $t \in \text{LT}_n$, v is a leaf in t , $d \in \{\rightarrow, \leftarrow\}$ and $\varepsilon = \pm 1$, for which (q, e, s) appears in the flip path $P_\varepsilon(t, t^{v,d})$.*

Proof. By lemma 6.7, the number of such quadruples is at most a constant times the number of those where $l(v) = l(p(v))$, so we shall restrict ourselves to the latter case; since $P_\varepsilon(t, t^{v,\rightarrow})$ is the reverse of $P_\varepsilon(t^{v,\rightarrow}, t)$, we may also suppose $d = \rightarrow$.

Suppose $(t, v, \rightarrow, \varepsilon)$ is a quadruple such that $l(v) = l(p(v))$ and (q, e, s) appears in $P_\varepsilon(t, t^{v,\rightarrow})$, and let c_1, \dots, c_{2n} be the clockwise contour of t , with c_l being the corner of v . If $l(c_{l+2}) = l(v)$, then $q = \phi(t, \varepsilon)$ and v is uniquely determined from the flip (q, e, s) .

If $l(c_{l+2}) = l(v) + 1$, then there are a few possibilities (refer again to Figure 17). If q has one more degree one vertex than $q^{e,s}$, then $q = \phi(t, \varepsilon)$ and v is that degree one vertex. If $q^{e,s}$ has one more degree one vertex than q , let e' be the edge issued from that vertex; then v is the vertex in question and $\phi(t^{v,\rightarrow}, \varepsilon) = (q^{e,s})^{e',-}$. Otherwise, e is a double edge within a degenerate face, $q^{e,s} = \phi(t^{v,\rightarrow}, \varepsilon)$ and v is its degree one endpoint.

Finally, if $l(c_{l+2}) = l(v) - 1$, then consider the edge e in $q^{e,s}$. First, let's suppose that (q, e, s) does not belong to a root rotating sequence. If e is the interior edge of a degenerate face, then $\phi(t^{v,\rightarrow}, \varepsilon) = q^{e,s}$ and v is its endpoint of degree 1. Otherwise, consider the two endpoints w_1, w_2 of e in $q^{e,s}$; one of them must play the role of the vertex w from Lemma 6.9. If it is w_1 , then to the right of the oriented edge (w_1, w_2) in $q^{e,s}$ lies a degenerate face with an internal vertex connected to w_1 . If (w_1, u) is the first oriented edge in clockwise order around w starting with (w_1, w_2) such that u is strictly nearer to δ than w_1 , the construction of the flip path implies that $\phi(t^{v,\rightarrow}, \varepsilon)$ can be obtained from $q^{e,s}$ by collapsing the face lying right of (w_1, w_2) and replacing (w_1, u) with a new degenerate face whose internal edge is issued from u and has v as the other endpoint. An analogous argument holds for w_2 , giving rise to only two possibilities for (t, v, \rightarrow) . If (q, e, s) actually belongs to a root rotation sequence, then there is a finite number of possibilities for the final quadrangulation q' obtained by completing the sequence; we can then use q' and its root edge in place of $q^{e,s}$ and e to reconstruct the final quadrangulation $\phi(t^{v,\rightarrow}, \varepsilon)$ in (at most) two ways. \square

We now have all the information necessary to fully justify the computation at the end of Section 6.1: assembling the estimate from Remark 6.1 and its consequences as stated above, as well as Lemma 6.7 and Lemma 6.10, yields the following:

Corollary 6.11. *There is a constant M such that, given any triple (q, e, s) , where $q \in \mathbf{Q}_n^\bullet$, e is an edge of q and $s \in \{+, -\}$,*

$$\left| \{t, v, x, \varepsilon \mid (q, e, s) \text{ appears in } P_\varepsilon(t, t^{v,x})\} \right| + \left| \{t \mid (q, e, s) \text{ appears in } P(t)\} \right| \leq M.$$

Furthermore, $|P_\varepsilon(t, t^{v,x})| \leq 7n$ for all $n \geq 17$, $t \in \text{LT}_n$, v leaf of t , $x \in \{\rightarrow, \leftarrow, +, =, -\}$, $\varepsilon \in \{-1, 1\}$.

This completes our proof of Theorem 1.

References

- [1] D. ALDOUS, *Triangulating the circle, at random.*, Amer. Math. Monthly, 101 (1994).
- [2] D. ALDOUS, *Mixing time for a markov chain on cladograms*, Combinatorics, Probability and Computing, 9 (2000), p. 191–204.
- [3] S. BRAVYI, L. CAHA, R. MOVASSAGH, D. NAGAJ, AND P. W. SHOR, *Criticality without frustration for quantum spin-1 chains*, Phys. Rev. Lett., 109 (2012).
- [4] T. BUDZINSKI, *On the mixing time of the flip walk on triangulations of the sphere*, Comptes Rendus Mathematique, 355 (2017), pp. 464 – 471.
- [5] P. CAPUTO, F. MARTINELLI, A. SINCLAIR, AND A. STAUFFER, *Random lattice triangulations: Structure and algorithms*, Ann. Appl. Probab., 25 (2015), pp. 1650–1685.
- [6] ———, *Dynamics of lattice triangulations on thin rectangles*, Electron. J. Probab., 21 (2016), p. 22.
- [7] P. CHASSAING AND G. SCHAEFFER, *Random planar lattices and integrated superBrownian excursion*, Probab. Theory Related Fields, 128 (2004), pp. 161–212.
- [8] E. COHEN, P. TETALI, AND D. YELIUSSIZOV, *Lattice Path Matroids: Negative Correlation and Fast Mixing*, ArXiv e-prints, (2015).
- [9] R. CORI AND B. VAUQUELIN, *Planar maps are well labeled trees*, Canad. J. Math., 33 (1981), pp. 1023–1042.
- [10] N. CURIEN, L. MÉNARD, AND G. MIERMONT, *A view from infinity of the uniform infinite planar quadrangulation*, Lat. Am. J. Probab. Math. Stat., 10 (2013), pp. 45–88.
- [11] P. DIACONIS AND L. SALOFF-COSTE, *Logarithmic Sobolev inequalities for finite Markov chains*, Ann. Appl. Probab., 6 (1996), pp. 695–750.
- [12] J.-F. LE GALL, *Uniqueness and universality of the Brownian map*, Ann. Probab., 41 (2013), pp. 2880–2960.
- [13] W. LÖHR, L. MYTNIK, AND A. WINTER, *The Aldous chain on cladograms in the diffusion limit*, ArXiv e-prints, (2018).
- [14] L. McSHINE AND P. TETALI, *On the mixing time of the triangulation walk and other catalan structures*, in Randomization Methods in Algorithm Design, Proceedings of a DIMACS Workshop, Princeton, New Jersey, USA, December 12-14, 1997, 1997, pp. 147–160.
- [15] L. MÉNARD, *The two uniform infinite quadrangulations of the plane have the same law*, Ann. Inst. H. Poincaré Probab. Statist., 46 (2010), pp. 190–208.
- [16] G. MIERMONT, *The Brownian map is the scaling limit of uniform random plane quadrangulations*, Acta Math., 210 (2013), pp. 319–401.
- [17] M. MOLLOY, B. REED, AND W. STEIGER, *On the mixing rate of the triangulation walk*, in Randomization methods in algorithm design (Princeton, NJ, 1997), vol. 43 of DIMACS Ser. Discrete Math. Theoret. Comput. Sci., Amer. Math. Soc., Providence, RI, 1999, pp. 179–190.
- [18] R. MOVASSAGH, *The gap of Fredkin quantum spin chain is polynomially small*, ArXiv e-prints, (2016).

- [19] R. MOVASSAGH AND P. W. SHOR, *Supercritical entanglement in local systems: Counterexample to the area law for quantum matter*, Proceedings of the National Academy of Sciences, 113 (2016), pp. 13278–13282.
- [20] J. SCHWEINSBERG, *An $O(n^2)$ bound for the relaxation time of a Markov chain on cladograms*, Random Struct. Algorithms, 20 (2002), pp. 59–70.
- [21] A. STAUFFER, *A Lyapunov function for Glauber dynamics on lattice triangulations*, Probability Theory and Related Fields, 169 (2017), p. 469–521.
- [22] D. B. WILSON, *Mixing times of lozenge tiling and card shuffling Markov chains*, The Annals of Applied Probability, 14 (2004), pp. 274–325.